

[54] HAND OPERATED THREAD LOOPING MACHINE

[76] Inventor: Billy H. Matthews, 2659 Heritage, Las Vegas, Nev. 89121

[**] Term: 14 Years

[21] Appl. No.: 519,943

[22] Filed: Nov. 1, 1974

[51] Int. Cl. D15-06; D2-07

[52] U.S. Cl. D3/19 A

[58] Field of Search 112/80; D3/19 A, 19 B, D3/19 D; D47/5; D92/15; D70/2 R, 2 A, 2 B, 1

[56] References Cited

U.S. PATENT DOCUMENTS

294,499	3/1884	Parks	112/80
314,023	3/1885	Hinkle	112/80
340,189	4/1886	Vigars	112/80

463,548	11/1891	Ross	112/80
1,614,576	1/1927	Steinbeck	112/80
1,739,358	12/1929	Gearhart	112/80

Primary Examiner—Winifred E. Herrmann
Attorney, Agent, or Firm—Jerry R. Seiler

[57] CLAIM

The ornamental design for a hand operated thread lopping machine, as shown and described.

DESCRIPTION

FIG. 1 is a perspective view of a hand operated thread lopping machine showing my new design; FIG. 2 and 3 are elevational views of one side thereof showing the reciprocating handle in different positions; FIG. 4 is a top view thereof; FIG. 5 is a side elevational view thereof; FIG. 6 is a bottom view thereof; FIG. 7 is a top view thereof; and FIG. 8 is a bottom view thereof.

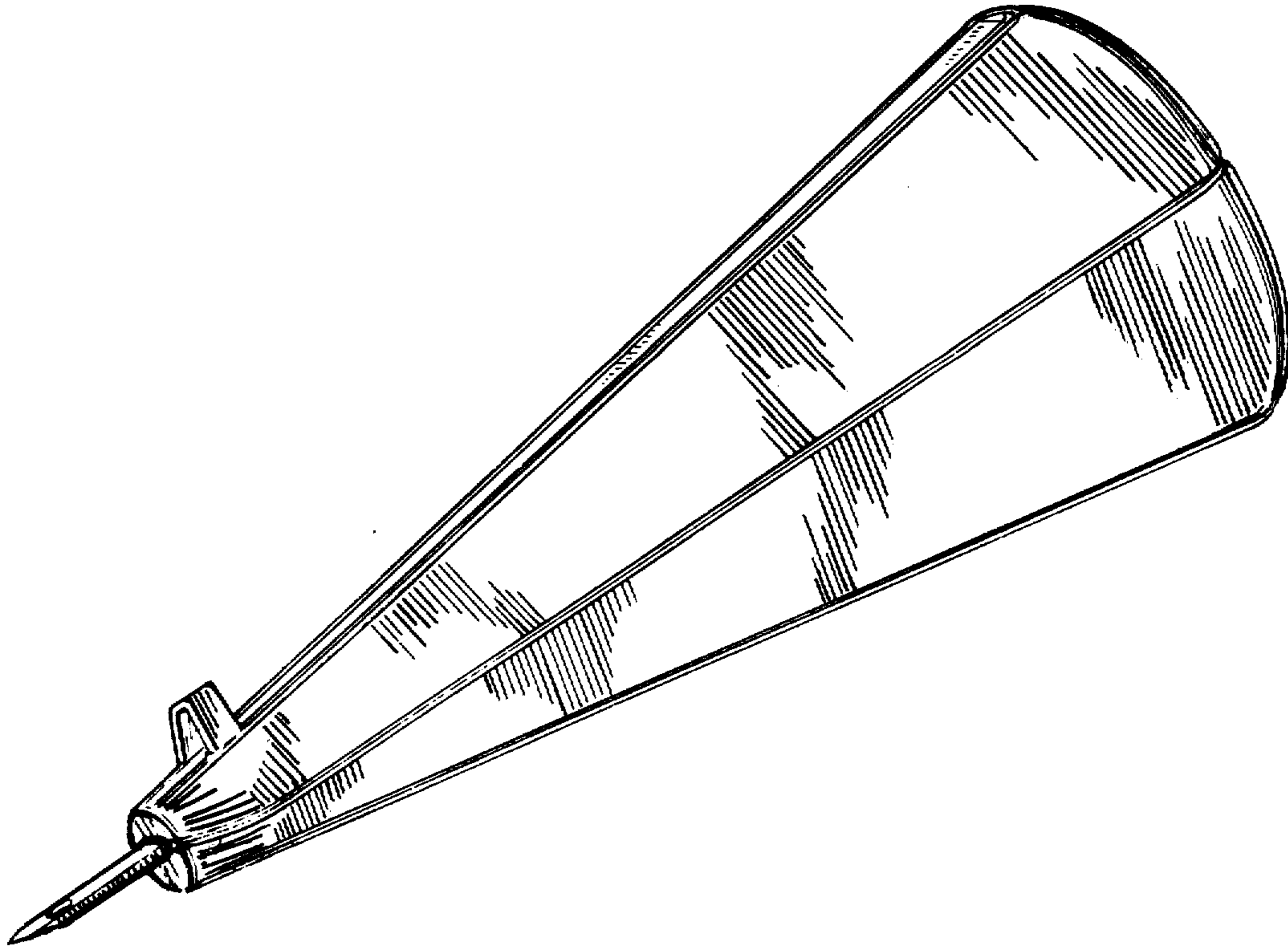

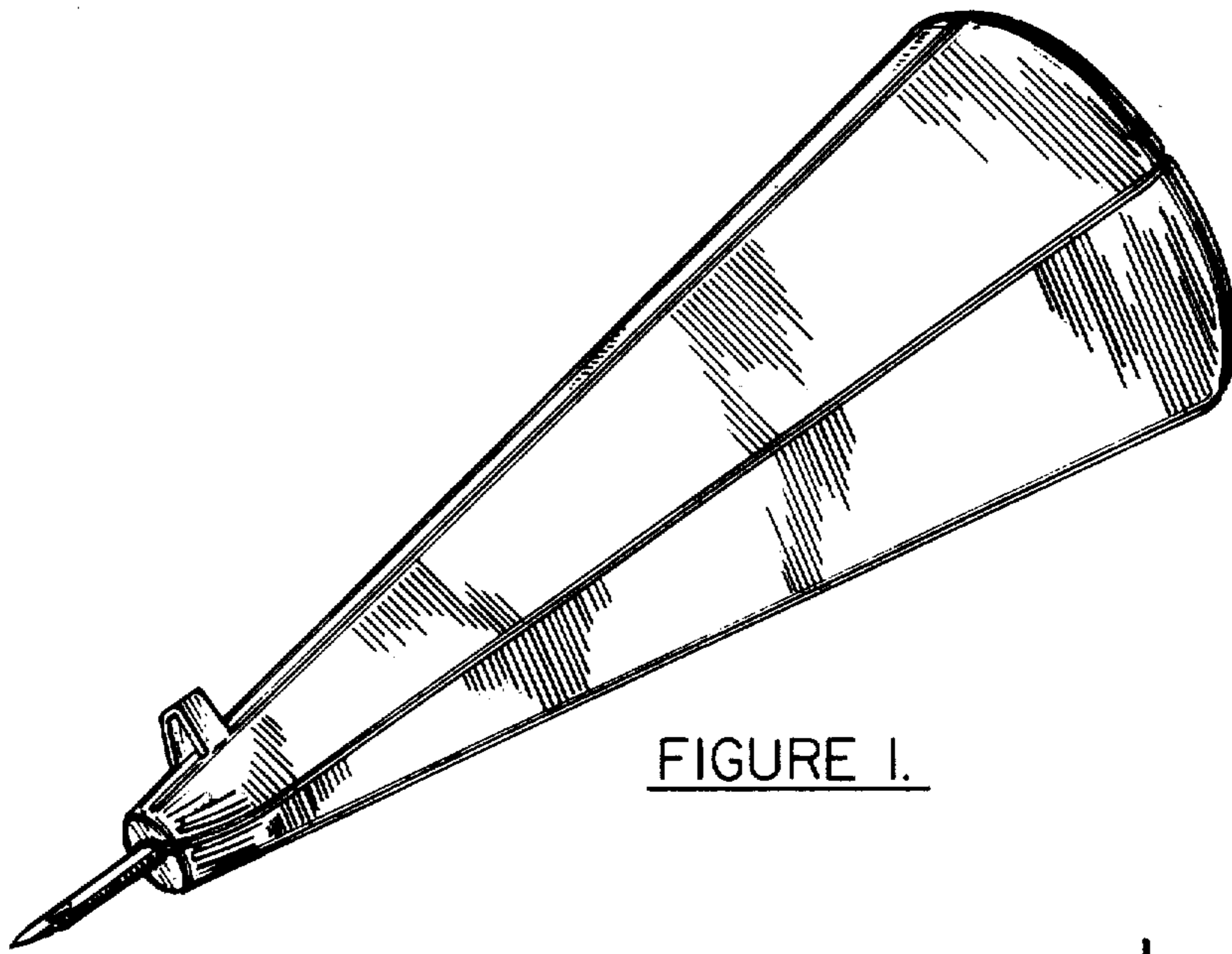

FIGURE 1.

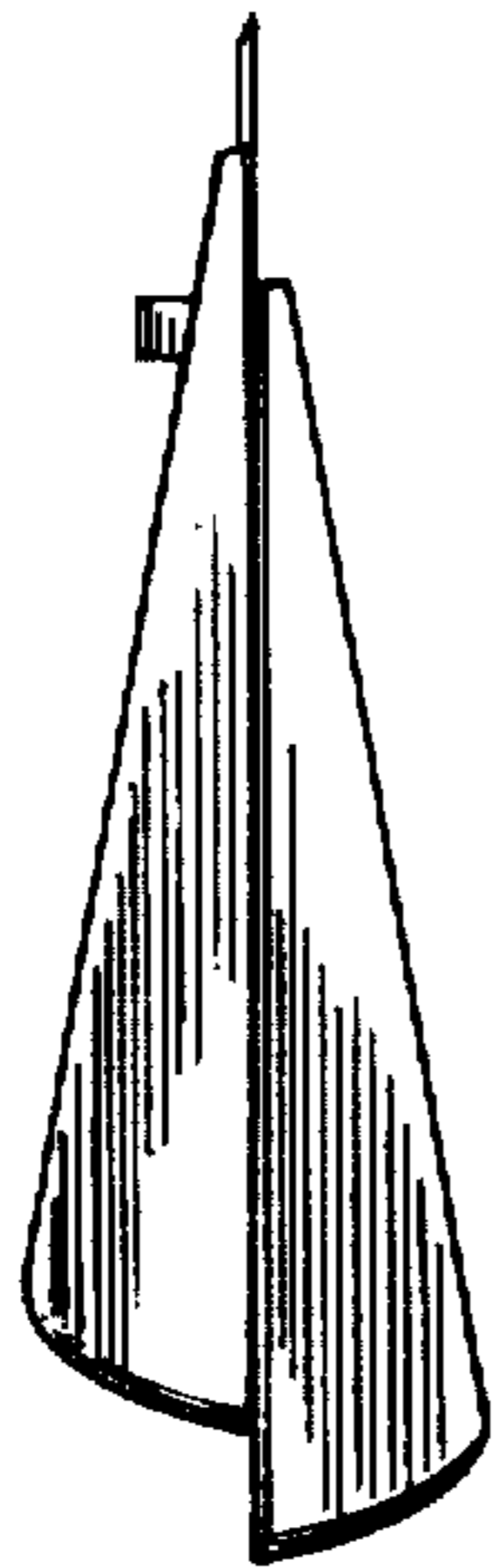

FIGURE 2.

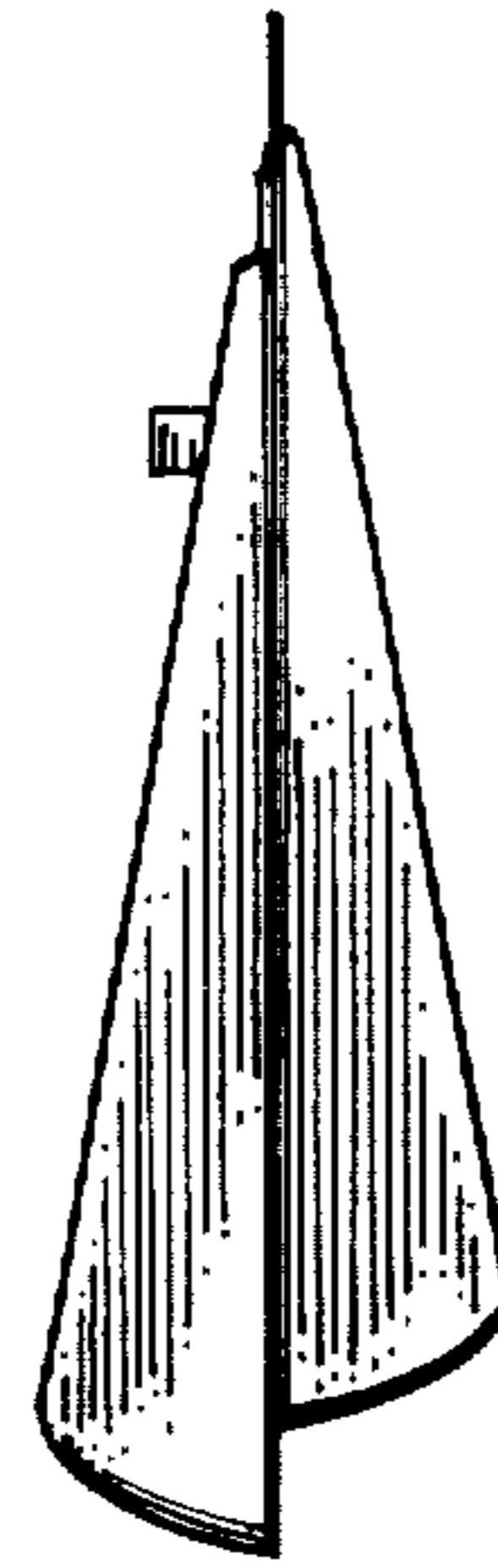

FIGURE 3.



FIGURE 4.

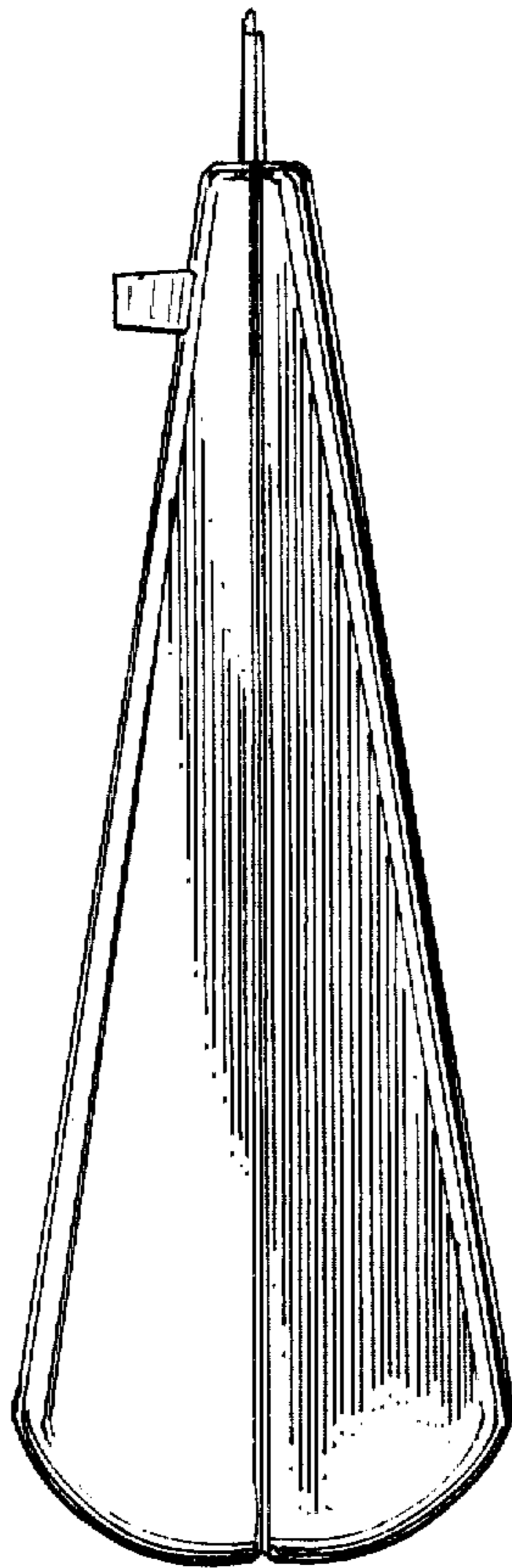

FIGURE 5.

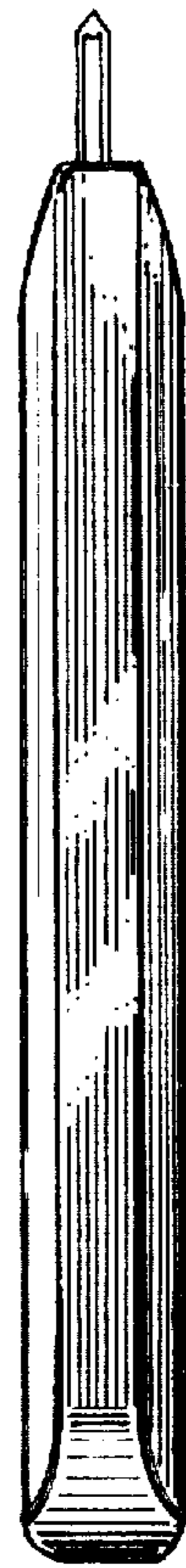

FIGURE 6.

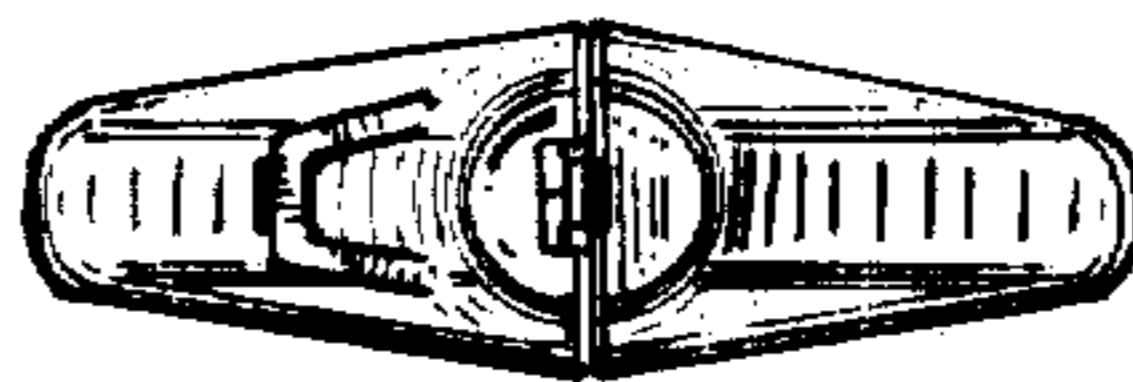

FIGURE 7.

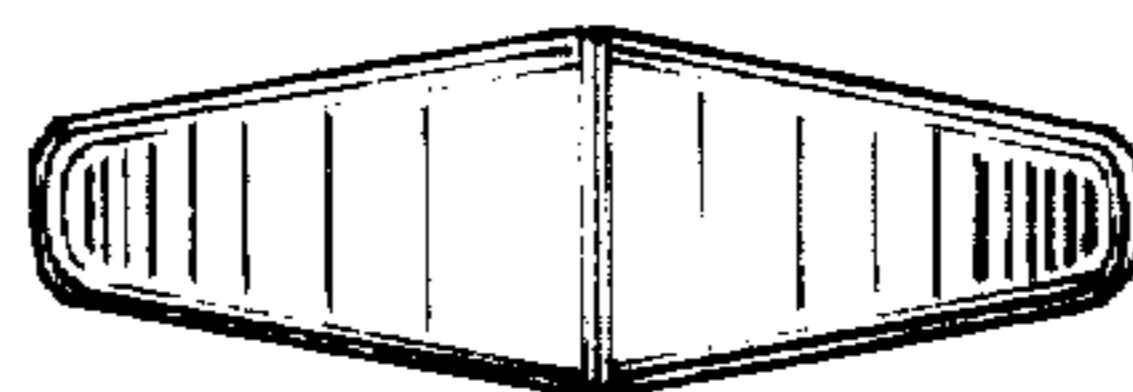

FIGURE 8.