

[54] **TABLE**  
 [76] Inventor: **Eugene D. Thomas**, 507 W. Fullerton Ave., Chicago, Ill. 60614  
 [\*\*] Term: **14 Years**  
 [21] Appl. No.: **583,578**  
 [22] Filed: **June 4, 1975**  
 [51] Int. Cl. .... **D6-03**  
 [52] U.S. Cl. .... **D6/177**  
 [58] Field of Search ..... D6/20, 27, 145, 146-149, D6/175-179

N.Y. Times Mag. Section, 1-22-1950, p. 31, Table by Robsjohn-Gibbings.

Primary Examiner—Bruce W. Dunkins  
Attorney, Agent, or Firm—George B. Newitt

[57] **CLAIM**

The ornamental design for a table, as shown and described.

**DESCRIPTION**

FIG. 1 is a perspective view, looking downward, of a table showing my new design;  
 FIG. 2 is another perspective view, looking upward, of the table in FIG. 1;  
 FIG. 3 is a side view of one side of the table in FIG. 1;  
 FIG. 4 is a side view, taken 90° from the view in FIG. 3, of the table in FIG. 1;  
 FIG. 5 is a top plan view taken of the table in FIG. 1; and  
 FIG. 6 is a bottom view of the table in FIG. 1.

[56] **References Cited**  
**U.S. PATENT DOCUMENTS**  
 D. 222,624 11/1971 Gianfagna ..... D6/177  
 D. 232,878 9/1974 Krumholz et al. .... D6/27 X  
 D. 236,926 9/1975 Alexander ..... D6/177  
**OTHER PUBLICATIONS**  
 Interiors, Nov. 1965, p. 215, Cocktail table by Habitat.

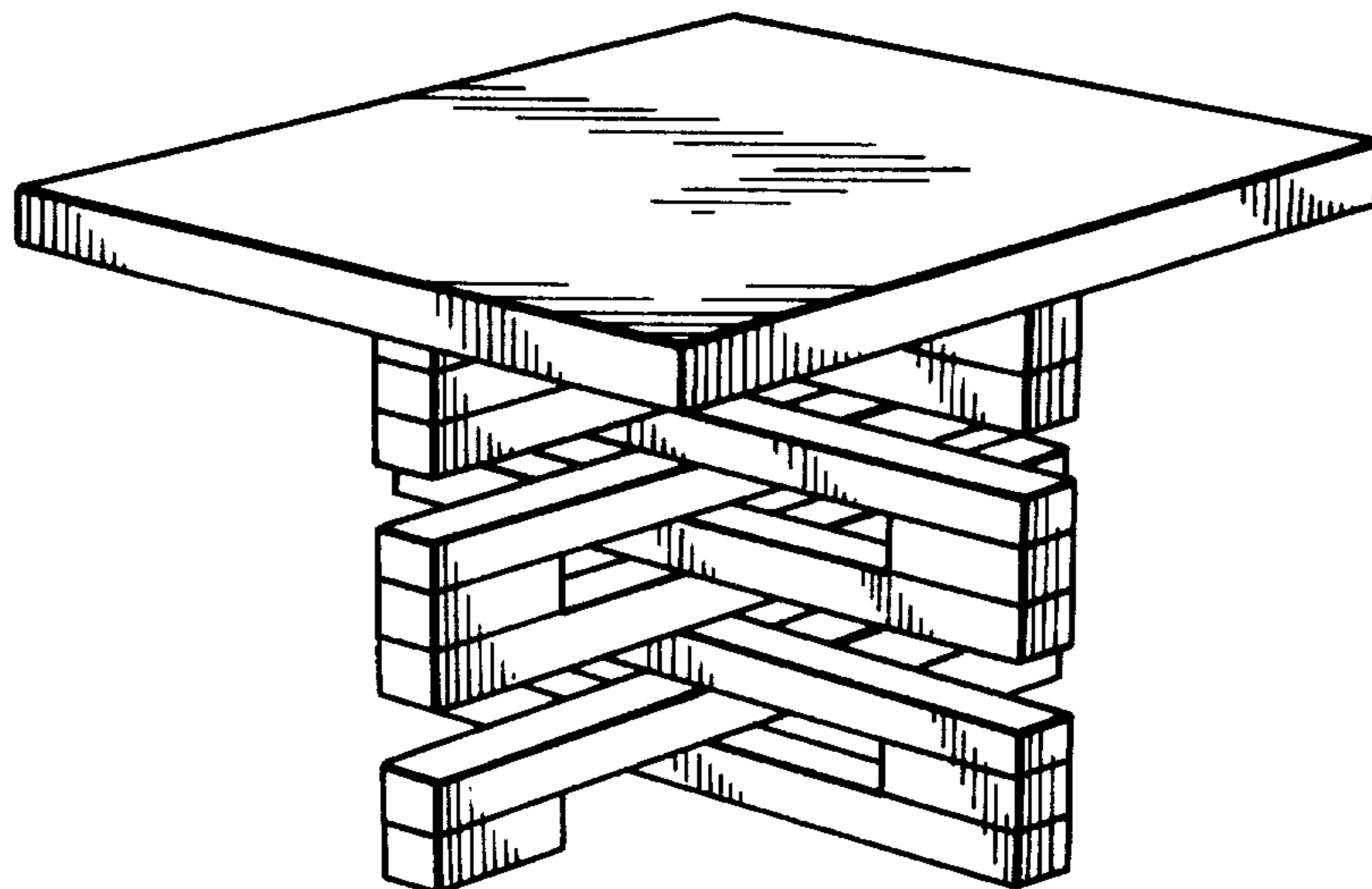

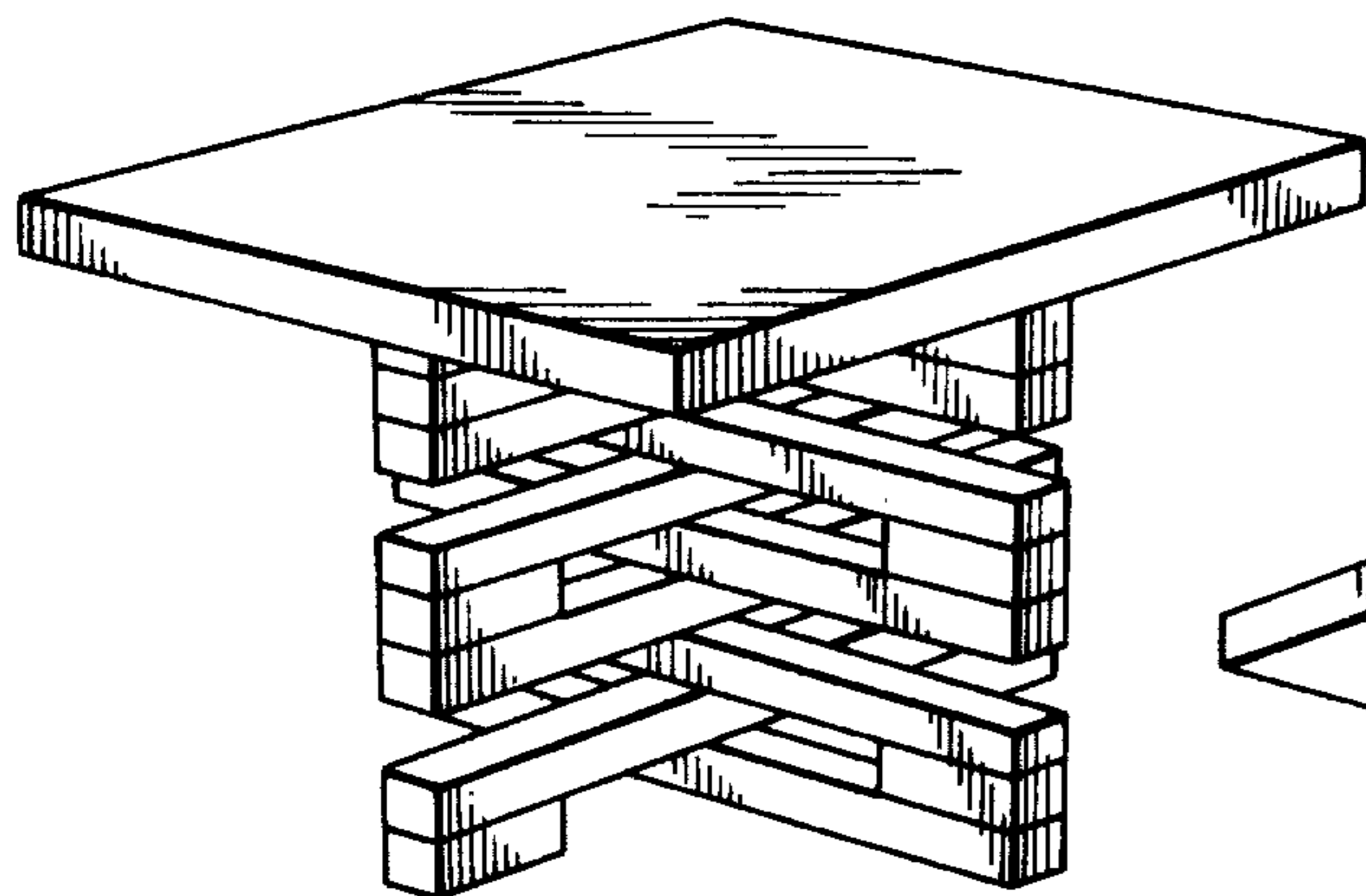

FIG. 1

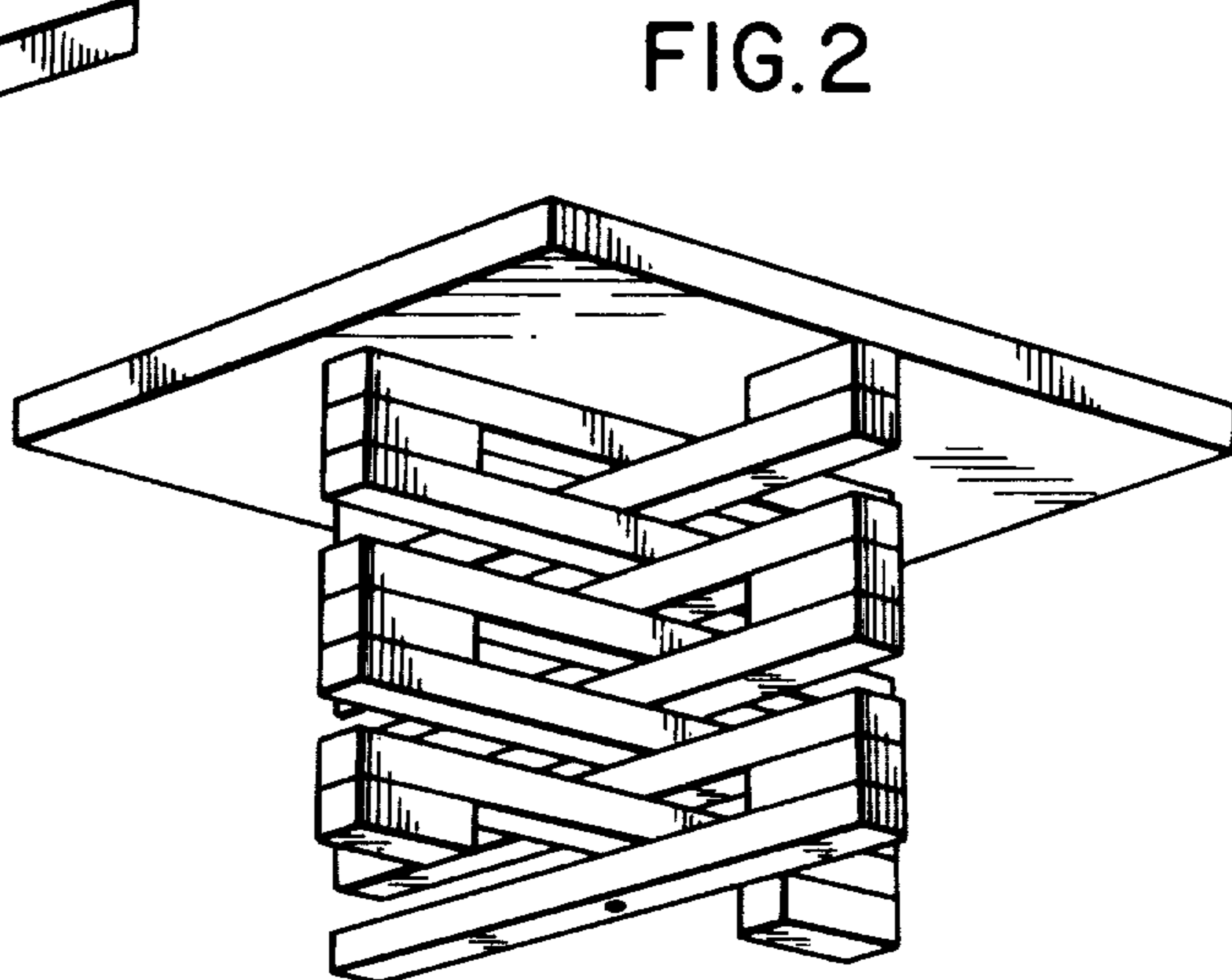

FIG. 2

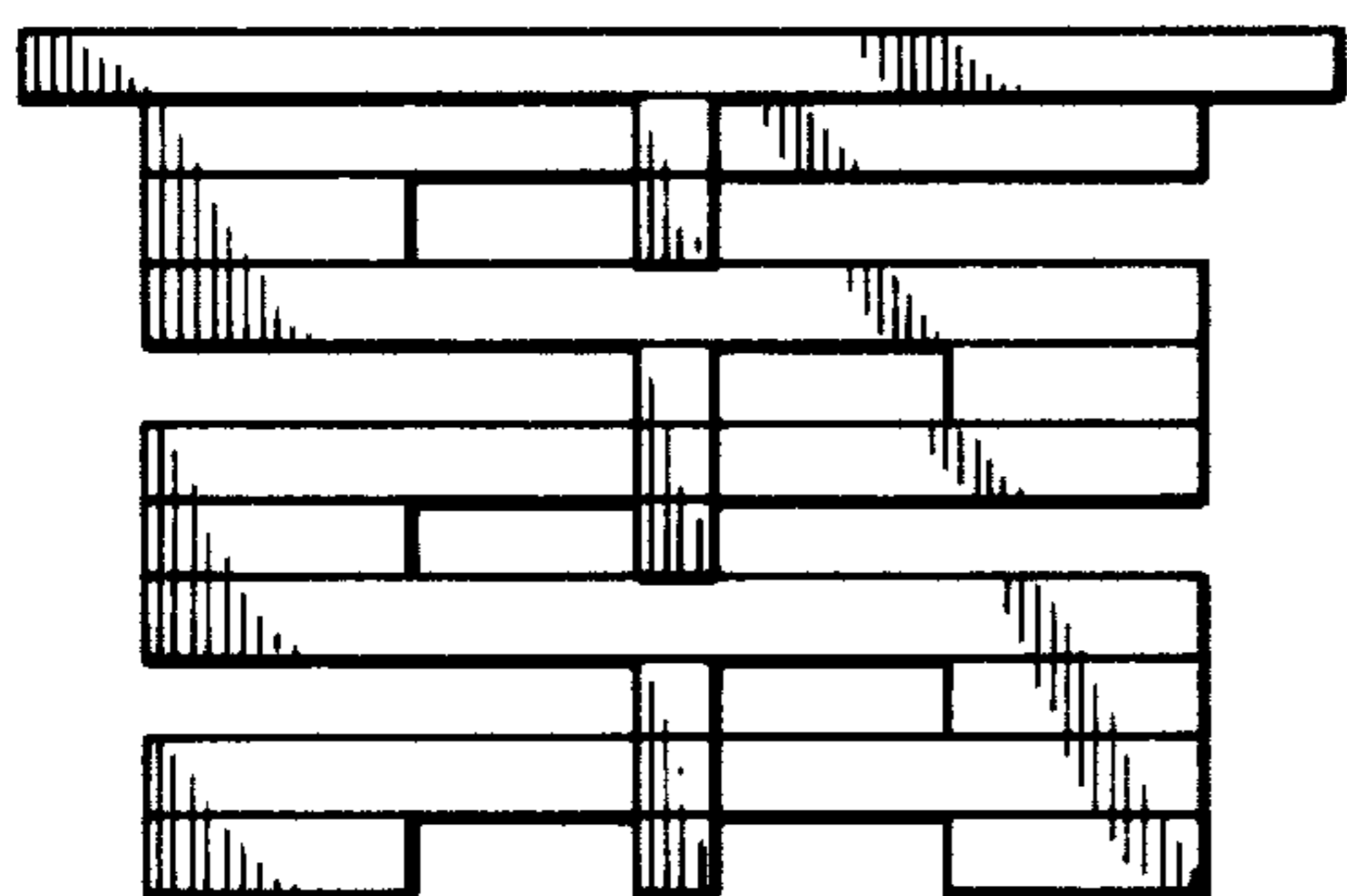

FIG. 3

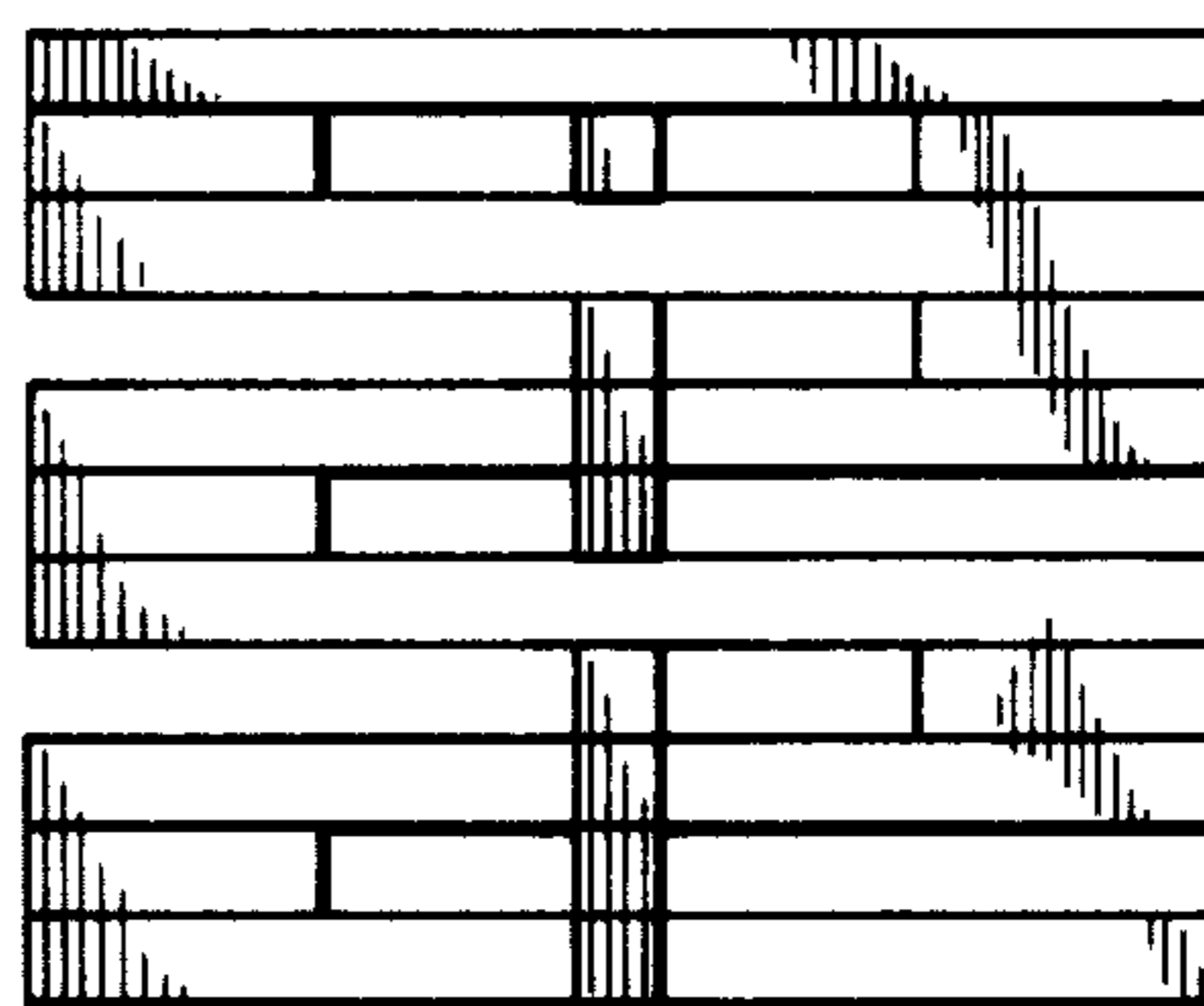

FIG. 4

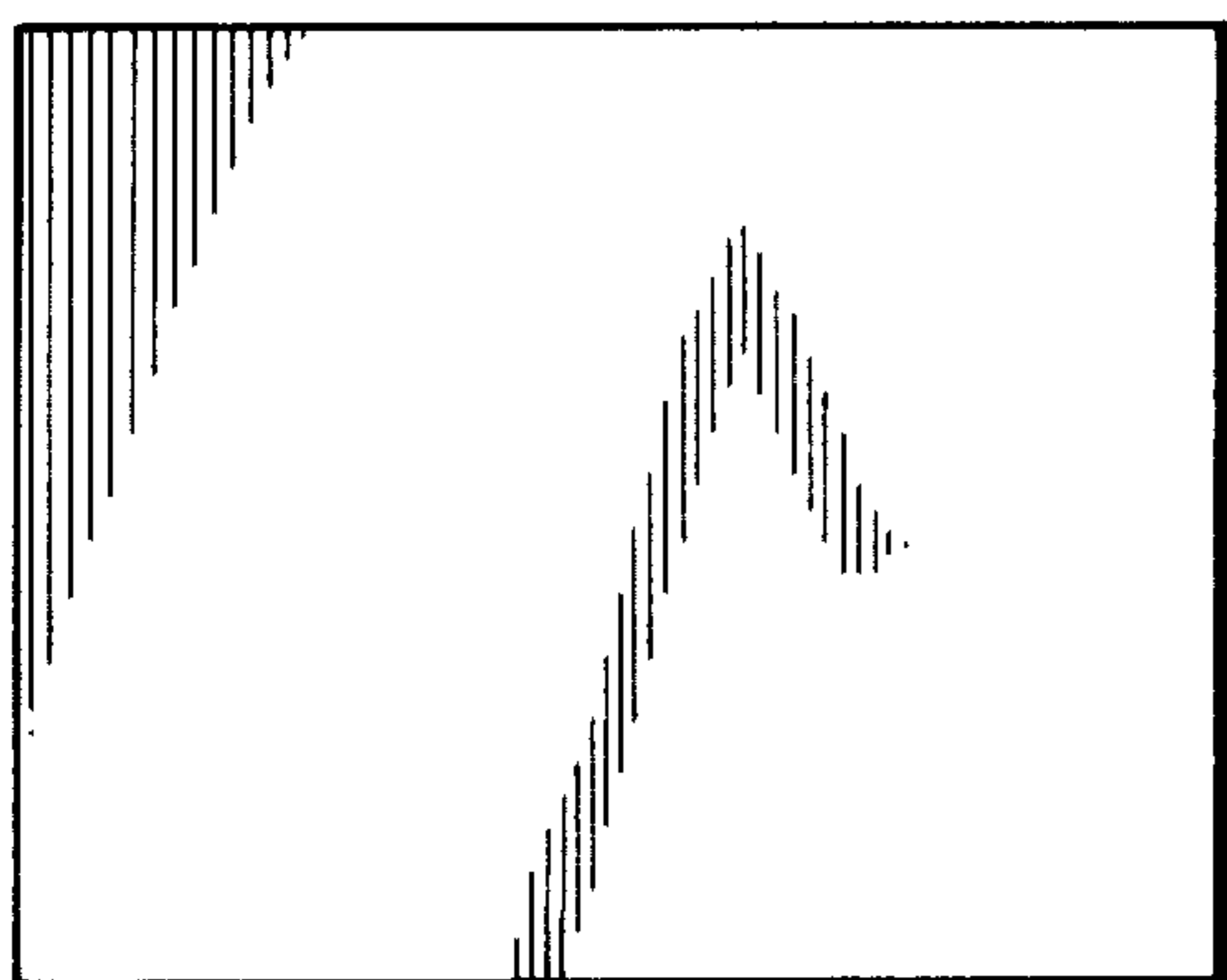

FIG. 5

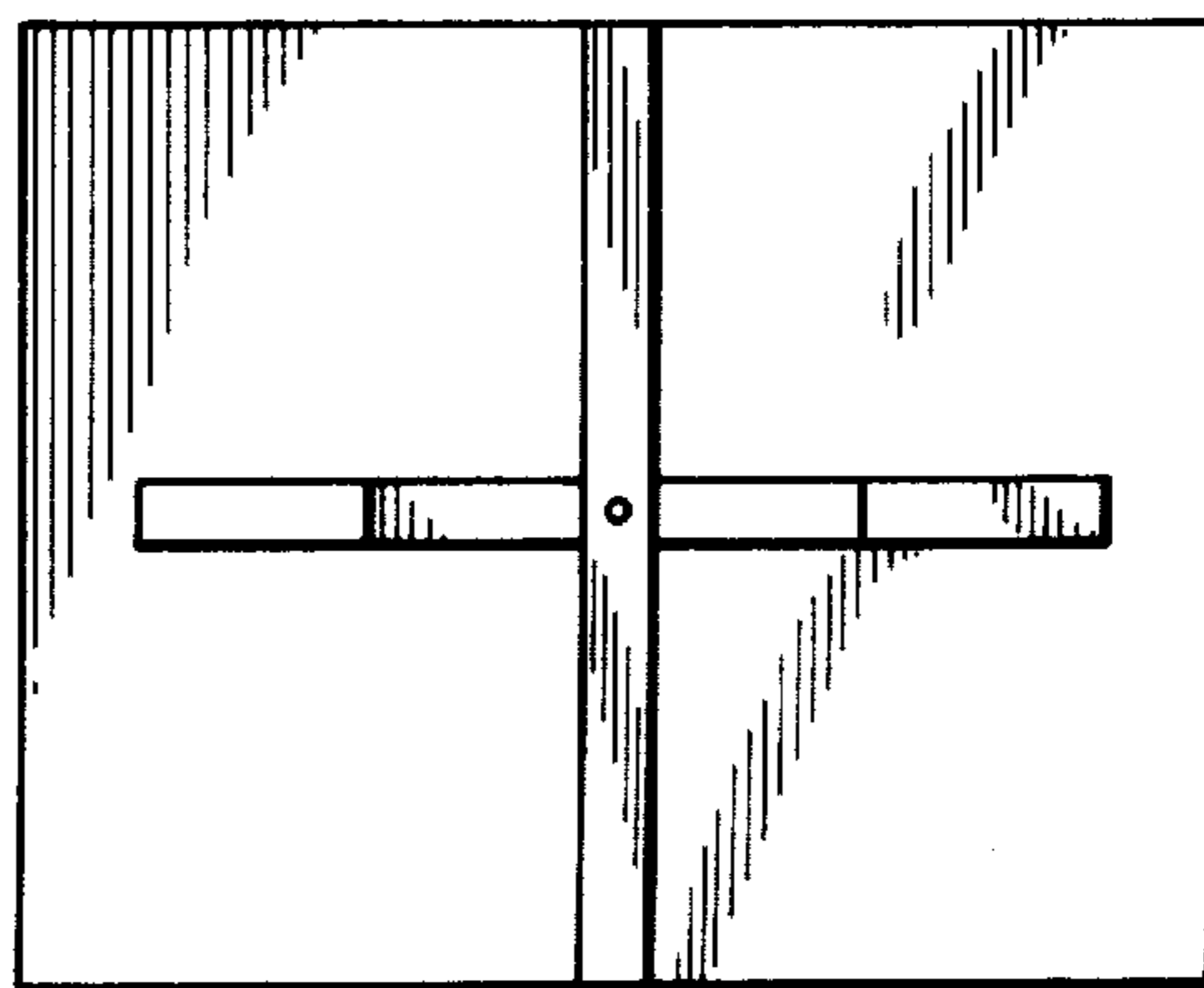

FIG. 6