



US0D1122367S

(12) **United States Design Patent**
Horn et al.

(10) **Patent No.: US D1,122,367 S**

(45) **Date of Patent: ** Apr. 14, 2026**

(54) **STRETCHING DEVICE**

(71) Applicant: **Advanced Kinetix LLC**, Royse City, TX (US)

(72) Inventors: **Kelli Jean Horn**, Royse City, TX (US);
Craig Dean Horn, Royse City, TX (US)

(73) Assignee: **Advanced Kinetix LLC**, Royse City, TX (US)

(**) Term: **15 Years**

(21) Appl. No.: **29/836,387**

(22) Filed: **Apr. 26, 2022**

(51) **LOC (15) Cl.** **21-02**

(52) **U.S. Cl.**
USPC **D21/679; D24/214**

(58) **Field of Classification Search**
USPC D21/324, 662, 673, 679, 686, 691, 692,
D21/694; D24/171, 200, 215
CPC A63B 2225/09; A63B 2023/006; A63B
2225/20; A63B 24/0075; A63B 21/0442;
A63B 1/00; A63B 23/1218; A63B
21/0724; A63B 21/068
See application file for complete search history.

(56) **References Cited**

U.S. PATENT DOCUMENTS

D405,851 S *	2/1999	McBride	D21/662
D423,676 S *	4/2000	Lazio	D24/214
D456,863 S *	5/2002	Smithy	D21/679
D769,454 S *	10/2016	Hong	D24/215
10,022,578 B2	7/2018	Kelly		

(Continued)

FOREIGN PATENT DOCUMENTS

CA	1239158 A	7/1988
DE	10 2009 039 742 A1	1/1900

Primary Examiner — George J Ulsh

Assistant Examiner — Gregory G Mclemore

(74) *Attorney, Agent, or Firm* — Foley & Lardner LLP

(57) **CLAIM**

An ornamental design for a stretching device as shown and described.

DESCRIPTION

FIG. 1 is an illustration of a front perspective view of a stretching device, according to a first illustrative embodiment;

FIG. 2 is an illustration of a front elevation view thereof;

FIG. 3 is an illustration of a rear elevation view thereof;

FIG. 4 is an illustration of a right-side view of thereof;

FIG. 5 is an illustration of a left-side view thereof;

FIG. 6 is an illustration of a top view thereof;

FIG. 7 is an illustration of a bottom view thereof;

FIG. 8 is an illustration of a front perspective view thereof with a top handle rotated relative to a bottom handle;

FIG. 9 is an illustration of a front perspective view thereof with the top handle further rotated relative to the bottom handle;

FIG. 10 is an illustration of a front perspective view thereof in a fully extended configuration;

FIG. 11 is an illustration of a top perspective view of a stretching device, according to a second illustrative embodiment;

FIG. 12 is an illustration of a front elevation view thereof;

FIG. 13 is an illustration of a rear elevation view thereof;

FIG. 14 is an illustration of a right-side view of thereof;

FIG. 15 is an illustration of a left-side view thereof;

FIG. 16 is an illustration of a top view thereof; and,

FIG. 17 is an illustration of a bottom view thereof.

The broken lines shown as dashed lines on the stretching device are for the purpose of illustrating unclaimed structure of the stretching device and form no part of the claimed design.

1 Claim, 11 Drawing Sheets

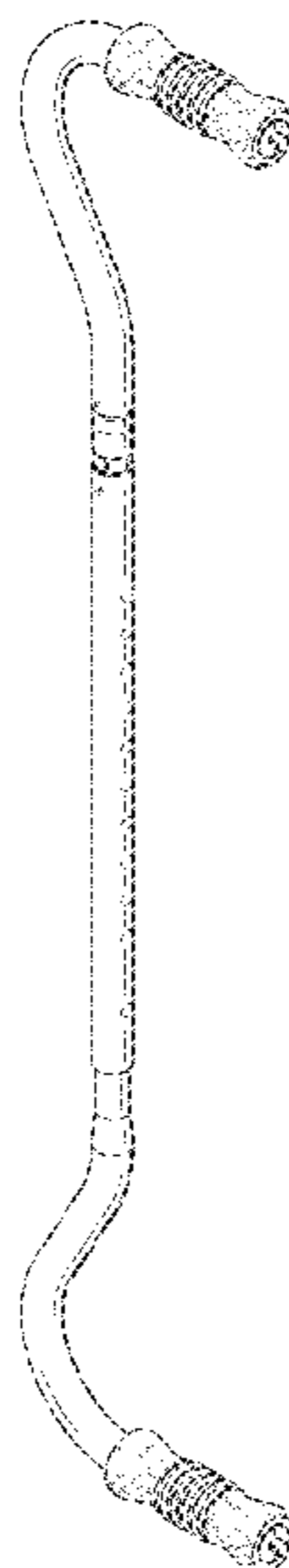

(56)

References Cited

U.S. PATENT DOCUMENTS

D853,505	S *	7/2019	Toueg	D21/679
10,413,776	B2	9/2019	Lewis	
D947,400	S *	3/2022	Mao	D24/214
D950,750	S *	5/2022	Bernstein	D24/215
D954,979	S *	6/2022	Flickinger	D24/213
D961,697	S *	8/2022	Alba	D21/679
D981,577	S *	3/2023	Reda	D24/214
D987,741	S *	5/2023	Morris	D21/679
D1,006,243	S *	11/2023	Savioli	D24/214
D1,069,942	S *	4/2025	Beasley	D21/679
D1,071,036	S *	4/2025	Wilkins	D21/679
D1,076,653	S *	5/2025	Cheng	D21/679
D1,080,772	S *	6/2025	Tsang	D21/679
2002/0082102	A1	6/2002	Reilly	
2015/0335934	A1	11/2015	Flynn	
2023/0024013	A1 *	1/2023	Horn	A63B 21/015

* cited by examiner

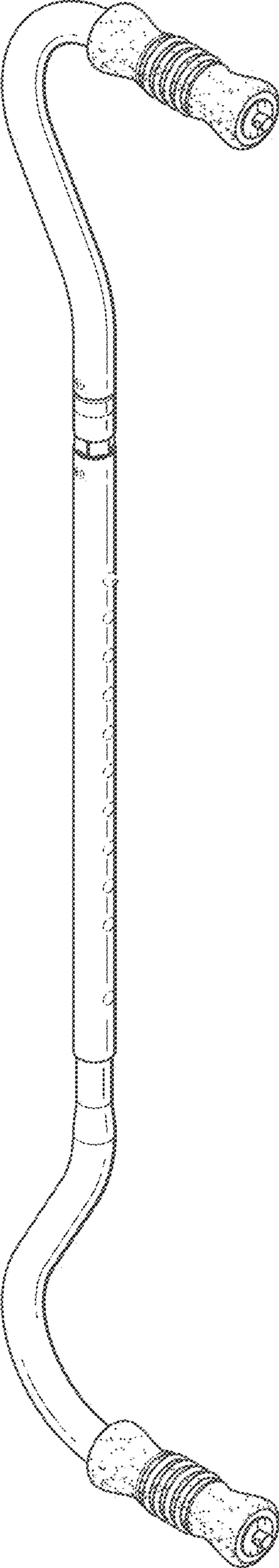

FIG. 1

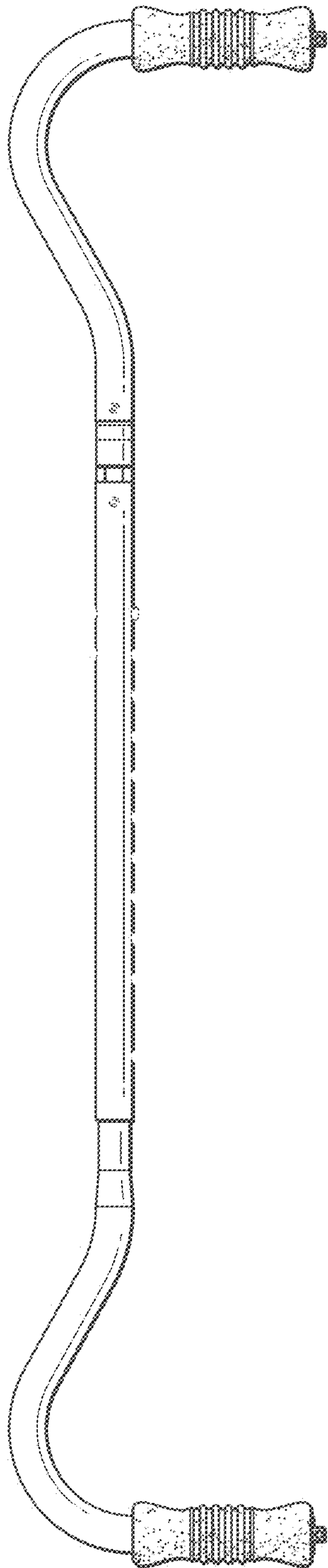

FIG. 2

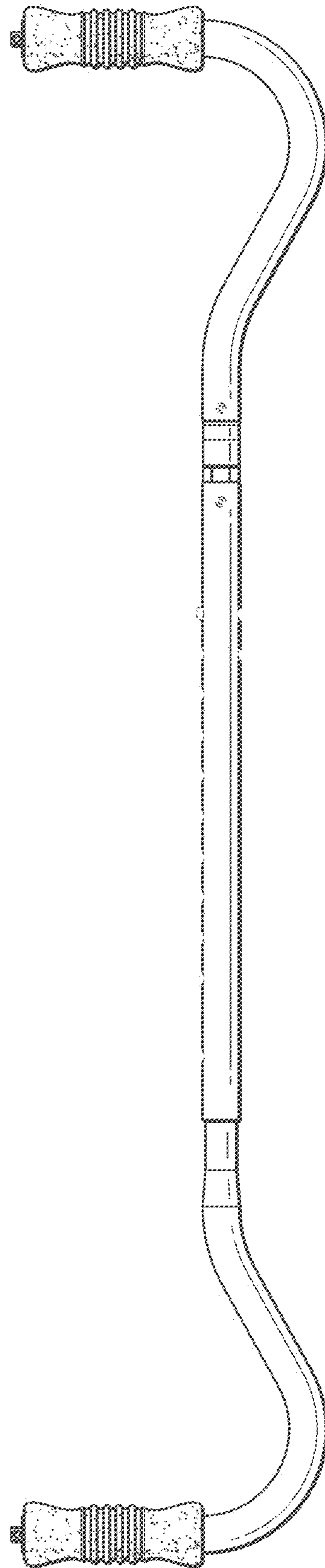

FIG. 3

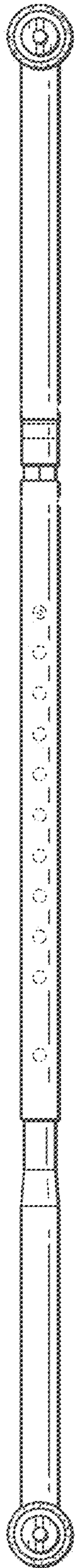

FIG. 4

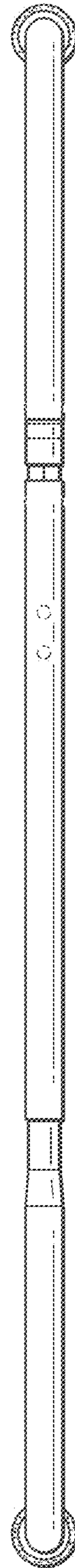

FIG. 5

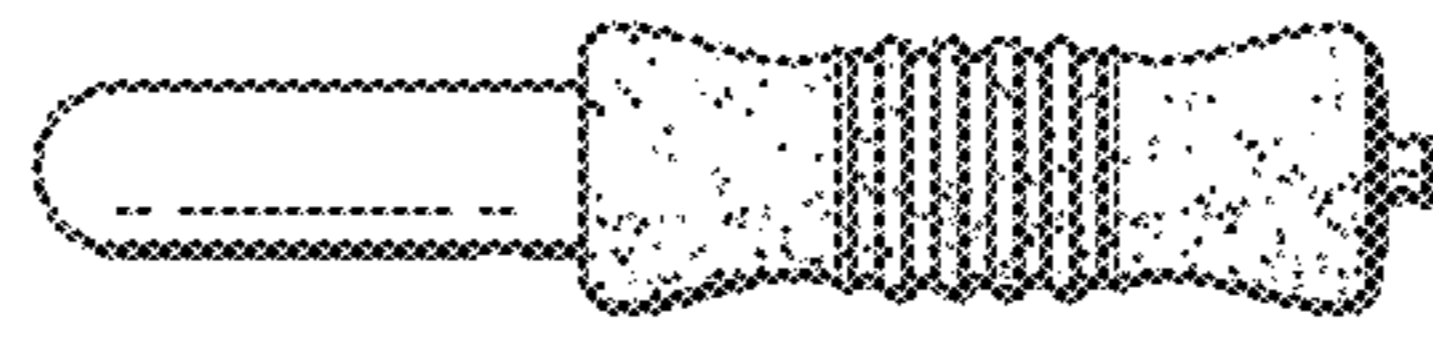

FIG. 6

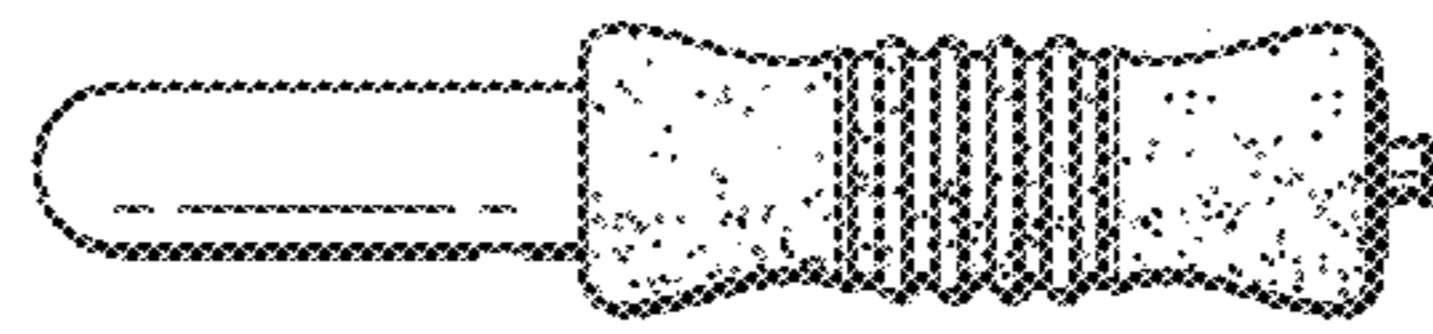

FIG. 7

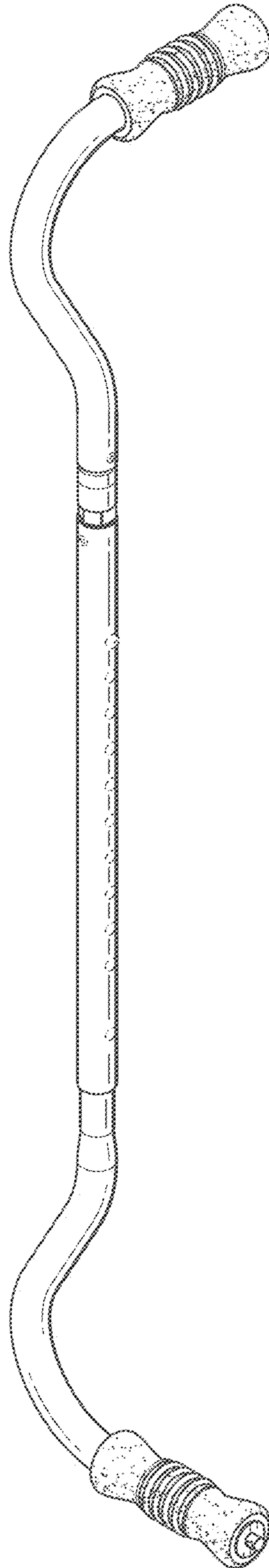

FIG. 8

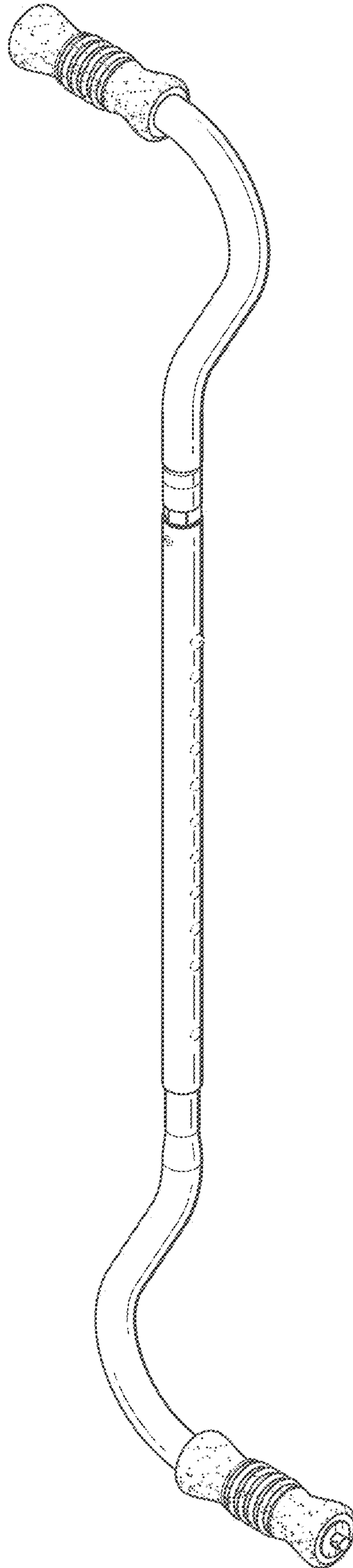

FIG. 9

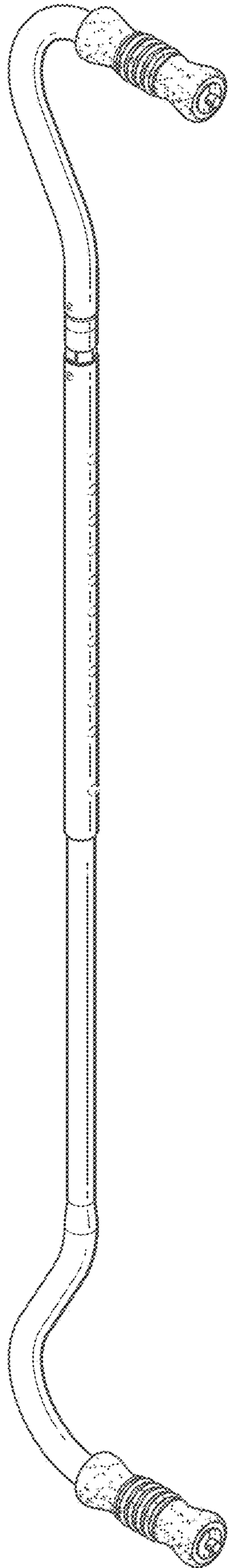

FIG. 10

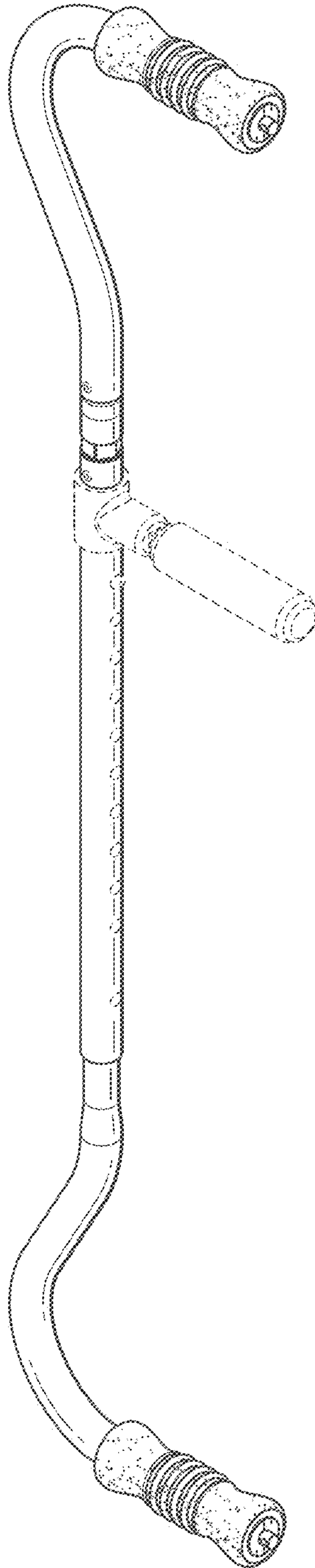

FIG. 11

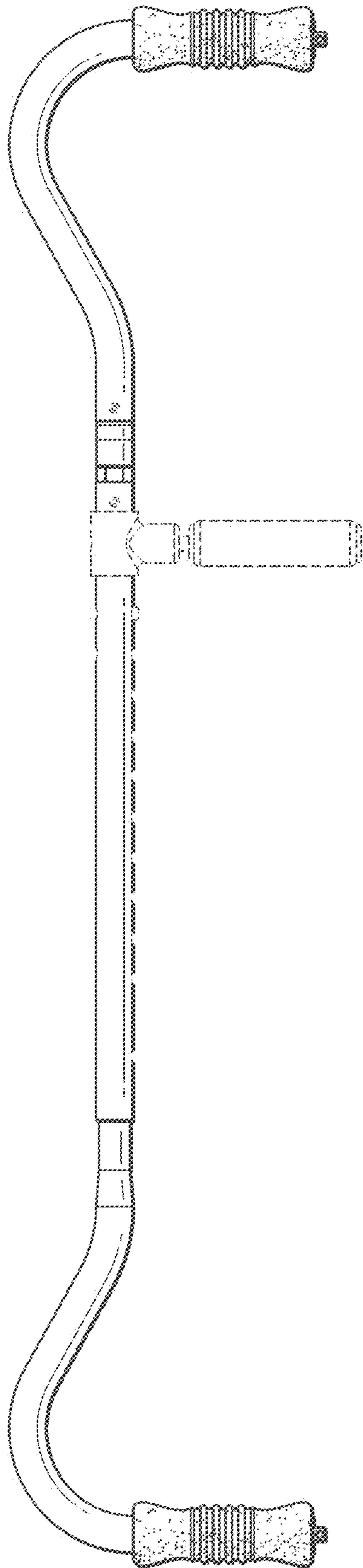

FIG. 12

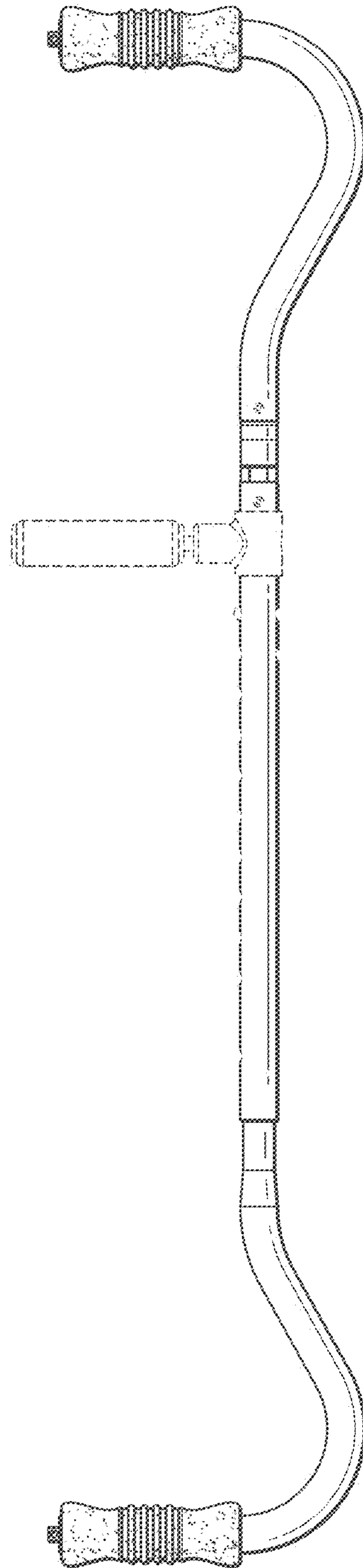

FIG. 13

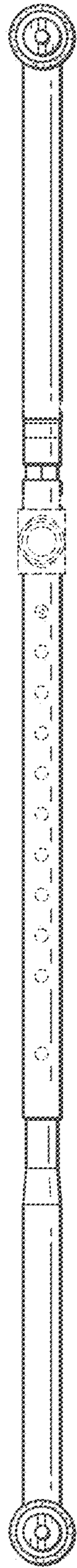

FIG. 14

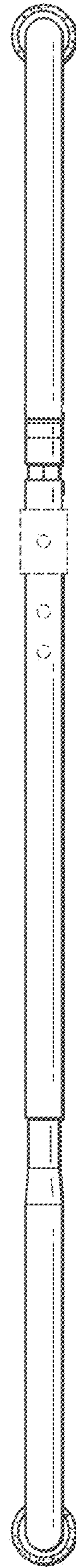

FIG. 15



FIG. 16



FIG. 17