



US0D1120821S

(12) **United States Design Patent**
Martin et al.

(10) **Patent No.:** **US D1,120,821 S**
(45) **Date of Patent:** **** Mar. 31, 2026**

(54) **MODEL VEHICLE AXLE CARRIER**

(71) Applicant: **TRAXXAS, L.P.**, McKinney, TX (US)

(72) Inventors: **Ross Martin**, North Richland Hills, TX (US); **Otto Karl Allmendinger**, Rowlett, TX (US); **Adam Cole Ewing**, McKinney, TX (US); **Caleb Hix**, McKinney, TX (US)

(73) Assignee: **TRAXXAS, L.P.**, McKinney, TX (US)

(**) Term: **15 Years**

(21) Appl. No.: **29/962,996**

(22) Filed: **Sep. 13, 2024**

(51) **LOC (15) Cl.** **21-01**

(52) **U.S. Cl.**
USPC **D21/562**

(58) **Field of Classification Search**
USPC D21/561-562; D12/159
CPC . B60G 7/001; B60G 7/02; B60G 3/20; B60G 2200/144
See application file for complete search history.

(56) **References Cited**

U.S. PATENT DOCUMENTS

D826,340 S	8/2018	Ewing et al.	
D845,842 S	4/2019	Sun	
D878,974 S	3/2020	McGaughy	
D880,375 S	4/2020	McGaughy	
D900,250 S	10/2020	Ewing et al.	
D902,090 S *	11/2020	Ewing	D12/159
D904,532 S	12/2020	Ewing et al.	
D905,798 S *	12/2020	Ewing	D12/159
D905,799 S *	12/2020	Ewing	D12/159
D944,901 S *	3/2022	Ewing	D21/562
D947,290 S	3/2022	Christensen et al.	
D947,957 S *	4/2022	Ewing	D21/562
D951,149 S *	5/2022	Ewing	D12/159
D951,150 S *	5/2022	Ewing	D12/159
D996,528 S	8/2023	Christensen et al.	

D1,014,655 S *	2/2024	Christensen	D12/159
D1,014,656 S *	2/2024	Christensen	D12/159
D1,049,262 S	10/2024	Wood et al.	
D1,051,244 S	11/2024	Ewing et al.	

(Continued)

FOREIGN PATENT DOCUMENTS

EM	007721154-0006	3/2020
GB	6307596	9/2023

(Continued)

OTHER PUBLICATIONS

Xray; "T1R Raycer-Instruction Manual;" Xray Model Racing Cars, Trencin, Slovak Republic, Europe (admitted prior art).

(Continued)

Primary Examiner — Michael A. Pratt

(74) *Attorney, Agent, or Firm* — Daryl R. Wright; Greg Carr

(57) **CLAIM**

The ornamental design for a model vehicle axle carrier as shown and described.

DESCRIPTION

FIG. 1 is an upper, left, front perspective view of a model vehicle axle carrier showing our new design; FIG. 2 is an upper, right, rear perspective view thereof; FIG. 3 is a lower, right, front perspective view thereof; FIG. 4 is a lower, left, rear perspective view thereof; FIG. 5 is a front elevation view thereof; FIG. 6 is a rear elevation view thereof; FIG. 7 is an upper plan view thereof; FIG. 8 is a lower plan view thereof; FIG. 9 is a right-side elevation view thereof; and, FIG. 10 is a left-side elevation view of a model vehicle axle carrier.

1 Claim, 9 Drawing Sheets

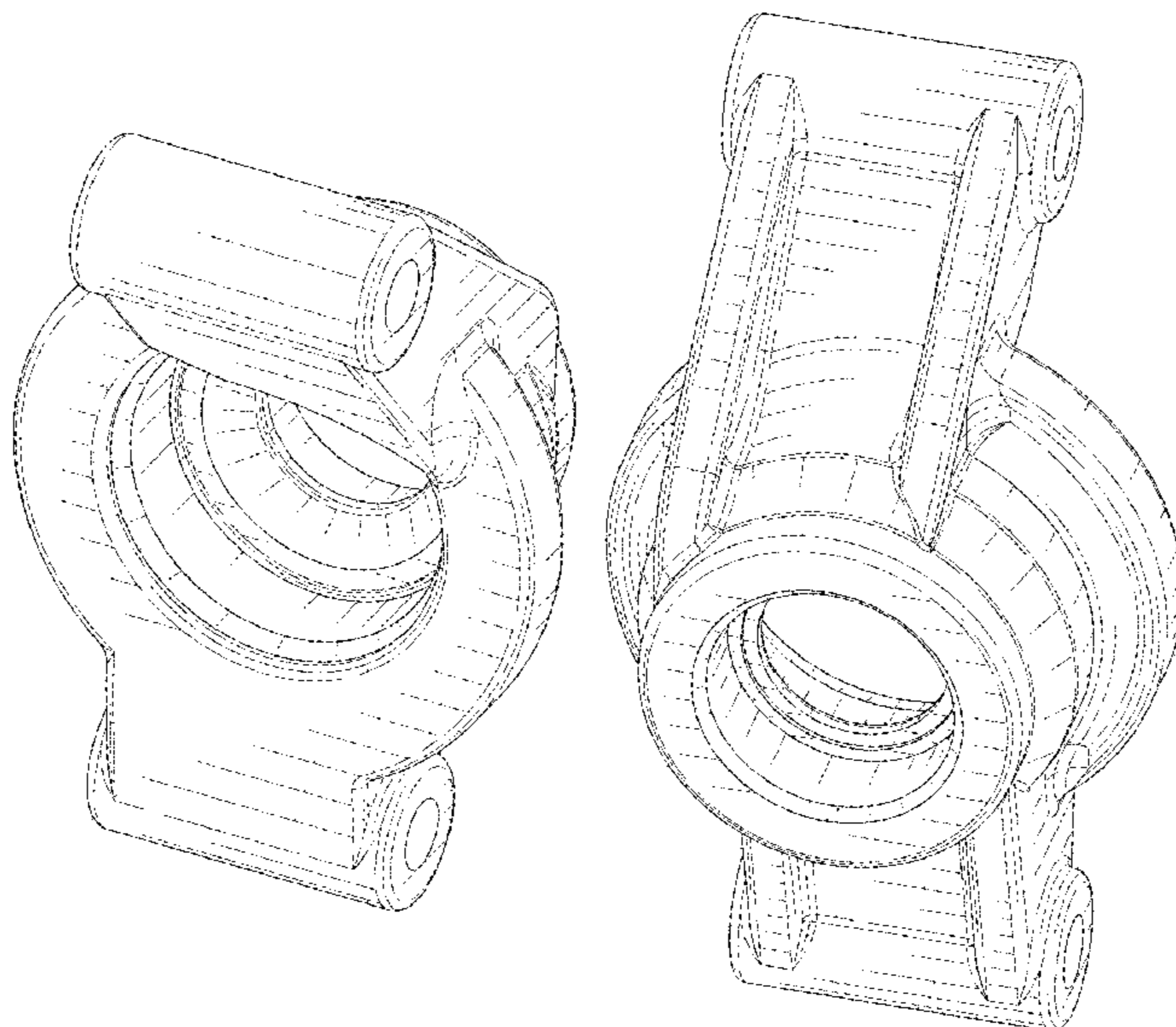

(56)

References Cited

U.S. PATENT DOCUMENTS

D1,051,245 S	11/2024	Ewing et al.
D1,060,528 S	2/2025	Poteet et al.
D1,074,847 S	5/2025	House et al.
D1,094,587 S	9/2025	Perez et al.

FOREIGN PATENT DOCUMENTS

GB	6307601	9/2023
TW	179940-0001	12/2016
WO	D095551-014	4/2017

OTHER PUBLICATIONS

Traxxas Rear Stub Axle Carrier (1.5 Degree), Earliest Available Date Oct. 29, 2007 [Online], [Site Visited Oct. 28, 2020]. Available From Internet, URL: <https://www.amainhobbies.com/traxxas-rear-stub-axle-carrier-1.5-degree-tra4352/p17759?gclid=EAlalQobChMlyY7Ak_TX7AIVWQIICR1dzw2fEAQYBCABEgL99vD_BWE> (Year: 2007).
 Traxxas Rear Stub Axle Carrier, Published date unavailable [online], [retrieved on Febb. 5, 2022]. Retrieved from the Internet: <https://www.rcmart.com/traxxas-rear-left-and-right-stub-axle-carrier-for-jato-5555-00036488> (Year: 2022).

Carriers stub axle, First Date Available: Unknown, Imaged retrieved on: Jun. 3, 2023, <<https://traxxas.com/products/parts/9552>>.
 Measjimi Brand, 2pcs Alloy Rear Stub Axle Hub Carrier 7752 for RC Hobby Car 1/5 1/6 X-MAXX (Red), as shown in www.amazon.com, No. date listed, Jun. 17, 2024, date found, Asin B09MH1V2Q. (Year: 2024).
 Weiqian brand, 1 Pair RC Rear Hub Carrier Portable Flexible CNC Aluminum Alloy Rear Stub Axle Carrier Replacement for TRAXXAS 1/5 Black, as shown in www.walmart.com, No. date listed, Jun. 17, 2024, date found. (Year: 2024).
 RPM Oversized Rear Axle Carriers for Traxxas X-Maxx, as shown in www.hobbytown.com, Sep. 27, 2016, Part # RPM81732. (Year: 2016).
 RiToEasysports 2Pcs RC Rear Axle Carrier, posted date unknown [online], [retrieved xx/xx/xx]. Retrieved from internet, https://www.amazon.com/RiToEasysports-Carrier-Aluminum-Alloy-Compatible/dp/B09JGDWWSK/ref=sr_1_28 (Year: 2024).
 Traxxas 3752 Stub Axle Carrier (pair), Amazon Website, Earliest Comment Date: Jul. 25, 2014 [Website Visited Oct. 1, 2024], Available on the Internet URL: <https://www.amazon.com/dp/B000SU2DOC/> (Year: 2014).
 Aluminum Stub Axle Carriers, Traxxas Website, No. Available Date [Website Visited Oct. 1, 2024], Available on the Internet URL: <https://traxxas.com/products/parts/7852-blue> (Year: 2024).

* cited by examiner

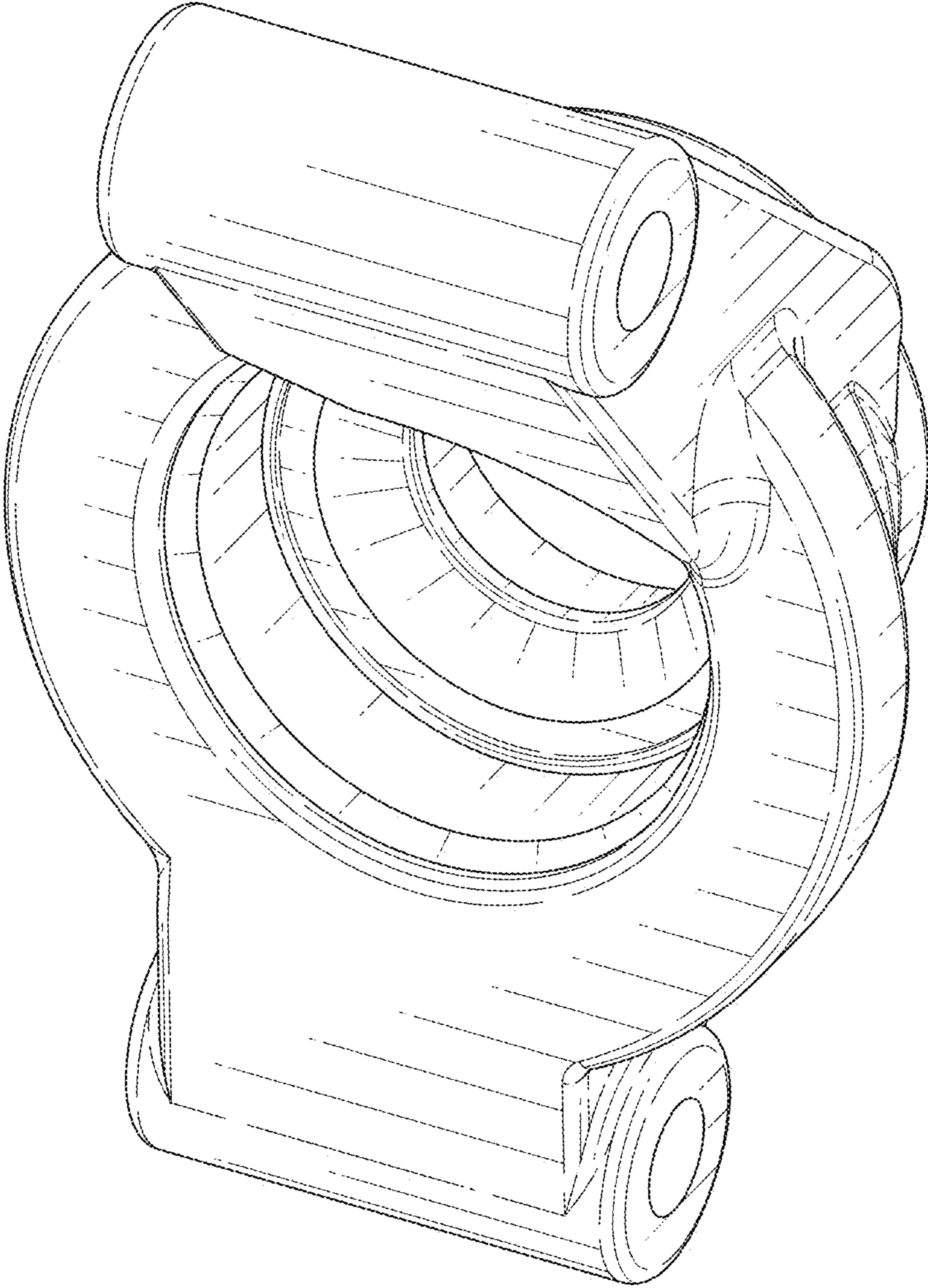

FIG. 1

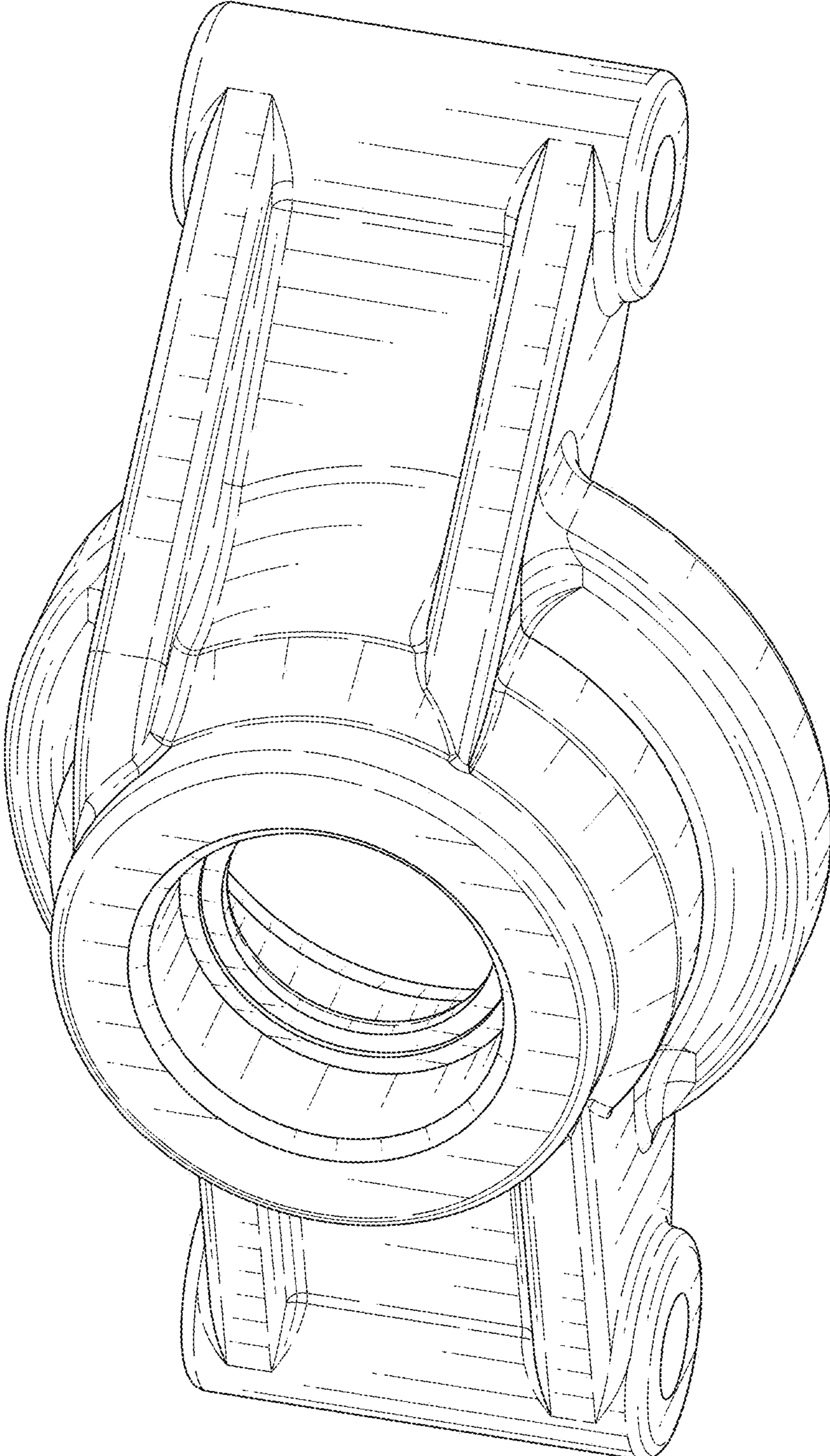

FIG. 2

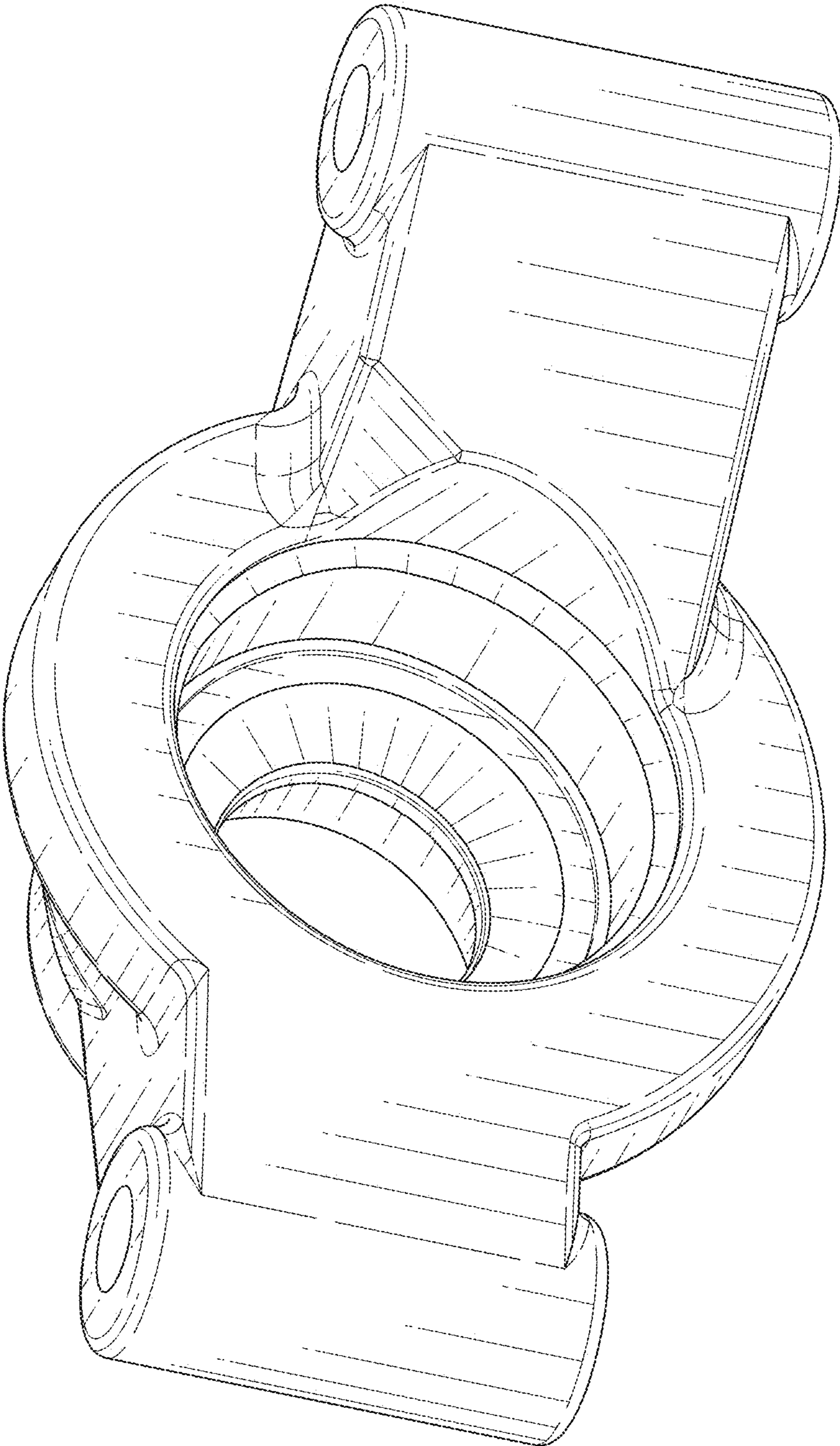

FIG. 3

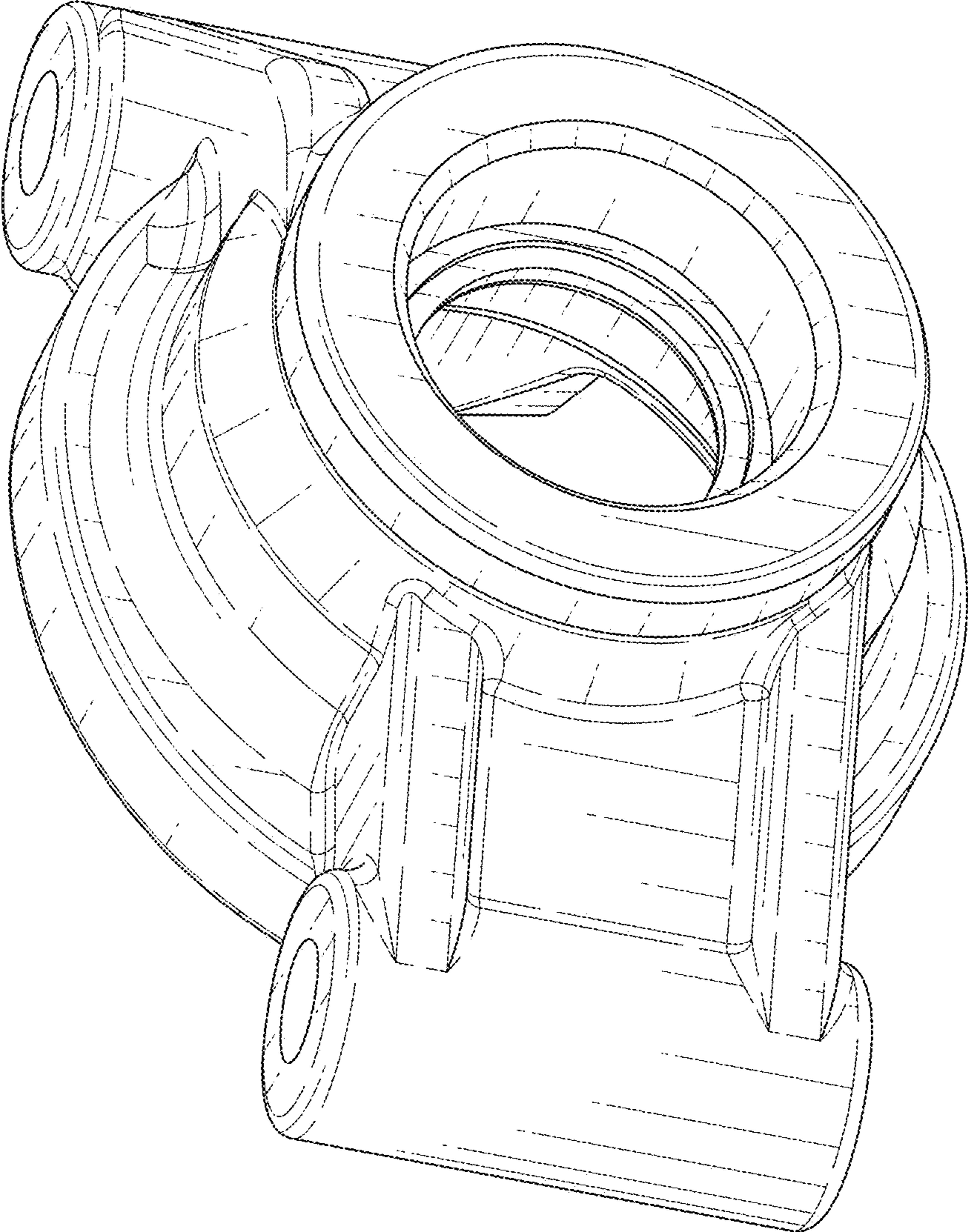

FIG. 4

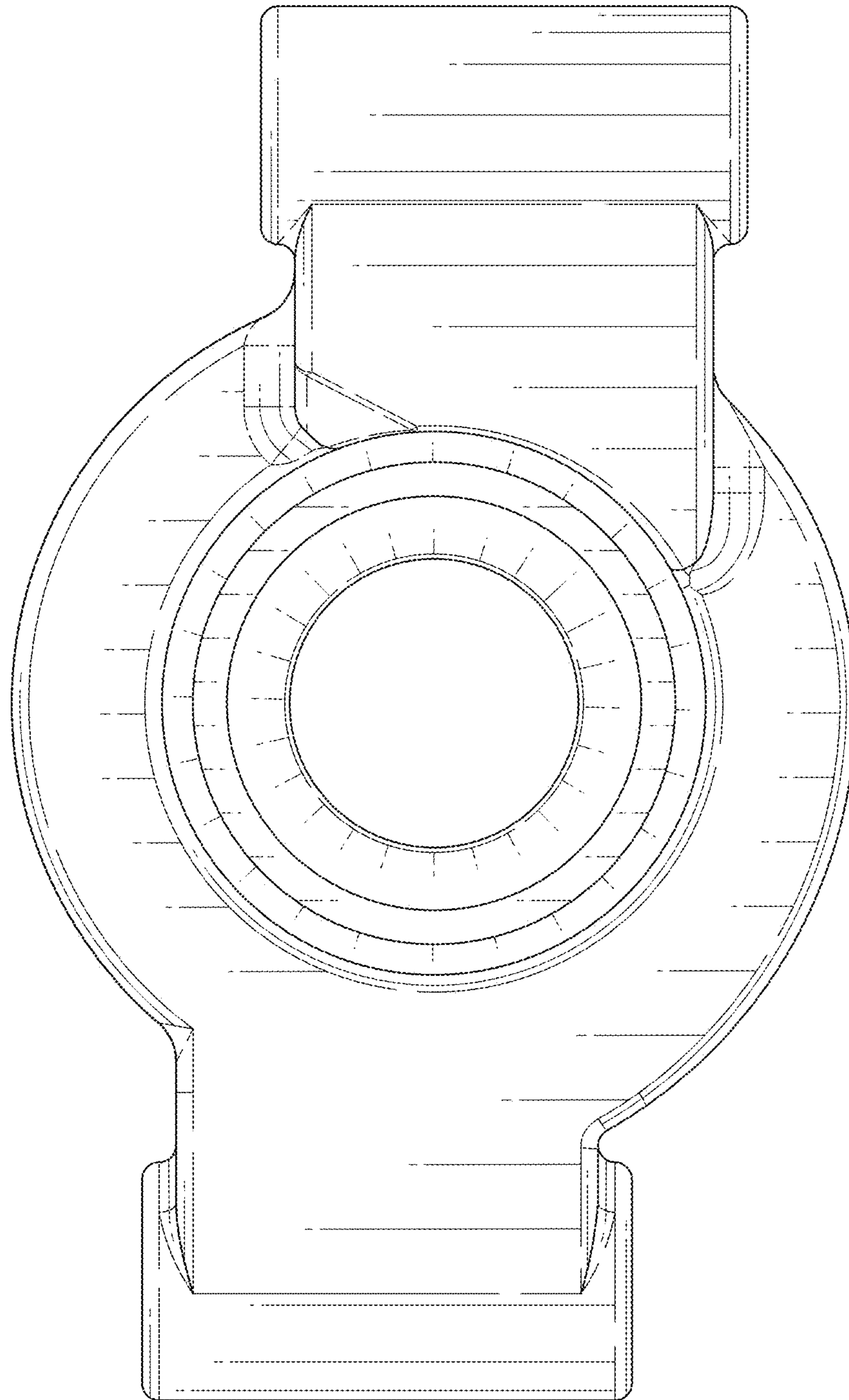

FIG. 5

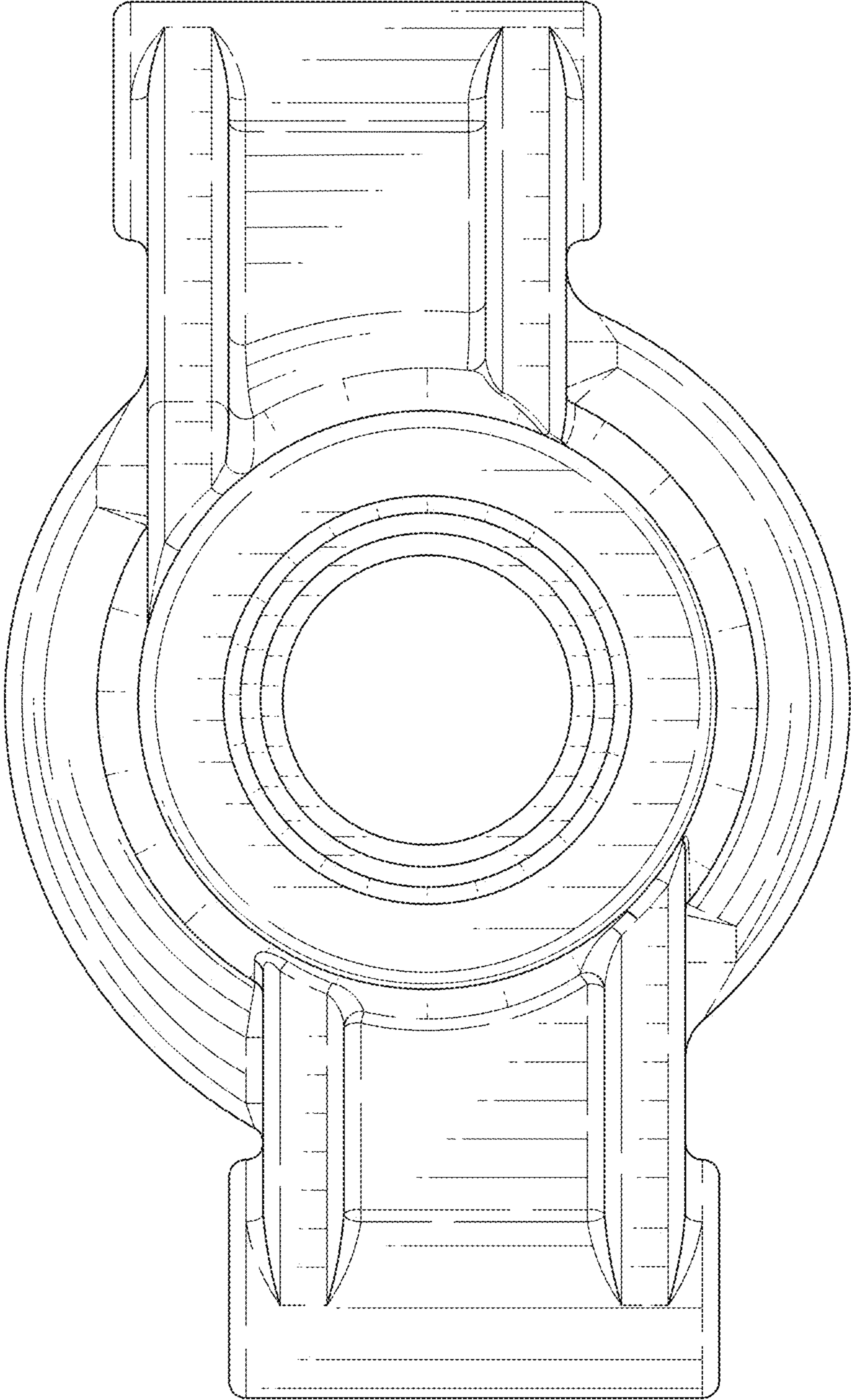

FIG. 6

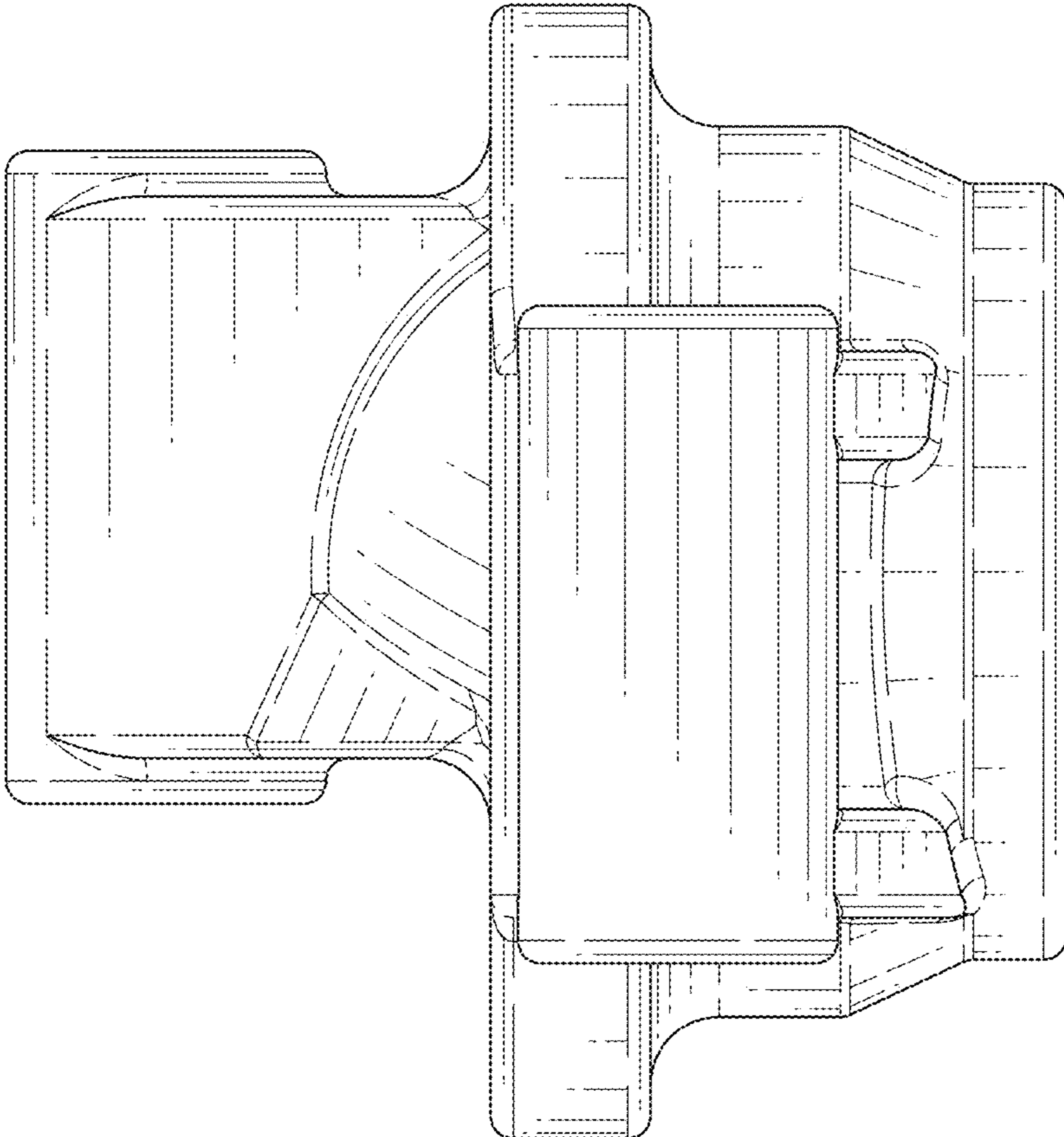

FIG. 8

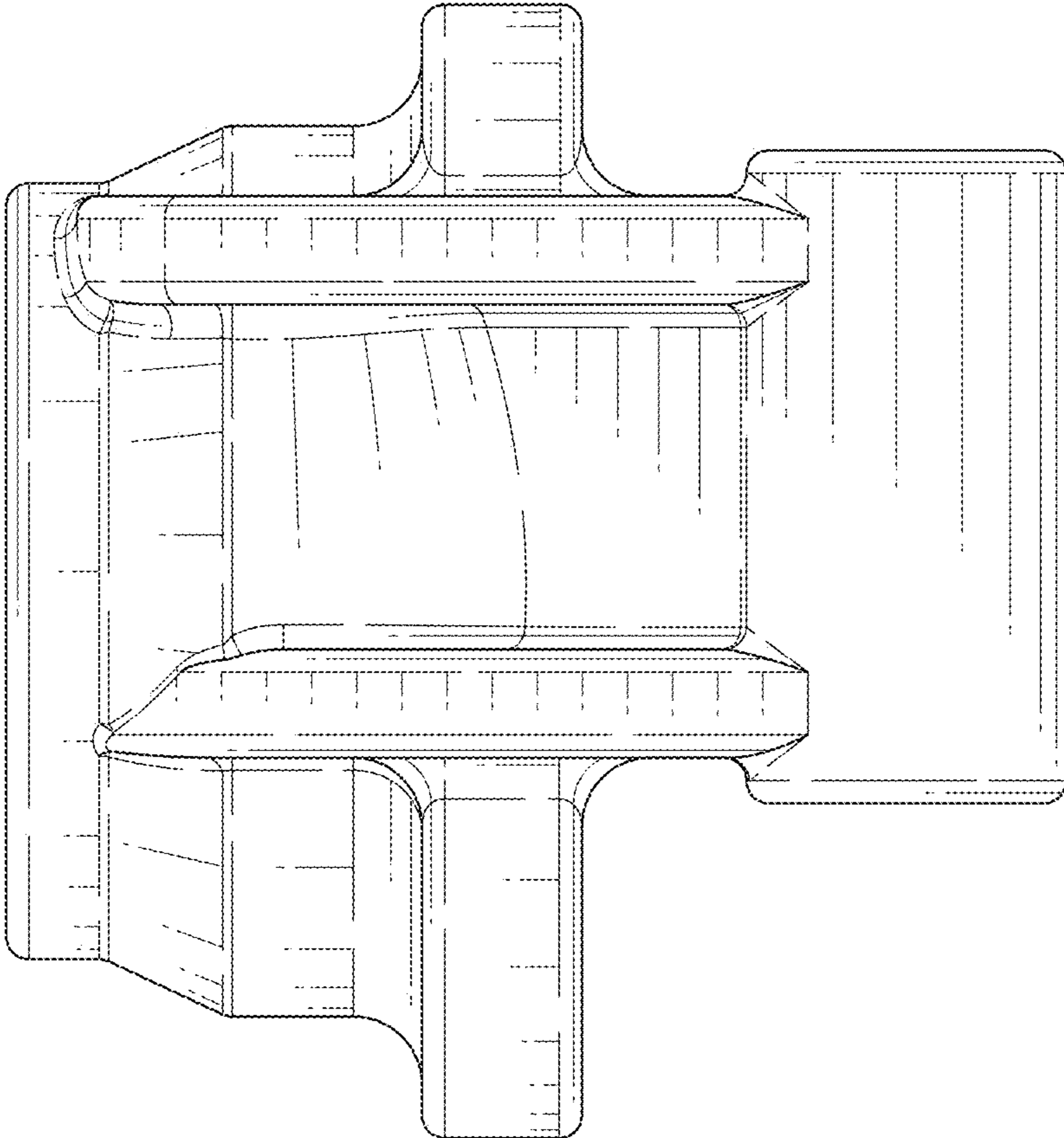

FIG. 7

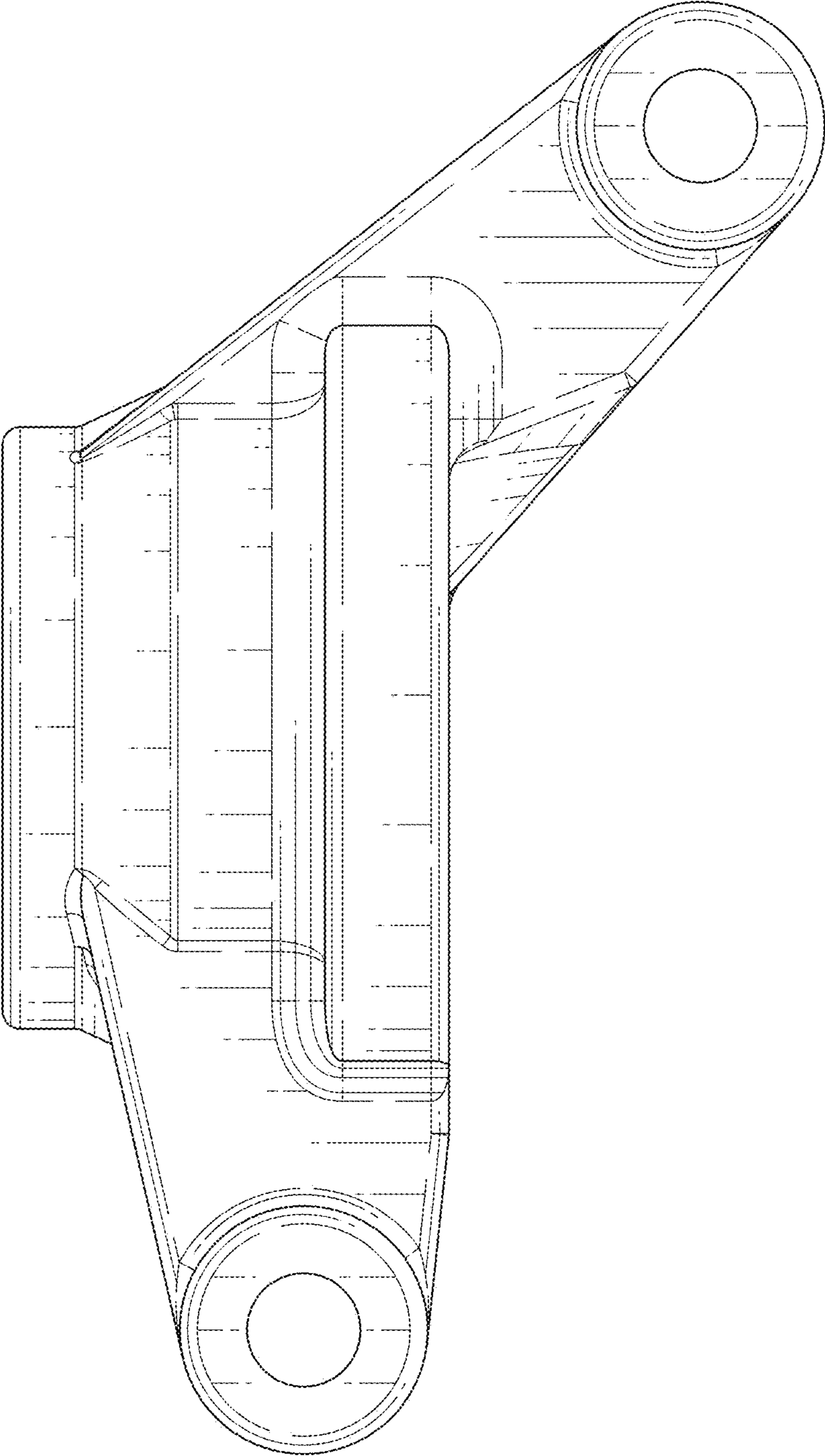

FIG. 9

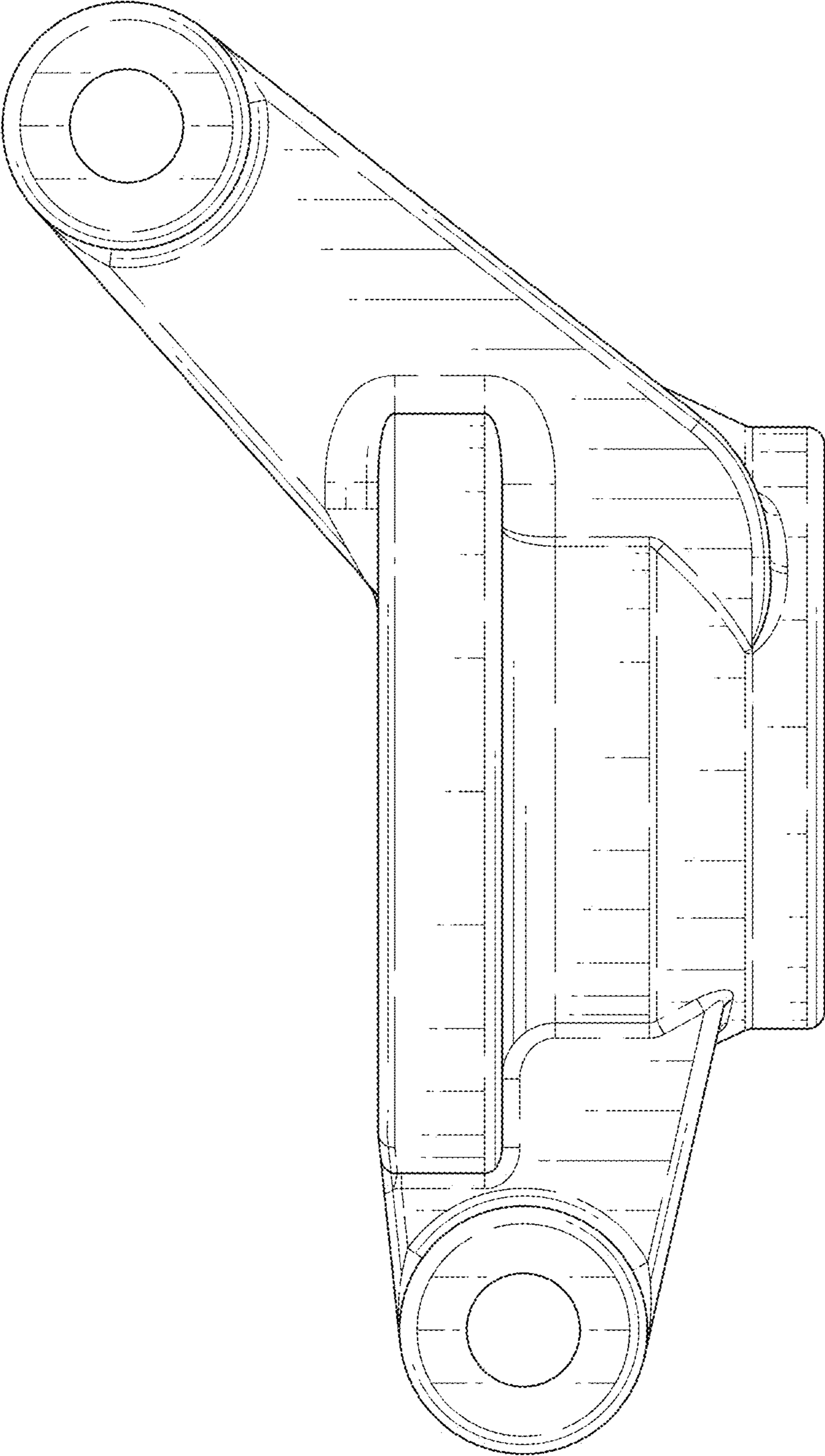

FIG. 10