



US0D1120356S

(12) **United States Design Patent** (10) **Patent No.:** **US D1,120,356 S**
Chen (45) **Date of Patent:** **** Mar. 24, 2026**

(54) **THERAPY BELT**

FOREIGN PATENT DOCUMENTS

(71) Applicant: **HAIKOU LILI INVESTMENT CO., LTD.**, Haikou (CN)

CN 305174546 S * 5/2019
CN 305613057 S * 2/2020

(72) Inventor: **Junyuan Chen**, Haikou (CN)

OTHER PUBLICATIONS

(73) Assignee: **HAIKOU LILI INVESTMENT CO., LTD.**, Haikou (CN)

Comfytemp, Comfytemp Portable Belly and Back Heating Pad, Pub: Sep. 8, 2025, Amazon.com, Retrieved from: https://www.amazon.com/Comfytemp-Portable-Cordless-Dual-Zone-Menstrual/dp/B0DZ2J1GS1/ref=sr_1_6 (Year: 2025).*

(**) Term: **15 Years**

(Continued)

(21) Appl. No.: **29/982,208**

(22) Filed: **Jan. 6, 2025**

Primary Examiner — Daniel J Domino
Assistant Examiner — Edward P Jones

(30) **Foreign Application Priority Data**

Jul. 15, 2024 (CN) 202430439269.4

(51) **LOC (15) Cl.** **24-01**

(52) **U.S. Cl.**
USPC **D24/200**; D24/190; D24/206

(58) **Field of Classification Search**
USPC D24/107, 188, 189, 190, 191, 192, 200, D24/206, 207, 208, 209, 231; D23/215, D23/221; D26/624, 627

CPC A61H 2201/02; A61F 7/00; A61F 7/10; A61F 7/02; A61F 7/08; A61F 7/0097; A61F 2007/0024

See application file for complete search history.

(56) **References Cited**

U.S. PATENT DOCUMENTS

D338,533 S * 8/1993 Burget D24/206
D397,838 S * 9/1998 Waggoner D2/624
D598,556 S * 8/2009 Chen D24/190
D826,516 S * 8/2018 Vopni D2/624
D831,221 S * 10/2018 Smith D24/190
D861,903 S * 10/2019 Cryan D24/200
D947,389 S * 3/2022 Ye D24/188
D1,036,683 S * 7/2024 Uzodike D24/206

(Continued)

(57) **CLAIM**

The ornamental design for a therapy belt as shown and described.

DESCRIPTION

FIG. 1 is a perspective view of a therapy belt showing my new design;
FIG. 2 is another perspective view thereof;
FIG. 3 is a front elevational view thereof;
FIG. 4 is a rear elevational view thereof;
FIG. 5 is a left side elevational view thereof;
FIG. 6 is a right side elevational view thereof;
FIG. 7 is an enlarged top plan view of the therapy belt;
FIG. 8 is an enlarged bottom plan view of the therapy belt;
FIG. 9 is an enlarged view of portion 9 shown in FIG. 5; and
FIG. 10 is an enlarged view of portion 10 shown in FIG. 8.
The dash-dash broken lines in the drawings depict portions of the therapy belt that form no part of the claimed design. The dot-dash broken lines in FIGS. 5, 8, and 9-10 represent boundaries of the enlarged portions and form no part of the claimed design.

1 Claim, 10 Drawing Sheets

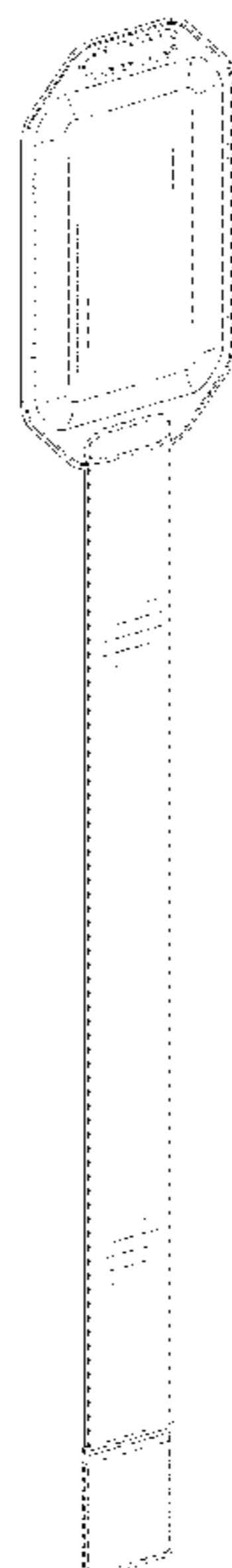

(56)

References Cited

U.S. PATENT DOCUMENTS

D1,041,120 S * 9/2024 Hu D2/702
D1,047,157 S * 10/2024 Sun D24/206
D1,098,463 S * 10/2025 Luo D24/209
D1,100,240 S * 10/2025 Wen D24/209
2004/0055076 A1 * 3/2004 Yoo A61H 39/04
2/338
2015/0306413 A1 * 10/2015 Tripolsky A61N 2/008
600/15

OTHER PUBLICATIONS

Cyferuy, Upgrade Portable Heating Pad for Period Cramps, Pub: Apr. 17, 2025, Amazon.com, Retrieved from: https://www.amazon.com/dp/B0DK8TF9W9/ref=sspa_dk_detail_3 (Year: 2025).*

Pixie Cup, Pixie Period Heating Pad for Cramps, Pub: Dec. 22, 2022, Amazon.com, Retrieved from: https://www.amazon.com/Pixie-Period-Heating-Pad-Cramps-Purple/dp/B0FHJDG4WM/ref=sr_1_6 (Year: 2022).*

* cited by examiner

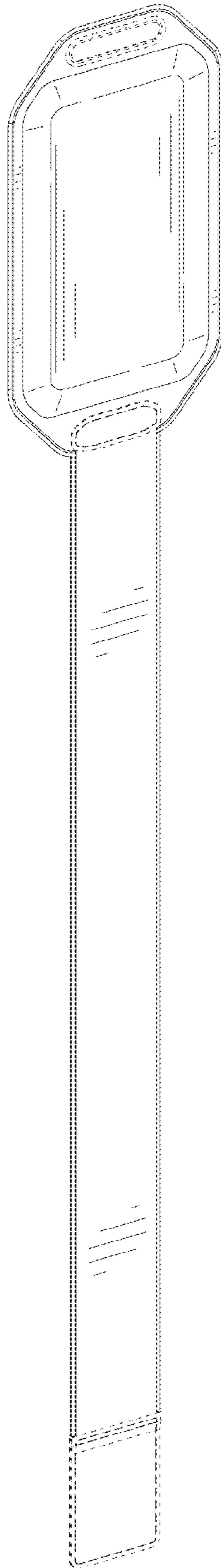

FIG. 1

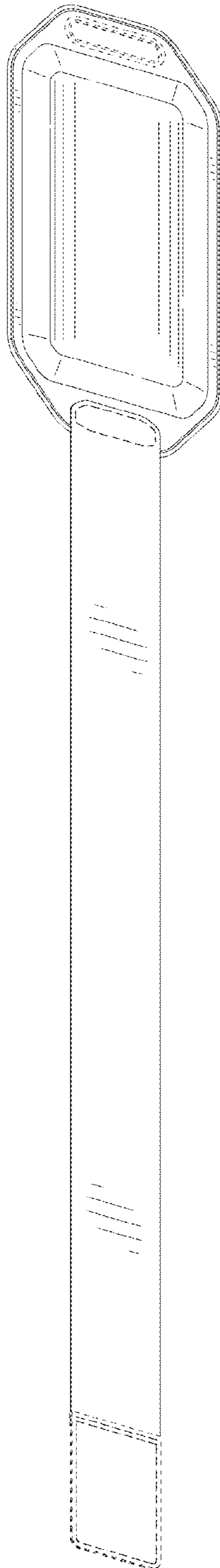

FIG. 2

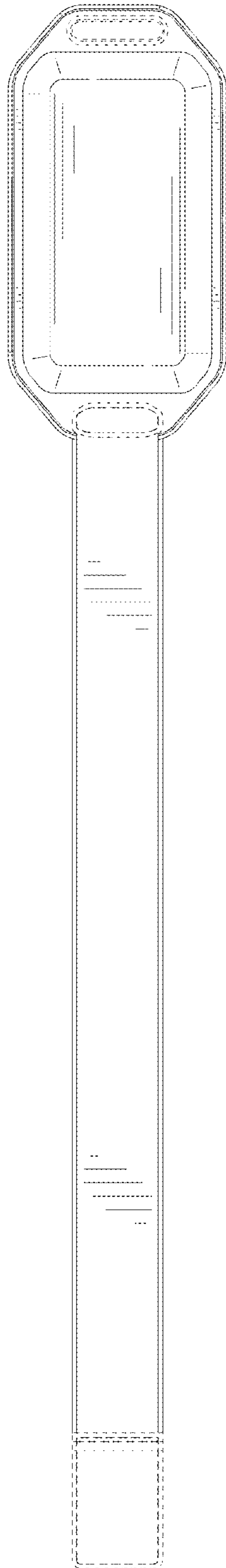

FIG. 3

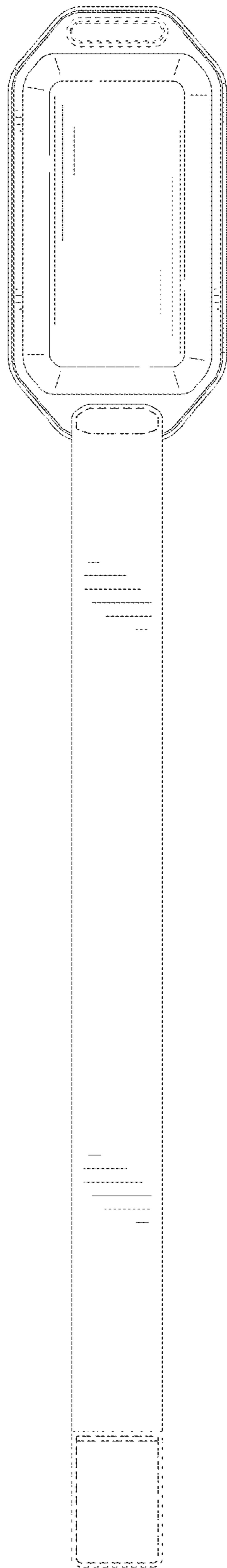

FIG. 4

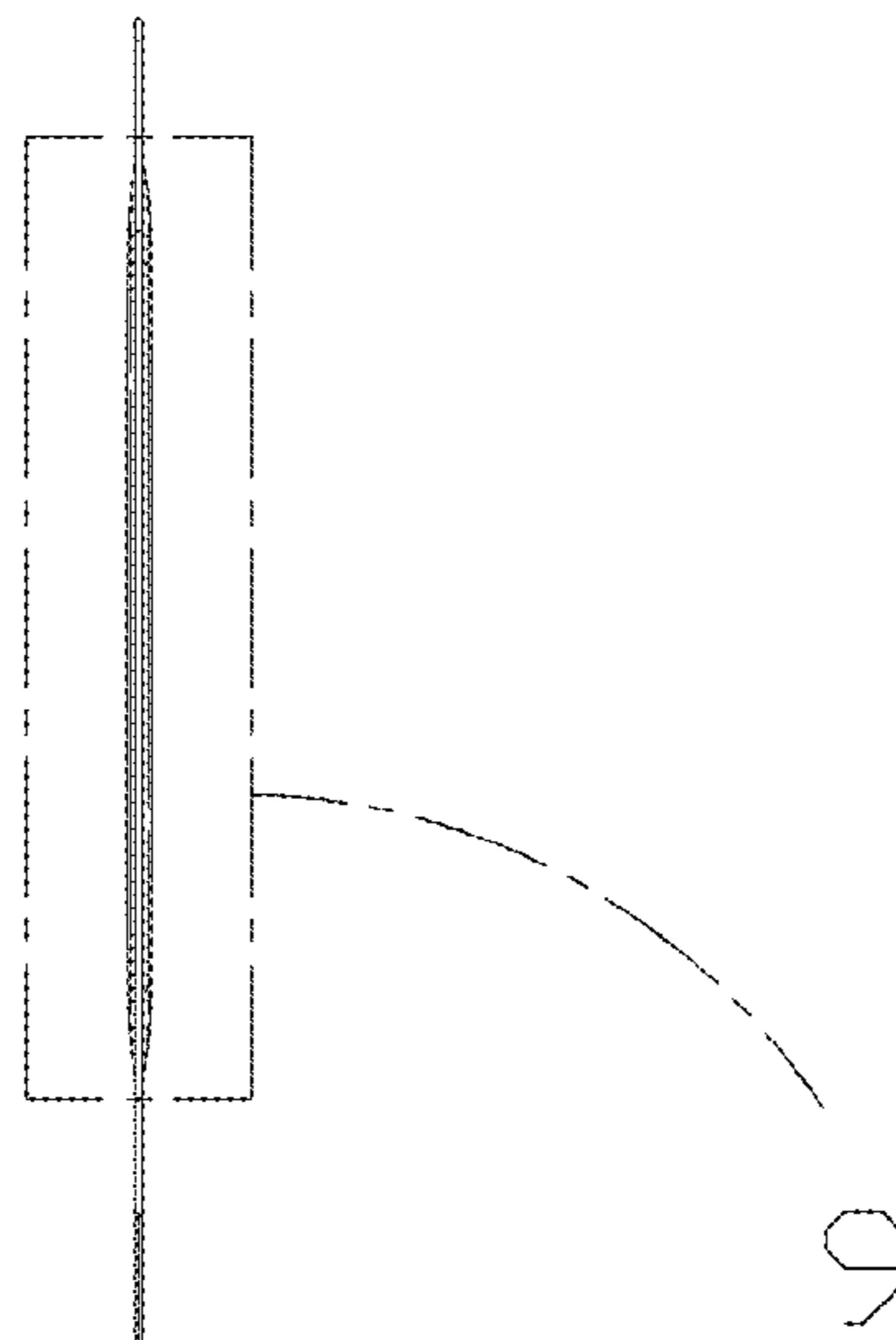

FIG. 5

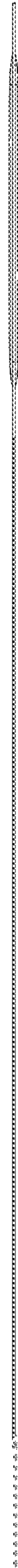

FIG. 6

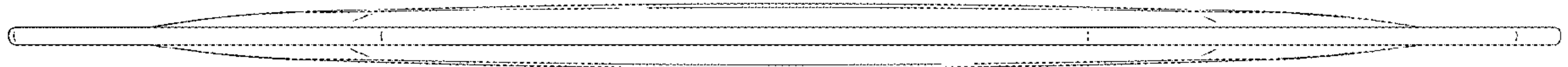

FIG. 7

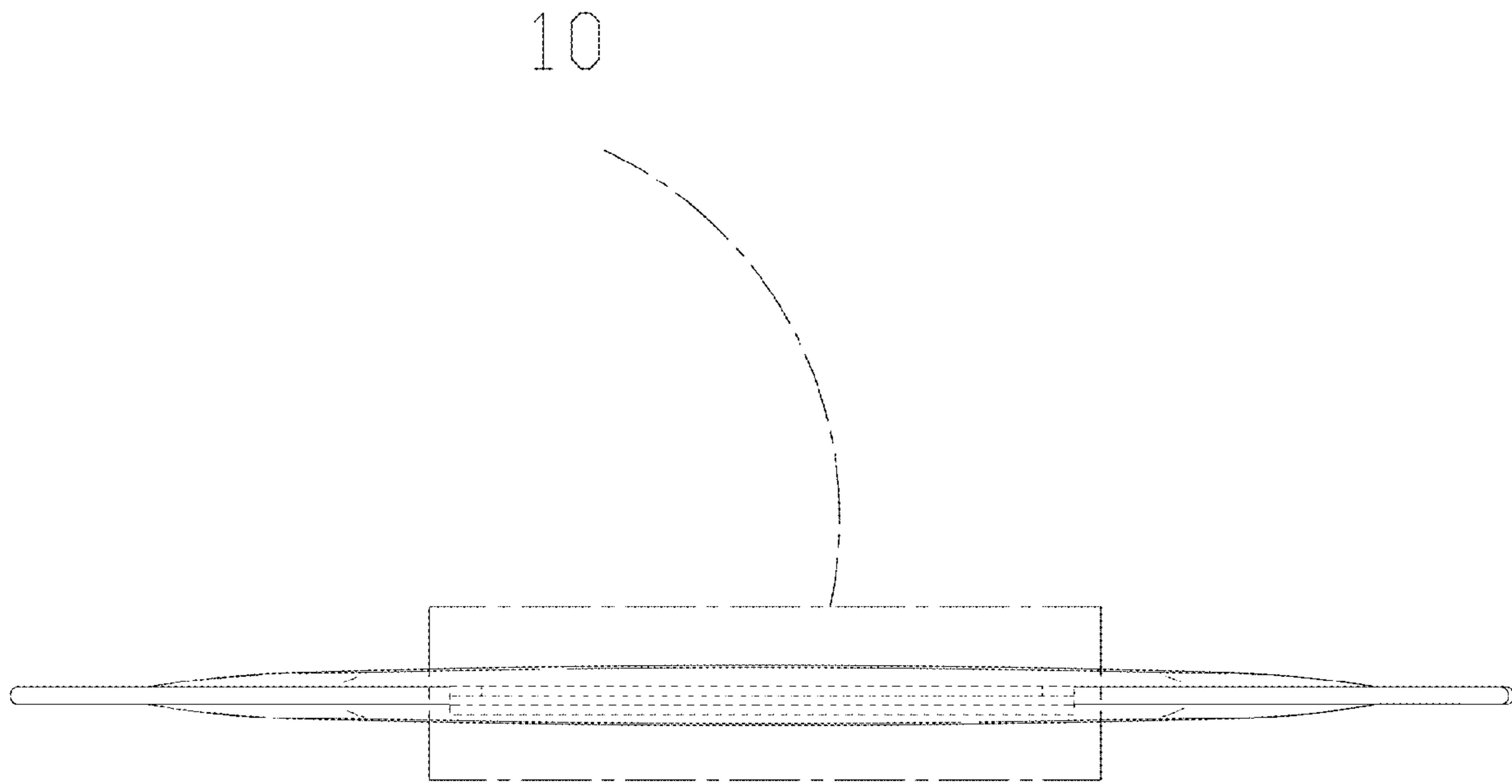

FIG. 8

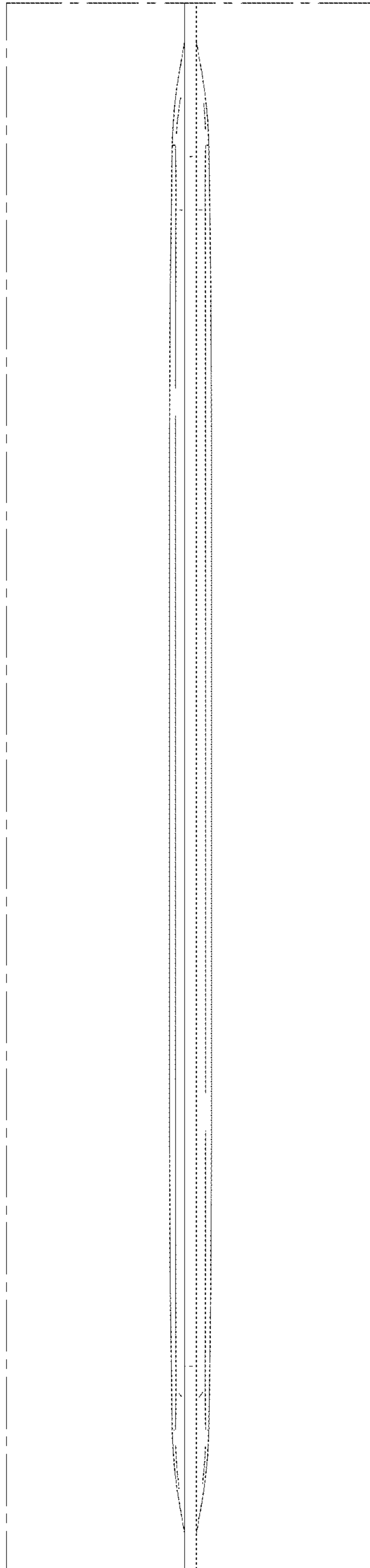

FIG. 9

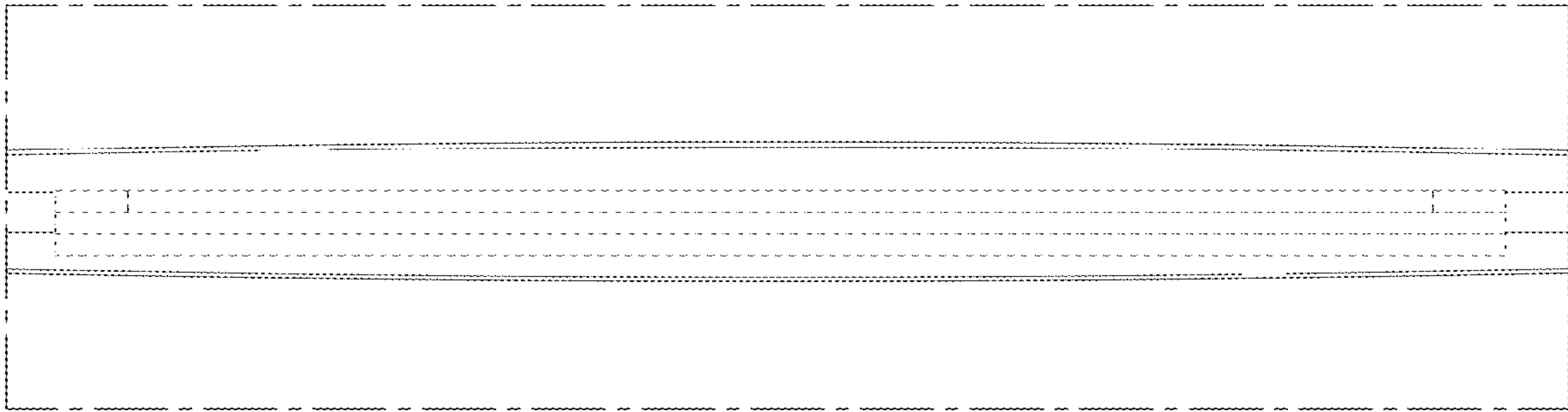

FIG. 10