



US0D1078402S

(12) **United States Design Patent** (10) **Patent No.: US D1,078,402 S**
Hood, II (45) **Date of Patent: ** Jun. 10, 2025**

(54) **FOOTBALL BOTTLE**

(71) Applicant: **Iondration, LLC**, Rockwall, TX (US)
(72) Inventor: **Antoine Hood, II**, Rockwall, TX (US)
(73) Assignee: **Iondration, LLC**, Rockwall, TX (US)
(**) Term: **15 Years**
(21) Appl. No.: **29/878,489**

(22) Filed: **Jun. 22, 2023**
(51) **LOC (15) Cl.** **09-01**
(52) **U.S. Cl.**
USPC **D9/668**; D9/540
(58) **Field of Classification Search**
USPC D9/600, 601, 668, 516, 540, 543, 548,
D9/549, 551, 553, 572, 575, 563, 564,
D9/612; D7/301, 514, 515, 516, 613,
D7/901; D3/270, 271.1, 271.9
CPC B65D 5/4258; B65D 81/60; B65D 81/365;
B65D 81/366; B65D 81/368; B65D
2203/00; B65D 2203/02
See application file for complete search history.

(56) **References Cited**

U.S. PATENT DOCUMENTS

D409,904 S *	5/1999	Clements	D9/668
D571,670 S *	6/2008	Lepoitevin	D9/668
D724,902 S *	3/2015	Dickerson	D7/625
D753,506 S *	4/2016	Veletakos	D9/557
D761,660 S *	7/2016	Giles	D9/668

OTHER PUBLICATIONS

Sawysine Football Ball Cups with Straws and Lids_Amazon, [date first available: Oct. 24, 2022], [date found online: Aug. 6, 2024], <https://www.amazon.com/dp/B0BK8ZNGTG> (Year: 2022).*
V V&I Pro Innovation Football Water Bottle_Amazon.in, [date first available: Jan. 10, 2020], [date found online: Aug. 6, 2024], <https://www.amazon.in/Football-Drinking-Squeezable-Shatterproof-Accessory/dp/B07T16M4JF> (Year: 2020).*

* cited by examiner

Primary Examiner — Shawn T Gingrich
Assistant Examiner — Katherine E Morris
(74) *Attorney, Agent, or Firm* — Sheri Higgins Law, PLLC; Sheri Higgins

(57) **CLAIM**

The ornamental design for a football bottle, as shown and described.

DESCRIPTION

FIG. 1 is a perspective view of a football bottle showing my new design.
FIG. 2 is a left side view thereof, wherein the right side view is a mirror image of the left side view.
FIG. 3 is a front view thereof.
FIG. 4 is a back view thereof.
FIG. 5 is a top view thereof; and,
FIG. 6 is a bottom view thereof.
The broken lines shown in the drawings depict portions of the football bottle that form no part of the claimed design.

1 Claim, 5 Drawing Sheets

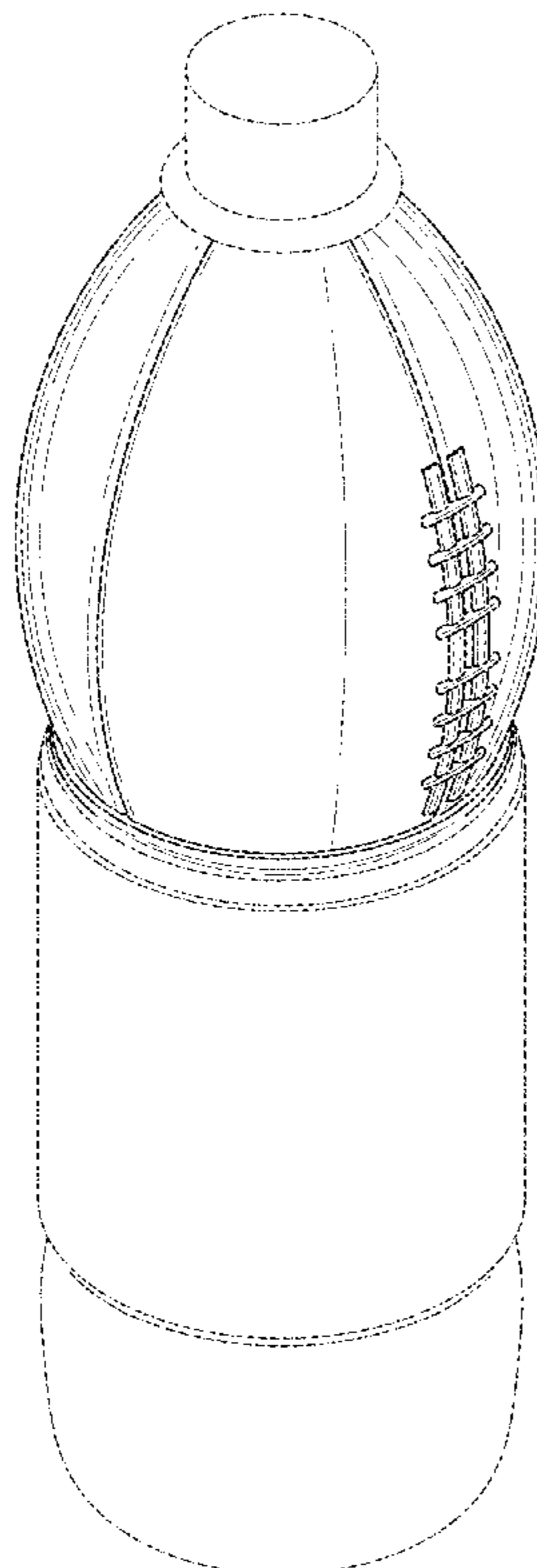

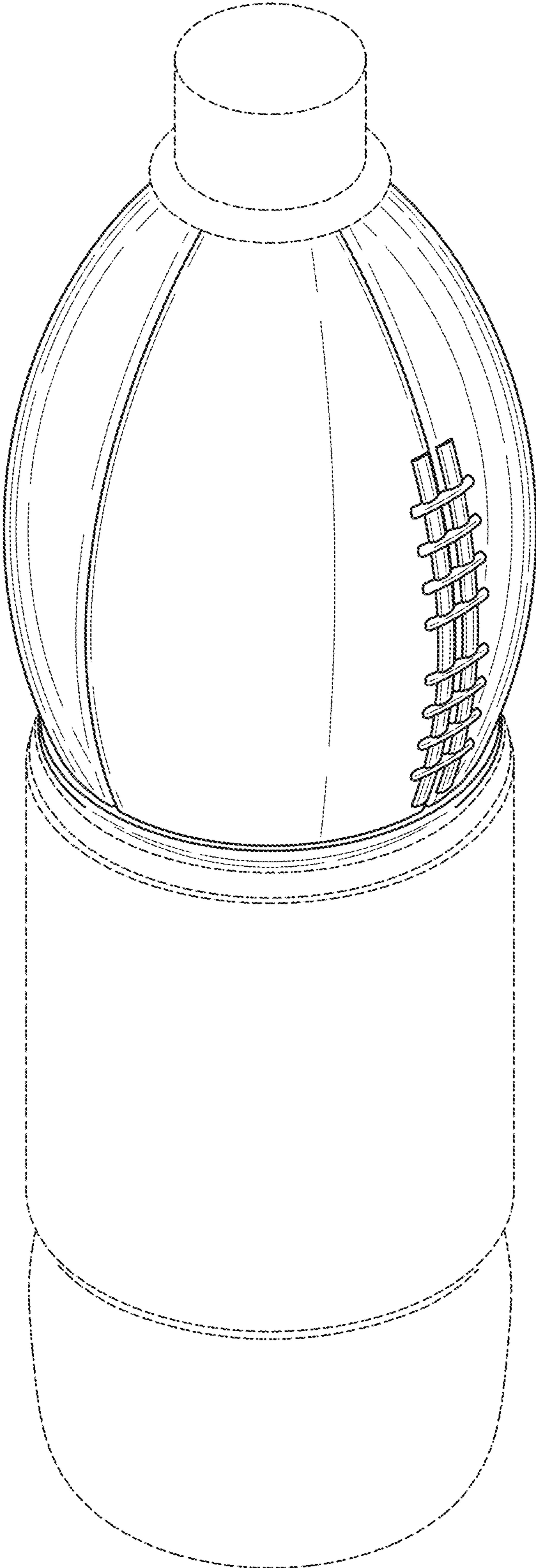

FIG. 1

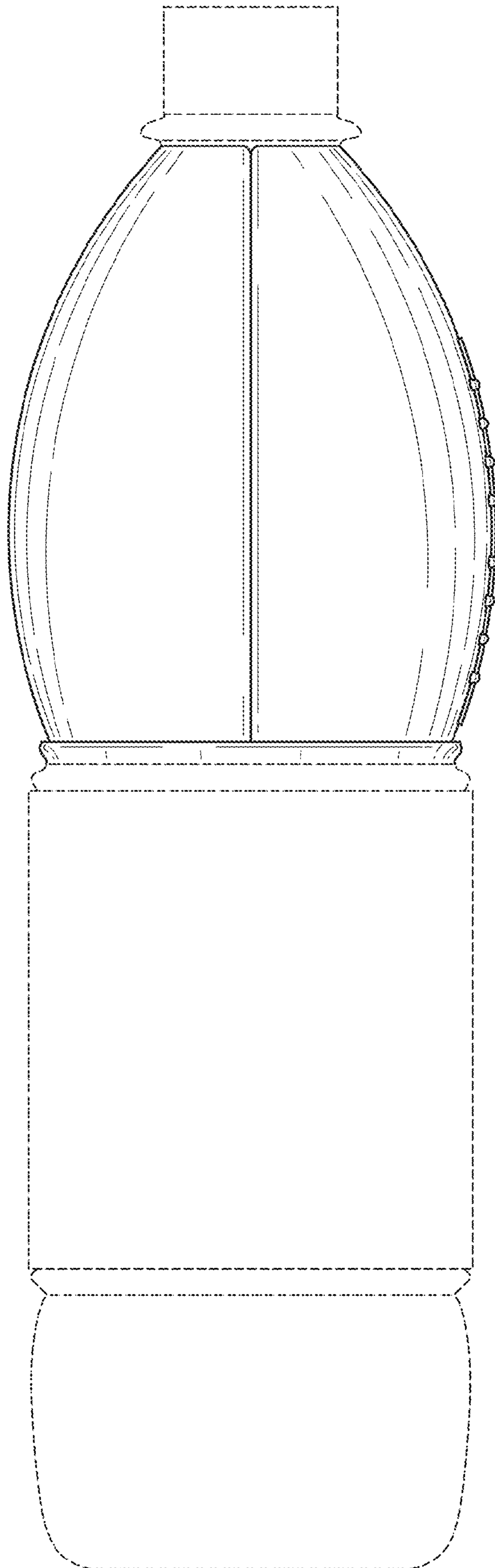

FIG. 2

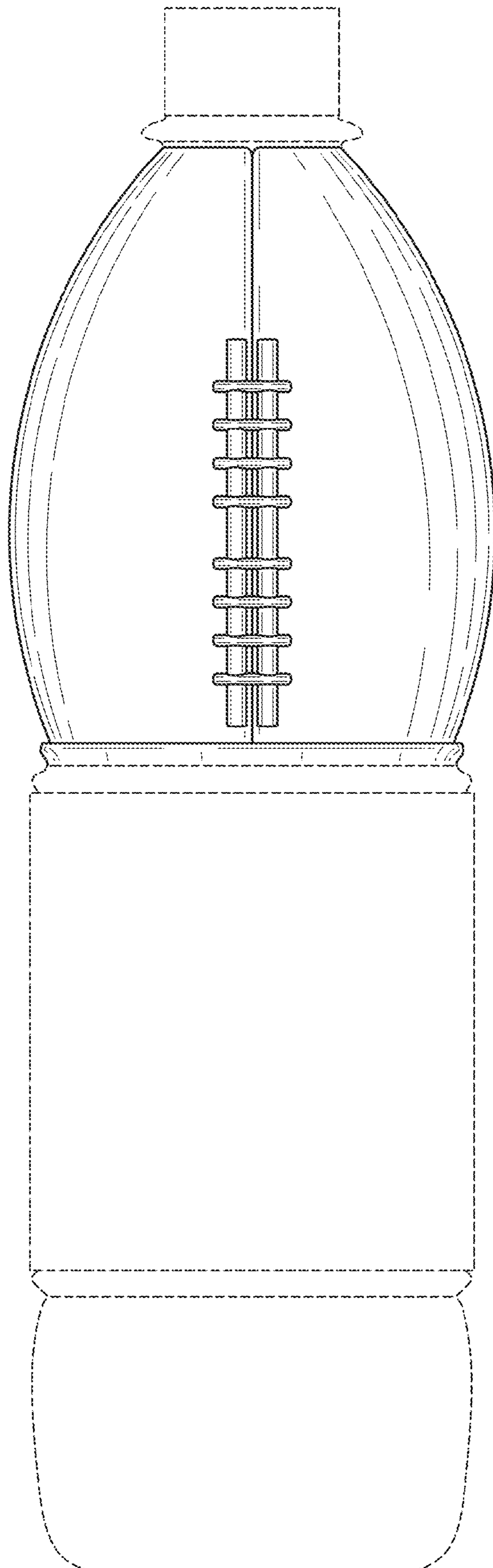

FIG. 3

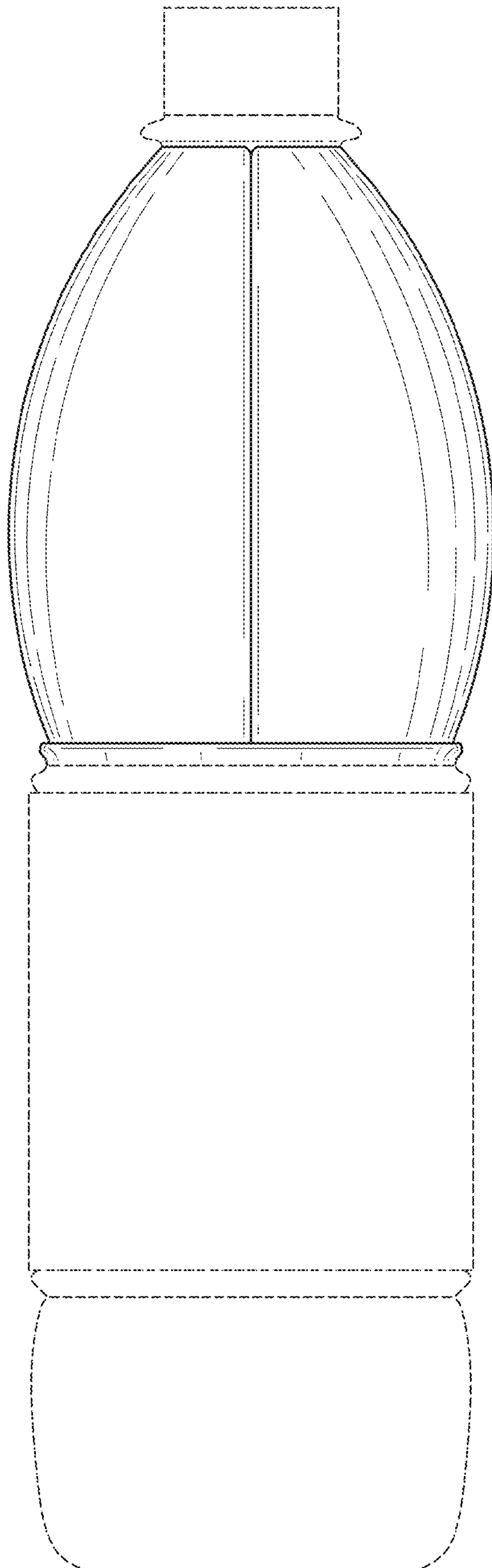

FIG. 4

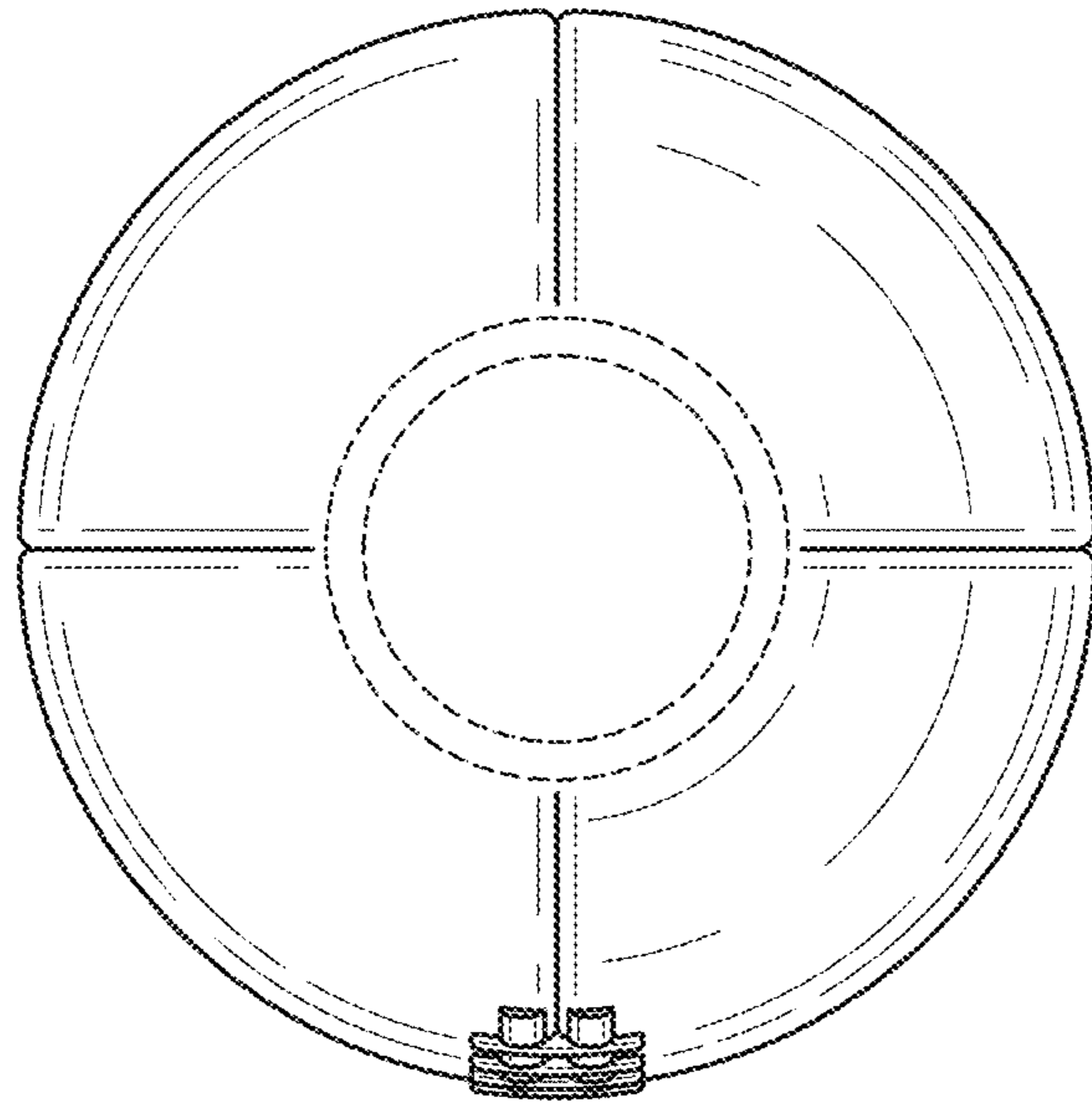

FIG. 5

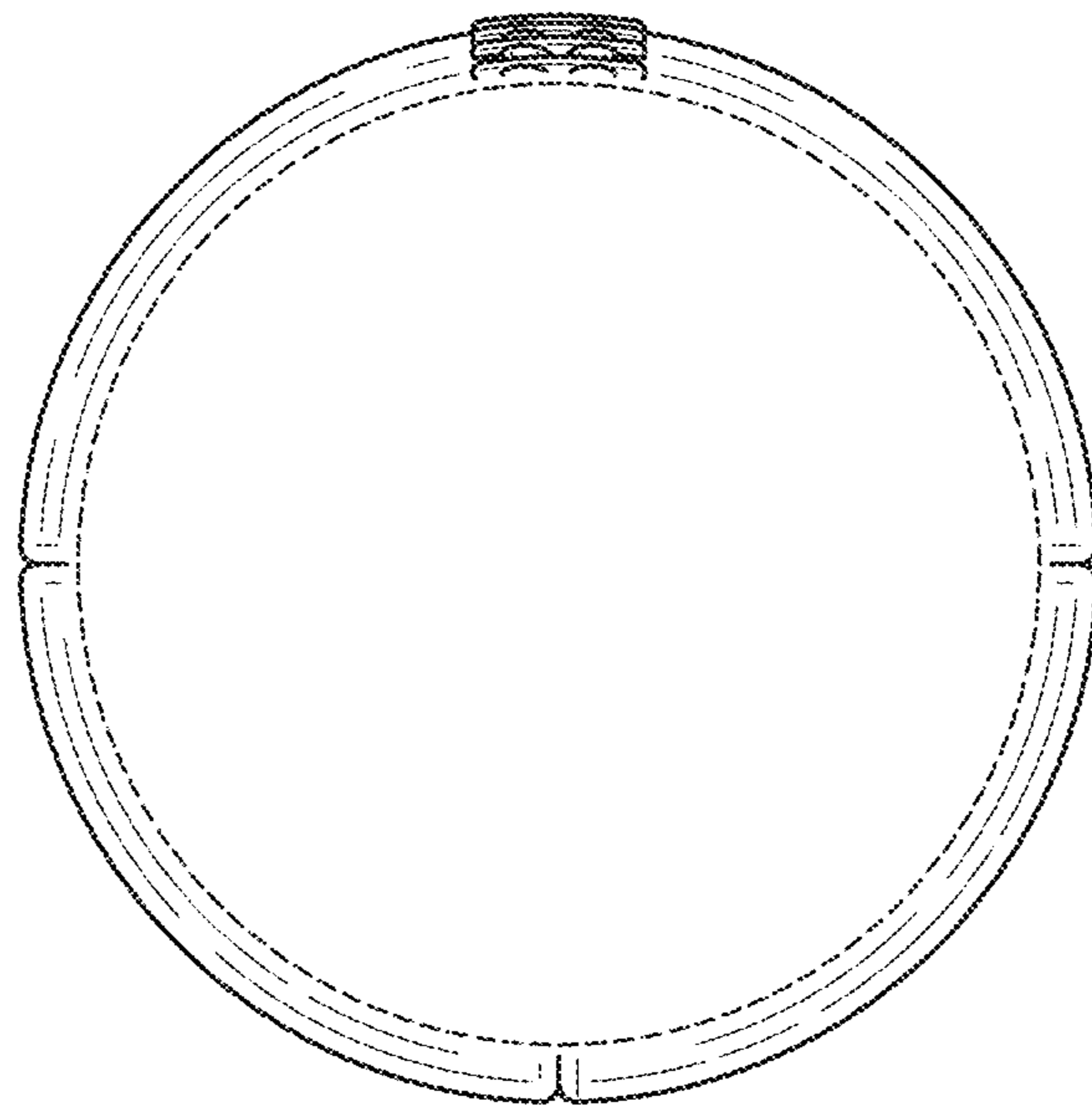

FIG. 6