



US0D1058510S

(12) **United States Design Patent** (10) **Patent No.:** **US D1,058,510 S**
Ewing et al. (45) **Date of Patent:** **** Jan. 21, 2025**

(54) **MODEL VEHICLE BATTERY STRAP**

(71) Applicant: **TRAXXAS, L.P.**, McKinney, TX (US)

(72) Inventors: **Adam Cole Ewing**, McKinney, TX (US); **Otto Karl Allmendinger**, Rowlett, TX (US); **Kent Poteet**, Lucas, TX (US); **Ross Martin**, Roanoke, TX (US); **Trent Collins**, McKinney, TX (US); **Caleb Hix**, McKinney, TX (US)

(73) Assignee: **TRAXXAS, L.P.**, McKinney, TX (US)

(**) Term: **15 Years**

(21) Appl. No.: **29/852,490**

(22) Filed: **Sep. 7, 2022**

(51) **LOC (15) Cl.** **13-02**

(52) **U.S. Cl.**
USPC **D13/119; D21/561**

(58) **Field of Classification Search**
USPC **D13/118, 119, 184, 199; D21/561; D11/200, 201; D3/228**
CPC **B65G 6/12**
See application file for complete search history.

(56) **References Cited**

U.S. PATENT DOCUMENTS

D342,595 S	*	12/1993	Day	D2/891
D488,924 S	*	4/2004	Miller	D3/228
D873,560 S	*	1/2020	Buschbom	D3/228
D963,996 S	*	9/2022	Kim	D2/891
D963,997 S	*	9/2022	Kim	D2/891
D964,745 S	*	9/2022	Pfotenhauer	D8/382
D987,289 S	*	5/2023	Bulte	D3/226
D1,011,958 S	*	1/2024	Wen	D8/356
D1,044,282 S	*	10/2024	Xing	D3/327

OTHER PUBLICATIONS

amazon.com, Battery Hold Down Bracket, Found at <https://www.amazon.com/Battery-Bracket-Aluminum-Alloy-Accessories/dp/B09TZ365CD/>, Date Available Mar. 18, 2022 (Year: 2022).*
amazon.com, Traxxas TRX-4M Battery Cover, Found at <https://www.amazon.co.uk/Traxxas-TRX-4M-Battery-Cover/dp/B0C4TNJNVZ>, Date Available Jun. 22, 2023 (Year: 2023).*
Traxxas Battery Strap, Found at <https://traxxas.com/products/parts/9727>, Date Available Sep. 13, 2022 (Year: 2022).*

* cited by examiner

Primary Examiner — April Rivas

Assistant Examiner — Robin L Hammonds

(74) *Attorney, Agent, or Firm* — Daryl R. Wright; Greg Carr

(57) **CLAIM**

The ornamental design for a model vehicle battery strap as shown and described.

DESCRIPTION

FIG. 1 is an upper, left, front perspective view of a model vehicle battery strap showing our new design; FIG. 2 is a front elevation view thereof; FIG. 3 is a rear elevation view thereof; FIG. 4 is a left side elevation view thereof; FIG. 5 is a right side elevation view thereof; FIG. 6 is an upper plan view thereof; FIG. 7 is a lower plan view thereof; FIG. 8 is an upper, right, rear perspective view thereof; and, FIG. 9 is a lower, right, rear perspective view of the model vehicle battery strap. In the drawings, the broken lines illustrate portions of the model vehicle battery strap that form no part of the claimed design.

1 Claim, 7 Drawing Sheets

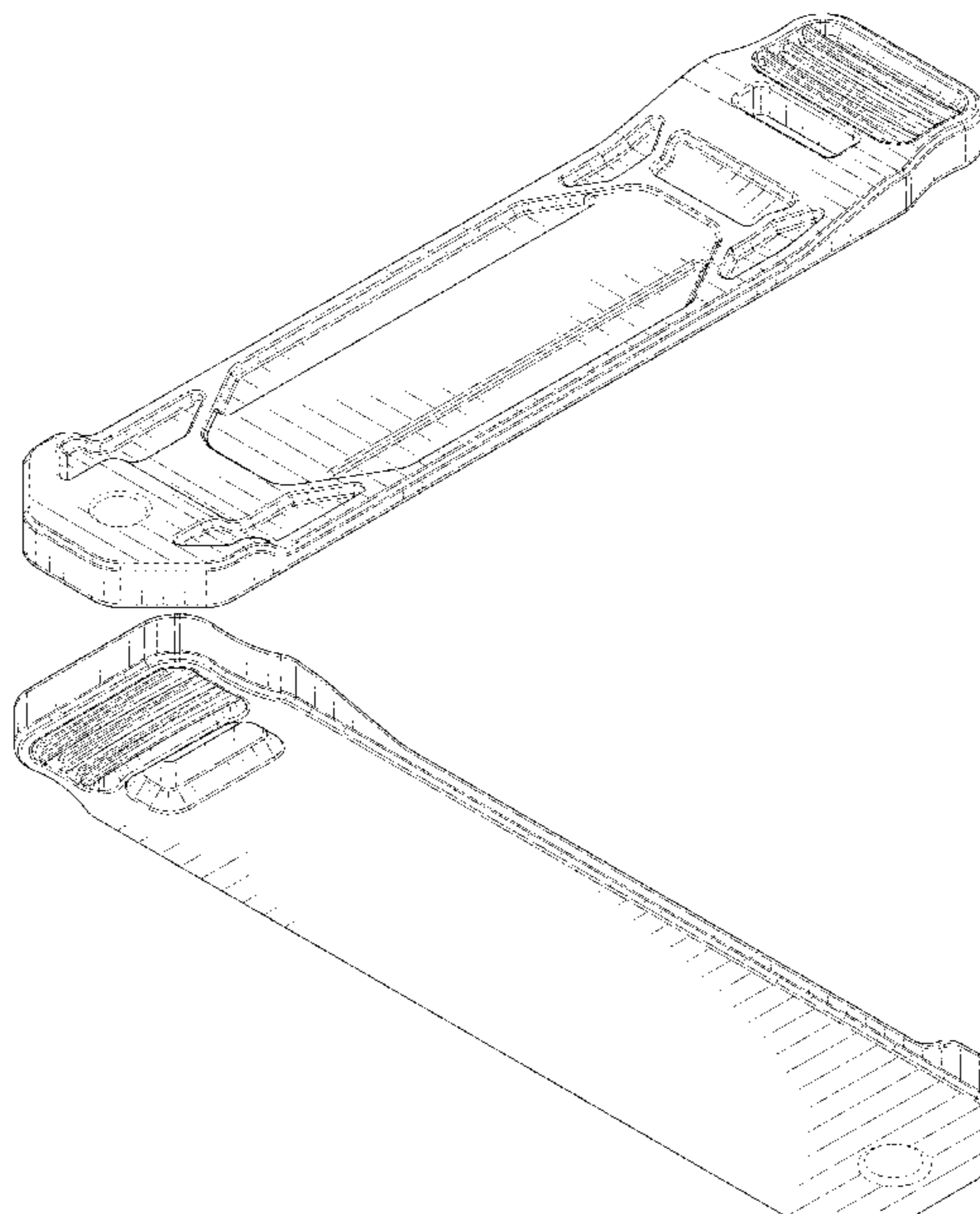

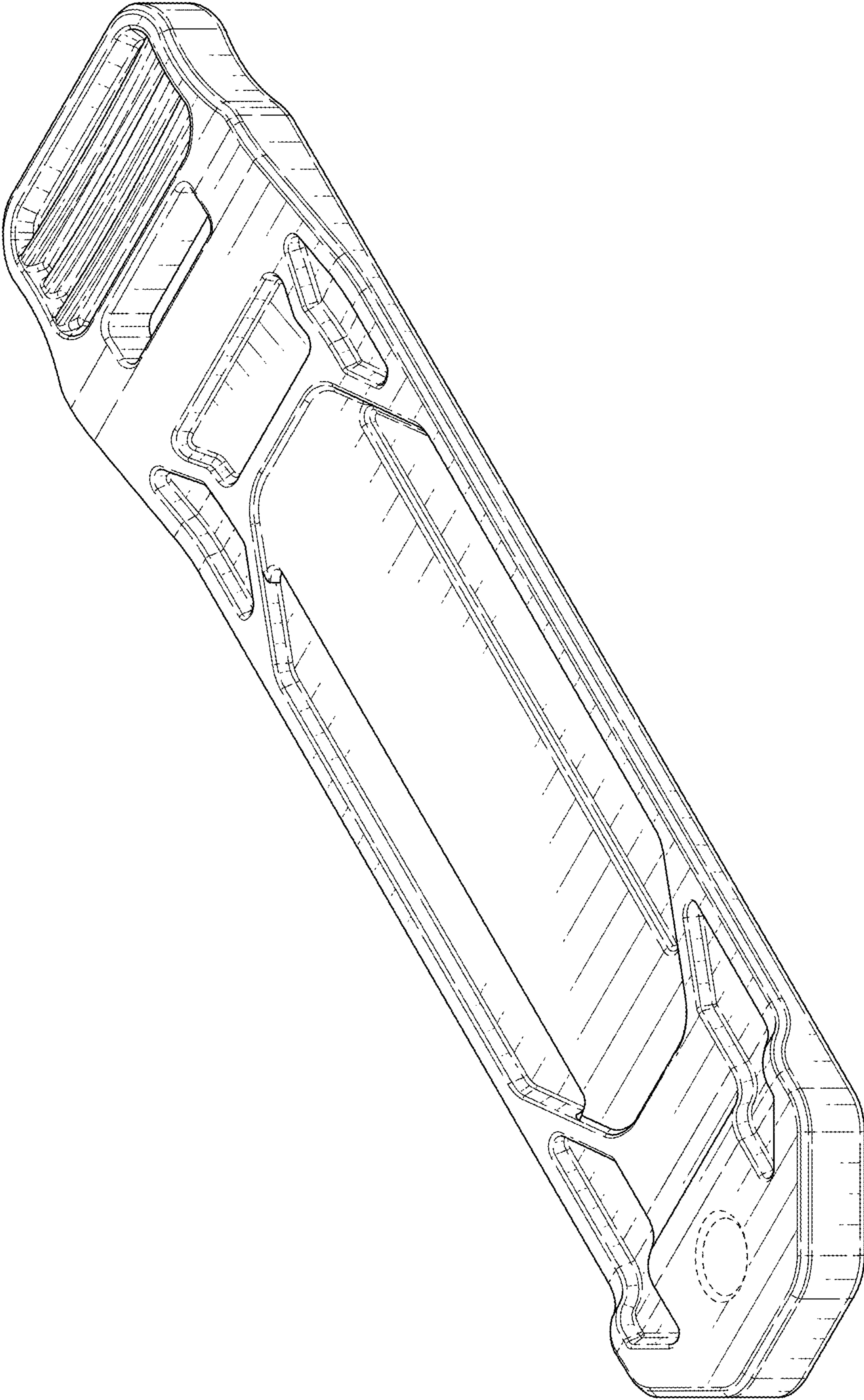

FIG. 1

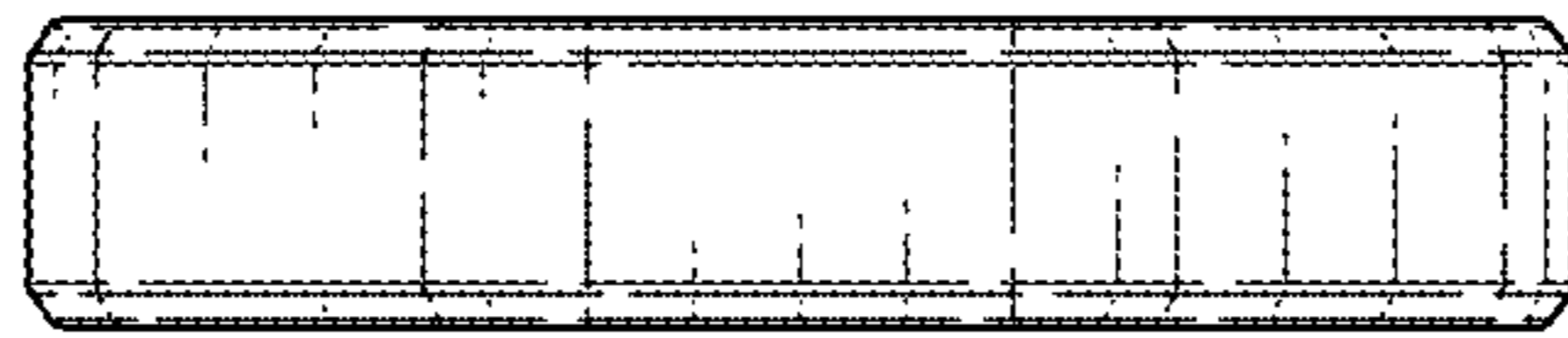

FIG. 2

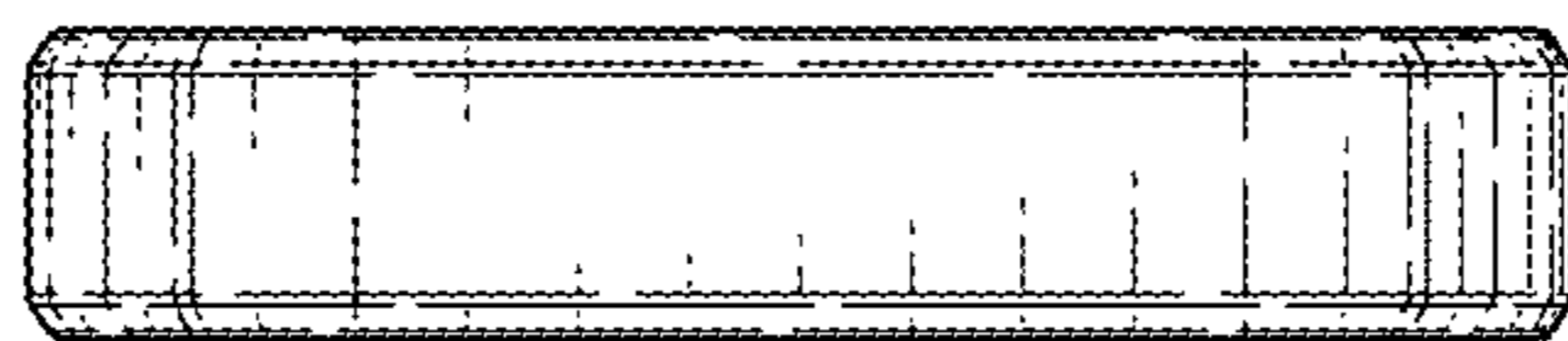

FIG. 3

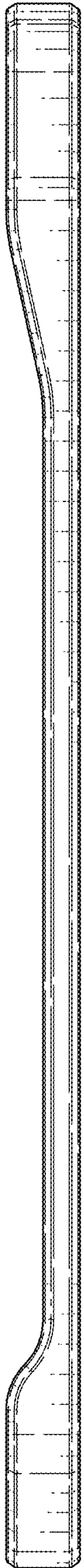

FIG. 4

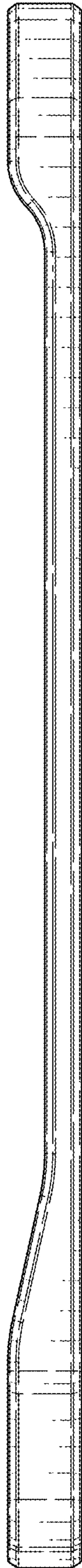

FIG. 5

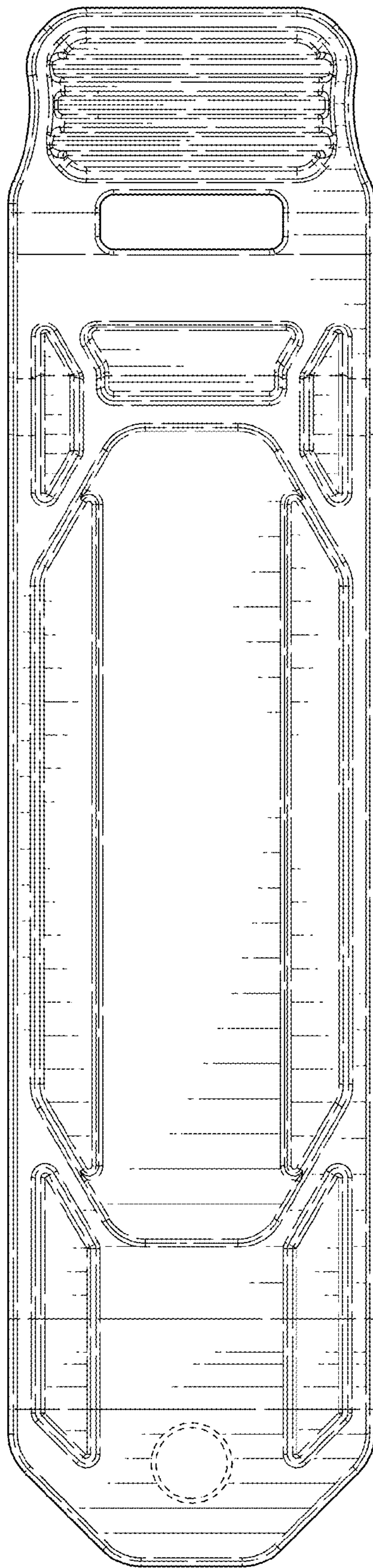

FIG. 6

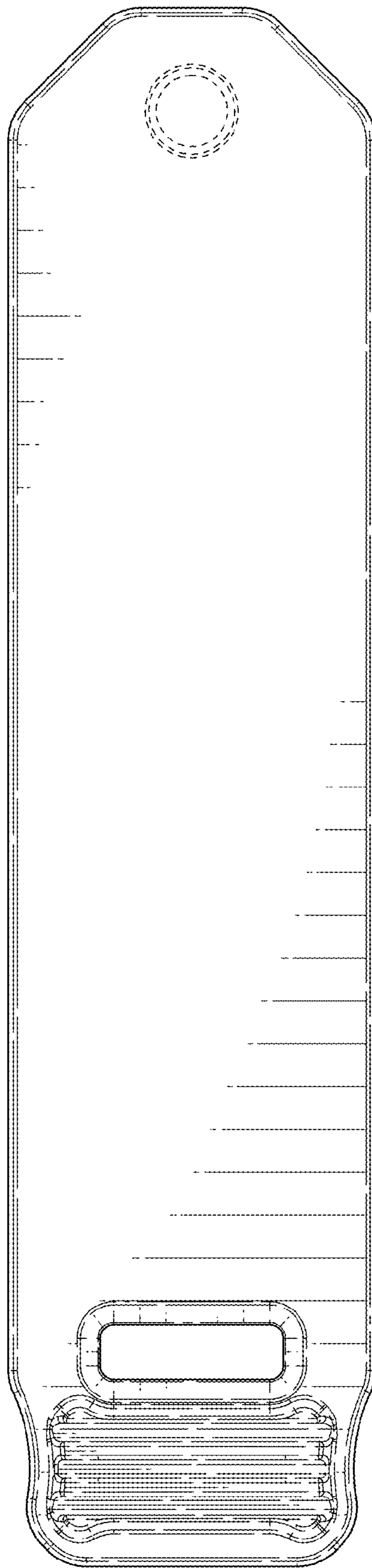

FIG. 7

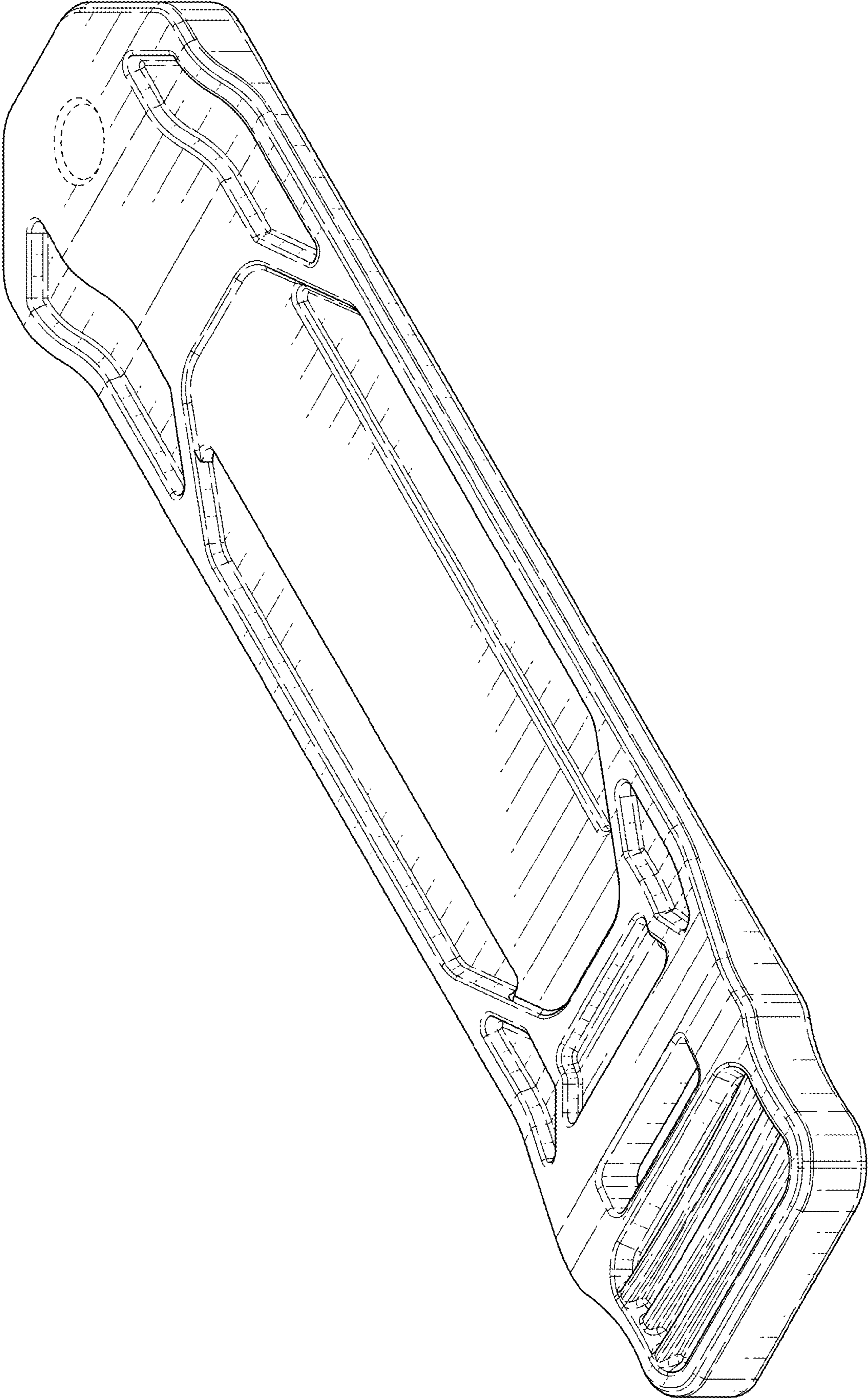

FIG. 8

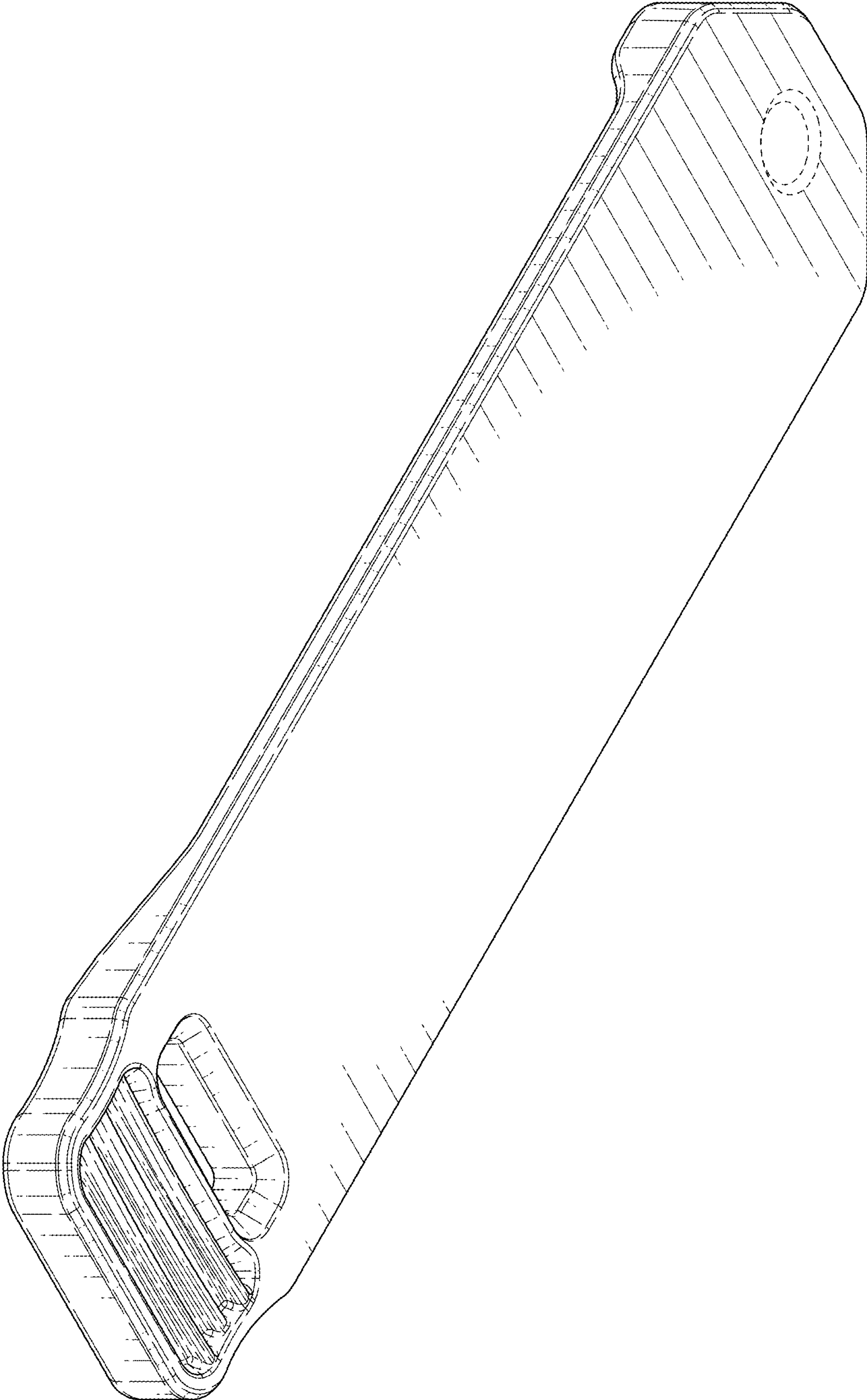

FIG. 9