



US0D1053244S

(12) **United States Design Patent**  
**Gandra et al.**

(10) **Patent No.:** **US D1,053,244 S**

(45) **Date of Patent:** **\*\* Dec. 3, 2024**

(54) **PIN PAD WITH INTEGRATED SCANNER**

(71) Applicant: **7-Eleven, Inc.**, Irving, TX (US)

(72) Inventors: **Srikanth Gandra**, Frisco, TX (US);  
**Mani Suri**, Frisco, TX (US); **Scott Albert**, Dallas, TX (US)

(73) Assignee: **7-ELEVEN, INC.**, Irving, TX (US)

(\*\*) Term: **15 Years**

(21) Appl. No.: **29/822,977**

(22) Filed: **Jan. 13, 2022**

(51) **LOC (14) Cl.** ..... **18-01**

(52) **U.S. Cl.**  
USPC ..... **D18/4.6**

(58) **Field of Classification Search**  
USPC ..... D18/4.1–4.6, 12–12.3, 2, 11, 14, 19–21,  
D18/54, 54.1, 99; D14/371, 373–390,  
D14/420, 436  
CPC ..... G06Q 20/00; G06Q 20/08; G06Q 20/20;  
G06Q 20/32; G06Q 20/40; G06Q 20/145;  
G06Q 20/204; G06Q 20/401; G06Q  
20/24; G07F 7/025; G07F 7/088; G07F  
7/0873; G07F 7/0886; G07F 7/0893;  
G07F 7/093; H04W 8/22; H04W  
52/0225; H04W 52/0254  
See application file for complete search history.

(56) **References Cited**

**U.S. PATENT DOCUMENTS**

D810,817 S \* 2/2018 Wang ..... D18/4.6  
9,977,511 B2 \* 5/2018 Wang ..... G07F 7/1033

9,990,616 B2 \* 6/2018 Wang ..... G07F 7/0873  
D823,935 S \* 7/2018 Wang ..... D18/4.6  
D915,504 S \* 4/2021 Wang ..... D14/387  
D923,696 S \* 6/2021 Wang ..... D14/455  
D940,787 S \* 1/2022 Luo ..... D18/4.6  
D951,337 S \* 5/2022 Waite ..... D18/12  
D951,338 S \* 5/2022 Waite ..... D18/12

\* cited by examiner

*Primary Examiner* — Michael A. Pratt

(74) *Attorney, Agent, or Firm* — Baker Botts L.L.P.

(57) **CLAIM**

The ornamental design for a pin pad with integrated scanner, as shown and described.

**DESCRIPTION**

FIG. 1 is a front view of a pin pad with integrated scanner thereof;  
FIG. 2 is a rear view thereof;  
FIG. 3 is a left side view thereof;  
FIG. 4 is a right side view thereof;  
FIG. 5 is a top view thereof;  
FIG. 6 is a bottom view thereof;  
FIG. 7 is a front top right perspective view thereof;  
FIG. 8 is a front top left perspective view thereof;  
FIG. 9 is a front bottom left perspective view thereof;  
FIG. 10 is a front bottom right perspective view thereof;  
FIG. 11 is a rear bottom left perspective view thereof;  
FIG. 12 is a rear bottom right perspective view thereof;  
FIG. 13 is a rear top left perspective view thereof; and,  
FIG. 14 is a rear top right perspective view thereof.  
The broken lines illustrate features of the article that form no part of the claimed design.

**1 Claim, 13 Drawing Sheets**

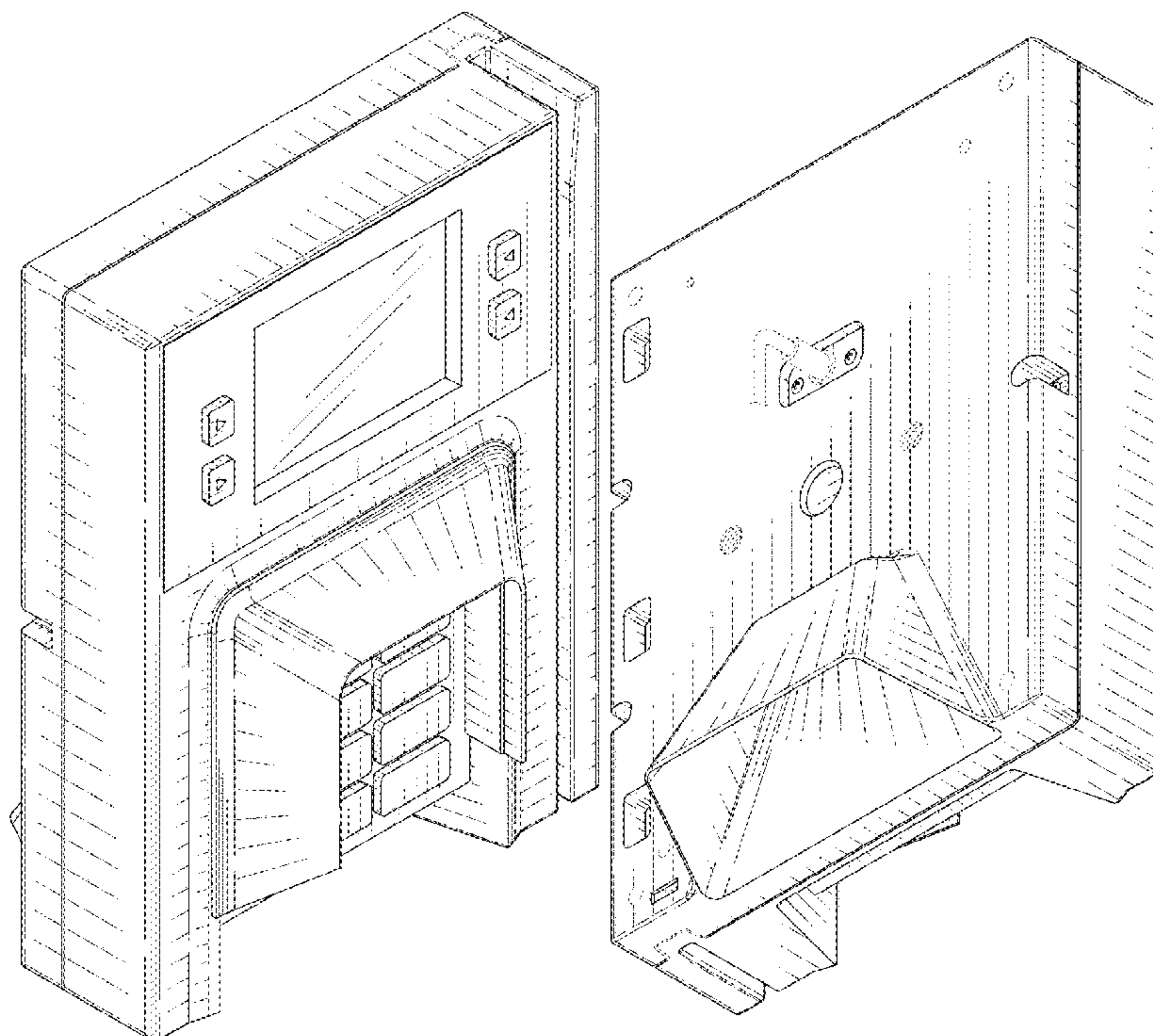

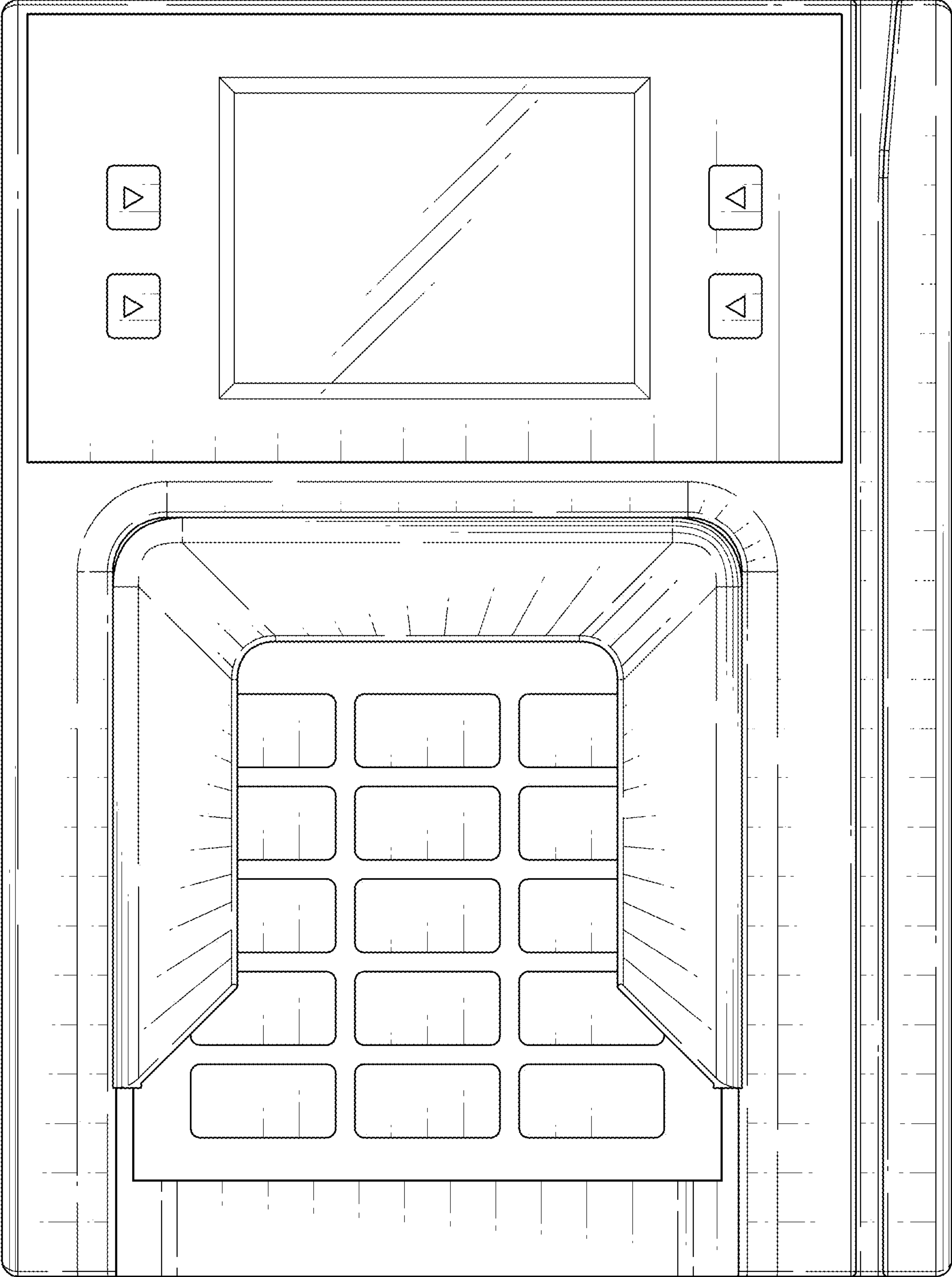

FIG. 1

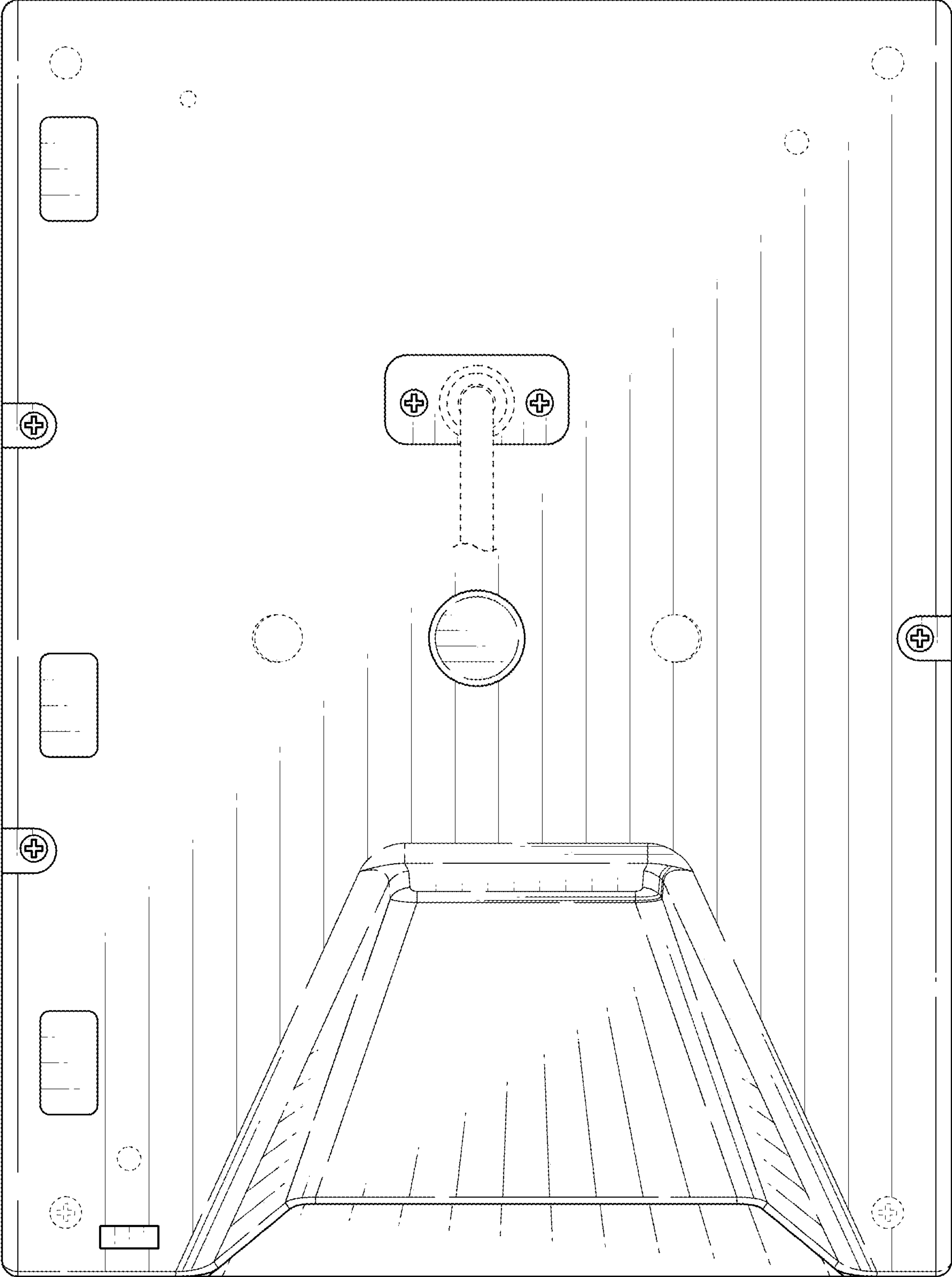

FIG. 2

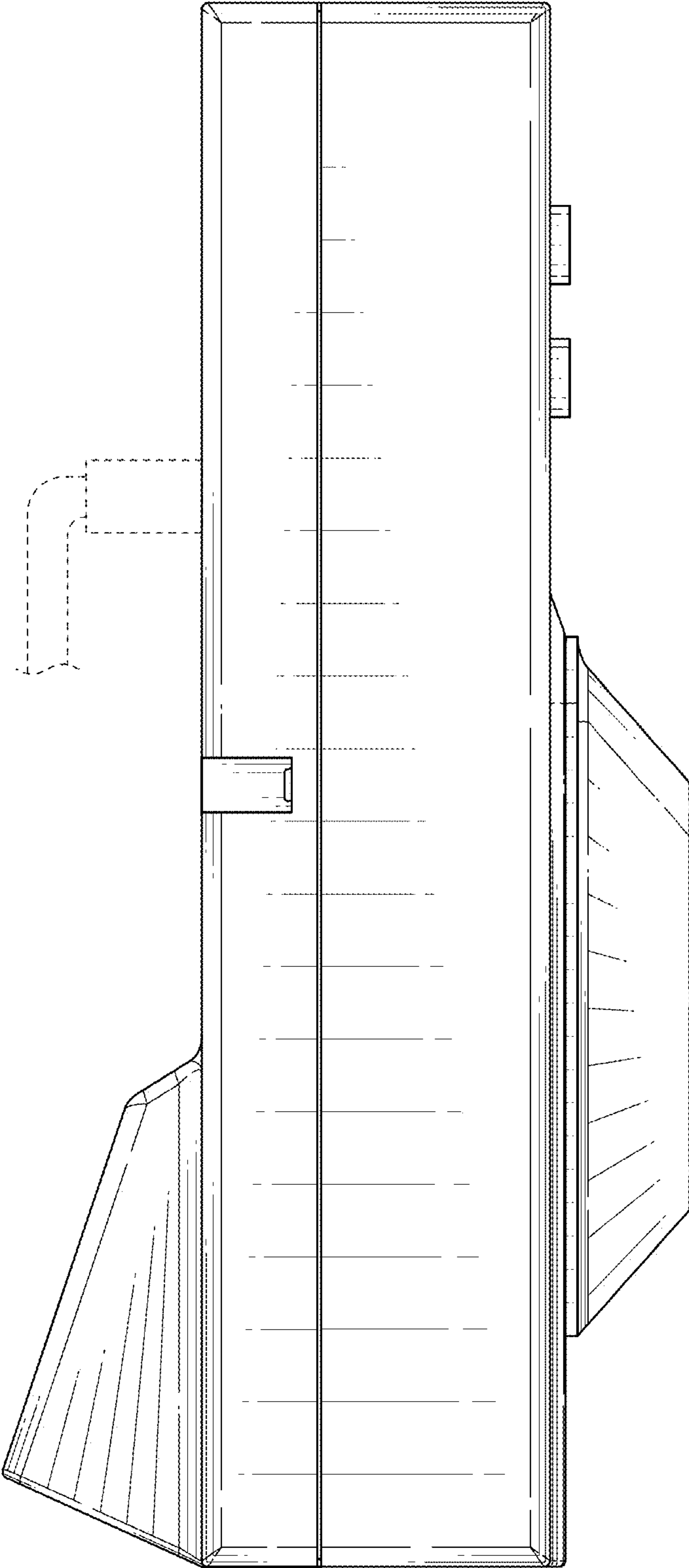

FIG. 3



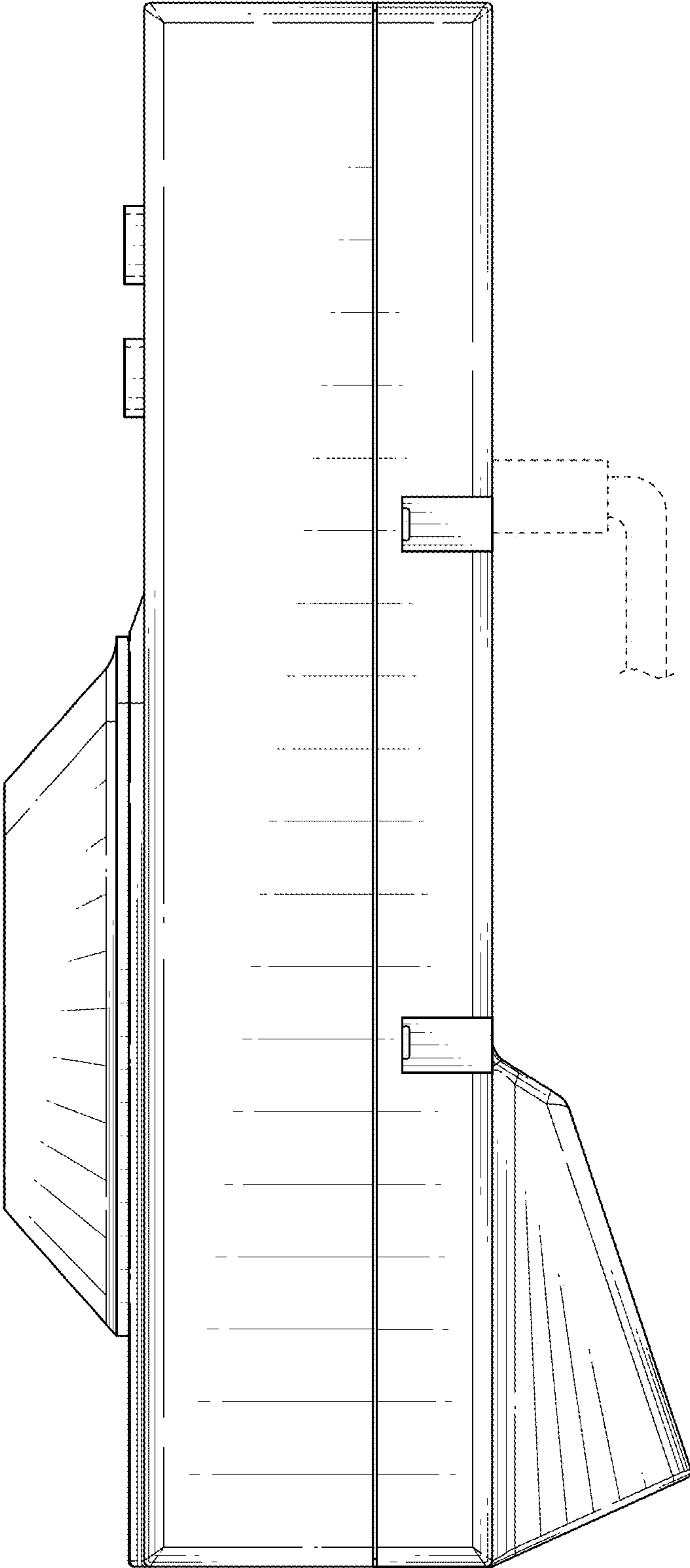

FIG. 4

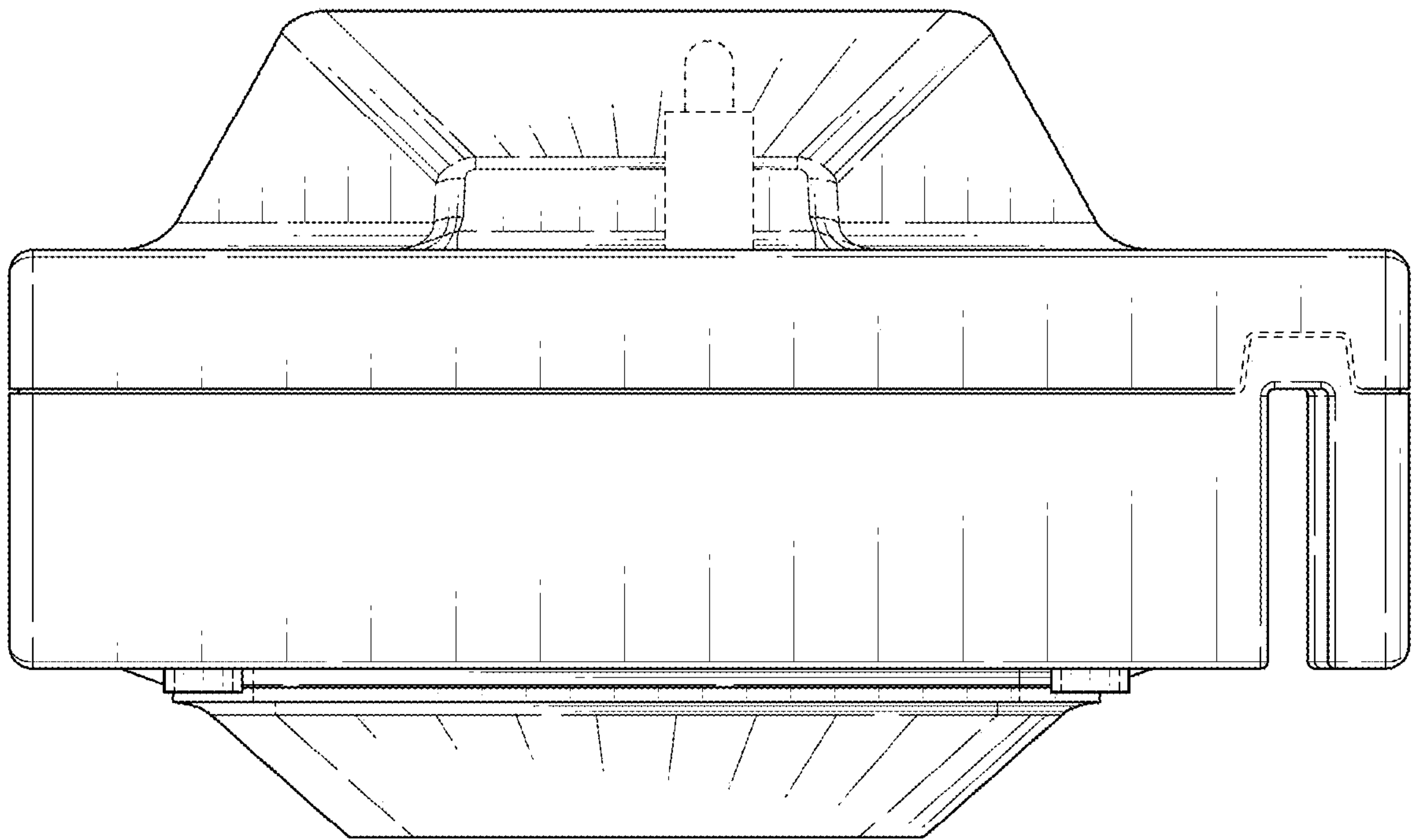

FIG. 5

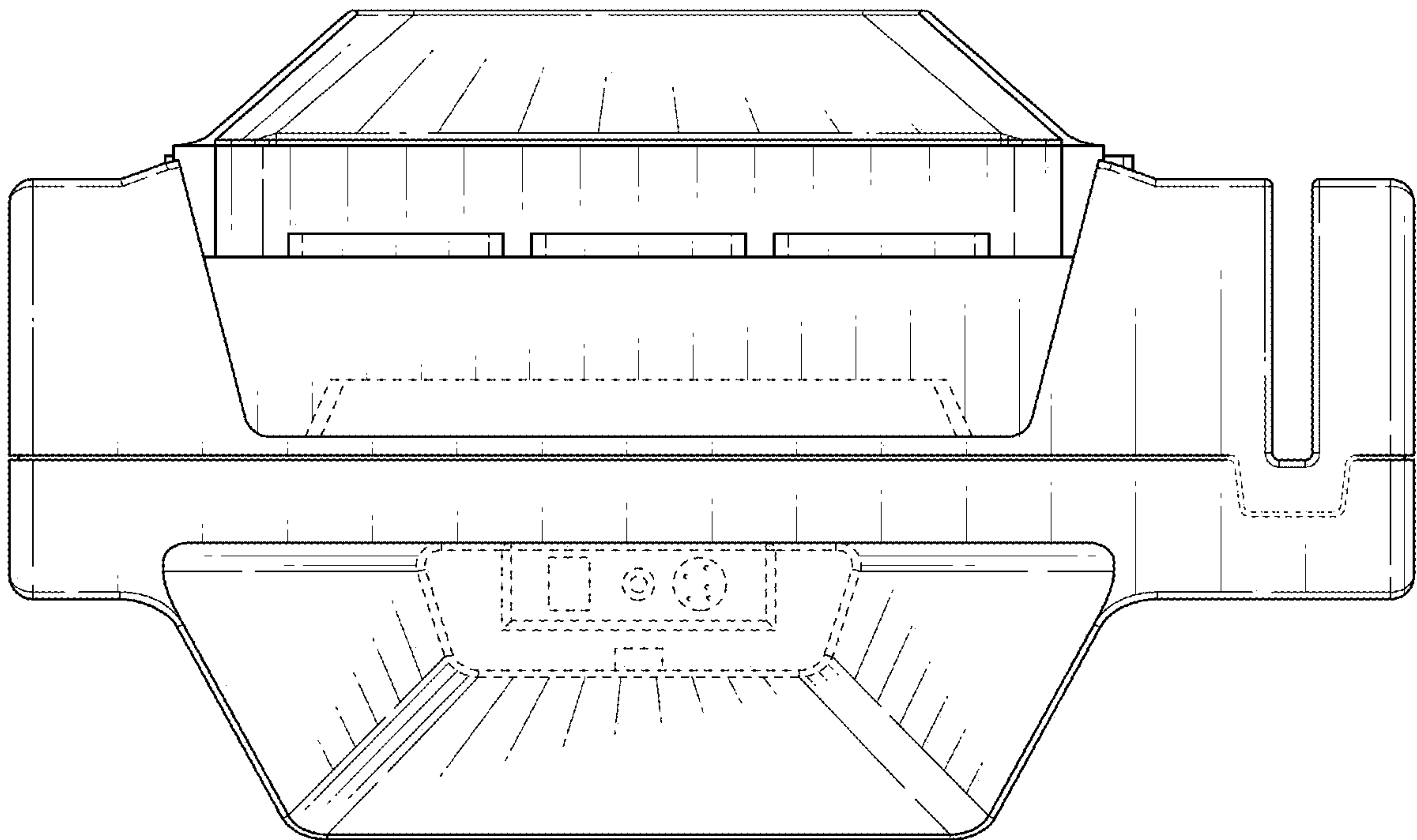

FIG. 6

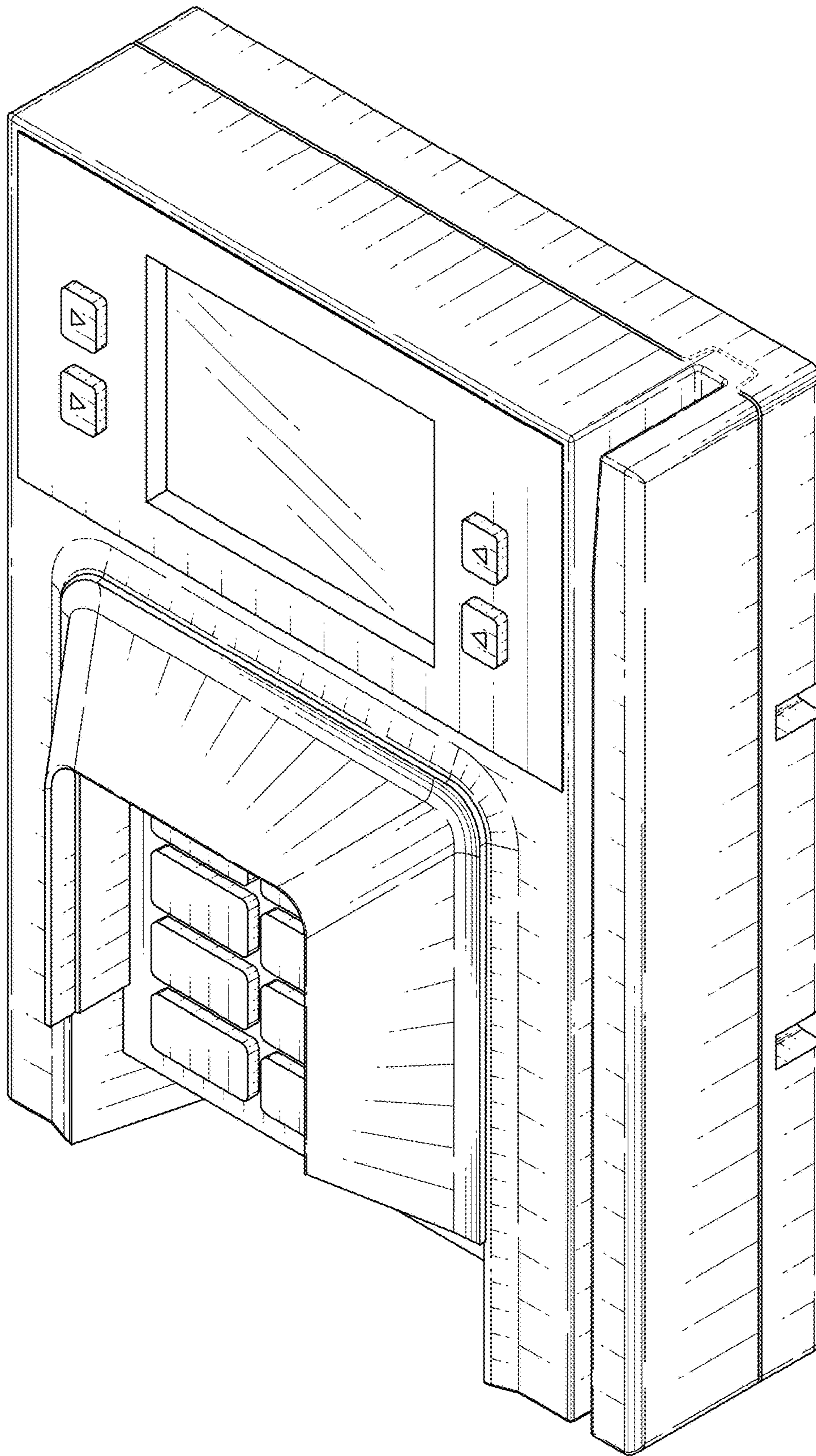

FIG. 7



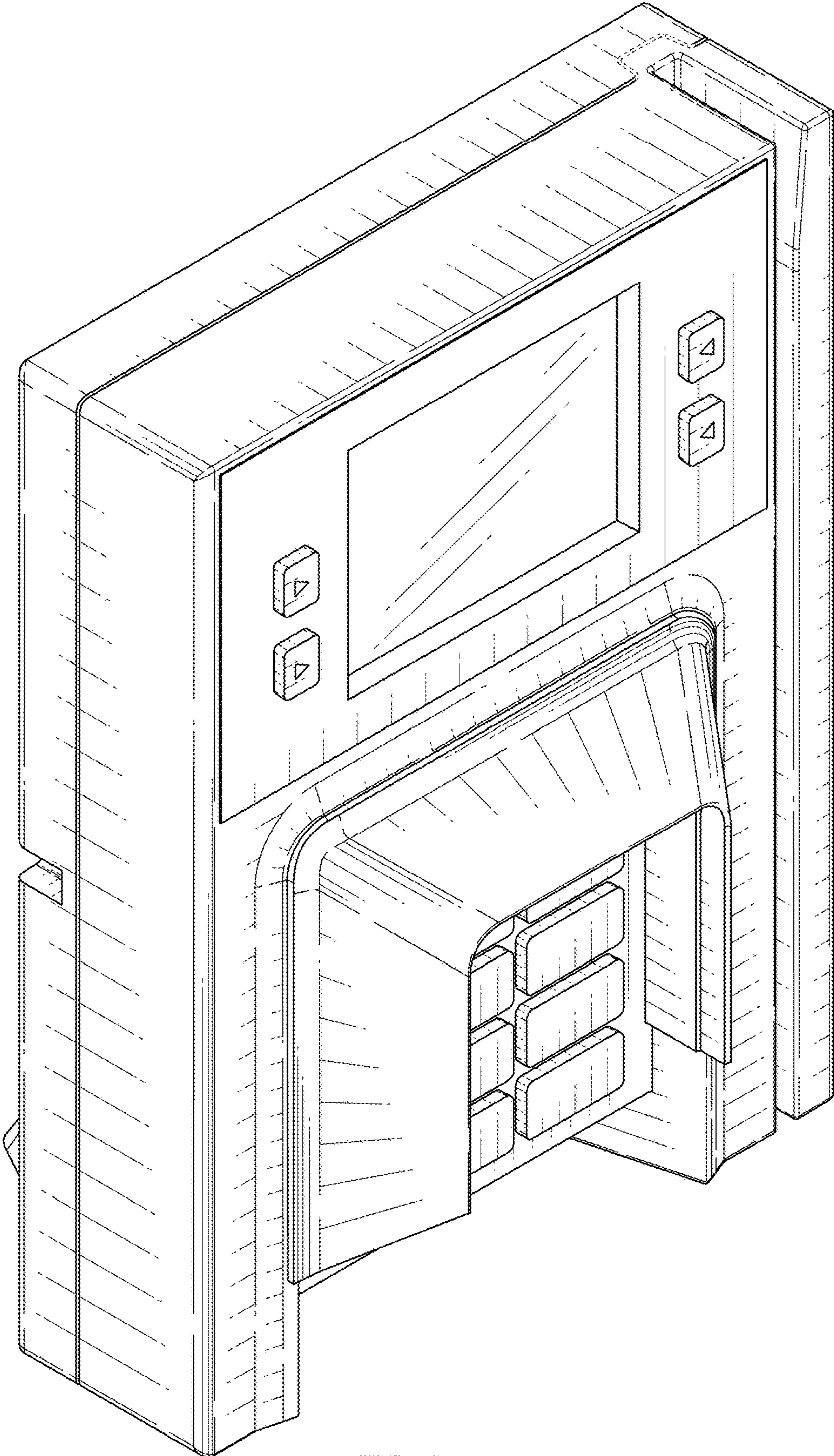

FIG. 8



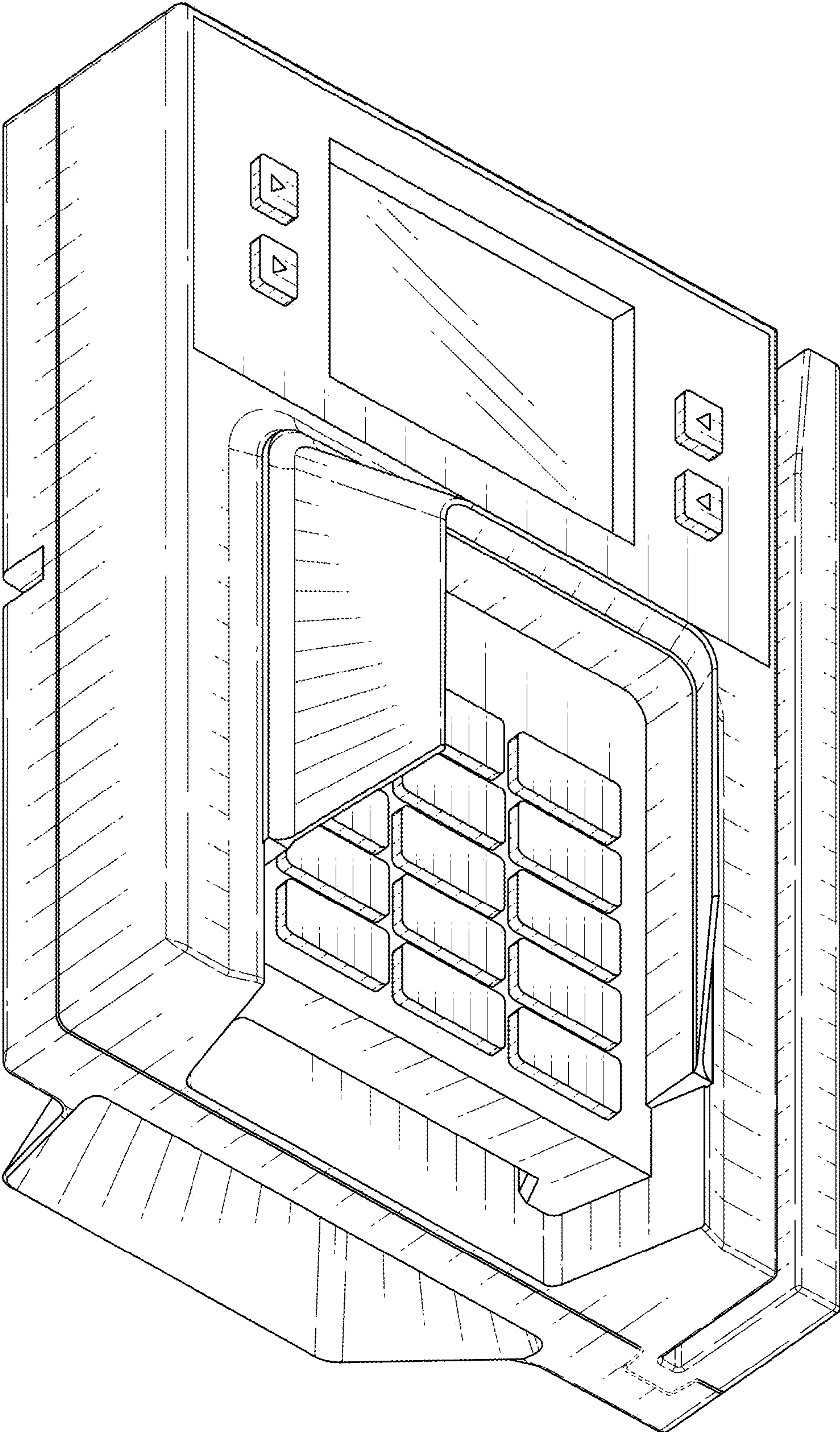

FIG. 9

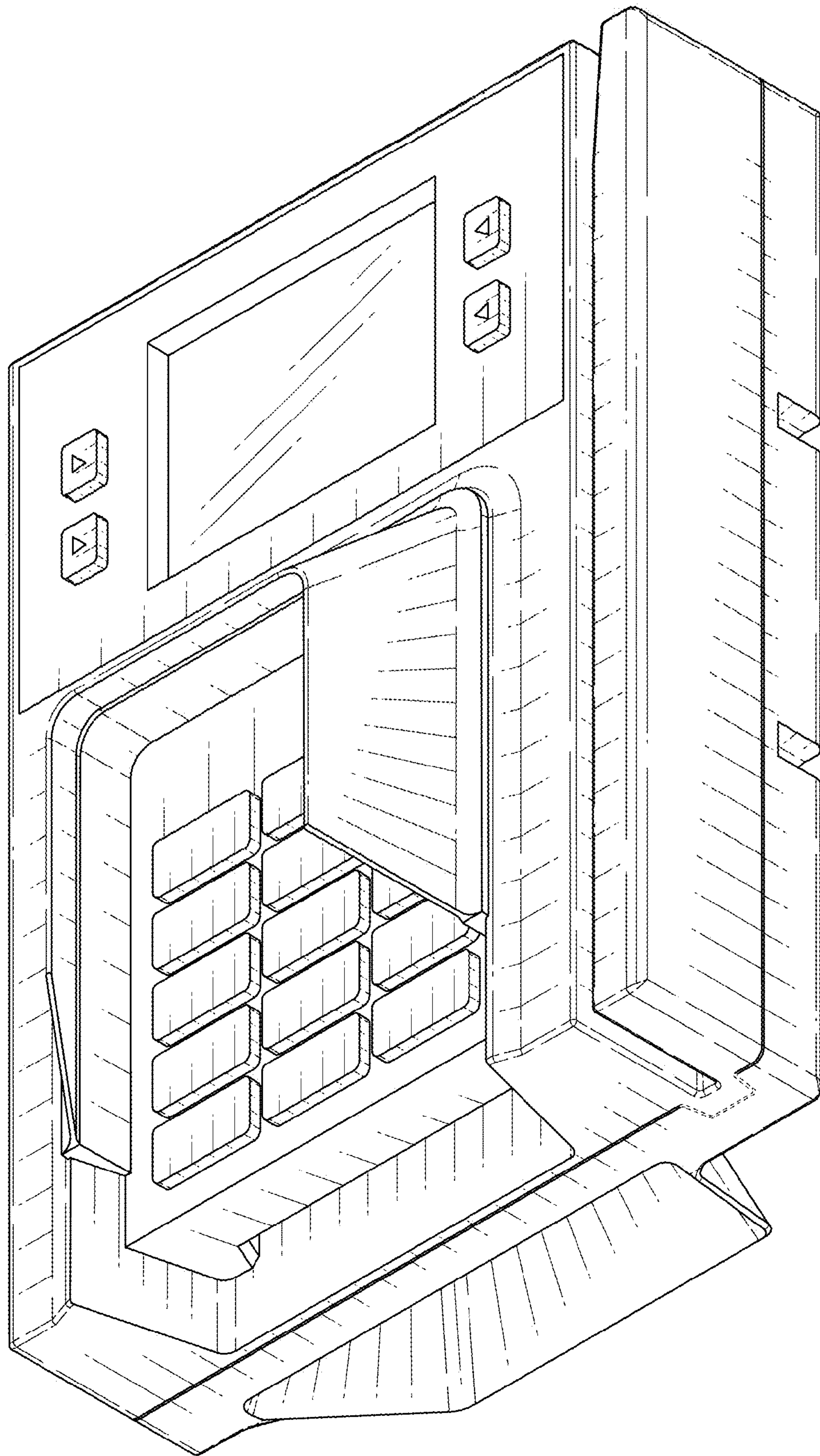

FIG. 10



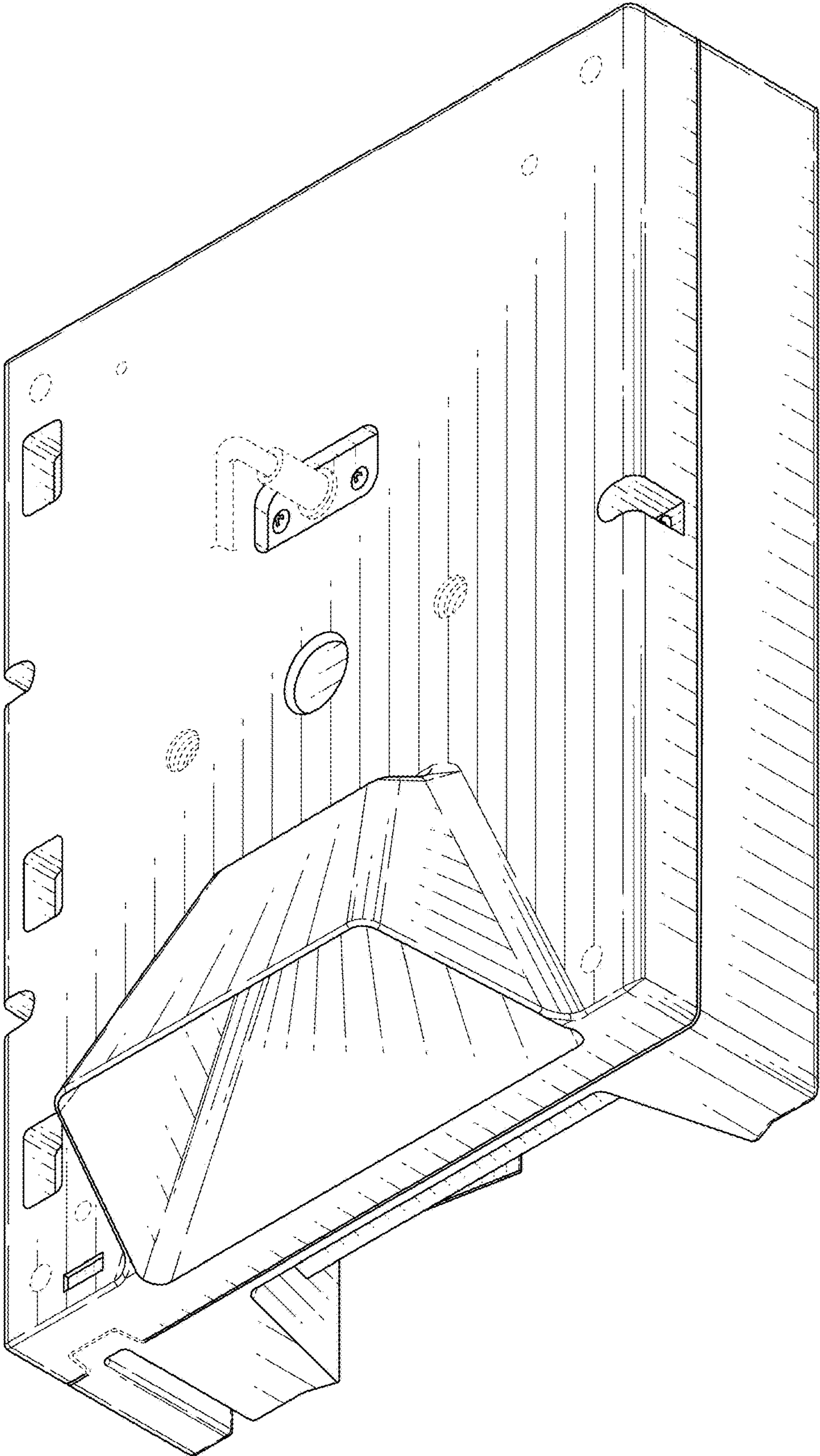

FIG. 11



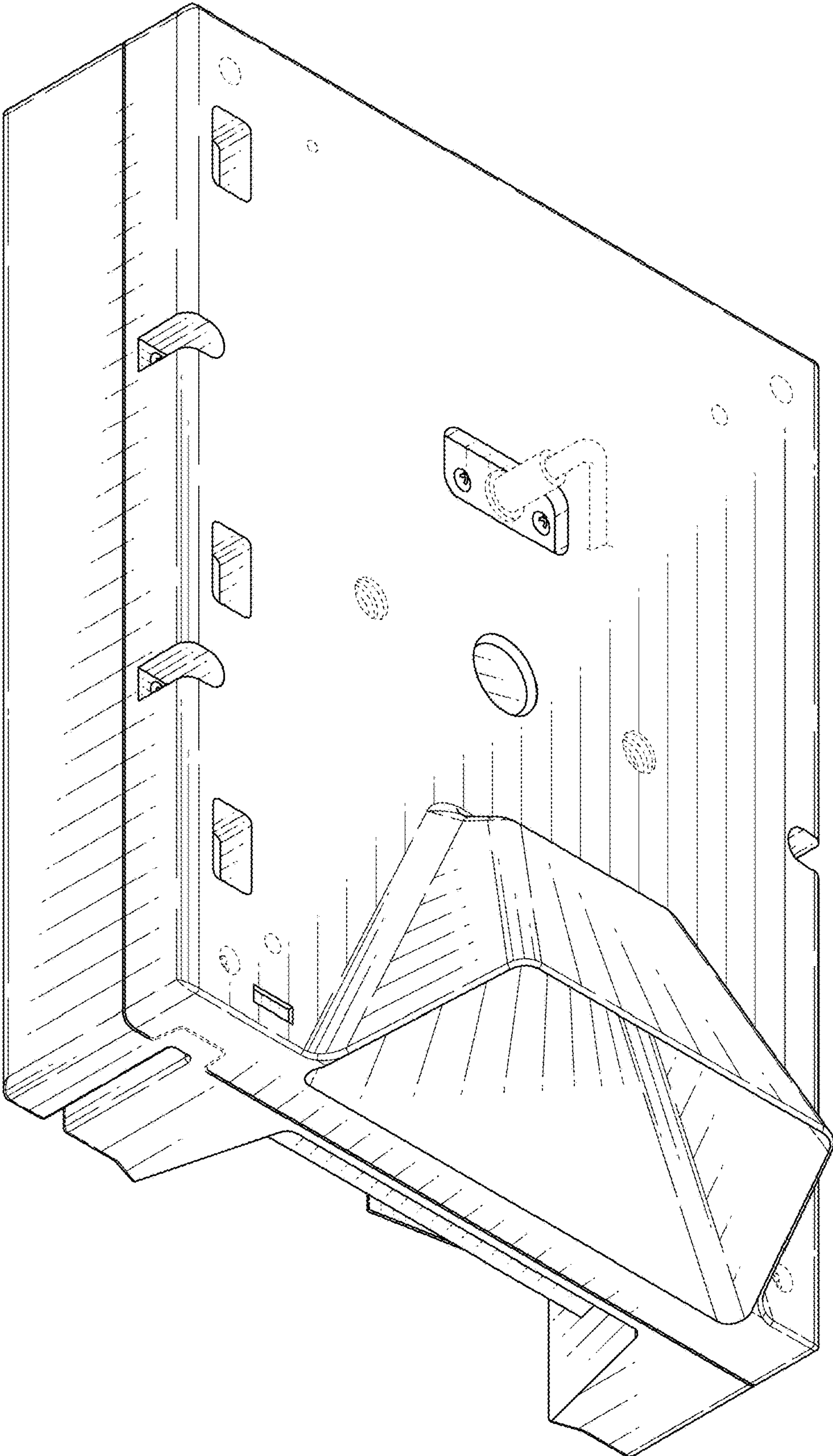

FIG. 12

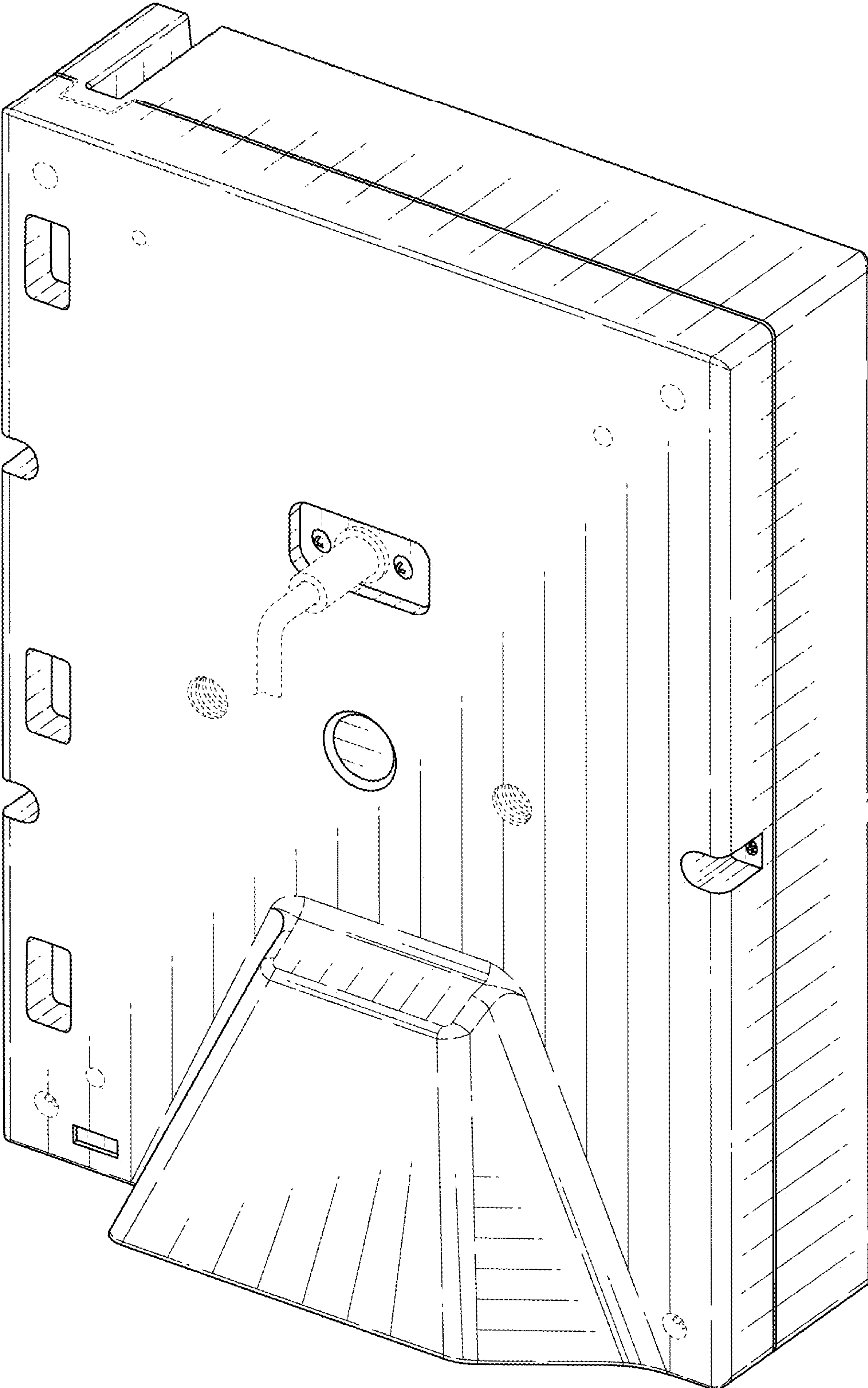

FIG. 13

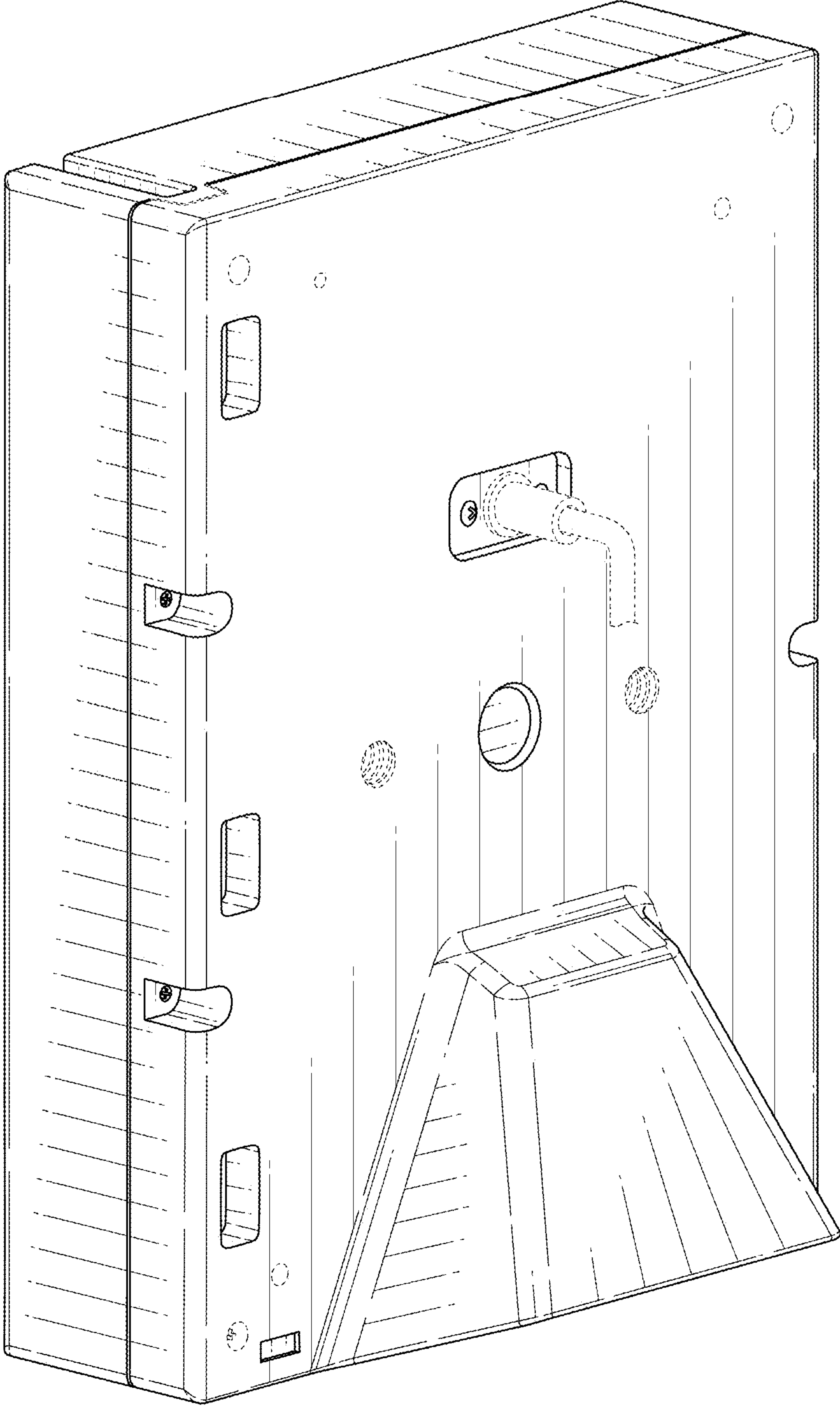

FIG. 14