



US0D1052499S

(12) **United States Design Patent** (10) **Patent No.:** **US D1,052,499 S**  
**Abdeljalil** (45) **Date of Patent:** **\*\* Nov. 26, 2024**

(54) **HOOD ORNAMENT**  
(71) Applicant: **National Truck Parts LLC,**  
Weatherford, TX (US)  
(72) Inventor: **Majdi Abdeljalil,** Weatherford, TX  
(US)  
(73) Assignee: **National Truck Parts LLC,**  
Weatherford, TX (US)

D549,631 S \* 8/2007 Conway ..... D12/197  
D552,505 S \* 10/2007 Vucko ..... D12/190  
D597,910 S \* 8/2009 Hu ..... D12/190  
D597,911 S \* 8/2009 Hu ..... D12/190  
D709,417 S \* 7/2014 Jordan ..... D12/190  
D715,201 S \* 10/2014 Lee ..... D12/190  
D870,007 S \* 12/2019 Rose ..... D12/190  
D955,902 S \* 6/2022 Fix ..... D10/104.1  
D971,077 S \* 11/2022 Wang ..... D21/600  
D1,020,597 S \* 4/2024 Carbis ..... D12/190  
2007/0044207 A1 \* 3/2007 Herman ..... B60R 13/00  
2/239

(\*\*) Term: **15 Years**

(Continued)

(21) Appl. No.: **29/851,302**  
(22) Filed: **Aug. 26, 2022**  
(51) **LOC (14) Cl.** ..... **12-16**  
(52) **U.S. Cl.**  
USPC ..... **D12/197**  
(58) **Field of Classification Search**  
USPC ..... D10/98; D12/114–115, 174, 190–192,  
D12/415; D23/324  
CPC ..... B60R 13/04; B60R 21/045; B60Q 3/10;  
B62D 25/14; G09F 7/00  
See application file for complete search history.

**OTHER PUBLICATIONS**

ebay.com, Shotgun Bunny Hood Ornament SemiTruck, published  
Jul. 12, 2024 [retrieved Jul. 23, 2024]. Retrieved from the  
internet<<https://www.ebay.com/itm/394508394036>> (Year: 2024).\*

(Continued)

*Primary Examiner* — Joseph Kukella  
*Assistant Examiner* — Lavon M. Amerson  
(74) *Attorney, Agent, or Firm* — David W. Carstens;  
Carstens, Allen & Gourley, LLP

(56) **References Cited**

(57) **CLAIM**

The ornamental design for an hood ornament, as shown and  
described.

**U.S. PATENT DOCUMENTS**

**DESCRIPTION**

D50,932 S \* 6/1917 Christensen ..... D11/105  
D80,815 S \* 3/1930 Ranst ..... D12/192  
D160,128 S \* 9/1950 Ross ..... D12/190  
D161,232 S \* 12/1950 Bell ..... D11/116  
D162,863 S \* 4/1951 Moss ..... D26/34  
D172,288 S \* 5/1954 Kerry ..... D12/190  
D179,602 S \* 1/1957 Jackson ..... D11/89  
D255,562 S \* 6/1980 Szperkowski ..... D12/197  
5,002,251 A \* 3/1991 Kranenberg ..... B60R 13/005  
428/31  
5,262,210 A \* 11/1993 Sellers ..... B60R 13/005  
280/727  
D401,202 S \* 11/1998 Washington, Sr. .... D11/160  
D505,898 S \* 6/2005 Marchese ..... D12/400

FIG. 1 is an upper perspective view of an hood ornament of  
the present invention;  
FIG. 2 is a lower perspective view thereof;  
FIG. 3 is a front view thereof;  
FIG. 4 is a back view thereof;  
FIG. 5 is a left side view thereof;  
FIG. 6 is a right side view thereof;  
FIG. 7 is a top view thereof; and,  
FIG. 8 is a bottom view thereof.

**1 Claim, 8 Drawing Sheets**

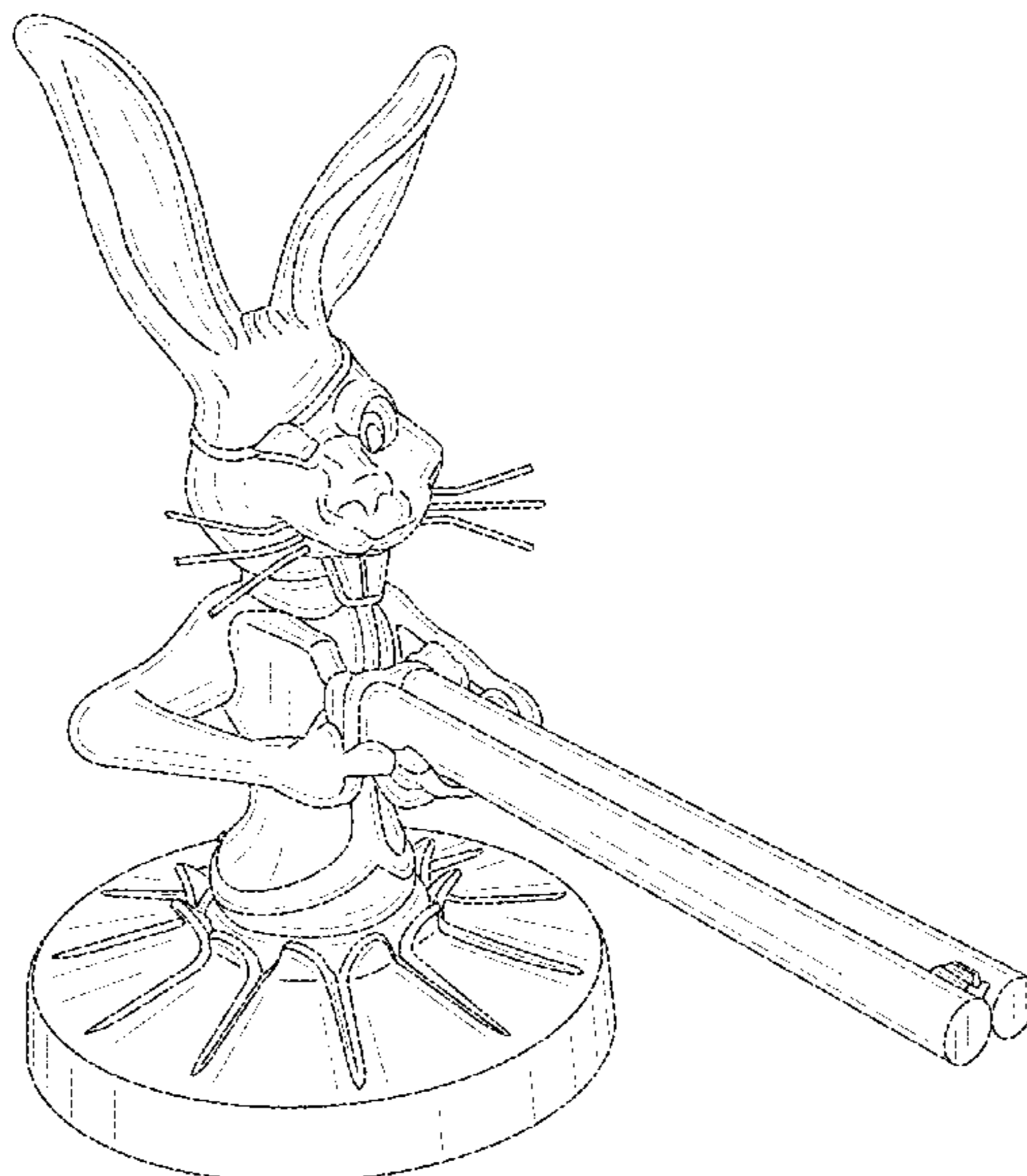

(56)

**References Cited**

U.S. PATENT DOCUMENTS

2013/0189456 A1\* 7/2013 Verbeyst-Hayes .... B60R 13/005  
428/31  
2014/0087096 A1\* 3/2014 Herman ..... B60R 13/005  
428/31  
2019/0161025 A1\* 5/2019 Dunn ..... B60R 13/005

OTHER PUBLICATIONS

Amazon.com, Shotgun Bunny Hood Ornament, publishing May 8, 2024 [retrieved Jul. 23, 2024]. Retrieved from the internet<<https://www.amazon.com/Ornament-Decoration-Exterior-Accessories-Automotive/dp/B0D479BSXS?th=1>> (Year: 2024).\*

\* cited by examiner

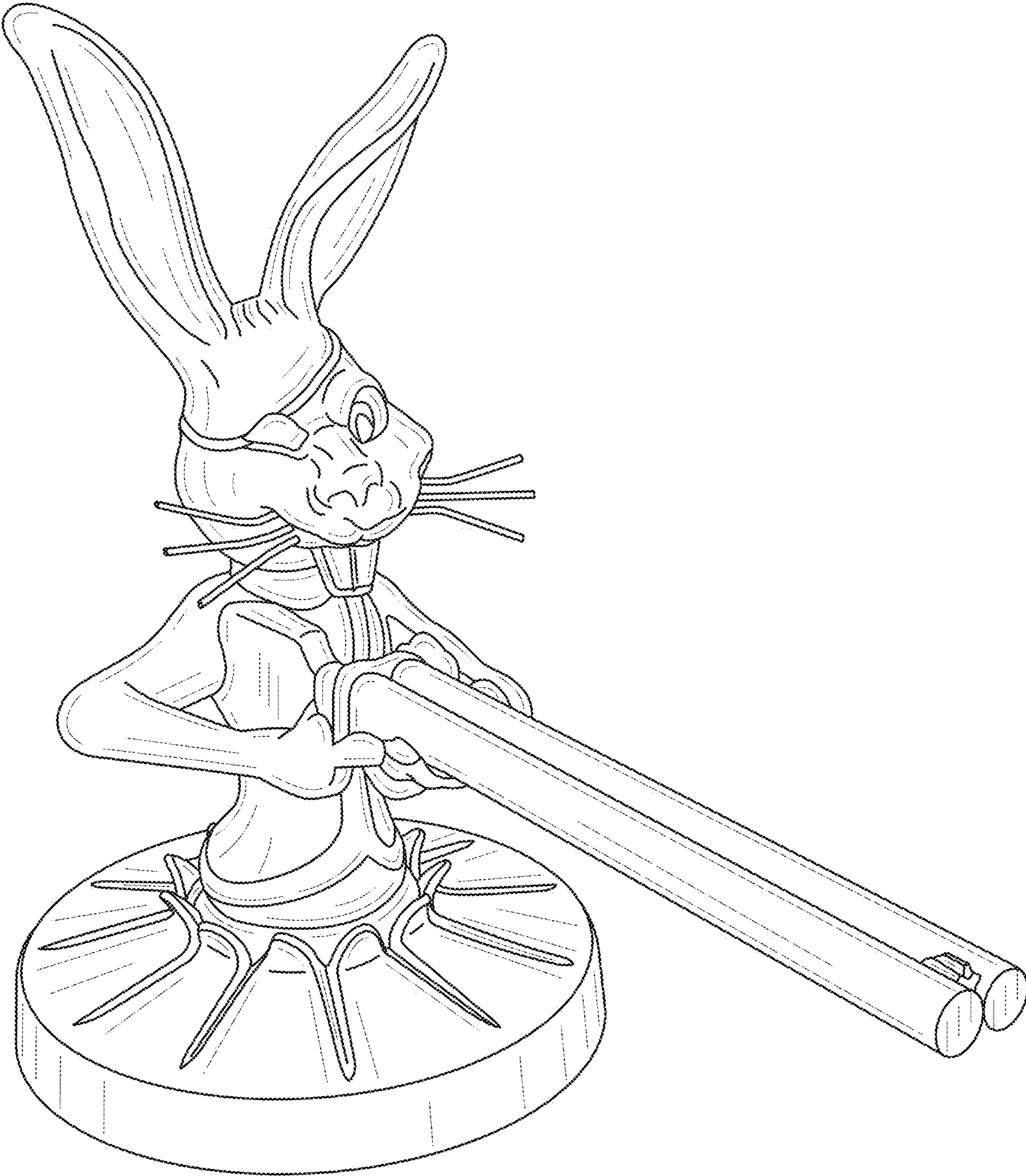

FIG. 1

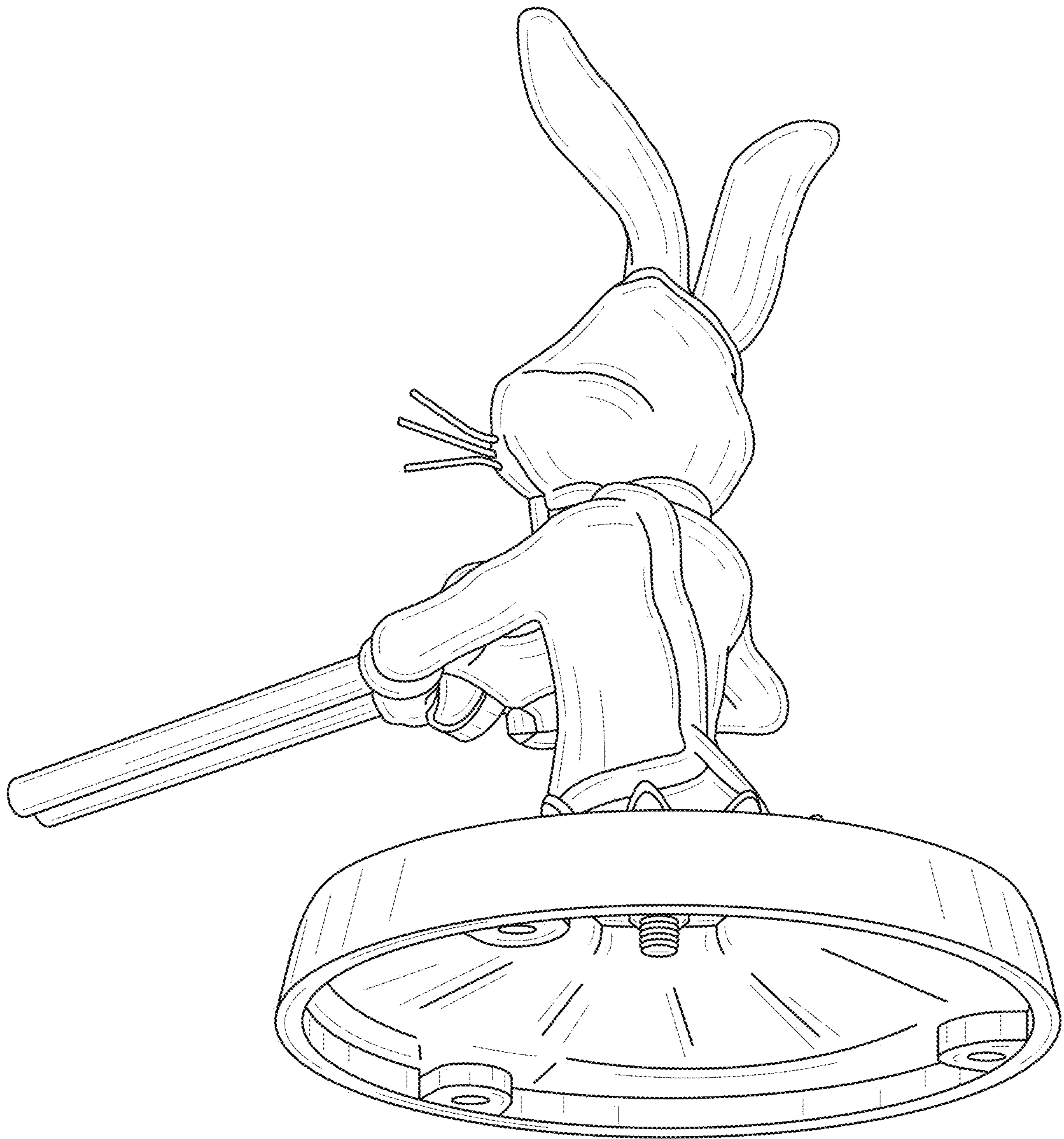
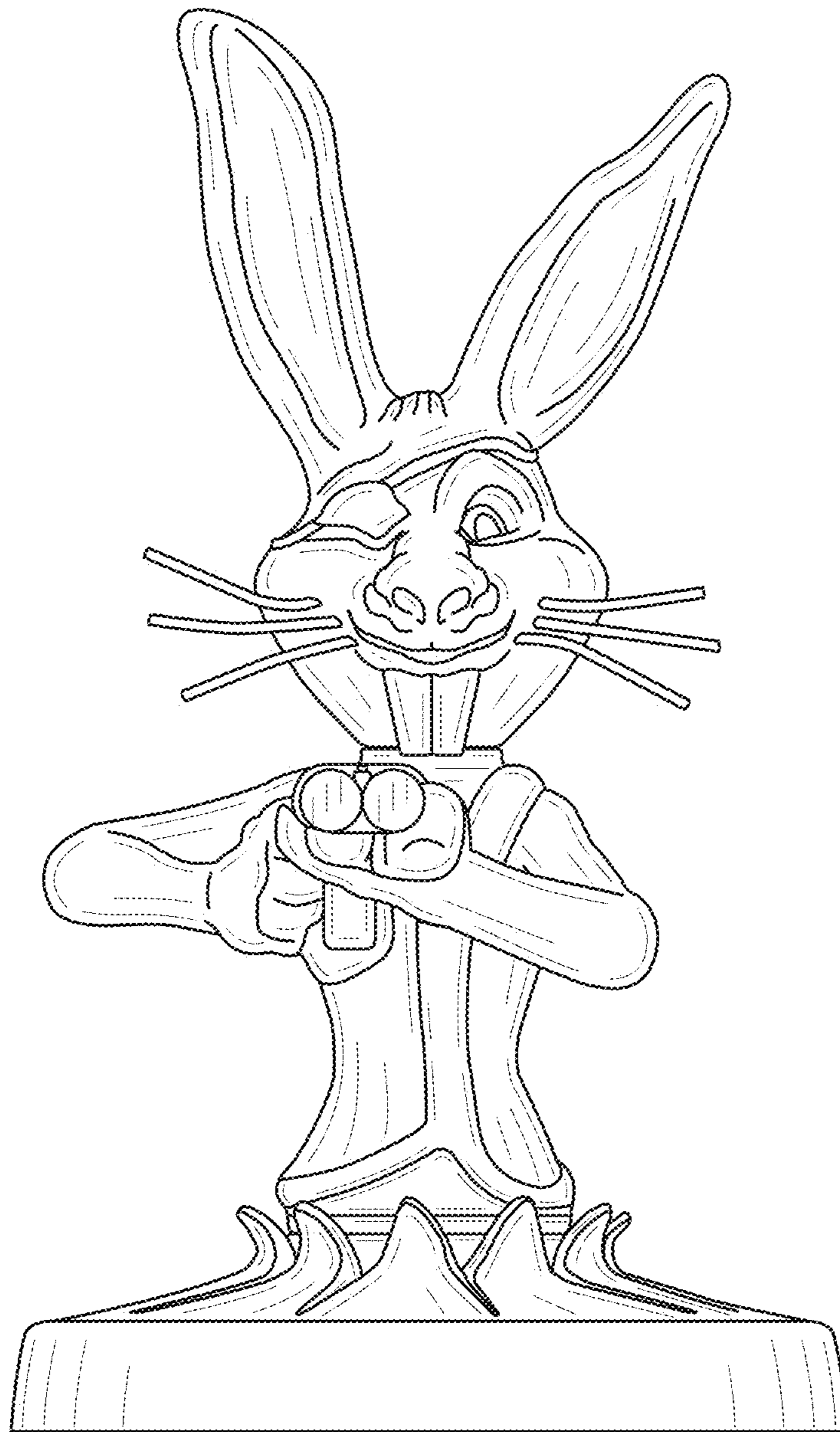
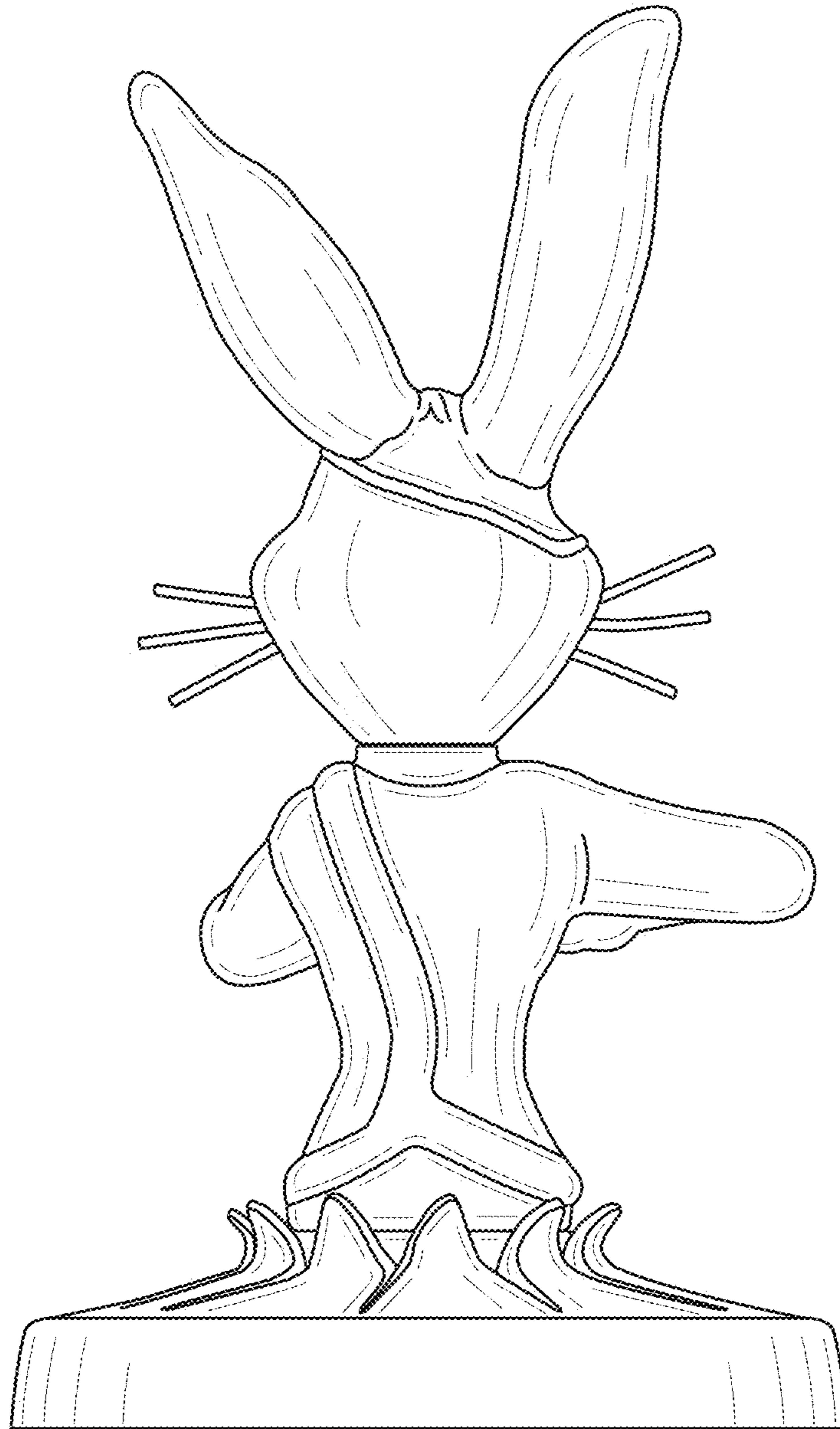

FIG. 2



**FIG. 3**



**FIG. 4**

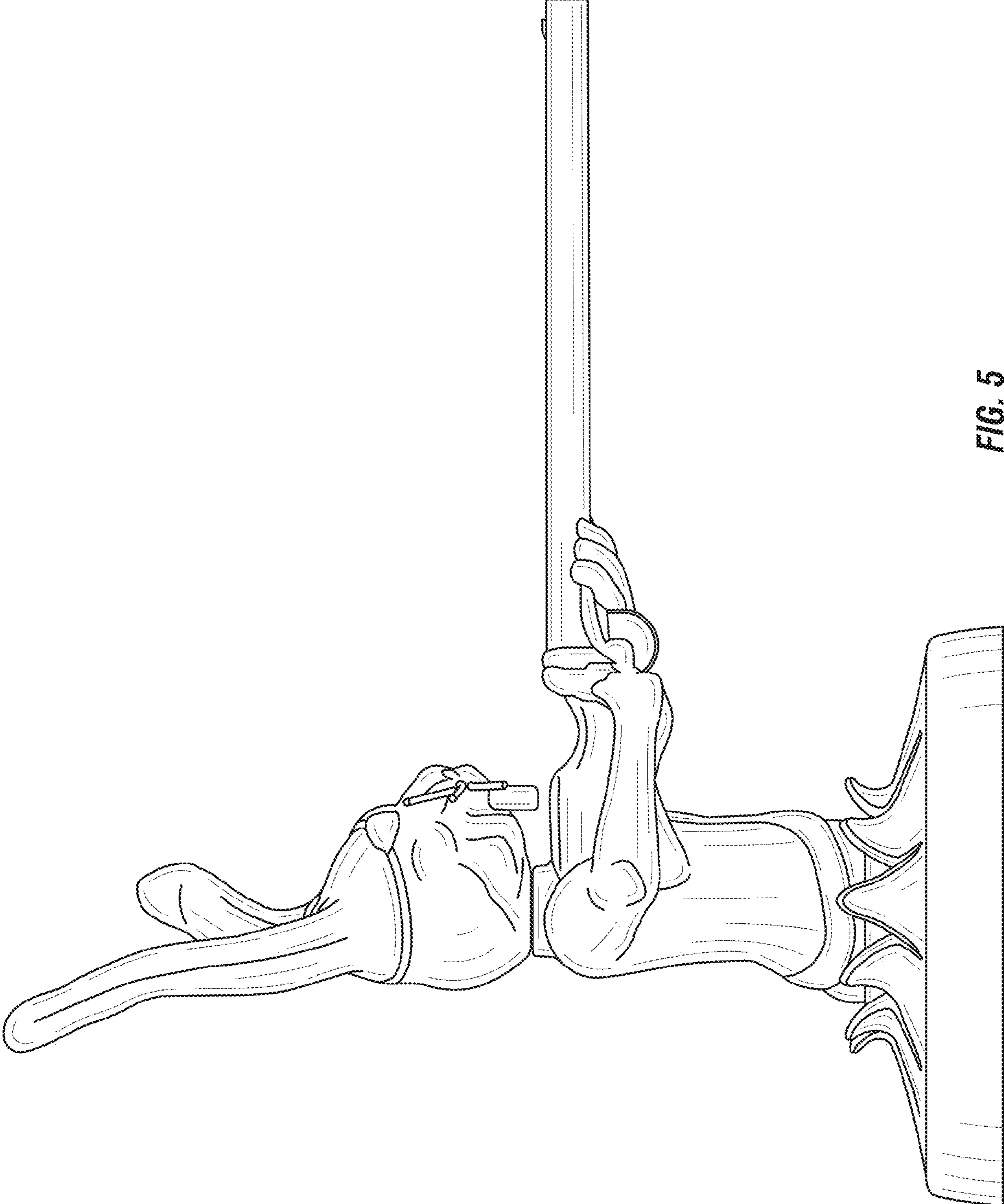

FIG. 5

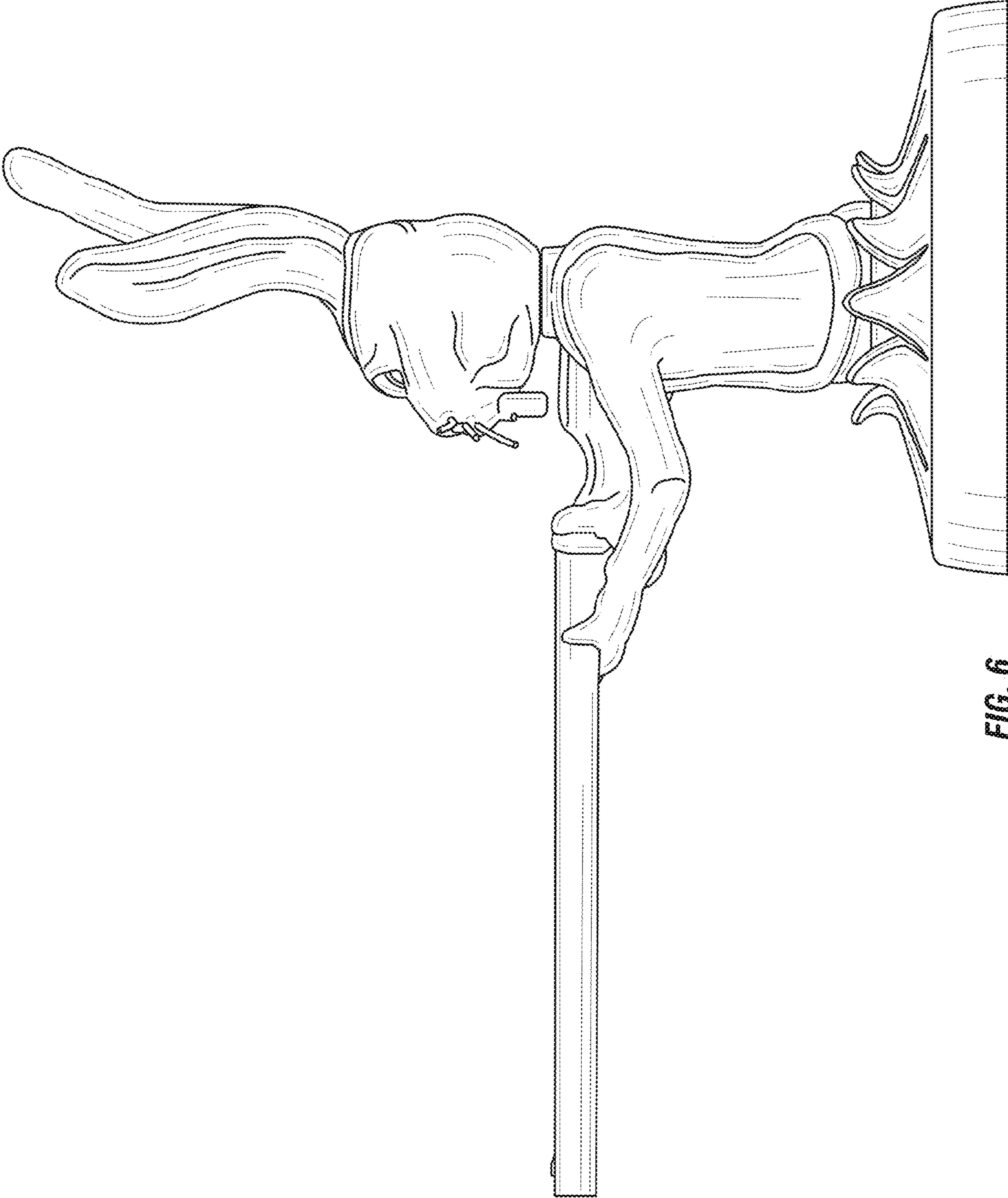

FIG. 6



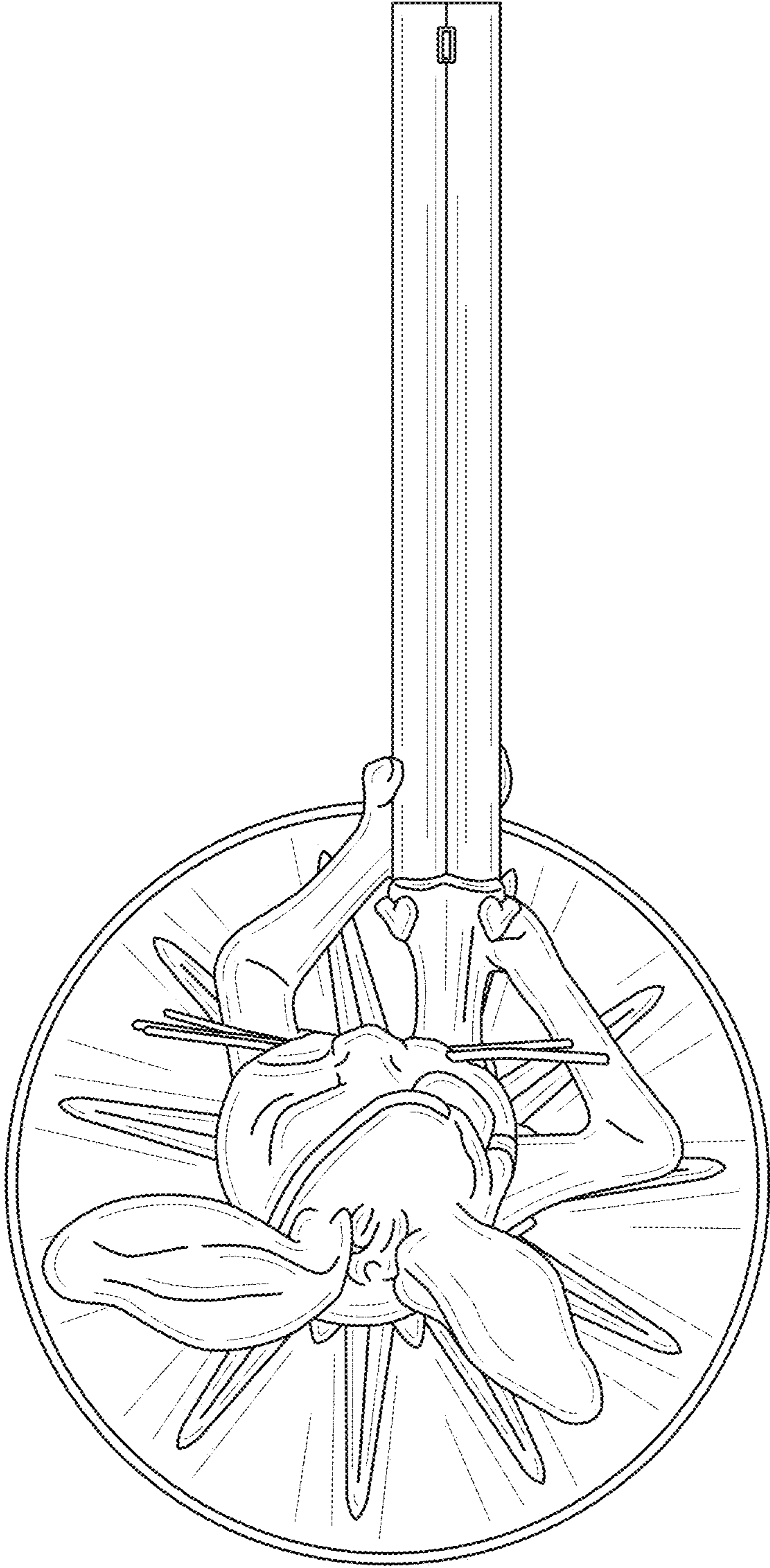

FIG. 7

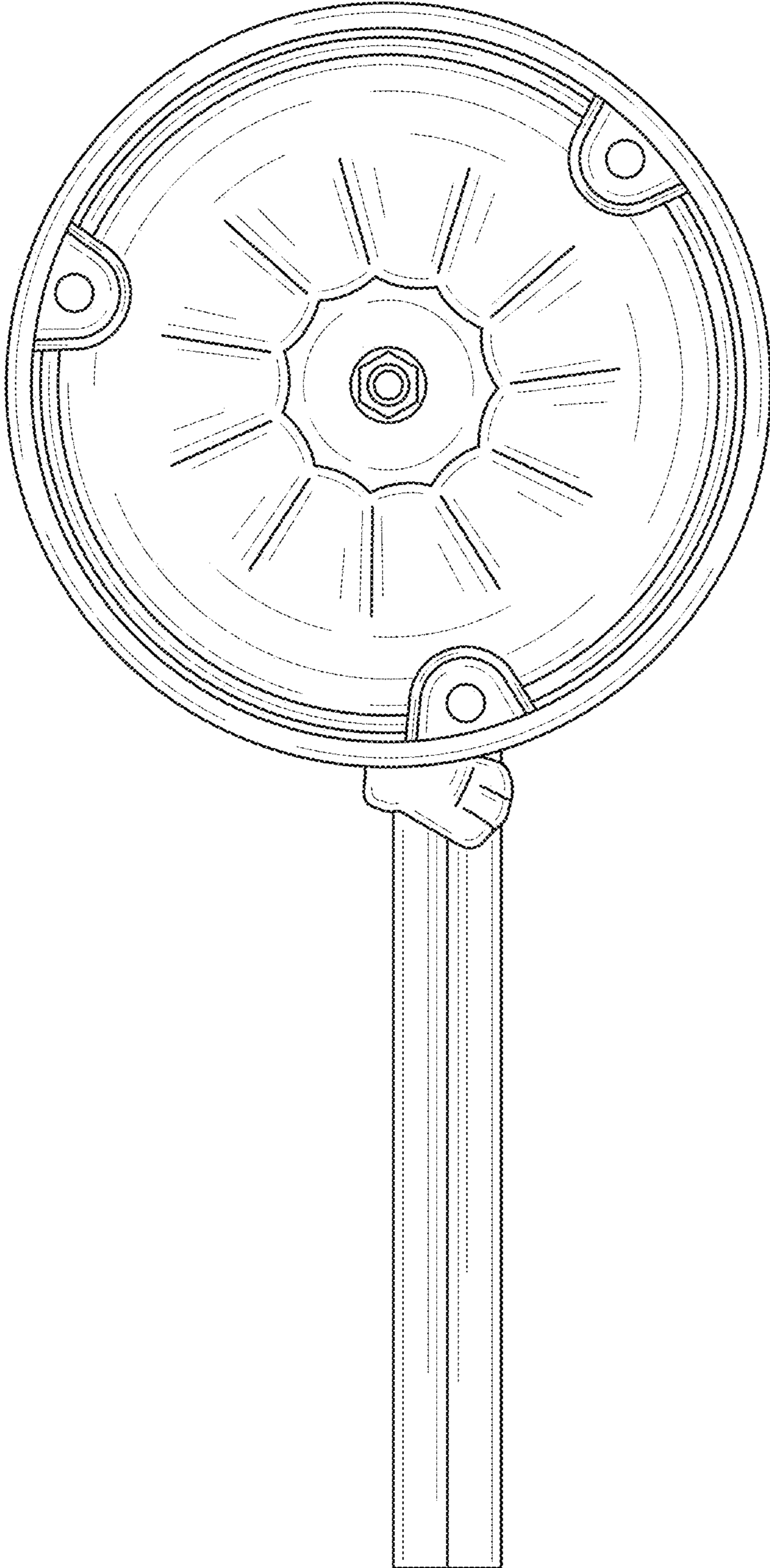

FIG. 8