



US0D1050329S

(12) **United States Design Patent** (10) **Patent No.:** **US D1,050,329 S**  
**Guo** (45) **Date of Patent:** **\*\* Nov. 5, 2024**

(54) **TENT**

(71) Applicant: **Jintong Guo**, Xiamen (CN)

(72) Inventor: **Jintong Guo**, Xiamen (CN)

(\*\*) Term: **15 Years**

(21) Appl. No.: **29/904,712**

(22) Filed: **Oct. 11, 2023**

(51) **LOC (14) Cl.** ..... **21-04**

(52) **U.S. Cl.**  
USPC ..... **D21/834**

(58) **Field of Classification Search**  
USPC ..... 446/478; D21/834, 837; 135/87, 88.01,  
135/88.05, 90, 117, 118, 143, 145, 157  
CPC ..... A63H 33/008; E04H 15/24; E04H 15/50;  
E04H 15/58; E04H 15/44; E04H 15/48;  
E04H 15/18; E04H 15/06; E04H 6/025;  
E04H 15/36

See application file for complete search history.

(56) **References Cited**

**U.S. PATENT DOCUMENTS**

D518,866 S	*	4/2006	Cantwell	.....	D21/834
D695,375 S	*	12/2013	Jin	.....	D21/834
D718,403 S	*	11/2014	Jin	.....	D21/837
D775,296 S		12/2016	Shir et al.		
D870,226 S		12/2019	Mundy et al.		
D926,908 S		8/2021	Wright et al.		
D933,769 S		10/2021	Cheng		
D970,673 S		11/2022	Guo		
D973,572 S		12/2022	Min		

**FOREIGN PATENT DOCUMENTS**

CN 308192985 \* 8/2023

**OTHER PUBLICATIONS**

Coleman Camping Tent with Instant Setup, 4/6/8/10 Person Weatherproof Tent, as shown in www.amazon.com, Dec. 12, 2017, ASIN B0787D6SD2. (Year: 2017).\*

Ever Advanced 10 Person Camping Blackout Tent, Multi Room Tent for Family, as shown in www.amazon.com, Jun. 9, 2023, ASIN B0C7L11VYS. (Year: 2023).\*

KTT Extra Large Tent 12 Person(Style-B), Family Cabin Tents,2 Rooms, Straight Wall, 3 Doors and 3 Windows with Mesh, Waterproof, Double Layer, Big Tent, as shown in www.amazon.com, Aug. 18, 2021, ASIN B09CZCSBY9. (Year: 2021).\*

KTT Extra Large Tent 10-12 Person(B),Family Cabin Tents,2 Rooms,Straight Wall,3 Doors and 3 Windows with Mesh,Waterproof, Double Layer,Big Tent for Outdoor,Picnic,Camping,Family Gathering, as shown in www.amazon.com, Sep. 5, 2023, ASIN B0CHBQPMRM. (Year: 2023).\*

(Continued)

*Primary Examiner* — Gino Colan

*Assistant Examiner* — Gregory G McLemore

(74) *Attorney, Agent, or Firm* — Jose Cherson Weissbrot

(57) **CLAIM**

The ornamental design for a tent as shown and described.

**DESCRIPTION**

FIG. 1 is a front and left side perspective view of a tent showing my new design;

FIG. 2 is a left side view thereof;

FIG. 3 is a right side view thereof;

FIG. 4 is a rear view thereof;

FIG. 5 is a front view thereof;

FIG. 6 is a top plan view thereof; and,

FIG. 7 is a bottom plan view thereof.

**1 Claim, 7 Drawing Sheets**

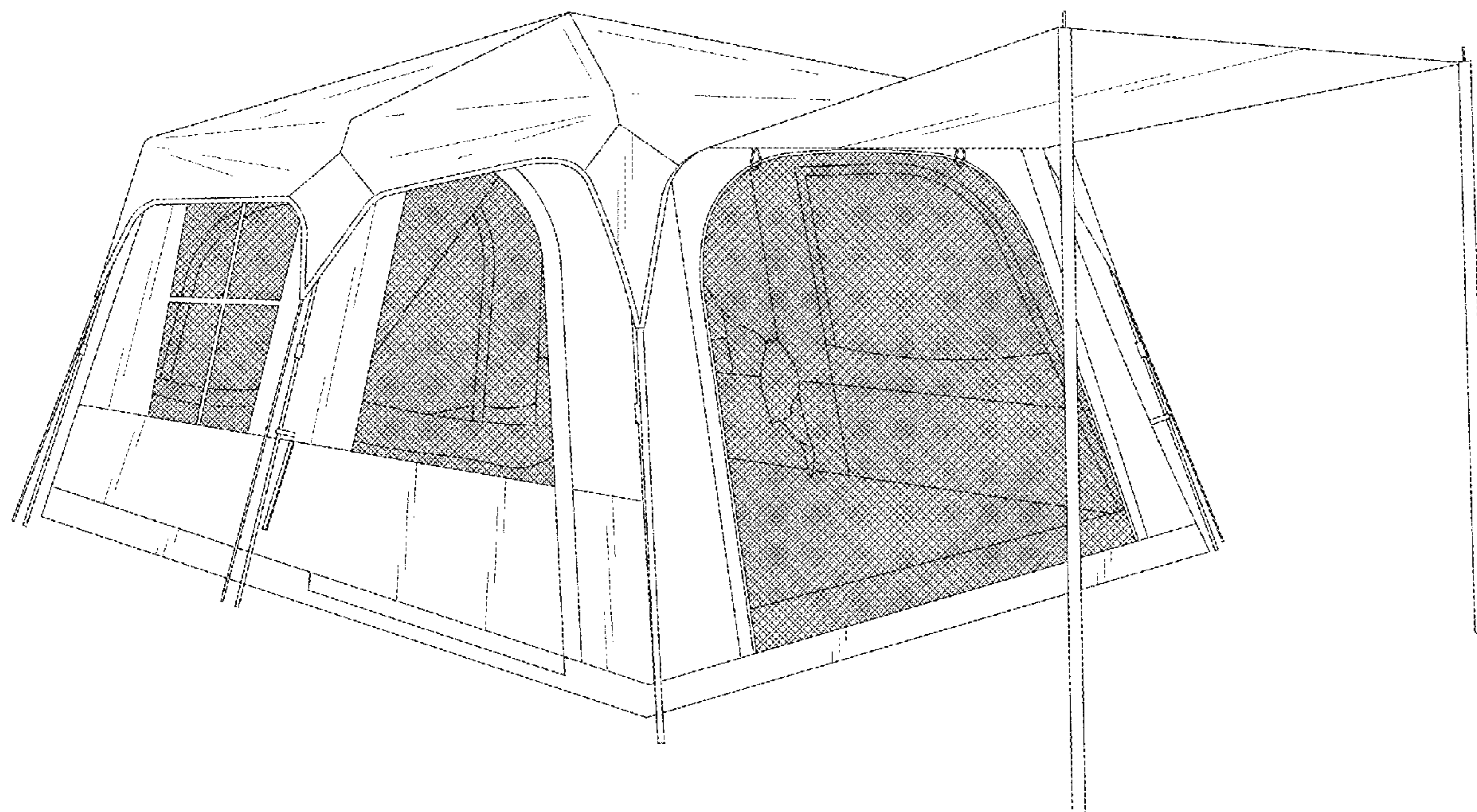

(56)

**References Cited**

OTHER PUBLICATIONS

KTT Instant Tent 12 Person(A),Large Family Cabin Tents, Automatic pop up Tent Build Quickly in 60S,2 Rooms,2Top Windows 3Doors and 3Windows with Mesh,Waterproof,Big Tent for Outdoor Camping., as shown in [www.amazon.com](http://www.amazon.com), Sep. 5, 2023, ASIN B0CHBN8X93. (Year: 2023).\*

Ozark Trail 13'x9' 8-Person Instant Cabin Tent with LED Lights, 36.9274 lbs, as shown in [www.walmart.com](http://www.walmart.com), Mar. 24, 2019, (Year: 2019).\*

Core 9 Person Instant Cabin Tent—14'x9', Green (40008), as shown in [www.amazon.com](http://www.amazon.com), Mar. 31, 2015, ASIN B00VFH1RQS. (Year: 2015).\*

Member's Mark 9-Person Instant Cabin Tent, as shown in [www.samsclub.com](http://www.samsclub.com), Jun. 26, 2021, Model # SAM-140978C1 (Year: 2021).\*

\* cited by examiner

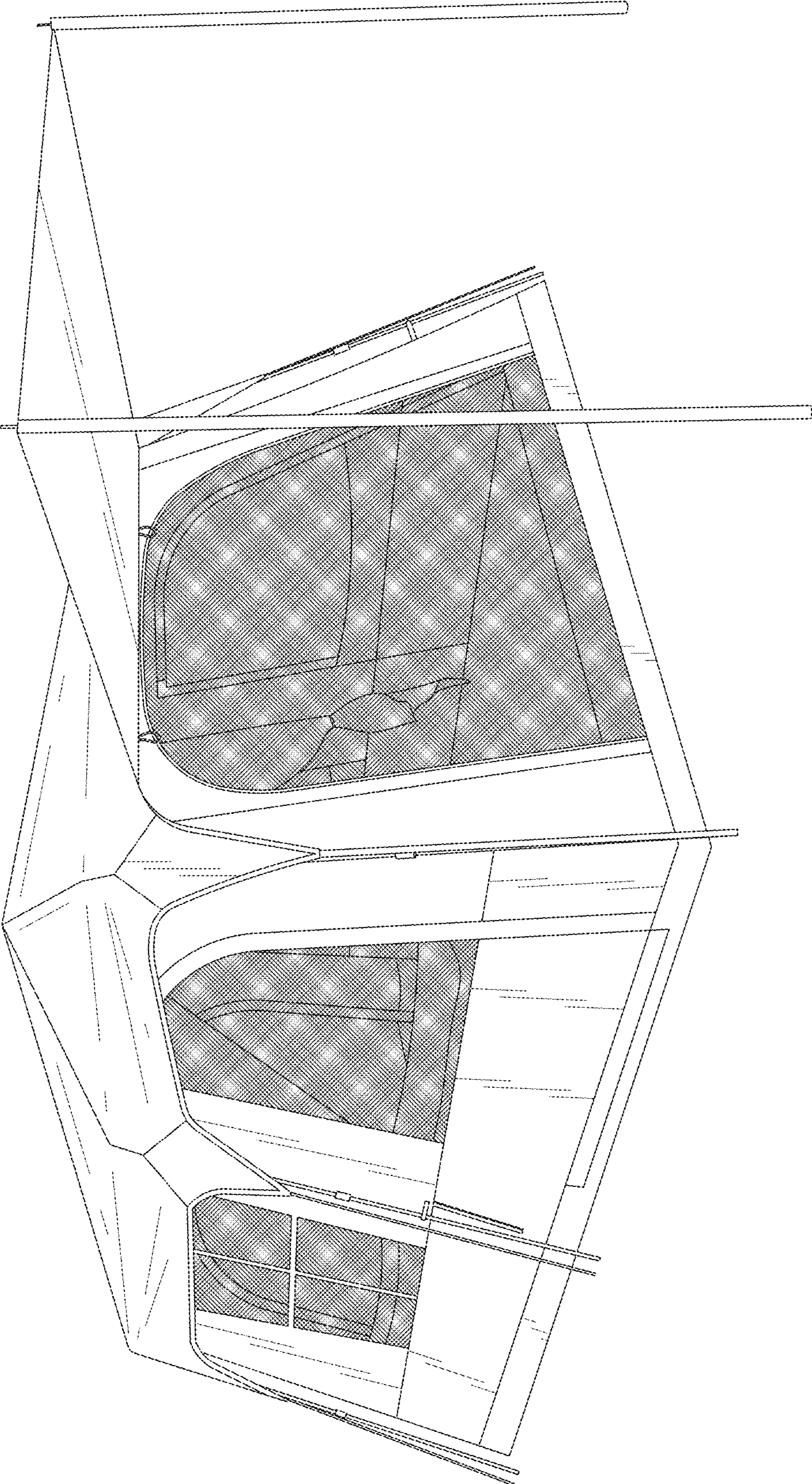

FIG. 1

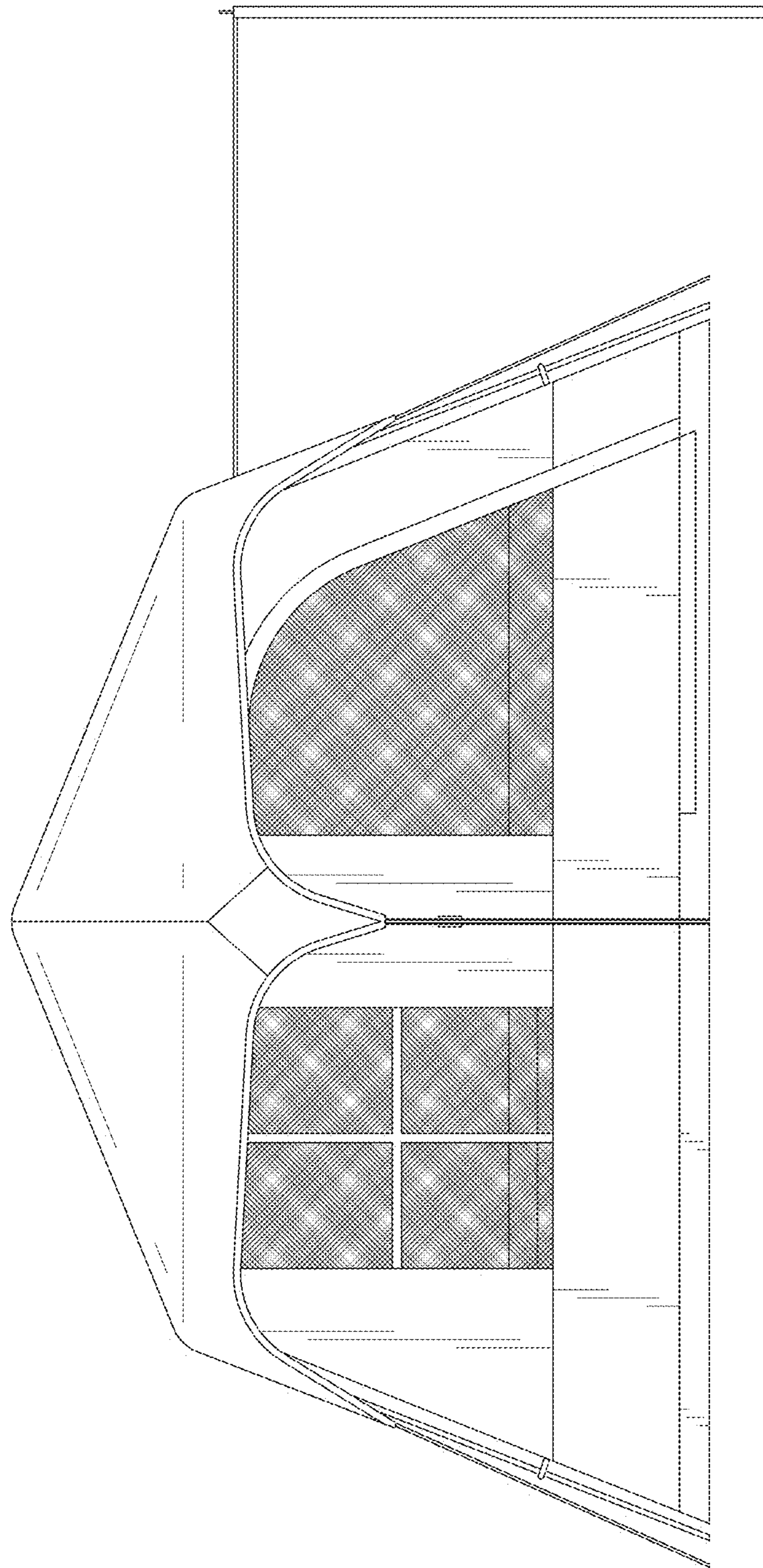

FIG. 2

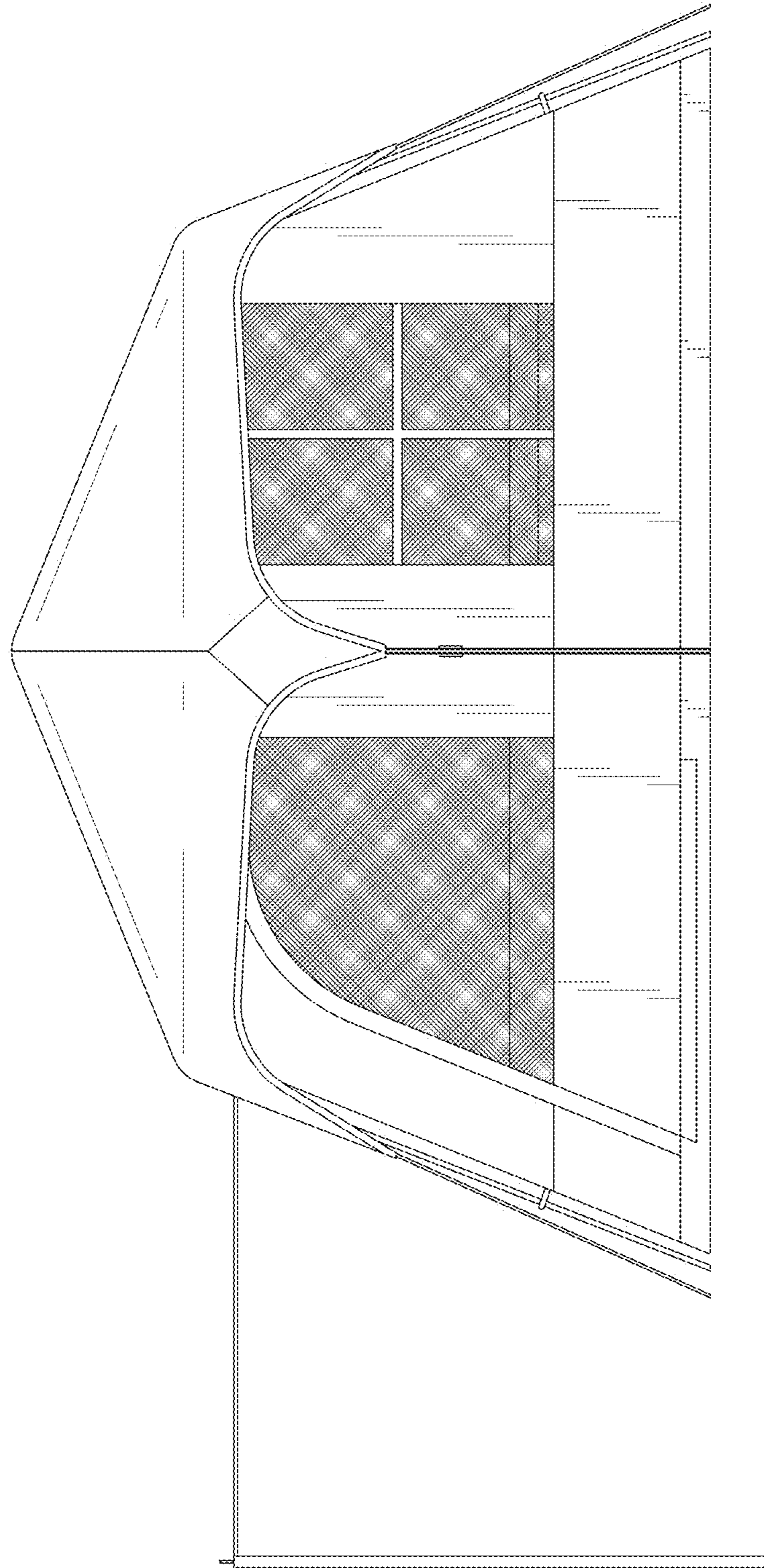

FIG. 3

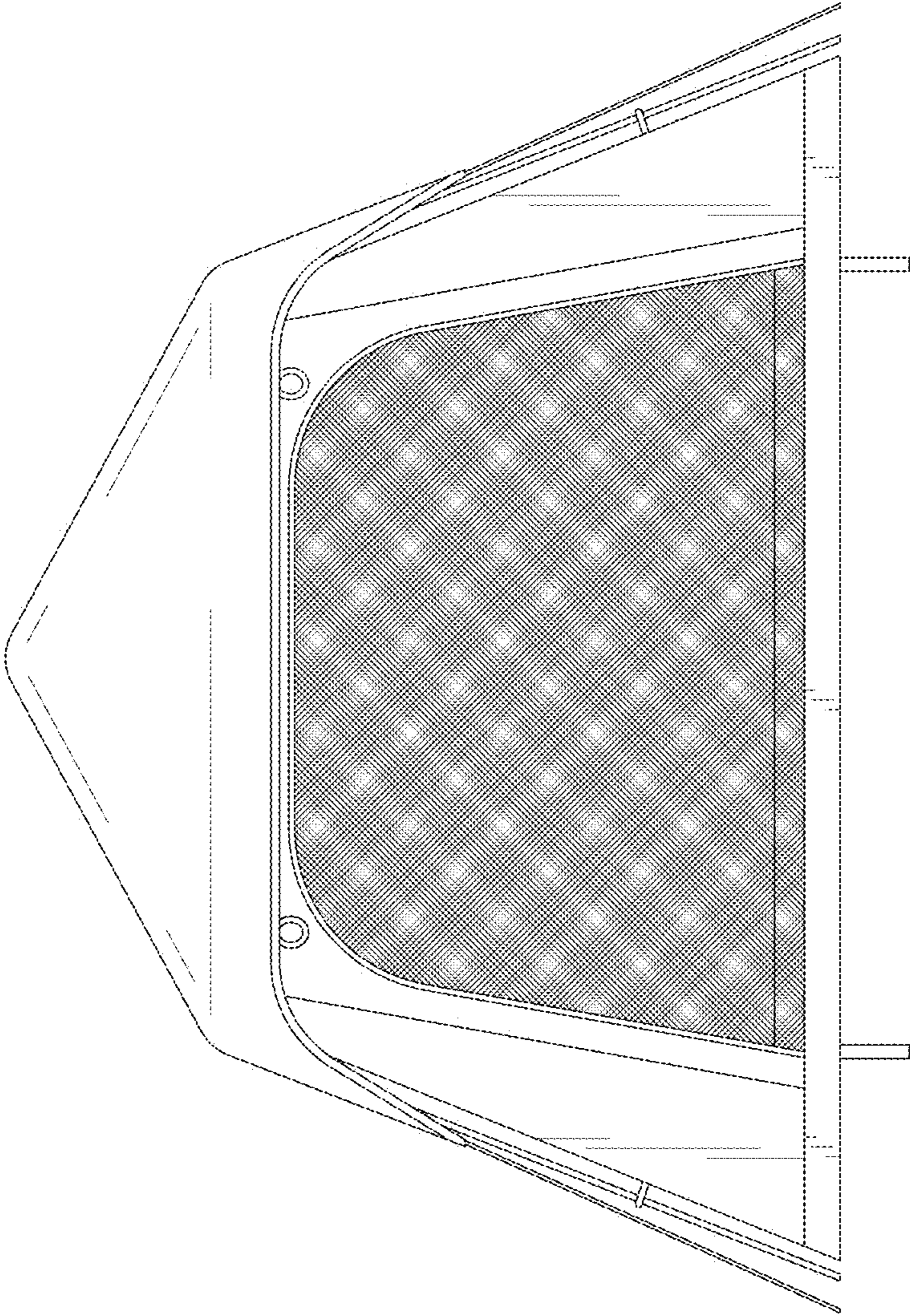

FIG. 4

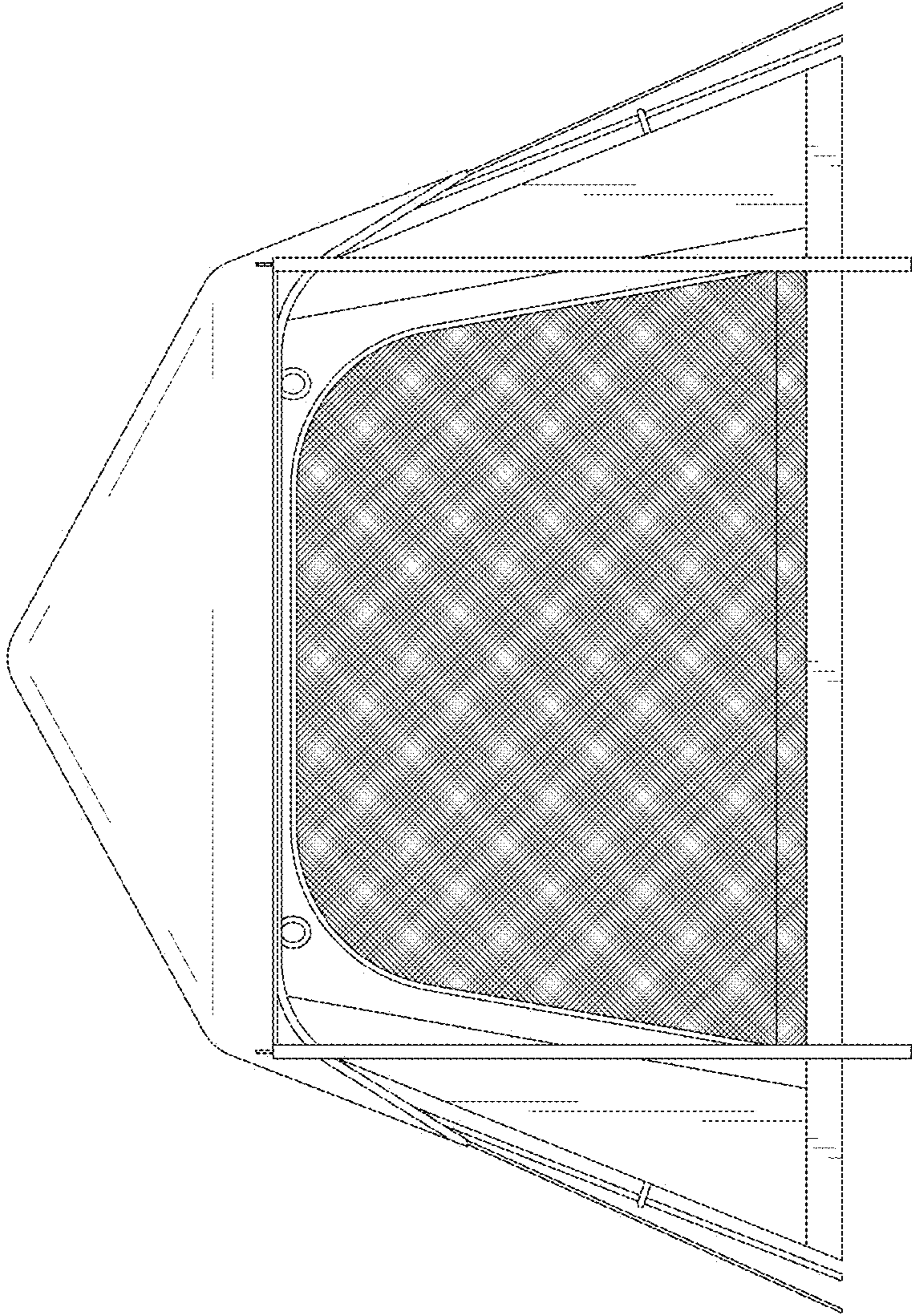

FIG. 5

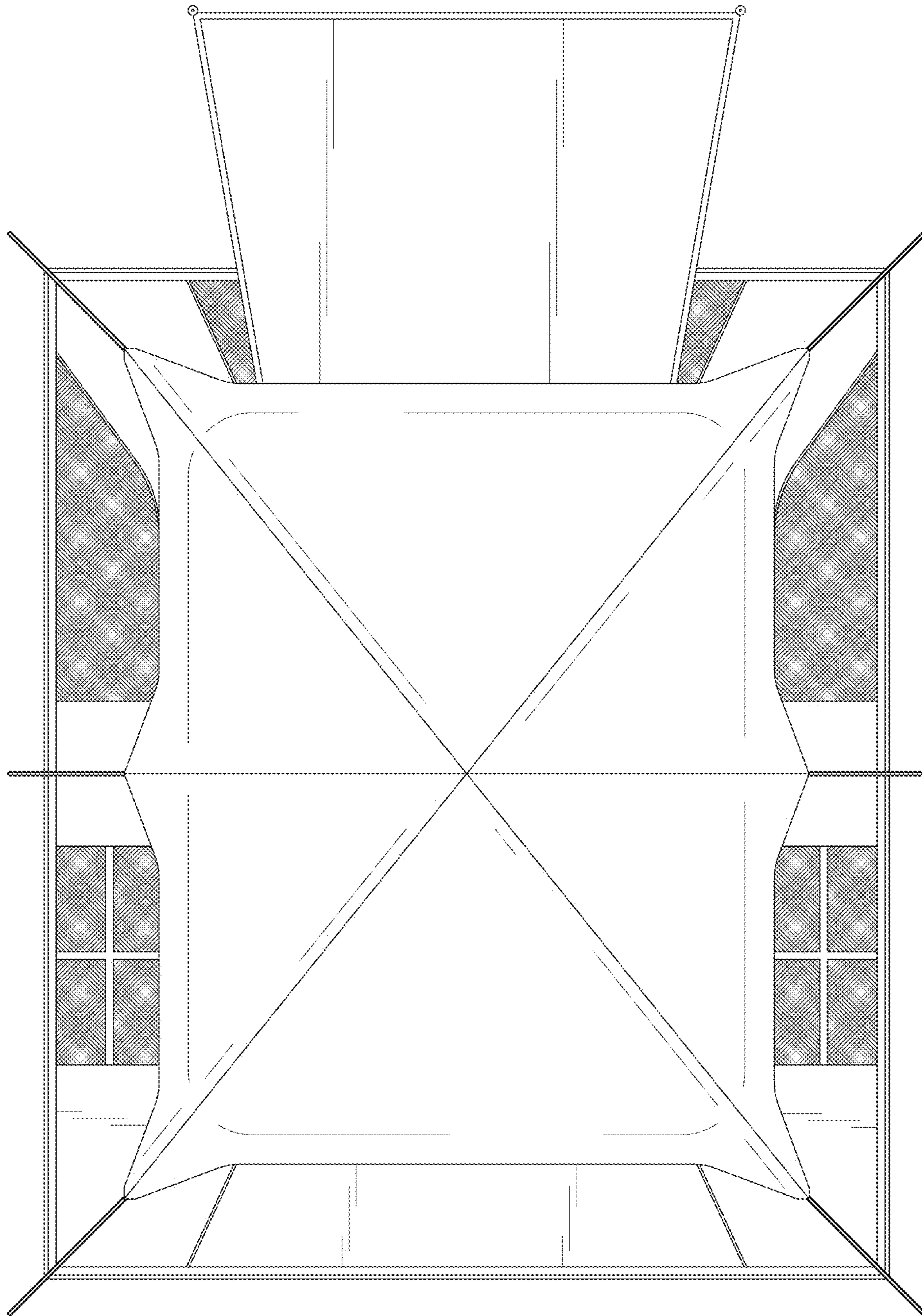

FIG. 6



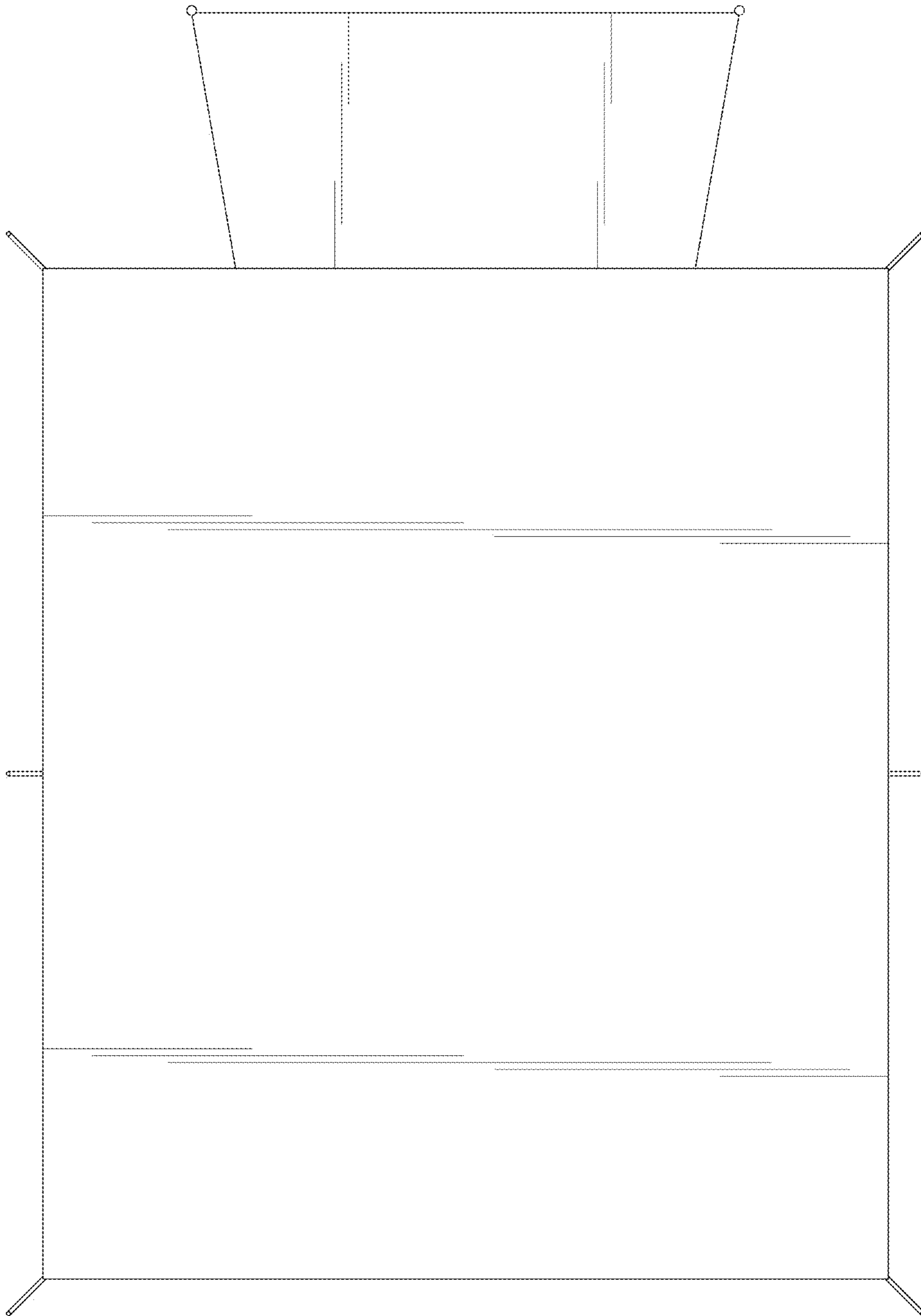

FIG. 7