



US0D1048847S

(12) **United States Design Patent**  
**Painter et al.**

(10) **Patent No.: US D1,048,847 S**

(45) **Date of Patent: \*\* Oct. 29, 2024**

(54) **UTILITY KNIFE**

7,185,436 B2 3/2007 Murphy  
D558,555 S \* 1/2008 Huang ..... D8/99  
7,415,769 B2 8/2008 Hughes

(71) Applicant: **Instant Brands Holdings Inc.**,  
Downers Grove, IL (US)

(Continued)

(72) Inventors: **Michael Joseph Painter**, Johnstown,  
OH (US); **Ludwin Miguel Mora**,  
Columbus, OH (US); **Sean W.**  
**Svendsen**, Columbus, OH (US); **Tania**  
**Louise Aldous**, Niles, IL (US)

**OTHER PUBLICATIONS**

Blue Ridge Tools 2 in 1 Rechargeable Screwdriver Flashlight,  
available at <https://www.target.com/p/blue-ridge-tools-2-in-1-rechargeable-screwdriver-flashlight/-/A-78262231#Ink=sametab>, product presently believed to be publicly available at least as of Aug. 5, 2020, 3 pg.

(Continued)

(73) Assignee: **Instant Brands Holdings Inc.**,  
Downers Grove, IL (US)

(\*\*) Term: **15 Years**

*Primary Examiner* — Philip S Hyder

(21) Appl. No.: **29/851,579**

(74) *Attorney, Agent, or Firm* — Tucker Ellis LLP

(22) Filed: **Aug. 30, 2022**

(51) **LOC (14) Cl.** ..... **08-03**

(52) **U.S. Cl.**  
USPC ..... **D8/99**

(58) **Field of Classification Search**  
USPC ..... D8/14, 51, 98, 99, 100, 105; D22/118  
CPC .... B26B 1/00; B26B 1/08; B26B 1/10; B26B  
5/001; B26B 5/002; B26B 5/003; B26B  
5/005; B26B 5/006

See application file for complete search history.

(57) **CLAIM**

The ornamental design for a utility knife, as shown and described.

**DESCRIPTION**

FIG. 1 is a top perspective view of a utility knife according to our new design;  
FIG. 2 is a rear elevation view of the utility knife of FIG. 1;  
FIG. 3 is a front elevation view of the utility knife of FIG. 1;  
FIG. 4 is a right side elevation view of the utility knife of FIG. 1;  
FIG. 5 is a left side elevation view of the utility knife of FIG. 1;  
FIG. 6 is a top plan view of the utility knife of FIG. 1; and,  
FIG. 7 is a bottom plan view of the utility knife of FIG. 1.  
The broken lines in the drawings illustrate portions of the utility knife that form no part of the claim. The dash-dot lines represent the boundary of the claimed design and forms no part thereof.

(56) **References Cited**

**U.S. PATENT DOCUMENTS**

D420,270 S \* 2/2000 Martone ..... D8/99  
D439,492 S \* 3/2001 Martone ..... D8/99  
6,330,749 B1 \* 12/2001 Khachatoorian ..... B26B 5/001  
30/162  
6,374,497 B1 \* 4/2002 Sun ..... B26B 5/001  
30/162  
D458,526 S \* 6/2002 Budrow ..... D8/99  
6,481,041 B1 11/2002 Ingram  
D478,493 S \* 8/2003 Martone ..... D8/99  
D509,419 S \* 9/2005 Chung ..... D8/99  
7,140,116 B2 11/2006 Coffin

**1 Claim, 4 Drawing Sheets**

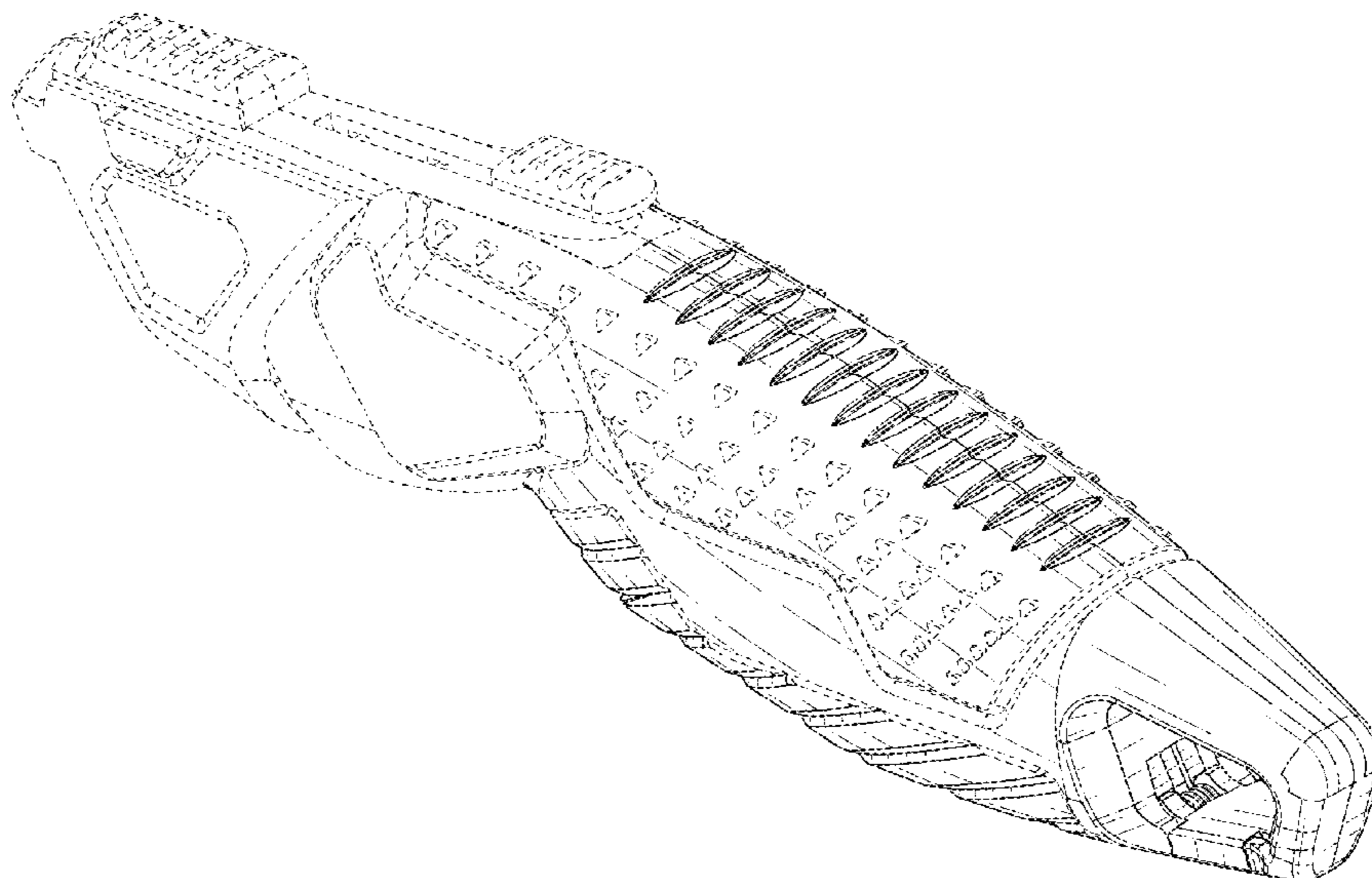

(56)

## References Cited

## U.S. PATENT DOCUMENTS

7,481,135	B2	1/2009	Schoenbeck	
D587,553	S *	3/2009	Constantine	D8/99
D629,274	S *	12/2010	Wu	D8/99
7,854,214	B2	12/2010	Khubani	
D651,064	S *	12/2011	Wu	D8/99
D668,526	S *	10/2012	Huang	D8/99
D675,503	S *	2/2013	Robinson	D8/99
D675,897	S *	2/2013	Wu	D8/99
D675,899	S *	2/2013	Wu	D8/99
8,677,627	B2	3/2014	Li	
8,739,414	B2	6/2014	Tyers	
D710,178	S *	8/2014	Wu	D8/99
8,793,881	B2 *	8/2014	Rowlay	B26B 5/001 30/162
9,032,631	B2	5/2015	Christie	
D767,361	S *	9/2016	Chiu	D8/99
9,545,731	B2	1/2017	Reid	
D793,198	S *	8/2017	Wang	D8/99
9,731,426	B2	8/2017	Kim	
9,764,486	B2	9/2017	Bublitz	
10,213,927	B2 *	2/2019	Chiu	B26B 5/003
D846,965	S	4/2019	Gilbert	
D848,235	S *	5/2019	Dechant	D8/99
10,279,490	B2	5/2019	Gilbert	
10,405,685	B2	9/2019	Wong	
D869,258	S *	12/2019	Ulloa	D8/99
10,589,436	B1	3/2020	Panosian	
D881,670	S *	4/2020	Yao	D8/99
D896,607	S *	9/2020	Wang	D8/99
D905,528	S	12/2020	Spotora	
D910,410	S *	2/2021	Chen	D8/99
D922,168	S *	6/2021	Chen	D8/99
2008/0235954	A1 *	10/2008	Radle	B26B 5/00 30/152
2008/0271322	A1 *	11/2008	Chen	B26B 5/001 30/162
2008/0301948	A1	12/2008	Kostner	
2009/0188066	A1	7/2009	Van Deursen	
2010/0037465	A1 *	2/2010	Price	B26B 5/001 30/152
2010/0037468	A1 *	2/2010	Rowlay	B26B 5/001 30/162
2012/0073143	A1 *	3/2012	Honda	B26B 5/002 30/162
2012/0090181	A1	4/2012	Broekhuizen	
2014/0250695	A1 *	9/2014	Wagner	B26B 5/003 30/162
2015/0013171	A1 *	1/2015	Wu	B26B 5/001 30/162
2015/0029702	A1	1/2015	Foley	
2017/0021511	A1 *	1/2017	Chiu	B26B 5/003
2017/0129112	A1 *	5/2017	Ranieri	B26B 1/08
2019/0375118	A1	12/2019	Spotora	
2020/0055202	A1 *	2/2020	Gomez	B26B 5/001
2020/0391396	A1 *	12/2020	Fossella	B26B 1/08
2022/0032483	A1 *	2/2022	Su	B26B 1/10

## OTHER PUBLICATIONS

Blue Ridge Tools Folding Utility Knife, available at <https://www.target.com/p/blue-ridge-tools-folding-utility-knife/-/A-78591336#Ink=sametab>, product presently believed to be publicly available at least as of Aug. 5, 2020, 3 pg.

Blue Ridge Tools 11 Function Hammer Multi Tool, available at <https://www.target.com/p/blue-ridge-tools-11-function-hammer-multi-tool/-/A-78591335#Ink=sametab>, product presently believed to be publicly available at least as of Aug. 5, 2020, 3 pg.

Blue Ridge Tools Rechargeable Screwdriver with Bit Storage, available at <https://www.target.com/p/blue-ridge-tools-rechargeable-screwdriver-with-bit-storage/-/A-78262217#Ink=sametab>, product presently believed to be publicly available at least as of Aug. 5, 2020, 3 pg.

Blue Ridge Tools Rechargeable Screwdriver Pink, available at <https://www.target.com/p/blue-ridge-tools-rechargeable-screwdriver-pink/-/A-78262233#Ink=sametab>, product presently believed to be publicly available at least as of Aug. 5, 2020, 3 pg.

Blue Ridge Tools Folding Multi Tool, available at <https://www.target.com/p/blue-ridge-tools-folding-multi-tool/-/A-78591363#Ink=sametab>, product presently believed to be publicly available at least as of Aug. 5, 2020, 3 pg.

Blue Ridge Tools Rechargeable Rotary Cutter, available at [https://www.target.com/p/blue-ridge-tools-rechargeable-rotary-cutter/-/A-78262218?store=3207&ref=tgt\\_adv\\_xsp&AFID=bing&fnds=gt&DFA=71700000072946997&CPNG=PLA\\_Home%2BImprovement%2BShopping\\_Local%7CHome%2BImprovement\\_Ecomm\\_Home&adgroup=SC\\_Home%2BImprovement\\_Power+Tools&LID=700000001230728pgs&LNM=PRODUCT\\_GROUP&network=o&device=c&location=&targetid=pla-4585444531614005&ds\\_rl=1246978&ds\\_rl=1247068&msclkid=e0cac81ec7161d4345caadb75d709f41&gclid=e0cac81ec7161d4345caadb75d709f41&gclid=3p.ds](https://www.target.com/p/blue-ridge-tools-rechargeable-rotary-cutter/-/A-78262218?store=3207&ref=tgt_adv_xsp&AFID=bing&fnds=gt&DFA=71700000072946997&CPNG=PLA_Home%2BImprovement%2BShopping_Local%7CHome%2BImprovement_Ecomm_Home&adgroup=SC_Home%2BImprovement_Power+Tools&LID=700000001230728pgs&LNM=PRODUCT_GROUP&network=o&device=c&location=&targetid=pla-4585444531614005&ds_rl=1246978&ds_rl=1247068&msclkid=e0cac81ec7161d4345caadb75d709f41&gclid=e0cac81ec7161d4345caadb75d709f41&gclid=3p.ds), product presently believed to be publicly available at least as of Aug. 5, 2020, 3 pg.

Snap-off Utility Knife (18 mm)—DIY (5 blades), available at <https://www.fiskars.com/en-us/crafting-and-sewing/ranges/diy-upholstery-tools/snap-off-utility-knife-18-mm-diy-5-blades-144720-1004>, product presently believed to be publicly available at least as of Aug. 5, 2020, 3 pg.

Snap-off Utility Knife (9 mm)—DIY (5 blades), available at <https://www.fiskars.com/en-us/crafting-and-sewing/products/diy-precision-tools/snap-off-utility-knife-9-mm-diy-5-blades-144710-1005>, product presently believed to be publicly available at least as of Aug. 5, 2020, 2 pg.

Walt Folding Utility Knife <https://www.agrisales-inc.com/dewalt-dwht10035-folding-utility-knife>, available as early as Aug. 29, 2022, 3 pgs.

Stanley Classic Retractable Utility Knife [https://www.amazon.com/Stanley-10-099-Classic-Retractable-Utility/dp/B013P44YHM/ref=asc\\_df\\_B013P44YHM/?tag=hyprod-20&linkCode=df0&hvadid=167125219398&hvpos=&hvnetw=g&hvrand=13139388483172131048&hvpone=&hvptwo=&hvqmt=&hvdev=c&hvdvcmdl=&hvlocint=&hvlocphy=9060252&hvtargid=pla-309758728252&pvc=1](https://www.amazon.com/Stanley-10-099-Classic-Retractable-Utility/dp/B013P44YHM/ref=asc_df_B013P44YHM/?tag=hyprod-20&linkCode=df0&hvadid=167125219398&hvpos=&hvnetw=g&hvrand=13139388483172131048&hvpone=&hvptwo=&hvqmt=&hvdev=c&hvdvcmdl=&hvlocint=&hvlocphy=9060252&hvtargid=pla-309758728252&pvc=1), available as early as Aug. 29, 2022, 7 pgs.

Milwaukee Fastback Folding Utility Knife, <https://www.milwaukeeetool.com/Products/Hand-Tools/Cutting/Knives-and-Blades/48-22-1502>, available as early as Aug. 29, 2022, 12 pgs.

PHC Snap-Blade Knife, <https://www.msdirect.com/browse/tnpla/09582081>, 14 pgs.

DeWalt 25mm Snap-Knife, <https://gemplers.com/products/dewalt-25mm-snap-off-knife>, available as early as Aug. 29, 2022, 2 pgs.

DeWalt Utility Knife, <https://www.zoro.com/dewalt-utility-knife-retractable-utility-general-purpose-steelrubber-dwht10046/i/G7636781/>, 11 pgs.

Olfa 25mm H-1, <https://olfa.com/products/25mm-h-1-rubber-inset-utility-knife>, available as early as Aug. 29, 2022, 10 pgs.

Olfa Knife Snap-Off 25mm, <https://www.tooleto.com/en/olfa-knife-snap-off-25mm-xh-1.html>, 2 pgs.

Tac-Force All Black Karambit Knife, <https://www.sunburstreflections.com/product/tac-force-all-black-karambit-knife>, available as early as Aug. 29, 2022, 3 pgs.

Fiskars 195210 45mm All Purpose Rotary Cutter, Fiskars 195210-1021 45 mm All Purpose Rotary Cutter—Walmart.com, available as early as Aug. 29, 2022 6 pgs.

Slice Box Cutter—Safety, <https://www.uline.com/Product/Detail/H-3552/Cutters/Slice-Box-Cutter-Safety>, available as early as Aug. 29, 2022, 1 pg.

Slice Super-Safe Carton Opener 1-Blade Retractable Utility Knife, <https://www.lowes.com/pd/Slice-Super-Safe-8482-Carton-Cutter/5013013295>, 3 pgs.

Olfa OLO Self-Guiding Carton Cutter Each, <https://www.olfaproducts.com/olo-cact-carton-cutter.html>, available as early as Aug. 29, 2022, 3 pgs.

Image of Kobalt product, available as early as Aug. 5, 2020, 1 pg.

Image of Anvil products, available as early as Aug. 5, 2020, 1 pg.

Image of Husky product, available as early as Aug. 5, 2020, 1 pg.

Image of Husky products, available as early as Aug. 5, 2020, 1 pg.

(56)

**References Cited**

## OTHER PUBLICATIONS

Image of Stantley products, available as early as Aug. 5, 2020, 1 pg.

Image of DeWalt 9mm Snap Knife, available as early as Aug. 5, 2020, 1 pg.

Image of Craftsman 9mm Snap Knife, available as early as Aug. 5, 2020, 1 pg.

Image of Husky 9mm Snap Knife, available as early as Aug. 5, 2020, 1 pg.

Image of Olfa 9mm Snap Knife, available as early as Aug. 5, 2020, 1 pg.

Image of Olfa 9mm 5023 Snap Knife, available as early as Aug. 5, 2020, 1 pg.

Image of Olfa XA-1 9mm Snap Knife, available as early as Aug. 5, 2020, 1 pg.

Images of Wurth Utility Knives, available as early as Aug. 6, 2022, 1 pg.

Image of Anvil THD 18mm Snap Knife, available as early as Aug. 5, 2020, 1 pg.

Image of Stanley Lowes SnapOff Blade 18mm 0-10-150, available as early as Aug. 5, 2020, 1 pg.

Image of DeWalt 18mm Snap Knife, available as early as Aug. 5, 2020, 1 pg.

Image of Olfa Lowes 18mm Snap Knife, available as early as Aug. 5, 2020, 1 pg.

Image of Olfa THD 18mm snap knife, available as early as Aug. 5, 2020, 1 pg.

Images of Olfa X-Design 18 3/4mm knife, available as early as Aug. 5, 2020, 1 pg.

Image of Milwaukee 18mm Snap-Off Knife, available as early as Aug. 5, 2020, 1 pg.

Image of ToolPro 25 mm Dial Lock Snap Knife, available as early as Aug. 5, 2020, 1 pg.

Image of Craftsman 25mm 1-Blade Utility Knife, available as early as Aug. 5, 2020, 1 pg.

Image of Fiskars Pro 25mm Snap-Off Blade Utility Knife, available as early as Aug. 5, 2020, 1 pg.

Image of Craftsman 25mm Snap Off Knife, available as early as Aug. 5, 2020, 1 pg.

Image of Stanley® 25mm DynaGrip® Snap-Off Knife, available as early as Aug. 5, 2020, 1 pg.

Image of Olfa H-1 25mm Extra Heavy Duty Cutter Knife, available as early as Aug. 5, 2020, 1 pg.

Image of Stanley 10-817 25mm FatMax Pro Snap-off Blade Knife, available as early as Aug. 5, 2020, 1 pg.

Image of Olfa 25mm Fiberglass-reinforced Ratchet-lock Snap-off Utility Knife, available as early as Aug. 5, 2020, 1 pg.

Image of Fiskars Pro Folding Utility Knife, available as early as Aug. 5, 2020, 1 pg.

Image of Fiskars Utility Trapezoid Blade Knife, available as early as Aug. 5, 2020; 1 pg.

Image of Milwaukee Self-Retracting Trapezoid Blade Knife, available as early as Aug. 5, 2020; 1 pg.

Image of utility blade trapezoid knife, available as early as Aug. 5, 2020; 1 pg.

Image of Landing Custom Safety Utility Trapezoid Blade Knife, available as early as Aug. 5, 2020; 1 pg.

Image of trapezoid blade knife, available as early as Aug. 5, 2020; 1 pg.

Image of Utility Trapezoid Blade Knife, available as early as Aug. 5, 2020; 1 pg.

Images of Foxmax Trapezoid Blade Knife, available as early as Aug. 5, 2020; 1 pg.

Fiskars Crafts Premier Ultra-Sharp Thread Snip product, available at [https://www.amazon.com/Fiskars-Crafts-Premier-Ultra-Sharp-Thread/dp/B072N2ZPGC/ref=sr\\_1\\_1?keywords=Fiskars%C2%AE+Ultrasharp+Thread+Snips&qid=1674082200&sr=8-1](https://www.amazon.com/Fiskars-Crafts-Premier-Ultra-Sharp-Thread/dp/B072N2ZPGC/ref=sr_1_1?keywords=Fiskars%C2%AE+Ultrasharp+Thread+Snips&qid=1674082200&sr=8-1) as early as Aug. 5, 2020, 10 pg.

Fiskars Shears available at [https://www.amazon.com/Fiskars-190500-RazorEdge-Micro-Tip-Action/dp/B00UY11IFG/ref=sr\\_1\\_2?keywords=Fiskars%C2%AE%2BUltrasharp%2BThread%2BSnips&qid=1674082685&sr=8-2&th=1](https://www.amazon.com/Fiskars-190500-RazorEdge-Micro-Tip-Action/dp/B00UY11IFG/ref=sr_1_2?keywords=Fiskars%C2%AE%2BUltrasharp%2BThread%2BSnips&qid=1674082685&sr=8-2&th=1) as early as Aug. 5, 2020, 10 pg.

Fiskars Scissors available at [https://www.amazon.com/Fiskars-5-Inch-Softgrip-Scissors/dp/B000B7MUE6/ref=sr\\_1\\_1?crd=GN6MJC4OEQY6&keywords=Fiskars%2B5%2Binch%2Bsoft%2Bgrip&qid=1674082882&sprefix=fiskars%2B5%2Binch%2Bsoft%2BCaps%2C589&sr=8-1&th=1](https://www.amazon.com/Fiskars-5-Inch-Softgrip-Scissors/dp/B000B7MUE6/ref=sr_1_1?crd=GN6MJC4OEQY6&keywords=Fiskars%2B5%2Binch%2Bsoft%2Bgrip&qid=1674082882&sprefix=fiskars%2B5%2Binch%2Bsoft%2BCaps%2C589&sr=8-1&th=1) as early as Aug. 5, 2020, 9 pg.

DeWalt Premium Folding Retractable Utility Knife, available at <https://www.dewalt.com/product/dwht10296/premium-folding-retractable-utility-knife?tid=576801> as early as Aug. 5, 2020; 12 pg.

DeWalt Folding Fixed Blade Knife, available at <https://www.dewalt.com/product/dwht10916/folding-fixed-blade-knife?tid=576801> as early as Aug. 5, 2020; 11 pg.

Milwaukee Fastback™ 6IN1 Folding Utility Knife, available at <https://www.milwaukeetool.com/Products/Hand-Tools/Cutting/48-22-1505> as early as Aug. 5, 2020; 6 pg.

Milwaukee Fastback™ Folding Utility Knife, available at <https://www.milwaukeetool.com/Products/Hand-Tools/Cutting/48-22-1501> as early as Aug. 5, 2020, 5 pg.

Milwaukee Fastback™ Spring Assisted Folding Knife, available at <https://www.milwaukeetool.com/Products/Hand-Tools/Cutting/48-22-1530> as early as Aug. 5, 2020, 10 pg.

Husky 21113 Folding Sure-Grip Lock Back Utility Knife, available at <https://www.amazon.com/Husky-21113-Sure-Grip-Disposable-Included/dp/B0026SY730> as early as Aug. 5, 2020, 8 pg.

Husky Retractable Folding Utility Knife, available at <https://www.homedepot.com/p/Husky-Retractable-Folding-Utility-Knife-99734/303741395> as early as Aug. 5, 2020, 5 pg.

Husky Pro Folding Utility Knife, available at <https://www.homedepot.com/p/Husky-Pro-Folding-Utility-Knife-99737/303741407#overlay> as early as Aug. 5, 2020, 5 pg.

Craftman 3/4-in 3-Blade Folding Retractable Utility Knife, available at [https://www.lowes.com/pd/CRAFTSMAN-3-4-in-3-Blade-Folding-Retractable-Utility-Knife/1000594515?cm\\_mmc=shp-\\_-c-\\_-vf-\\_-tol-\\_-ggl-\\_-SS\\_SDB-Craftsman-\\_-1000594515-\\_-local-\\_-0-\\_-0&ds\\_a\\_cid=279391351&gclid=EAlaQobChMIvo-DrP6-wIVTsmUCR2LTgfOEAQYASABEgKM4\\_D\\_BwE&gclsrc=aw.ds](https://www.lowes.com/pd/CRAFTSMAN-3-4-in-3-Blade-Folding-Retractable-Utility-Knife/1000594515?cm_mmc=shp-_-c-_-vf-_-tol-_-ggl-_-SS_SDB-Craftsman-_-1000594515-_-local-_-0-_-0&ds_a_cid=279391351&gclid=EAlaQobChMIvo-DrP6-wIVTsmUCR2LTgfOEAQYASABEgKM4_D_BwE&gclsrc=aw.ds) as early as Aug. 5, 2020, 5 pg.

Irwin FK150 Folding Utility Knife, available at <https://www.irwin.com/tools/utility-knives-blades/irwin-fk150-folding-utility-knife> as early as Aug. 5, 2020, 4 pg.

Irwin Folding, available at <https://www.irwin.com/tools/utility-knives-blades/folding> as early as Aug. 5, 2020, 5 pg.

Kobalt Lockback 11-Blade Folding Utility Knife, available at <https://www.lowes.com/pd/Kobalt-Kobalt-Quick-Change-Folding-Lock-Back-Knife/5001727641> as early as Aug. 5, 2020, 6 pg.

DeWalt Premium Retractable Utility Knife, available at <https://www.dewalt.com/product/dwht10295/premium-retractable-utility-knife?tid=576801> as early as Aug. 5, 2020; 8 pg.

DeWalt Instantchanger Knife, available at <https://www.dewalt.com/product/dwht10914/instantchanger-knife?tid=576801> as early as Aug. 5, 2020; 7 pg.

DeWalt Retractable Utility Knife, available at <https://www.dewalt.com/product/dwht10319/retractable-utility-knife?tid=576801> as early as Aug. 5, 2020; 7 pg.

DeWalt Fixed Blade Knife, available at <https://www.dewalt.com/product/dwht10246/fixed-blade-knife?tid=576801> as early as Aug. 5, 2020; 7 pg.

Craftsman Quick Change 3-Blade Retractable Utility Knife with On Tool Blade Storage, available at <https://www.lowes.com/pd/CRAFTSMAN-Quick-Change-Knife/5000242955> as early as Aug. 5, 2020; 2 pg.

Irwin 3/4-in 1-Blade Retractable Utility Knife with On Tool Blade Storage, available at [https://www.lowes.com/pd/IRWIN-3-4-in-1-Blade-Retractable-Utility-Knife-with-with-On-Tool-Blade-Storage/1003172452?cm\\_mmc=shp-\\_-c-\\_-vf-\\_-tol-\\_-ggl-\\_-SS\\_Irwin-\\_-1003172452-\\_-local-\\_-0-\\_-0&ds\\_a\\_cid=279391351&gclid=EAlaQobChMIILbQuJzA-wIVojizAB2BpwrcEAQYAYABEgKq3\\_D\\_BwE&gclsrc=aw.ds](https://www.lowes.com/pd/IRWIN-3-4-in-1-Blade-Retractable-Utility-Knife-with-with-On-Tool-Blade-Storage/1003172452?cm_mmc=shp-_-c-_-vf-_-tol-_-ggl-_-SS_Irwin-_-1003172452-_-local-_-0-_-0&ds_a_cid=279391351&gclid=EAlaQobChMIILbQuJzA-wIVojizAB2BpwrcEAQYAYABEgKq3_D_BwE&gclsrc=aw.ds) as early as Aug. 5, 2020; 3 pg.

Craftsman 3/4-in 3-Blade Retractable Utility Knife with On Tool Blade Storage, available at <https://www.lowes.com/pd/CRAFTSMAN-3-4-in-3-Blade-Retractable-Utility-Knife-with-with-On-Tool-Blade-Storage/1000594575> as early as Aug. 5, 2020; 3 pg.

(56)

**References Cited**

OTHER PUBLICATIONS

Craftsman Hi-Vis Quick Change 3-Blade Retractable Utility Knife with On Tool Blade Storage, available at <https://www.lowes.com/pd/CRAFTSMAN-HI-VIS-Quick-Change-Knife/5000242959> as early as Aug. 5, 2020; 2 pg.

Snap-on Folding Utility Knife, available at [https://www.samsclub.com/p/utility-knife-set-folding-retractable/prod19921932?pid=\\_CSE\\_PIN\\_716244](https://www.samsclub.com/p/utility-knife-set-folding-retractable/prod19921932?pid=_CSE_PIN_716244) as early as Aug. 5, 2020; 4 pg.

Fiskars 770050 Painters Utility Folding Knife, available at <https://www.ihlcanada.com/fiskars-770050-painters-utility-folding-knife-28566> as early as Aug. 5, 2020 as early as Aug. 5, 2020; 2 pg.

Gerber Gear Edge Exchange-A-Blade Folding Razor Utility Knife, available at <https://www.walmart.com/ip/Gerber-Gear-Edge-Exchange-A-Blade-Folding-Razor-Utility-Knife-Orange/285345154> as early as Aug. 5, 2020; 4 pg.

Steel Grip 5½in. Sliding Safety Knife Silver, available at <https://www.acehardware.com/departments/tools/hand-tools/utility-and-hobby-knives/2796142> as early as Aug. 5, 2020; 6 pg.

Image of Craftsman Lowes 18mm Snap Knife, available as early as Aug. 5, 2020, 1 pg.

Image of Husky THD 18mm Snap Knife, available as early as Aug. 5, 2020, 1 pg.

Image of DeWalt THD 25mm Snap Knife, available as early as Aug. 5, 2020, 1 pg.

\* cited by examiner

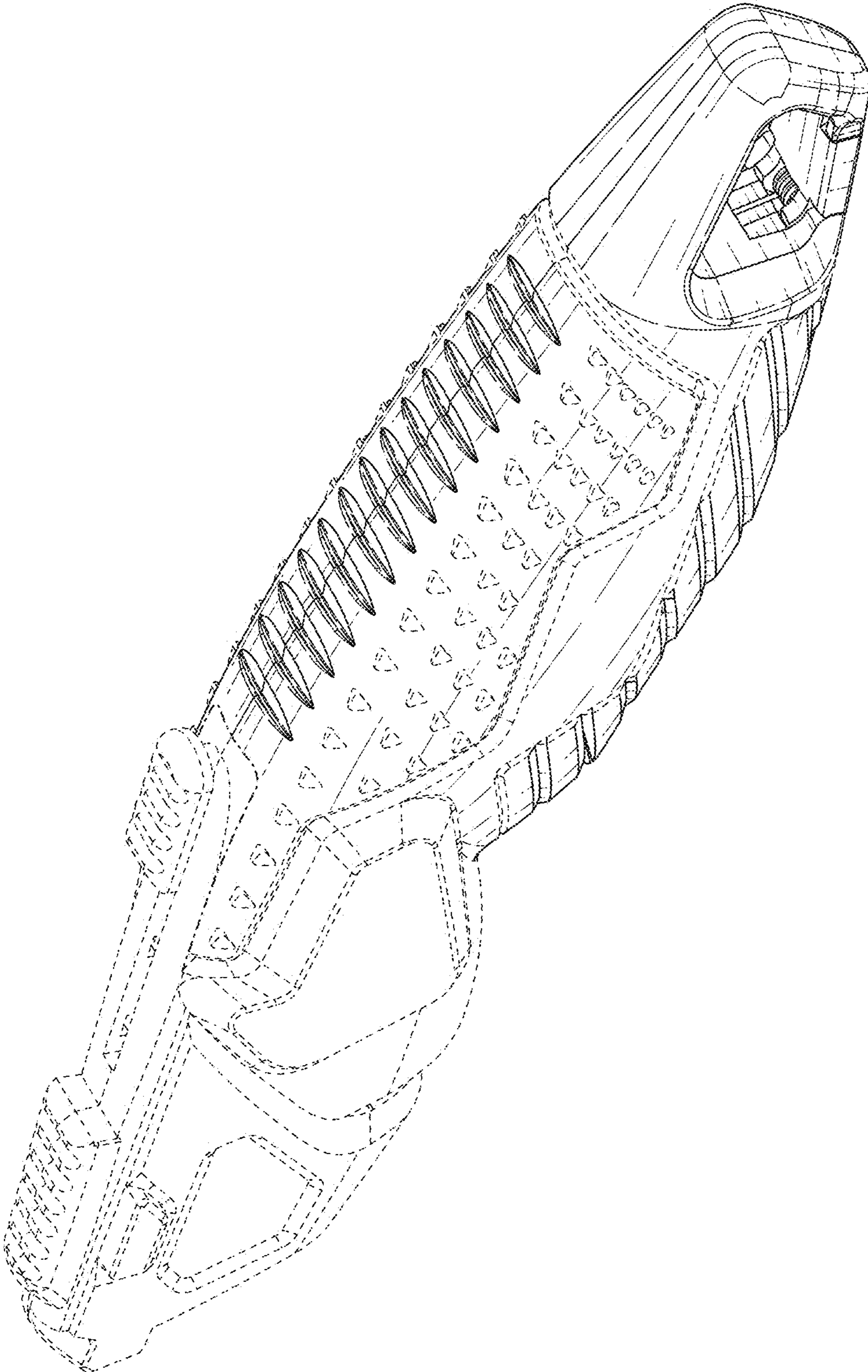

FIG. 1

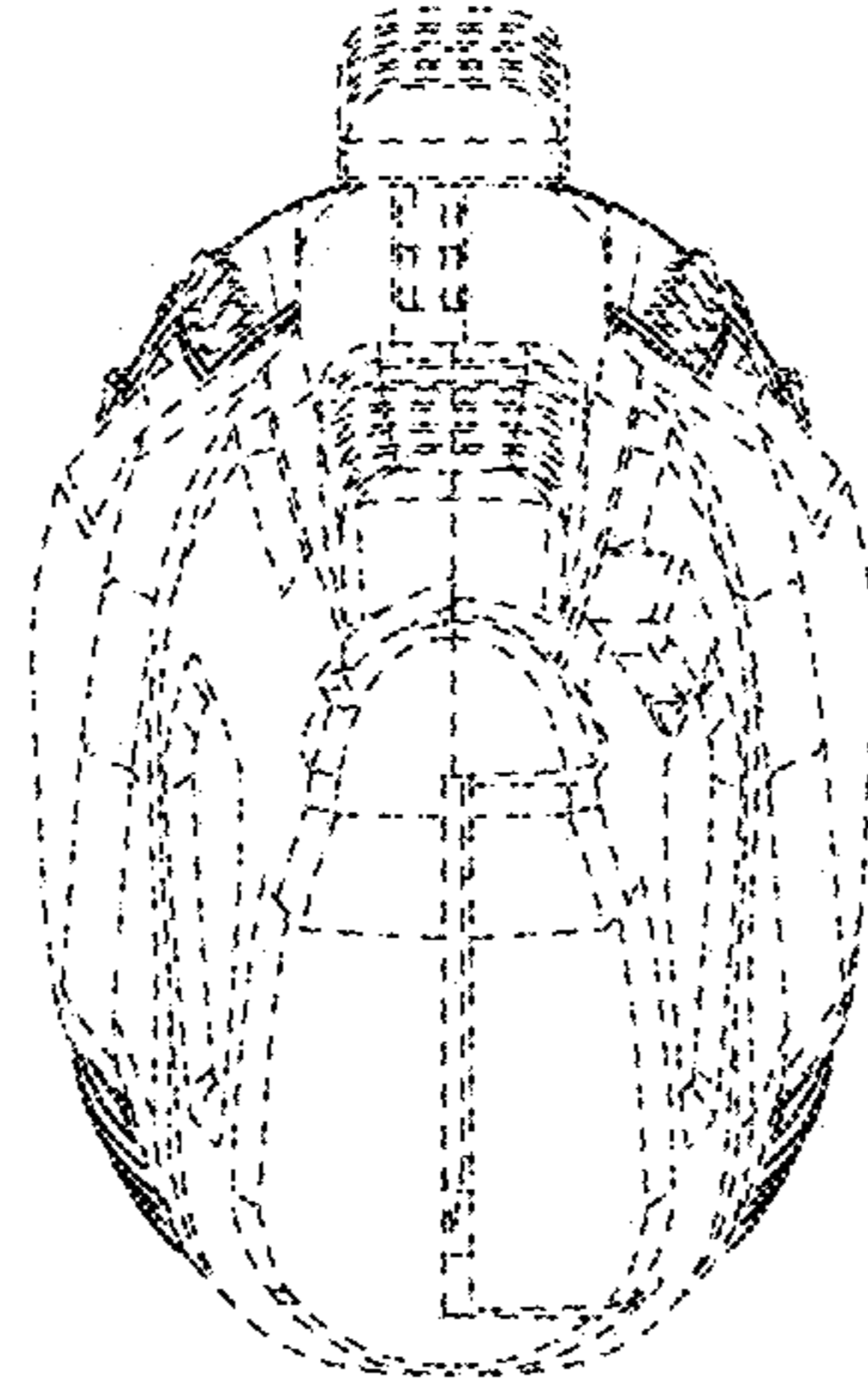

FIG. 2

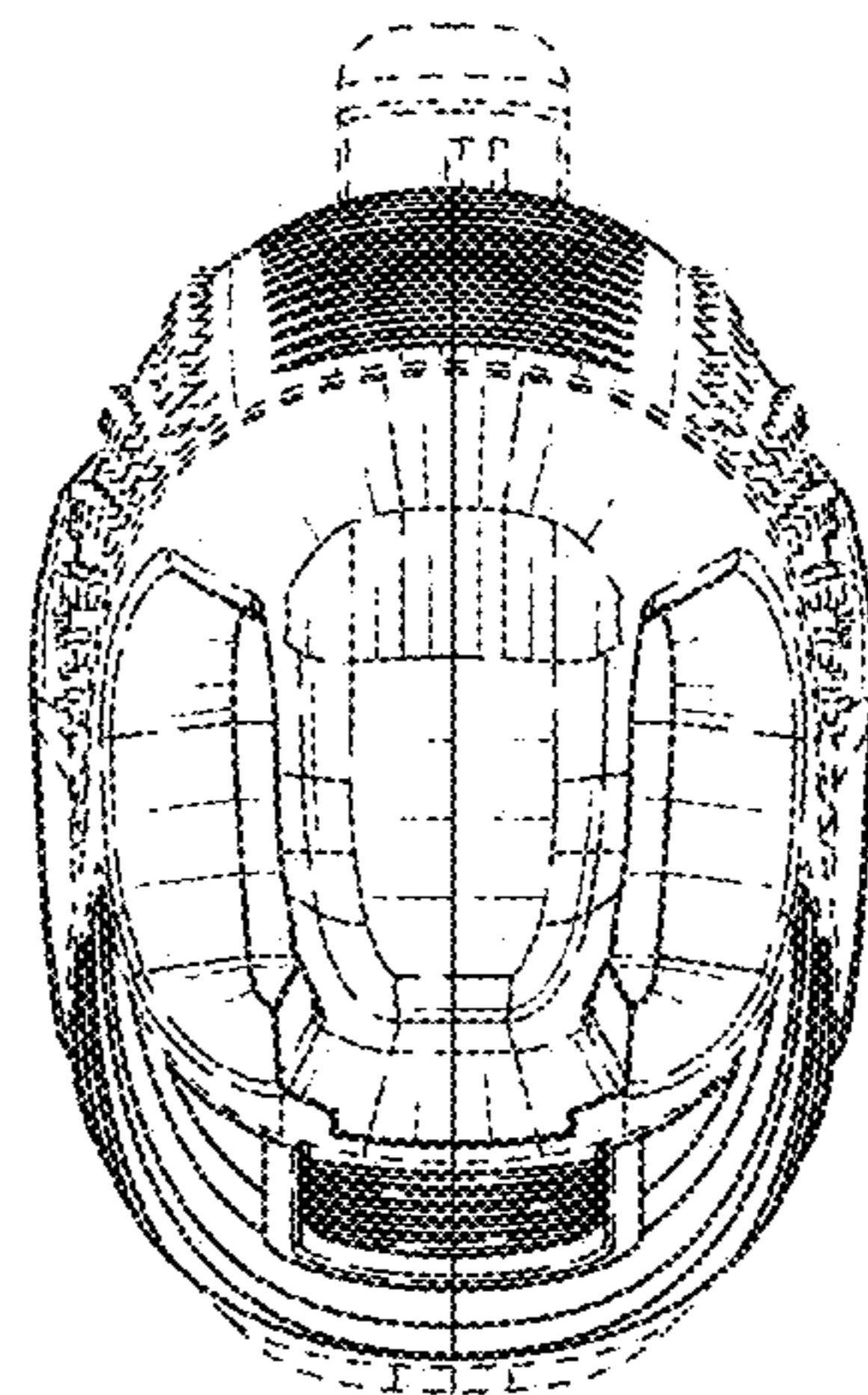

FIG. 3

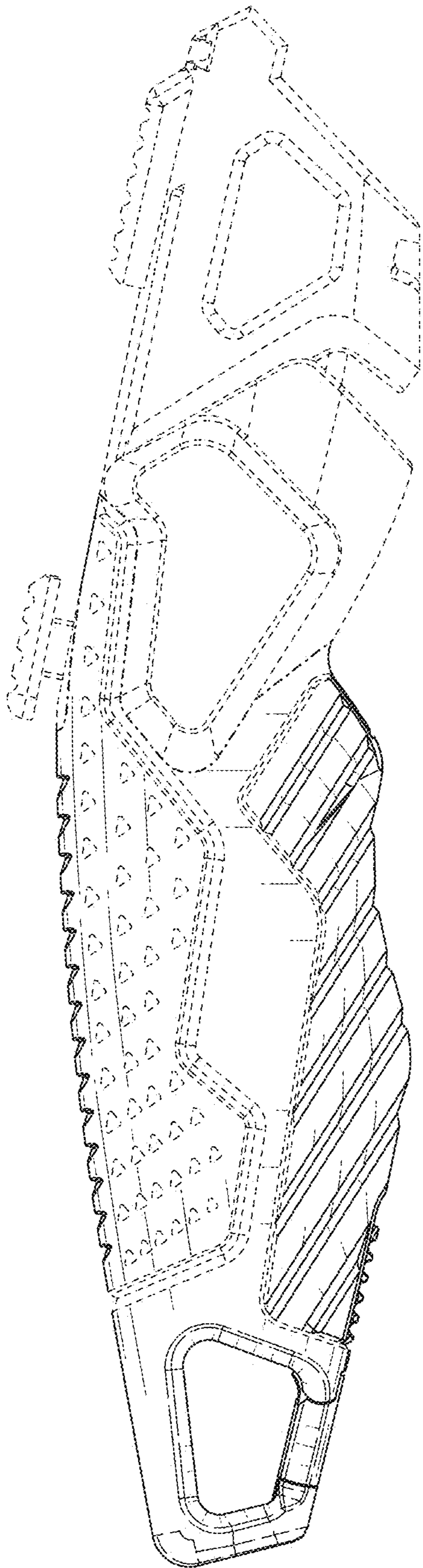

FIG. 4

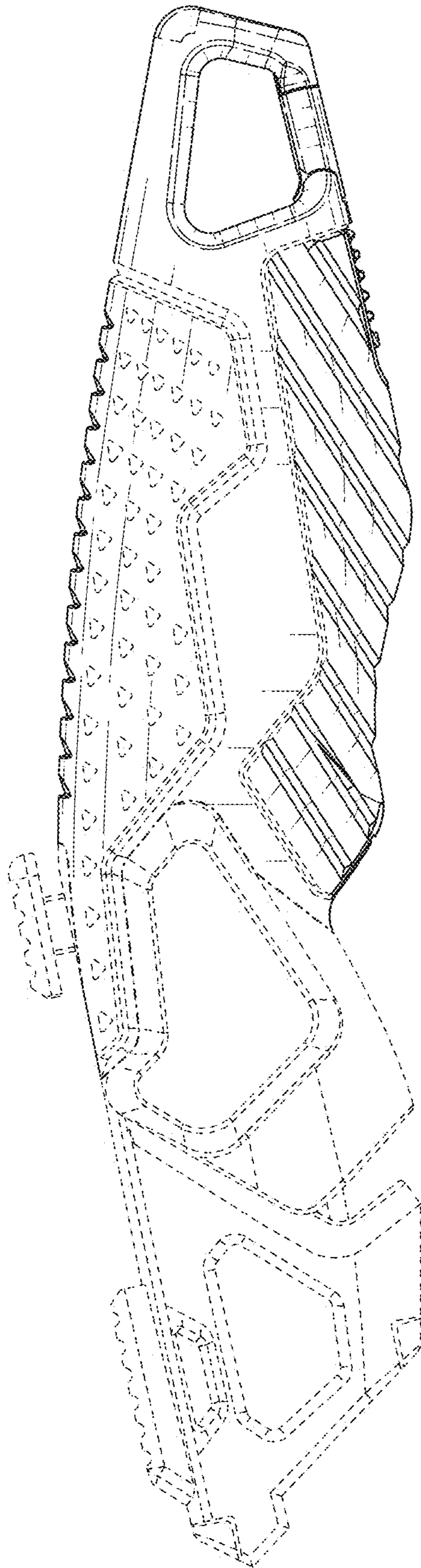

FIG. 5

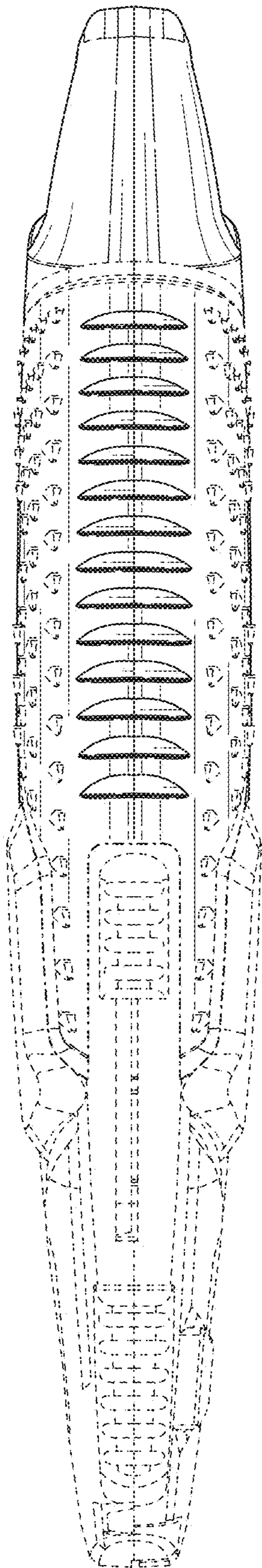

FIG. 6

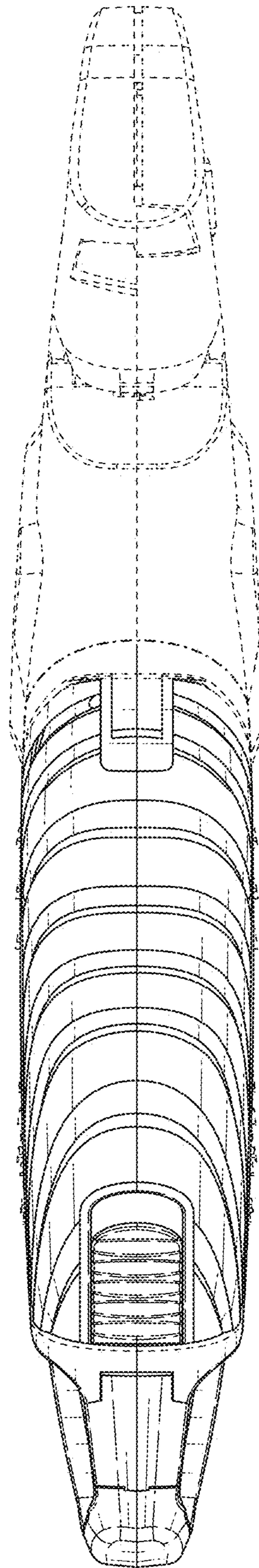

FIG. 7