



US0D1048366S

(12) **United States Design Patent** (10) **Patent No.:** **US D1,048,366 S**
Ye (45) **Date of Patent:** **** Oct. 22, 2024**

(54) **PORTABLE TOILET**
(71) Applicant: **Y&S INTERNATIONAL ONLINE RETAILER CORP.**, Orlando, FL (US)
(72) Inventor: **Jianqi Ye**, Orlando, FL (US)
(73) Assignee: **Y&S INTERNATIONAL ONLINE RETAILER CORP.**, Orlando, FL (US)
(**) Term: **15 Years**
(21) Appl. No.: **29/877,596**
(22) Filed: **Jun. 8, 2023**
(51) **LOC (14) Cl.** **23-03**
(52) **U.S. Cl.**
USPC **D23/395**
(58) **Field of Classification Search**
USPC D23/296, 299–298, 309, 311–313
CPC A47K 11/06; A47K 13/06; A47K 11/00
See application file for complete search history.

(56) **References Cited**
U.S. PATENT DOCUMENTS
3,142,847 A * 8/1964 Kurrels A47K 11/02
206/517
5,611,092 A * 3/1997 Van Dusen A47K 11/06
4/484
6,061,845 A * 5/2000 Kakutani A47K 11/02
4/483
D532,492 S * 11/2006 Giese D23/299
9,364,124 B2 * 6/2016 Morris A47K 11/026
D918,353 S * 5/2021 Xu D23/296
D960,334 S * 8/2022 Pan D23/299
D967,359 S 10/2022 Liu
D989,247 S * 6/2023 Yang D23/296
D995,730 S * 8/2023 Deng D23/299

D997,313 S * 8/2023 Hou D23/299
2011/0258767 A1 * 10/2011 Lok A47K 11/06
4/483
2023/0007955 A1 * 1/2023 Kumagai A47K 11/04

OTHER PUBLICATIONS

Foldable Potty, Portable Potty Seat For Toddler in Travel , Kids boys&Girls Training Toilet Seat, In Urgent Toilet, Moblie toilet in Car, For Camping, Outdoor, Indoor, review date: Apr. 30, 2023; https://www.amazon.com/Foldable-Portable-Toddler-Travel%EF%BC%8CKids-Training/dp/B0BZD5FZ7S/ref=cm_cr_ar_p (Year: 2023).*

* cited by examiner

Primary Examiner — George J Ulsh
Assistant Examiner — Andrea Marie McKay
(74) *Attorney, Agent, or Firm* — Nitin Kaushik

(57) **CLAIM**
The ornamental design for a portable toilet, as shown and described.

DESCRIPTION

FIG. 1 is a front perspective view of a portable toilet, showing my new design;
FIG. 2 is a front view thereof;
FIG. 3 is a rear view thereof;
FIG. 4 is a left side view thereof;
FIG. 5 is a right side view thereof;
FIG. 6 is a top view thereof;
FIG. 7 is a bottom view thereof;
FIG. 8 is a perspective view of the portable toilet shown in FIG. 1 in a disassembled and compacted configuration; and,
FIG. 9 is a front perspective view of the portable toilet shown in FIG. 1 in an open configuration.
The broken lines in the drawings illustrate the portions of the portable toilet, which form no part of the claimed design.

1 Claim, 9 Drawing Sheets

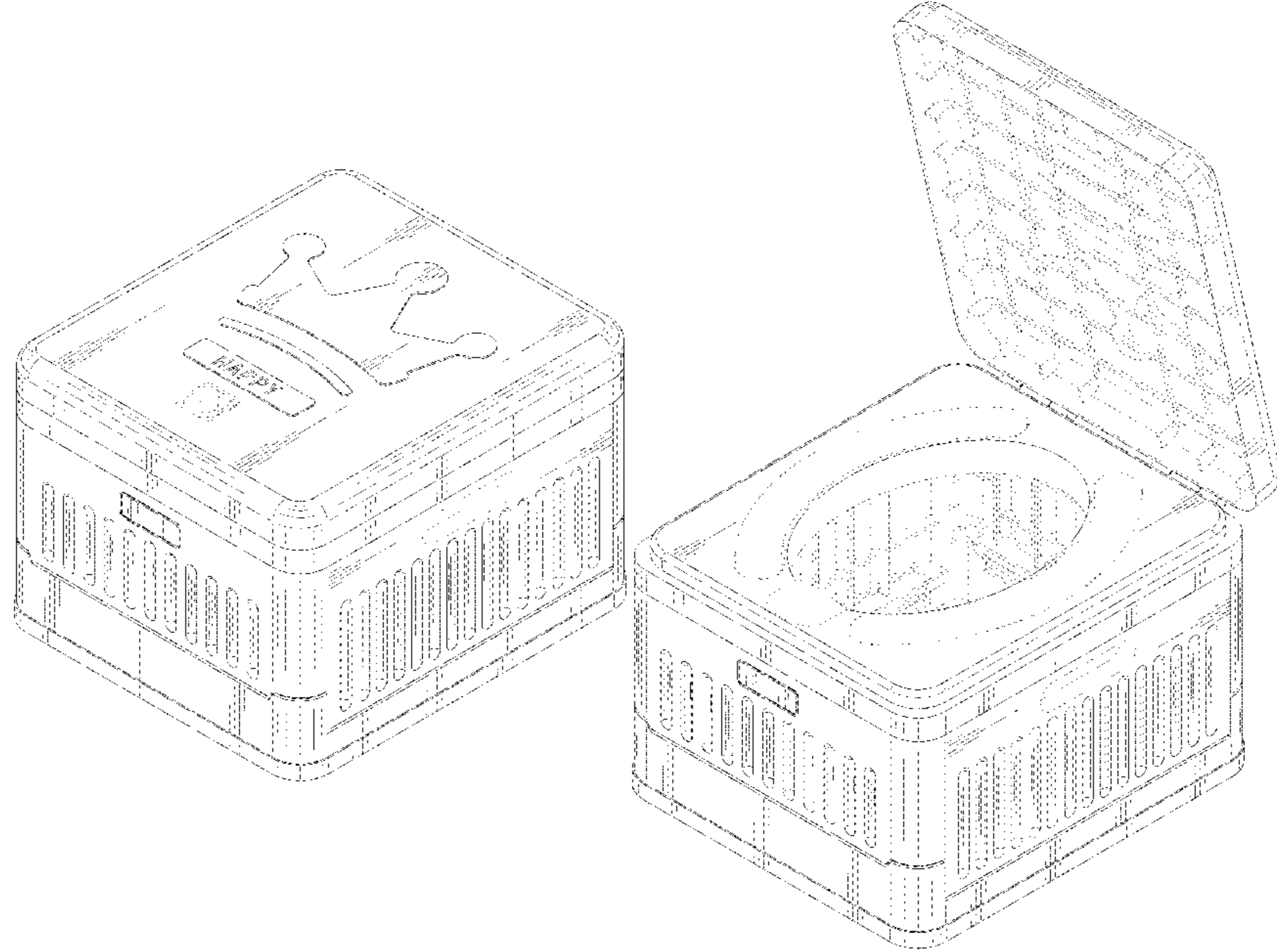

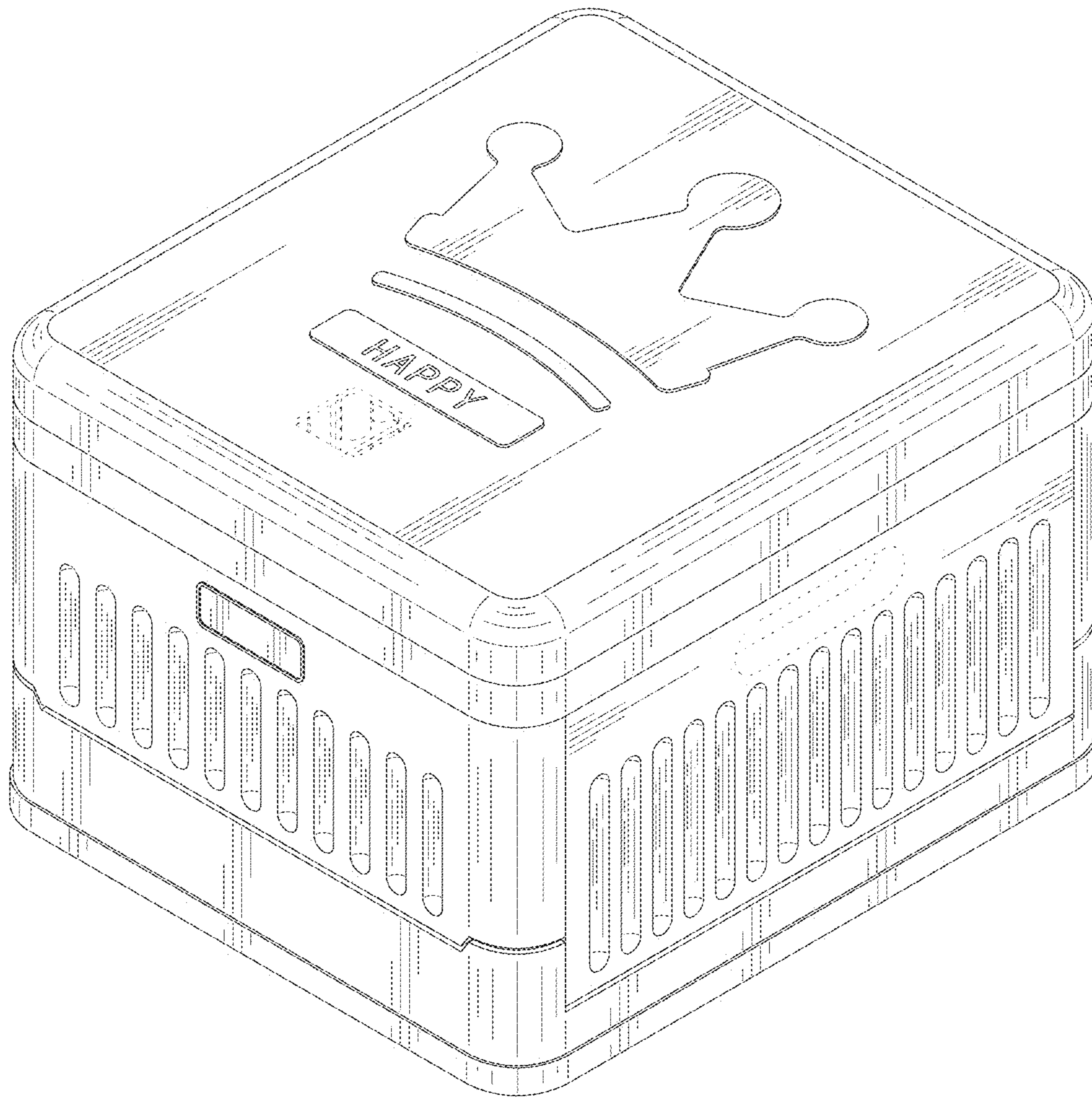

FIG. 1

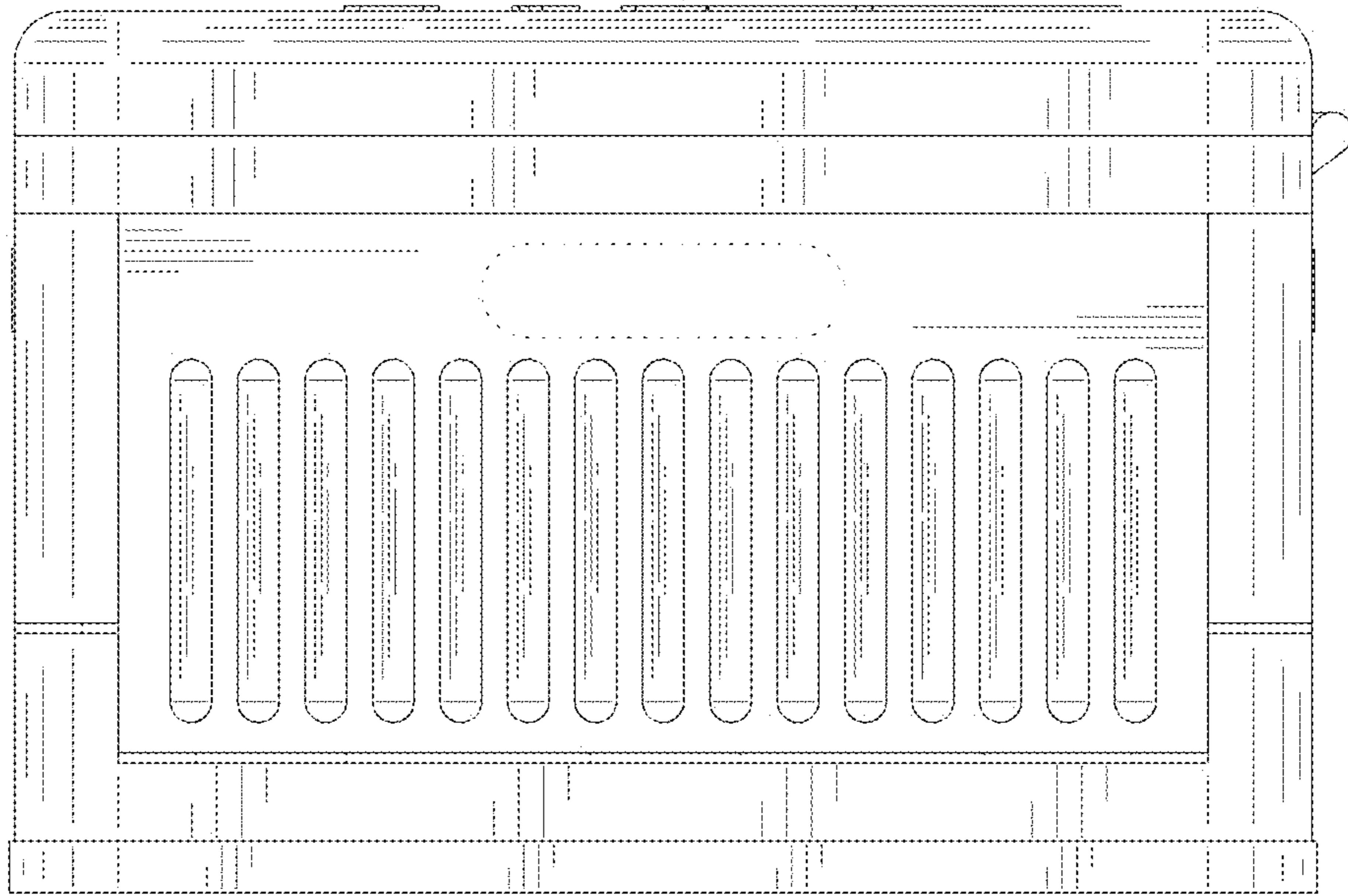

FIG. 2

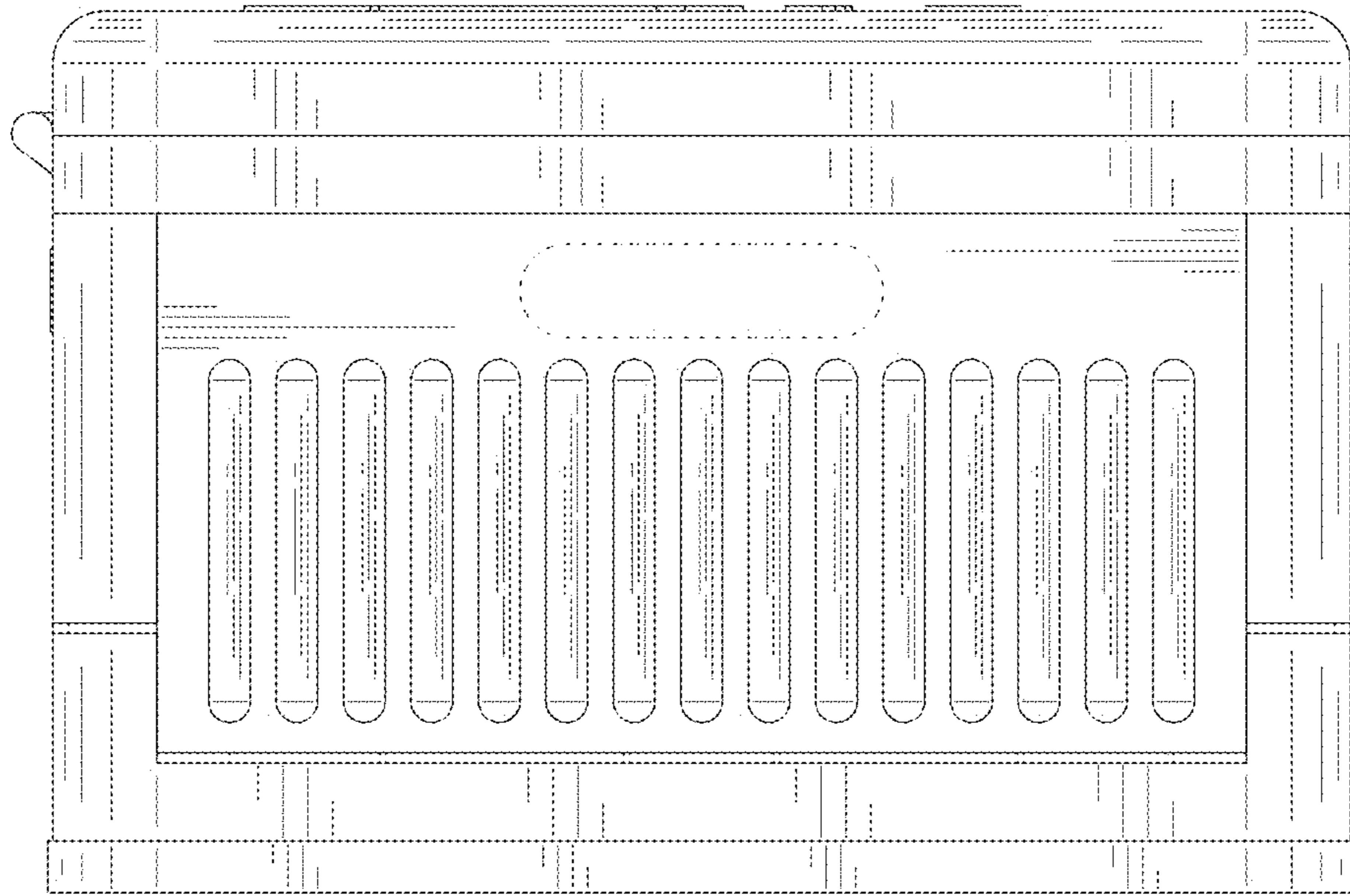

FIG. 3

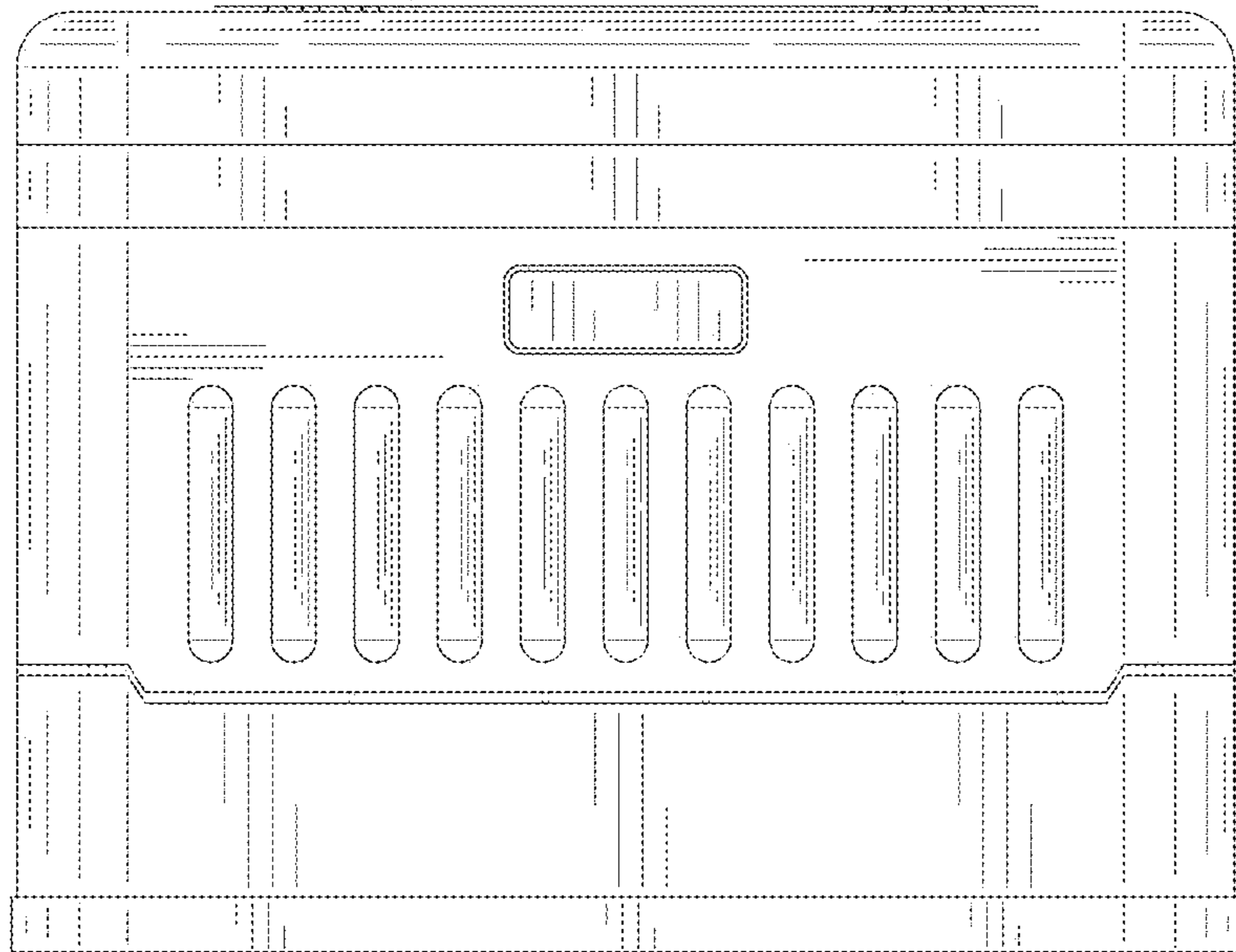

FIG. 4

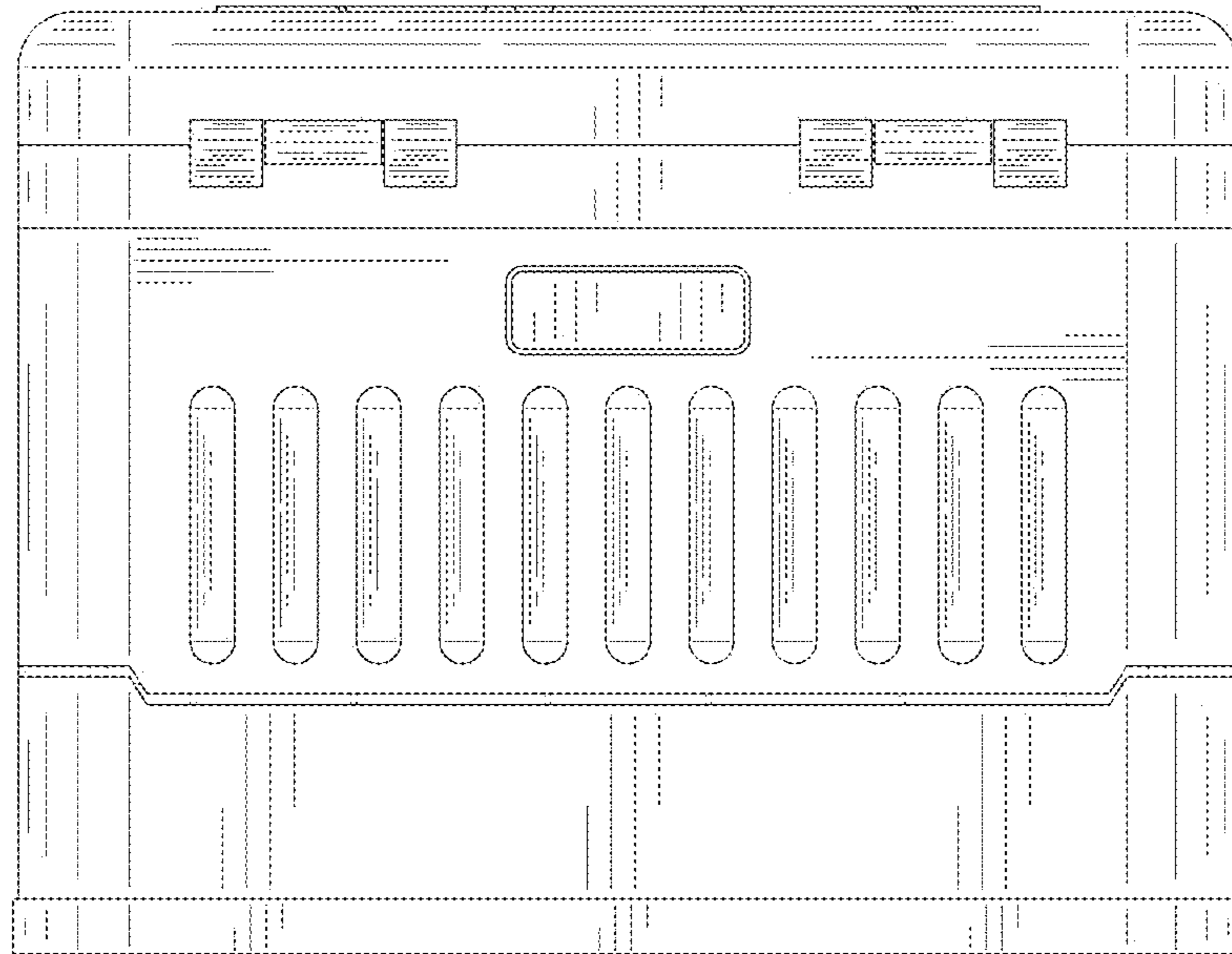

FIG. 5

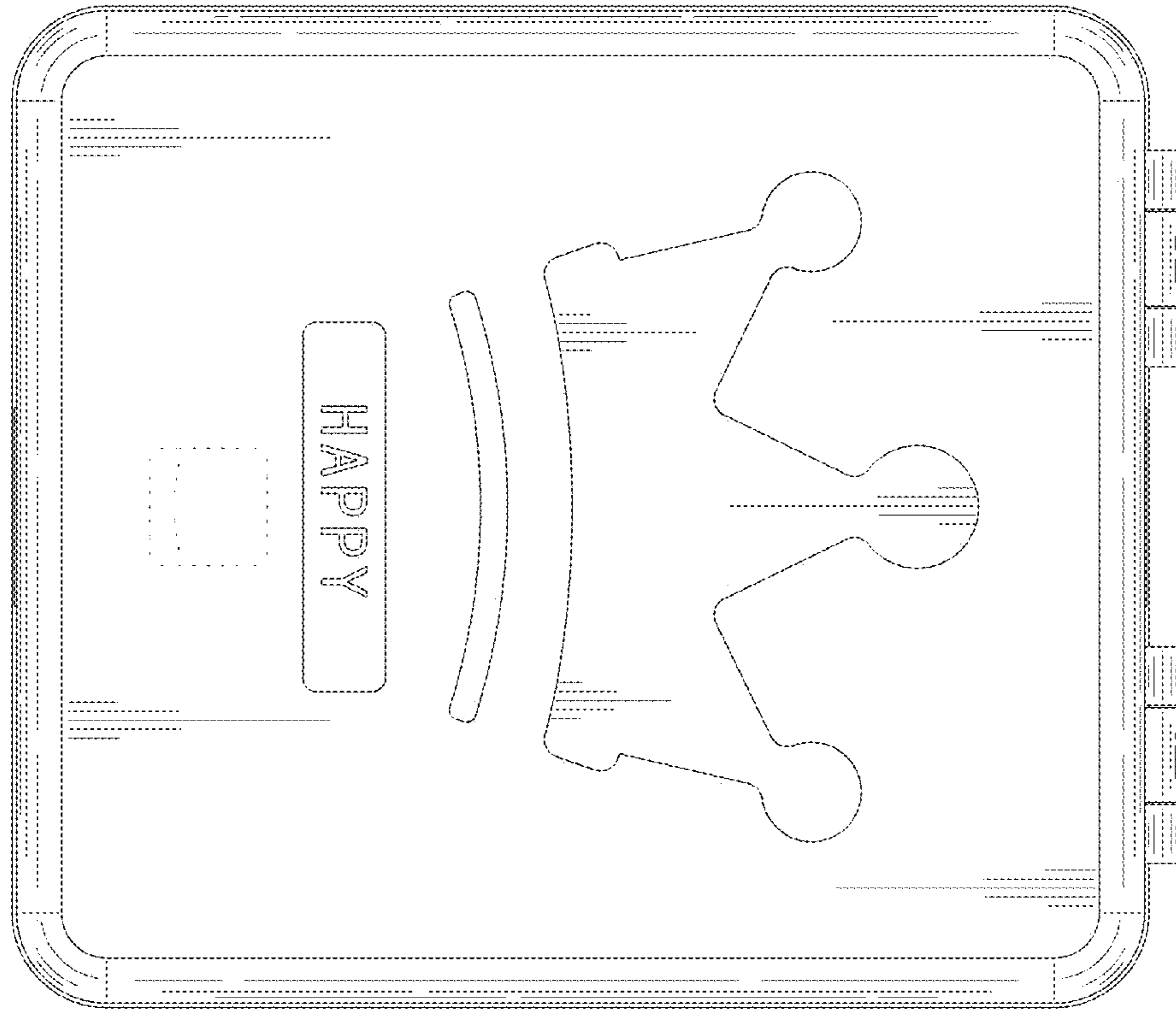

FIG. 6

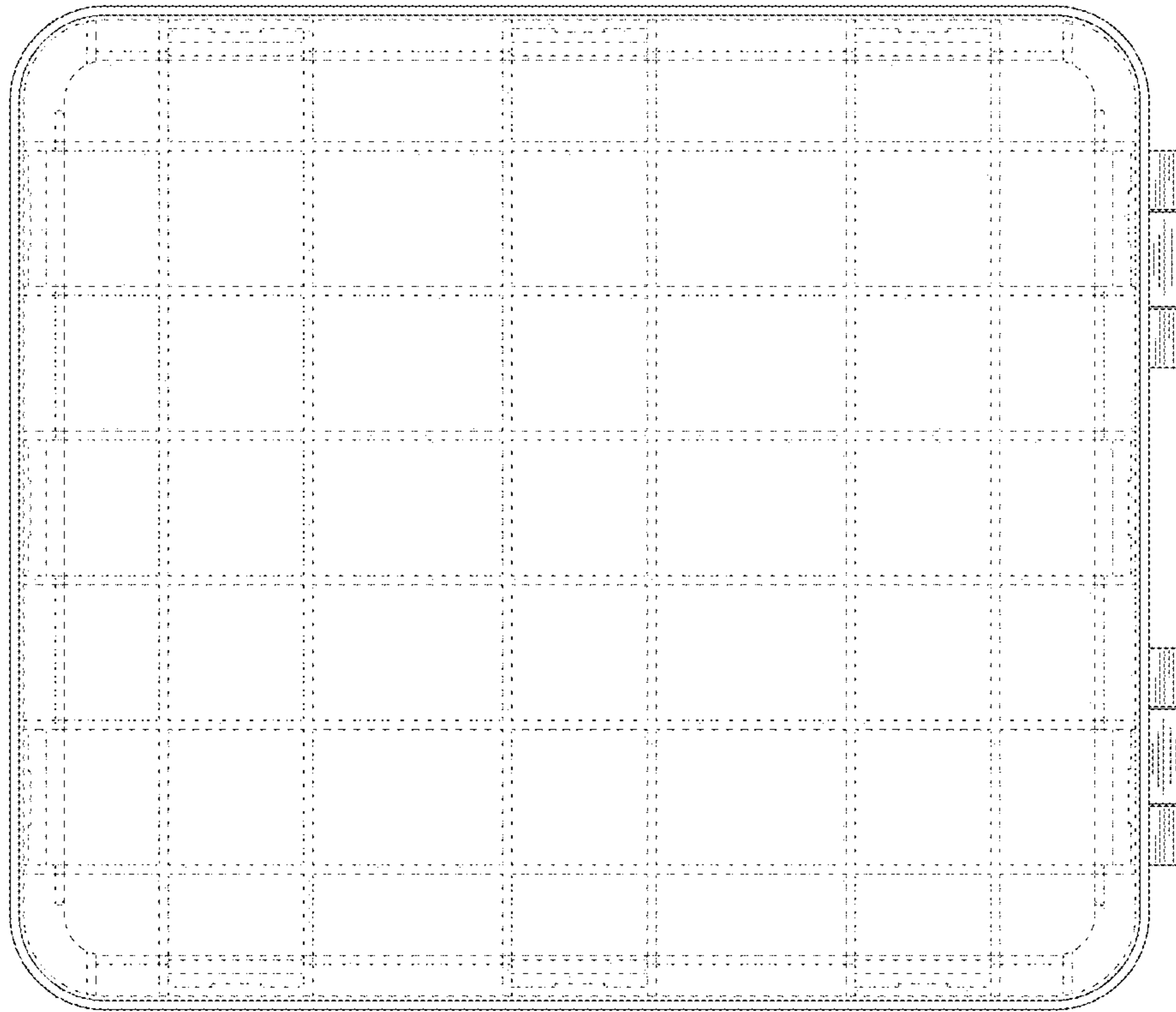

FIG. 7

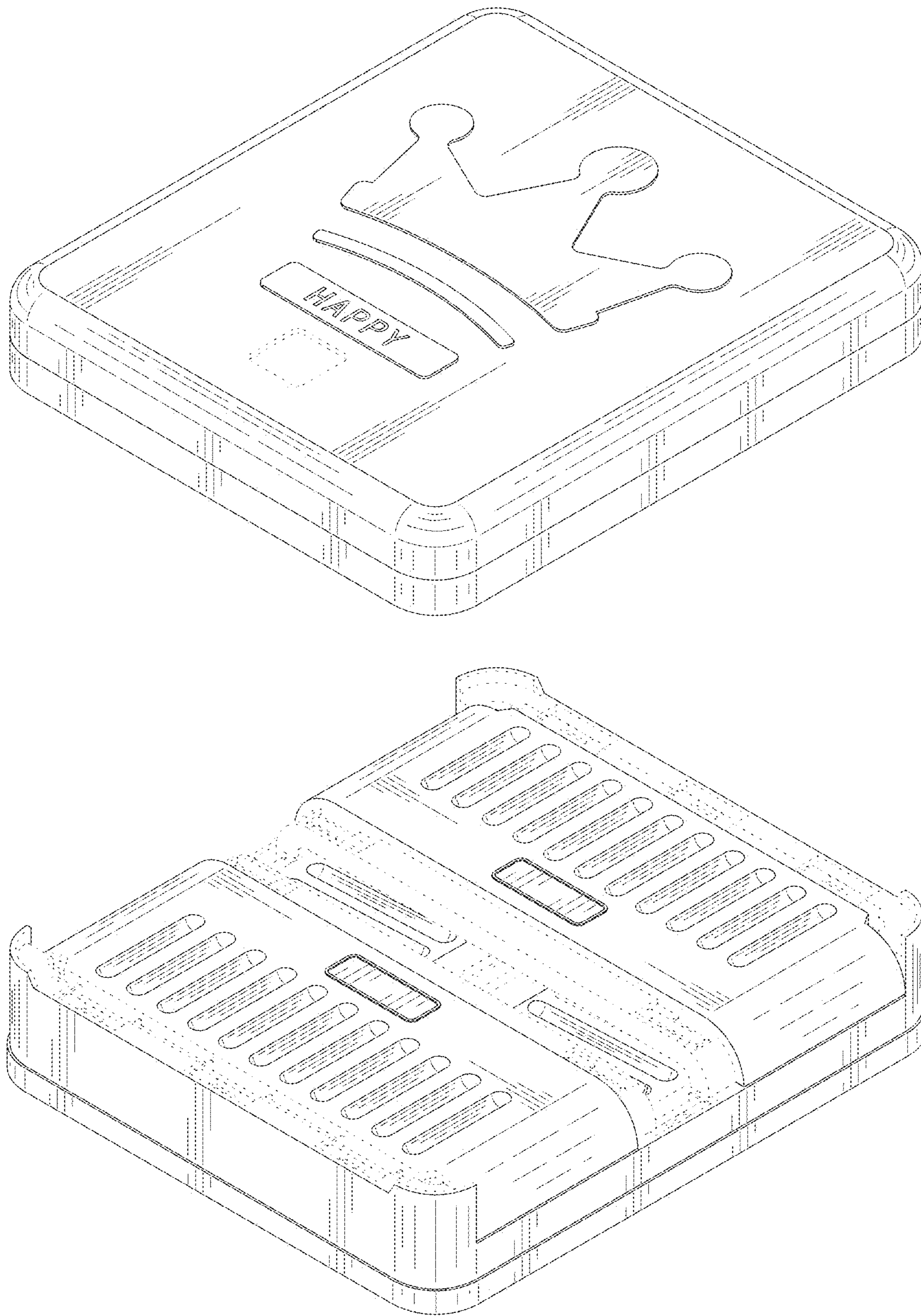

FIG. 8

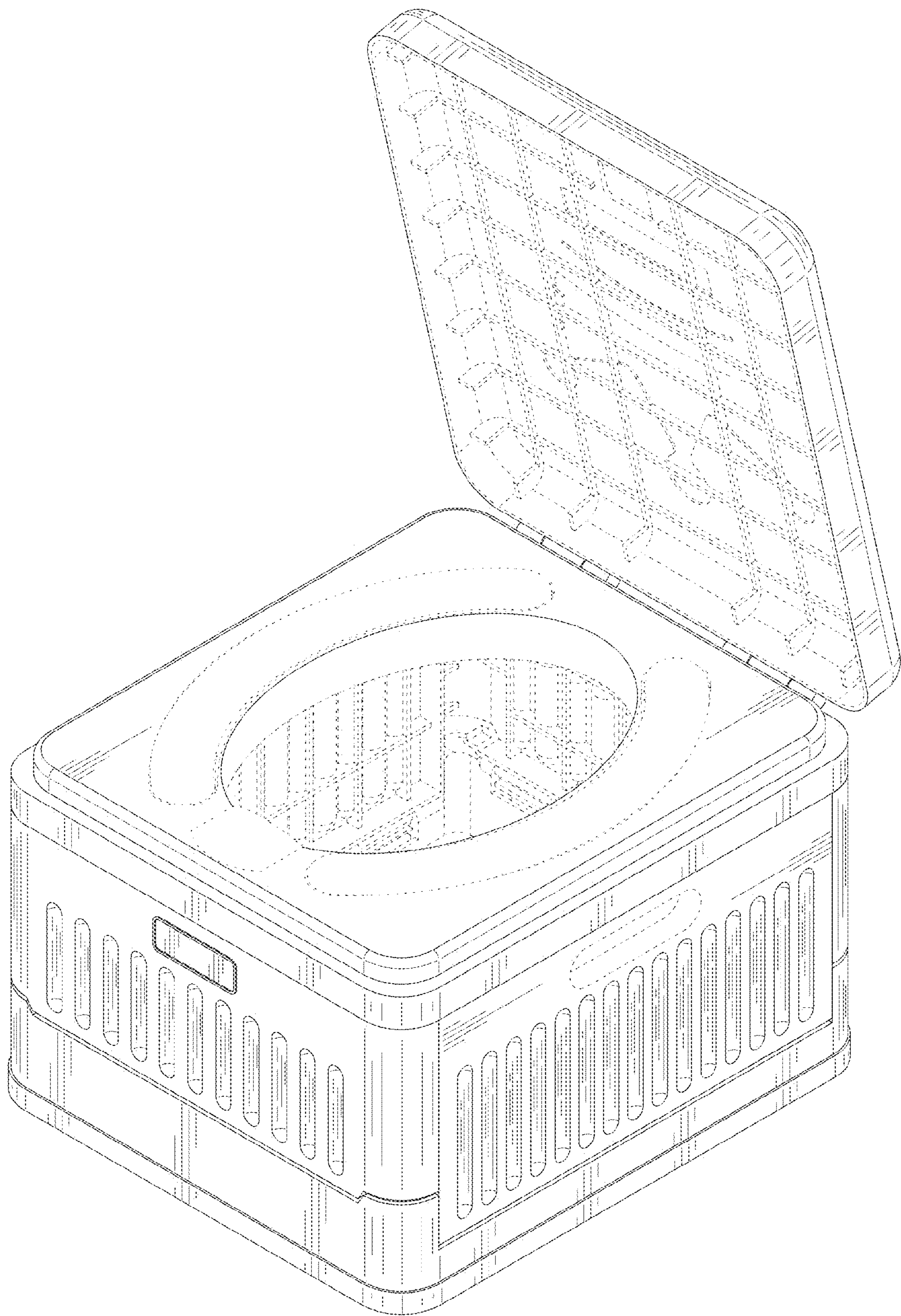

FIG. 9