



US0D1047748S

(12) **United States Design Patent** (10) **Patent No.:** **US D1,047,748 S**
Silvestri (45) **Date of Patent:** **** Oct. 22, 2024**

(54) **EARRING**
(71) Applicant: **Bulgari S.p.A.**, Rome (IT)
(72) Inventor: **Lucia Silvestri**, Rome (IT)
(73) Assignee: **Bulgari S.p.A.**, Rome (IT)
(**) Term: **15 Years**
(21) Appl. No.: **29/804,533**
(22) Filed: **Aug. 20, 2021**

D322,230 S * 12/1991 Hawkins D11/15
D338,629 S * 8/1993 Bulgari D11/5
D339,082 S * 9/1993 Bulgari D11/4
D445,717 S * 7/2001 Haquet D11/27
D549,607 S * 8/2007 Mouclier D11/67
(Continued)

(30) **Foreign Application Priority Data**

Feb. 25, 2021 (WO) WIPO101908

(51) **LOC (14) Cl.** **11-01**
(52) **U.S. Cl.**

USPC **D11/42**

(58) **Field of Classification Search**

USPC D11/1-3, 40-43, 45, 47, 75-79, 86-91,
D11/93

CPC .. A44C 1/00; A44C 7/00; A44C 7/002; A44C
7/003; A44C 7/004; A44C 7/005; A44C
7/006; A44C 15/00; A44C 17/02; A44C
17/046; A44C 25/00; A44C 25/001; A44C
25/007; A44C 27/00; A44C 5/02; A44C
5/0007; A44C 5/0015; A44C 7/007; A44C
7/008; A44B 9/16; Y10T 29/23; Y10T
29/4959

See application file for complete search history.

(56) **References Cited**

U.S. PATENT DOCUMENTS

434,302 A * 8/1890 Senner A44C 5/08
63/38
D146,851 S * 6/1947 Chernow D11/40
D165,606 S * 1/1952 Parisi D11/12
4,187,696 A * 2/1980 van Bergen A44C 7/006
63/14.4
D308,349 S * 6/1990 Bulgari D11/42

FOREIGN PATENT DOCUMENTS

JP D1641500 * 9/2019
RU 00074448 * 4/2010

OTHER PUBLICATIONS

A touch of eternity. Online [website]. Instagram, posted online by user @bulgari on May 22, 2021, [retrieved on May 5, 2023]. Retrieved from the internet: <<https://www.instagram.com/p/CPLfOaSoBdc/?hl=en>>. (Year: 2021).*

(Continued)

Primary Examiner — Amy C Wierenga

Assistant Examiner — Grace Doyle

(74) *Attorney, Agent, or Firm* — Stephen J. Kenny; Foley Hoag LLP

(57) **CLAIM**

The ornamental design for an earring as shown and described.

DESCRIPTION

FIG. 1 is a perspective view of the earring showing my new design.

FIG. 2 is a front view thereof.

FIG. 3 is a back view thereof.

FIG. 4 is a left side view thereof.

FIG. 5 is a right side view thereof.

FIG. 6 is a top view thereof; and,

FIG. 7 is a bottom view thereof.

The portions of the earring shown in broken lines form no part of the claimed design.

1 Claim, 7 Drawing Sheets

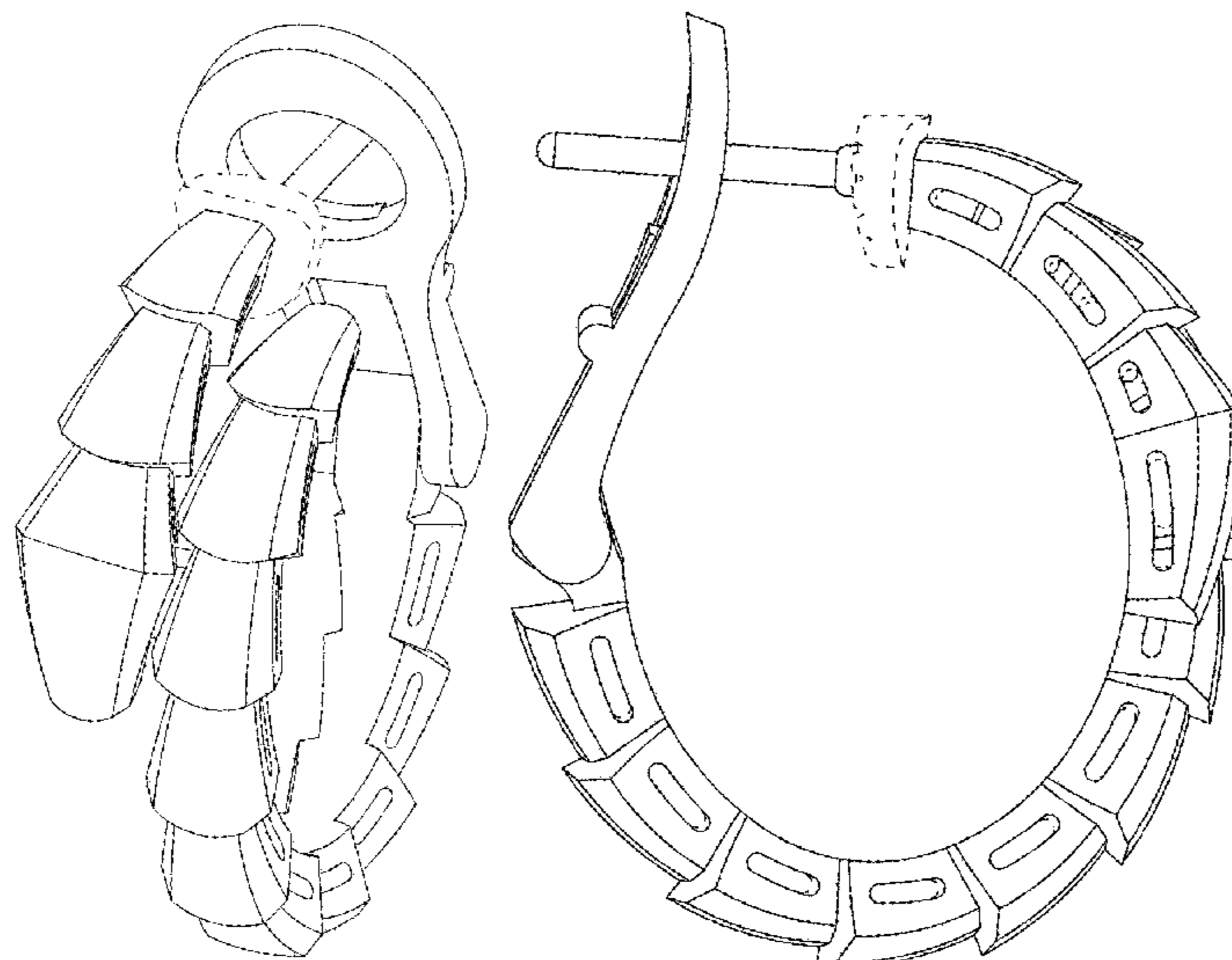

(56)

References Cited

U.S. PATENT DOCUMENTS

D606,886 S * 12/2009 Bulgari A44C 7/006
D10/34
D606,894 S * 12/2009 Bulgari D11/5
D780,035 S * 2/2017 Bulgari D11/42
D937,116 S * 11/2021 Silvestri D11/40
D1,009,684 S * 1/2024 Traglio D11/42

OTHER PUBLICATIONS

Bulgari. Online [website]. Facebook, posted online by user “COT & Partners” on Oct. 18, 2021, [retrieved on May 5, 2023]. Retrieved from the internet: <<https://www.facebook.com/photo/?fbid=375763584249315&set=a.138713821287627>>. (Year: 2021).*

Serpenti Viper Earrings. Online [website]. Bulgari, publication date unknown, [retrieved on May 5, 2023]. Retrieved from the internet: <<https://www.bulgari.com/en-us/jewelry/earrings/serpenti-viper-earrings-rose-gold-pink-358361>>. (Year: 2023).*

* cited by examiner

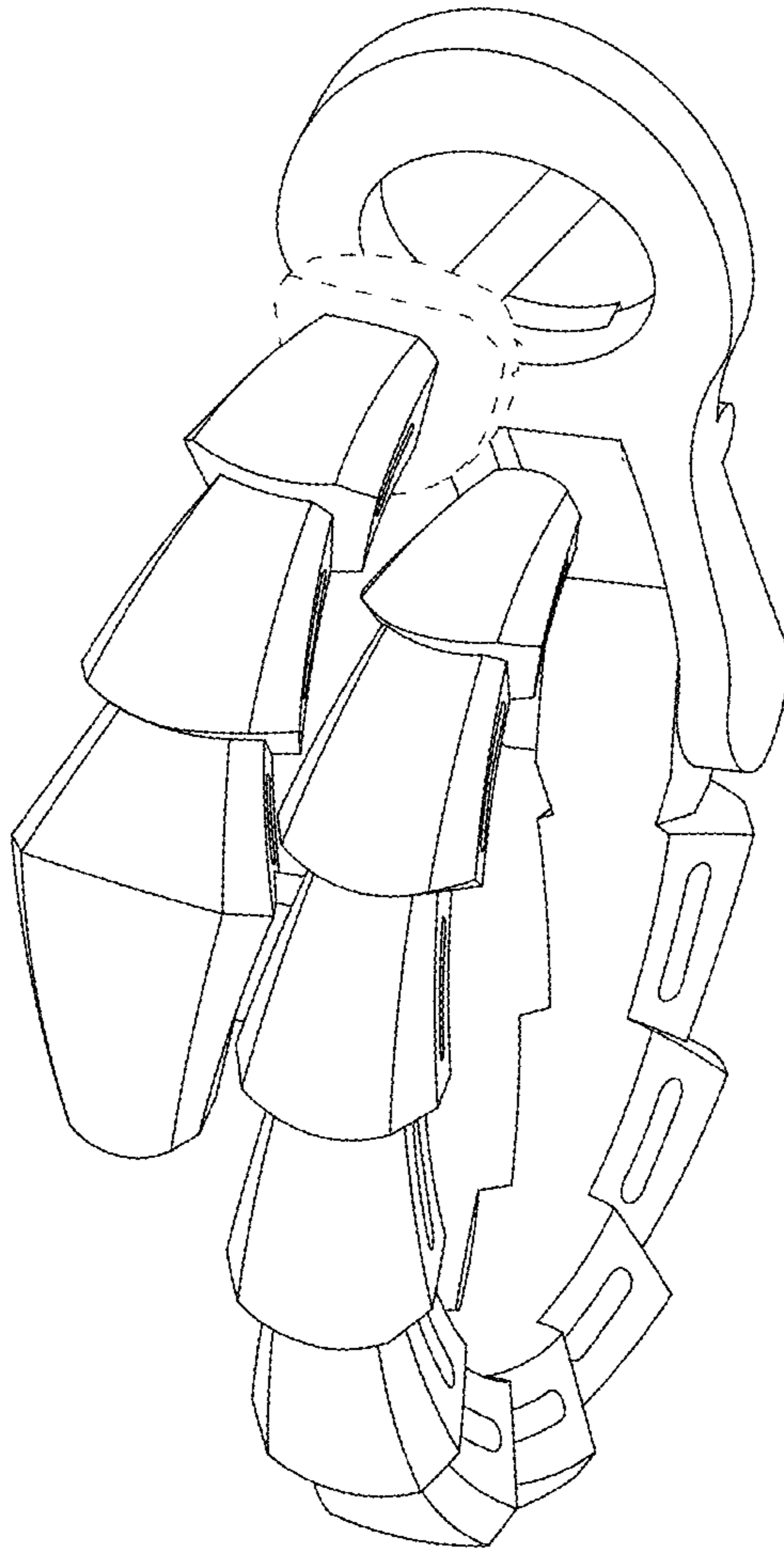

FIG. 1

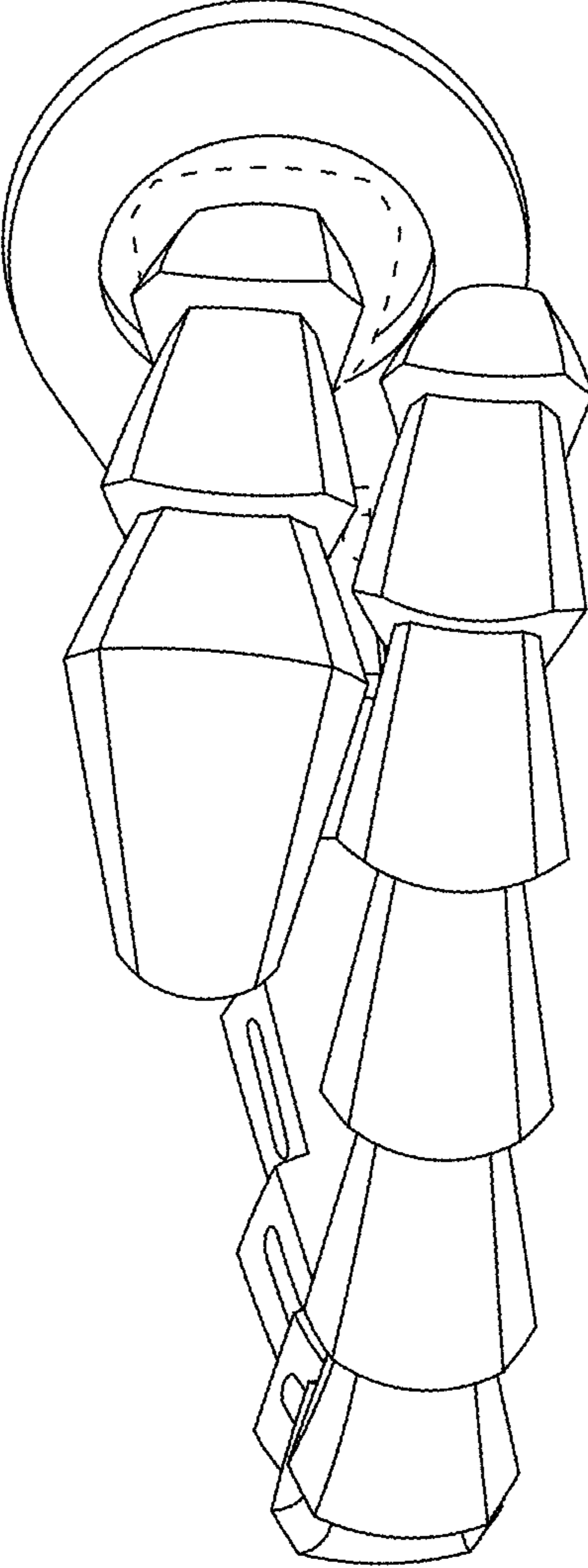

FIG. 2

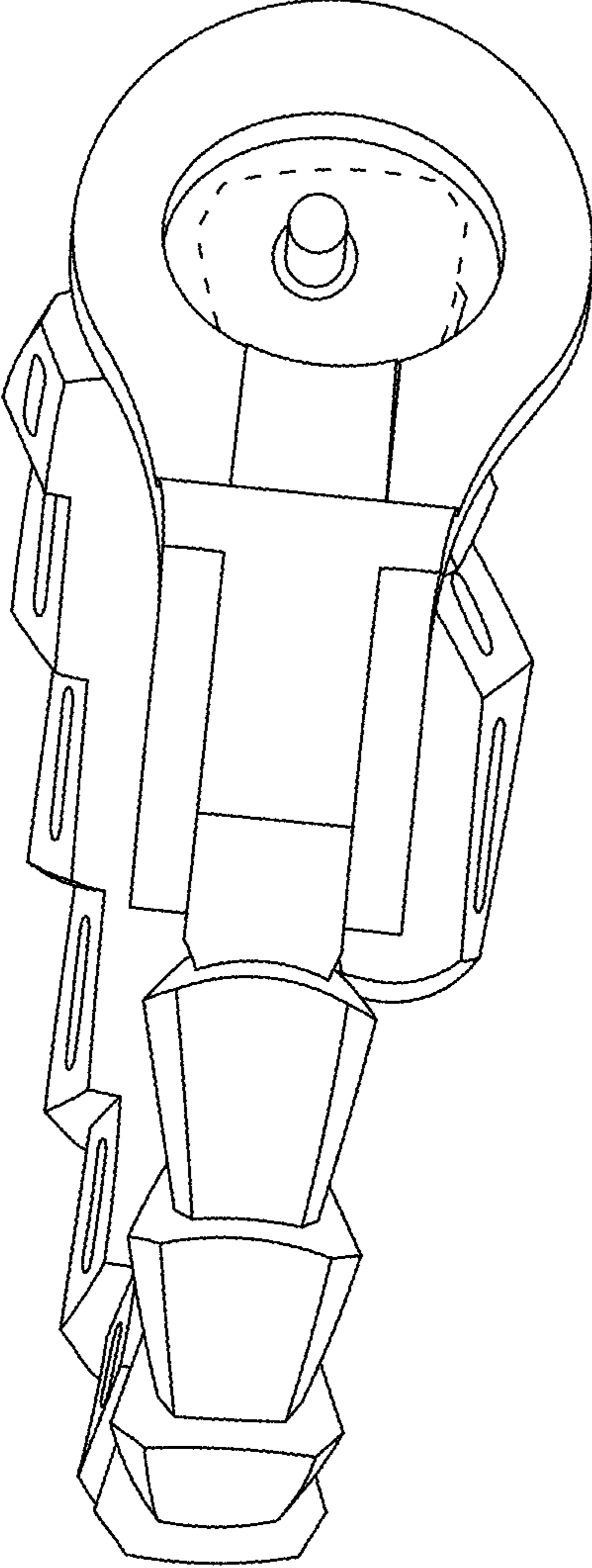

FIG. 3

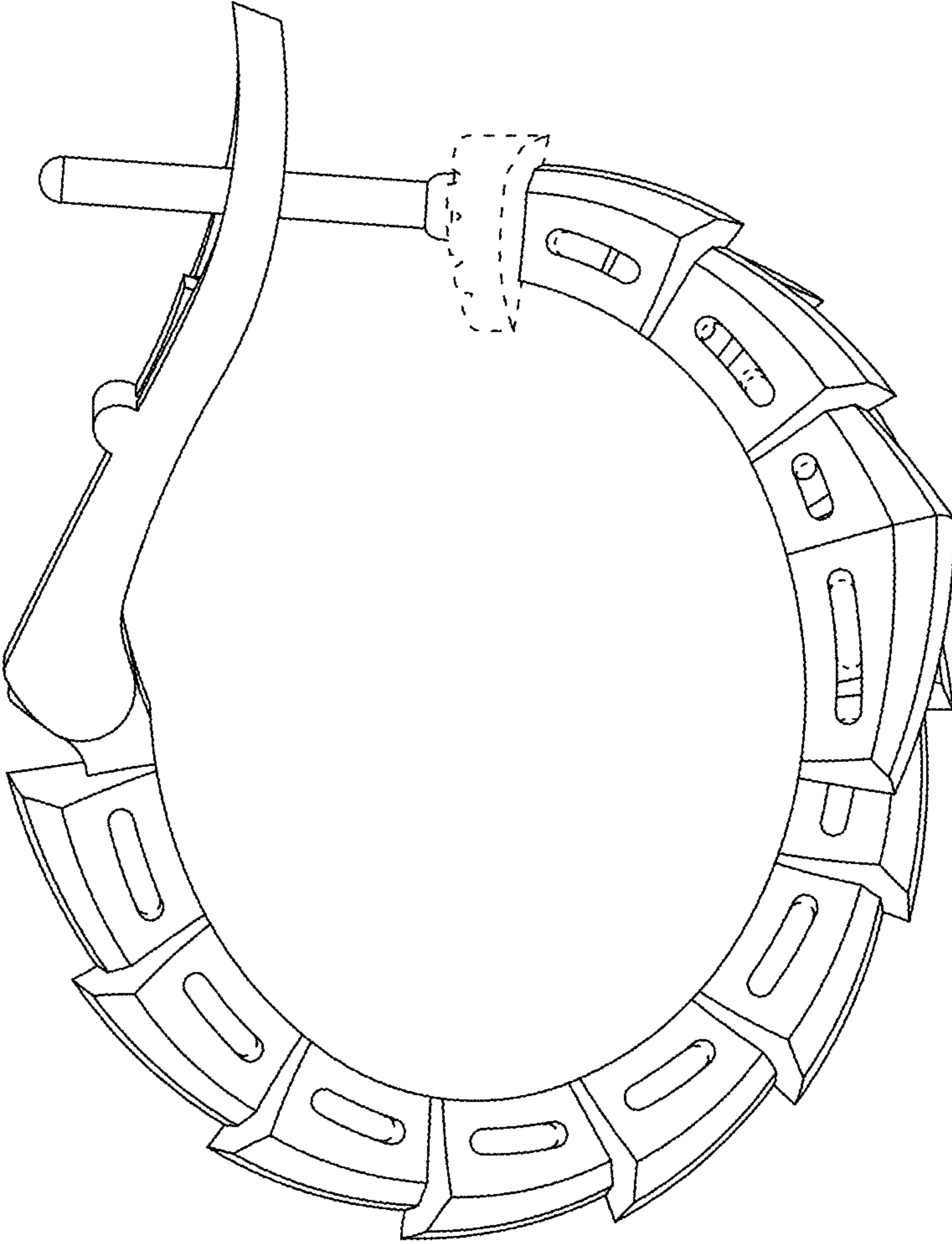

FIG. 4

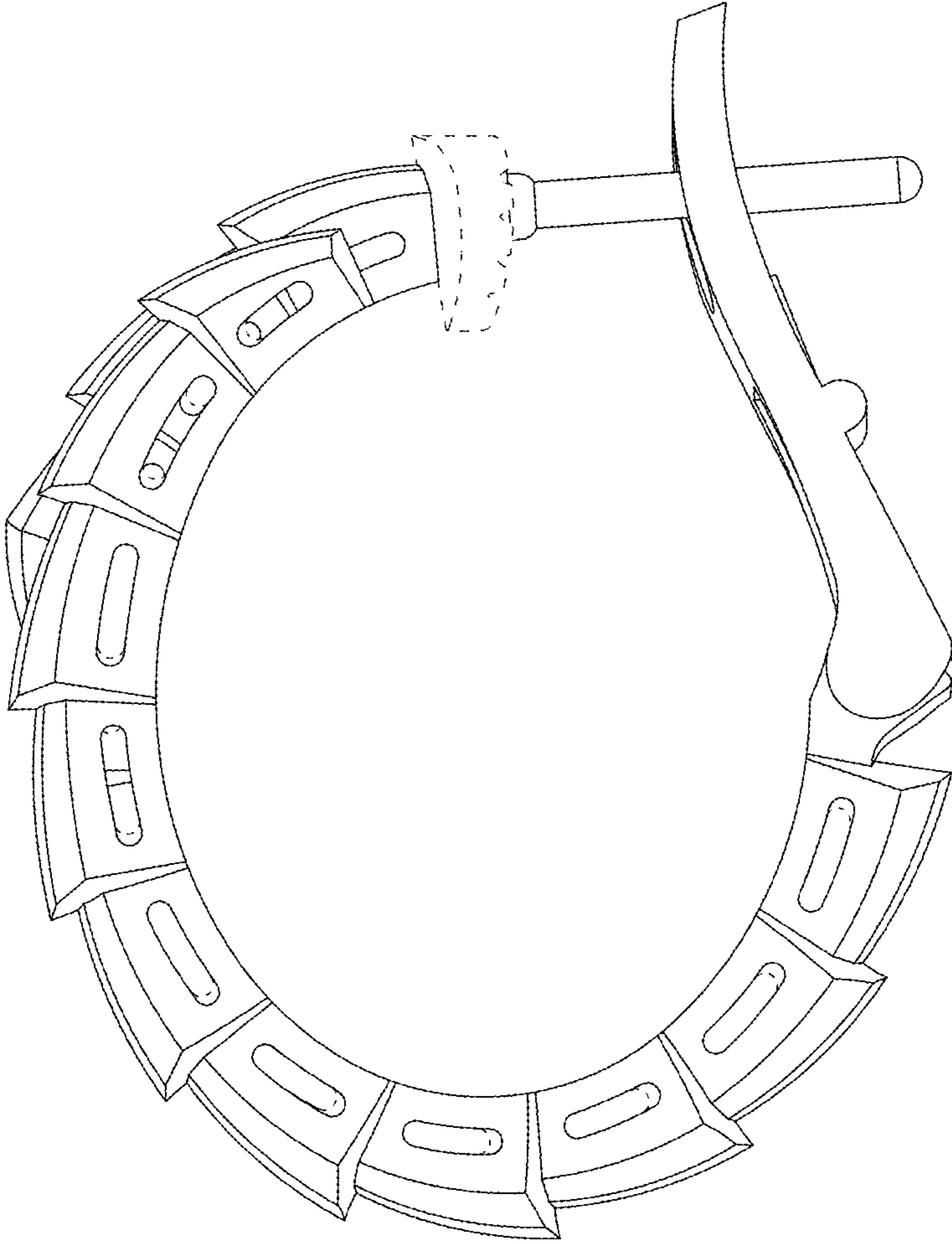

FIG. 5

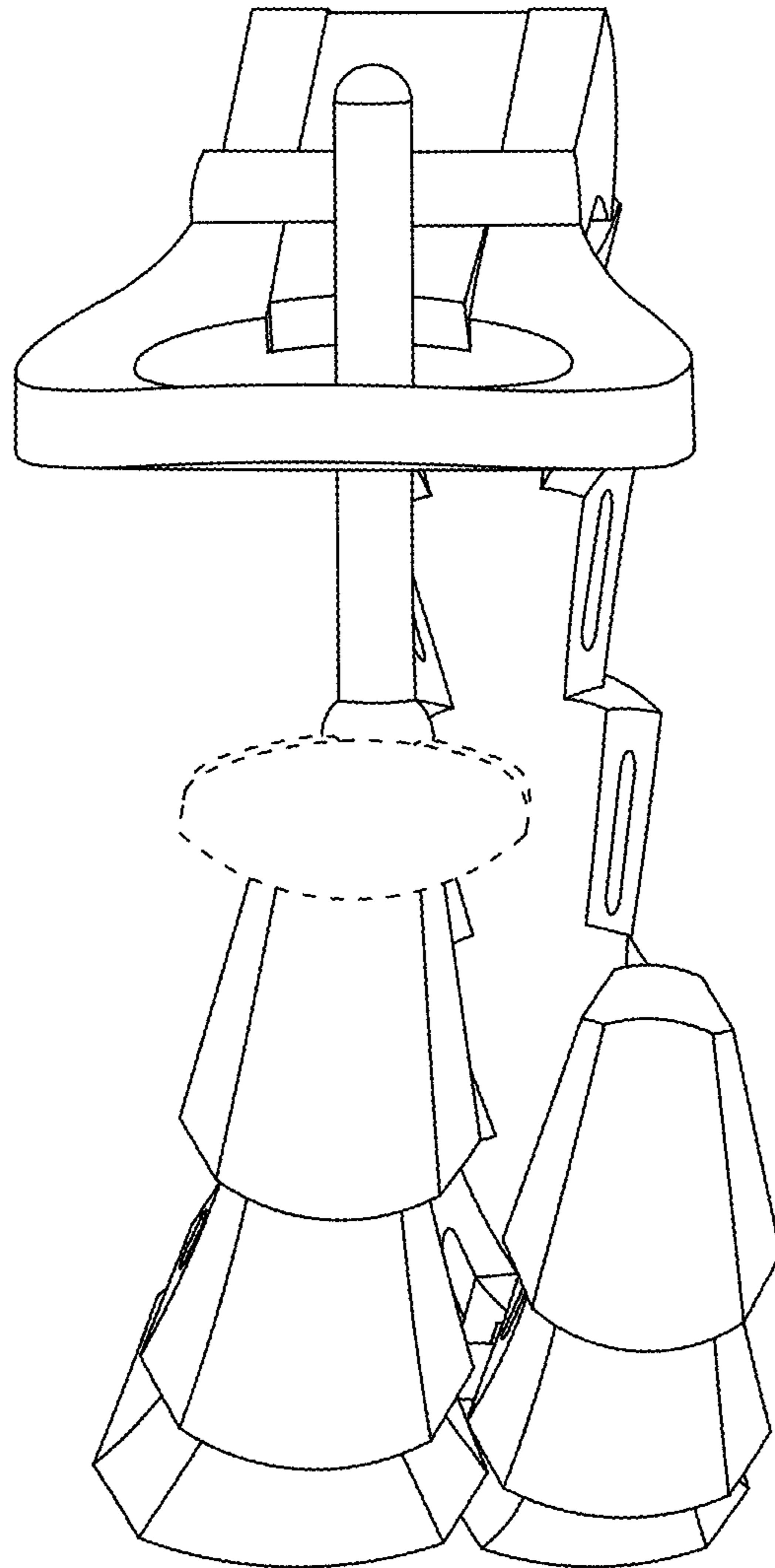

FIG. 6

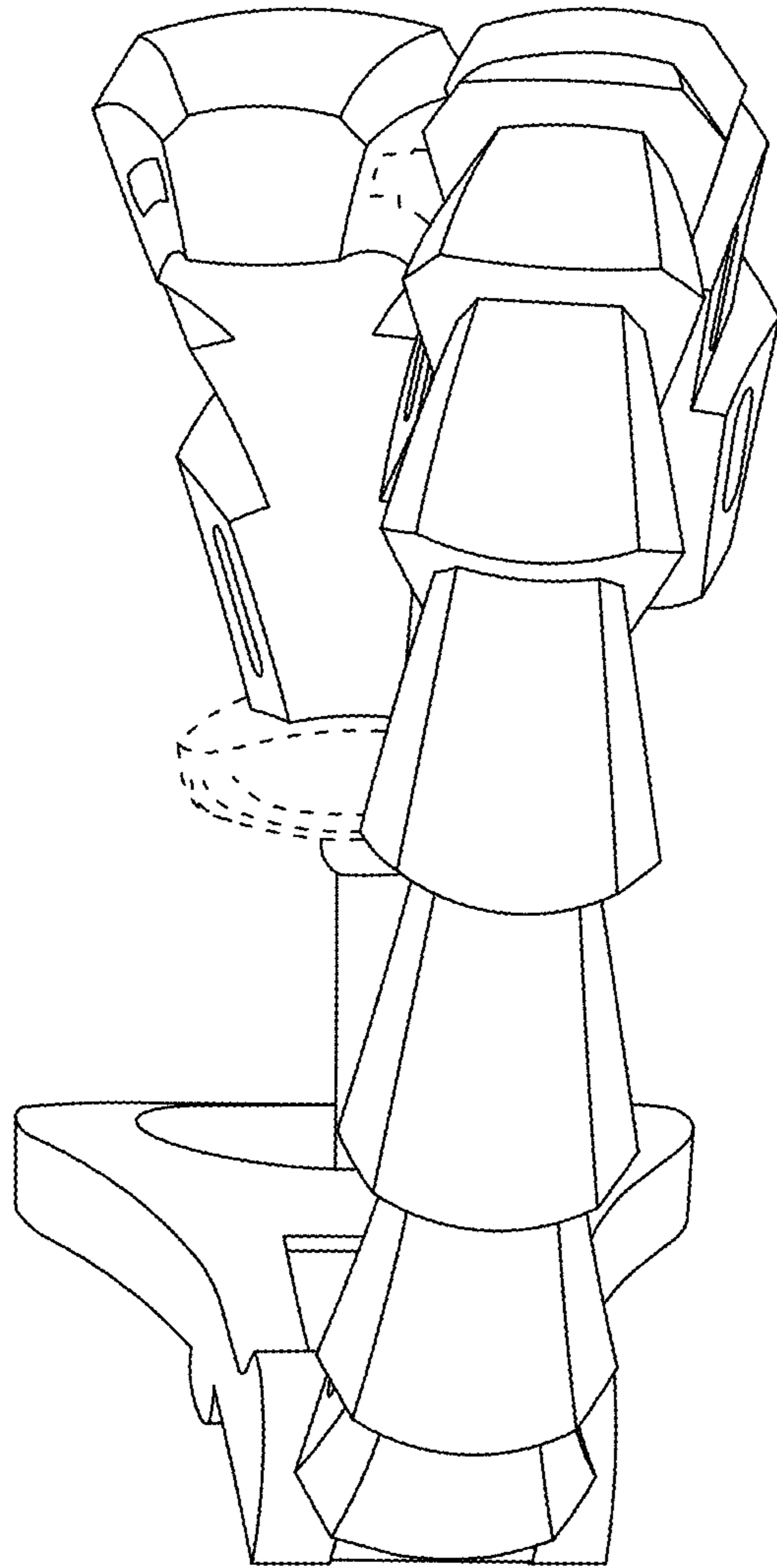

FIG. 7