



US0D1046588S

(12) **United States Design Patent** (10) **Patent No.:** **US D1,046,588 S**
Painter et al. (45) **Date of Patent:** **** Oct. 15, 2024**

(54) **UTILITY KNIFE**

OTHER PUBLICATIONS

(71) Applicant: **Instant Brands Holdings Inc.**,
Downers Grove, IL (US)

Walt Folding Utility Knife <https://www.agrisales-inc.com/dewalt-dwht10035-folding-utility-knife>, available as early as Aug. 29, 2022, 3 pgs.

(Continued)

(72) Inventors: **Michael Joseph Painter**, Johnstown, OH (US); **Eric James Fickas**, Plain City, OH (US); **Tania Louise Aldous**, Niles, IL (US)

Primary Examiner — Philip S Hyder

(74) *Attorney, Agent, or Firm* — TUCKER ELLIS LLP

(73) Assignee: **INSTANT BRANDS HOLDINGS INC.**, Downers Grove, IL (US)

(57) **CLAIM**

The ornamental design for a utility knife, as shown and described.

(**) Term: **15 Years**

DESCRIPTION

(21) Appl. No.: **29/851,589**

FIG. 1 is a top perspective view of a utility knife according to a first embodiment of our new design;

(22) Filed: **Aug. 30, 2022**

FIG. 2 is a left side elevation view of the utility knife of FIG. 1;

(51) **LOC (14) Cl.** **08-03**

FIG. 3 is a right side elevation view of the utility knife of FIG. 1;

(52) **U.S. Cl.**

USPC **D8/99**

FIG. 4 is a front elevation view of the utility knife of FIG. 1;

(58) **Field of Classification Search**

USPC D8/14, 98, 99, 100, 105; D22/118

CPC B26B 1/00; B26B 1/08; B26B 1/10; B26B

5/001; B26B 5/002; B26B 5/003; B26B

5/005; B26B 5/006

See application file for complete search history.

FIG. 5 is a rear elevation view of the utility knife of FIG. 1;

FIG. 6 is a top plan view of the utility knife of FIG. 1;

FIG. 7 is a bottom plan view of the utility knife of FIG. 1;

FIG. 8 is a top perspective view of a utility knife according to a second embodiment of our new design;

FIG. 9 is a left side elevation view of the utility knife of FIG. 8;

FIG. 10 is a right side elevation view of the utility knife of FIG. 8;

FIG. 11 is a front elevation view of the utility knife of FIG. 8;

FIG. 12 is a rear elevation view of the utility knife of FIG. 8;

FIG. 13 is a top plan view of the utility knife of FIG. 8; and,

FIG. 14 is a bottom plan view of the utility knife of FIG. 8.

The broken lines in the drawings illustrate portions of the utility knife that form no part of the claim.

(56) **References Cited**

U.S. PATENT DOCUMENTS

D439,492 S 3/2001 Martone
6,354,007 B1 * 3/2002 Scarla B26B 1/02
30/330

D458,526 S 6/2002 Budrow
6,481,041 B1 11/2002 Ingram
D478,493 S 8/2003 Martone

(Continued)

1 Claim, 8 Drawing Sheets

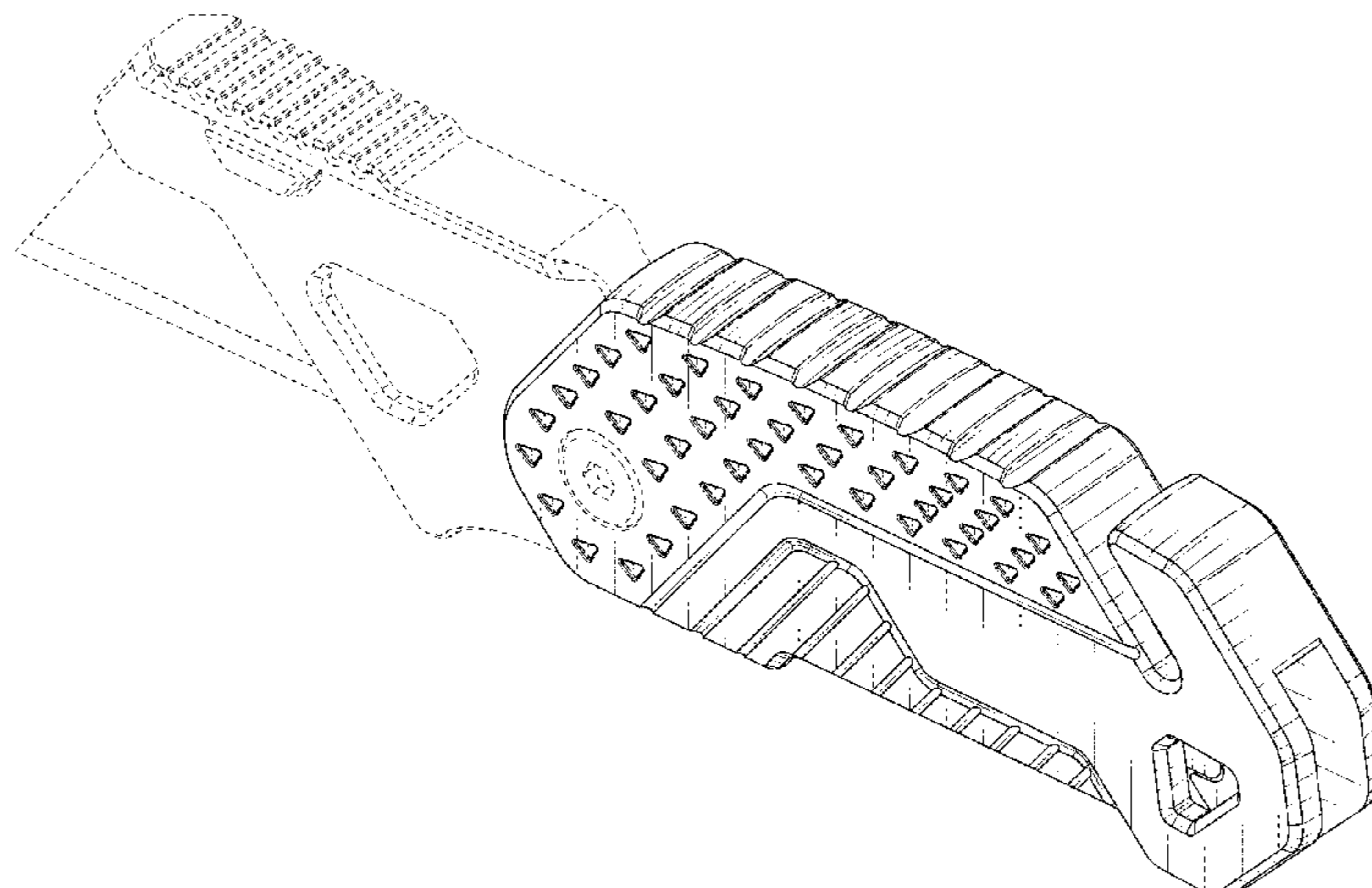

(56)

References Cited

U.S. PATENT DOCUMENTS

D494,437 S * 8/2004 Scarla D8/99
 D509,419 S 9/2005 Chung
 7,140,116 B2 11/2006 Coffin
 7,185,436 B2 3/2007 Murphy
 7,415,769 B2 8/2008 Hughes
 D578,858 S * 10/2008 Ping D8/99
 D579,299 S * 10/2008 Ping D8/99
 D583,643 S * 12/2008 Ping D8/99
 7,481,135 B2 1/2009 Schoenbeck
 D587,553 S 3/2009 Constantine
 7,814,664 B2 * 10/2010 LeBlanc B26B 1/042
 30/330
 D629,274 S 12/2010 Wu
 7,854,214 B2 12/2010 Khubani
 D668,526 S 10/2012 Huang
 D675,503 S 2/2013 Robinson
 D675,899 S 2/2013 Wu
 D691,018 S * 10/2013 Robinson D8/99
 8,549,755 B2 * 10/2013 Ranieri B26B 5/001
 30/162
 D699,090 S * 2/2014 Kalajyan D8/99
 8,677,627 B2 3/2014 Li
 8,739,414 B2 6/2014 Tyers
 D710,178 S 8/2014 Wu
 8,938,883 B2 * 1/2015 Gringer B26B 1/048
 30/155
 9,032,631 B2 5/2015 Christie
 D732,367 S * 6/2015 Parker D8/99
 D738,182 S * 9/2015 Parker D8/99
 D742,716 S * 11/2015 Parker D8/99
 D767,361 S 9/2016 Chiu
 9,545,731 B2 1/2017 Reid
 9,731,426 B2 8/2017 Kim
 9,764,486 B2 9/2017 Bublitz
 10,144,139 B2 * 12/2018 Squiers B26B 5/00
 D846,965 S 4/2019 Gilbert
 10,279,490 B2 5/2019 Gilbert
 10,405,685 B2 9/2019 Wong
 D869,258 S 12/2019 Ulloa
 10,589,436 B1 3/2020 Panosian
 D881,670 S 4/2020 Yao
 D896,607 S 9/2020 Wang
 D905,528 S 12/2020 Spotora
 D910,410 S 2/2021 Chen
 D920,074 S * 5/2021 Hutchens D8/99
 D922,168 S 6/2021 Chen
 D994,455 S * 8/2023 Washburn D8/99
 D995,261 S * 8/2023 Hangartner D8/99
 2008/0289191 A1 * 11/2008 LeBlanc B26B 1/042
 30/160
 2008/0301948 A1 12/2008 Kostner
 2009/0165309 A1 * 7/2009 Kamb B26B 1/02
 30/162
 2009/0188066 A1 7/2009 Van Deursen
 2009/0193662 A1 * 8/2009 van Deursen B26B 5/001
 30/154
 2009/0199408 A1 * 8/2009 Zeng B26B 5/001
 30/152
 2011/0023308 A1 * 2/2011 Ping B26B 1/042
 30/161
 2012/0090181 A1 4/2012 Broekhuizen
 2015/0029702 A1 1/2015 Foley
 2017/0120463 A1 * 5/2017 Pelletier B26B 1/046
 2017/0129112 A1 5/2017 Ranieri
 2018/0354144 A1 * 12/2018 LeBlanc B26B 1/04
 2019/0375118 A1 12/2019 Spotora
 2022/0032483 A1 2/2022 Su

OTHER PUBLICATIONS

Stanley Classic Retractable Utility Knife <https://www.amazon.com/Stanley-10-099-Classic-Retractable-Utility/dp/B013P44YHM/> ref=asc_df_B013P44YHM/?tag=hyprod-20&linkCode=df0&hvadid=

167125219398&hvpos=&hvnetw=g&hvrand=13139388483172131048
 &hvpone=&hvptwo=&hvqmt=&hvdev=c&hvdvcmld=&hvlocint=&hvlocphy=9060252&hvtargid=pla-309758728252&pssc=1, available
 as early as Aug. 29, 2022, 7 pgs.
 Milwaukee Fastback Folding Utility Knife, <https://www.milwaukeetool.com/Products/Hand-Tools/Cutting/Knives-and-Blades/48-22-1502>,
 available as early as Aug. 29, 2022, 12 pgs.
 PHC Snap-Blade Knife, <https://www.msdirect.com/browse/tnpla/09582081>, 14 pgs.
 DeWalt 25mm Snap-Knife, <https://gemplers.com/products/dewalt-25mm-snap-off-knife>, available as early as Aug. 29, 2022, 2 pgs.
 DeWalt Utility Knife, <https://www.zoro.com/dewalt-utility-knife-retractable-utility-general-purpose-steelrubber-dwht10046/i/G7636781/>, 11 pgs.
 Olfa 25mm H-1, <https://olfa.com/products/25mm-h-1-rubber-inset-utility-knife>, available as early as Aug. 29, 2022, 10 pgs.
 Olfa Knife Snap-Off 25mm, <https://www.tooleto.com/en/olfa-knife-snap-off-25mm-xh-1.html>, 2 pgs.
 Tac-Force All Black Karambit Knife, <https://www.sunburstreflections.com/product/tac-force-all-black-karambit-knife>, available as early as Aug. 29, 2022, 3 pgs.
 Fiskars 195210 45mm All Purpose Rotary Cutter, Fiskars 195210-1021 45 mm All Purpose Rotary Cutter—Walmart.com, available as early as Aug. 29, 2022 6 pgs.
 Slice Box Cutter—Safety, <https://www.uline.com/Product/Detail/H-3552/Cutters/Slice-Box-Cutter-Safety>, available as early as Aug. 29, 2022, 1 pg.
 Slice Super-Safe Carton Opener 1-Blade Retractable Utility Knife, <https://www.lowes.com/pd/Slice-Super-Safe-8482-Carton-Cutter/5013013295>, 3 pgs.
 Olfa OLO Self-Guiding Carton Cutter Each, <https://www.olfaproducts.com/olo-cact-carton-cutter.html>, available as early as Aug. 29, 2022, 3 pgs.
 Image of Kobalt product, available as early as Aug. 5, 2020, 1 pg.
 Image of Anvil products, available as early as Aug. 5, 2020, 1 pg.
 Image of Husky product, available as early as Aug. 5, 2020, 1 pg.
 Image of Husky products, available as early as Aug. 5, 2020, 1 pg.
 Image of Stantley products, available as early as Aug. 5, 2020, 1 pg.
 Image of DeWalt 9mm Snap Knife, available as early as Aug. 5, 2020, 1 pg.
 Image of Craftsman 9mm Snap Knife, available as early as Aug. 5, 2020, 1 pg.
 Image of Husky 9mm Snap Knife, available as early as Aug. 5, 2020, 1 pg.
 Image of Olfa 9mm Snap Knife, available as early as Aug. 5, 2020, 1 pg.
 Image of Olfa 9mm 5023 Snap Knife, available as early as Aug. 5, 2020, 1 pg.
 Image of Olfa XA-1 9mm Snap Knife, available as early as Aug. 5, 2020, 1 pg.
 Images of Wurth Utility Knives, available as early as Aug. 6, 2022, 1 pg.
 Image of Anvil THD 18mm Snap Knife, available as early as Aug. 5, 2020, 1 pg.
 Image of Stanley Lowes SnapOff Blade 18mm 0-10-150, available as early as Aug. 5, 2020, 1 pg.
 Image of DeWalt 18mm Snap Knife, available as early as Aug. 5, 2020, 1 pg.
 Image of Olfa Lowes 18mm Snap Knife, available as early as Aug. 5, 2020, 1 pg.
 Image of Olfa THD 18mm snap knife, available as early as Aug. 5, 2020, 1 pg.
 Images of Olfa X-Design 18 3/4 mm knife, available as early as Aug. 5, 2020, 1 pg.
 Image of Milwaukee 18mm Snap-Off Knife, available as early as Aug. 5, 2020, 1 pg.
 Image of ToolPro 25 mm Dial Lock Snap Knife, available as early as Aug. 5, 2020, 1 pg.
 Image of Craftsman 25mm 1-Blade Utility Knife, available as early as Aug. 5, 2020, 1 pg.
 Image of Fiskars Pro 25mm Snap-Off Blade Utility Knife, available as early as Aug. 5, 2020, 1 pg.

(56)

References Cited

OTHER PUBLICATIONS

Image of Craftsman 25mm Snap Off Knife, available as early as Aug. 5, 2020, 1 pg.

Image of Stanley® 25mm DynaGrip® Snap-Off Knife, available as early as Aug. 5, 2020, 1 pg.

Image of Olfa H-1 25mm Extra Heavy Duty Cutter Knife, available as early as Aug. 5, 2020, 1 pg.

Image of Stanley 10-817 25mm FatMax Pro Snap-off Blade Knife, available as early as Aug. 5, 2020, 1 pg.

Image of Olfa 25mm Fiberglass-reinforced Ratchet-lock Snap-off Utility Knife, available as early as Aug. 5, 2020, 1 pg.

Image of Fiskars Pro Folding Utility Knife, available as early as Aug. 5, 2020, 1 pg.

Image of Fiskars Utility Trapezoid Blade Knife, available as early as Aug. 5, 2020; 1 pg.

Image of Milwaukee Self-Retracting Trapezoid Blade Knife, available as early as Aug. 5, 2020; 1 pg.

Image of utility blade trapezoid knife, available as early as Aug. 5, 2020; 1 pg.

Image of Landing Custom Safety Utility Trapezoid Blade Knife, available as early as Aug. 5, 2020; 1 pg.

Image of trapezoid blade knife, available as early as Aug. 5, 2020; 1 pg.

Image of Utility Trapezoid Blade Knife, available as early as Aug. 5, 2020; 1 pg.

Images of Foxmax Trapezoid Blade Knife, available as early as Aug. 5, 2020; 1 pg.

Fiskars Crafts Premier Ultra-Sharp Thread Snip product, available at https://www.amazon.com/Fiskars-Crafts-Premier-Ultra-Sharp-Thread/dp/B072N2ZPGC/ref=sr_1_1?keywords=Fiskars%C2%AE+Ultrasharp+Thread+Snips&qid=1674082200&sr=8-1 as early as Aug. 5, 2020, 10 pg.

Fiskars Shears available at https://www.amazon.com/Fiskars-190500-RazorEdge-Micro-Tip-Action/dp/B00UY11IFG/ref=sr_1_2?keywords=Fiskars%C2%AE%2BUltrasharp%2BThread%2BSnips&qid=1674082685&sr=8-2&th=1 as early as Aug. 5, 2020, 10 pg.

Fiskars Scissors available at https://www.amazon.com/Fiskars-5-Inch-Softgrip-Scissors/dp/B000B7MUE6/ref=sr_1_1?crd=GN6MJC4OEQY6&keywords=Fiskars%2B5%2Binch%2Bsoft%2Bgrip&qid=1674082882&srefix=fiskars%2B5%2Binch%2Bsoft%2Caps%2C589&sr=8-1&th=1 as early as Aug. 5, 2020, 9 pg.

Dewalt Premium Folding Retractable Utility Knife, available at <https://www.dewalt.com/product/dwht10296/premium-folding-retractable-utility-knife?tid=576801> as early as Aug. 5, 2020; 12 pg.

Dewalt Folding Fixed Blade Knife, available at <https://www.dewalt.com/product/dwht10916/folding-fixed-blade-knife?tid=576801> as early as Aug. 5, 2020; 11 pg.

Milwaukee Fastback™ 6IN1 Folding Utility Knife, available at <https://www.milwaukeetool.com/Products/Hand-Tools/Cutting/48-22-1505> as early as Aug. 5, 2020; 6 pg.

Milwaukee Fastback™ Folding Utility Knife, available at <https://www.milwaukeetool.com/Products/Hand-Tools/Cutting/48-22-1501> as early as Aug. 5, 2020, 5 pg.

Milwaukee Fastback™ Spring Assisted Folding Knife, available at <https://www.milwaukeetool.com/Products/Hand-Tools/Cutting/48-22-1530> as early as Aug. 5, 2020, 10 pg.

Husky 21113 Folding Sure-Grip Lock Back Utility Knife, available at <https://www.amazon.com/Husky-21113-Sure-Grip-Disposable-Included/dp/B0026SY730> as early as Aug. 5, 2020, 8 pg.

Husky Retractable Folding Utility Knife, available at <https://www.homedepot.com/p/Husky-Retractable-Folding-Utility-Knife-99734/303741395> as early as Aug. 5, 2020, 5 pg.

Husky Pro Folding Utility Knife, available at <https://www.homedepot.com/p/Husky-Pro-Folding-Utility-Knife-99737/303741407#overlay> as early as Aug. 5, 2020, 5 pg.

Craftsman ¾-in 3-Blade Folding Retractable Utility Knife, available at https://www.lowes.com/pd/CRAFTSMAN-3-4-in-3-Blade-Folding-Retractable-Utility-Knife/1000594515?cm_mmc=shp-_c-_vf-_tol-_ggl-_SS_SDB-Craftsman-_1000594515-_local-_0-_

0&&ds_a_cid=279391351&gclid=EAlalQobChMIvo-DrP6_-wIVTsmUCR2LTgfOEAYASABEgKM4_D_BwE&gclsrc=aw.ds as early as Aug. 5, 2020, 5 pg.

Irwin FK150 Folding Utility Knife, available at <https://www.irwin.com/tools/utility-knives-blades/irwin-fk150-folding-utility-knife> as early as Aug. 5, 2020, 4 pg.

Irwin Folding, available at <https://www.irwin.com/tools/utility-knives-blades/folding> as early as Aug. 5, 2020, 5 pg.

Kobalt Lockback 11-Blade Folding Utility Knife, available at <https://www.lowes.com/pd/Kobalt-Kobalt-Quick-Change-Folding-Lock-Back-Knife/5001727641> as early as Aug. 5, 2020, 6 pg.

Dewalt Premium Retractable Utility Knife, available at <https://www.dewalt.com/product/dwht10295/premium-retractable-utility-knife?tid=576801> as early as Aug. 5, 2020; 8 pg.

Dewalt Instantchange® Knife, available at <https://www.dewalt.com/product/dwht10914/instantchanger-knife?tid=576801> as early as Aug. 5, 2020; 7 pg.

Dewalt Retractable Utility Knife, available at <https://www.dewalt.com/product/dwht10319/retractable-utility-knife?tid=576801> as early as Aug. 5, 2020; 7 pg.

Dewalt Fixed Blade Knife, available at <https://www.dewalt.com/product/dwht10246/fixed-blade-knife?tid=576801> as early as Aug. 5, 2020; 7 pg.

Craftsman Quick Change 3-Blade Retractable Utility Knife with On Tool Blade Storage, available at <https://www.lowes.com/pd/CRAFTSMAN-Quick-Change-Knife/5000242955> as early as Aug. 5, 2020; 2 pg.

Irwin ¾-in 1-Blade Retractable Utility Knife with On Tool Blade Storage, available at https://www.lowes.com/pd/IRWIN-3-4-in-1-Blade-Retractable-Utility-Knife-with-with-On-Tool-Blade-Storage/1003172452?cm_mmc=shp-_c-_vf-_tol-_ggl-_SS_Irwin-_1003172452-_local-_0-_0&&ds_a_cid=279391351&gclid=EAlalQobChMIILbQuJzA-wlVojizAB2BpwrcEAQYAYABEgKq3_D_BwE&gclsrc=aw.ds as early as Aug. 5, 2020; 3 pg.

Craftsman ¾-in 3-Blade Retractable Utility Knife with On Tool Blade Storage, available at <https://www.lowes.com/pd/CRAFTSMAN-3-4-in-3-Blade-Retractable-Utility-Knife-with-with-On-Tool-Blade-Storage/1000594575> as early as Aug. 5, 2020; 3 pg.

Craftsman Hi-Vis Quick Change 3-Blade Retractable Utility Knife with On Tool Blade Storage, available at <https://www.lowes.com/pd/CRAFTSMAN-HI-VIS-Quick-Change-Knife/5000242959> as early as Aug. 5, 2020; 2 pg.

Snap-on Folding Utility Knife, available at https://www.samsclub.com/p/utility-knife-set-folding-retractable/prod19921932?pid=_CSE_PIN_716244 as early as Aug. 5, 2020; 4 pg.

Fiskars 770050 Painters Utility Folding Knife, available at <https://www.ihlcanada.com/fiskars-770050-painters-utility-folding-knife-28566> as early as Aug. 5, 2020 as early as Aug. 5, 2020; 2 pg.

Gerber Gear Edge Exchange-A-Blade Folding Razor Utility Knife, available at <https://www.walmart.com/ip/Gerber-Gear-Edge-Exchange-A-Blade-Folding-Razor-Utility-Knife-Orange/285345154> as early as Aug. 5, 2020; 4 pg.

Steel Grip 5-½ in. Sliding Safety Knife Silver, available at <https://www.acehardware.com/departments/tools/hand-tools/utility-and-hobby-knives/2796142> as early as Aug. 5, 2020; 6 pg.

Image of Craftsman Lowes 18mm Snap Knife, available as early as Aug. 5, 2020, 1 pg.

Image of Husky THD 18mm Snap Knife, available as early as Aug. 5, 2020, 1 pg.

Image of DeWalt THD 25mm Snap Knife, available as early as Aug. 5, 2020, 1 pg.

Blue Ridge Tools 2 in 1 Rechargeable Screwdriver Flashlight, available at <https://www.target.com/p/blue-ridge-tools-2-in-1-rechargeable-screwdriver-flashlight/-/A-78262231#lnk=sametab>, product presently believed to be publicly available at least as of Aug. 5, 2020, 3 pg.

Blue Ridge Tools Folding Utility Knife, available at <https://www.target.com/p/blue-ridge-tools-folding-utility-knife/-/A-78591336#lnk=sametab>, product presently believed to be publicly available at least as of Aug. 5, 2020, 3 pg.

Blue Ridge Tools 11 Function Hammer Multi Tool, available at <https://www.target.com/p/blue-ridge-tools-11-function-hammer-multi>

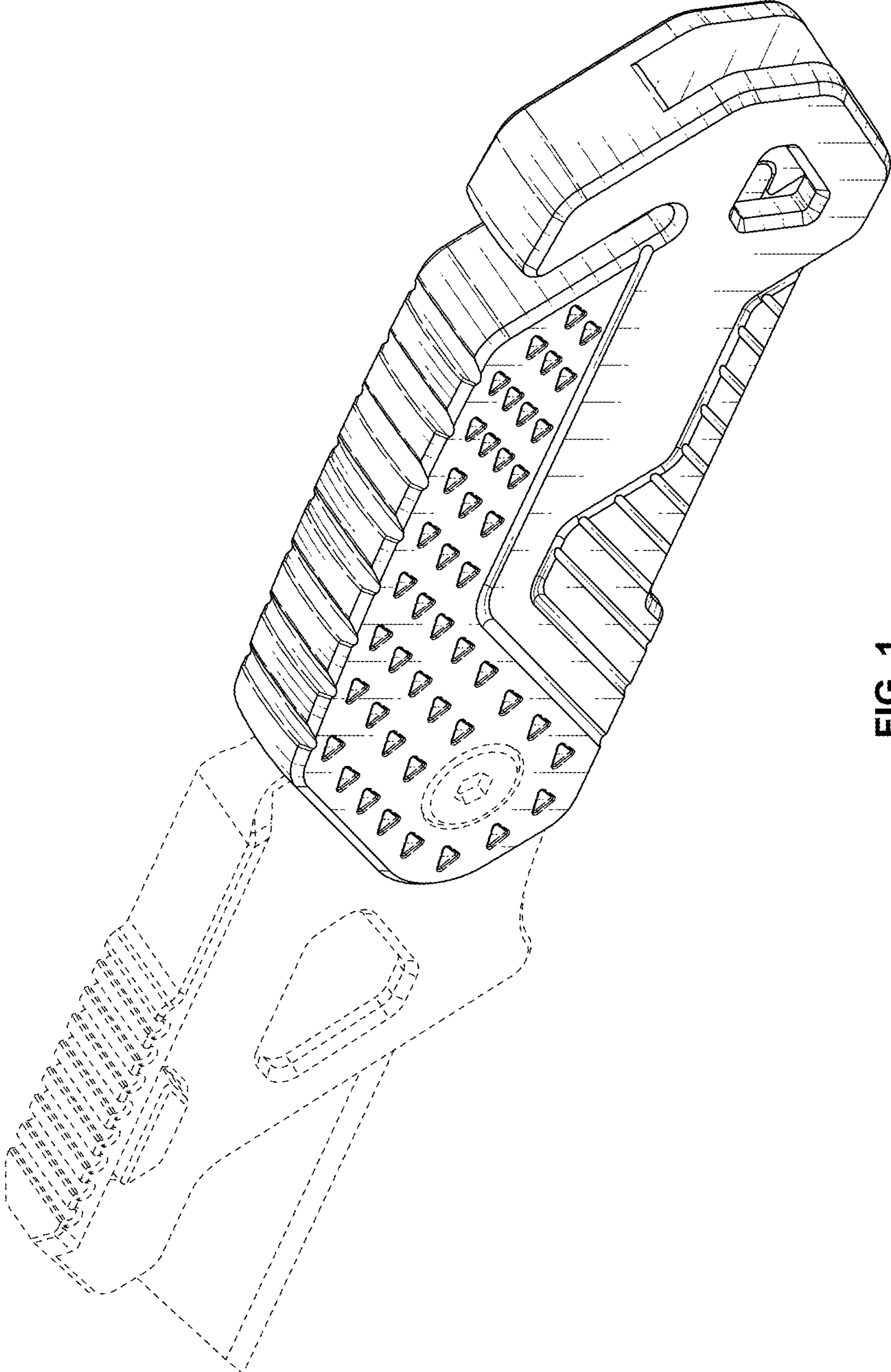

FIG. 1

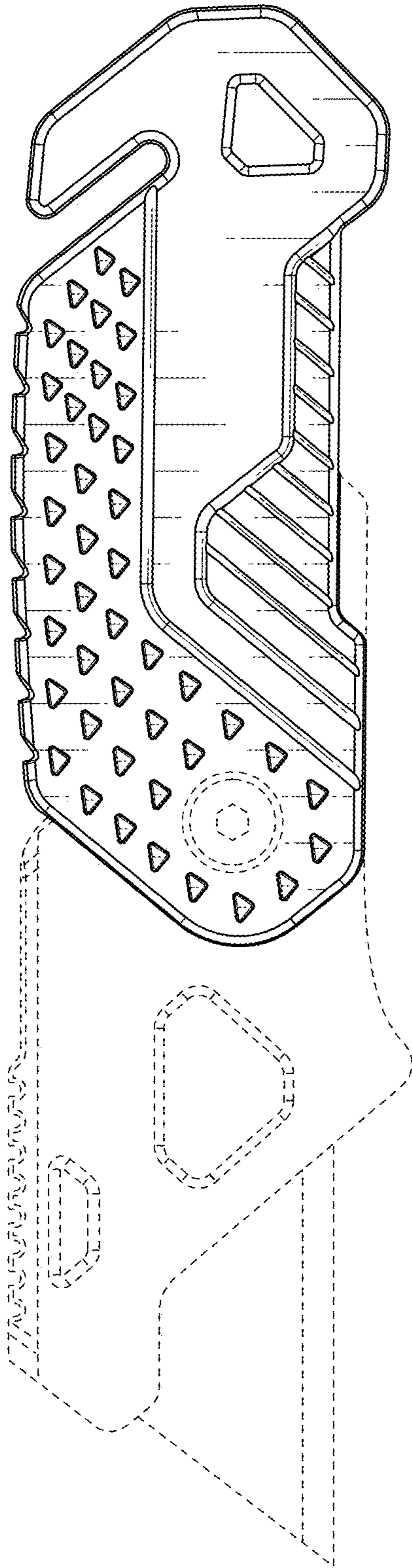

FIG. 2

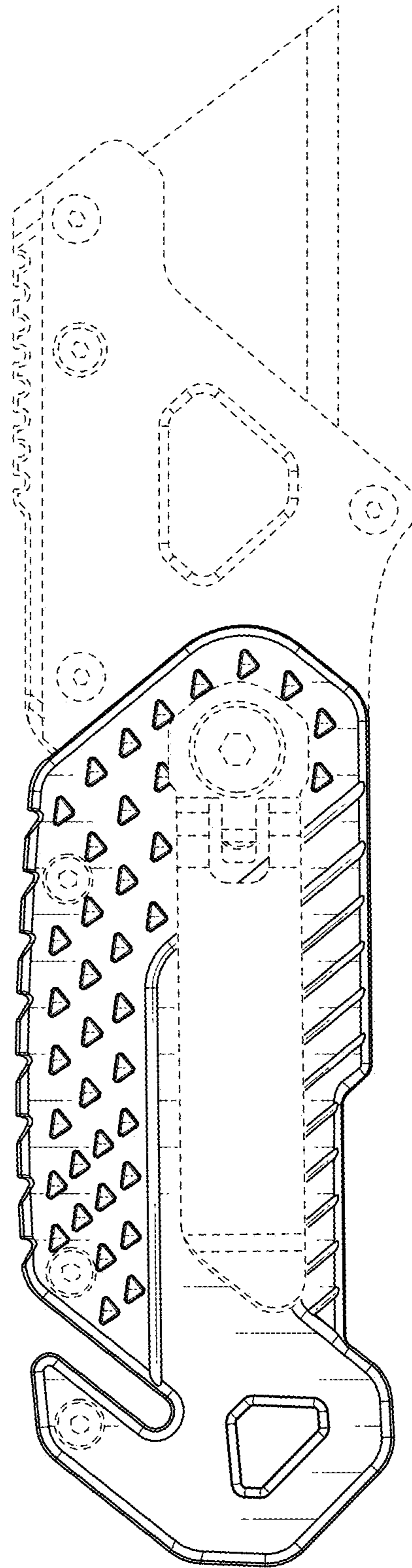

FIG. 3

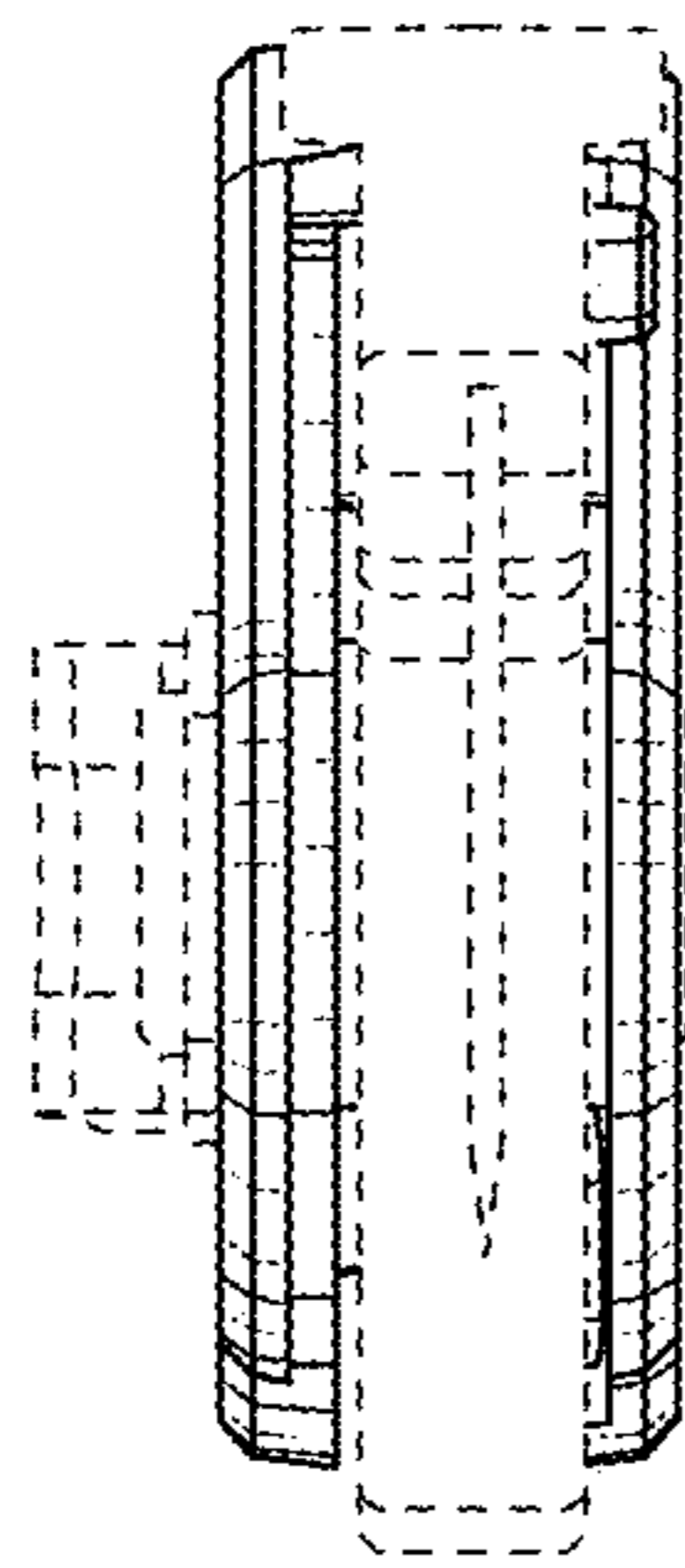

FIG. 4

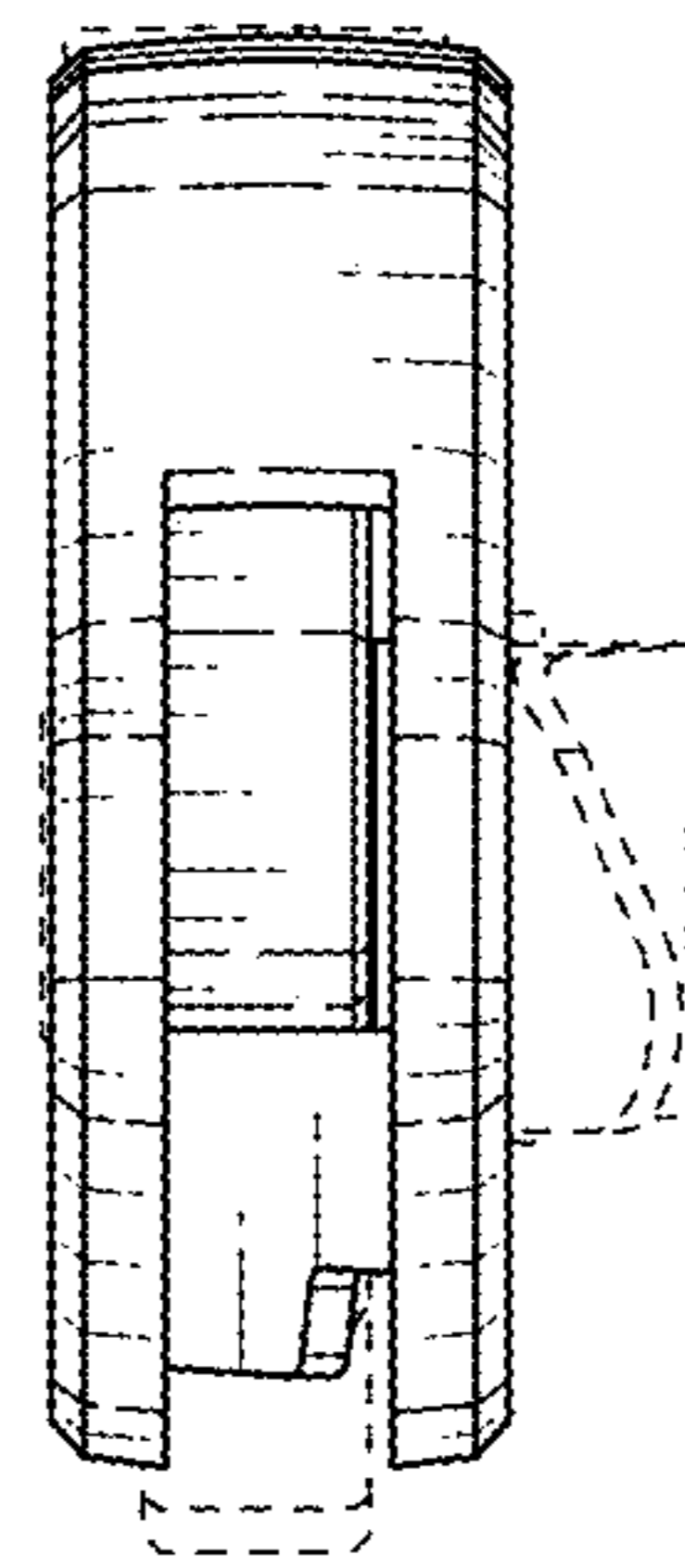

FIG. 5

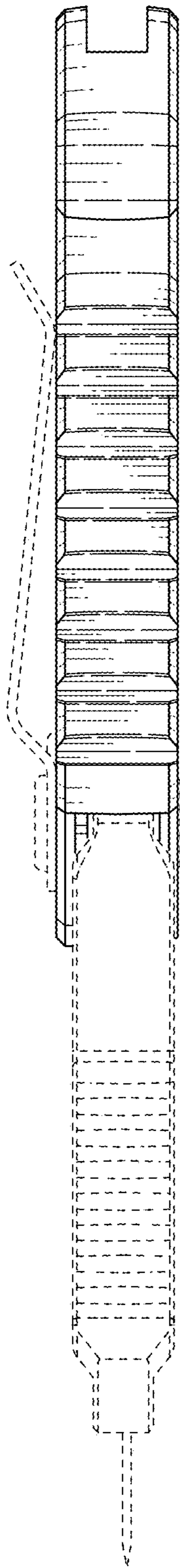

FIG. 6

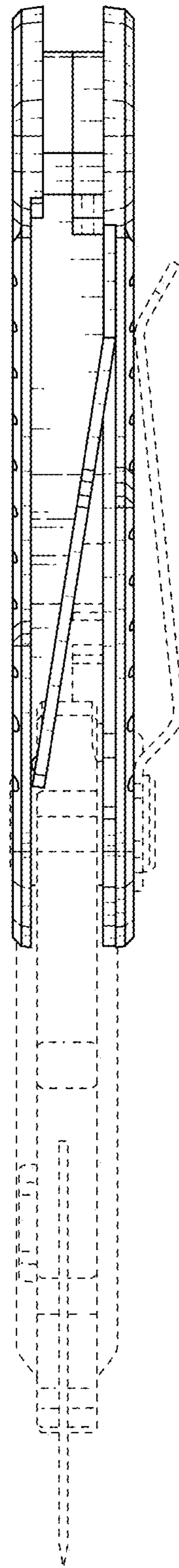

FIG. 7

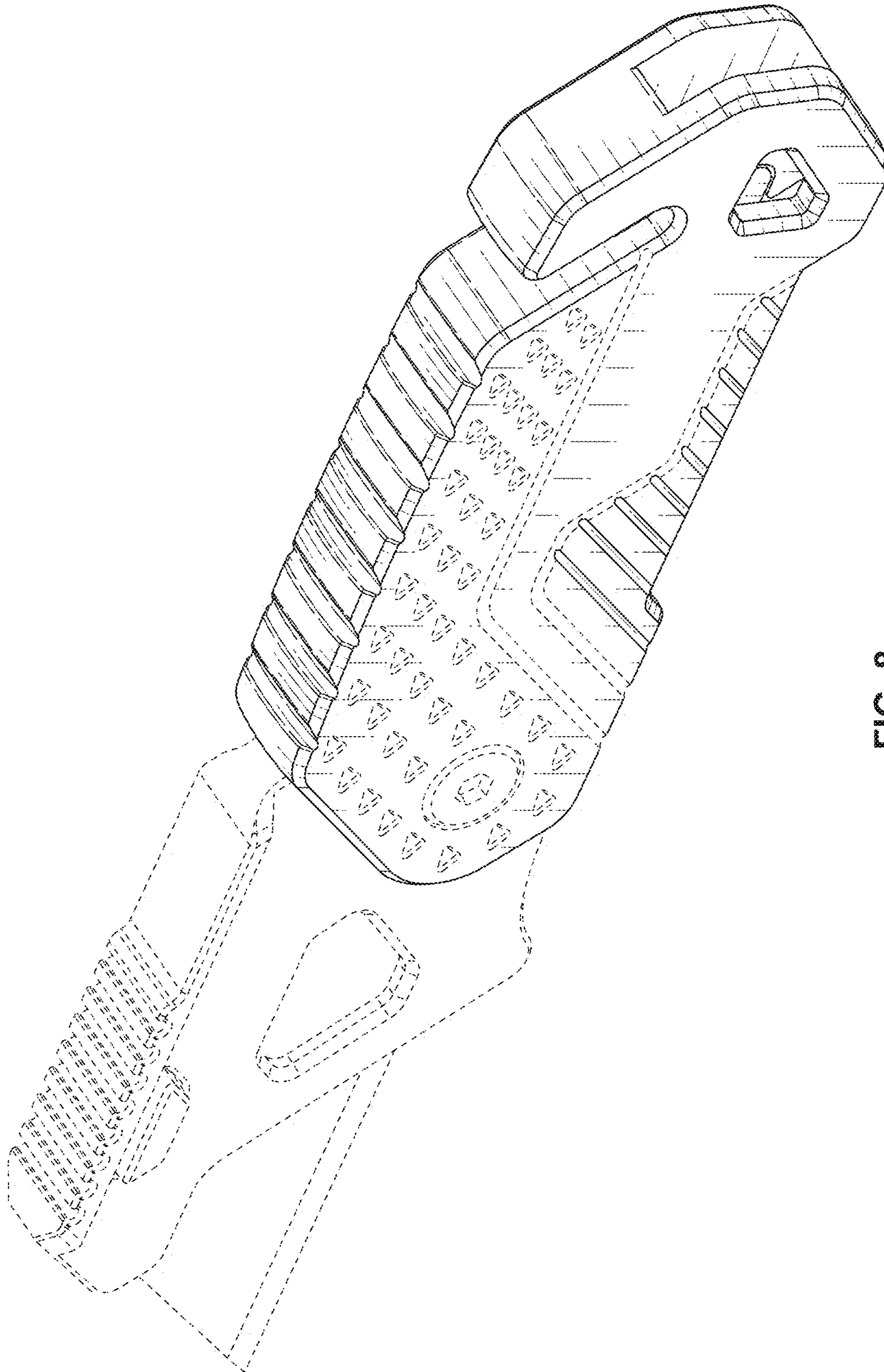

FIG. 8

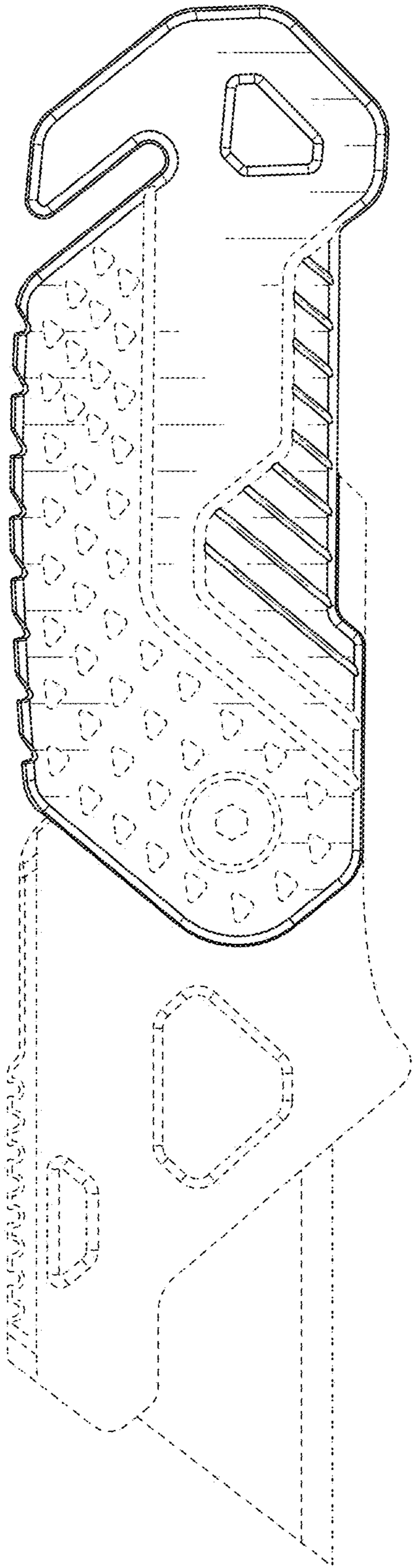

FIG. 9

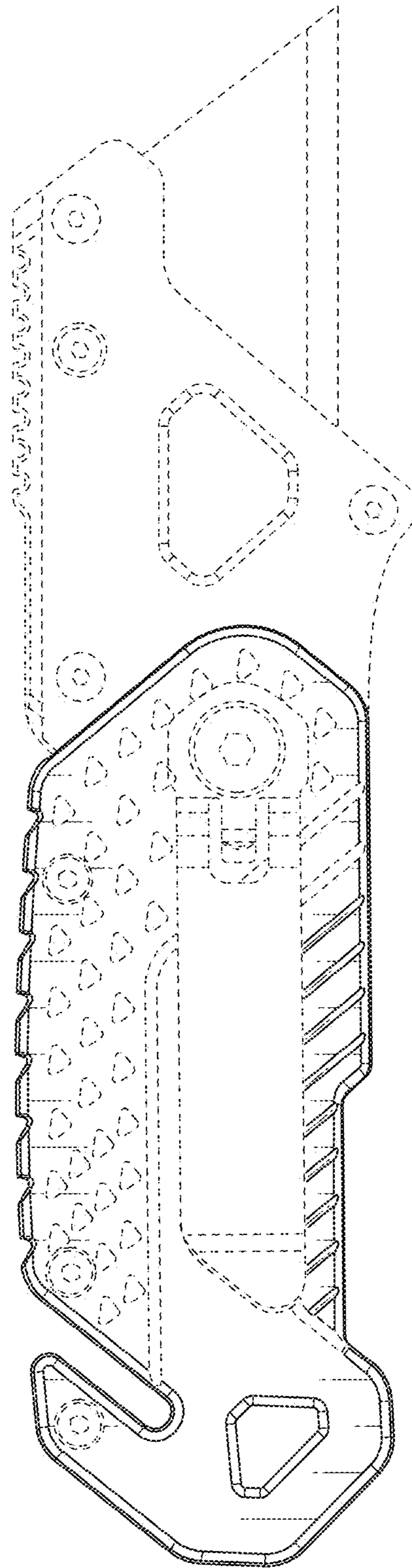

FIG. 10

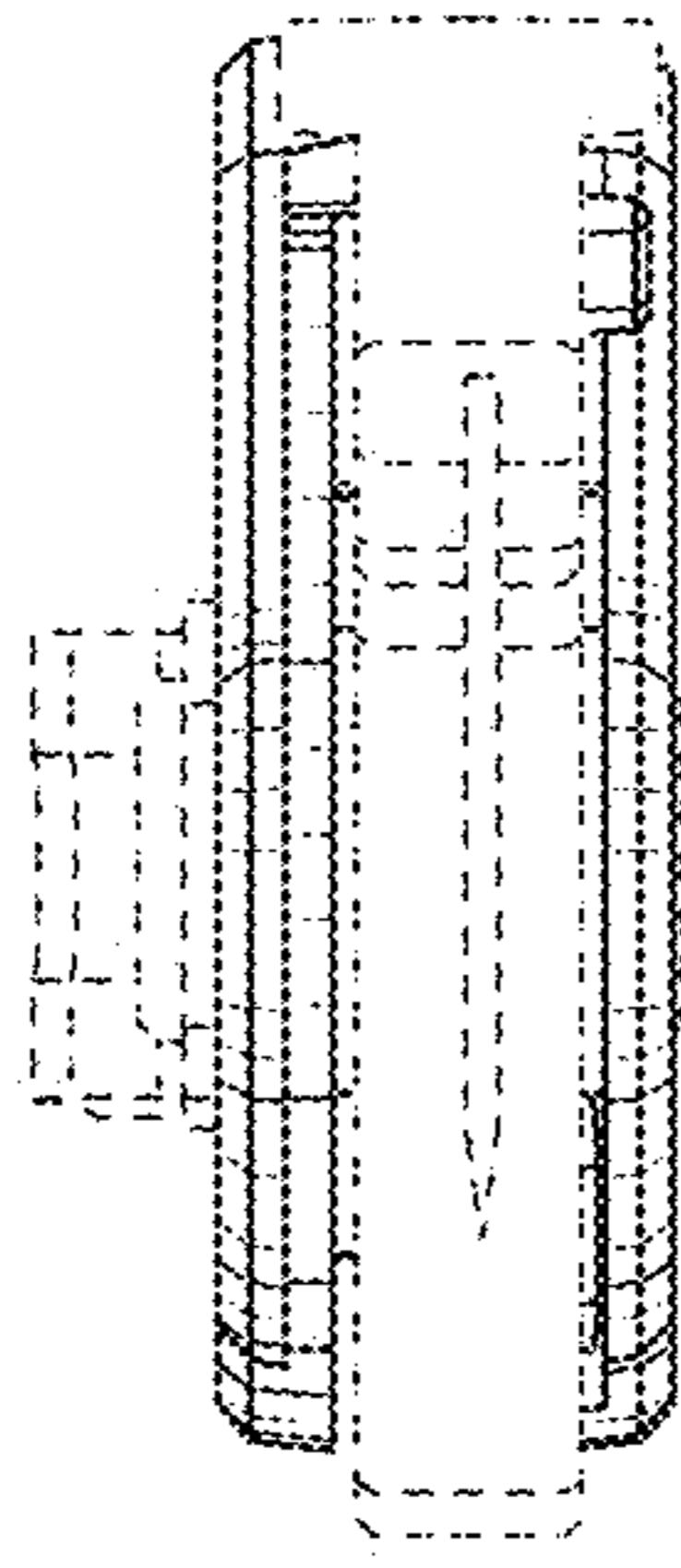

FIG. 11

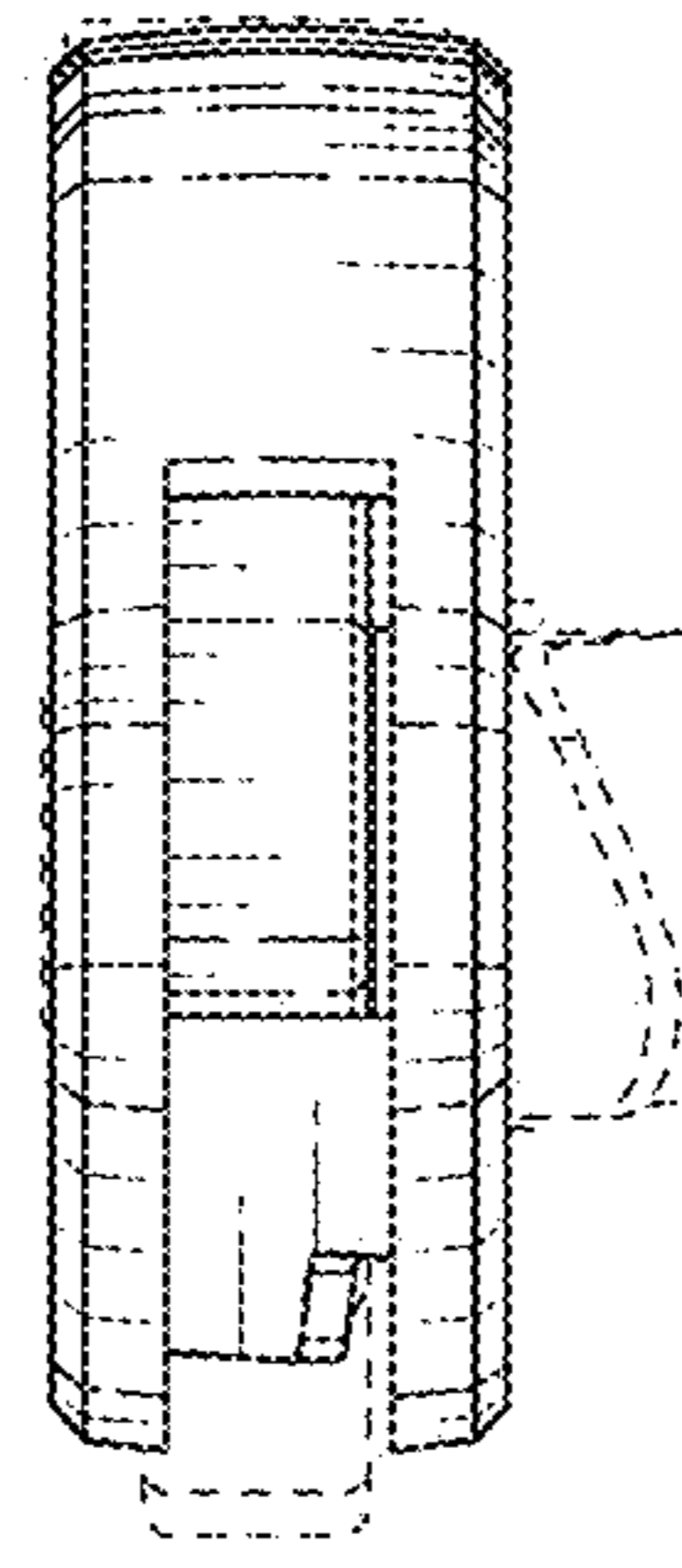

FIG. 12

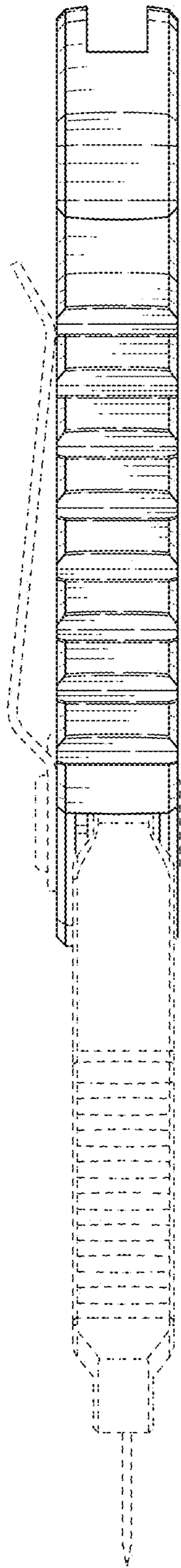

FIG. 13

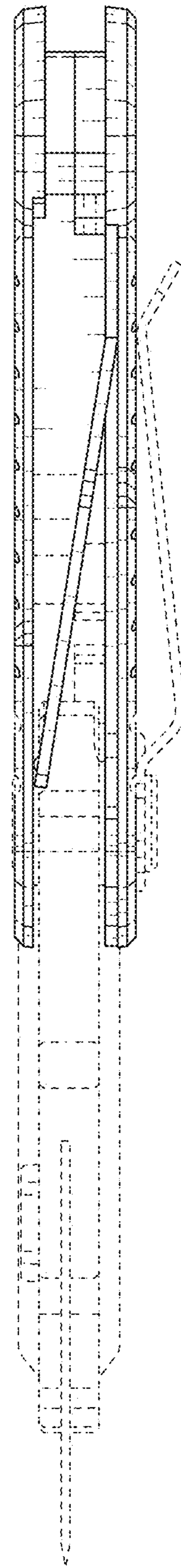

FIG. 14