

US0D1044639S

(12) **United States Design Patent** (10) **Patent No.:** **US D1,044,639 S**
Chiang (45) **Date of Patent:** **** *Oct. 1, 2024**

(54) **MUD FLAP SET**

- (71) Applicant: **Man Kit Chiang**, Dublin, CA (US)
- (72) Inventor: **Man Kit Chiang**, Dublin, CA (US)
- (*) Notice: This patent is subject to a terminal disclaimer.
- (**) Term: **15 Years**
- (21) Appl. No.: **29/787,031**
- (22) Filed: **Jun. 3, 2021**

Related U.S. Application Data

- (63) Continuation-in-part of application No. 29/787,029, filed on Jun. 3, 2021, now Pat. No. Des. 1,012,798.
- (51) **LOC (14) Cl.** **12-16**
- (52) **U.S. Cl.**
USPC **D12/185**
- (58) **Field of Classification Search**
USPC D12/90-92, 93, 96, 181, 184, 185, 196, D12/202
CPC B62D 25/18; B62D 25/188
See application file for complete search history.

(56) **References Cited**

U.S. PATENT DOCUMENTS

D308,847 S *	6/1990	Price	D12/185
D310,345 S *	9/1990	Iacovelli	D12/185
5,407,229 A *	4/1995	Garrett	B62D 25/18 280/851
D415,460 S *	10/1999	Ward	D12/185
D818,914 S *	5/2018	Johnson	B62D 25/18 D12/185
D826,120 S *	8/2018	DiCanzio	B62D 25/18 D12/185
2018/0009485 A1 *	1/2018	Johnson	B62D 25/18 D12/185

OTHER PUBLICATIONS

Amazon, Extreme Online Store Replacement for 2020 Chevrolet Corvette C8, published Mar. 25, 2018 [retrieved Oct. 7, 2022]. Retrieved from the internet<<https://www.amazon.com/Extreme-Online-Store-Replacement-2020-Present/dp/B08Q33DPH6>> (Year: 2018).*

Amazon, Qispoler Front & Rear Splash Guards Mud Flaps Molded Splash Guards, published Apr. 19, 2022 [retrieved Oct. 7, 2022]. Retrieved from the internet<https://www.amazon.com/dp/B09Y8561DZ/ref=sspa_dk_detail_5?> (Year: 2022).*

* cited by examiner

Primary Examiner — Joseph Kukella
Assistant Examiner — Lavon M. Amerson

(57) **CLAIM**

The ornamental design for a mud flap set, as shown and described.

DESCRIPTION

FIG. 1 is a top-front-left perspective view of a mud flap set showing my new design;
FIG. 2 is a top-rear-right perspective view thereof;
FIG. 3 is a bottom-front-left perspective view thereof;
FIG. 4 is a bottom-rear-right perspective view thereof;
FIG. 5 is a front elevational view thereof;
FIG. 6 is a rear elevational view thereof;
FIG. 7 is a top plan view thereof;
FIG. 8 is a bottom plan view thereof;
FIG. 9 is a right elevational view thereof; and,
FIG. 10 is a left elevational view thereof.
The broken lines showing fastening members in FIGS. 1-10 are included for the purpose of illustrating environmental structure and form no part of the claimed design.

1 Claim, 10 Drawing Sheets

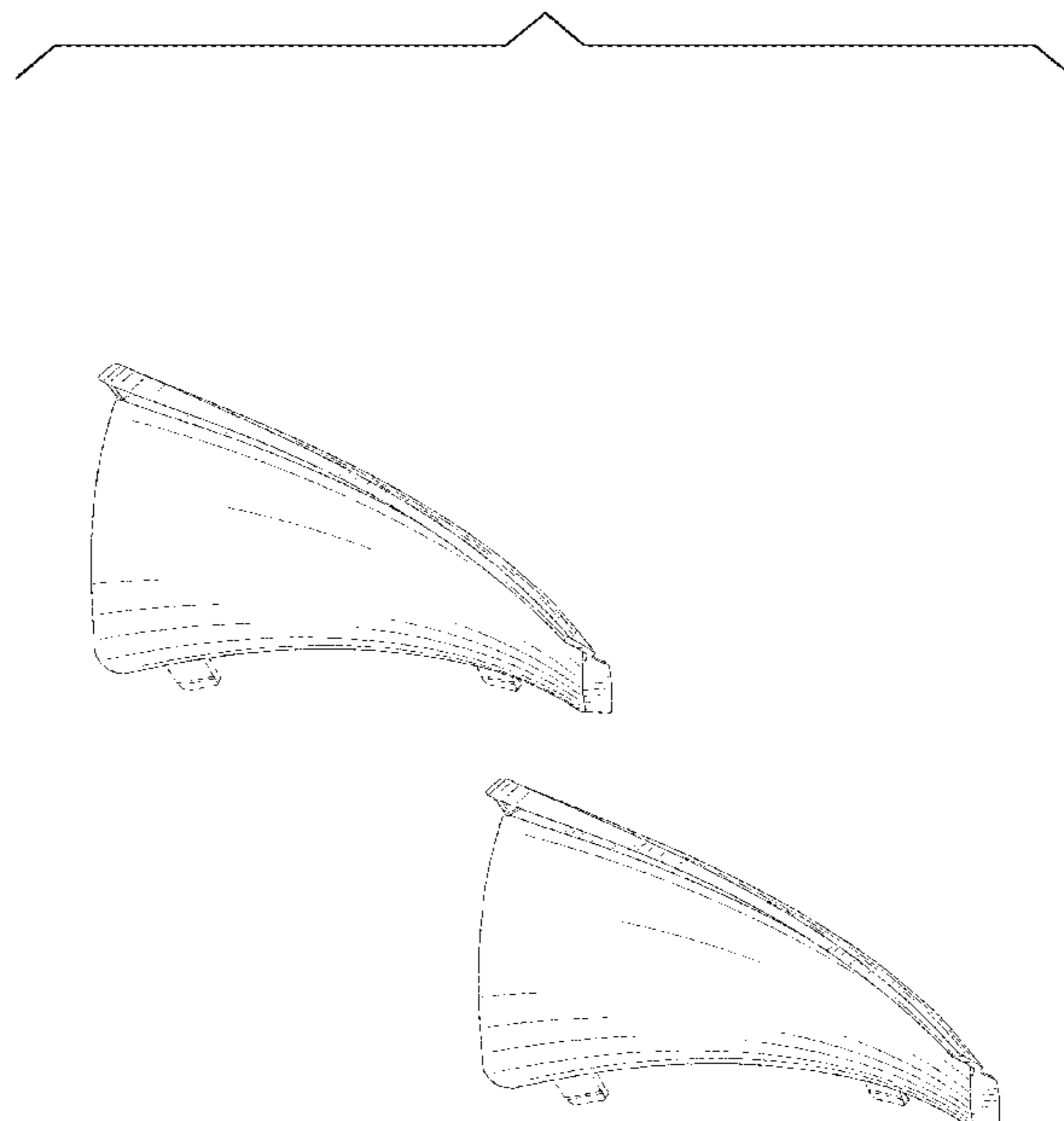

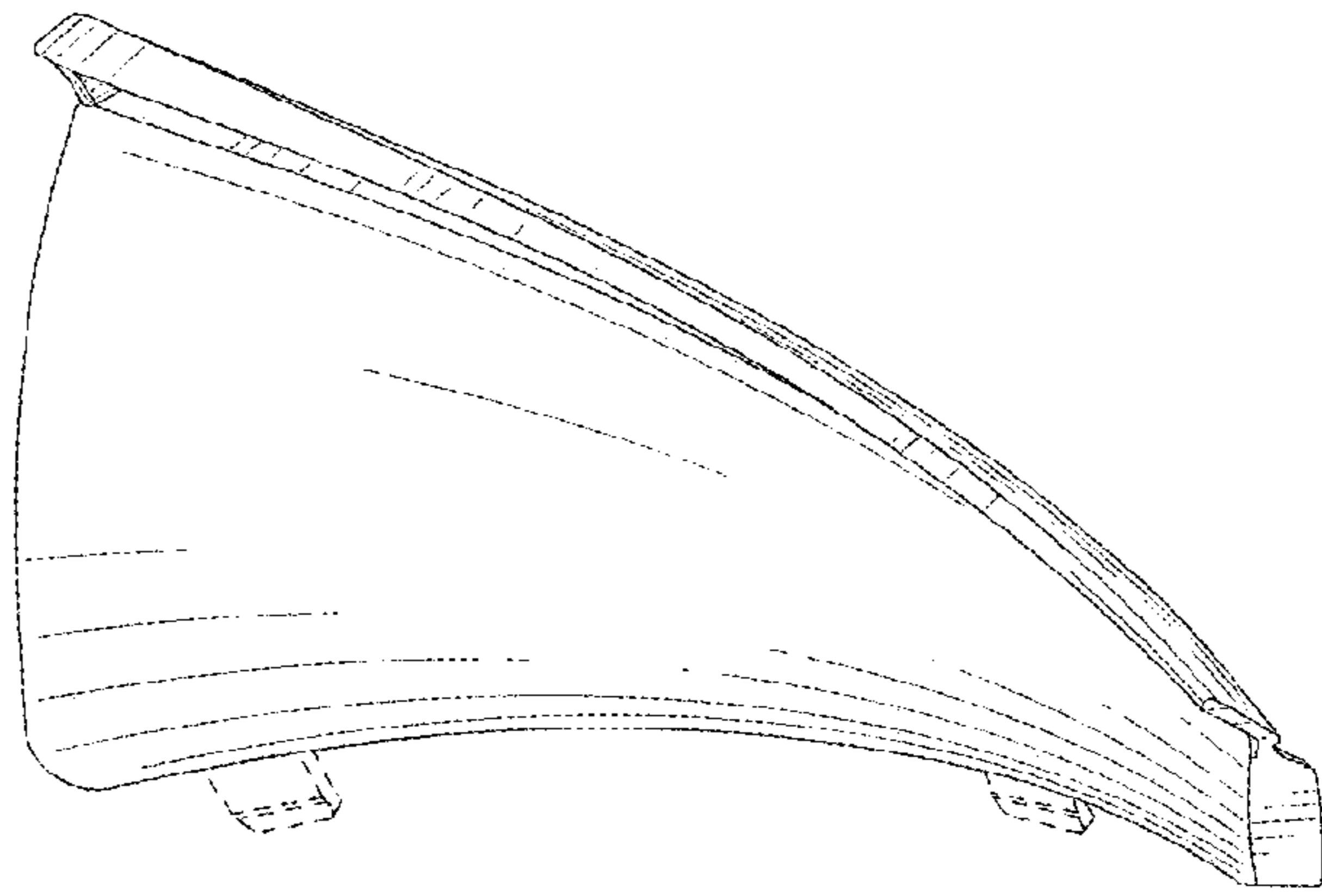
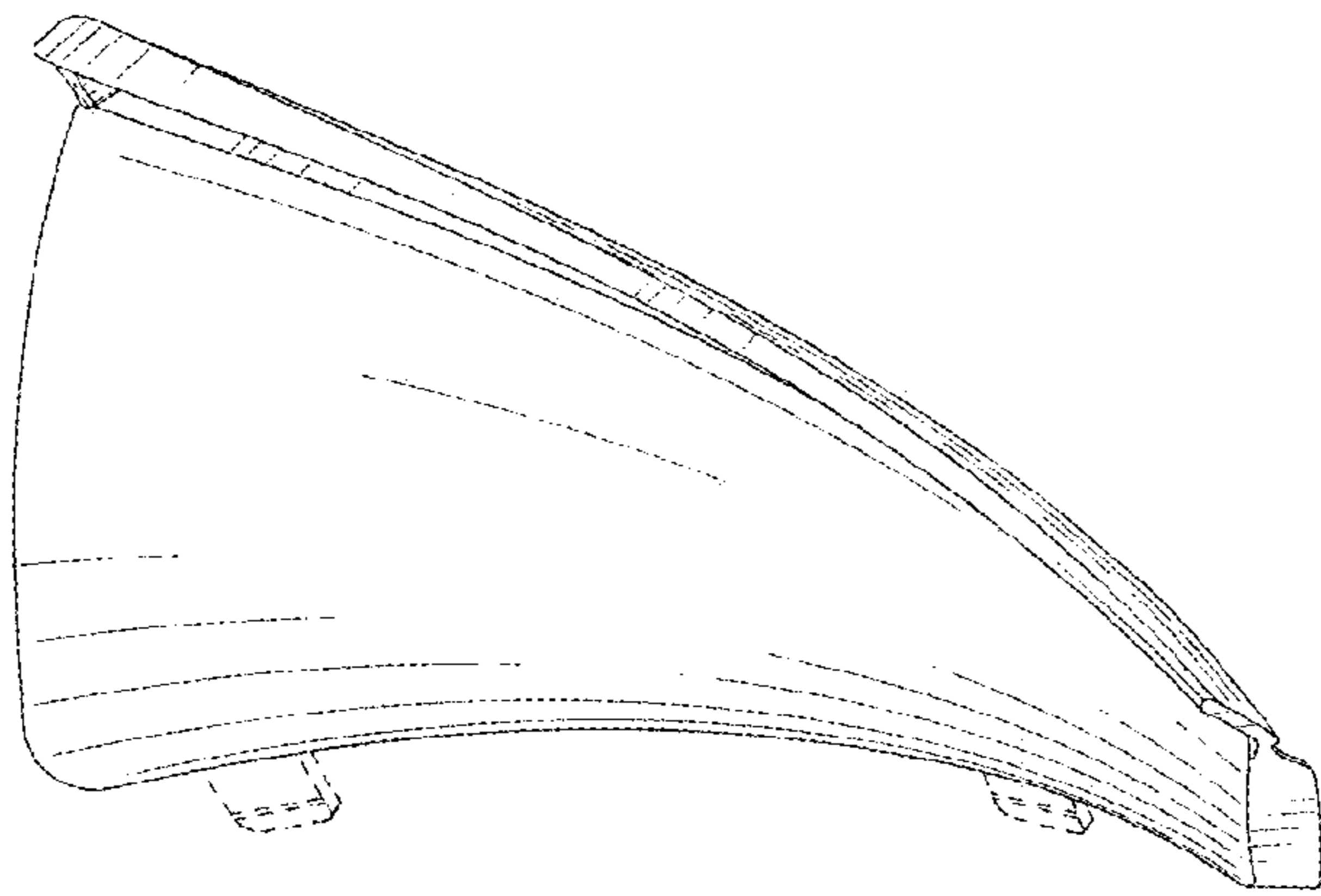

FIG. 1

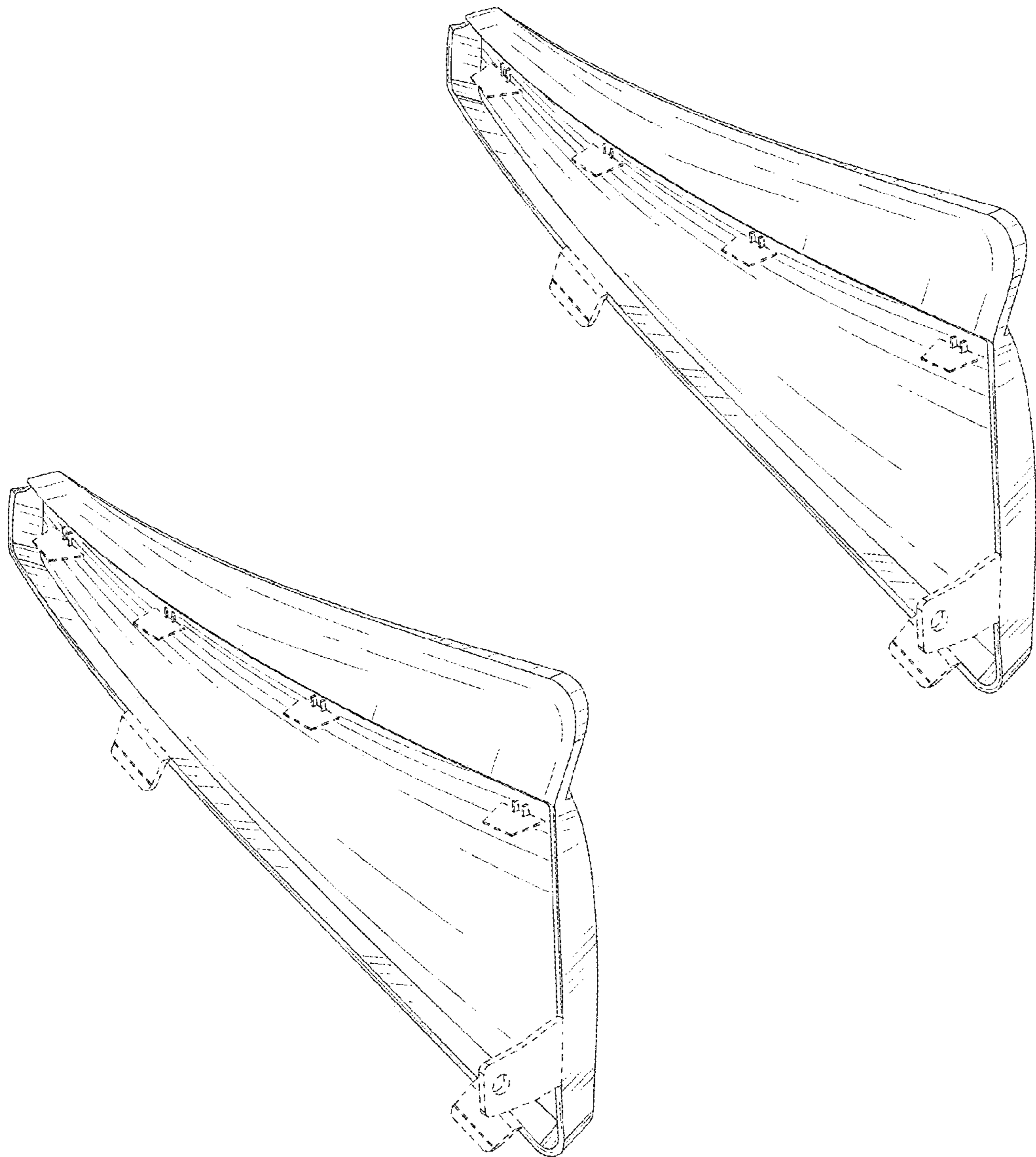

FIG. 2

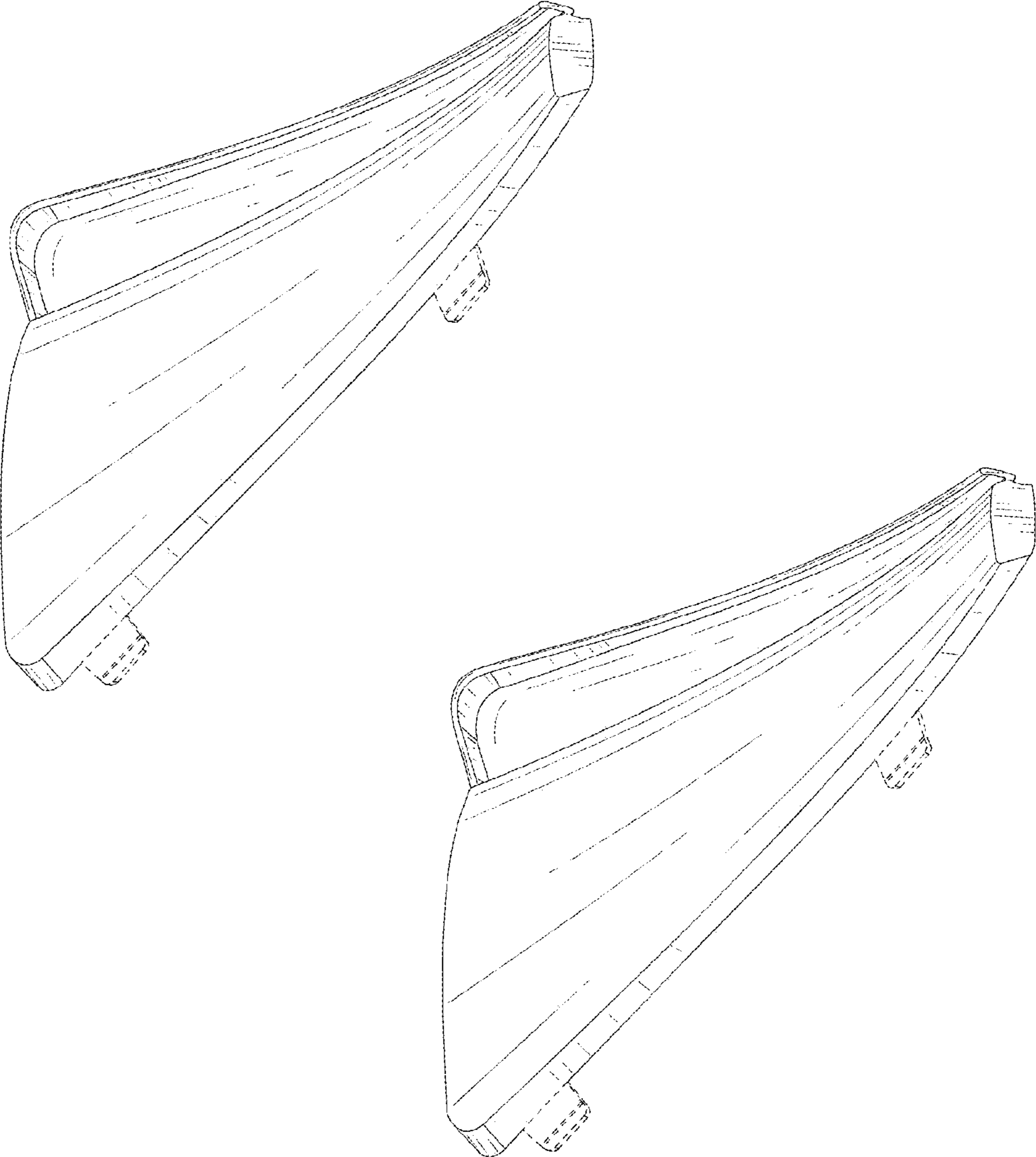

FIG. 3

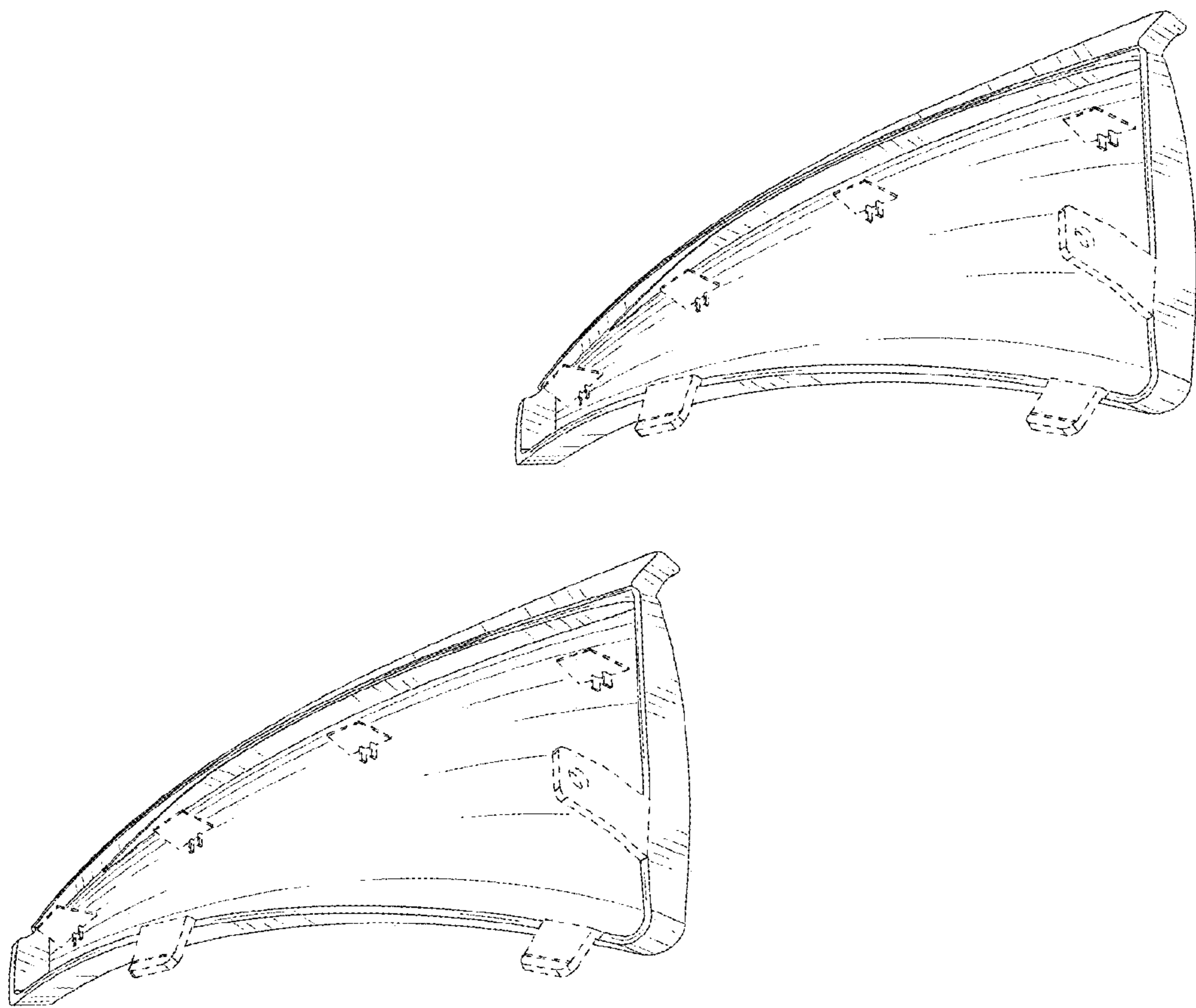

FIG. 4

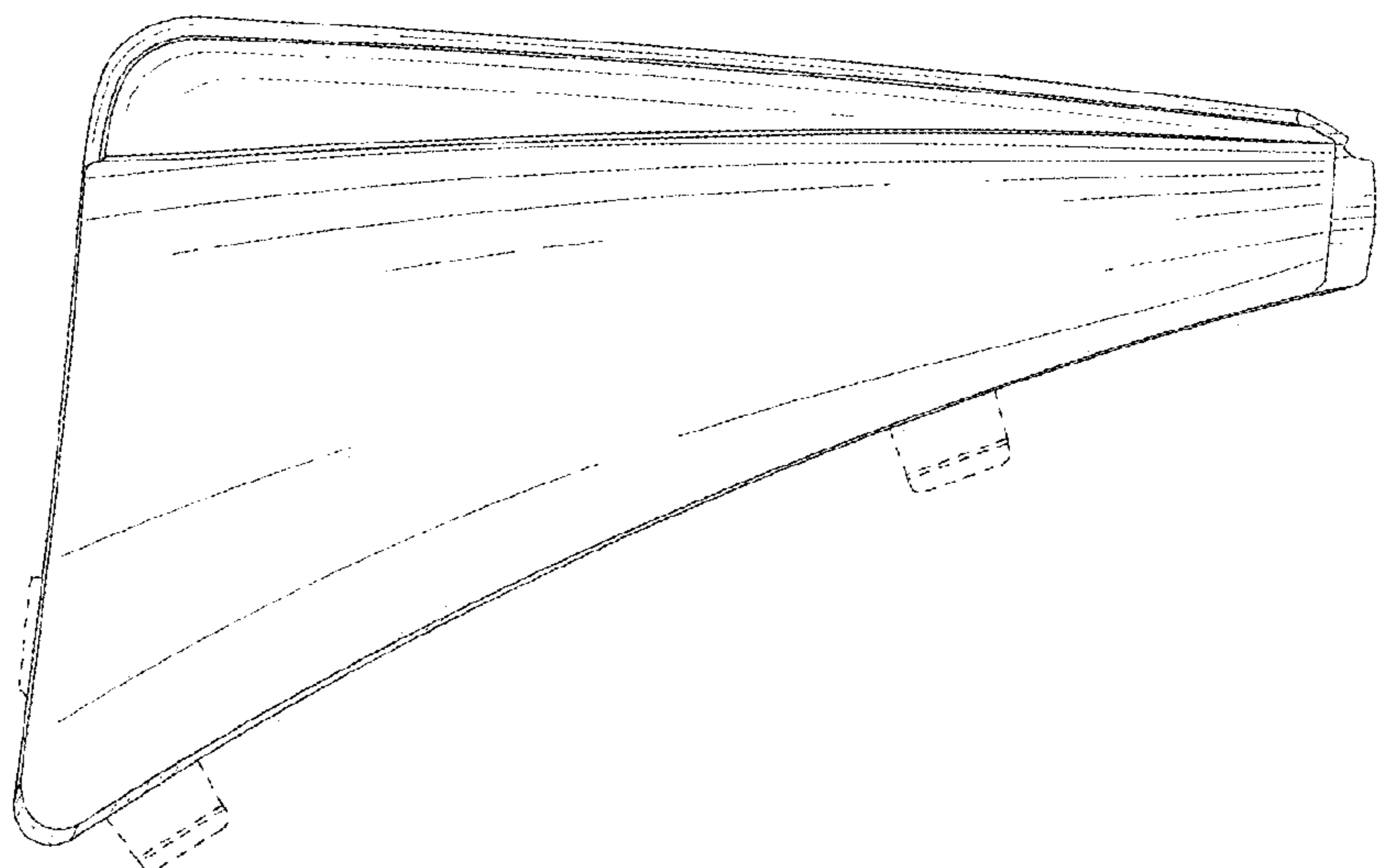
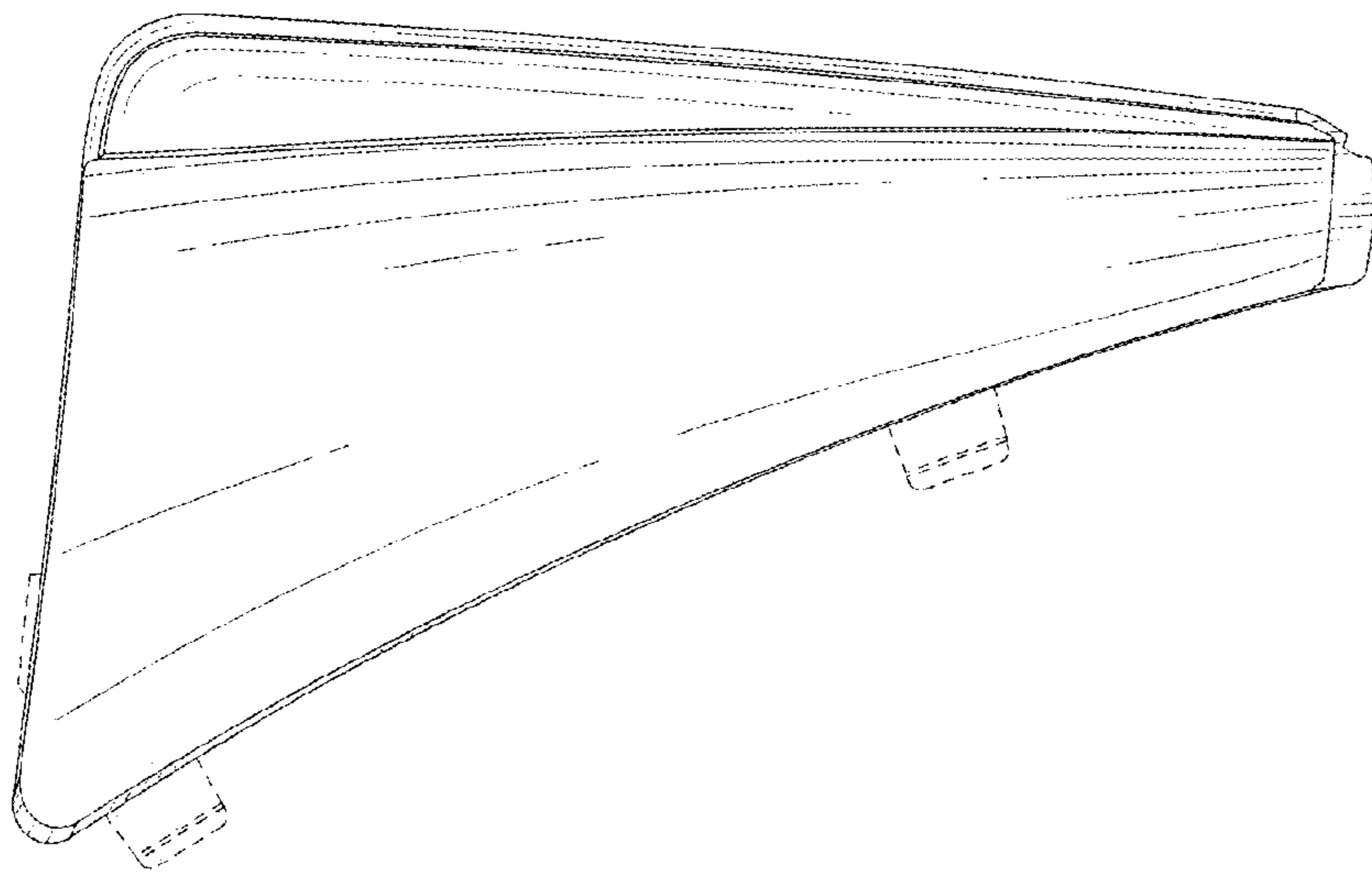

FIG. 5

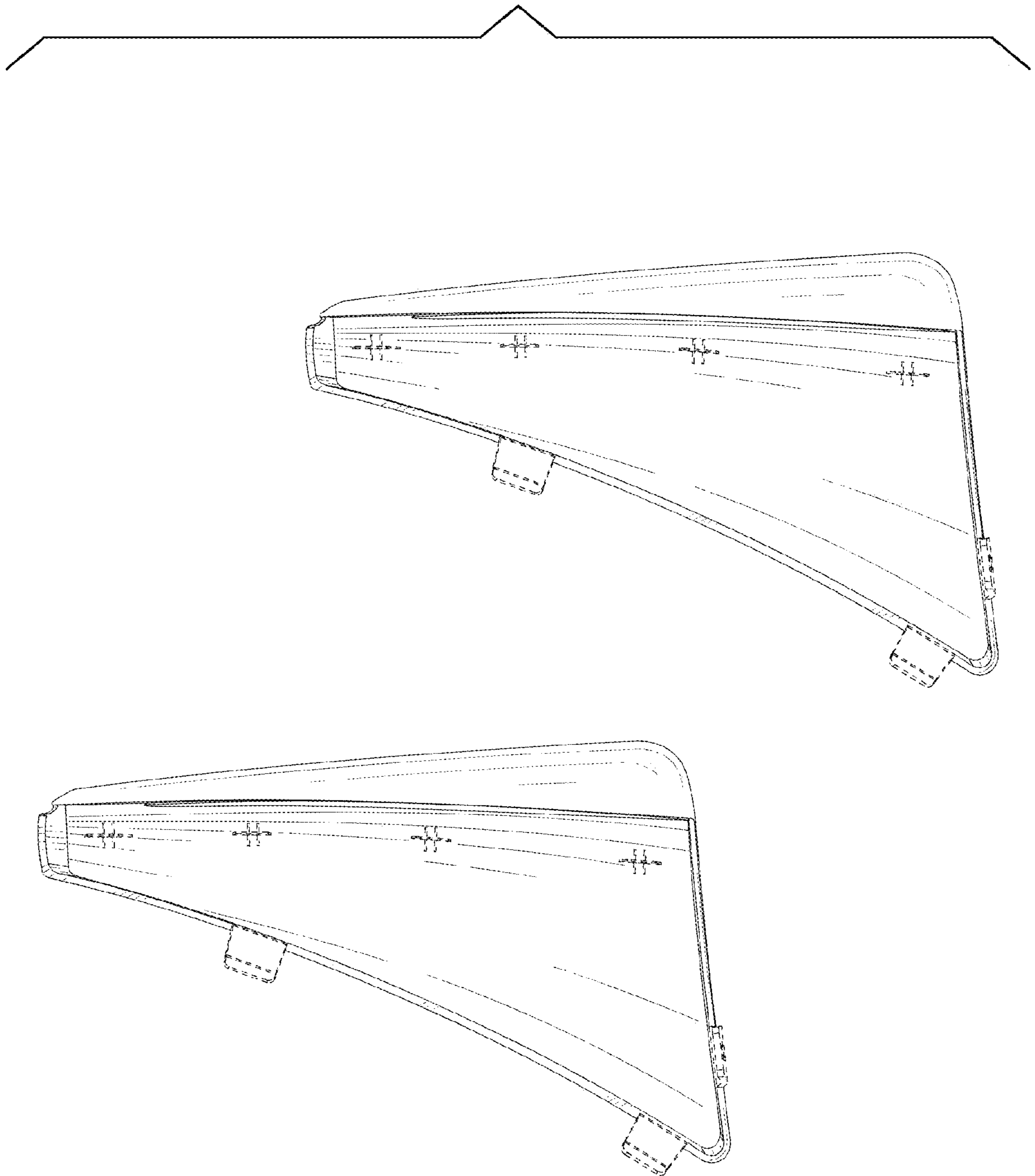

FIG. 6

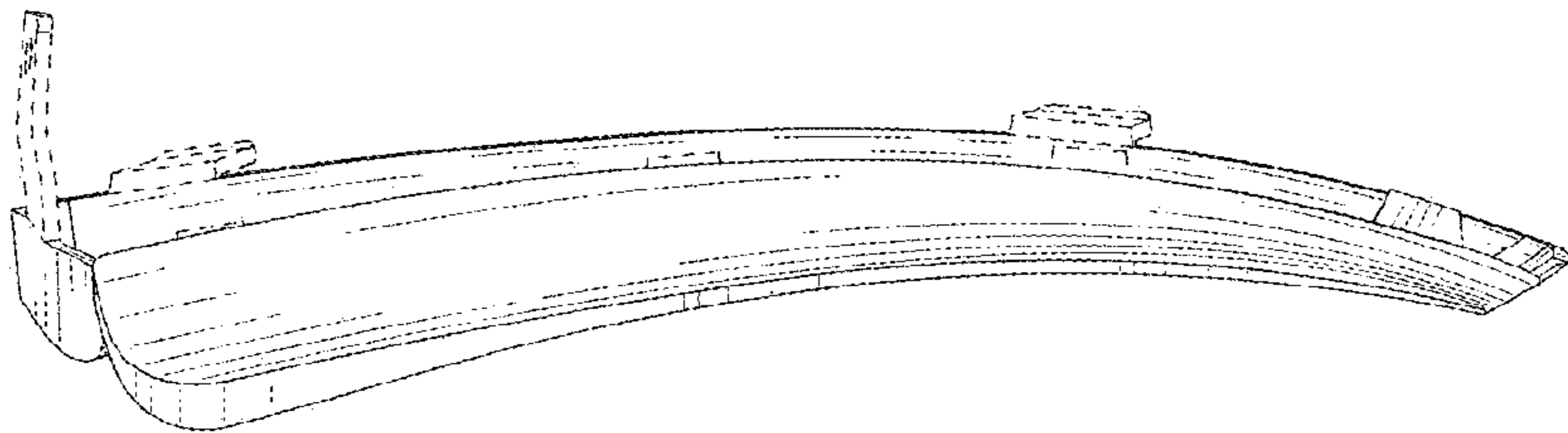
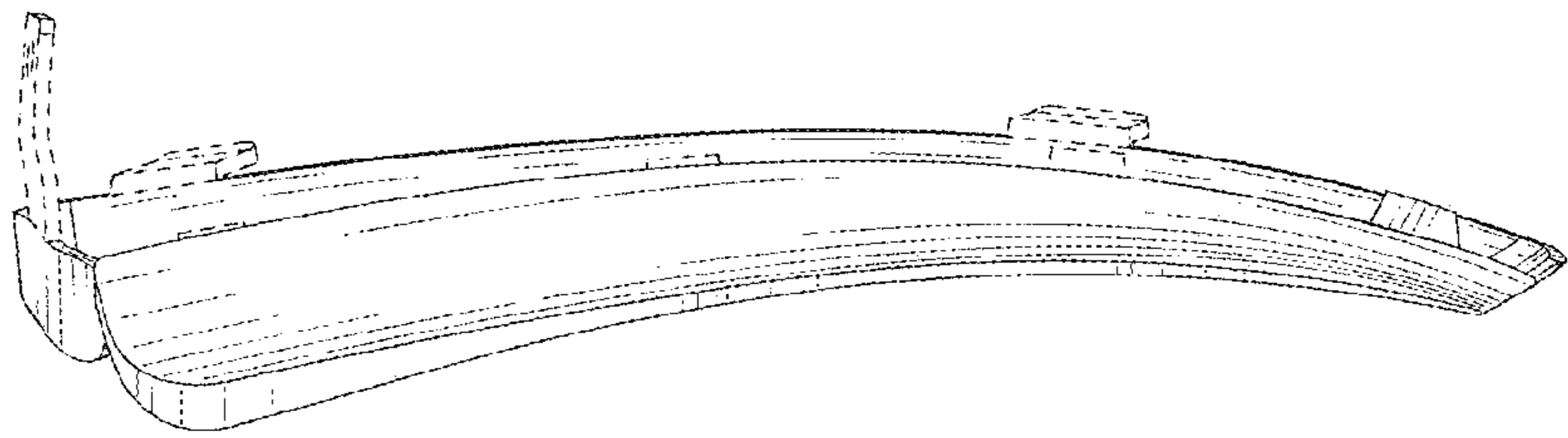

FIG. 7

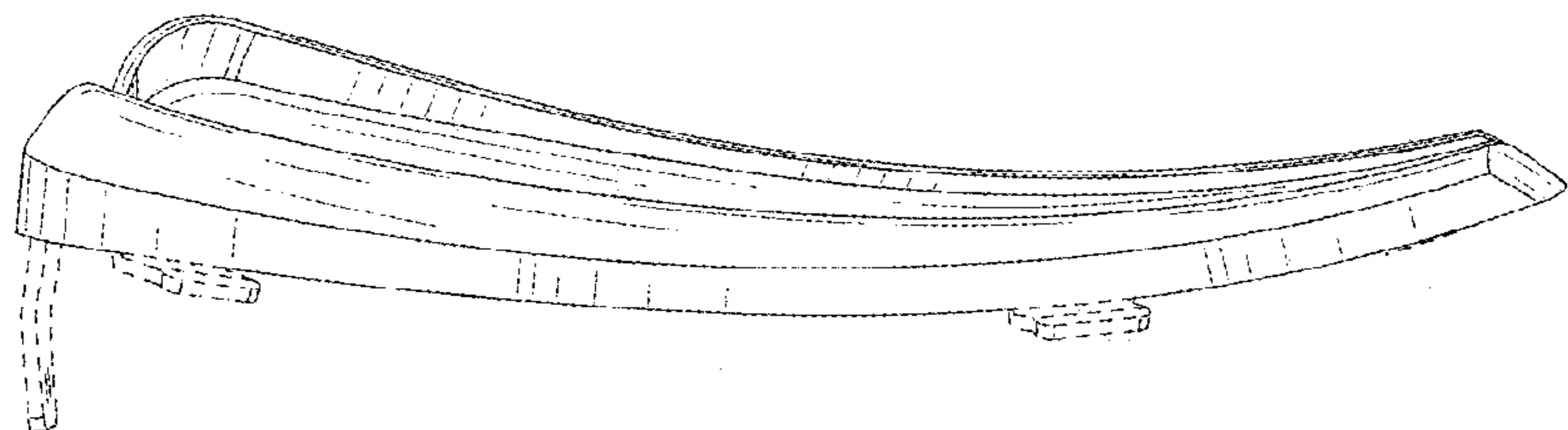
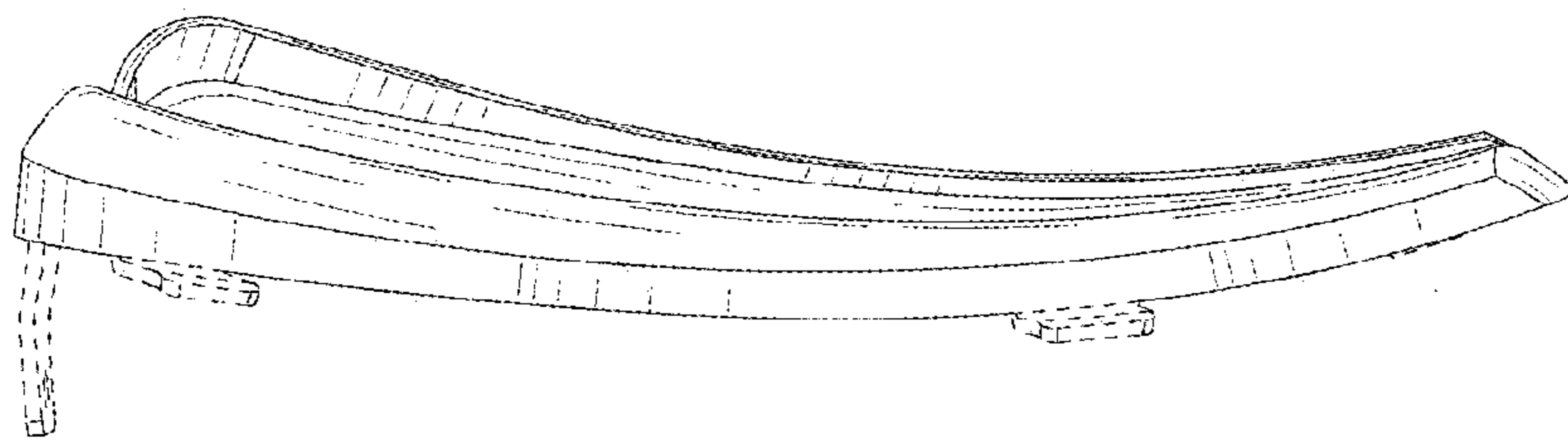

FIG. 8

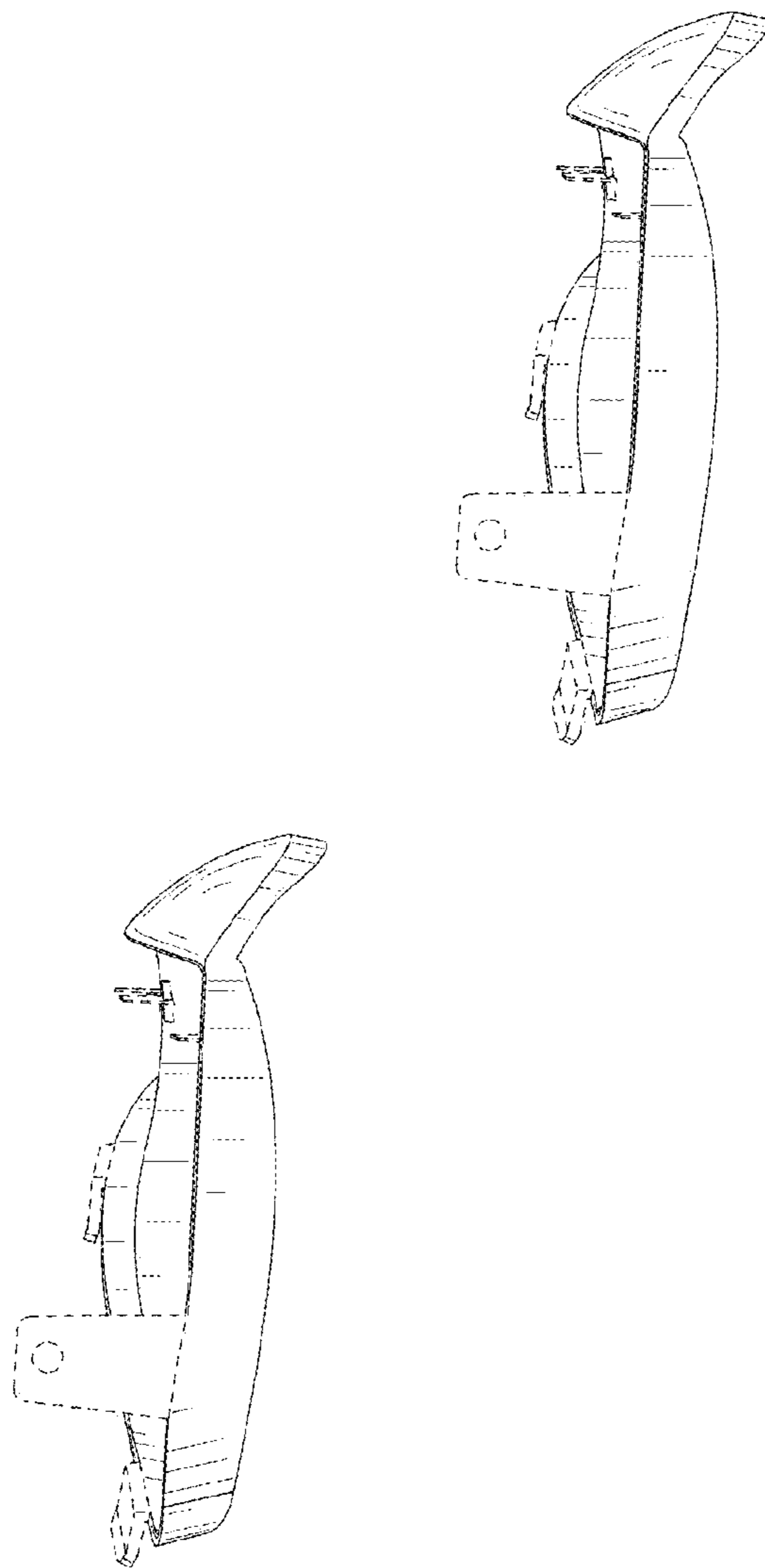

FIG. 9

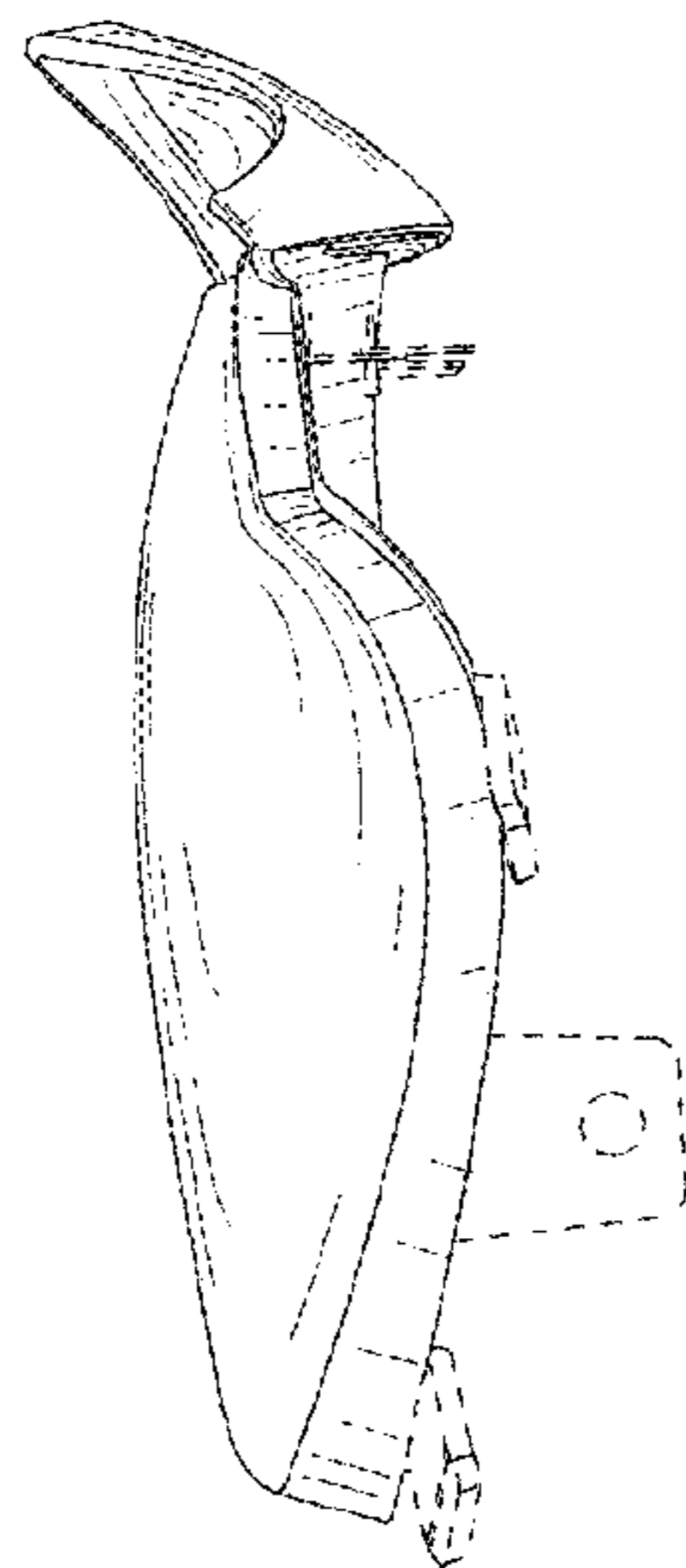
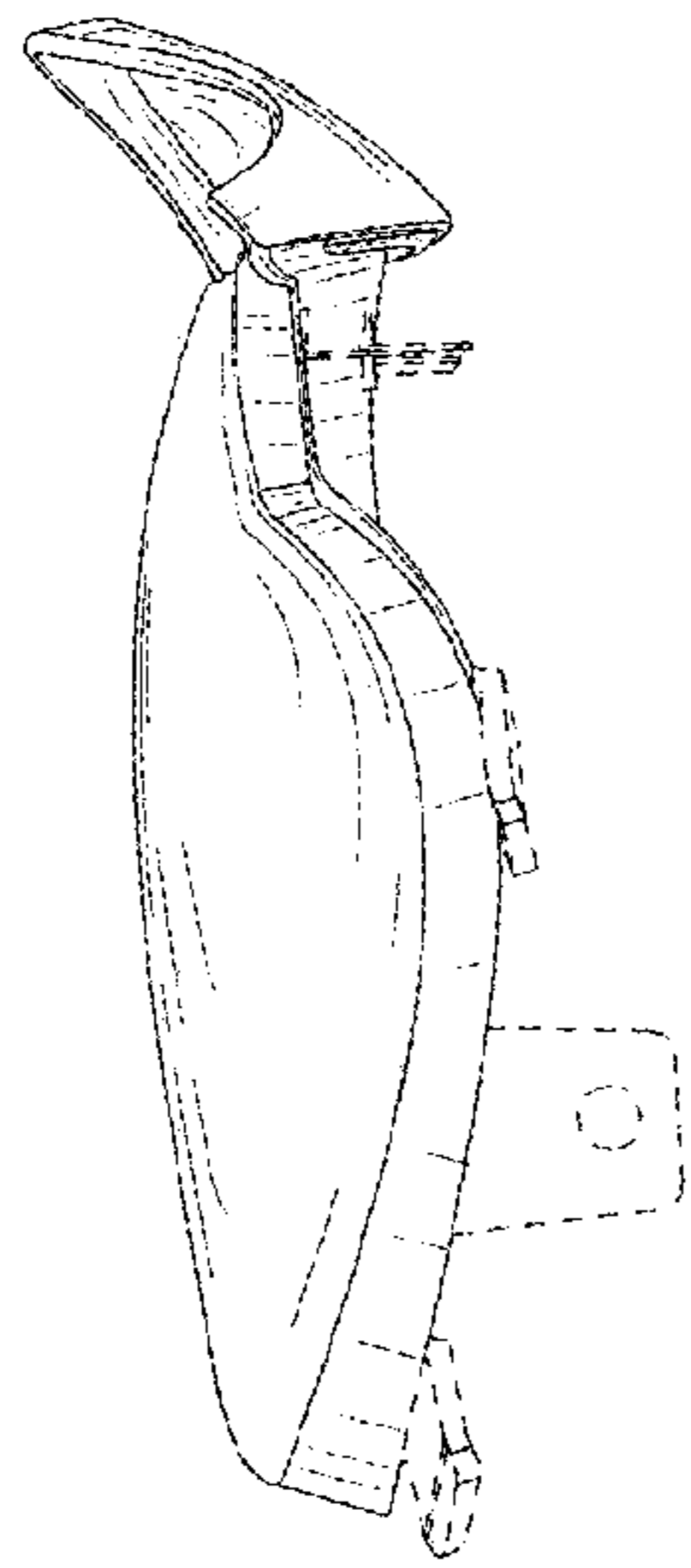

FIG. 10