



US0D1041695S

(12) **United States Design Patent** (10) **Patent No.:** **US D1,041,695 S**
Qian (45) **Date of Patent:** **** Sep. 10, 2024**

(54) **LADDER LIGHT**

(71) Applicant: **Qiuju Qian**, Zhejiang (CN)

(72) Inventor: **Qiuju Qian**, Zhejiang (CN)

(*) Notice: Patent file contains an affidavit/declaration under 37 CFR 1.130(b).

(**) Term: **15 Years**

(21) Appl. No.: **29/925,305**

(22) Filed: **Jan. 23, 2024**

(51) **LOC (14) Cl.** **26-04**

(52) **U.S. Cl.**

USPC **D26/25**

(58) **Field of Classification Search**

USPC D26/25, 26, 57, 61, 67, 68, 72, 93, 94, D26/101

(Continued)

(56) **References Cited**

U.S. PATENT DOCUMENTS

D323,195 S * 1/1992 Gehlbach D11/118
D368,439 S * 4/1996 Romero D11/118

(Continued)

FOREIGN PATENT DOCUMENTS

CN 307595855 * 10/2022
CN 307998862 * 4/2023

OTHER PUBLICATIONS

Amazon | Muyun LED Christmas Light 4.3ft Christmas Decorative Ladder Tree Lights . . . posted on Sep. 7, 2023, © 1996-2024, Amazon.com, Inc. [online], site visited Apr. 30, 2024. Available from Internet, <https://www.amazon.com/Christmas-Decorations-Ladder-Lights-Outdoor/dp/B0CHJ8WML6/ref=asc_df_B0CMH75BCH/> (Year: 2023).*

(Continued)

Primary Examiner — Cary M Robinson
Assistant Examiner — Julie Marie Bailey

(74) *Attorney, Agent, or Firm* — Kunzler Bean & Adamson, PC; Bryan Pitt

(57) **CLAIM**

The ornamental design for a ladder light, as shown and described.

DESCRIPTION

FIG. 1 is a front, right and top perspective view of a ladder light, showing my design.

FIG. 2 is a rear, left and bottom perspective view thereof.

FIG. 3 is a front elevation view thereof.

FIG. 4 is a rear elevation view thereof.

FIG. 5 is a left side elevation view thereof.

FIG. 6 is a right side elevation view thereof.

FIG. 7 is a top plan view thereof.

FIG. 8 is a bottom plan view thereof.

FIG. 9 is an enlarged view of detail 9 in FIG. 1.

FIG. 10 is an enlarged view of detail 10 in FIG. 1.

FIG. 11 is a front, right and top perspective view of a ladder light in FIG. 1 without the top piece.

FIG. 12 is a rear, left and bottom perspective view of FIG. 11.

FIG. 13 is a front elevation view of FIG. 11.

FIG. 14 is a rear elevation view of FIG. 11.

FIG. 15 is a left side elevation view of FIG. 11.

FIG. 16 is a right side elevation view of FIG. 11.

FIG. 17 is a top plan view of FIG. 11.

FIG. 18 is a bottom plan view of FIG. 11.

FIG. 19 is an enlarged view of detail 19 in FIG. 11.

FIG. 20 is an enlarged view of detail 20 in FIG. 11.

FIG. 21 is another front, right and top perspective view of the ladder light shown in FIG. 11 in an alternate configuration of use.

FIG. 22 is another front, right and top perspective view of the ladder light shown in FIG. 11 in an alternate configuration of use.

FIG. 23 is another front, right and top perspective view of the ladder light shown in FIG. 11 in an alternate configuration of use; and,

(Continued)

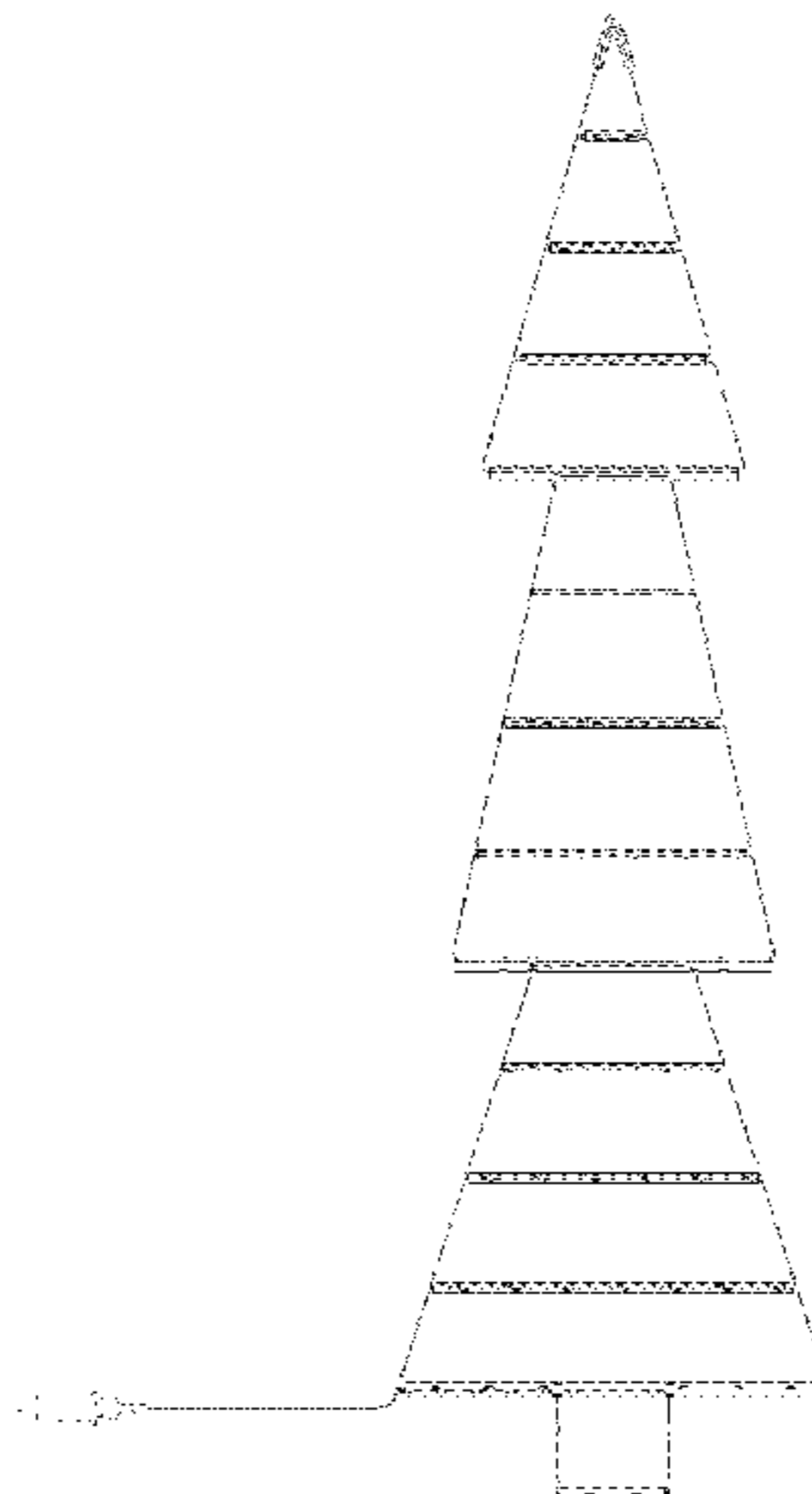

FIG. 24 is another front, right and top perspective view of the ladder light shown in FIG. 11 in an alternate configuration of use.

The broken lines depict portions of the Ladder Light that form no part of the claimed design. The dot-dash broken lines in FIGS. 1, 9, 10, 11, 19 and 20 depict the boundaries of the enlargements that form no part of the claimed design.

1 Claim, 24 Drawing Sheets

(58) Field of Classification Search

CPC F21S 4/10; F21S 4/15; Y10S 362/806; F21W 2121/004; F21Y 2115/10; F21Y 2103/10; F21V 21/008

See application file for complete search history.

(56) References Cited

U.S. PATENT DOCUMENTS

5,712,770 A * 1/1998 Huang F21S 4/20 362/249.16
D982,194 S * 3/2023 Qian D26/25

D984,688 S * 4/2023 Zhou D26/25
D994,165 S 8/2023 Zhou
D997,400 S * 8/2023 Yu D26/25
D1,002,882 S * 10/2023 Liao D26/25
D1,003,469 S * 10/2023 Su D26/25
D1,005,530 S 11/2023 Yu
D1,011,569 S * 1/2024 Zeng D26/25
2005/0248943 A1 * 11/2005 Tsai F21S 4/20 362/249.01

OTHER PUBLICATIONS

Newegg | Funiao (New) Christmas Decoration Lights, 4.6ft LED Ladder Lights, posted on Dec. 6, 2023, © 2000-2024 Newegg Inc. [online], site visited Apr. 30, 2024. Available from Internet, <https://www.newegg.com/p/0VV-026C-00046?item=9SIBMYWK3N7059&source=region> (Year: 2023).*

* cited by examiner

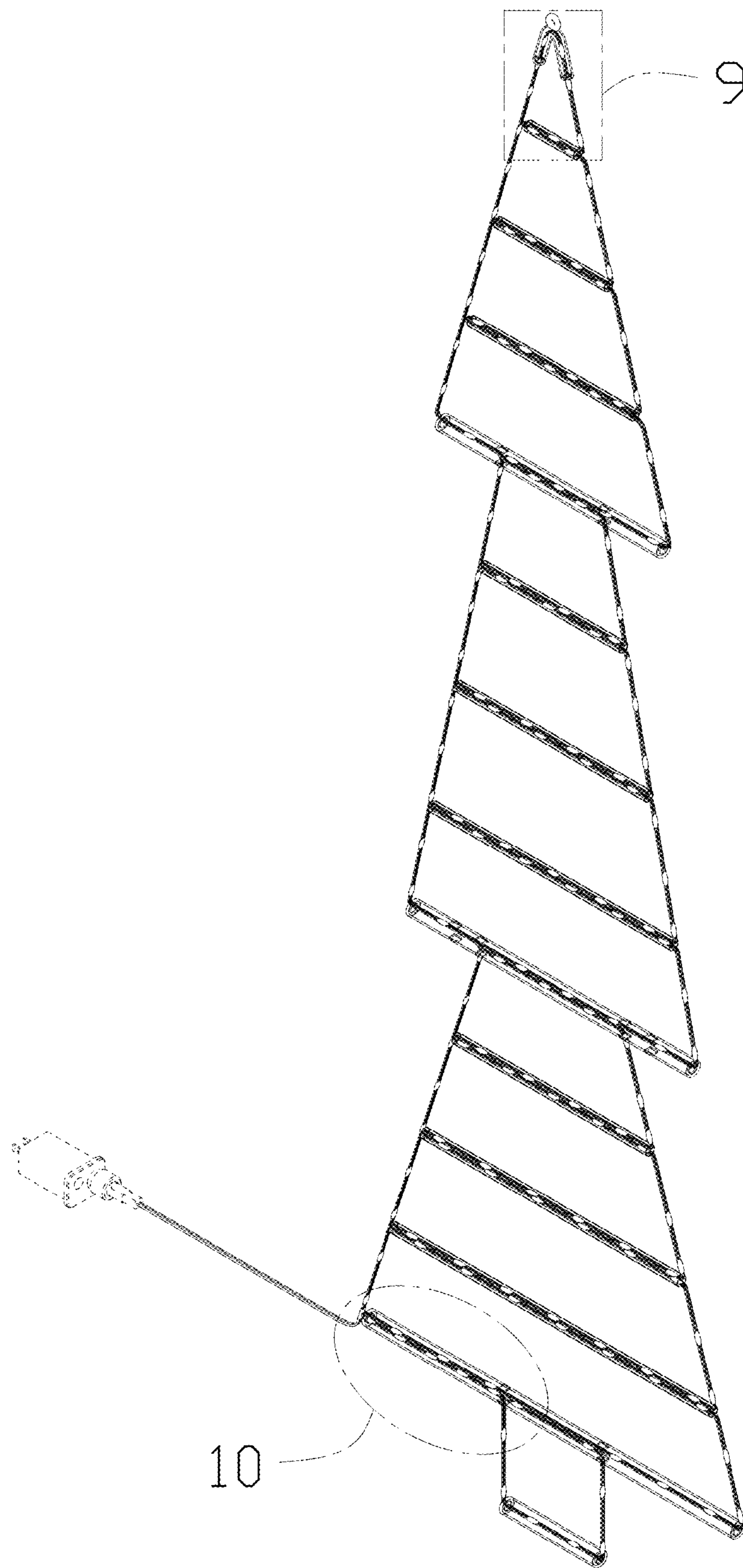

10

9

FIG. 1

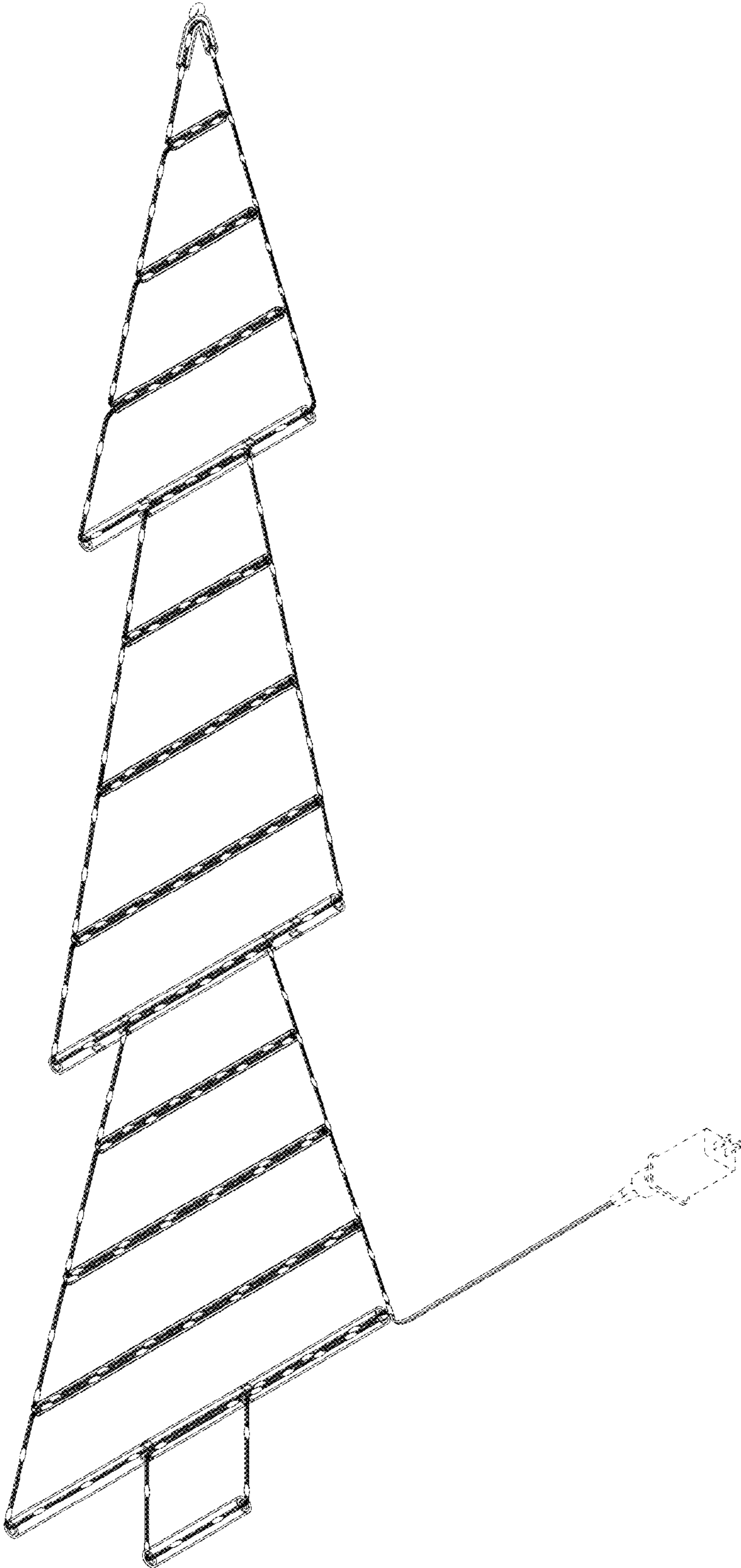

FIG. 2

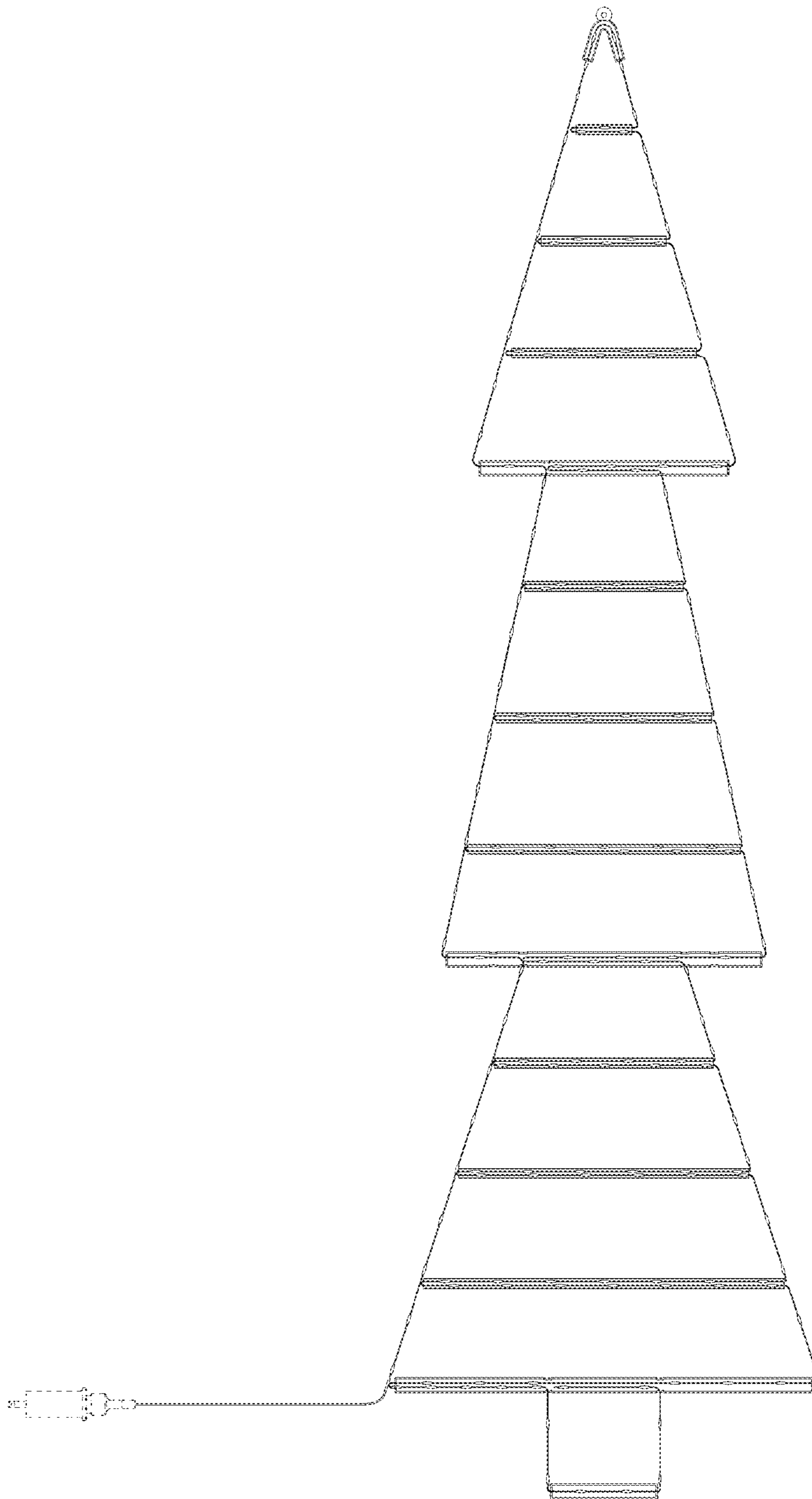

FIG. 3

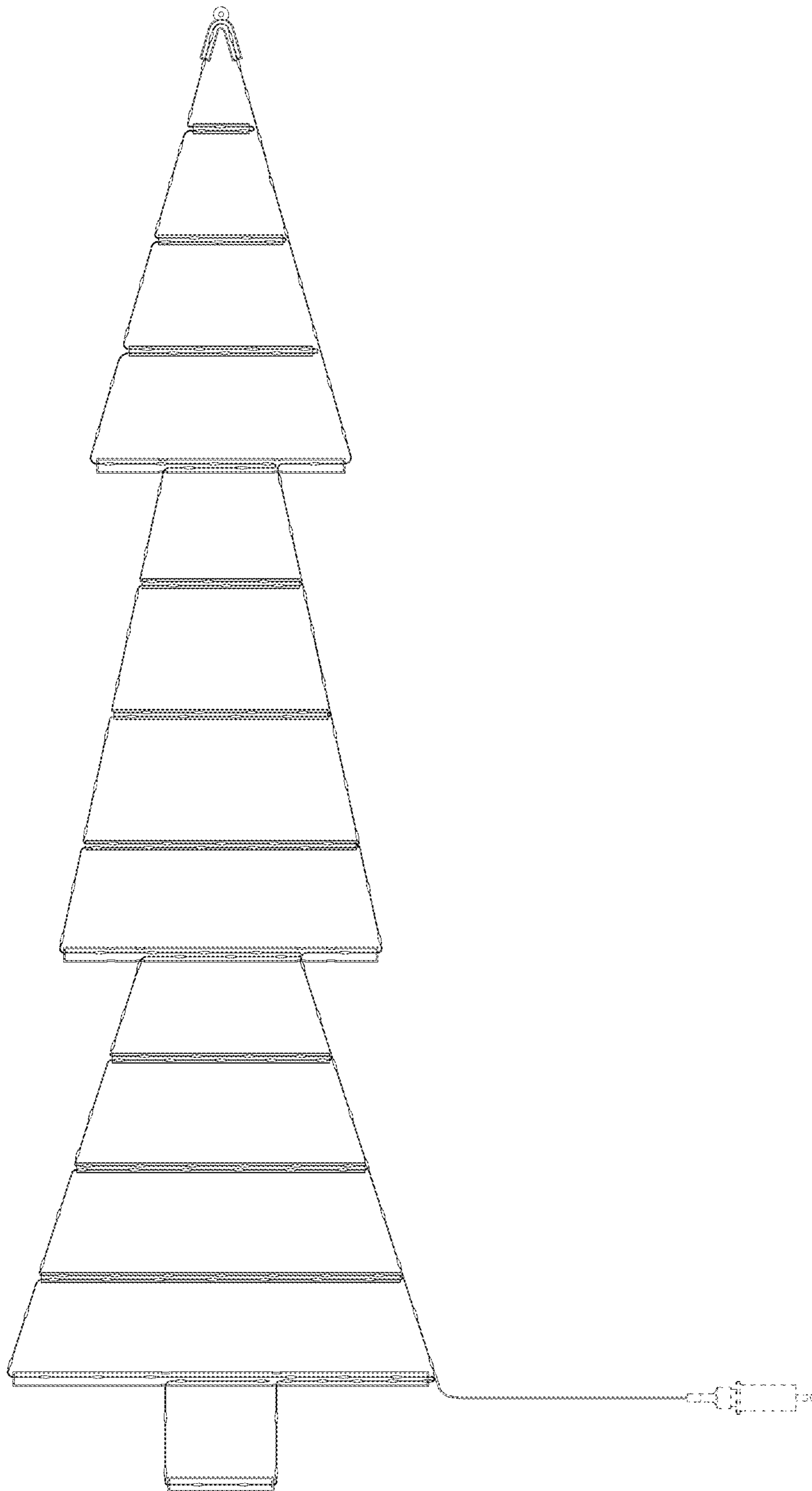

FIG. 4

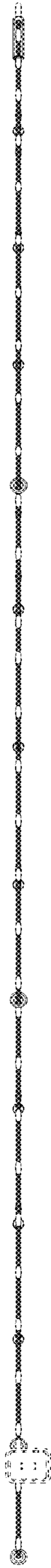

FIG. 5

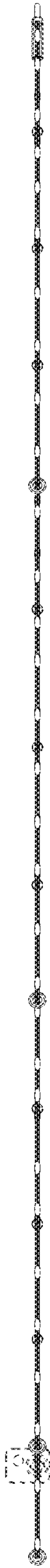

FIG. 6

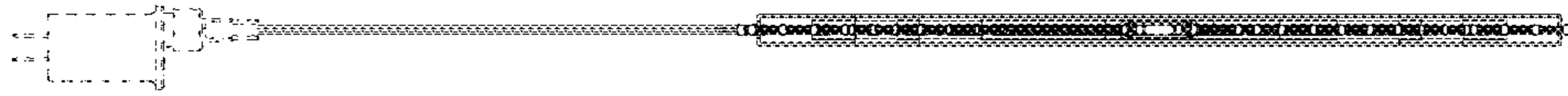

FIG. 7

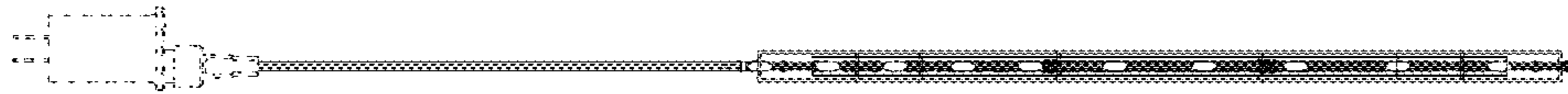

FIG. 8

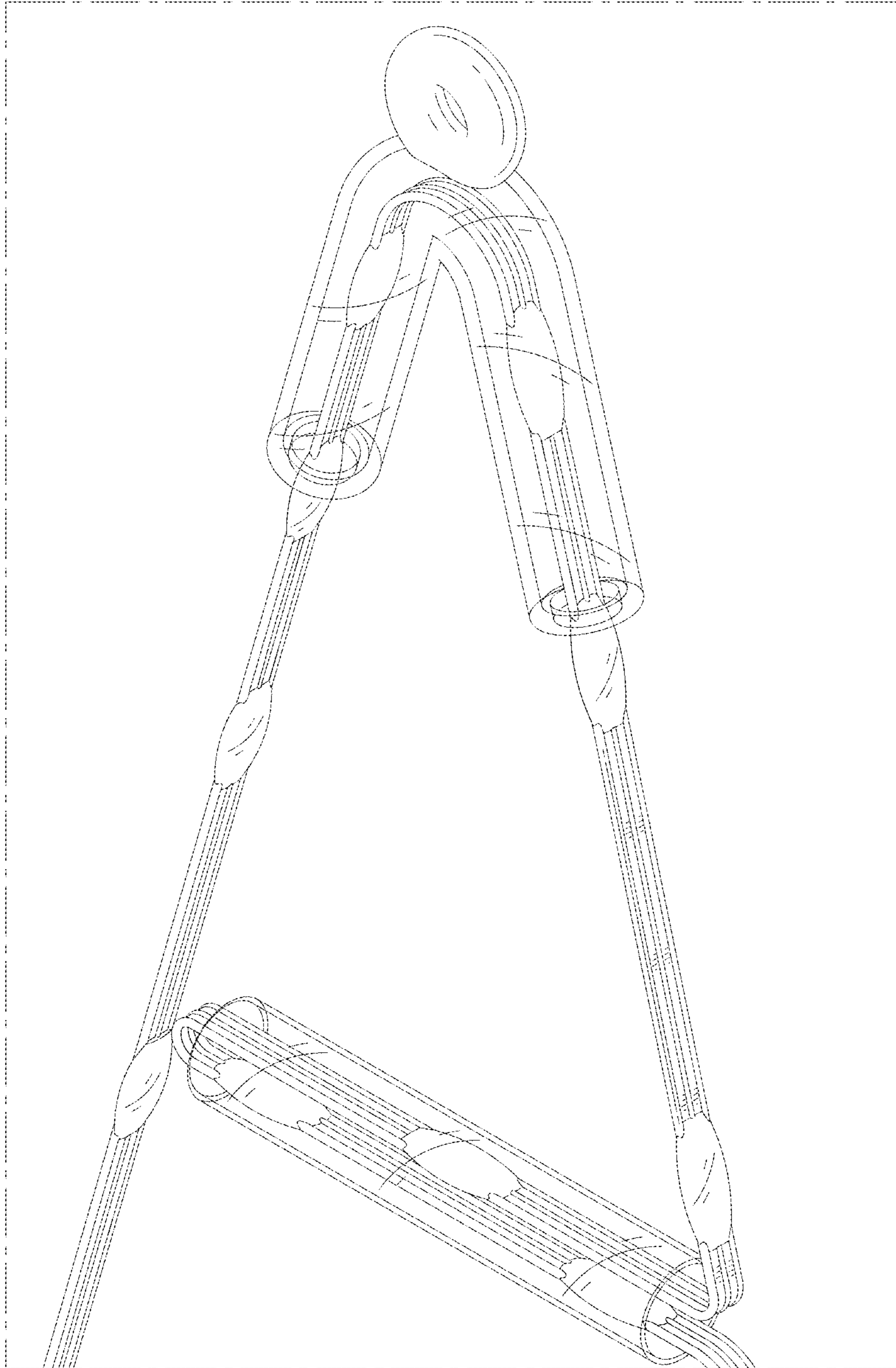

FIG. 9

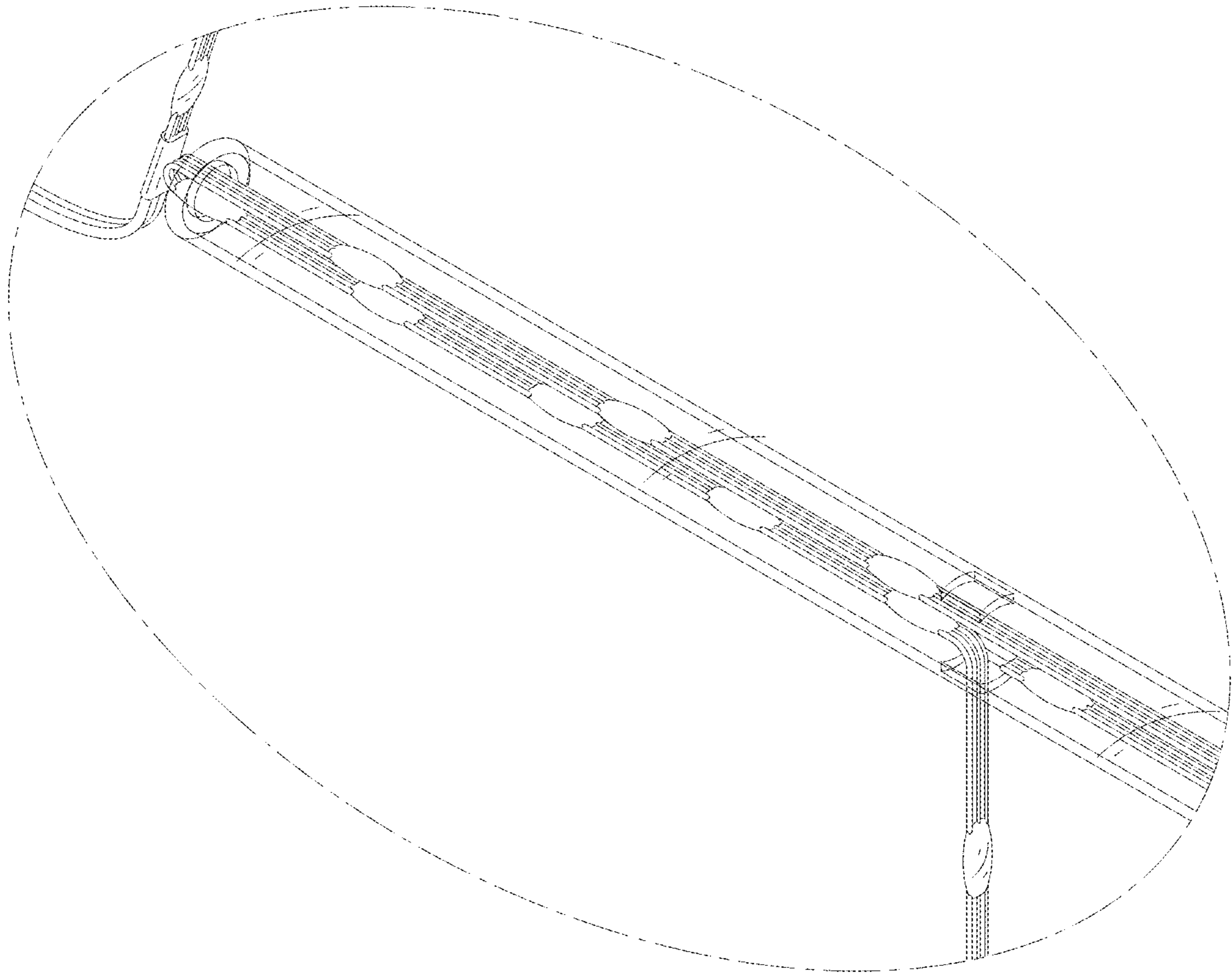

FIG. 10

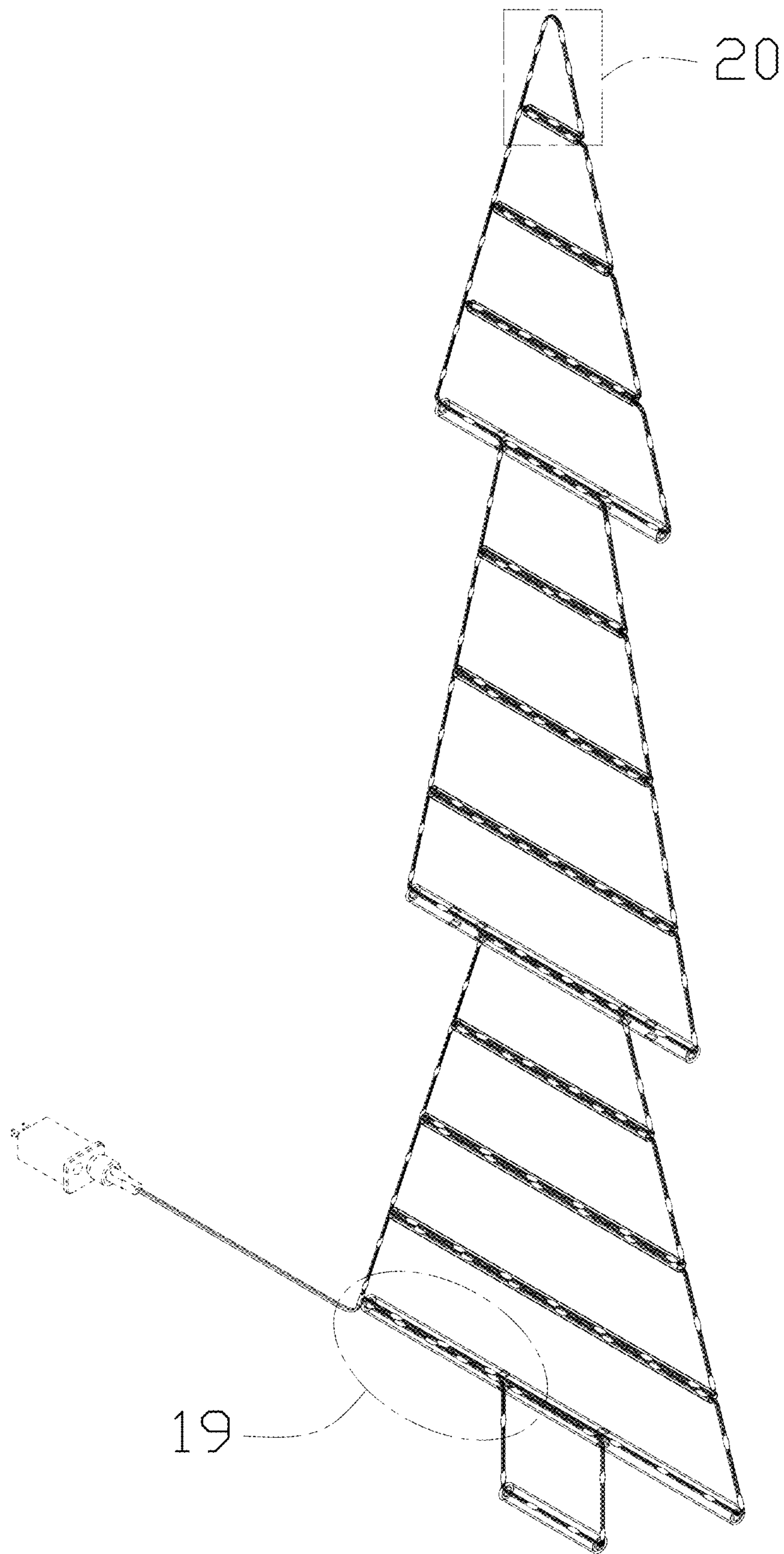

FIG. 11

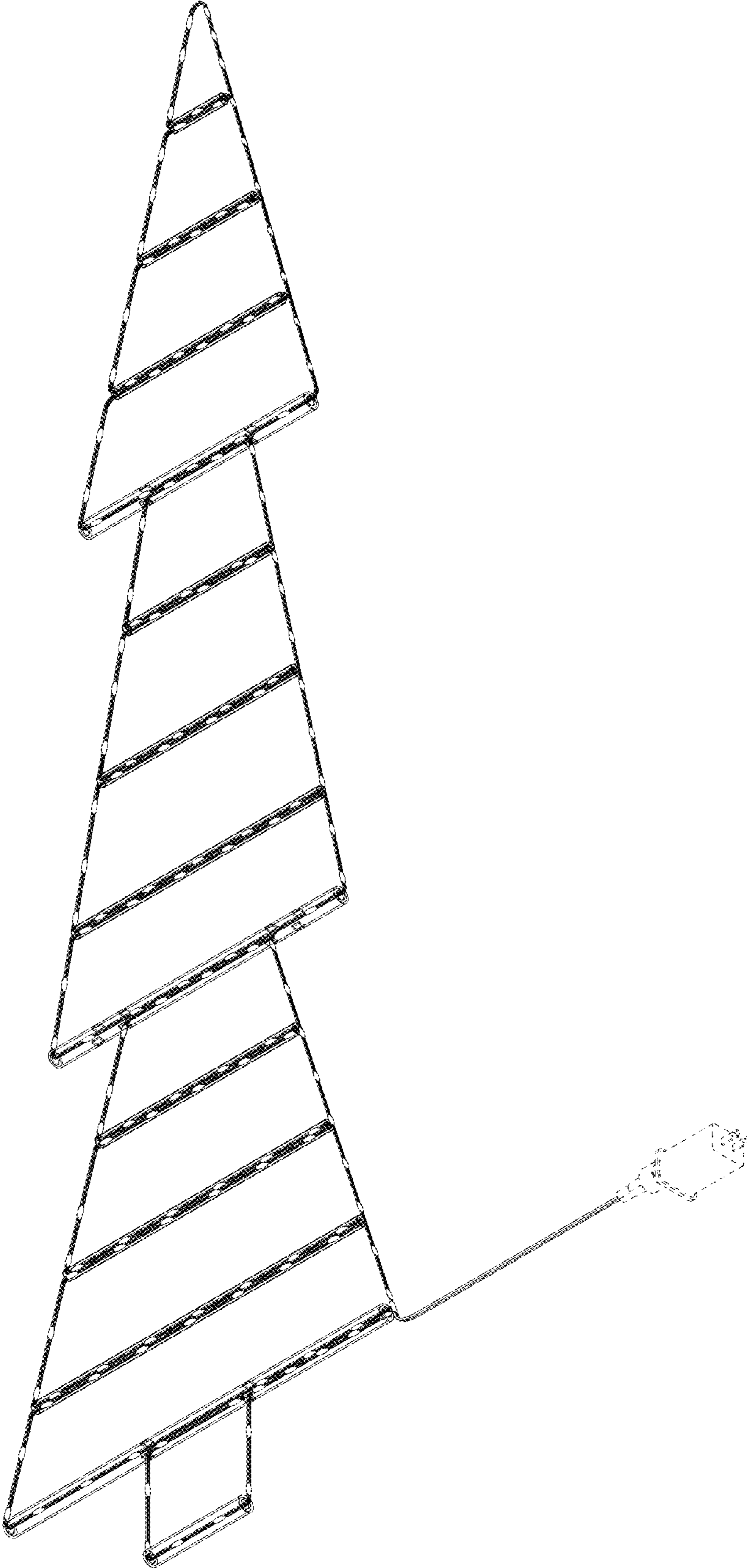

FIG. 12

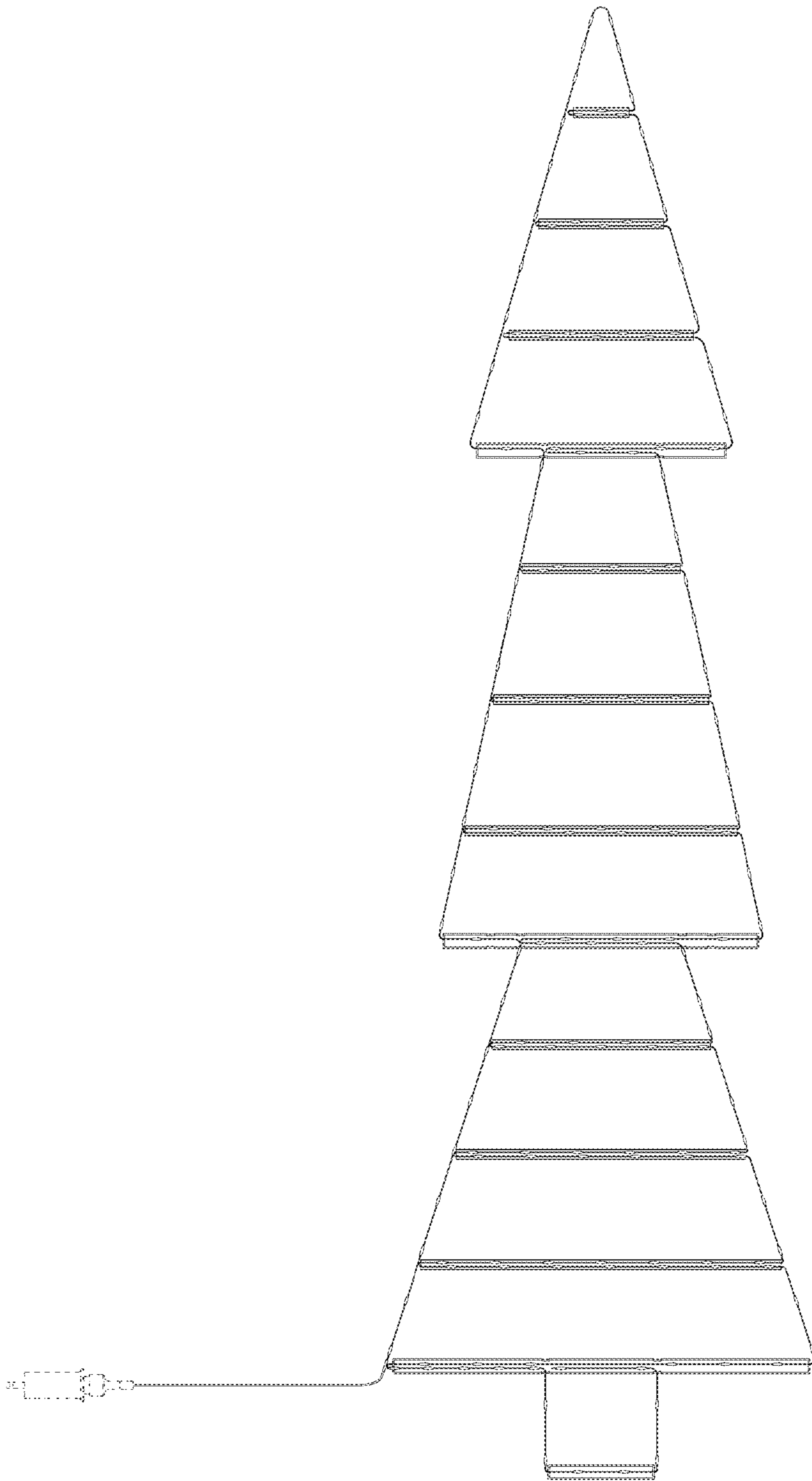

FIG. 13

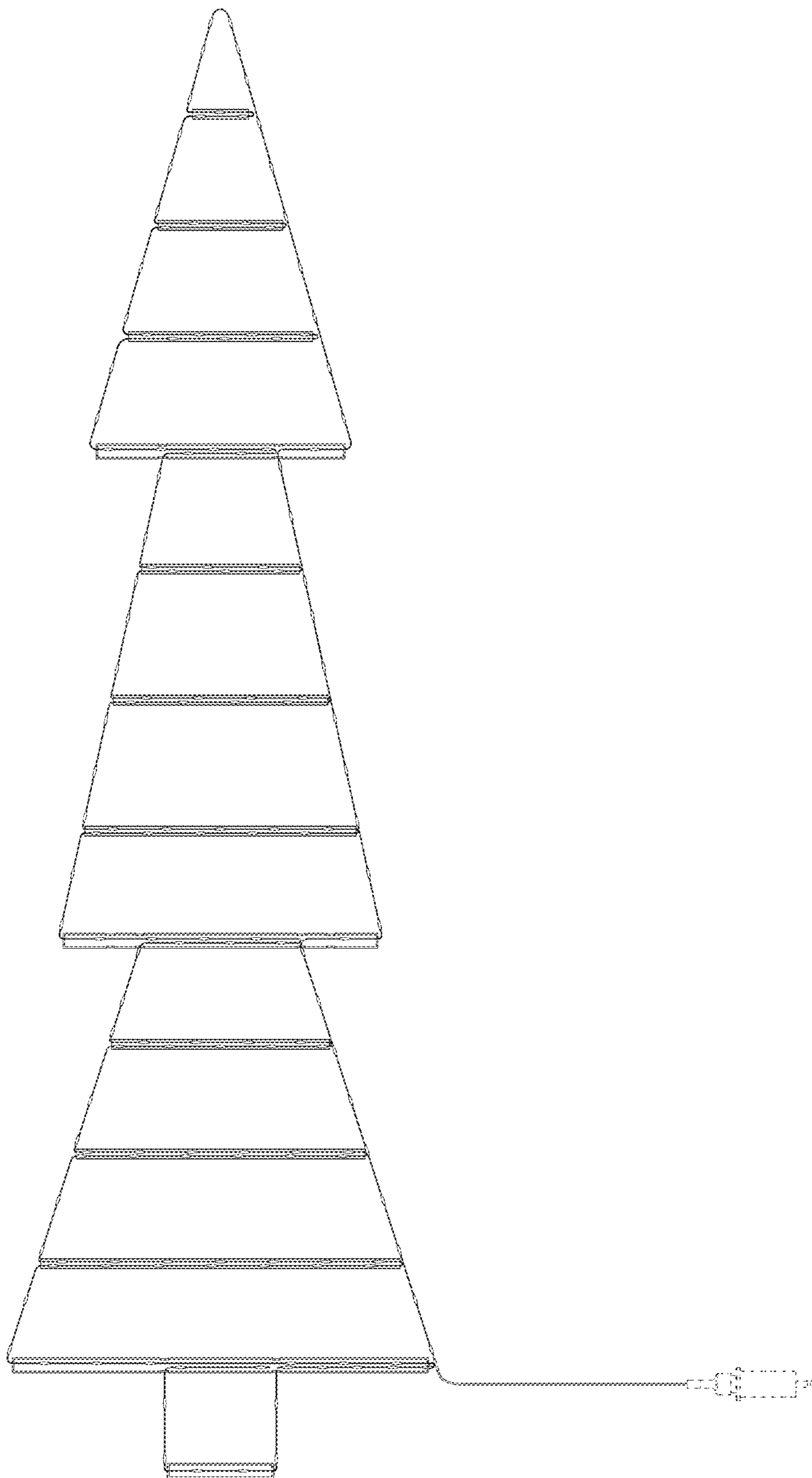

FIG. 14

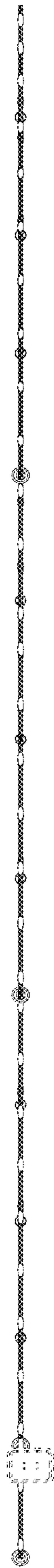

FIG. 15

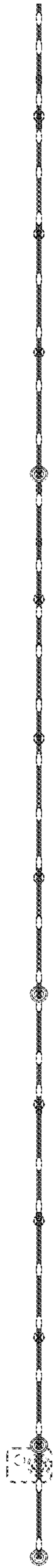

FIG. 16



FIG. 17

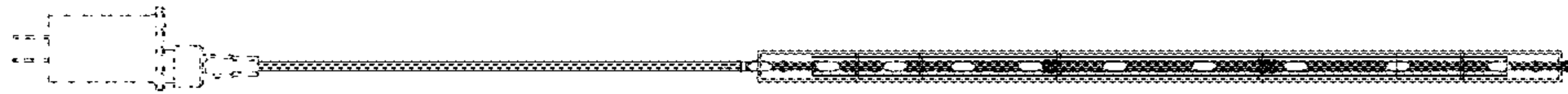

FIG. 18

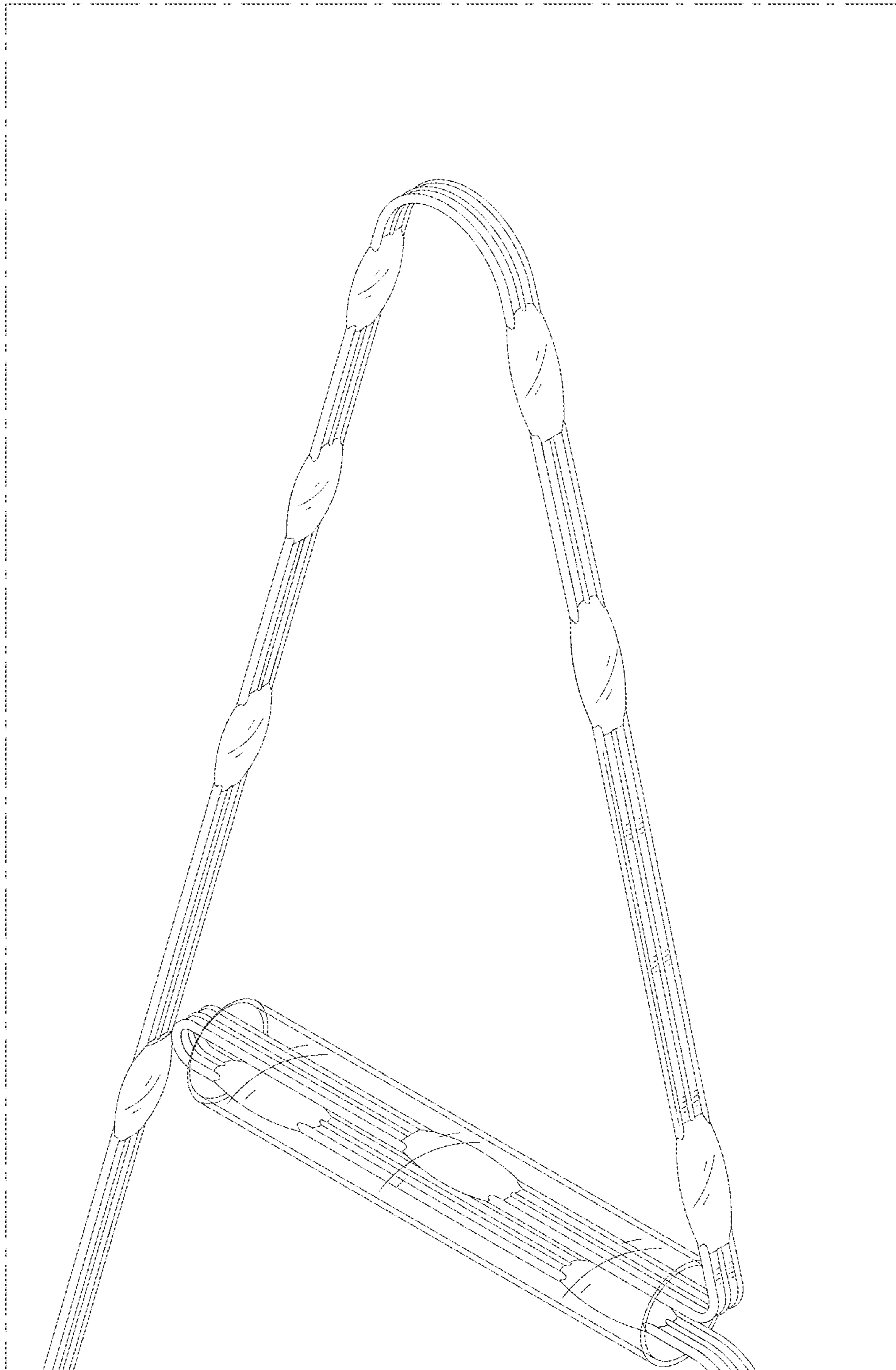

FIG. 19

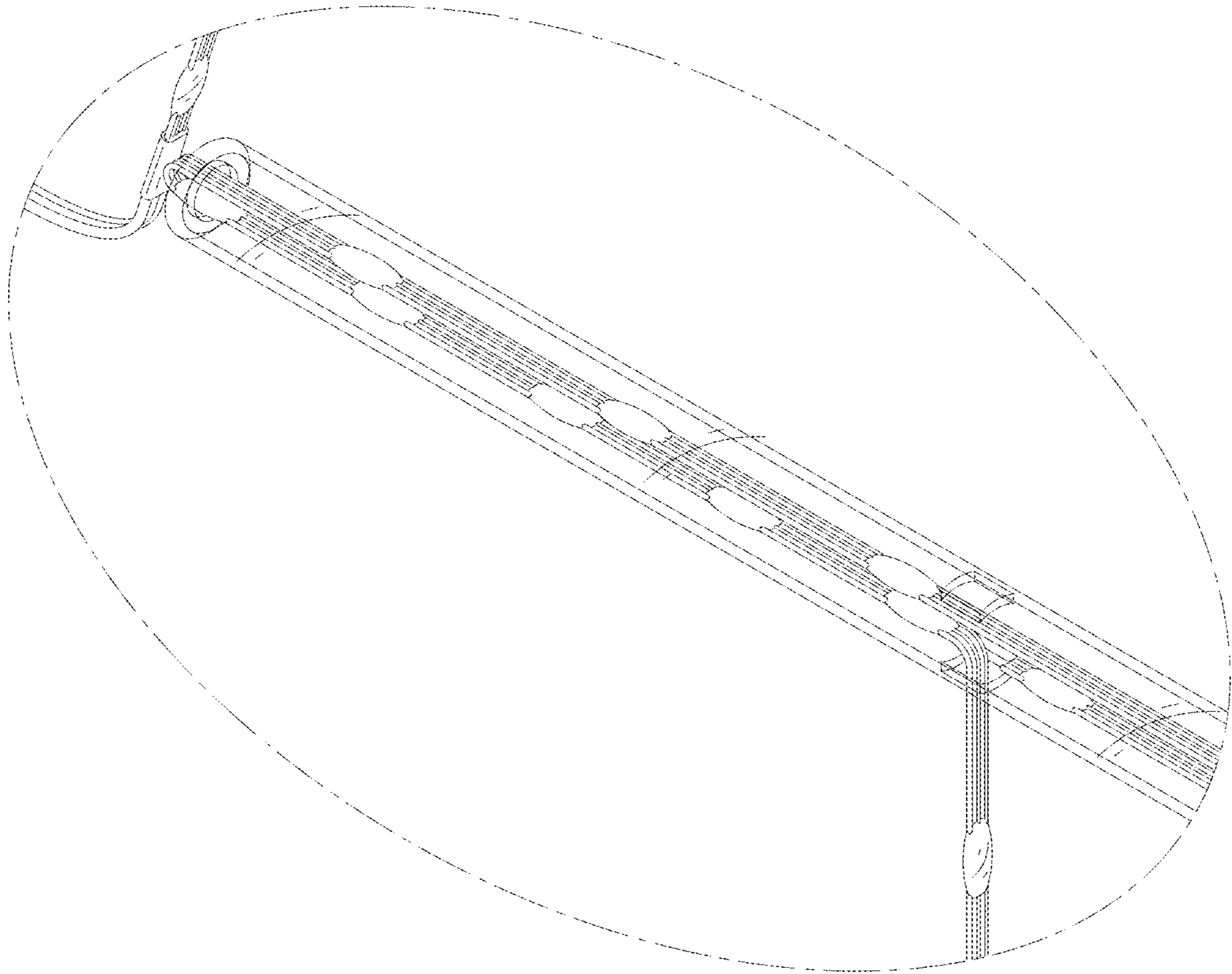

FIG. 20

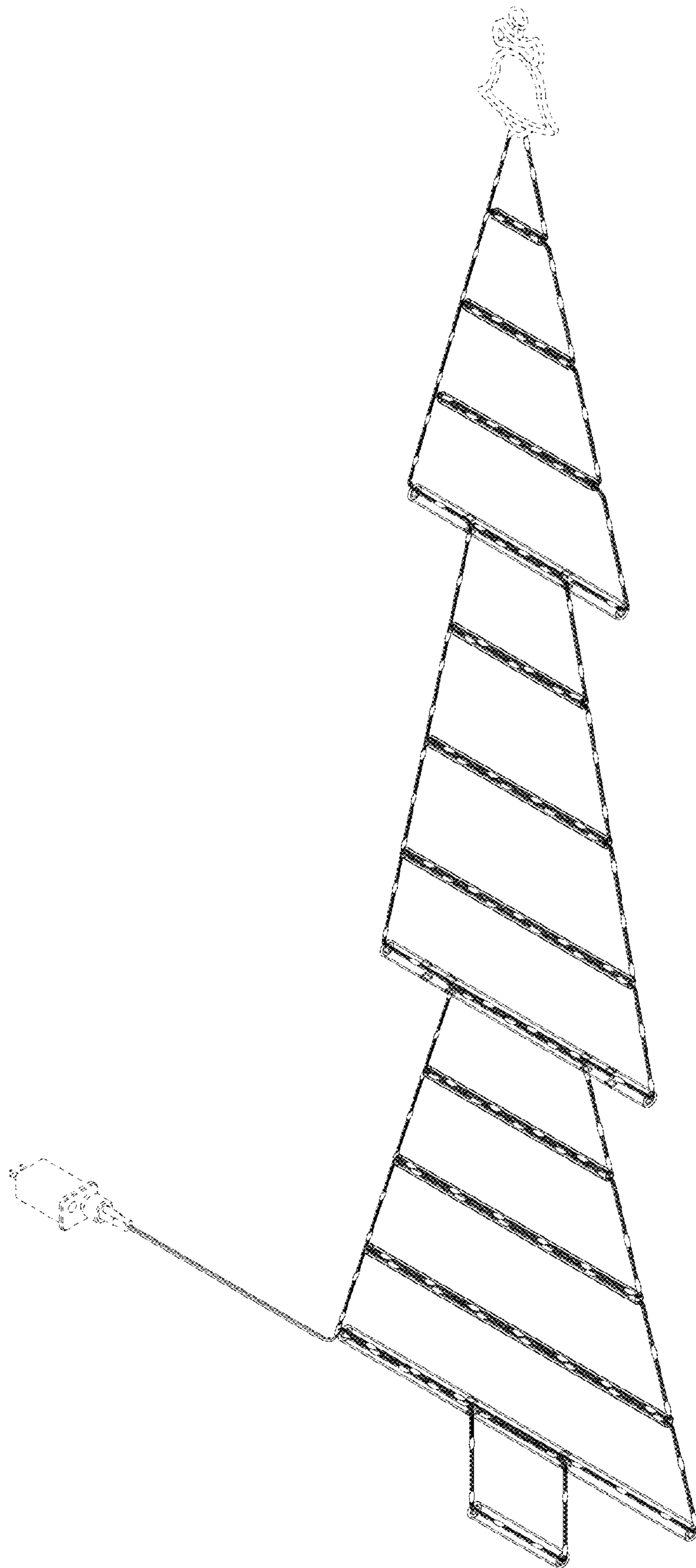

FIG. 21

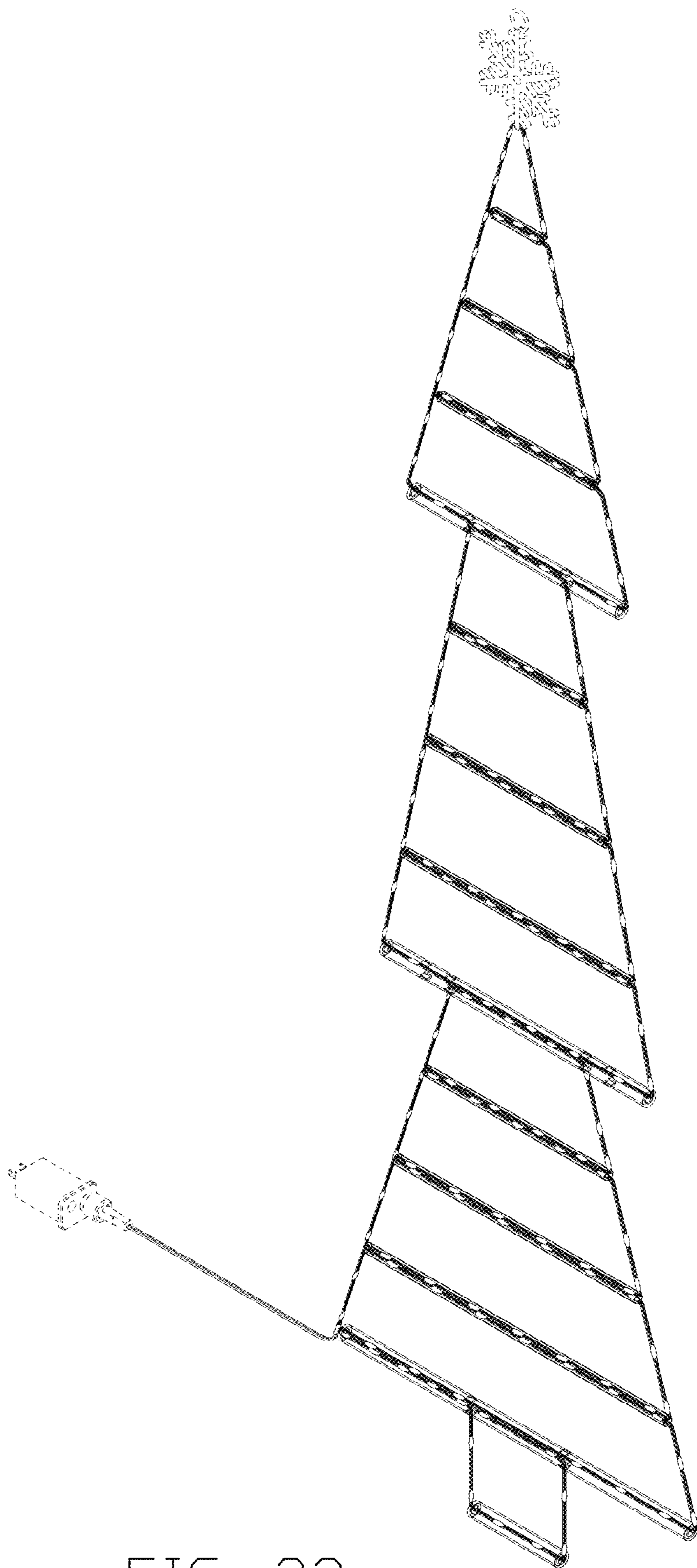

FIG. 22

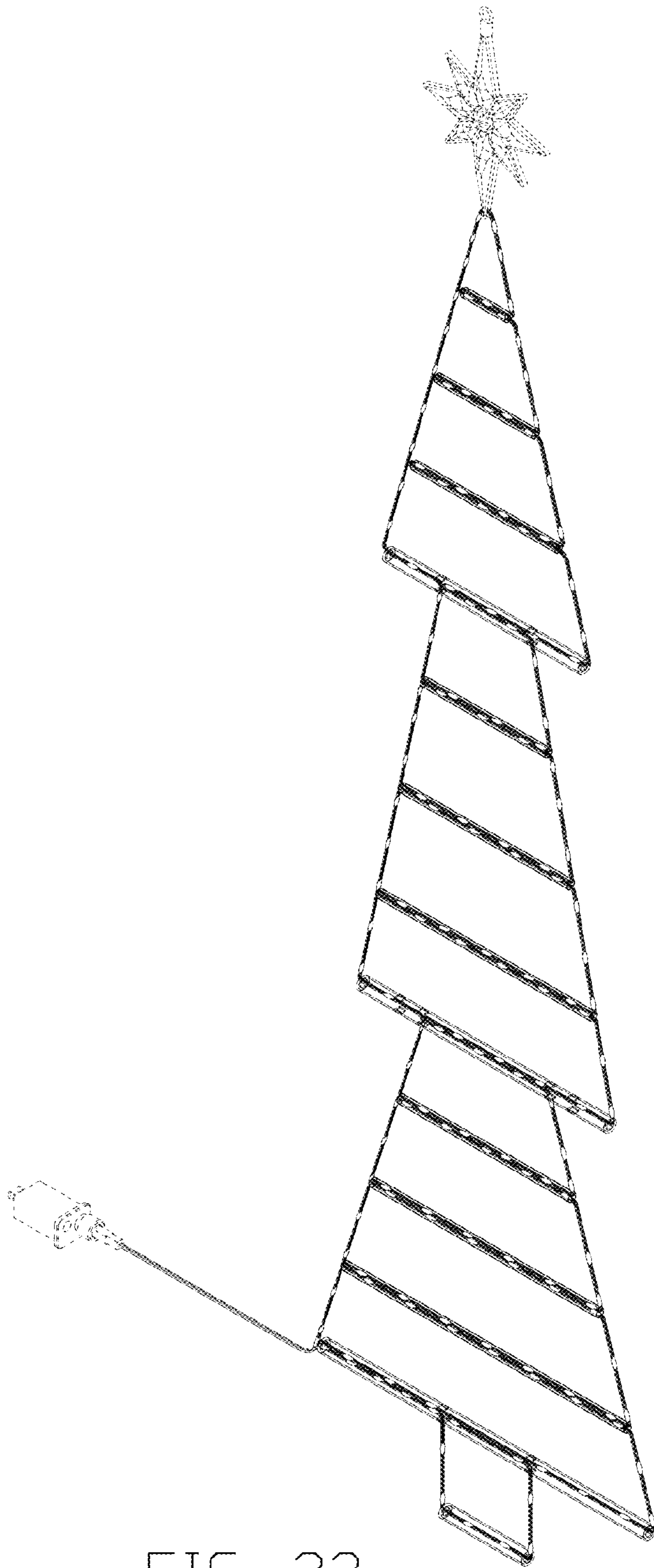

FIG. 23

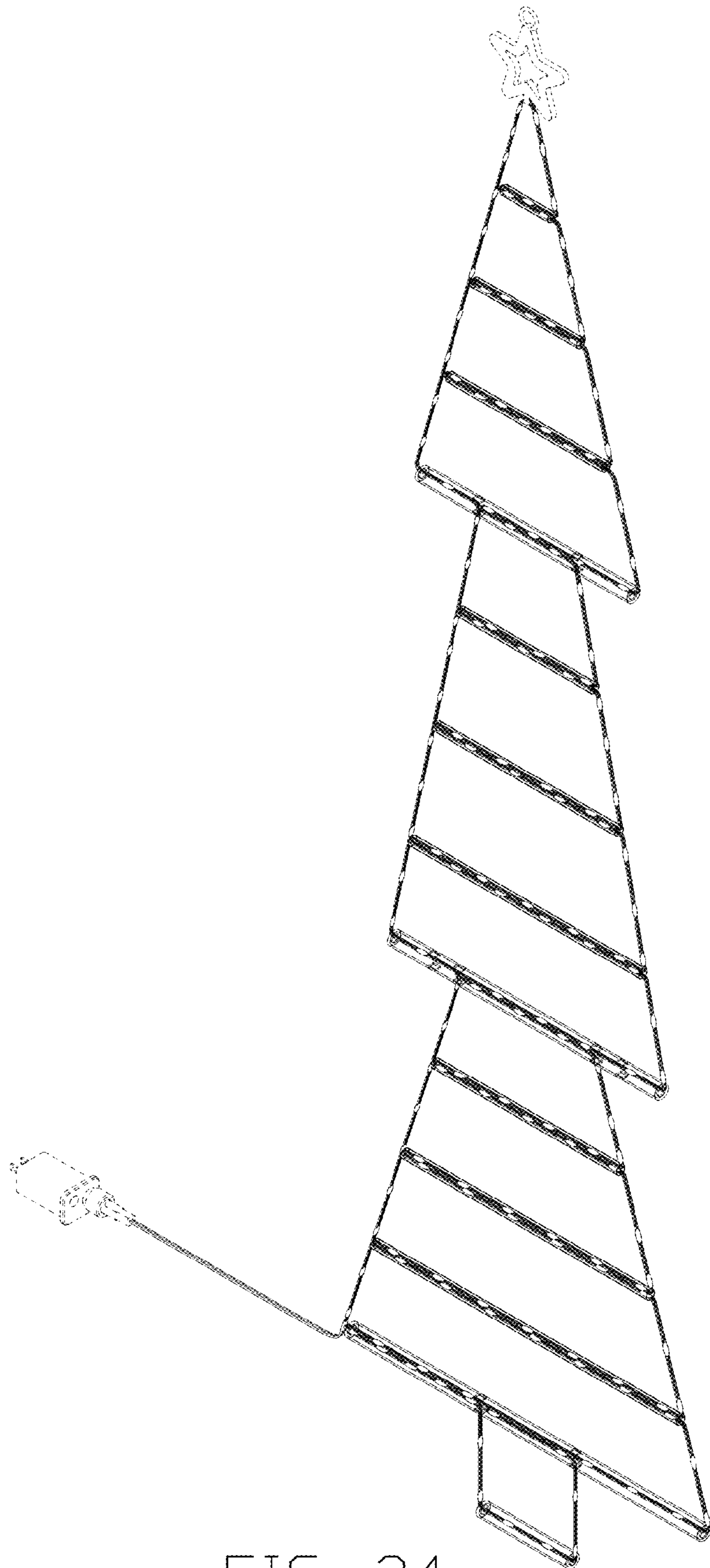

FIG. 24