



US0D1039228S

(12) **United States Design Patent** (10) **Patent No.:** **US D1,039,228 S**
Duan (45) **Date of Patent:** **** Aug. 13, 2024**

(54) **MAKEUP BRUSH CLEANER MACHINE**

FOREIGN PATENT DOCUMENTS

(71) Applicant: **Jiaxian Duan**, Shenzhen (CN)
(72) Inventor: **Jiaxian Duan**, Shenzhen (CN)
(**) Term: **15 Years**

CN 102179381 A * 9/2011
CN 303467126 * 11/2015
CN 109157146 A * 1/2019
CN 210523181 U * 5/2020
CN 308638544 * 5/2024
EM 015054732-0001 * 4/2024

(21) Appl. No.: **29/935,187**

OTHER PUBLICATIONS

(22) Filed: **Mar. 29, 2024**

(51) **LOC (14) Cl.** **15-05**

(52) **U.S. Cl.**
USPC **D32/1**

(58) **Field of Classification Search**
USPC D32/1
CPC A61C 19/002; B08B 3/12
See application file for complete search history.

CoStyle Ultrasonic Cleaner, Walmart website 2024, site visited May 24, 2024, <https://www.walmart.com/ip/COSTYLE-Ultrasonic-Cleaner-22W-48KHz-Portable-Professional-Ultrasonic-Cleaner-Machine-for-Cleaning-Eyeglass-Watches-Dentures-Ring-Blade-Razor/5757016299>.*

* cited by examiner

Primary Examiner — John R Yeh

(56) **References Cited**

U.S. PATENT DOCUMENTS

D306,784 S * 3/1990 Fung D32/35
D406,416 S * 3/1999 Chan D32/1
D414,904 S * 10/1999 Knowlton D32/1
D516,257 S * 2/2006 Brackett D32/1
D524,998 S * 7/2006 Nickerson D32/1
D575,912 S * 8/2008 Mangano D32/1
D633,663 S * 3/2011 Choi D32/1
D747,835 S 1/2016 Barnard
D778,004 S * 1/2017 Yao D32/1
D815,373 S * 4/2018 Yao D32/1
D898,310 S * 10/2020 Miller D32/1
D900,416 S * 10/2020 Yao D32/1
D932,117 S 9/2021 Xiao
D996,747 S * 8/2023 Gu D24/217
D1,004,865 S * 11/2023 Yao D24/217
D1,011,657 S * 1/2024 Liao D32/35
2009/0308416 A1 * 12/2009 Utz B08B 3/12
134/115 R

(57) **CLAIM**

The ornamental design for a makeup brush cleaner machine, as shown and described.

DESCRIPTION

FIG. 1 is a top, front and right side perspective view of a makeup brush cleaner machine, showing my new design; FIG. 2 is a bottom, rear and left side perspective view thereof; FIG. 3 is a front elevational view thereof; FIG. 4 is a rear elevational view thereof; FIG. 5 is a left side elevational view thereof; FIG. 6 is a right side elevational view thereof; FIG. 7 is a bottom plan view thereof; and, FIG. 8 is a top plan view thereof.

1 Claim, 8 Drawing Sheets

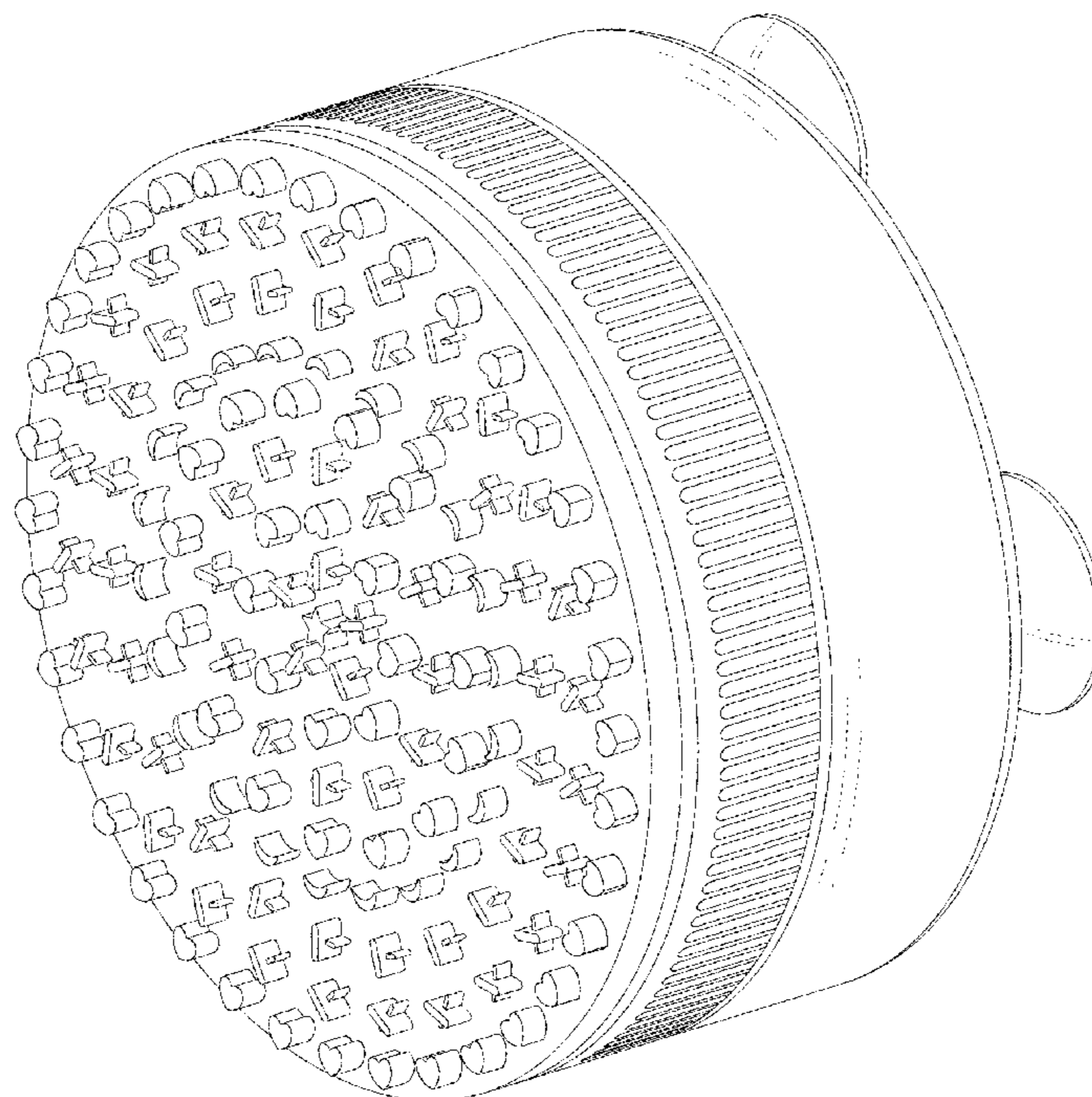

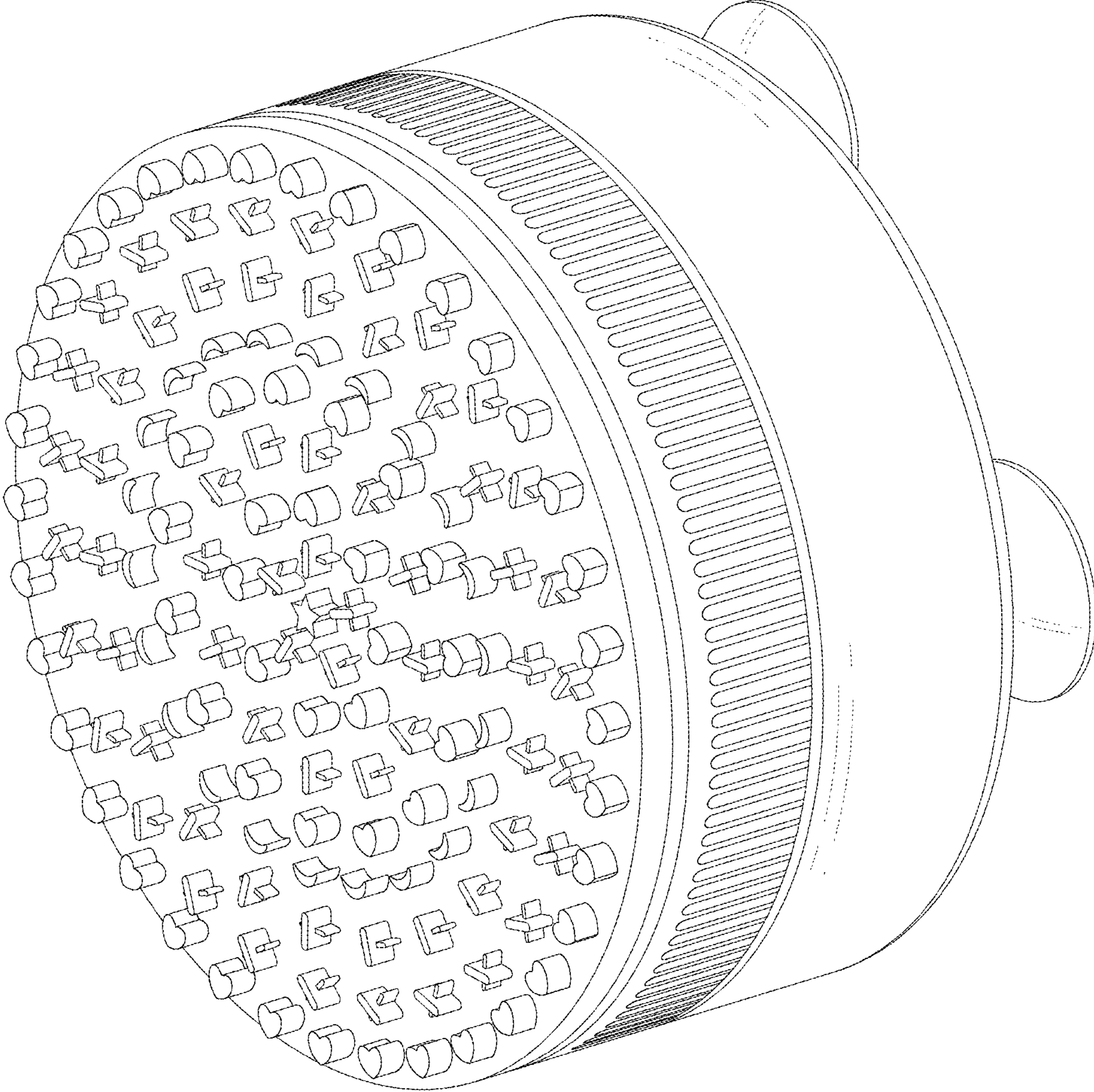

FIG. 1

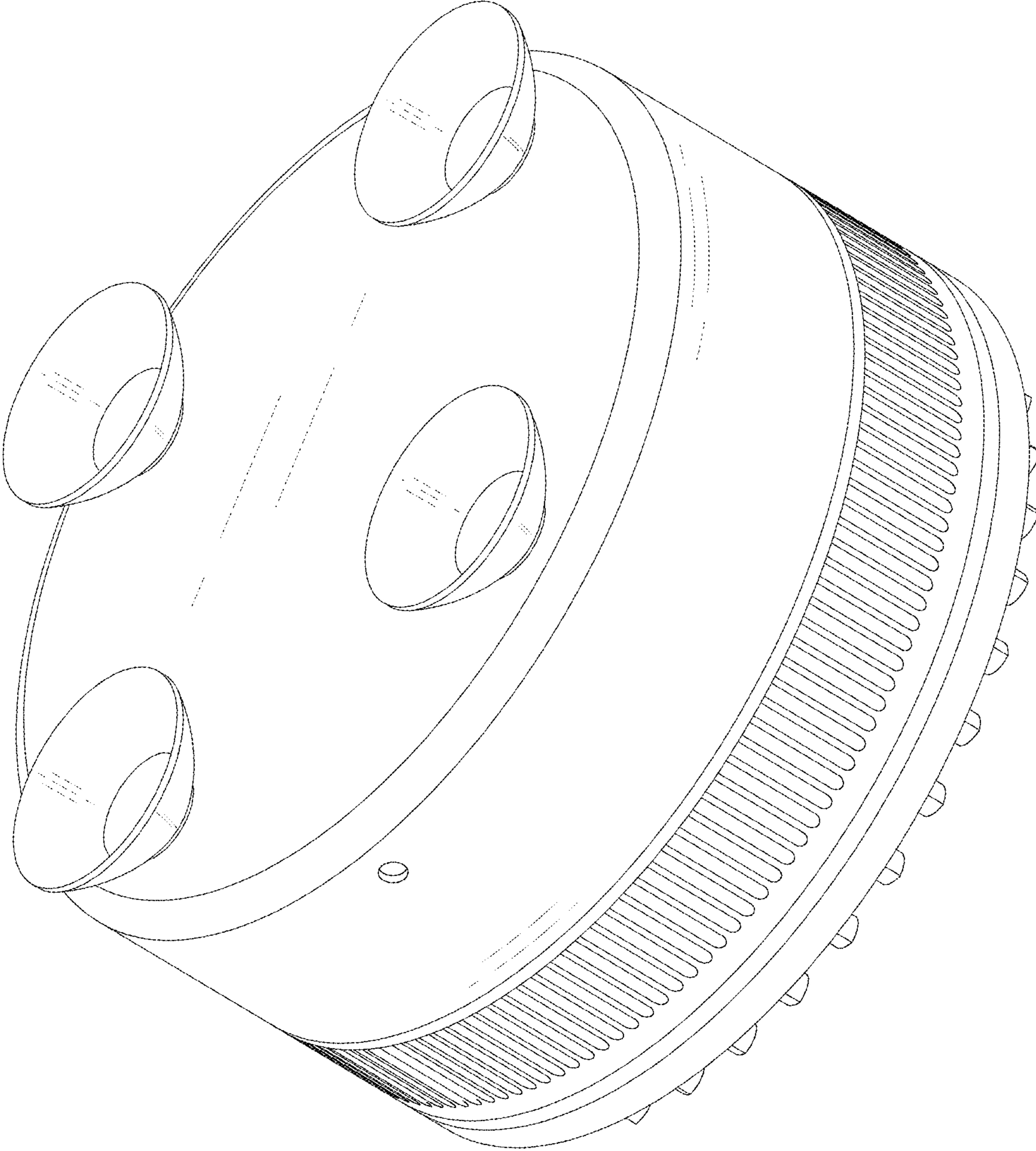

FIG. 2

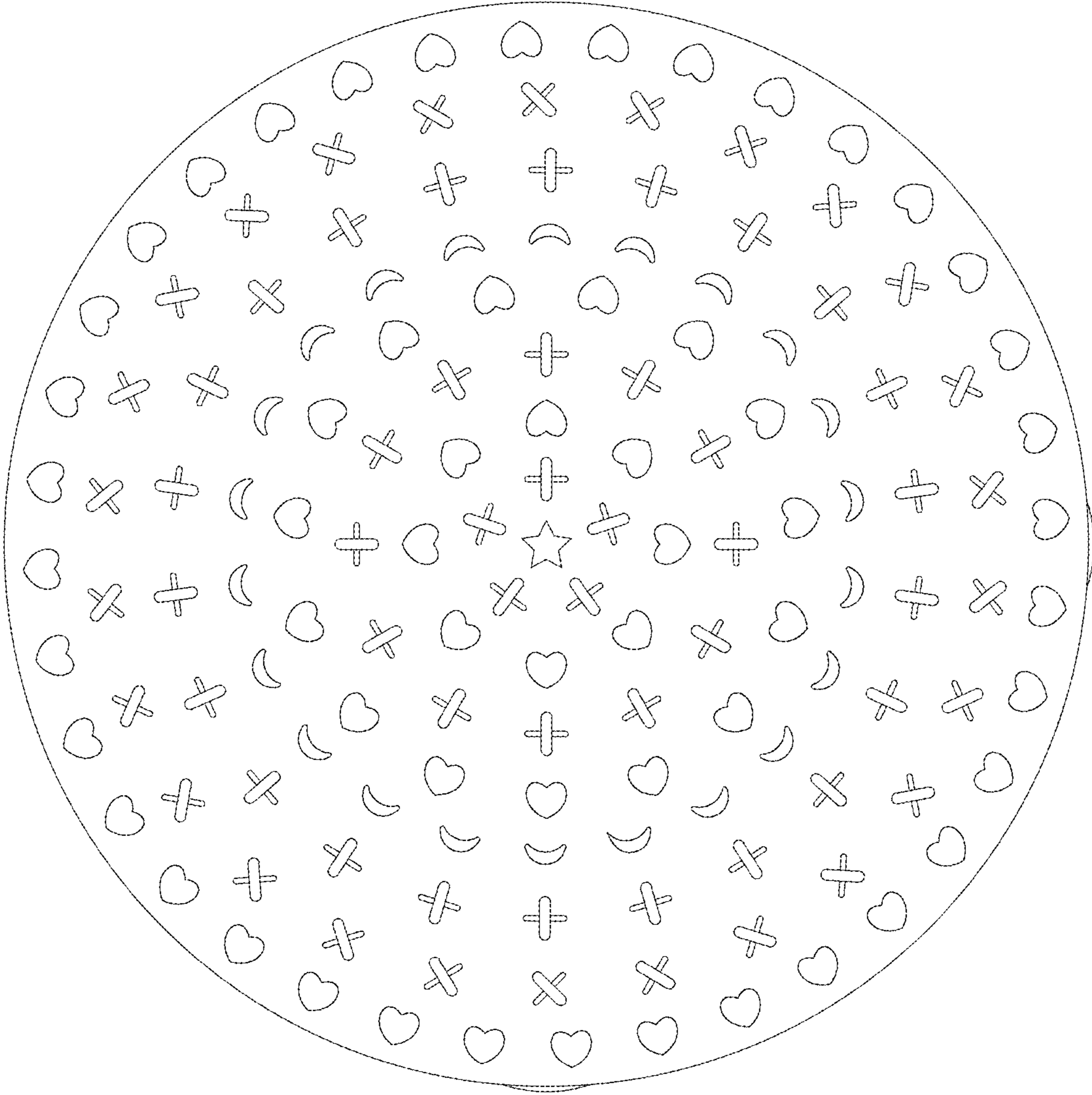

FIG. 3

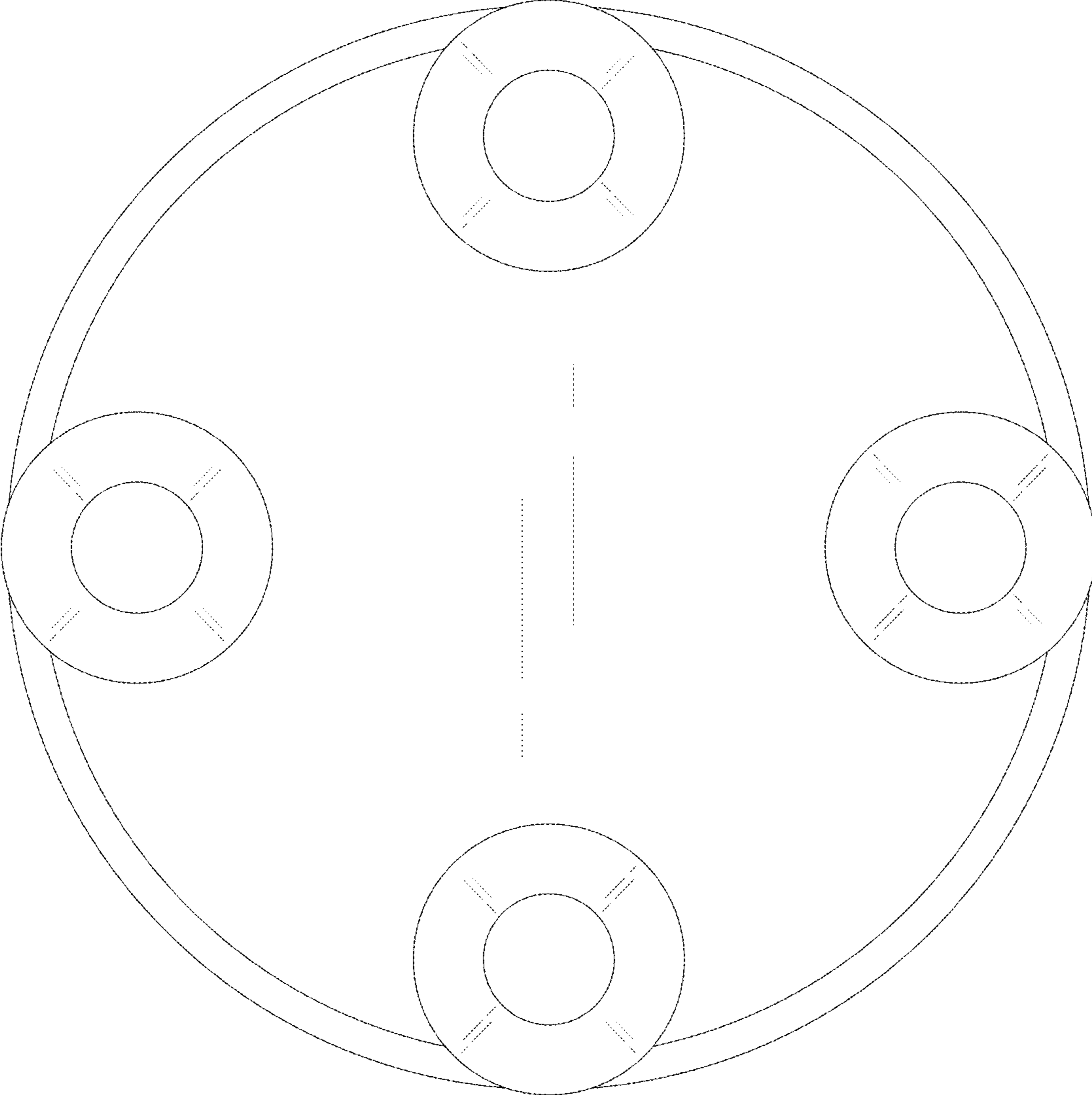

FIG. 4

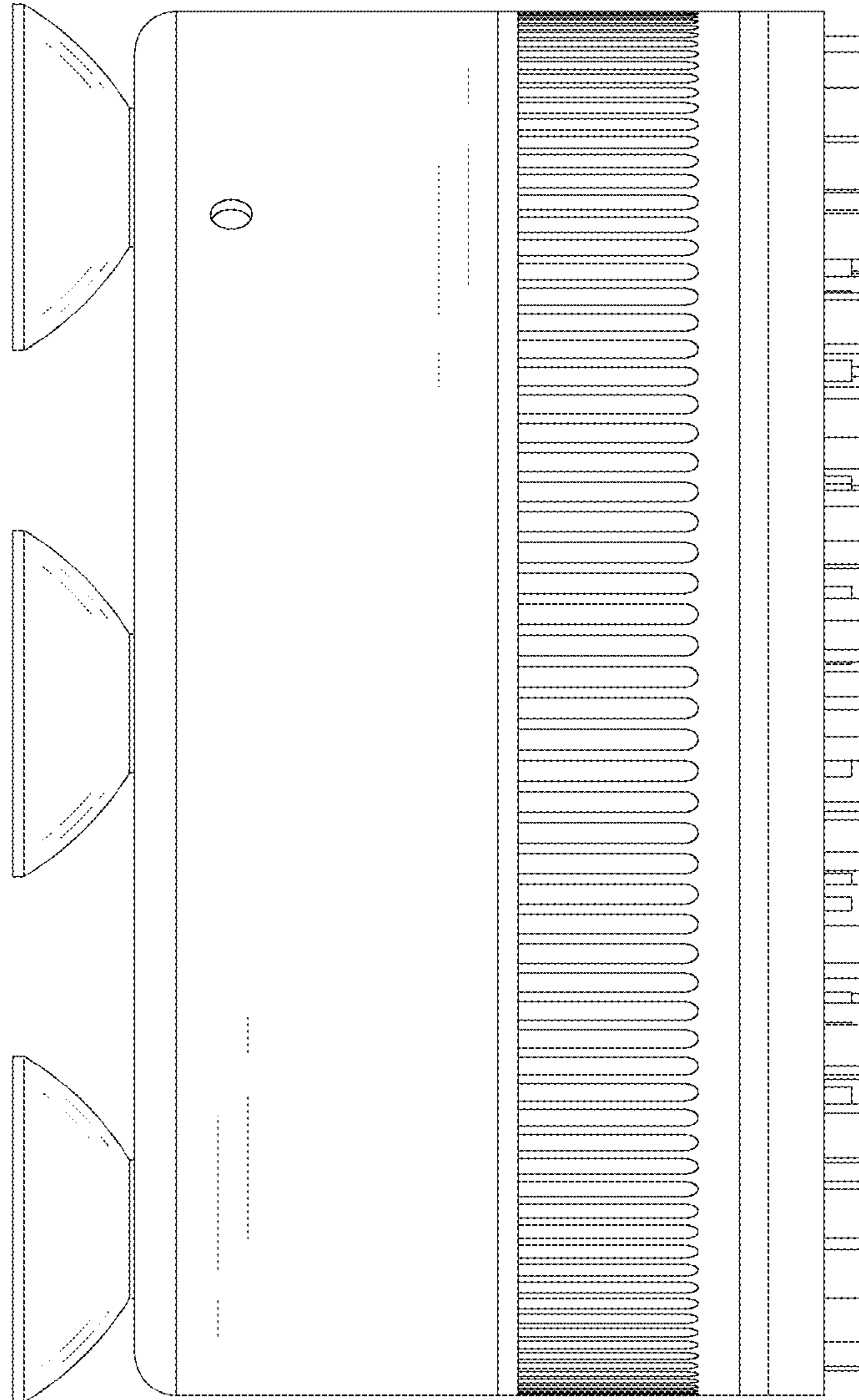

FIG. 5

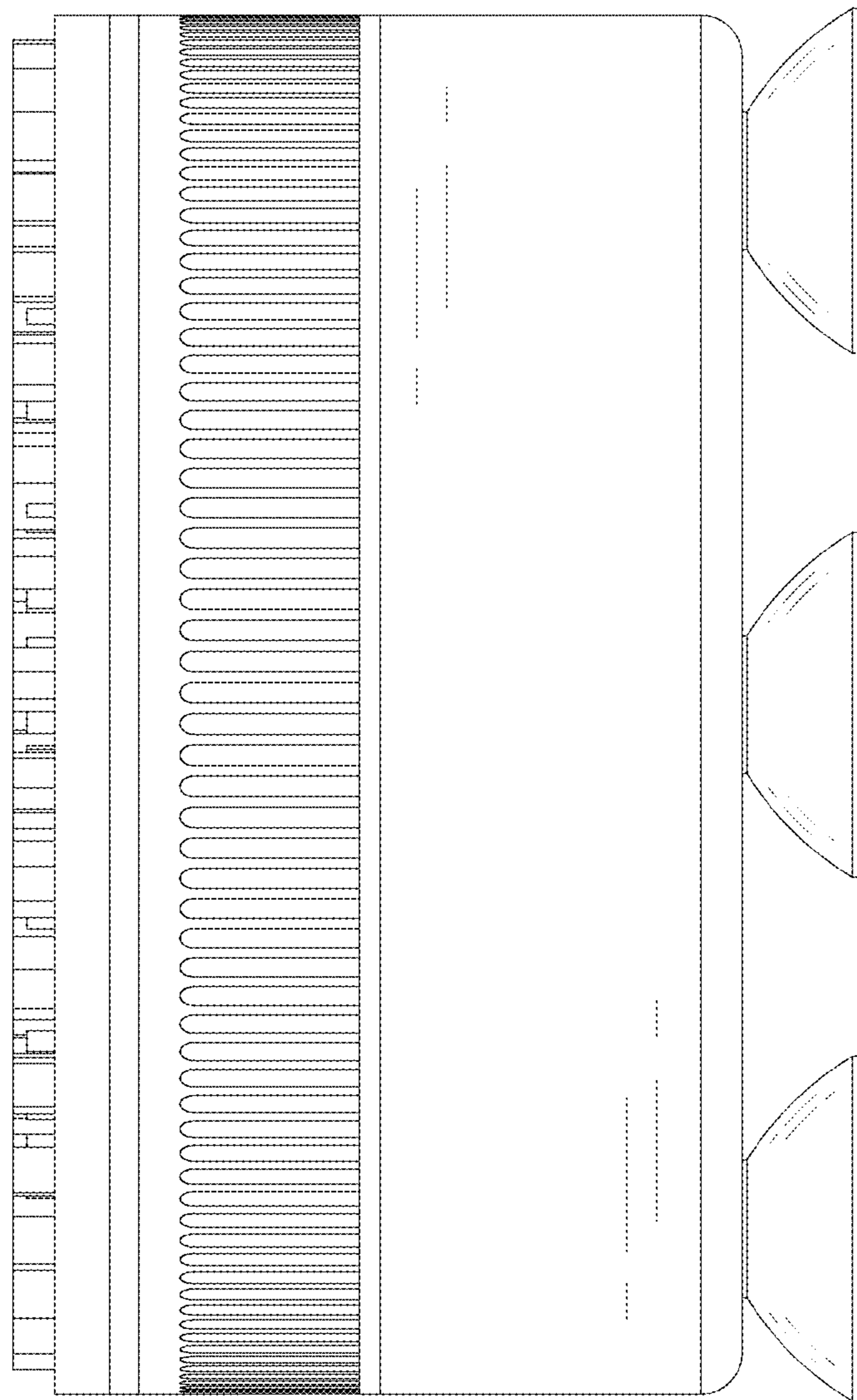

FIG. 6

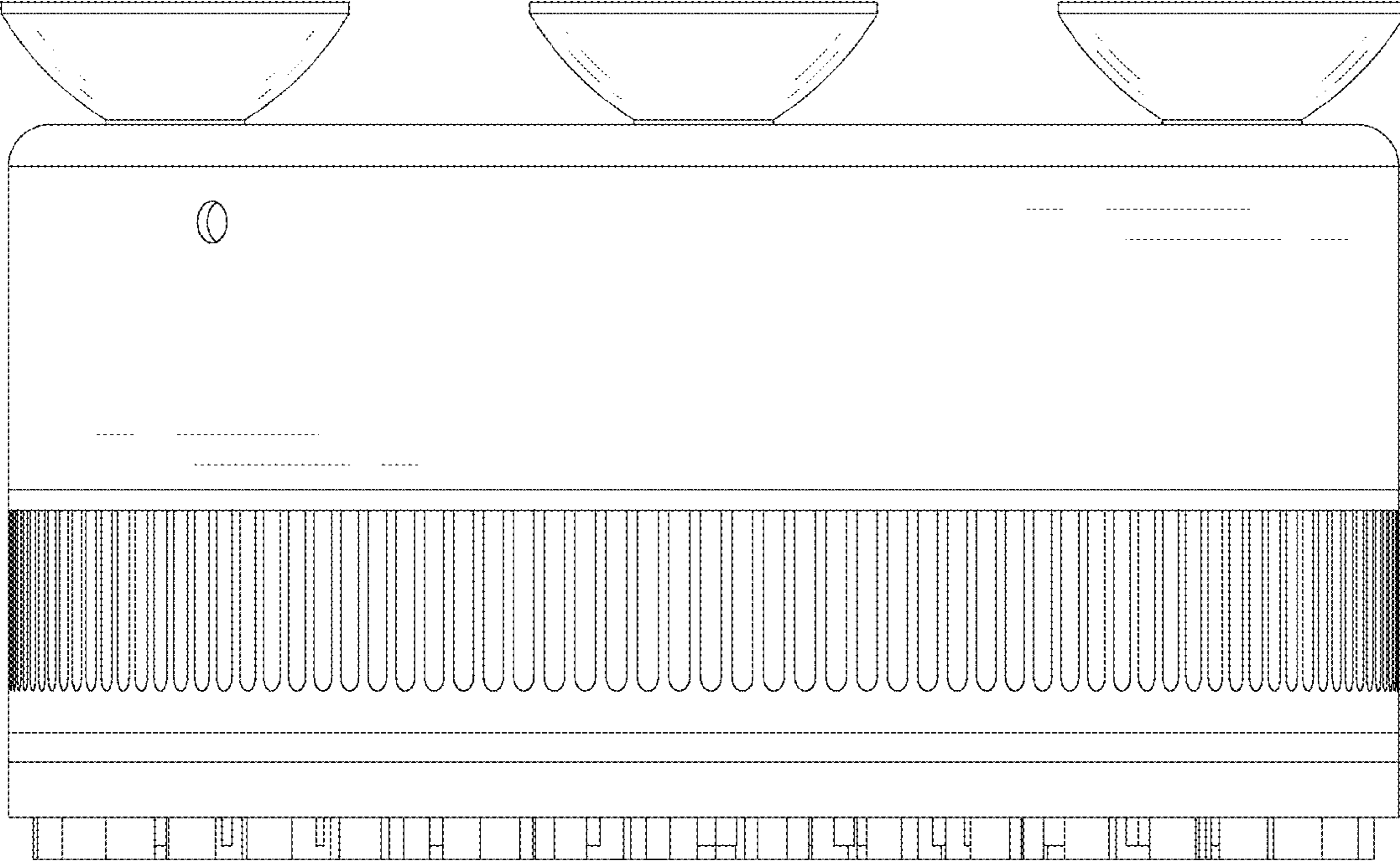

FIG. 7

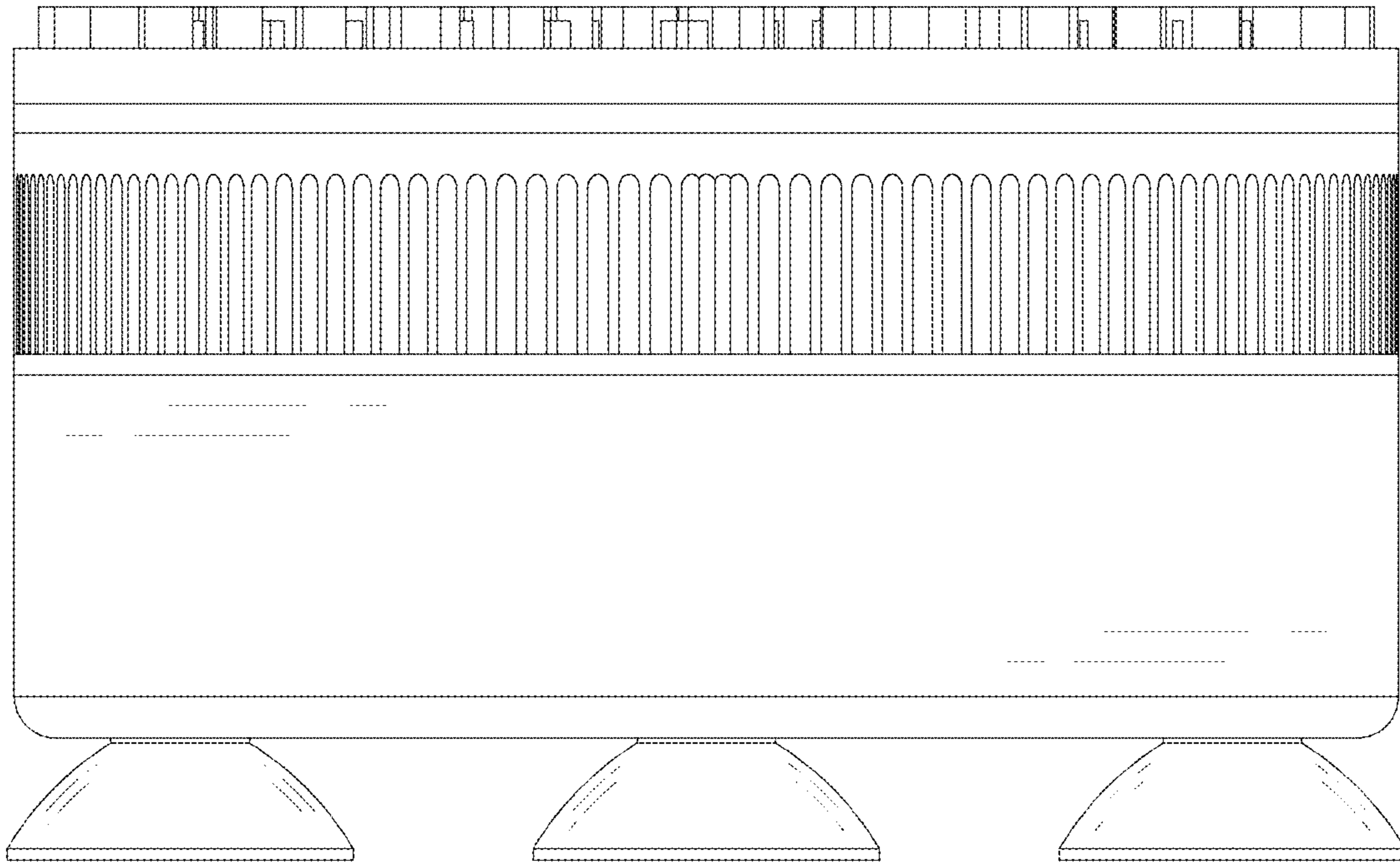

FIG. 8