

US0D1039090S

(12) **United States Design Patent** (10) **Patent No.:** **US D1,039,090 S**  
**Schier et al.** (45) **Date of Patent:** **\*\* Aug. 13, 2024**

(54) **GOLF CLUB HEAD**

FOREIGN PATENT DOCUMENTS

(71) Applicant: **KARSTEN MANUFACTURING CORPORATION**, Phoenix, AZ (US)

JP 3214539 1/2018  
JP D1754671 \* 10/2023

(72) Inventors: **Matthew T. Schier**, Phoenix, AZ (US);  
**David A. Higdon**, Cave Creek, AZ (US); **Cory S. Bacon**, Scottsdale, AZ (US)

OTHER PUBLICATIONS

Golf club iron google search; google.com; Mar. 18, 2024.\*  
(Continued)

(73) Assignee: **Karsten Manufacturing Corporation**, Phoenix, AZ (US)

*Primary Examiner* — Mitchell I. Siegel

(\*\*) Term: **15 Years**

(57) **CLAIM**

The ornamental design for a golf club head, as shown and described.

(21) Appl. No.: **29/867,348**

**DESCRIPTION**

(22) Filed: **Oct. 20, 2022**

(51) **LOC (14) Cl.** ..... **21-02**

(52) **U.S. Cl.**  
USPC ..... **D21/747**

(58) **Field of Classification Search**  
USPC ..... D21/747-751, 759  
CPC ..... A63B 53/00; A63B 53/02; A63B 53/04;  
A63B 53/047; A63B 53/0475; A63B  
2053/0479; A63B 2053/0483; A63B  
2053/0445; A63B 60/00; A63B 60/46  
See application file for complete search history.

FIG. 1 is a front perspective view of a golf club head according to a first embodiment;  
FIG. 2 is a rear perspective view of the golf club head of FIG. 1;  
FIG. 3 is a top view of the golf club head of FIG. 1;  
FIG. 4 is a bottom view of the golf club head of FIG. 1;  
FIG. 5 is a front view of the golf club head of FIG. 1;  
FIG. 6 is a rear view of the golf club head of FIG. 1;  
FIG. 7 is a heel side view of the golf club head of FIG. 1;  
FIG. 8 is a toe side view of the golf club head of FIG. 1;  
FIG. 9 is a front perspective view of a golf club head according to a second embodiment;  
FIG. 10 is a bottom perspective view of the golf club head of FIG. 9;  
FIG. 11 is a top view of the golf club head of FIG. 9;  
FIG. 12 is a bottom view of the golf club head of FIG. 9;  
FIG. 13 is a front view of the golf club head of FIG. 9;  
FIG. 14 is a rear view of the golf club head of FIG. 9;  
FIG. 15 is a heel side view of the golf club head of FIG. 9;  
and,  
FIG. 16 is a toe side view of the golf club head of FIG. 9.  
The broken lines shown on the drawings form no part of the claimed design.

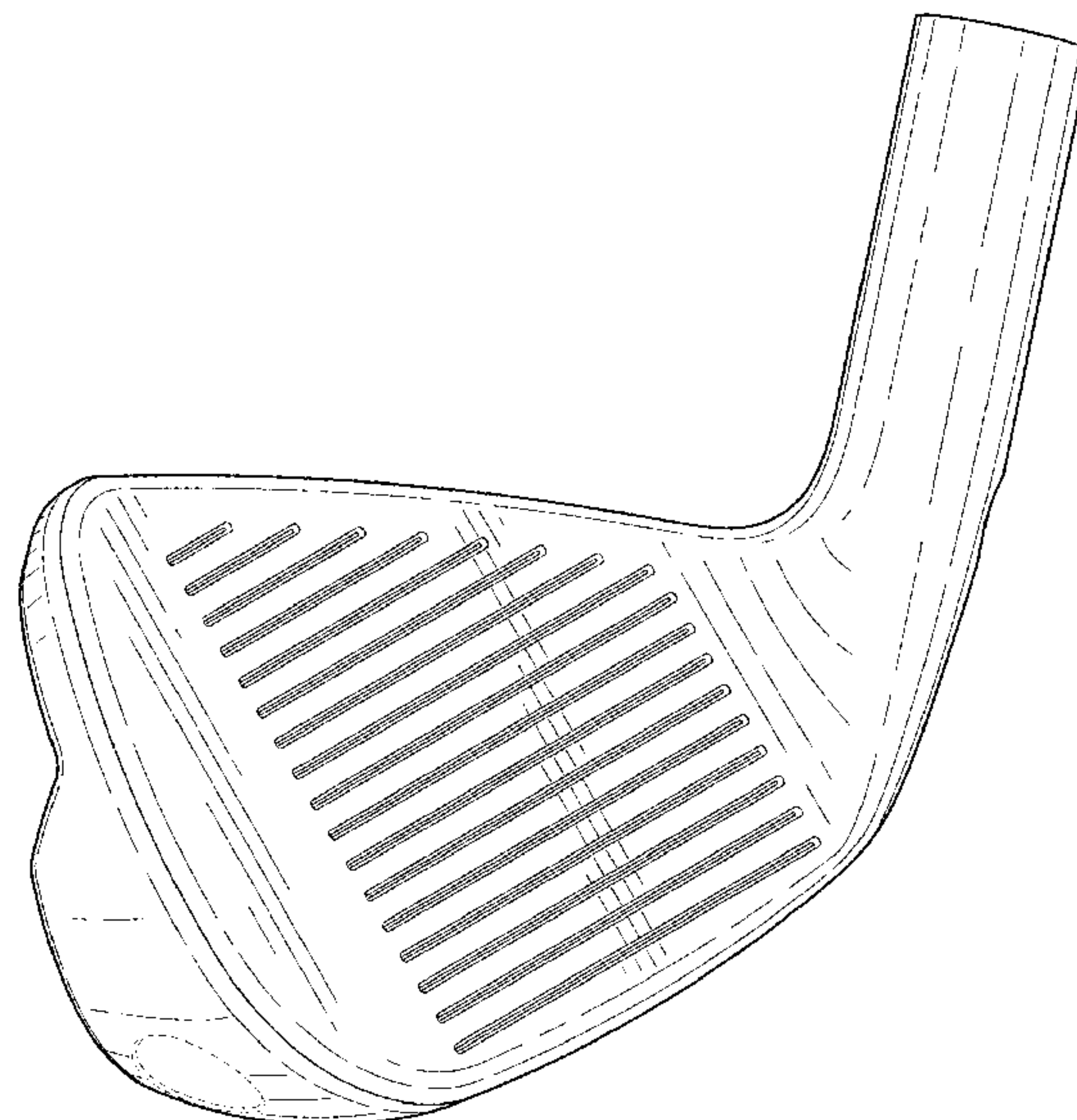
(56) **References Cited**

U.S. PATENT DOCUMENTS

D179,818 S 3/1957 Penna  
D209,299 S 11/1967 Long  
4,874,171 A 10/1989 Ezaki et al.  
5,078,397 A 1/1992 Aizawa  
5,198,062 A 3/1993 Chen  
D336,672 S \* 6/1993 Gorman ..... D21/749  
D337,143 S 7/1993 Lo  
5,425,535 A 6/1995 Gee

(Continued)

**1 Claim, 12 Drawing Sheets**



(56)

References Cited

U.S. PATENT DOCUMENTS

5,766,092 A 6/1998 Mimeur et al.  
 6,030,293 A 2/2000 Takeda  
 6,042,486 A 3/2000 Gallagher  
 6,093,116 A 7/2000 Hettinger  
 6,200,228 B1 3/2001 Takeda  
 6,592,469 B2 7/2003 Gilbert  
 6,843,733 B1 1/2005 Llewellyn et al.  
 6,921,344 B2 7/2005 Gilbert  
 6,929,563 B2 8/2005 Nishitani  
 6,932,717 B2 8/2005 Hou et al.  
 6,964,620 B2 11/2005 Gilbert et al.  
 7,125,343 B2 10/2006 Imamoto  
 7,153,222 B2 12/2006 Gilbert et al.  
 7,182,698 B2 2/2007 Tseng  
 7,371,190 B2 5/2008 Gilbert et al.  
 7,390,270 B2 6/2008 Roberts et al.  
 7,476,162 B2 1/2009 Stites et al.  
 7,731,604 B2 6/2010 Wahl et al.  
 7,744,487 B2 6/2010 Tavares et al.  
 7,803,068 B2 9/2010 Clausen et al.  
 7,811,180 B2 10/2010 Roach et al.  
 7,922,604 B2 4/2011 Roach et al.  
 7,976,403 B2 7/2011 Gilbert et al.  
 8,157,670 B2 4/2012 Oldknow et al.  
 8,157,673 B2 4/2012 Gilbert et al.  
 8,388,464 B2 3/2013 Gilbert et al.  
 8,690,705 B2 4/2014 Molinari  
 8,753,220 B2 6/2014 Roach et al.  
 D708,282 S 7/2014 Oldknow  
 D709,576 S 7/2014 Oldknow  
 D709,974 S 7/2014 Oldknow  
 8,911,302 B1 12/2014 Ivanova et al.  
 8,939,848 B2 1/2015 Soracco et al.  
 8,968,114 B2 3/2015 Boyd et al.  
 8,973,243 B2 3/2015 Su  
 9,056,231 B2 6/2015 Wallans  
 9,199,141 B2 12/2015 Cardani et al.  
 9,259,629 B2 2/2016 Gilbert et al.  
 9,370,697 B2 6/2016 Beno et al.  
 9,381,409 B1 7/2016 Griffin et al.  
 9,387,370 B2 7/2016 Hebreo et al.  
 9,427,633 B2 8/2016 Oldknow  
 9,555,296 B2 1/2017 Gilbert et al.  
 9,586,104 B2 3/2017 Roach  
 D796,606 S \* 9/2017 Oliveira ..... D21/747  
 9,821,203 B2 11/2017 Dolezel et al.  
 9,895,584 B1 2/2018 Su  
 D823,406 S 7/2018 Oyler

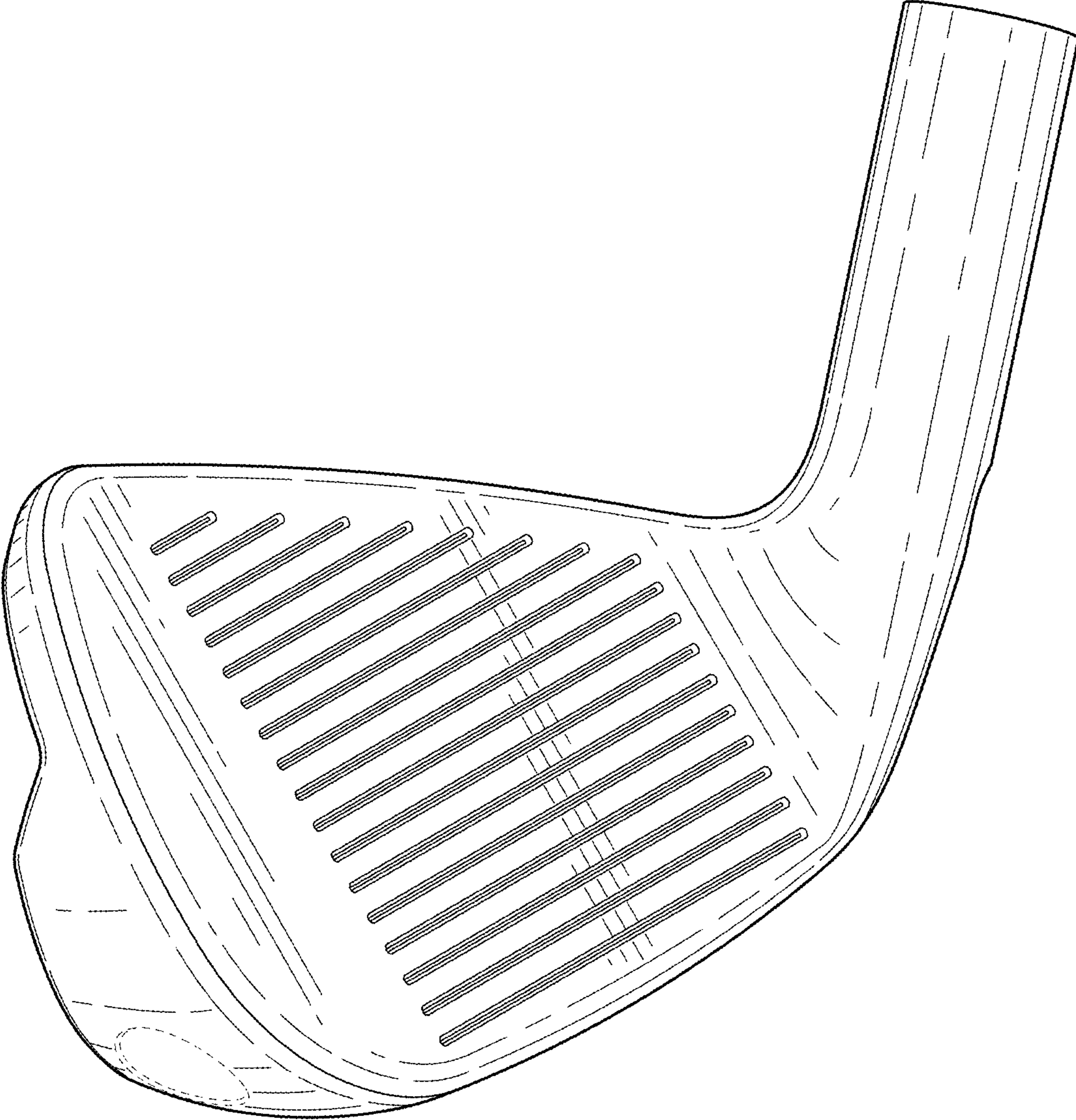
D827,076 S \* 8/2018 Tang ..... D21/759  
 10,039,963 B2 8/2018 Ripp et al.  
 10,052,535 B1 8/2018 Westrum et al.  
 10,076,692 B2 9/2018 Gilbert et al.  
 10,112,084 B2 10/2018 Stokke et al.  
 D832,953 S 11/2018 Bacon  
 D832,957 S \* 11/2018 Tang ..... D21/759  
 D835,736 S 12/2018 Chun  
 D851,718 S \* 6/2019 Stokke ..... D21/747  
 D855,129 S 7/2019 Oliveira  
 D856,450 S 8/2019 Milleman  
 D859,547 S 9/2019 Stokke  
 D885,506 S 5/2020 Nishina  
 D888,172 S 6/2020 Stokke  
 D895,039 S \* 9/2020 Wang ..... D21/747  
 D897,467 S \* 9/2020 Kim ..... D21/759  
 D900,261 S \* 10/2020 Chun ..... D21/747  
 D907,729 S \* 1/2021 Kim ..... D21/752  
 D926,273 S \* 7/2021 Agrella ..... D21/747  
 D926,274 S \* 7/2021 Agrella ..... D21/747  
 D926,899 S \* 8/2021 Clarke ..... D21/747  
 D928,895 S \* 8/2021 Bacon ..... D21/747  
 D944,908 S \* 3/2022 Chun ..... D21/747  
 D947,970 S \* 4/2022 Wang ..... D21/747  
 D970,663 S \* 11/2022 Chun ..... D21/747  
 D973,807 S \* 12/2022 Chang ..... D21/747  
 D986,363 S \* 5/2023 Chang ..... D21/747  
 D1,000,558 S \* 10/2023 Kitching, Jr. .... D21/747  
 D1,005,425 S \* 11/2023 Nicolette ..... D21/759  
 2005/0014573 A1 1/2005 Lee  
 2005/0037860 A1 2/2005 Gilbert et al.  
 2007/0049403 A1 3/2007 Chen  
 2009/0163295 A1 6/2009 Tseng  
 2012/0289360 A1 11/2012 Breier et al.  
 2015/0182816 A1 7/2015 Radcliffe  
 2015/0209630 A1 7/2015 Kawaguchi et al.  
 2016/0346638 A1 12/2016 Snyder  
 2018/0140910 A1 5/2018 Parsons et al.  
 2018/0147457 A1 5/2018 Bacon  
 2018/0221730 A1 8/2018 Petersen et al.  
 2019/0262673 A1 8/2019 Clarke  
 2019/0299068 A1 \* 10/2019 Hosooka ..... A63B 53/04  
 2020/0298077 A1 9/2020 Clarke

OTHER PUBLICATIONS

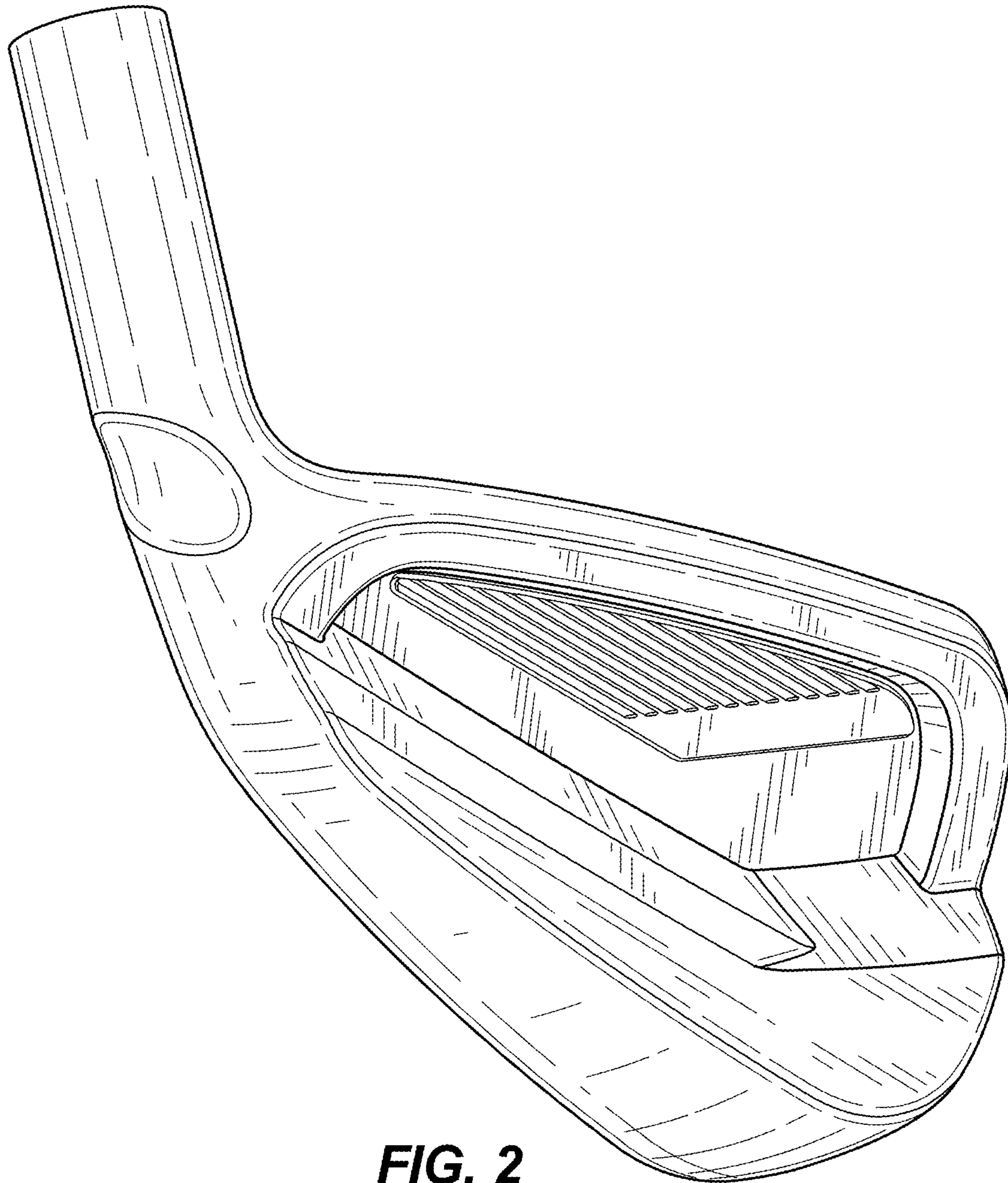
Ping club iron google search; google.com; Mar. 18, 2024.\*  
 ping.com; Mar. 18, 2024.\*  
 Xxio Forged Irons, www.xxiousa.com, Men's Golf Clubs / Xxio Forged Series / Xxio Forged Irons, accessed May 3, 2019.

\* cited by examiner

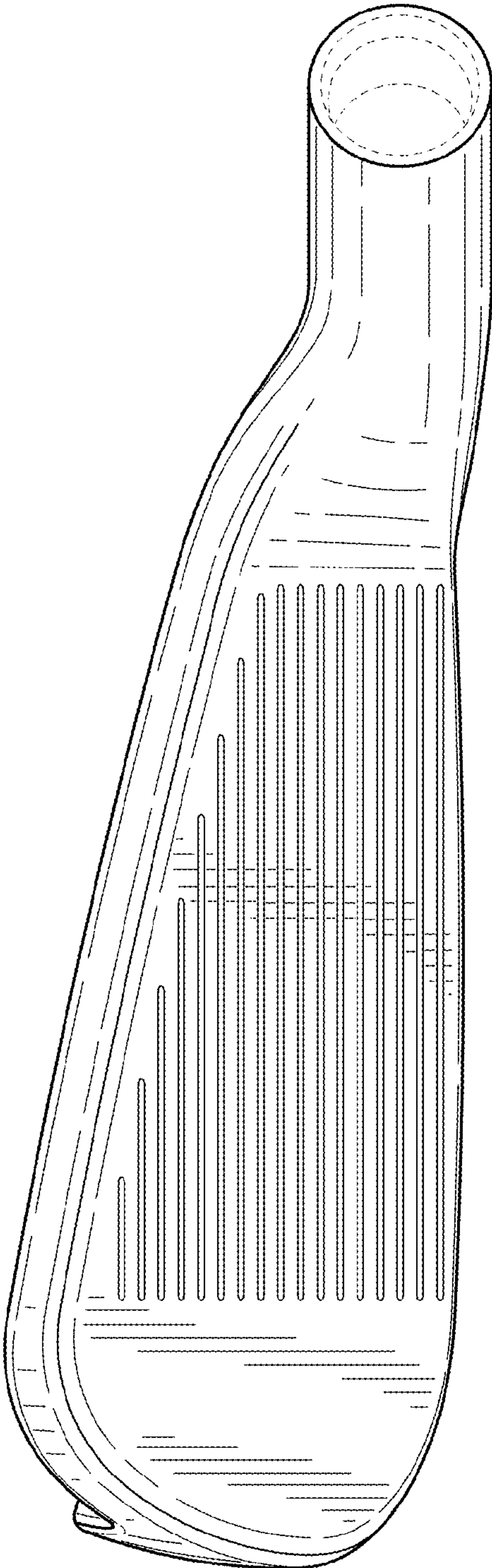




**FIG. 1**



**FIG. 2**



**FIG. 3**



**FIG. 4**



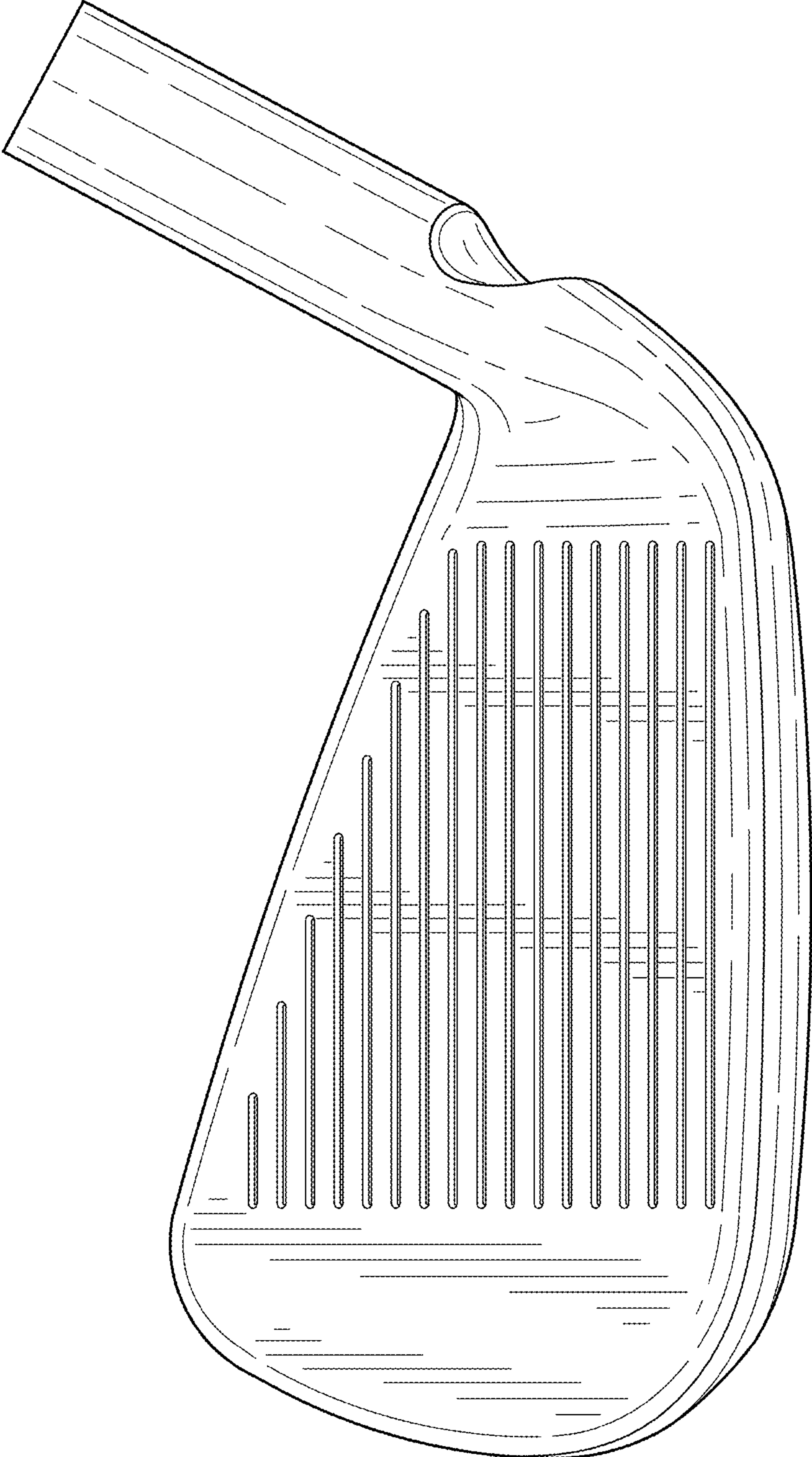
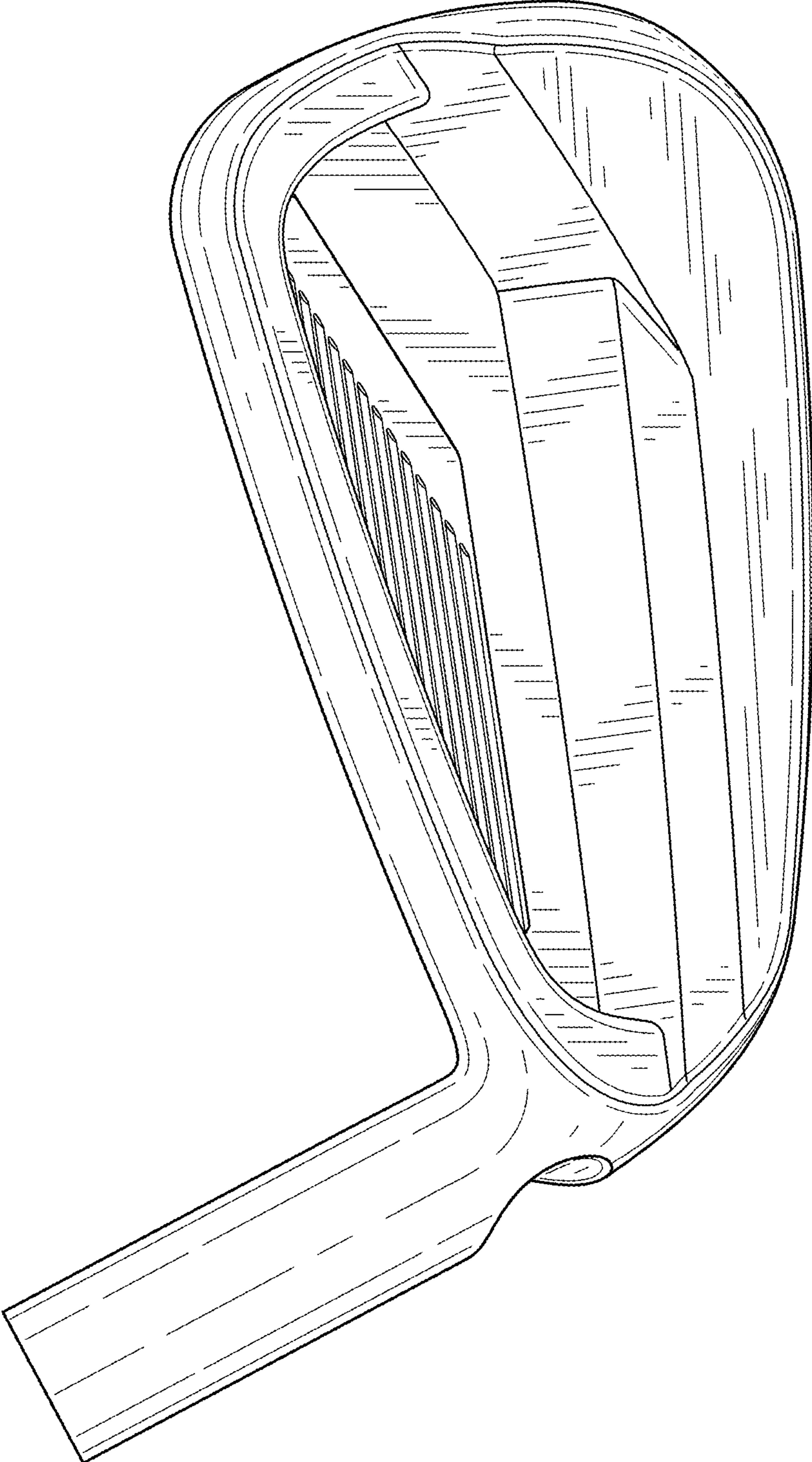
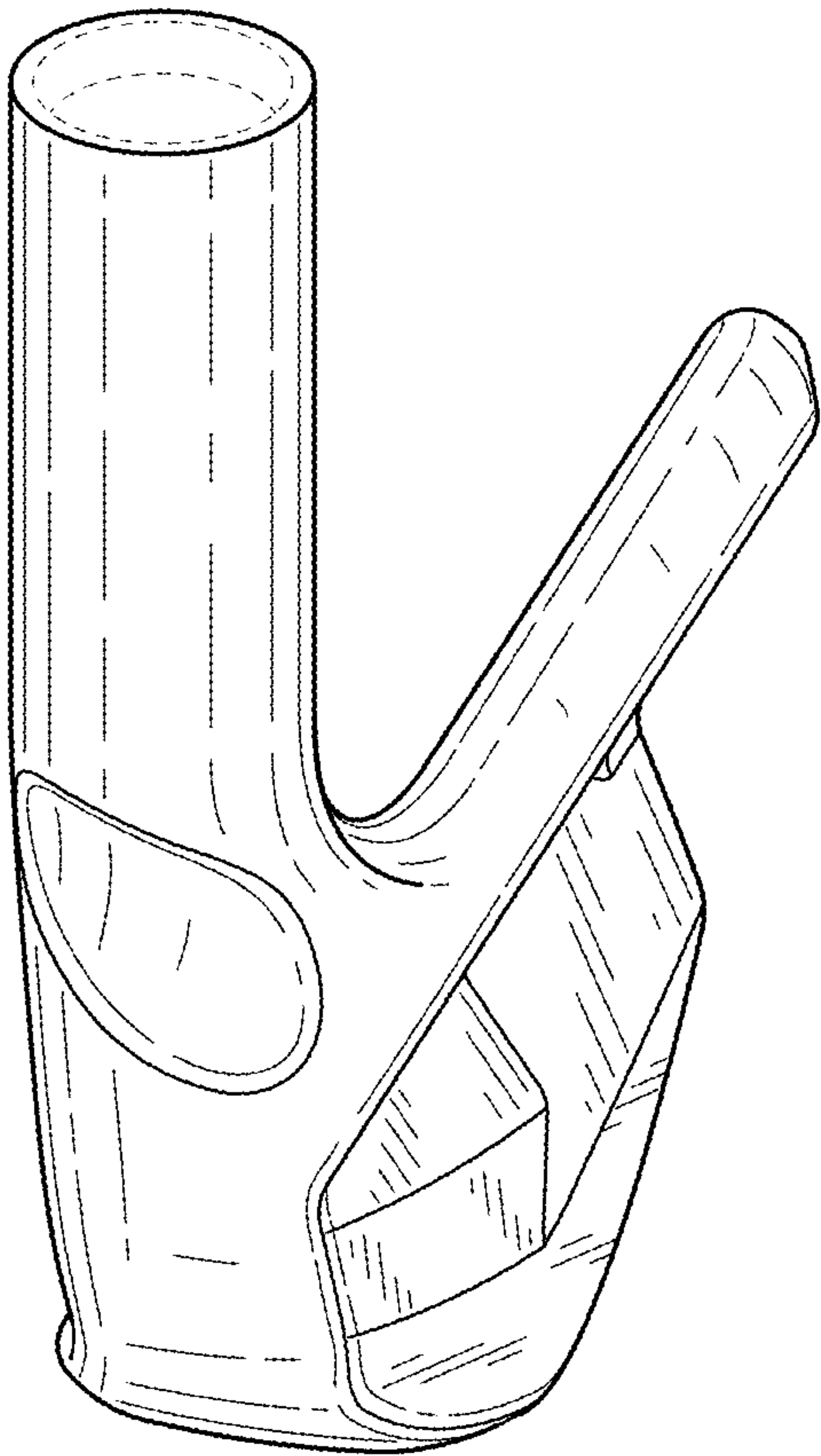


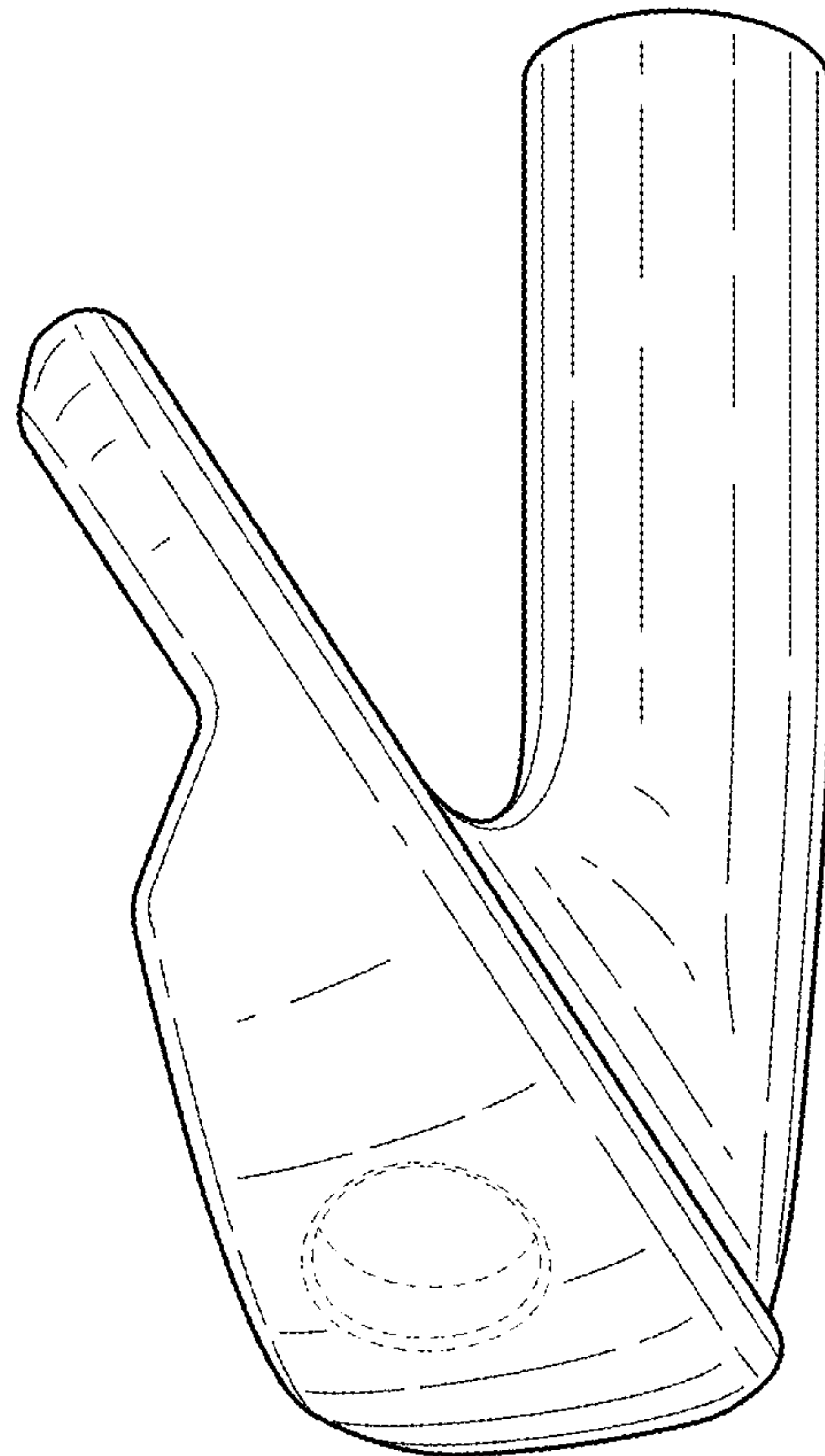
FIG. 5



**FIG. 6**

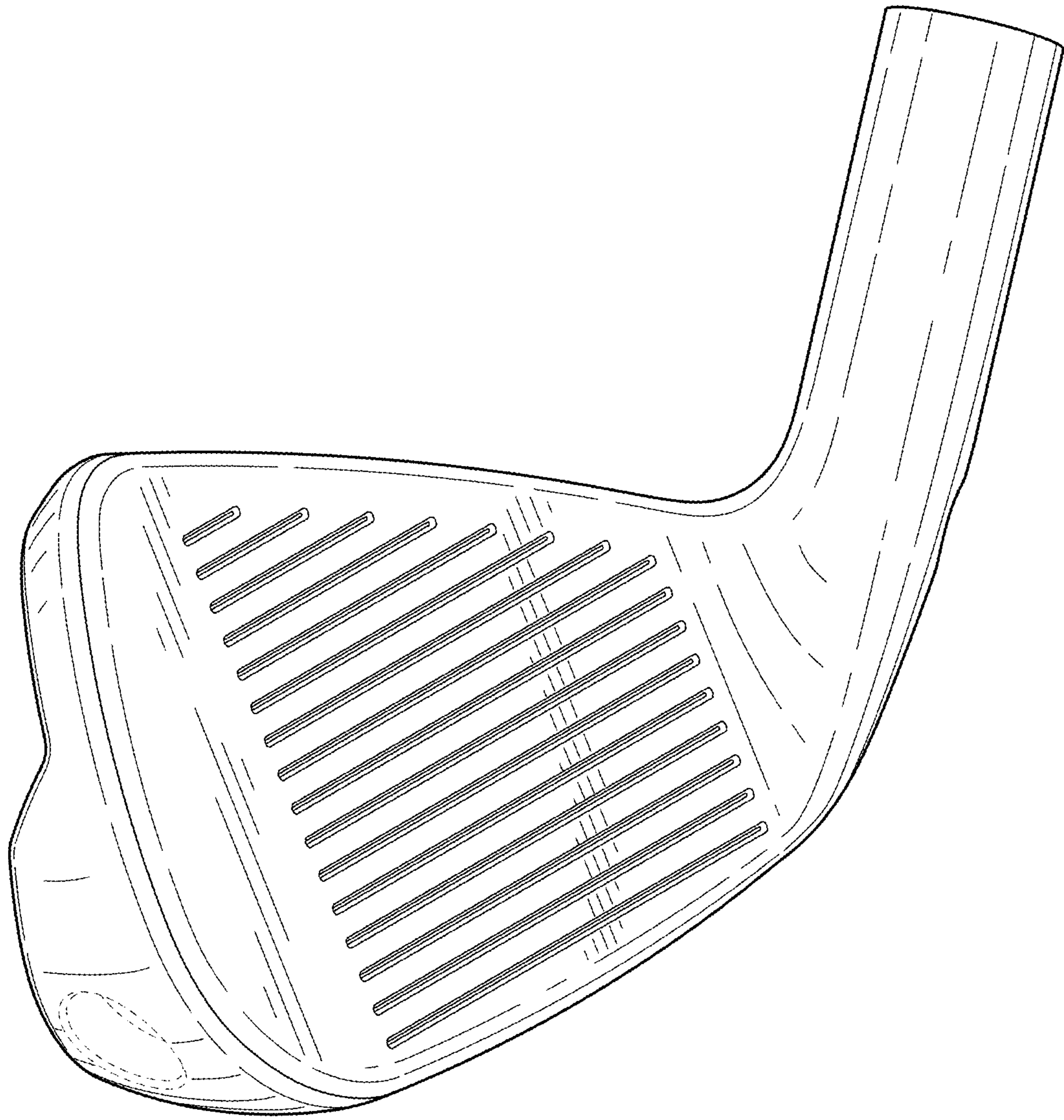


**FIG. 7**

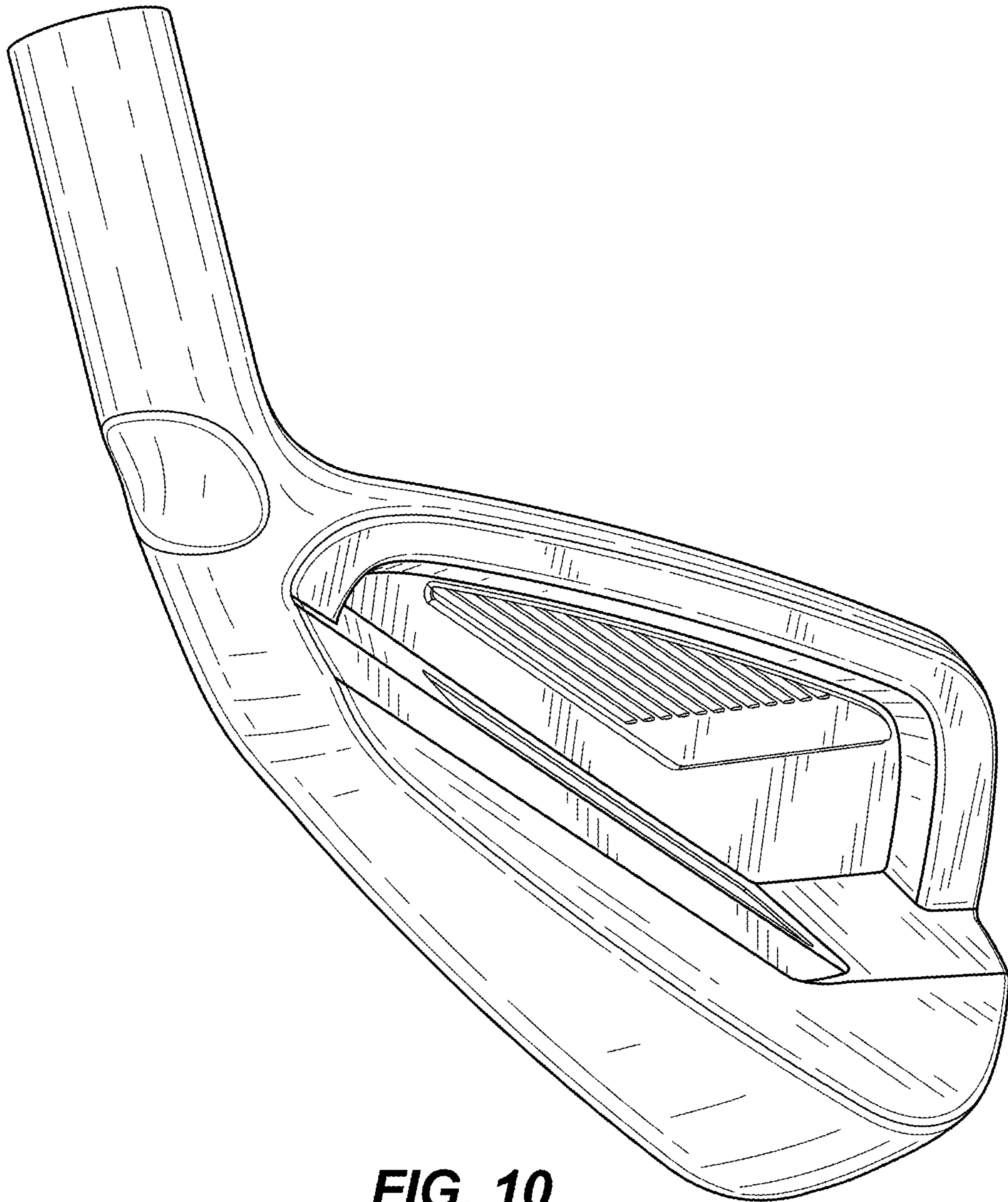


**FIG. 8**

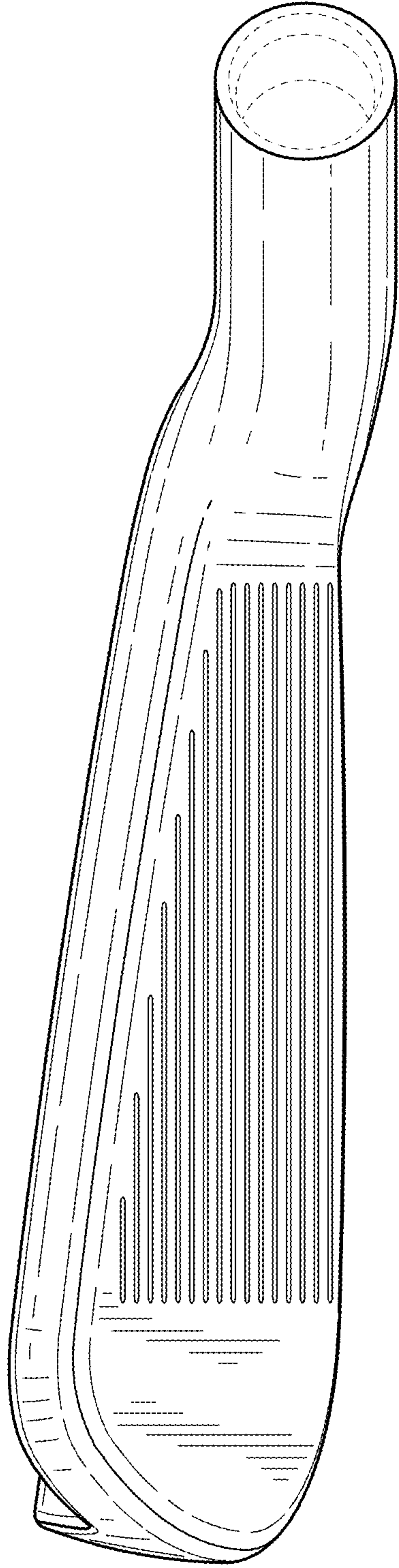




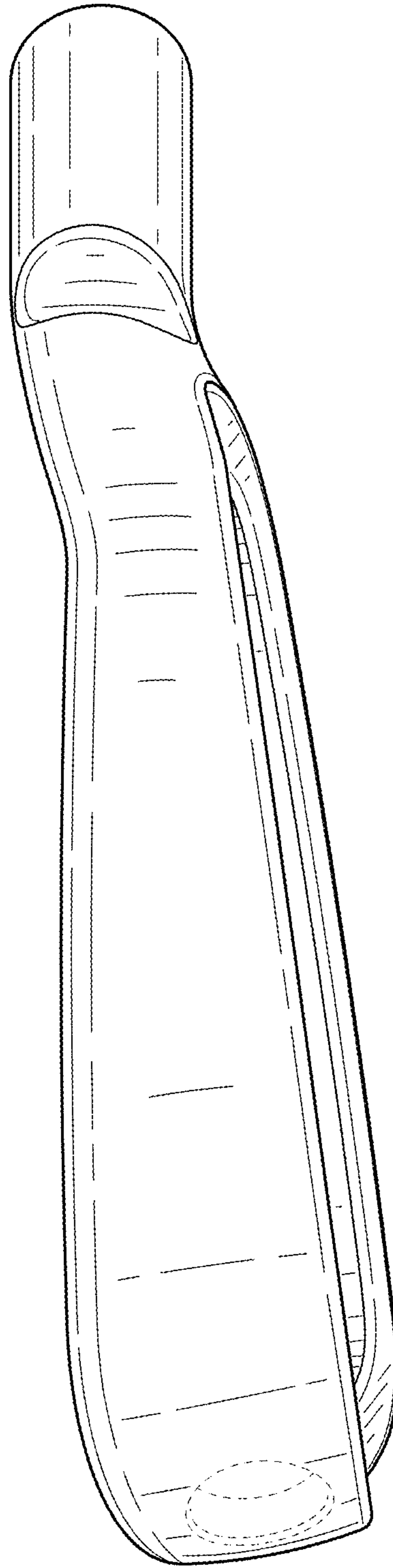
**FIG. 9**



**FIG. 10**



**FIG. 11**



**FIG. 12**



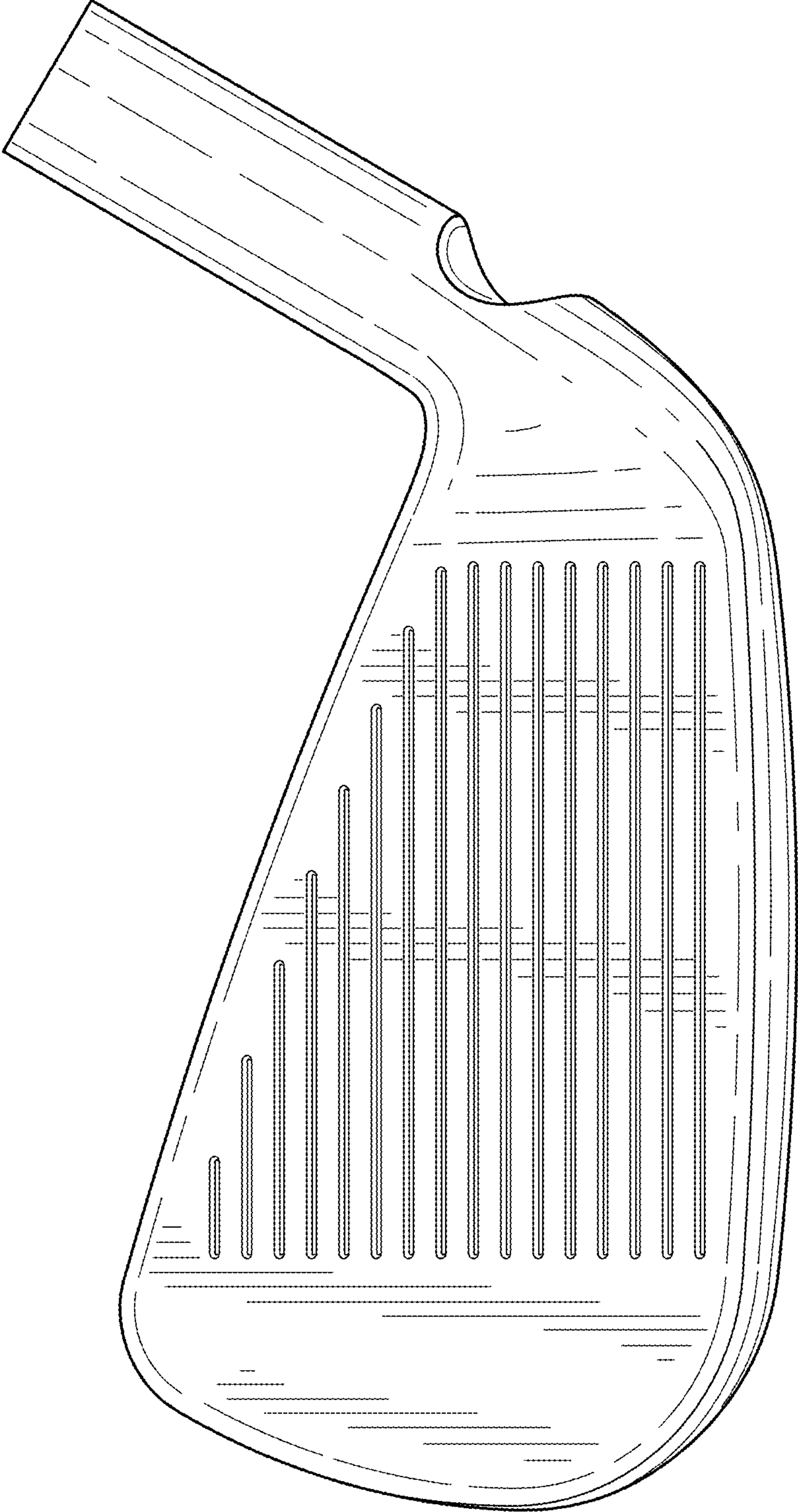
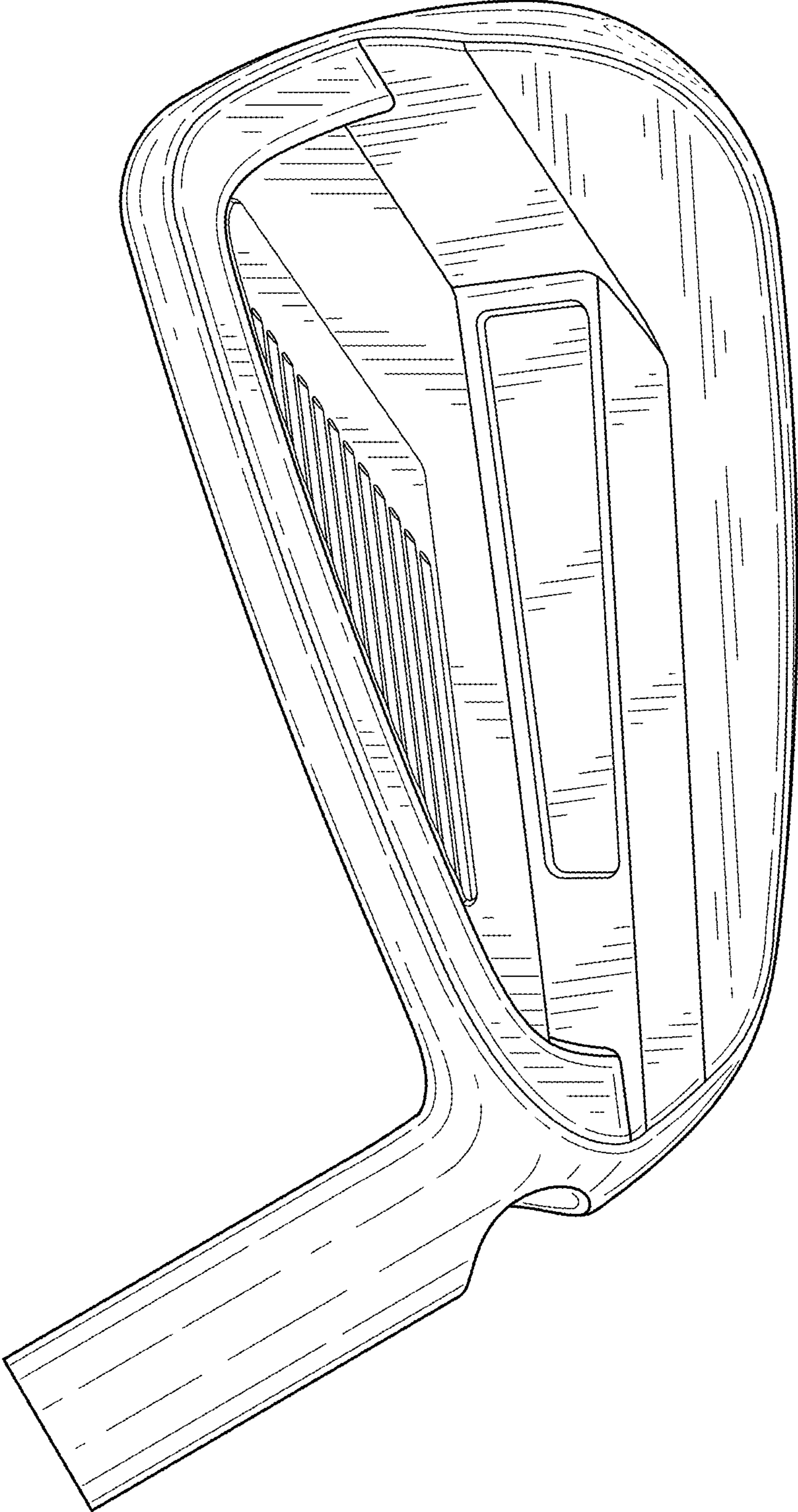
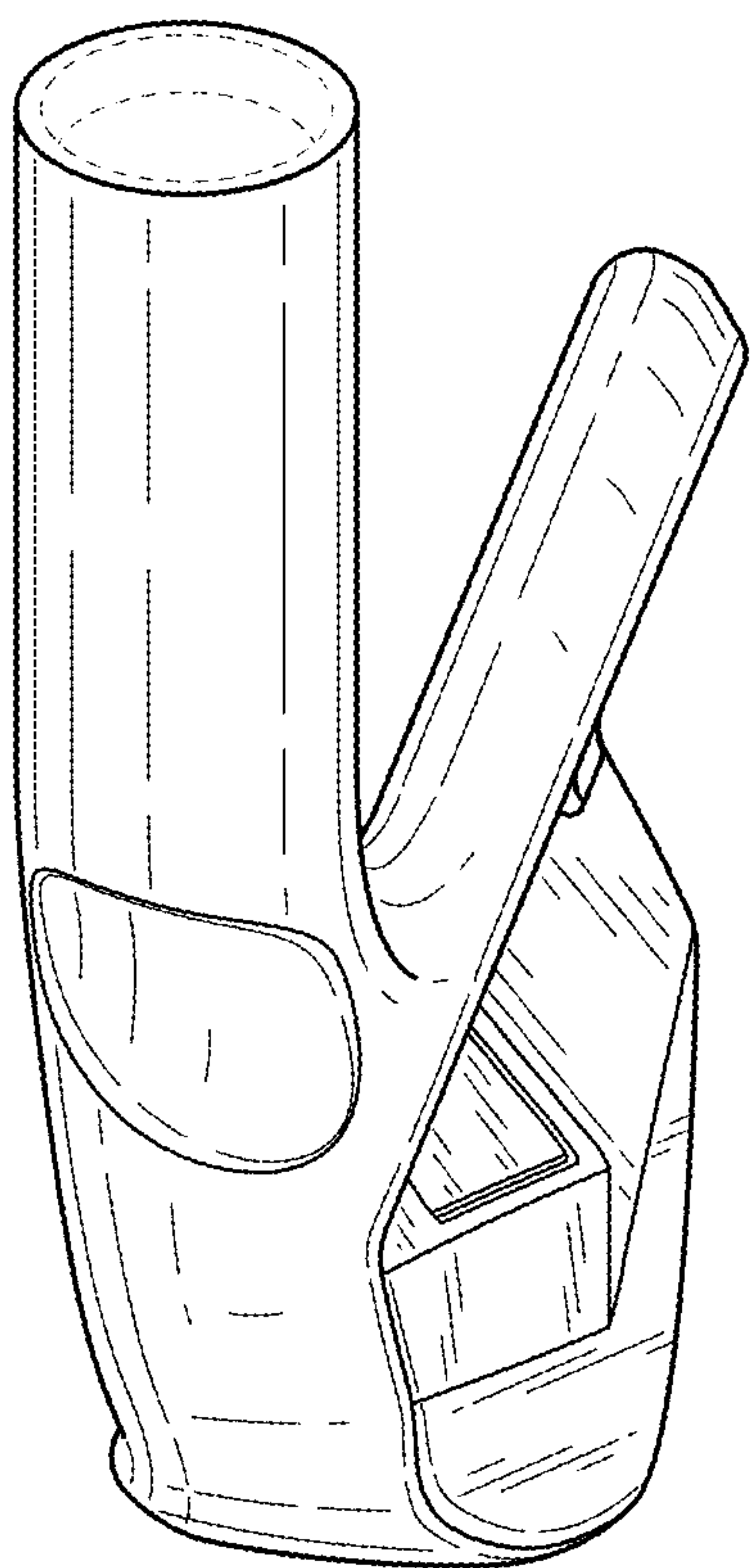


FIG. 13



**FIG. 14**



**FIG. 15**



**FIG. 16**