



US0D1038413S

(12) **United States Design Patent** (10) **Patent No.:** **US D1,038,413 S**
Bachand (45) **Date of Patent:** **** Aug. 6, 2024**

(54) **TANK**
(71) Applicant: **Renu Therapy, LLC**, Costa Mesa, CA (US)
(72) Inventor: **Bill Bachand**, Santa Ana, CA (US)
(73) Assignee: **Renu Therapy, LLC**, Costa Mesa, CA (US)
(**) Term: **15 Years**

D244,711 S 6/1977 Armbruster
D246,728 S 12/1977 Wormser
D248,667 S 7/1978 Plugge
D271,523 S 11/1983 Richburg
D277,409 S 1/1985 Elsner
(Continued)

(21) Appl. No.: **29/933,630**
(22) Filed: **Mar. 20, 2024**

FOREIGN PATENT DOCUMENTS

CN 201830229906 10/2018
GB 6035899 5/2018

Related U.S. Application Data

(63) Continuation of application No. 29/914,341, filed on Oct. 16, 2023, which is a continuation of application No. 29/870,181, filed on Jan. 18, 2023, now abandoned, which is a continuation of application No. 29/811,925, filed on Oct. 18, 2021, now Pat. No. Des. 983,983, which is a continuation of application No. 29/757,138, filed on Nov. 3, 2020, now Pat. No. Des. 936,234.

OTHER PUBLICATIONS

US D796,647 S, 09/2017, Schoenherr et al. (withdrawn)
(Continued)

(51) **LOC (14) Cl.** **24-01**
(52) **U.S. Cl.**
USPC **D24/204**

Primary Examiner — Calvin E Vansant
Assistant Examiner — Mark T. Philipps
(74) *Attorney, Agent, or Firm* — Knobbe, Martens, Olson & Bear, LLP

(58) **Field of Classification Search**
USPC D25/2; D24/201–205; D15/79, 83; D23/276–278, 280.1, 280.2, 280.3
CPC A47K 3/022; A47K 3/062; A61H 33/06; A61H 33/066; A61H 33/6055; A61H 33/6021; A61H 33/6089; A61H 33/6094; A61H 2035/004; A61H 35/006
See application file for complete search history.

(57) **CLAIM**

The ornamental design for a tank, as shown and described.

(56) **References Cited**

U.S. PATENT DOCUMENTS

D26,992 S 4/1897 Kornbaum
D217,074 S 3/1970 Jones

DESCRIPTION

FIG. 1 is a front, right-side perspective view of a tank showing an embodiment of my design with a lid removed; FIG. 2 is a rear, left-side perspective view thereof with the lid removed; FIG. 3 is a front, right-side perspective view thereof; FIG. 4 is a top plan view thereof; FIG. 5 is a bottom plan view thereof; FIG. 6 is a right-side elevation view thereof; FIG. 7 is a left-side elevation view thereof; FIG. 8 is a front elevation view thereof; and, FIG. 9 is a rear elevation view thereof. The broken lines shown in the drawings represent portions of the tank that form no part of the claimed design.

1 Claim, 9 Drawing Sheets

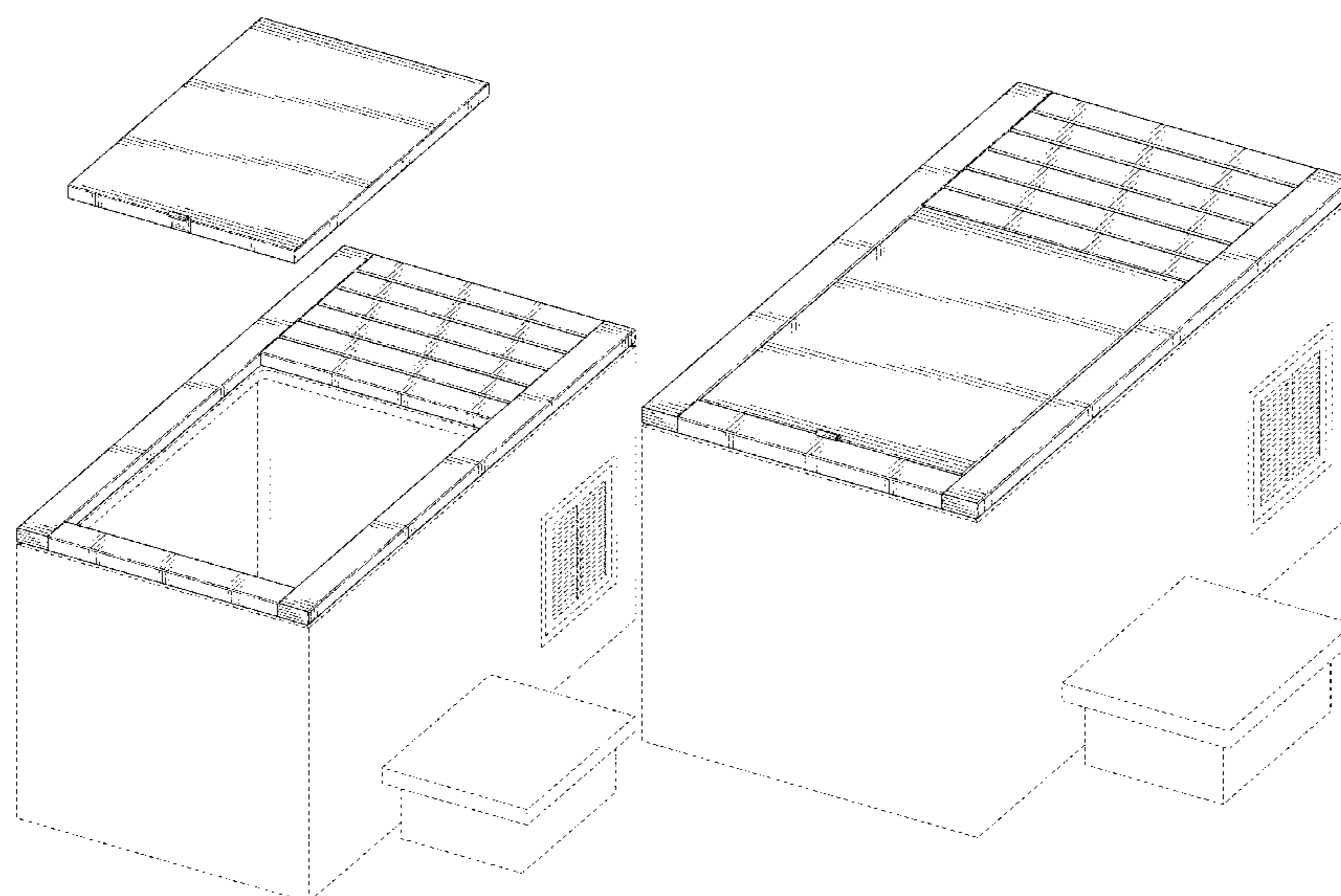

(56)

References Cited

U.S. PATENT DOCUMENTS

D412,973 S 8/1999 Donnelly
 D468,813 S 1/2003 Kohler et al.
 D475,127 S 5/2003 Svendsen et al.
 D482,763 S 11/2003 Thomas
 D483,840 S 12/2003 Molinaro
 D483,875 S 12/2003 Dupras
 D495,802 S 9/2004 Walker et al.
 D498,521 S 11/2004 Bayer
 D499,467 S 12/2004 Aubry et al.
 D510,984 S 10/2005 Matthews
 D527,081 S 8/2006 Hatrick-Smith
 D537,925 S 3/2007 Mahon
 D547,877 S 7/2007 Walker
 D560,768 S 1/2008 Smith
 D585,995 S 2/2009 Sinka et al.
 D598,079 S 8/2009 Lutz
 D613,834 S 4/2010 Kergoet
 D613,835 S 4/2010 Hoh
 D613,869 S 4/2010 Ton
 D629,117 S 12/2010 Walker
 D633,603 S 3/2011 Su
 D639,916 S 6/2011 Dosne
 D642,663 S 8/2011 Dosne
 D645,567 S 9/2011 Walker et al.
 D662,211 S 6/2012 Howe
 D686,332 S 7/2013 Suri
 D732,177 S 6/2015 Lee
 D737,416 S 8/2015 Ahmes
 D739,949 S 9/2015 Lee
 D740,922 S 10/2015 Tu
 D745,692 S 12/2015 Oh et al.
 D796,646 S 9/2017 Schoenherr et al.
 D801,489 S 10/2017 Schoenherr et al.
 D802,724 S 11/2017 Schoenherr et al.
 D810,245 S 2/2018 Schoenherr et al.
 D843,000 S 3/2019 Harder et al.
 D862,719 S 10/2019 Tran
 D864,402 S 10/2019 Rathnam
 D867,552 S 11/2019 Kiukas
 D882,047 S 4/2020 Burnstein
 D882,822 S 4/2020 Painter et al.
 D902,142 S 11/2020 Zheng et al.
 D903,066 S 11/2020 Dominguez et al.

D904,586 S 12/2020 Magone
 D936,234 S 11/2021 Bachand
 D983,983 S 4/2023 Bachand
 D996,629 S * 8/2023 Duong D24/204
 D999,389 S * 9/2023 Lun D24/204
 D1,011,540 S * 1/2024 Bachand D24/204
 2015/0240509 A1 8/2015 Ferriss et al.
 2016/0081875 A1 3/2016 Oh et al.
 2016/0298348 A1 10/2016 Lisk

OTHER PUBLICATIONS

BlueCube Baths, CoreChill Cold Plunge, (site visited Mar. 9, 2023), BlueCube Baths website, URL:<https://bluecubebaths.com/products/corechill-the-5-cold-plunge-ice-bath-pre-order?variant=42316731056299&gclid=EALalQobChMl2OCRn8TP_QIVZYJbCh000wVLEAKYAyABEgKWYfD_BwE> (Year: 2023).
 Breathe Degrees, “You’ve probably seen these classy cold tubs at our Solana Beach spot. Well . . .”, (posted Feb. 17, 2021), Twitter.com, URL:<<https://twitter.com/breathedegrees/status/1362070707430174724?ext=H HwWi MC5tfCFhuclAAAA>> (Year: 2021).
 RenuTherapy, @renutherapy Instagram profile with posts and stories—Picuki.com. Posted before Dec. 2020. Retrieved from website at: <https://picuki.com/profile/renutherapy>.
 FuroHealth’s Instagram post dated Nov. 5, 2018, available at <https://www.instagram.com/p/Bp0L8Q1Dhzk/>.
 FuroHealth’s Instagram post dated Jan. 1, 2019, available at <https://www.instagram.com/p/BsGzh7yDTYY/>.
 Photos of Breathe Degrees Cold Plunge Tub, alleged by third party to be offered for sale to the public and sold in Sep. 2020.
 Renu Therapy, @renutherapy’s Instagram post dated Dec. 16, 2019, accessed at https://www.instagram.com/p/B6JcjkfDT_a/?hl=en.
 Renu Therapy, @renutherapy’s Instagram post dated Dec. 20, 2019, accessed at <https://www.instagram.com/p/B6Ua7dUF-n1/?hl=en>.
 Renu Therapy, @renutherapy’s Instagram post dated Jan. 13, 2020, accessed at <https://www.instagram.com/p/B7SIAg8IHVM/?hl=en>.
 Renu Therapy, @renutherapy’s Instagram post dated Aug. 24, 2020, accessed at <https://www.instagram.com/p/CESgYvmFGYm/?hl=en>.
 Purported Proforma Invoice and Advice of Inward Remittance, alleged by third party to correspond to offline sale on Sep. 16, 2019 of a tank, sauna heater, and steam generator.

* cited by examiner

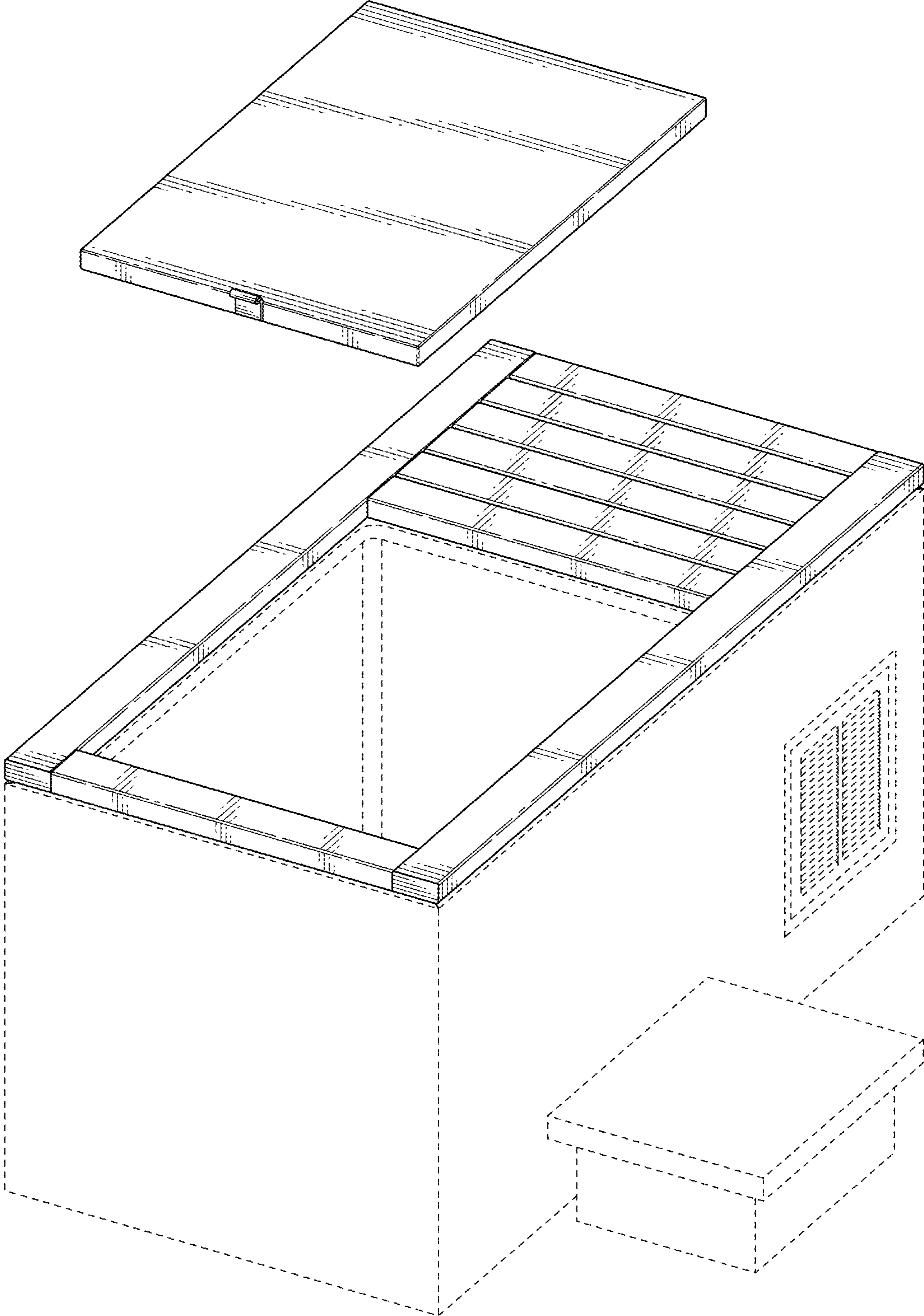

FIG. 1

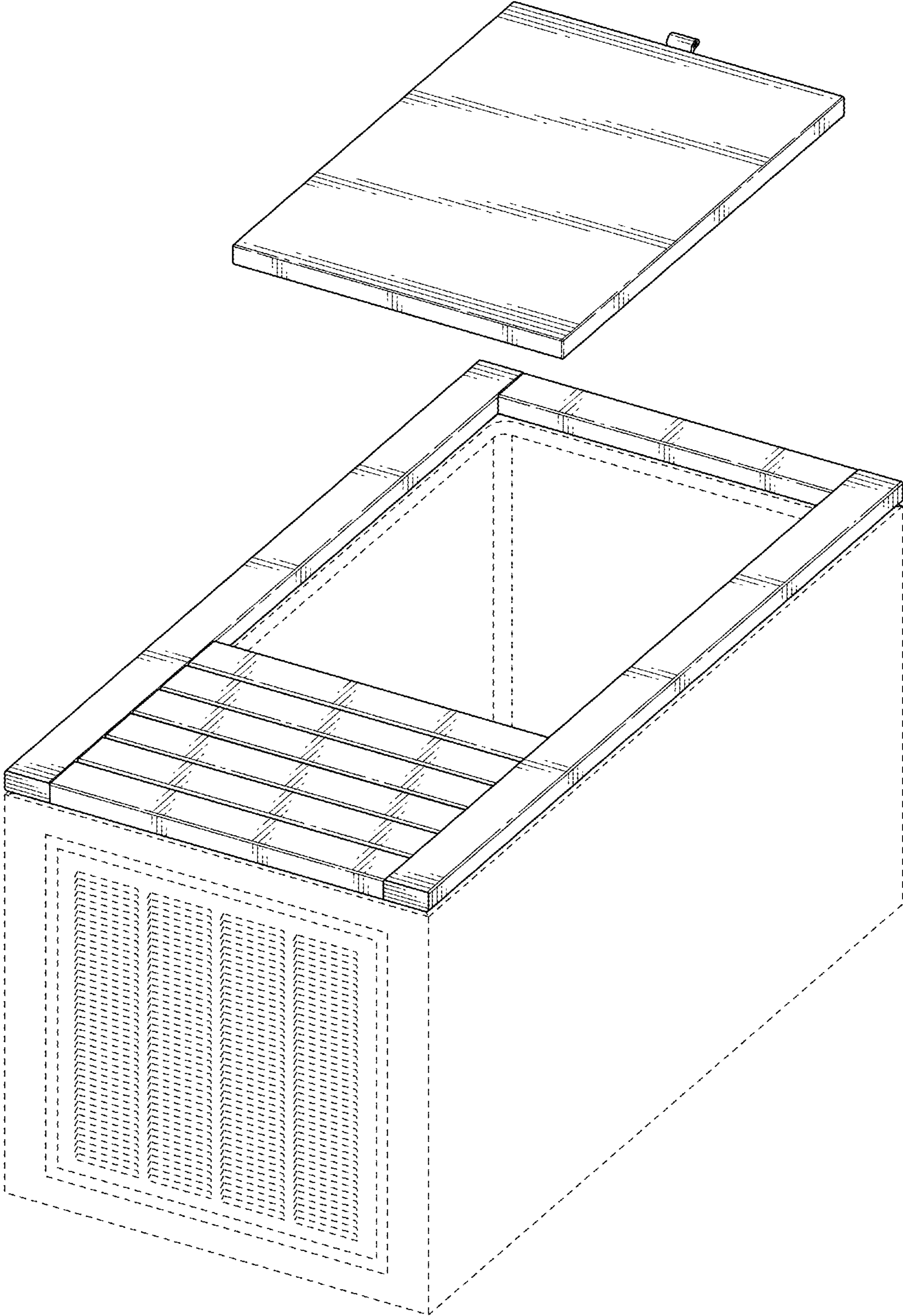

FIG. 2

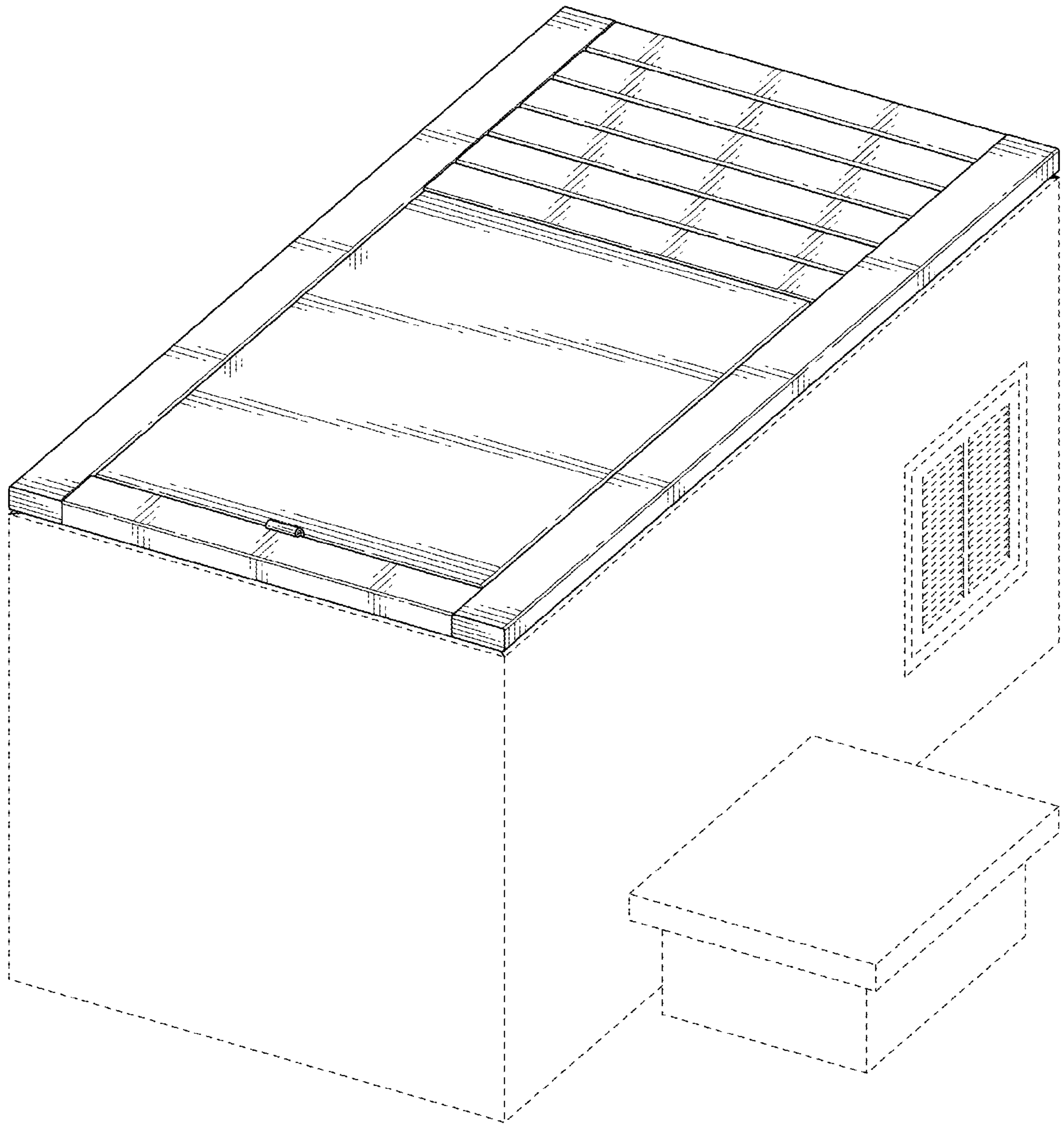

FIG. 3

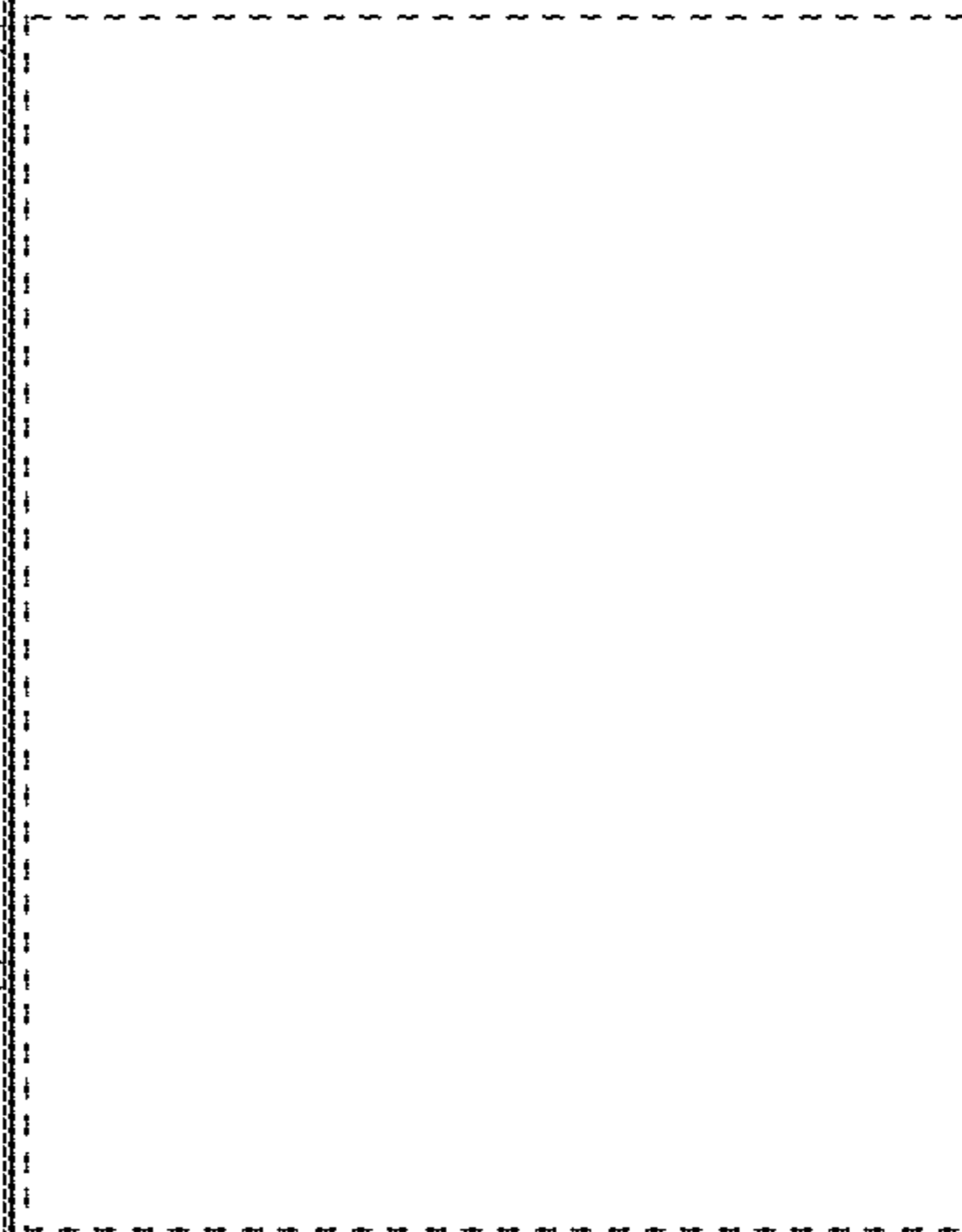
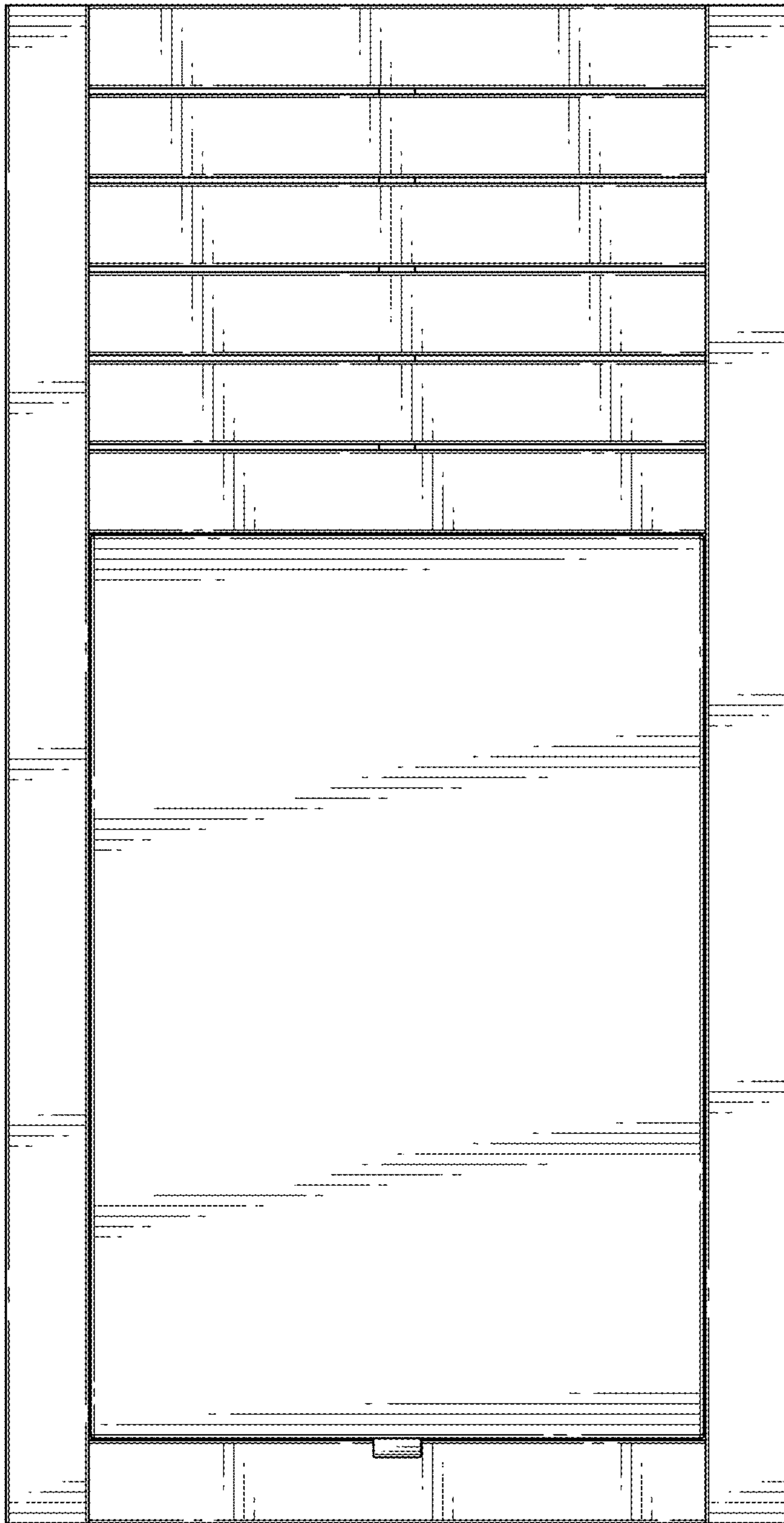

FIG. 4

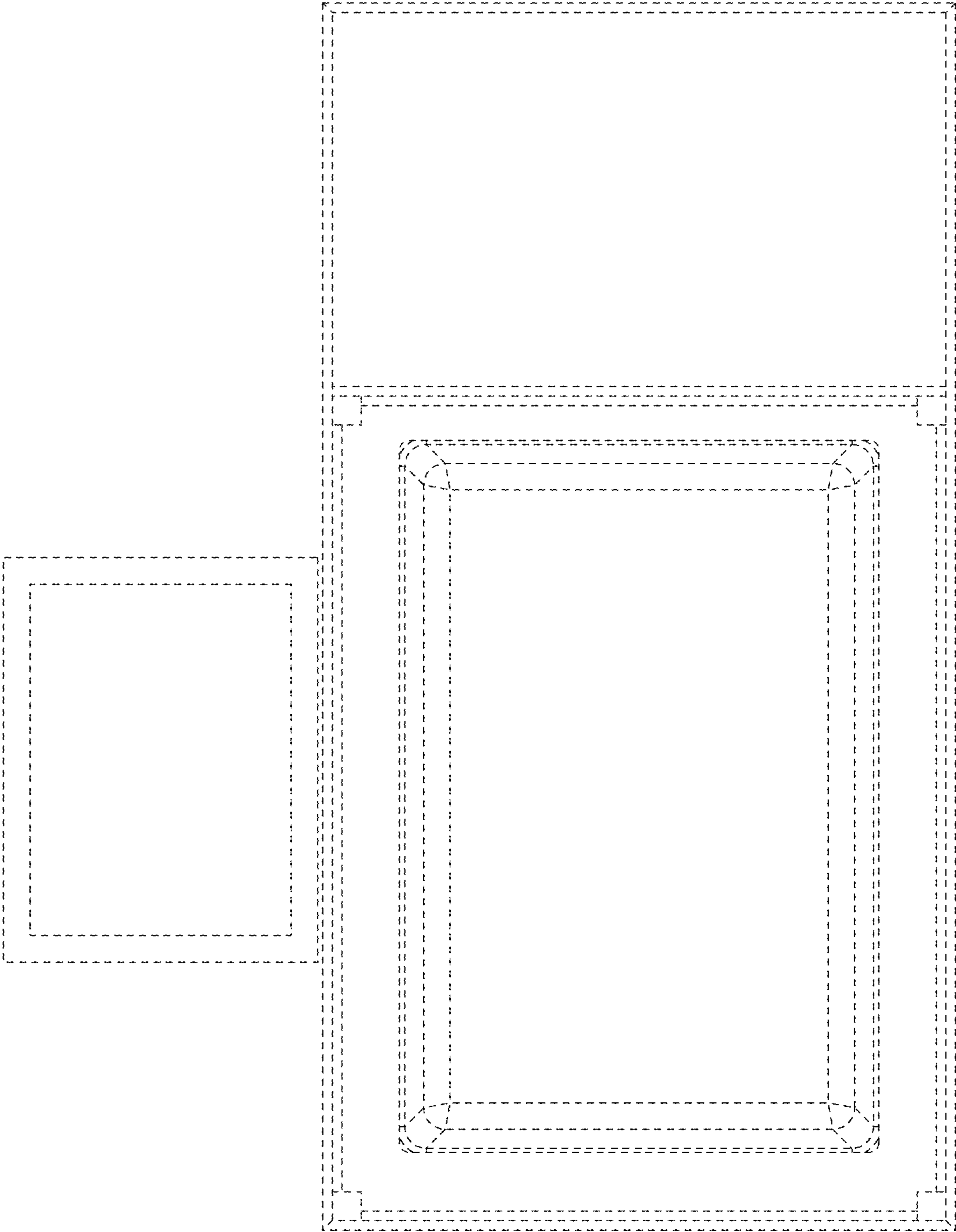

FIG. 5

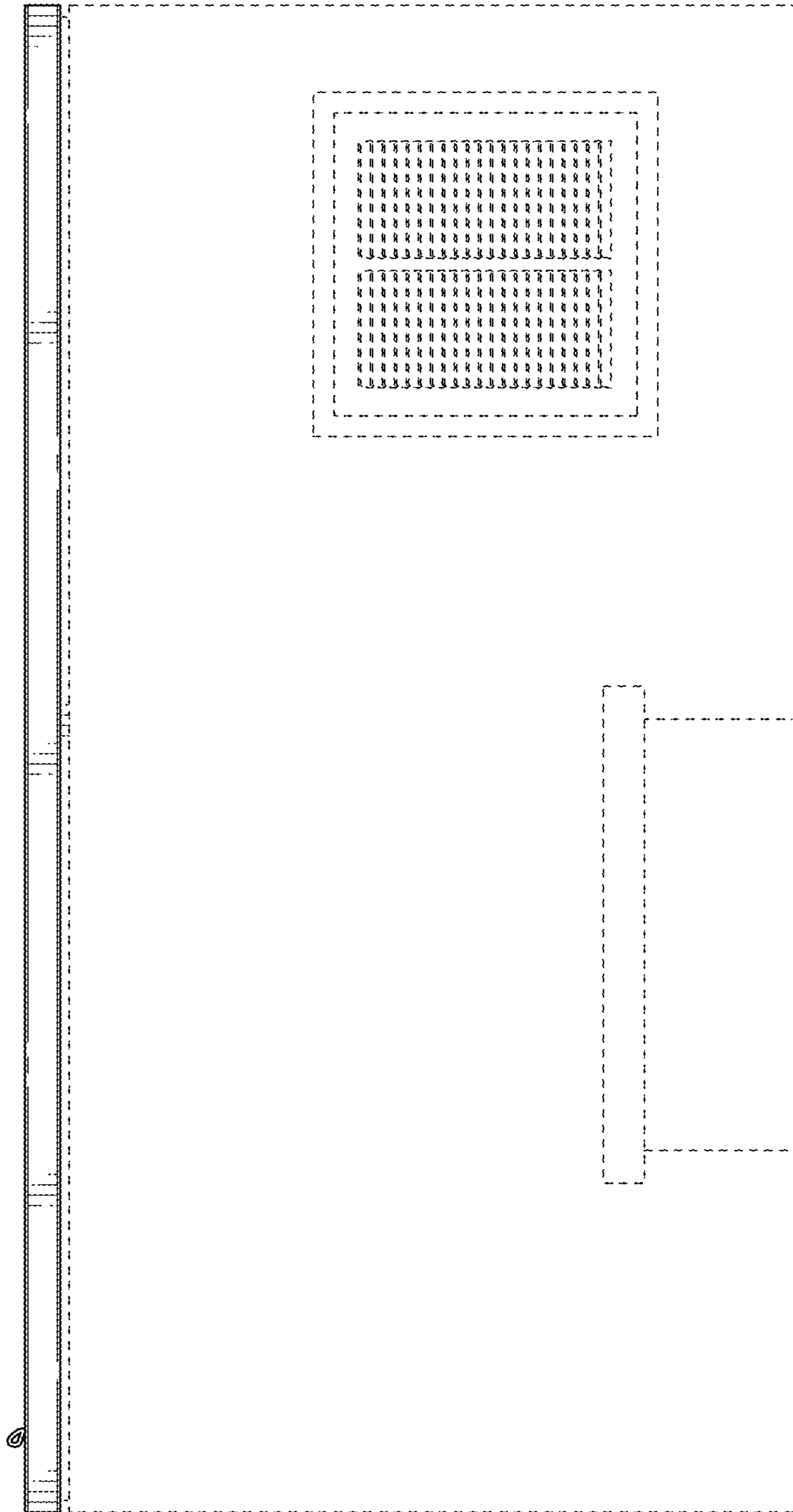

FIG. 6

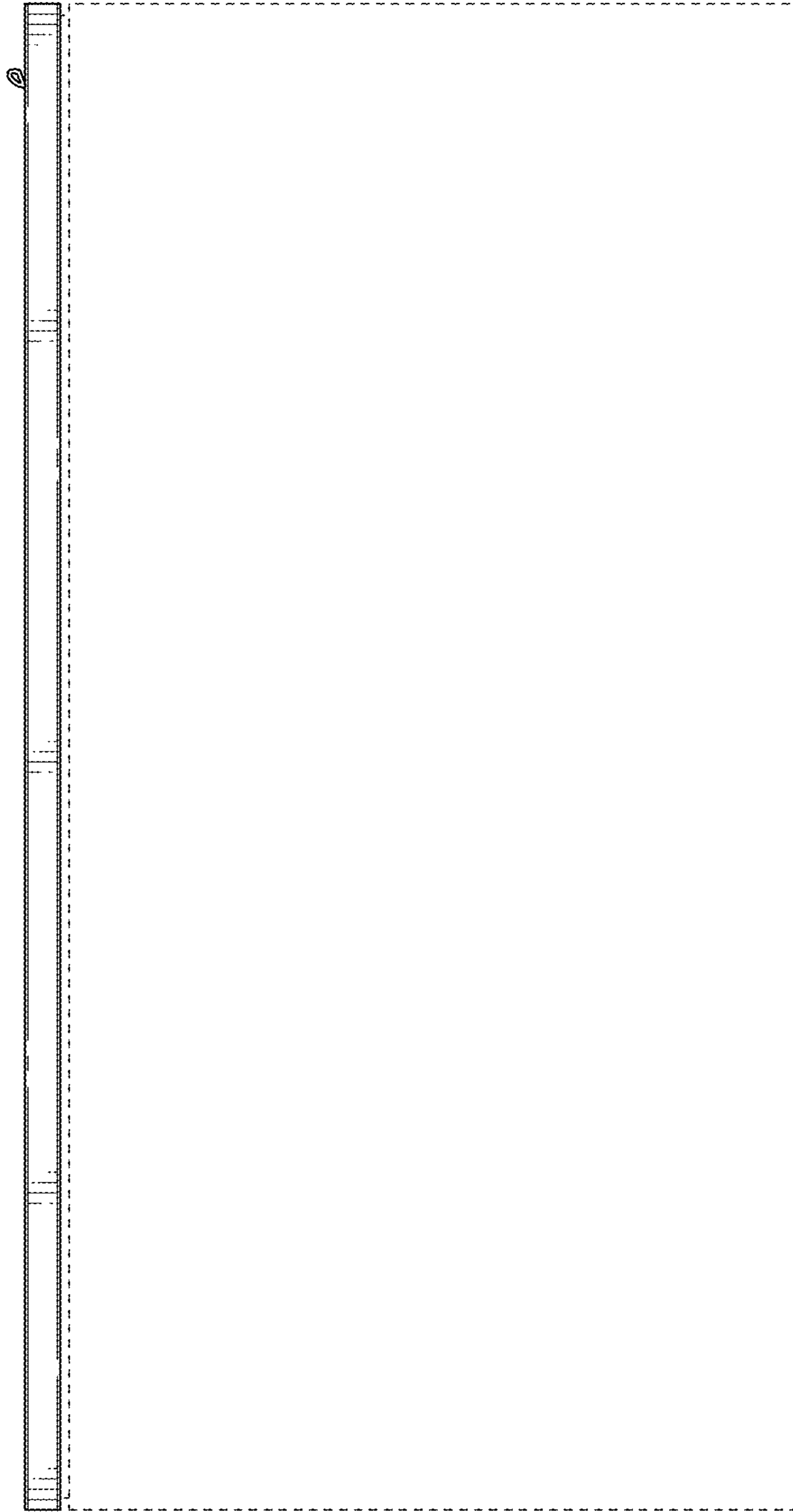

FIG. 7

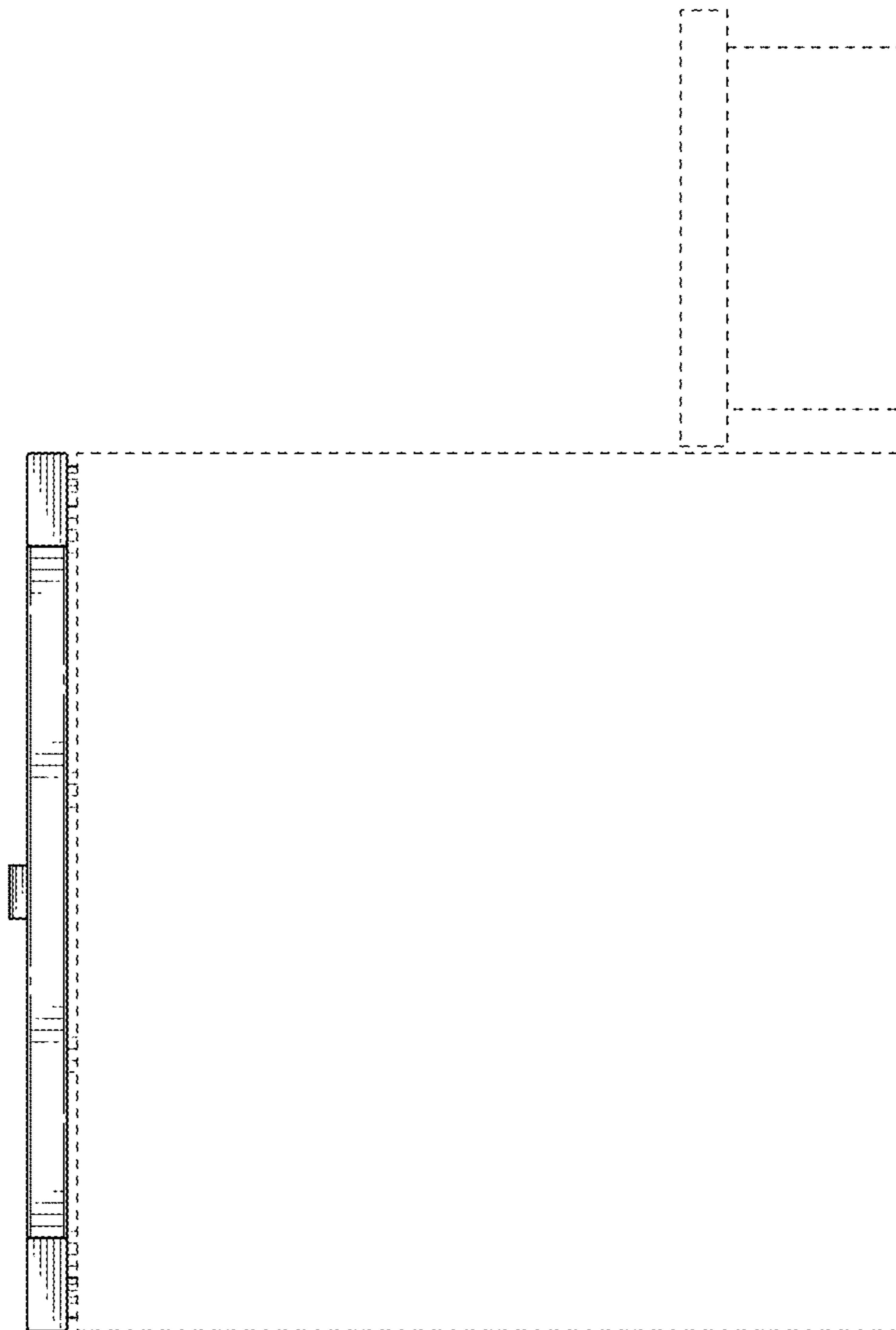

FIG. 8

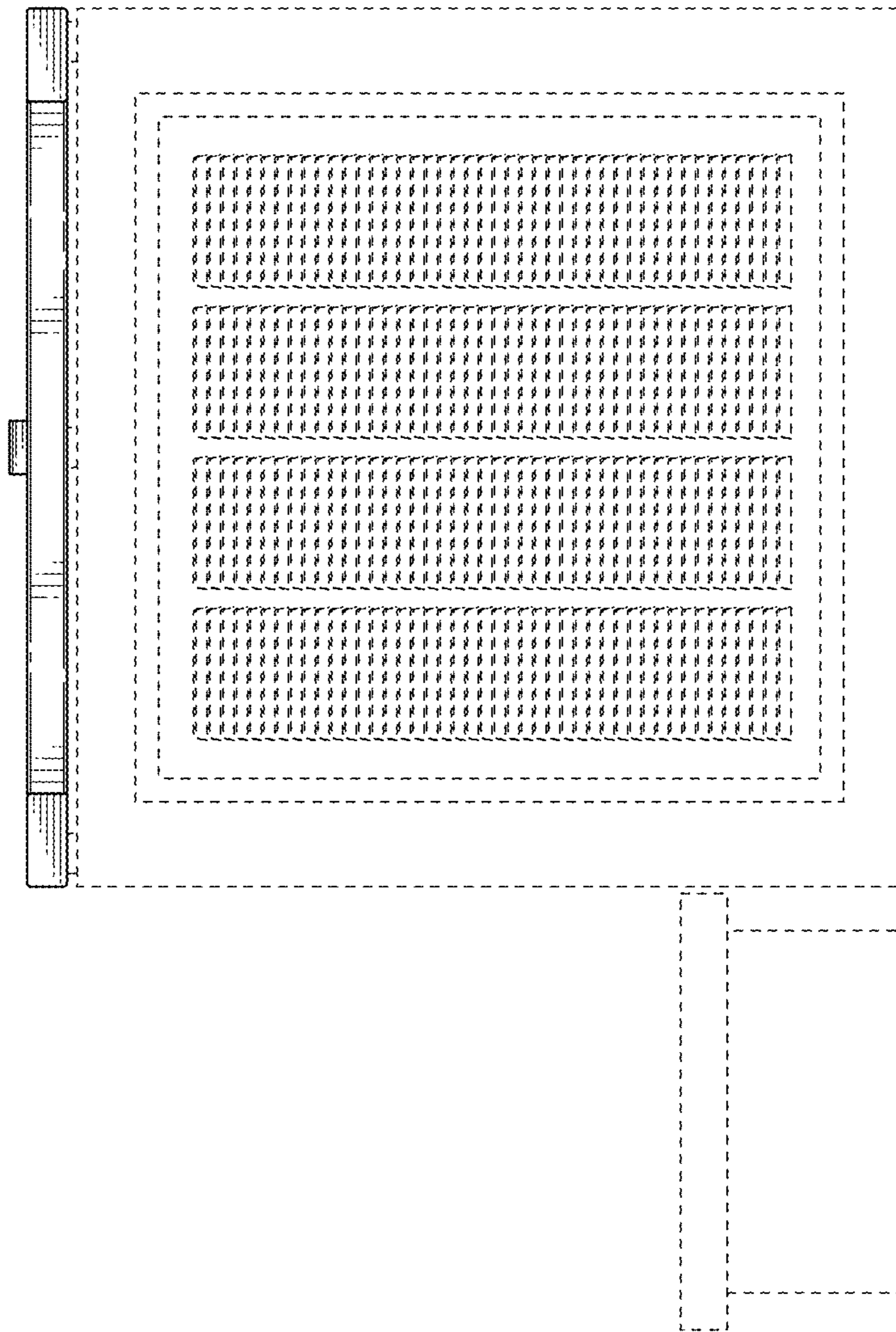

FIG. 9