



US0D1035988S

(12) **United States Design Patent**
Reid et al.

(10) **Patent No.:** **US D1,035,988 S**
(45) **Date of Patent:** **** Jul. 16, 2024**

- (54) **ELECTRONIC VAPORIZER**
- (71) Applicant: **iVision Tech Inc.**, Middletown, DE (US)
- (72) Inventors: **Blake Reid**, McKinney, TX (US); **Ali Kohbodi**, Sierra Madre, CA (US)
- (**) Term: **15 Years**
- (21) Appl. No.: **29/813,431**
- (22) Filed: **Oct. 28, 2021**

D814,693 S *	4/2018	Qiu	D27/101
D819,880 S *	6/2018	Qiu	D27/101
D821,639 S *	6/2018	Dai	D27/162
D828,622 S *	9/2018	Chen	D27/162
D852,409 S	6/2019	Takebara		
D857,984 S	8/2019	Zhu		
D890,416 S *	7/2020	Ouyang	D27/162
D914,278 S *	3/2021	Luo	D27/162
D932,095 S *	9/2021	Liu	D27/162
D953,616 S *	5/2022	Liu	D27/162
D989,385 S *	6/2023	Hai	D27/162
2023/0139744 A1 *	5/2023	Kohbodi	A24F 40/51 131/329

* cited by examiner

Related U.S. Application Data

- (63) Continuation-in-part of application No. 17/513,045, filed on Oct. 28, 2021.
- (51) **LOC (14) Cl.** **27-07**
- (52) **U.S. Cl.**
USPC **D27/162**
- (58) **Field of Classification Search**
USPC D27/100–101, 161–196; D23/360, 362;
D24/110, 110.4–110.6, 113
CPC A24F 40/10; A24F 40/42; A24F 40/485;
A24F 40/40; A24F 40/46; A61M 15/06;
A61M 11/042; A61M 2205/8206
See application file for complete search history.

Primary Examiner — Marissa J Cash
Assistant Examiner — William B Melliar
(74) *Attorney, Agent, or Firm* — Clement Cheng

(57) **CLAIM**

The ornamental design for an electronic vaporizer, as shown and described.

DESCRIPTION

FIG. 1 is a perspective view.
FIG. 2 is a bottom perspective view.
FIG. 3 is a right side view.
FIG. 4 is a left side view.
FIG. 5 is a front view.
FIG. 6 is a back view.
FIG. 7 is a top view; and,
FIG. 8 is a bottom view.
The broken lines in the drawings depict portions of the electronic vaporizer that form no part of the claimed design.

(56) **References Cited**

U.S. PATENT DOCUMENTS

D761,999 S *	7/2016	Liu	D27/101
D788,362 S	5/2017	Qiu		
D790,766 S *	6/2017	Li	D27/163
D800,377 S *	10/2017	Liu	D27/101

1 Claim, 7 Drawing Sheets

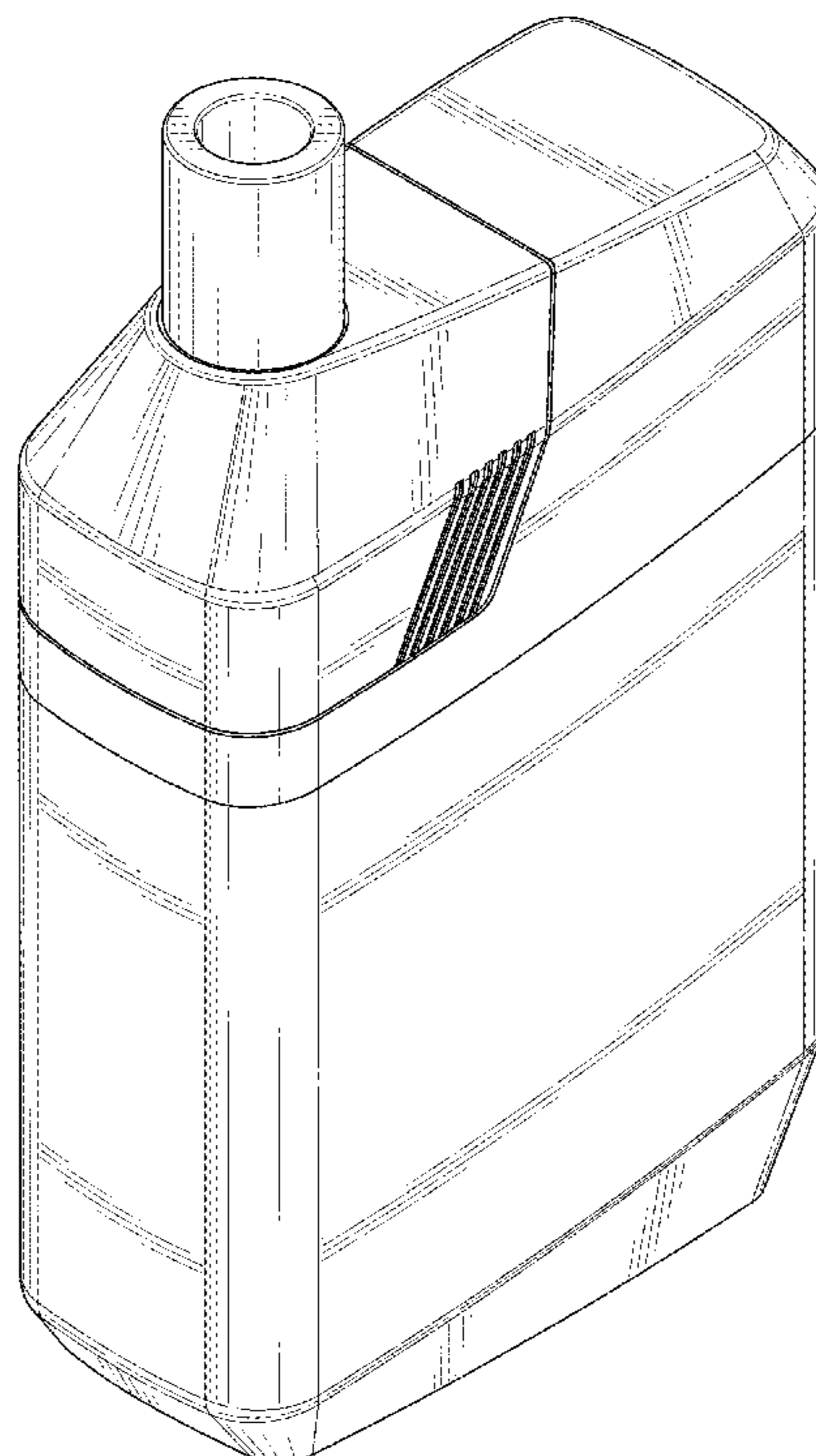

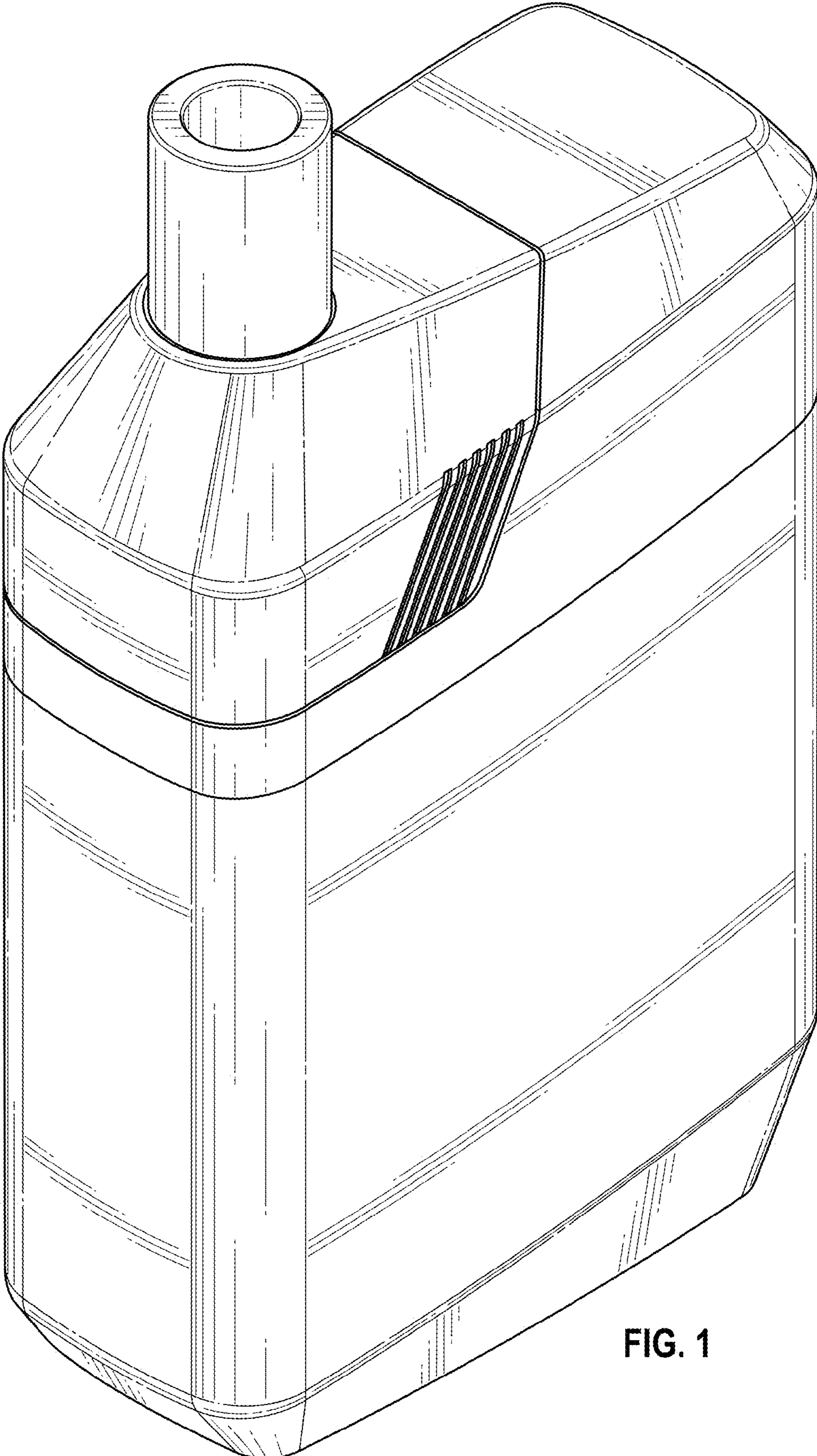

FIG. 1

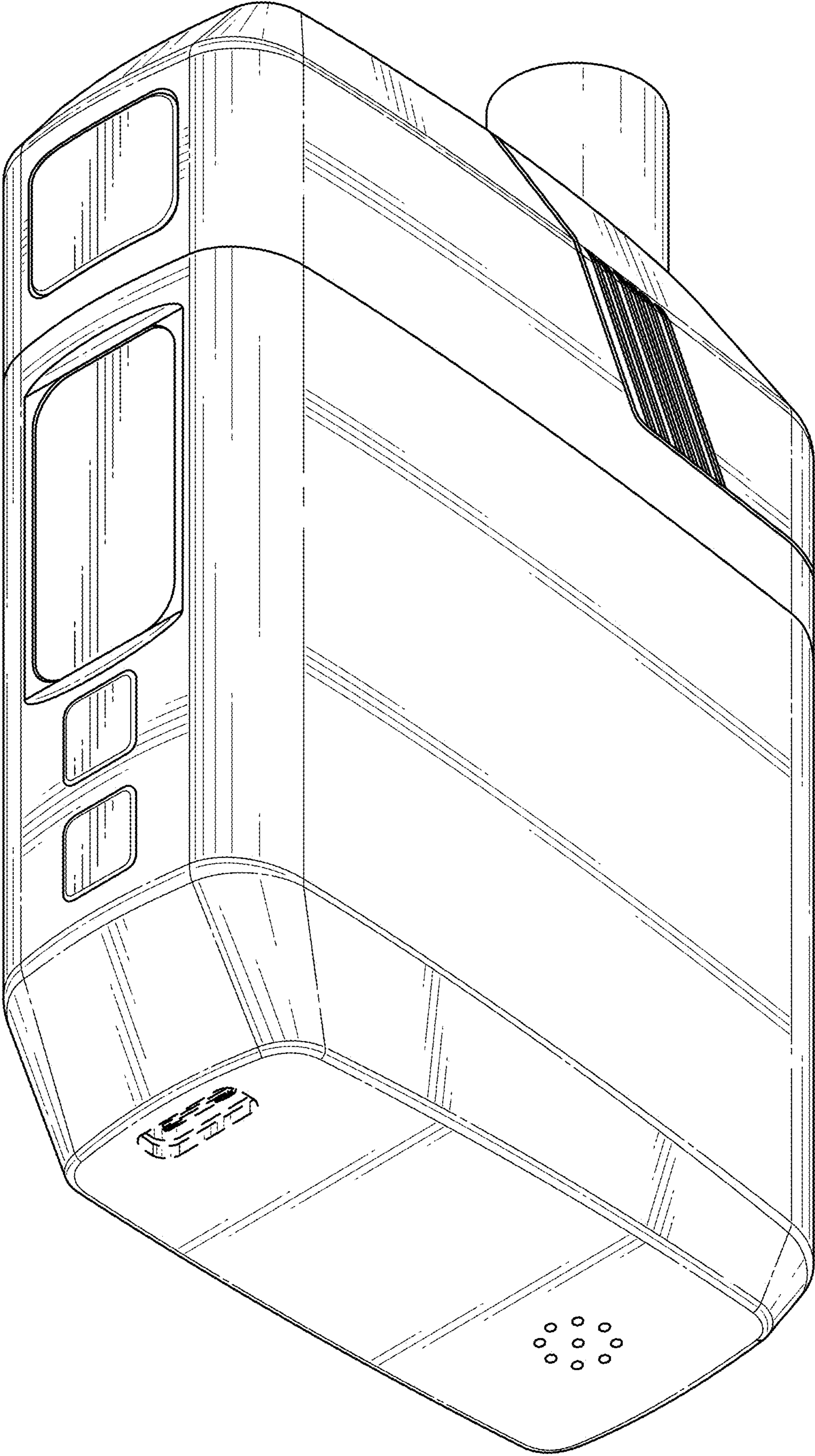

FIG. 2

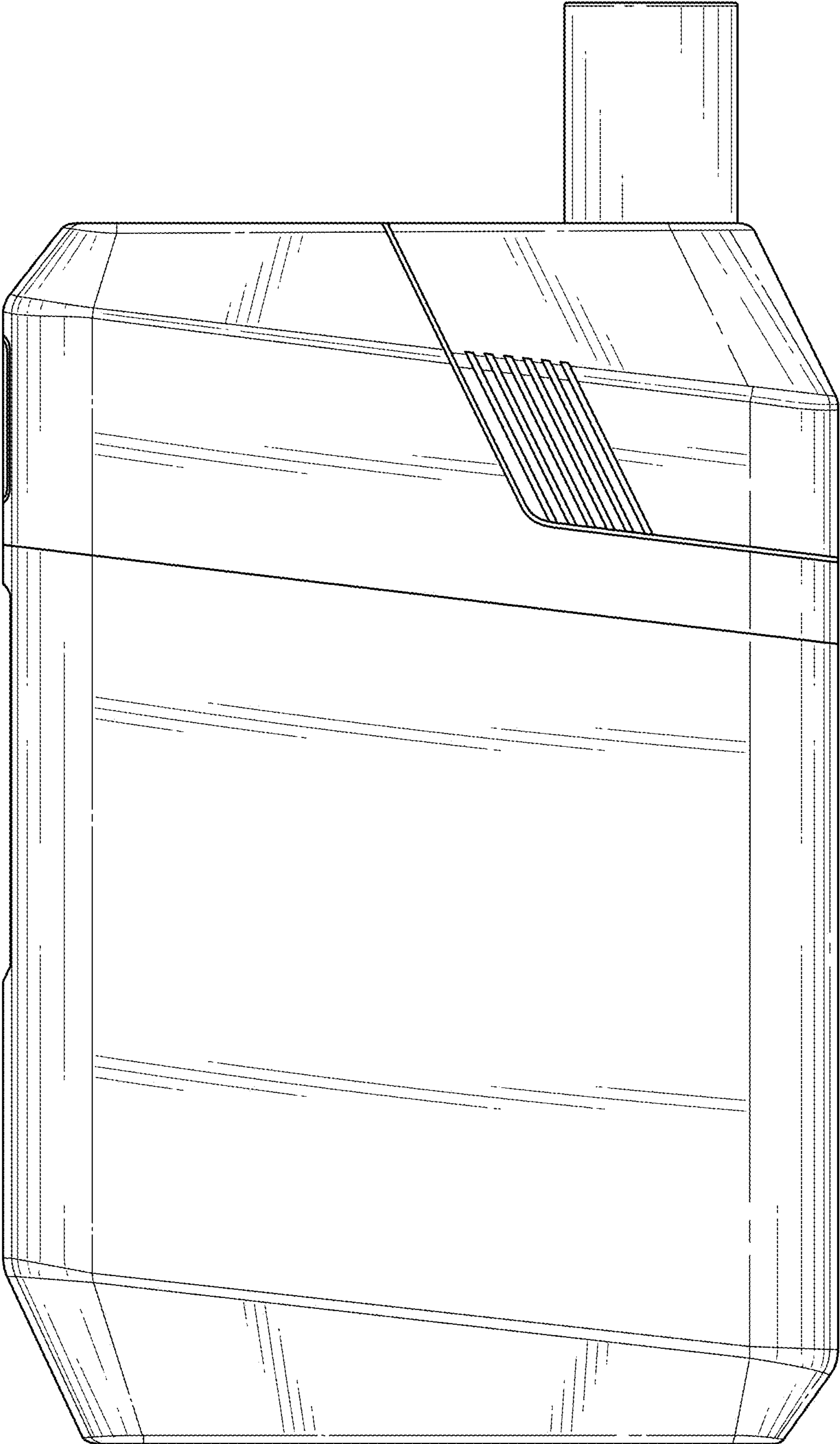

FIG. 3

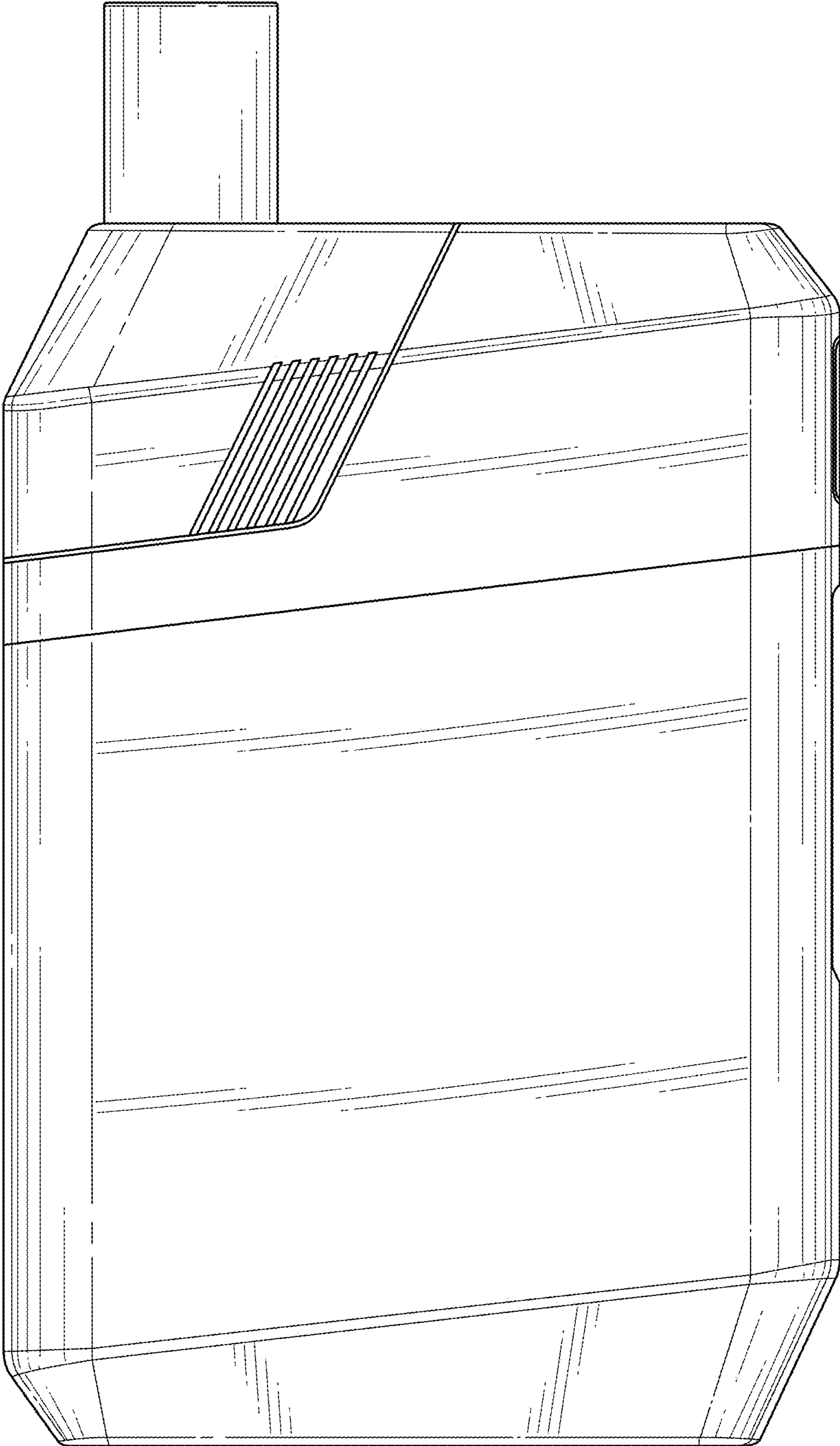

FIG. 4

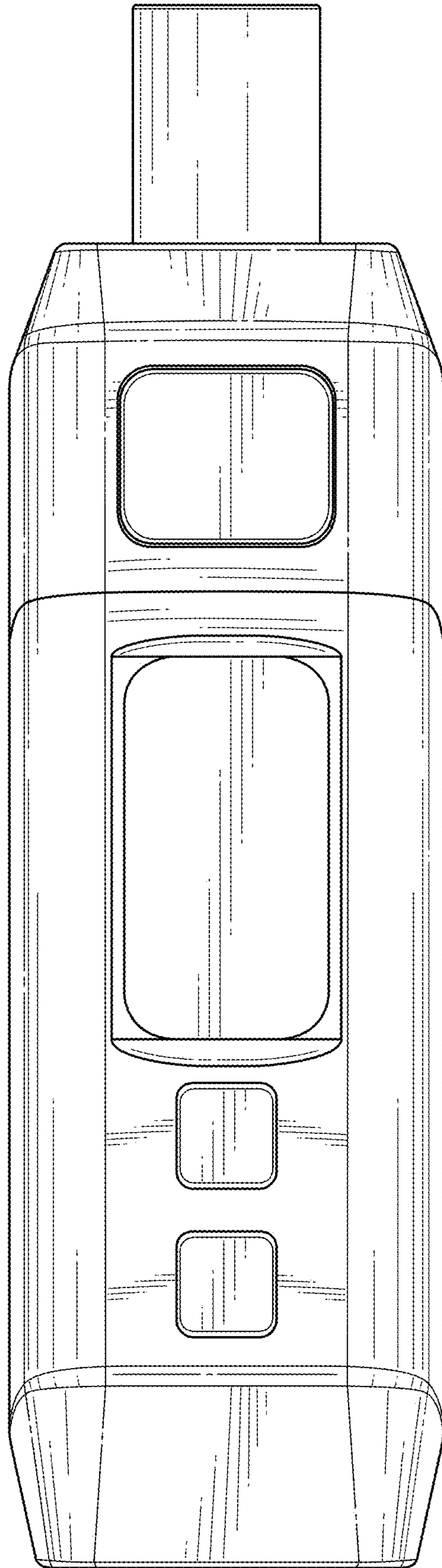

FIG. 5

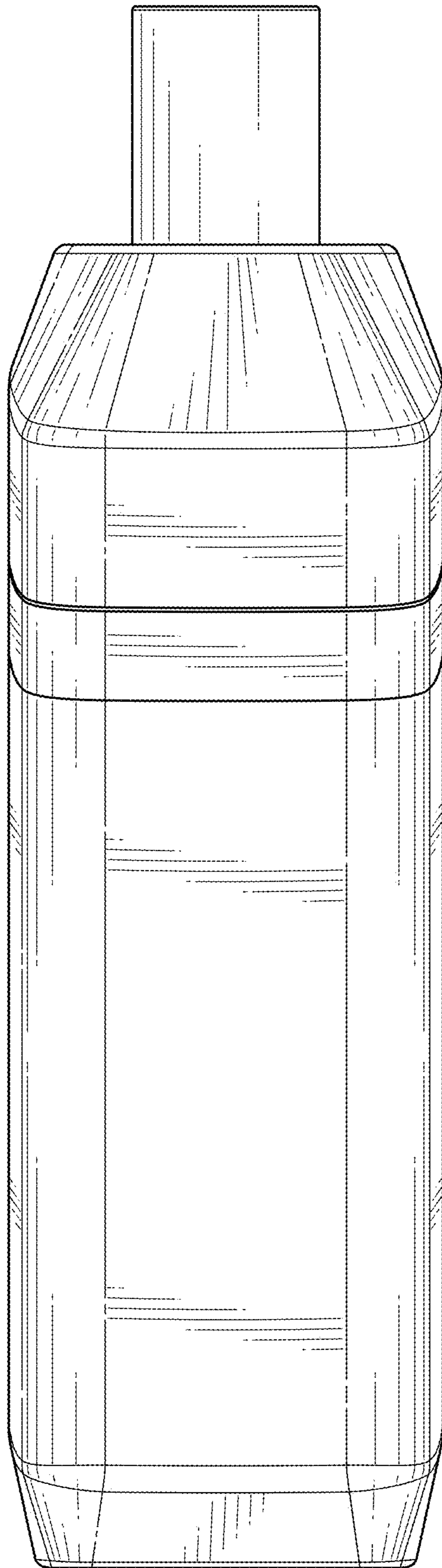

FIG. 6

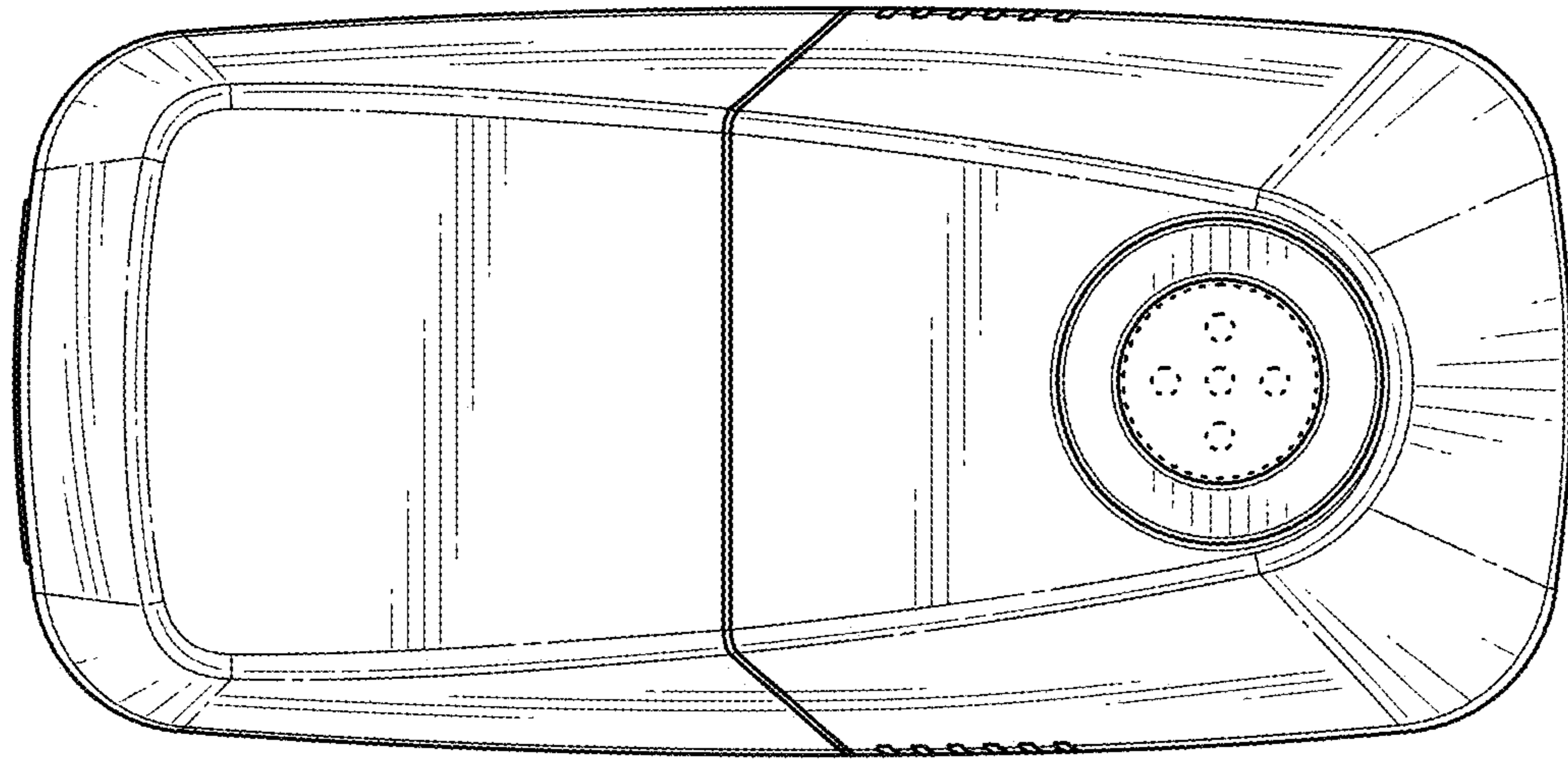

FIG. 7

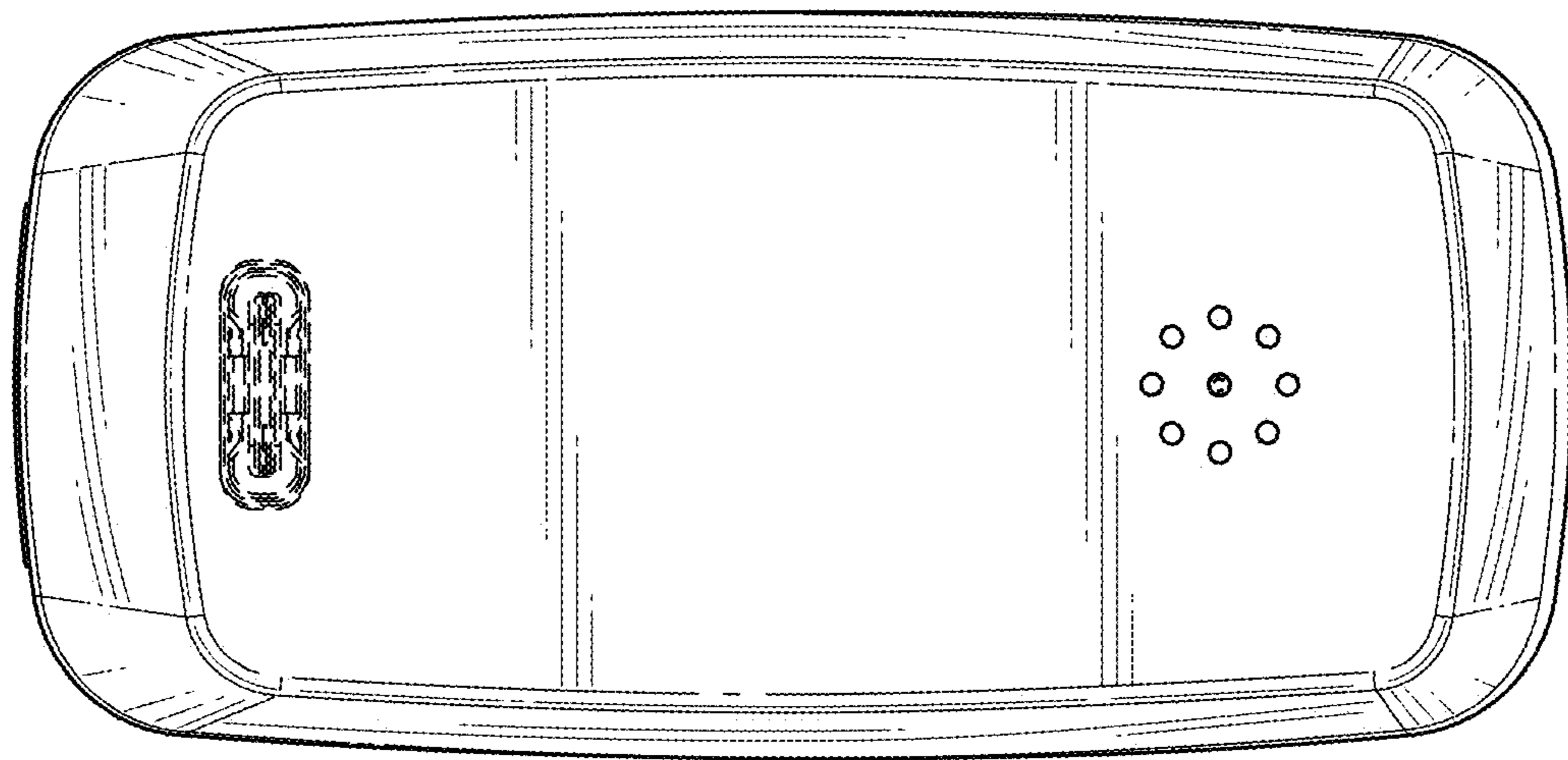

FIG. 8