



US0D1033538S

(12) **United States Design Patent** (10) **Patent No.:** **US D1,033,538 S**  
**Rosburg et al.** (45) **Date of Patent:** **\*\* Jul. 2, 2024**

(54) **VENDING MACHINE** 6,948,324 B2 \* 9/2005 Jin ..... F25D 23/006  
62/298  
(71) Applicant: **PepsiCo, Inc.**, Purchase, NY (US) D513,014 S 12/2005 Seki  
D518,836 S 4/2006 Reese et al.  
(72) Inventors: **Klaus Rosburg**, Brooklyn, NY (US); D520,532 S 5/2006 Reese et al.  
**Stephen Lim**, Chappaqua, NY (US); D520,533 S 5/2006 Reese et al.  
**Gustavo De Souza Messias**, Milan D541,315 S 4/2007 Trulaske, Sr.  
(IT); **Ali Akay**, Milan (IT); **Martin** D630,230 S 1/2011 Yang  
**Ivar Franzen**, Milan (IT) D646,307 S 10/2011 Schaffer et al.  
(73) Assignee: **PepsiCo, Inc.**, Purchase, NY (US) (Continued)  
(\*\*) Term: **15 Years**  
(21) Appl. No.: **29/801,619**  
(22) Filed: **Jul. 29, 2021**  
(51) **LOC (14) Cl.** ..... **20-01**  
(52) **U.S. Cl.**  
USPC ..... **D20/8**  
(58) **Field of Classification Search**  
USPC ..... D20/1-9, 99; D15/79, 81, 89; D99/28  
CPC ... G07F 9/00; G07F 7/00; G07F 7/025; G07F  
7/08; G07F 7/12; G07F 11/00; G07F  
11/02; G07F 11/62; G07F 11/165; G07F  
7/069; G07F 13/00; G07F 17/00; G07F  
17/40; G06Q 20/18  
See application file for complete search history.

(56) **References Cited**  
U.S. PATENT DOCUMENTS  
D196,207 S \* 9/1963 Fink ..... D15/87  
D244,019 S 4/1977 Brown  
D271,107 S 10/1983 Trulaske  
D357,026 S \* 4/1995 Kelemen ..... D6/661  
D363,398 S 10/1995 Branz et al.  
5,803,560 A 9/1998 Trulaske, Sr. et al.  
D420,368 S \* 2/2000 Bardin ..... D15/91  
D421,534 S 3/2000 Trulaske, Sr. et al.  
D449,844 S 10/2001 Kim  
D481,224 S 10/2003 Draper  
D481,740 S 11/2003 Li et al.

**OTHER PUBLICATIONS**  
Pepsico introduces social vending system, posted at prnewswire.com, posted on Apr. 27, 2011, retrieved from internet: https://www.prnewswire.com/news-releases/pepsico-introduces-social-vending-system-the-next-generation-in-interactive-vend-technology-120769284.html (Year: 2011).\*  
(Continued)  
*Primary Examiner* — Catherine Ho  
(74) *Attorney, Agent, or Firm* — Sterne, Kessler, Goldstein & Fox P.L.L.C.

(57) **CLAIM**  
The ornamental design for a vending machine, as shown and described.

**DESCRIPTION**  
FIG. 1 is a top perspective view of a vending machine showing the claimed design;  
FIG. 2 is a bottom perspective view thereof;  
FIG. 3 is a front view thereof;  
FIG. 4 is a rear view thereof;  
FIG. 5 is a left side view thereof;  
FIG. 6 is a right side view thereof;  
FIG. 7 is a top view thereof; and,  
FIG. 8 is a bottom view thereof.  
The broken lines in the figures show portions of the vending machine that form no part of the claimed design.

**1 Claim, 7 Drawing Sheets**

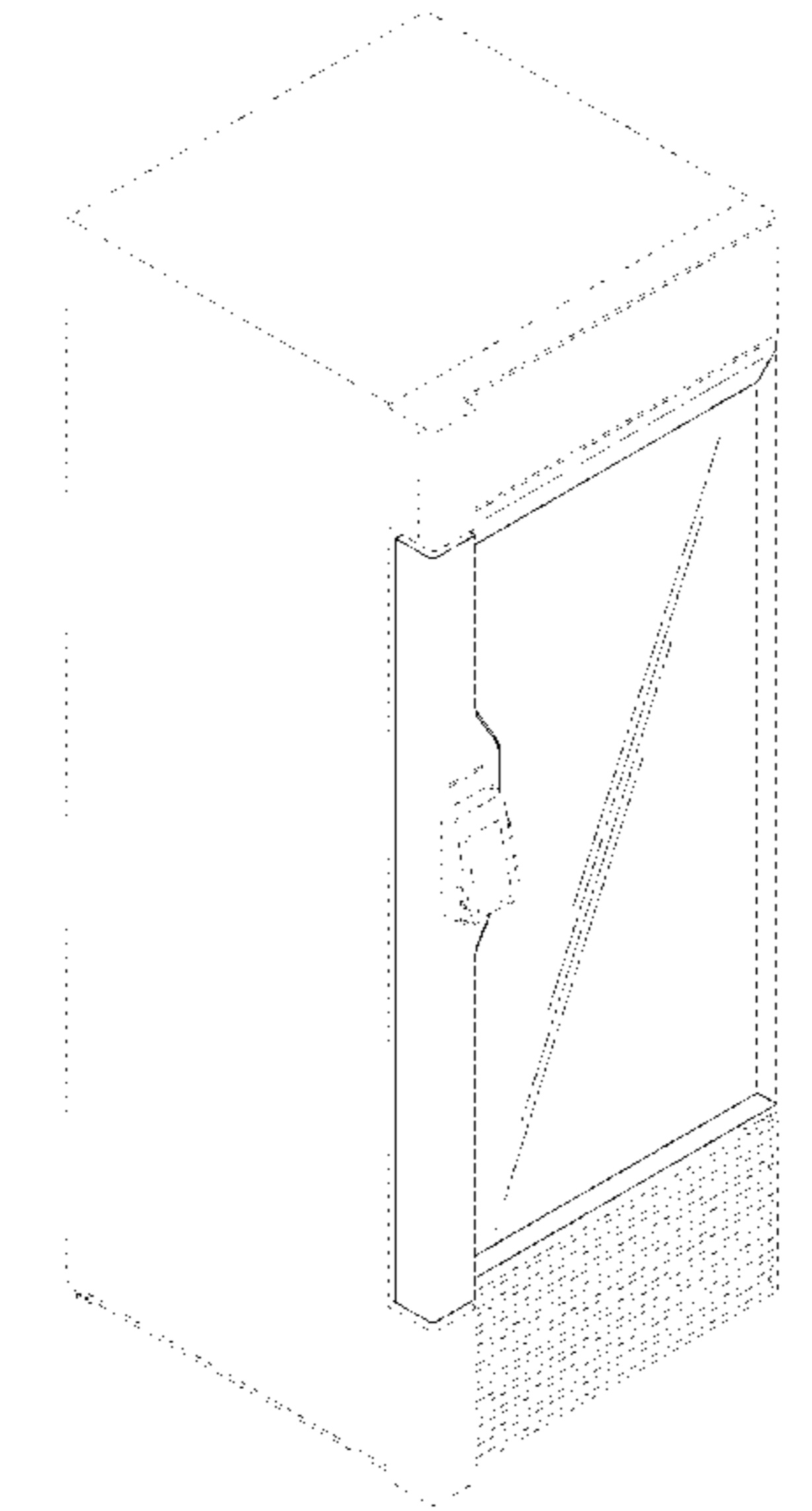

(56)

References Cited

U.S. PATENT DOCUMENTS

D651,221 S 12/2011 Voron et al.  
 D652,064 S 1/2012 Voron et al.  
 8,104,302 B2\* 1/2012 Hayase ..... A47F 3/0426  
 62/279  
 D656,967 S \* 4/2012 Yi ..... D15/86  
 8,157,336 B2\* 4/2012 Hayase ..... E05B 1/0015  
 312/222  
 D671,574 S 11/2012 Jafa et al.  
 D671,575 S 11/2012 Jafa et al.  
 D671,576 S 11/2012 Jafa et al.  
 8,387,872 B2\* 3/2013 Buffa ..... G07F 7/00  
 235/381  
 D693,379 S \* 11/2013 Brenneis ..... D15/81  
 8,672,427 B2\* 3/2014 Hammonds ..... A47F 11/06  
 312/116  
 D728,026 S 4/2015 Broen et al.  
 D736,272 S 8/2015 Stolarz et al.  
 D736,276 S \* 8/2015 Kim ..... D15/89  
 D745,901 S \* 12/2015 Kim ..... D15/89  
 D754,054 S \* 4/2016 Sethapun ..... D12/345  
 D756,428 S \* 5/2016 Ogg ..... D15/89  
 9,406,187 B2\* 8/2016 Hammonds ..... G07F 11/38  
 9,532,660 B2\* 1/2017 Jafa ..... A47F 3/0404  
 D787,565 S \* 5/2017 Broen ..... D15/81  
 9,750,355 B1\* 9/2017 Stolarz ..... A47F 3/0404  
 D799,565 S 10/2017 Broen et al.  
 D803,277 S 11/2017 Stolarz et al.  
 D850,499 S 6/2019 Broen et al.  
 D857,763 S \* 8/2019 Cunningham ..... D15/79

D860,318 S \* 9/2019 Li ..... D20/1  
 D894,974 S \* 9/2020 Cho ..... F25D 25/025  
 D15/79  
 D920,395 S \* 5/2021 Broen ..... D15/88  
 11,000,133 B2\* 5/2021 Jafa ..... F25D 23/065  
 11,157,886 B2\* 10/2021 Winsor ..... G06Q 20/18  
 11,672,359 B2\* 6/2023 Jain ..... A47F 5/0062  
 362/125  
 D999,796 S \* 9/2023 Shahrokhi ..... D15/91  
 2003/0213259 A1\* 11/2003 Upton ..... A47F 3/0408  
 62/507  
 2007/0241645 A1\* 10/2007 Trulaske, Sr. .... A47F 3/001  
 312/223.5  
 2008/0277361 A1\* 11/2008 Primiano ..... A47F 11/10  
 211/49.1  
 2008/0307815 A1\* 12/2008 Daddis, Jr. .... F25B 39/04  
 165/121  
 2009/0072679 A1\* 3/2009 Avila ..... F25D 23/028  
 312/116  
 2010/0018233 A1 1/2010 Jafa et al.  
 2011/0301749 A1 12/2011 Hammonds et al.  
 2021/0312751 A1\* 10/2021 Xu ..... G07F 11/1653

OTHER PUBLICATIONS

Pepsico launches new interactive vending machine, posted at foodbev.com, posted on Oct. 9, 2012, retrieved from internet: <https://www.foodbev.com/news/pepsico-launches-new-interactive-vending/> (Year: 2012).\*

\* cited by examiner

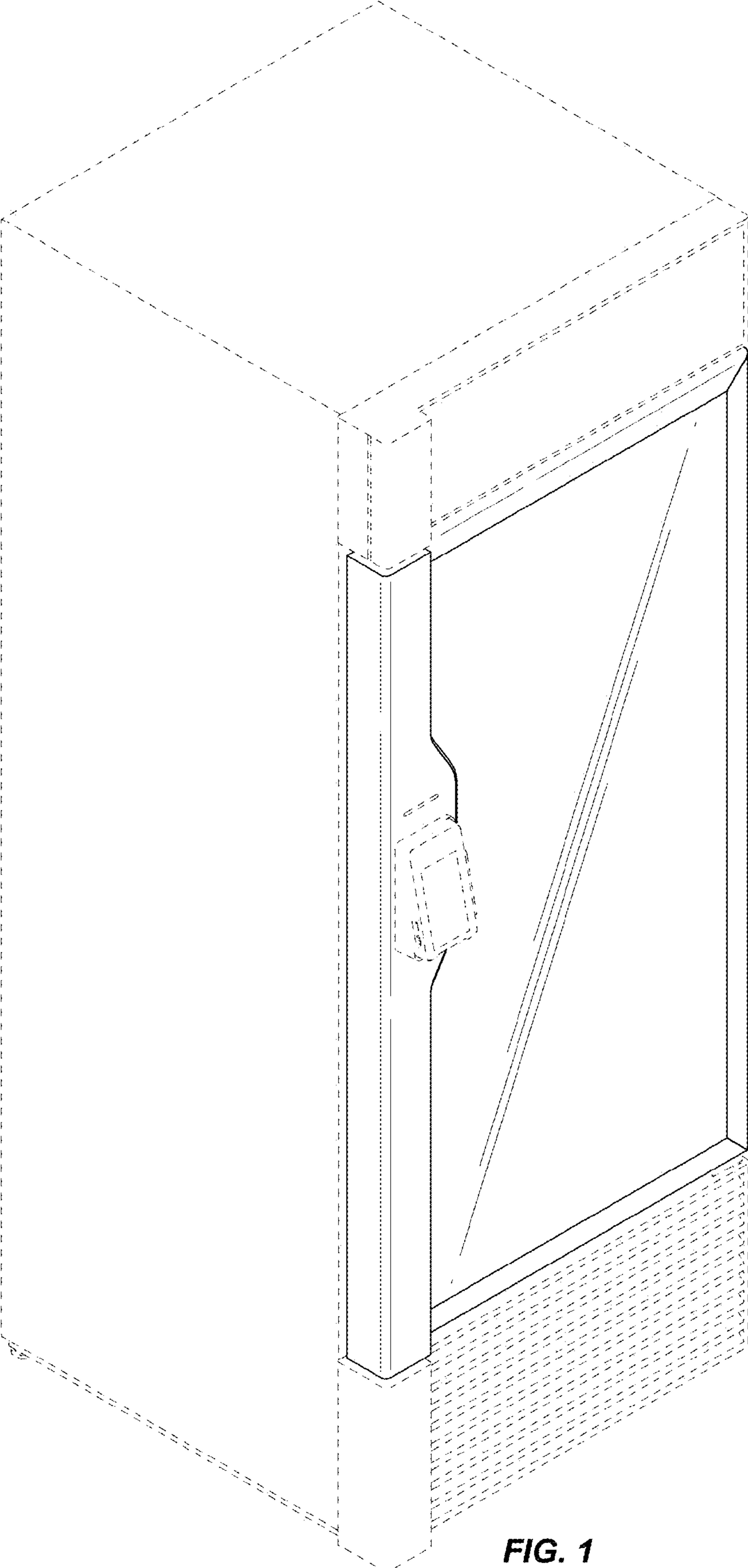

FIG. 1

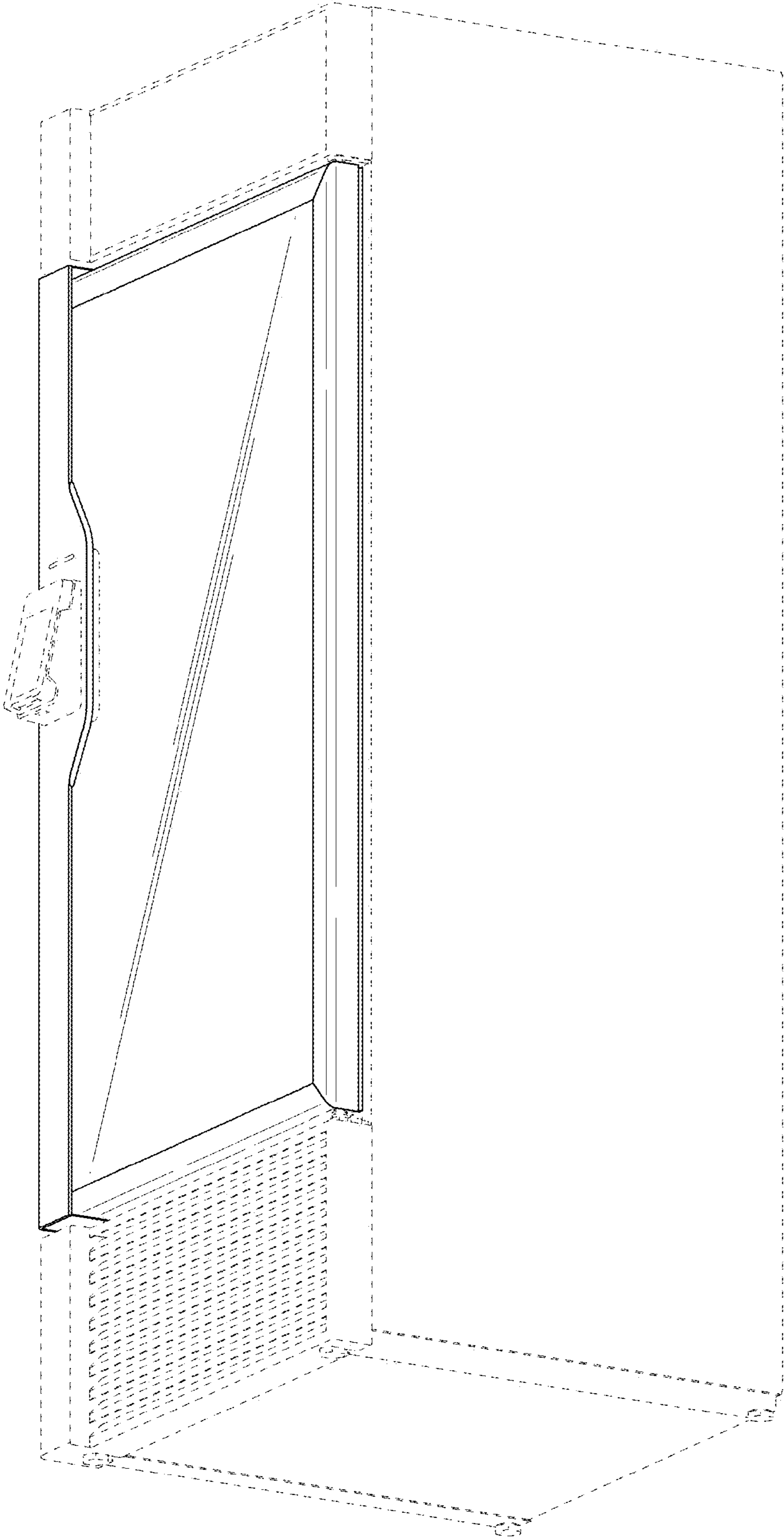

FIG. 2

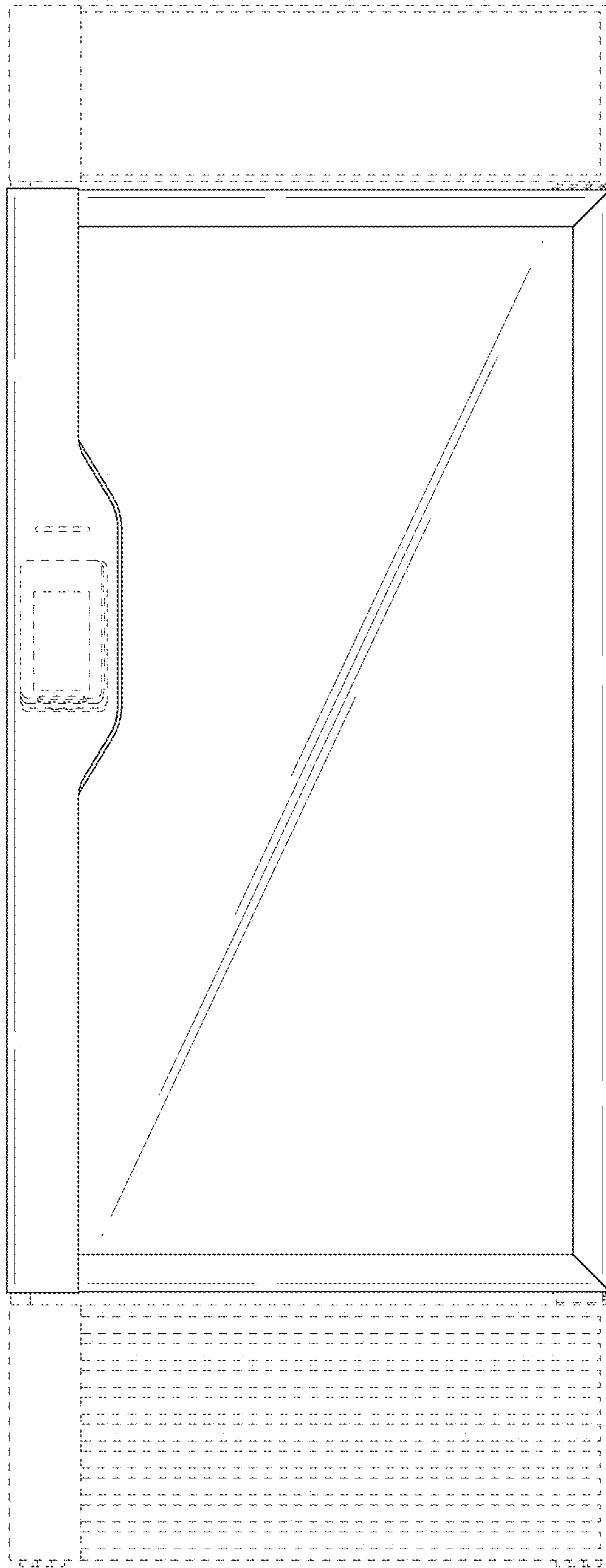

FIG. 3



**FIG. 4**

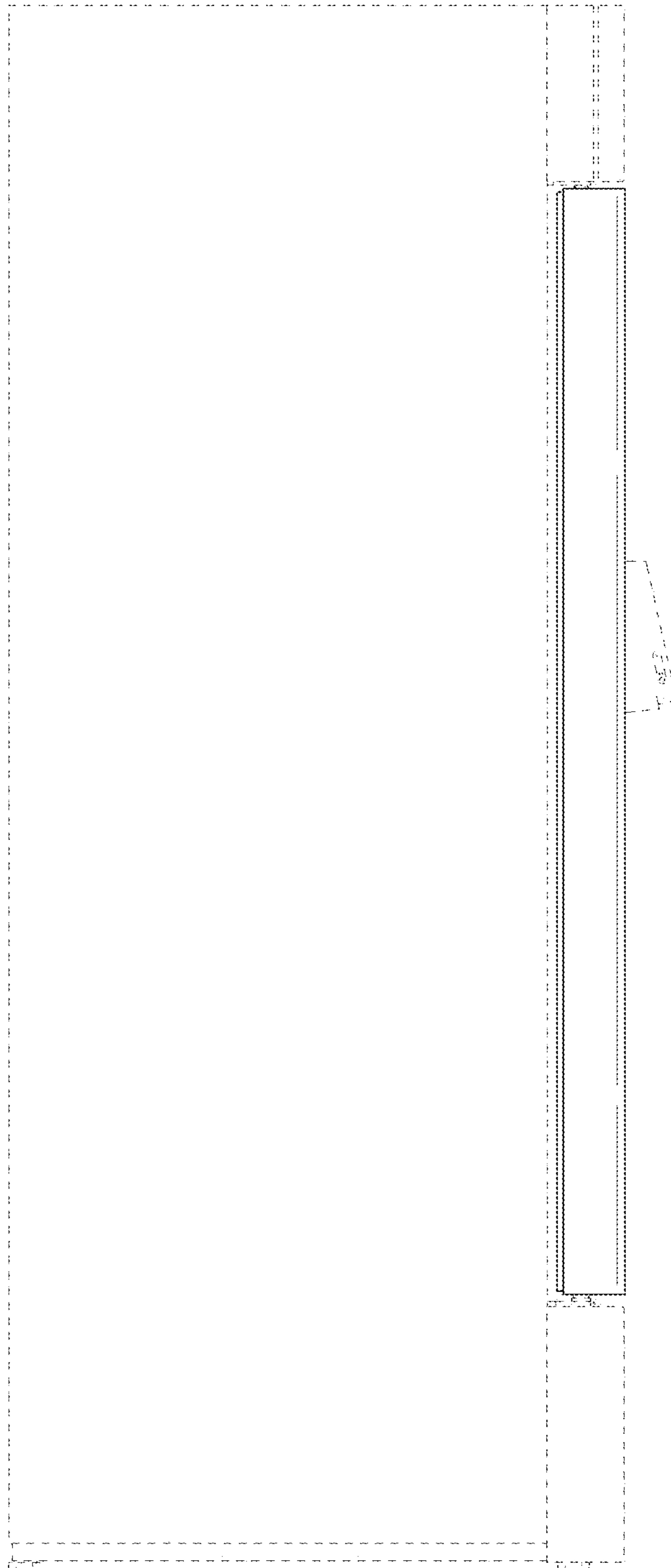

FIG. 5

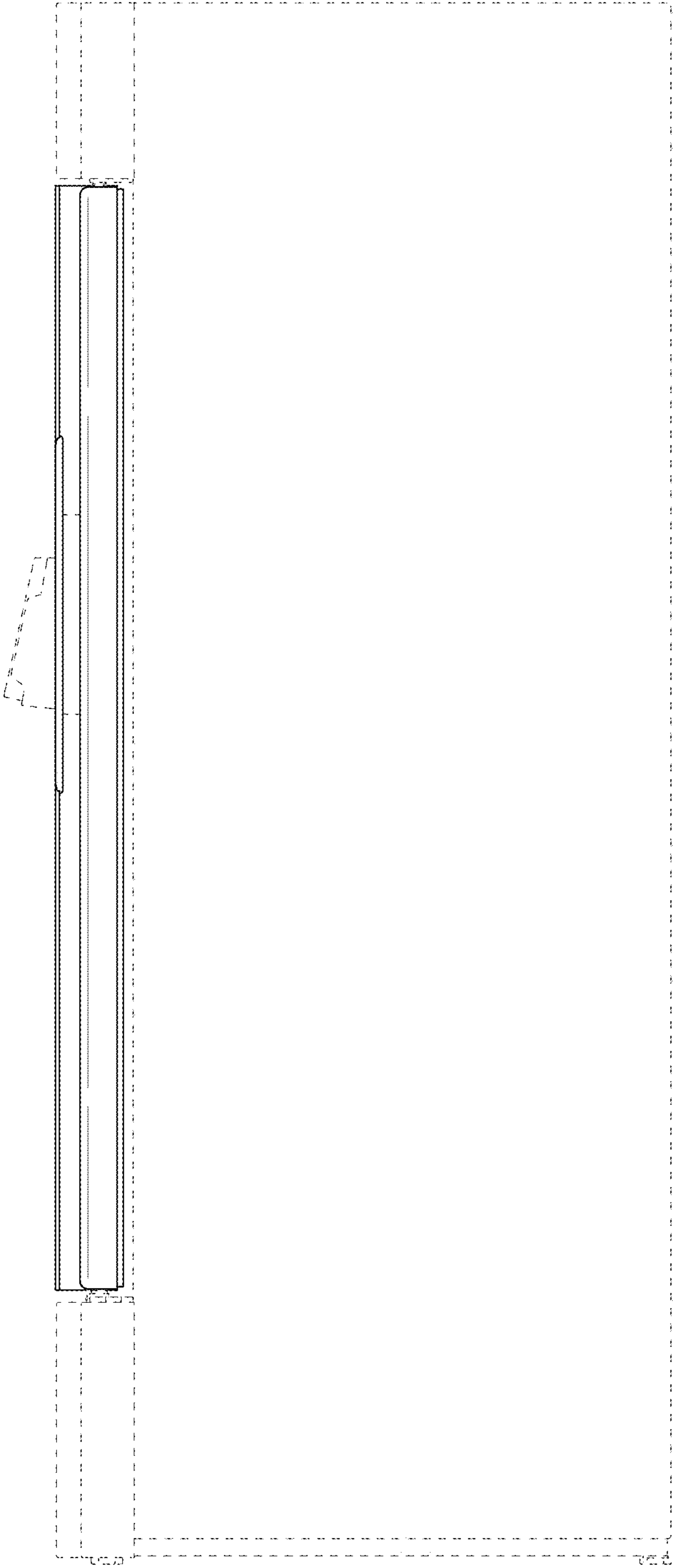
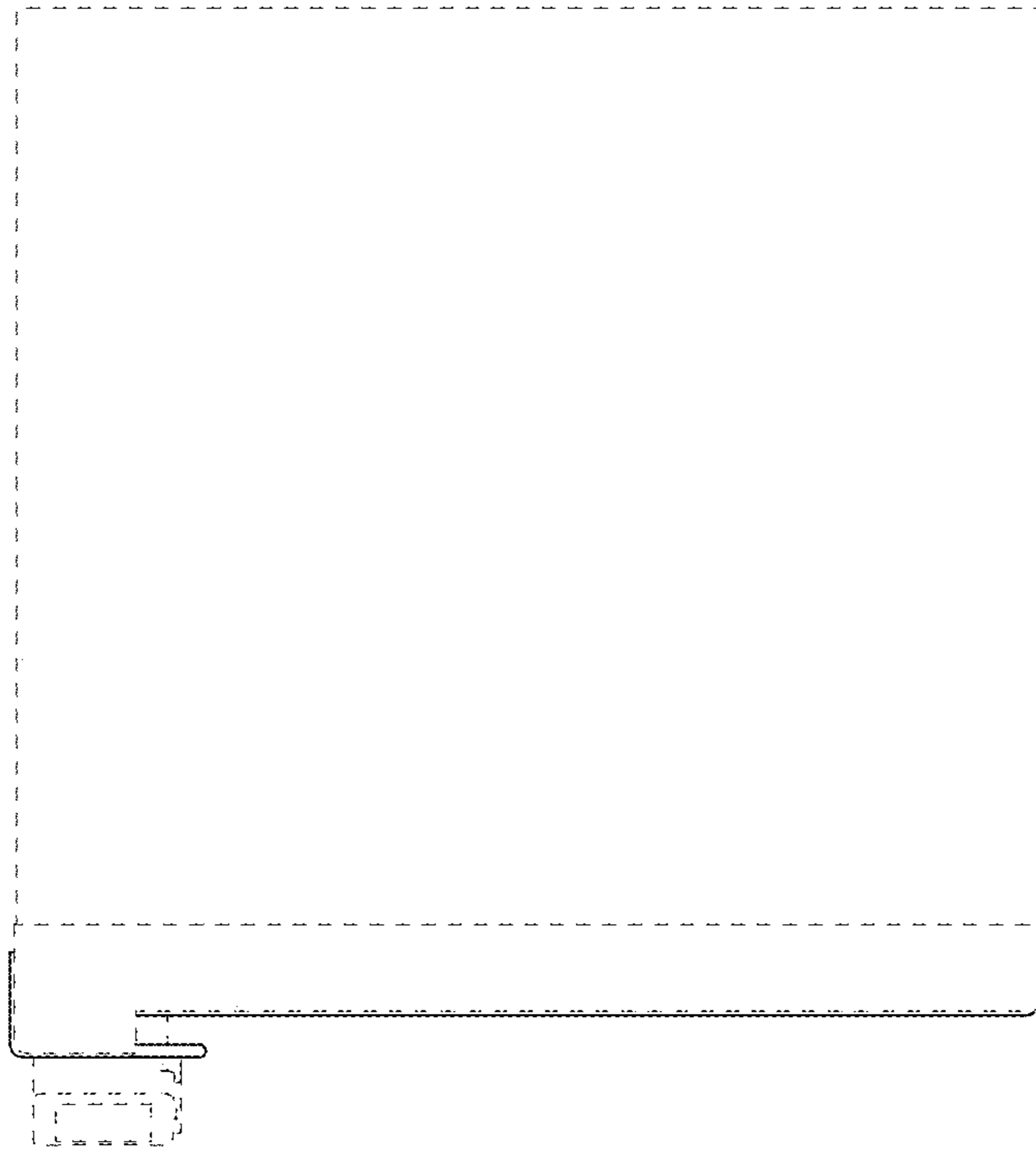
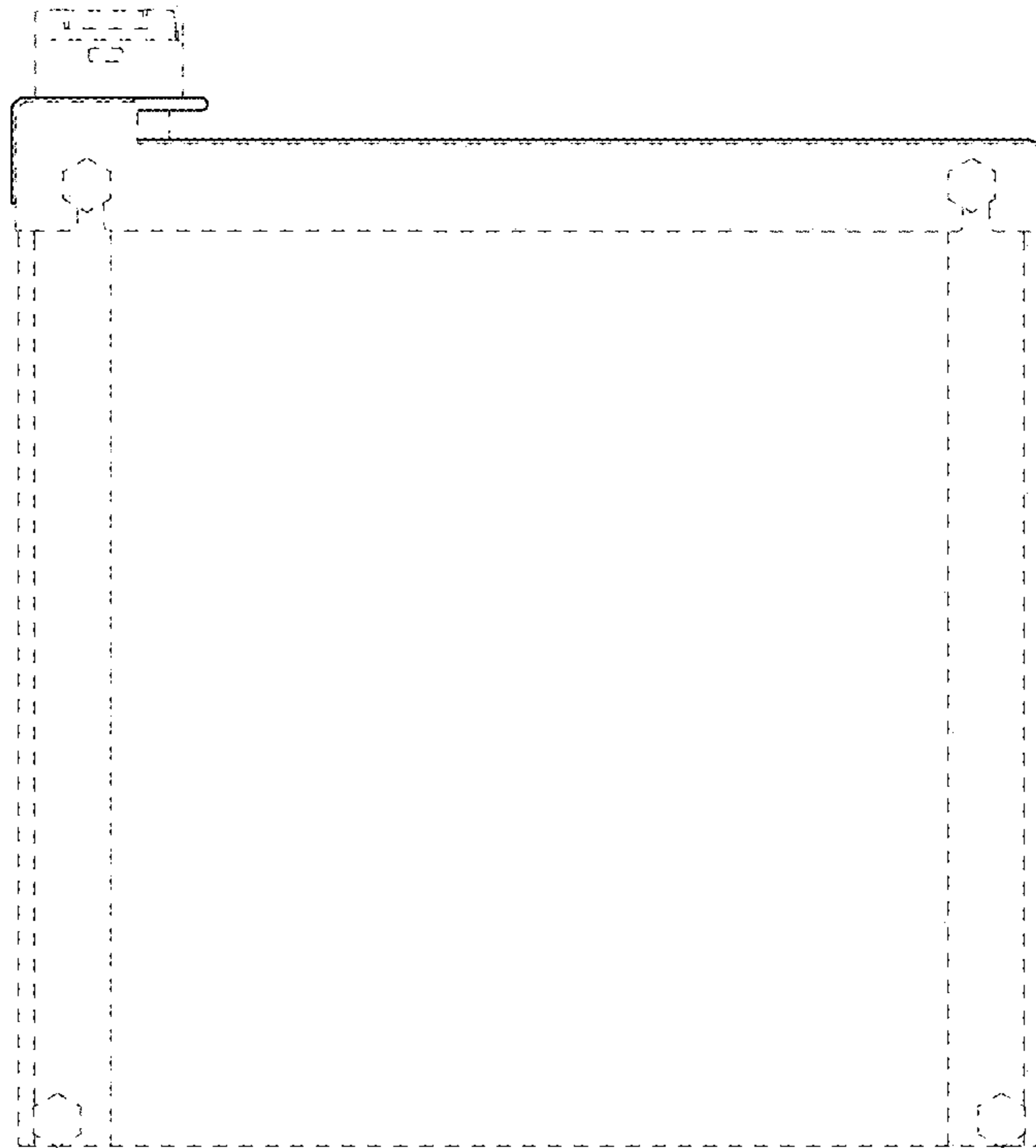

FIG. 6





**FIG. 7**



**FIG. 8**