



US0D1029094S

(12) **United States Design Patent** (10) **Patent No.:** **US D1,029,094 S**
Asano et al. (45) **Date of Patent:** **** May 28, 2024**

(54) **PRINTER**

D681,720 S 5/2013 Inada
D694,316 S * 11/2013 Jihoon D18/50
D730,437 S 5/2015 Seki et al.
D743,483 S 11/2015 Nanno et al.

(Continued)

(71) Applicant: **BROTHER INDUSTRIES, LTD.**,
Nagoya (JP)

(72) Inventors: **Masahide Asano**, Nagoya (JP); **Toshiya Inada**, Nagoya (JP)

(73) Assignee: **BROTHER INDUSTRIES, LTD.**,
Nagoya (JP)

JP D1633758 * 2/2022
JP D1633759 * 2/2022

(Continued)

(**) Term: **15 Years**

OTHER PUBLICATIONS

(21) Appl. No.: **29/835,761**

(22) Filed: **Apr. 21, 2022**

Amazon. Link: <https://www.amazon.com/Epson-Workforce-WF-4820-250-sheet-Touchscreen/dp/B08DXK91SX/?th=1>. Sep. 22, 2020. Epson® Workforce® Pro WF-4820 Wireless Color Inkjet All-In-One Printer, Black, Large (Year: 2020).*
HP Africa. Link: https://hp.com/emea_africa-en/products/printers/product-details/24494381. Visited Mar. 8, 2024. HP Laser MFP 135a (4ZB82A) (Year: 2024).*

(Continued)

Related U.S. Application Data

(62) Division of application No. 29/690,116, filed on May 6, 2019, now Pat. No. Des. 955,469.

(30) **Foreign Application Priority Data**

Nov. 8, 2018 (JP) 2018-024527
Nov. 8, 2018 (JP) 2018-024528

(51) **LOC (14) Cl.** **14-02**

(52) **U.S. Cl.**
USPC **D18/50**

(58) **Field of Classification Search**
USPC D18/36-41, 45-49, 50, 53-56, 59;
D14/121, 301, 307, 420-421
CPC H04N 1/00204; H04N 1/00249; H04N
1/00278; G06K 15/12; G06K 15/14; B41J
3/00; B41J 3/28; B41J 3/445; B41J 3/46
See application file for complete search history.

(56) **References Cited**

U.S. PATENT DOCUMENTS

D641,778 S * 7/2011 Lee D18/37
D648,377 S 11/2011 Miyauchi et al.
D667,489 S 9/2012 Inoue et al.

Primary Examiner — Lauren D McVey
(74) *Attorney, Agent, or Firm* — Oliff PLC

(57) **CLAIM**

The ornamental design for a printer, as shown and described.

DESCRIPTION

FIG. 1 is a perspective view of the printer;
FIG. 2 is a front elevational view thereof;
FIG. 3 is a rear elevational view thereof;
FIG. 4 is a left-side elevational view thereof;
FIG. 5 is a right-side elevational view thereof;
FIG. 6 is a top plan view thereof; and,
FIG. 7 is a bottom plan view thereof.
The evenly spaced and dot-dash broken lines immediately adjacent to the shaded areas depict the bounds of the claimed design, while all other broken lines are directed to environment. The broken lines form no part of the claimed design.

1 Claim, 7 Drawing Sheets

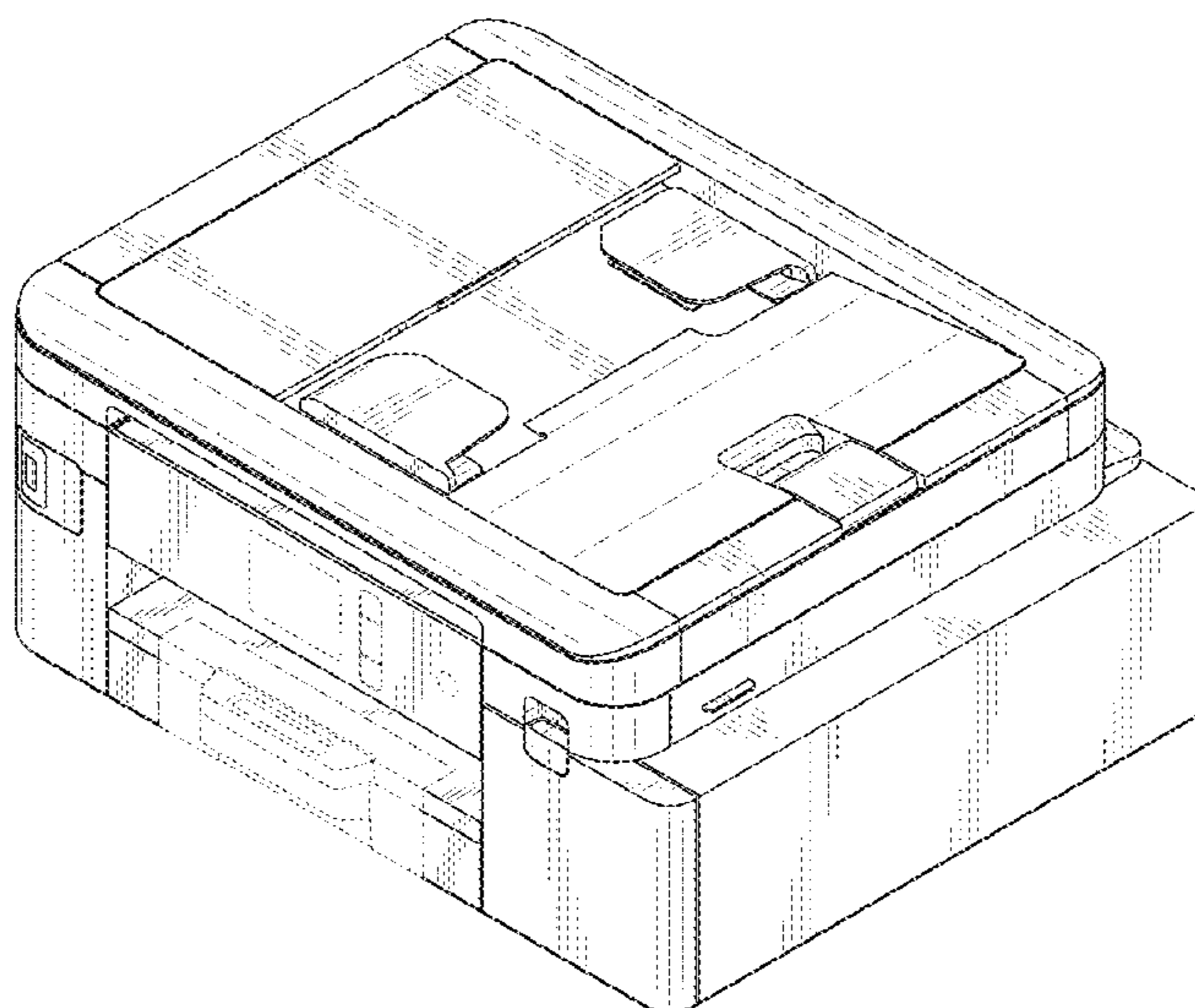

(56)

References Cited

OTHER PUBLICATIONS

U.S. PATENT DOCUMENTS

D743,484 S	11/2015	Nanno et al.	
D752,138 S	3/2016	Seki et al.	
D752,139 S	3/2016	Seki et al.	
D758,483 S	6/2016	Seki et al.	
D806,790 S	1/2018	Sato	
D815,683 S	4/2018	Tanaka	
D827,021 S	8/2018	Asano et al.	
D896,884 S *	9/2020	Kim	D18/50
D914,084 S	3/2021	Takeuchi et al.	
D923,702 S	6/2021	Lim et al.	
D932,543 S	10/2021	Yamamoto et al.	
D942,536 S	2/2022	Odachi et al.	
D966,405 S *	10/2022	Inada	D18/53
D971,314 S *	11/2022	Asano	D18/50

FOREIGN PATENT DOCUMENTS

JP	D1634498	2/2022
JP	D1662193	2/2022
JP	D1675492	3/2022

Office Depot. Link: <https://www.officedepot.com/a/products/9324630/Brother-INKvestment-Tank-MFC-J4335DW-Wireless/>. Visited Mar. 8, 2024. Brother® INKvestment Tank MFC-J4335DW Wireless Inkjet All-In-One Color Printer (Year: 2024).*

Amazon. Link: <https://www.amazon.com/Brother-MFCJ6945DW-INKvestment-Wireless-Printing/dp/B07GD52JR4>, Brother Inkjet Printer, MFCJ6945DW , Sep. 4, 2018.

RTINGS.com. Link: <https://www.rtings.com/printer/reviews/epson/ecotank-et-15000>, Epson Eco Tank ET—15000 Printer Review, Sep. 22, 2020.

RTINGS.com. Link: <https://www.rtings.com/printer/reviews/best/by-usage/office>, The 5 Best Office Printers—Winter 2022, Jan. 25, 2022.

Amazon. Link: https://www.amazon.com/Brother-INKvestment-MFC-J4535DWC-Wireless-Printer/dp/B09F89DJQT/ref=sr_1_1?crid=2AWCZP9ZS6D0R&keywords=B09F89DJQT&qid=1646859657&s=electronics&sprefix=b09f89djqt%2Celectronics%2C52&sr=1-1, Sep. 2, 2021.

* cited by examiner

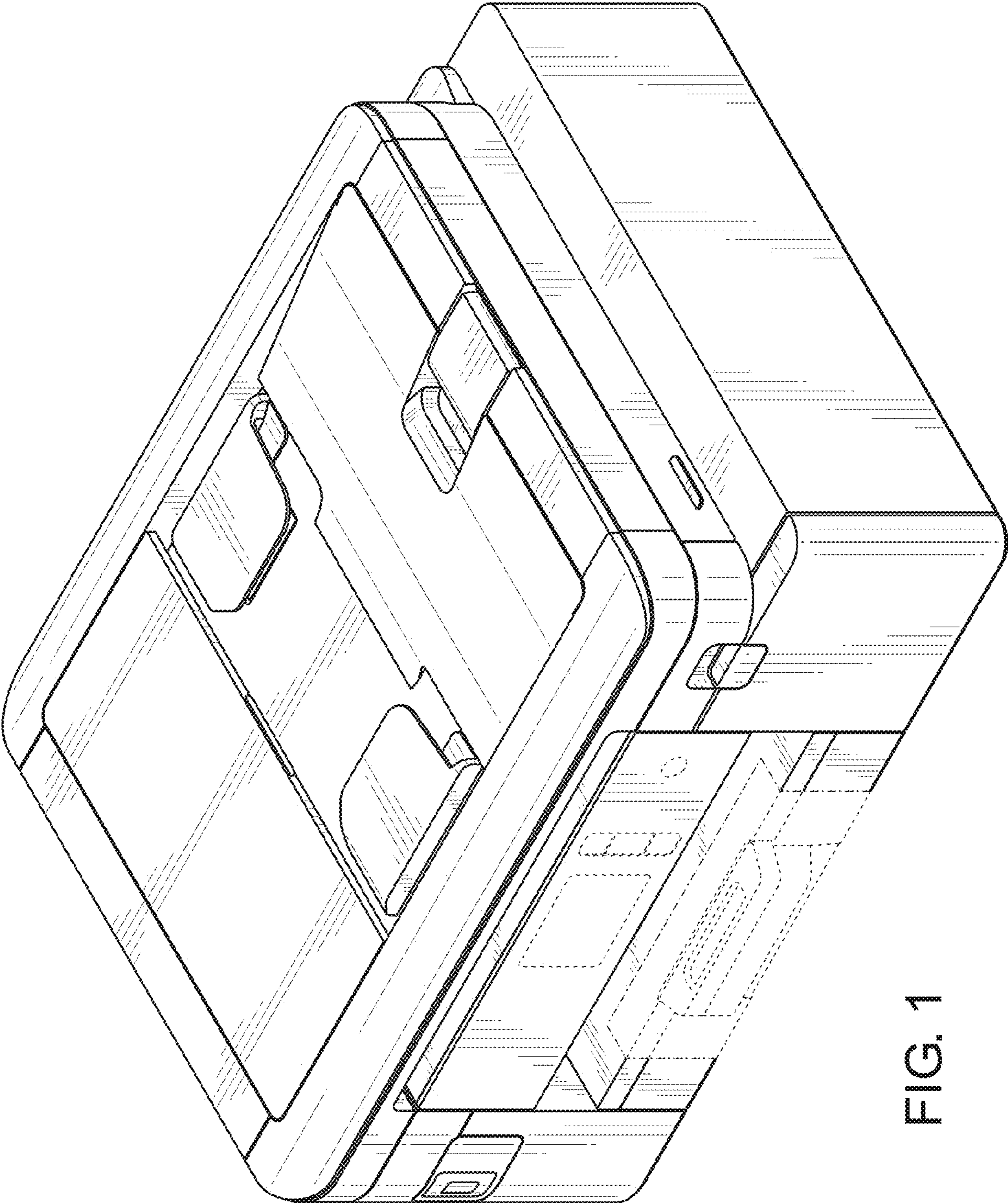

FIG. 1

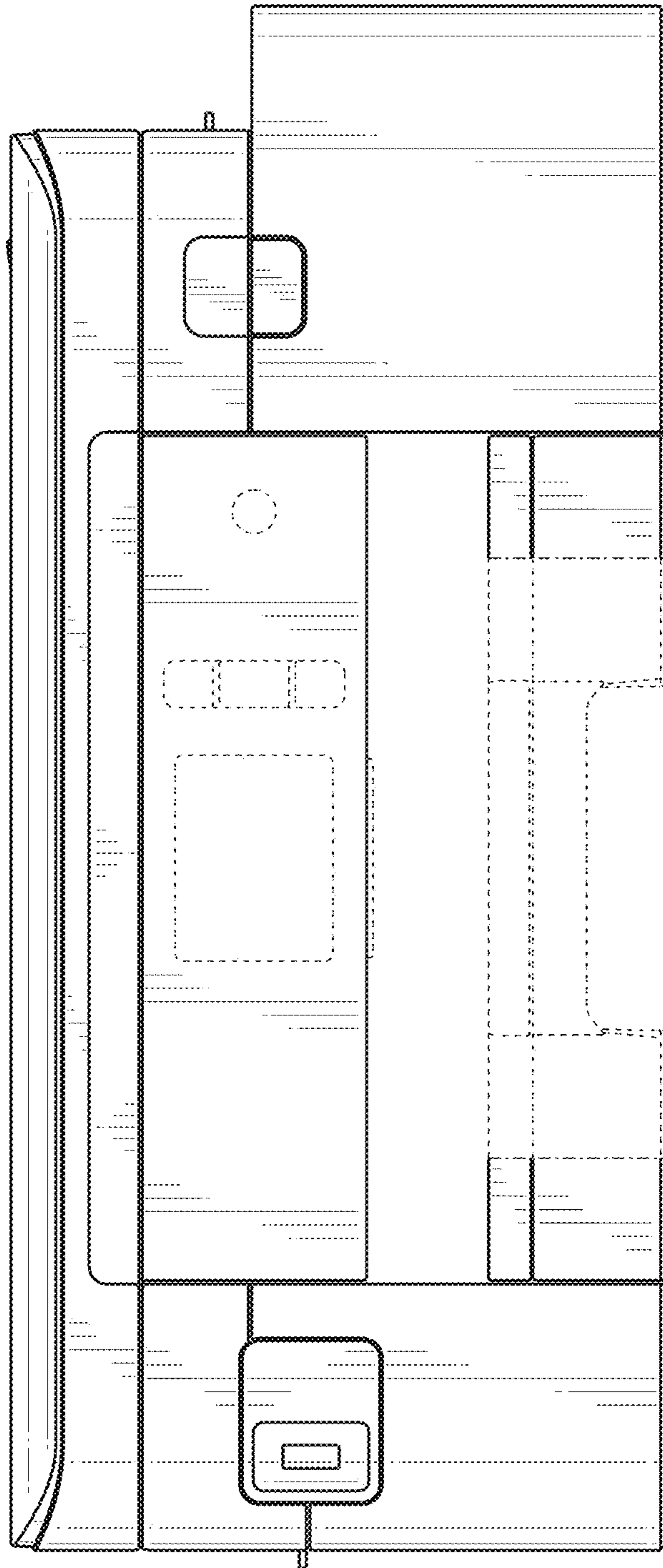

FIG. 2

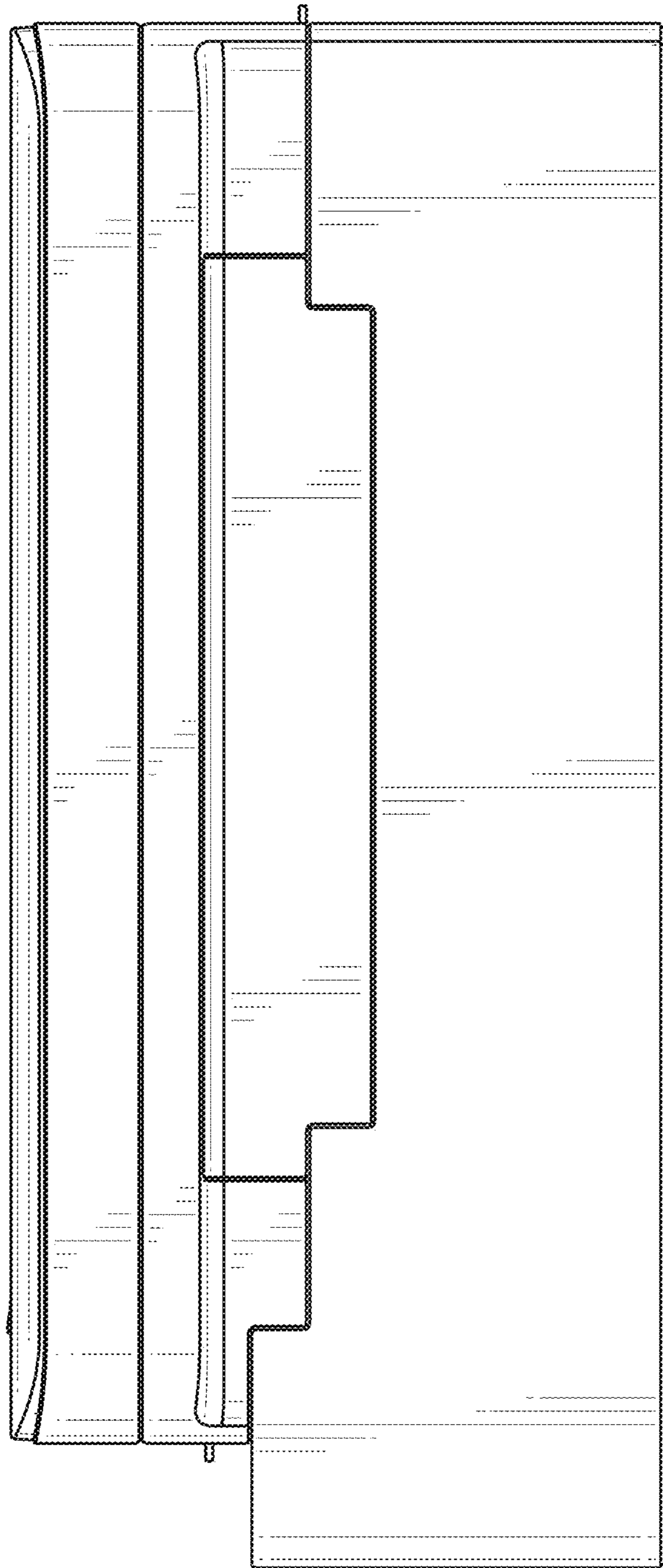

FIG. 3

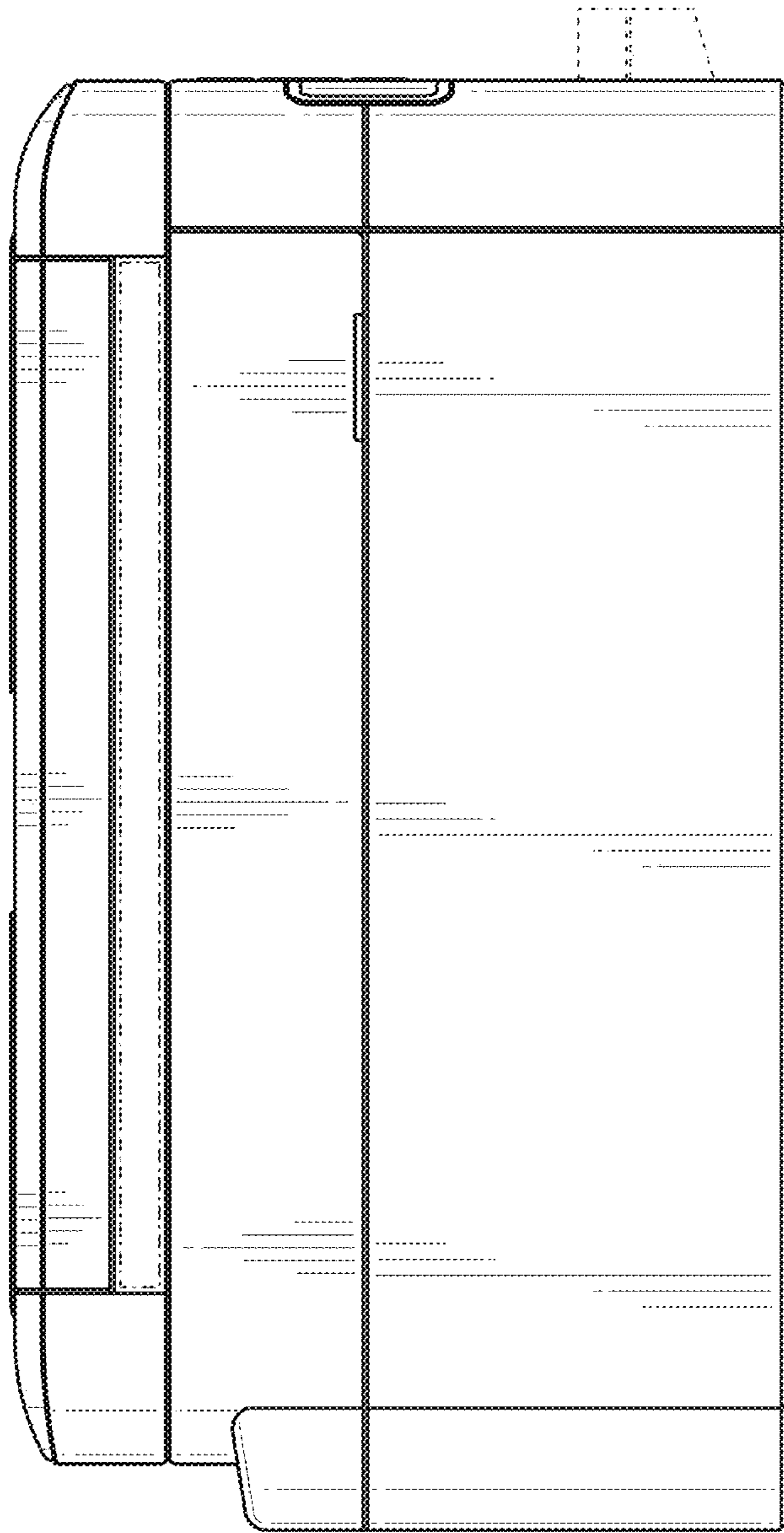

FIG. 4

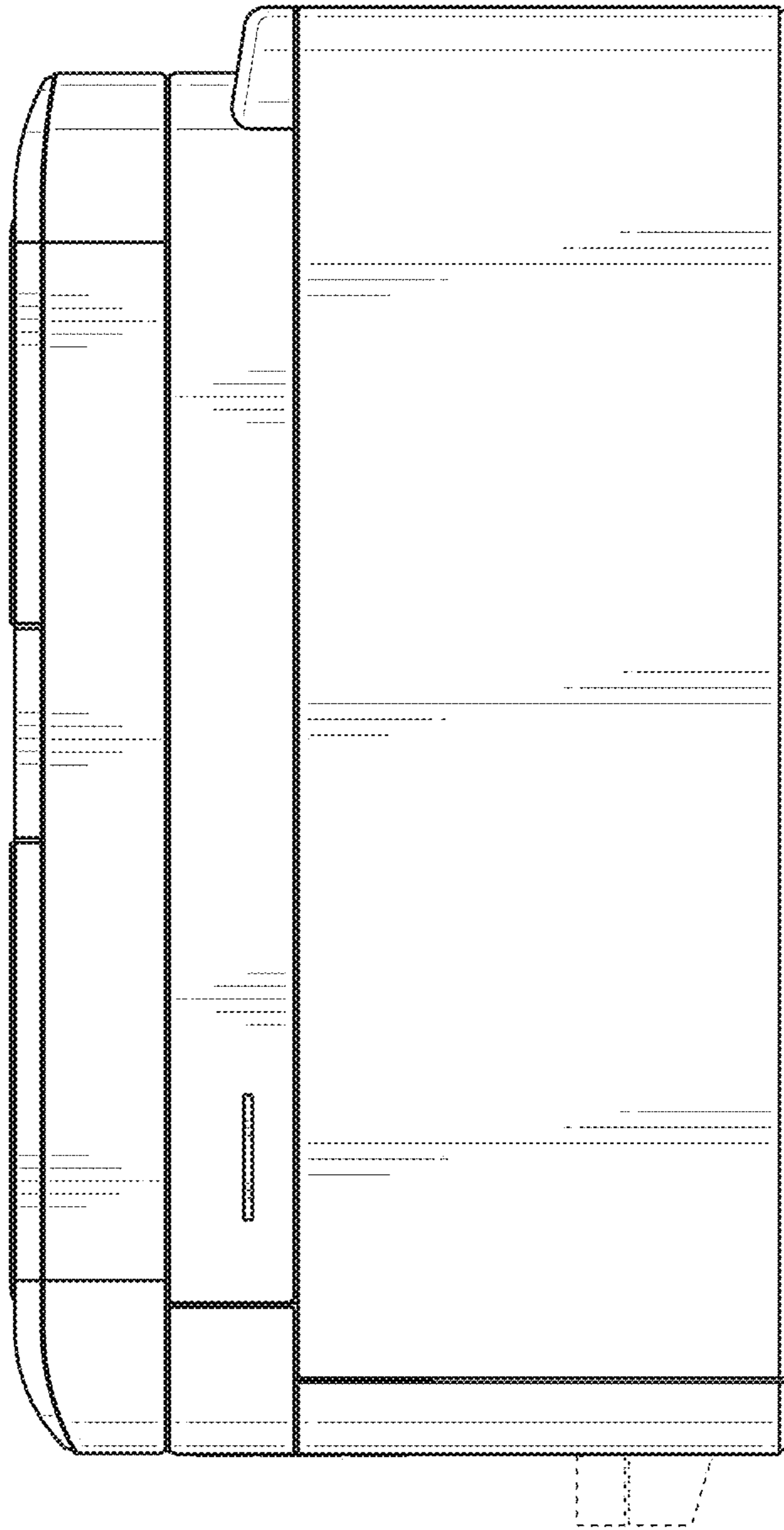

FIG. 5

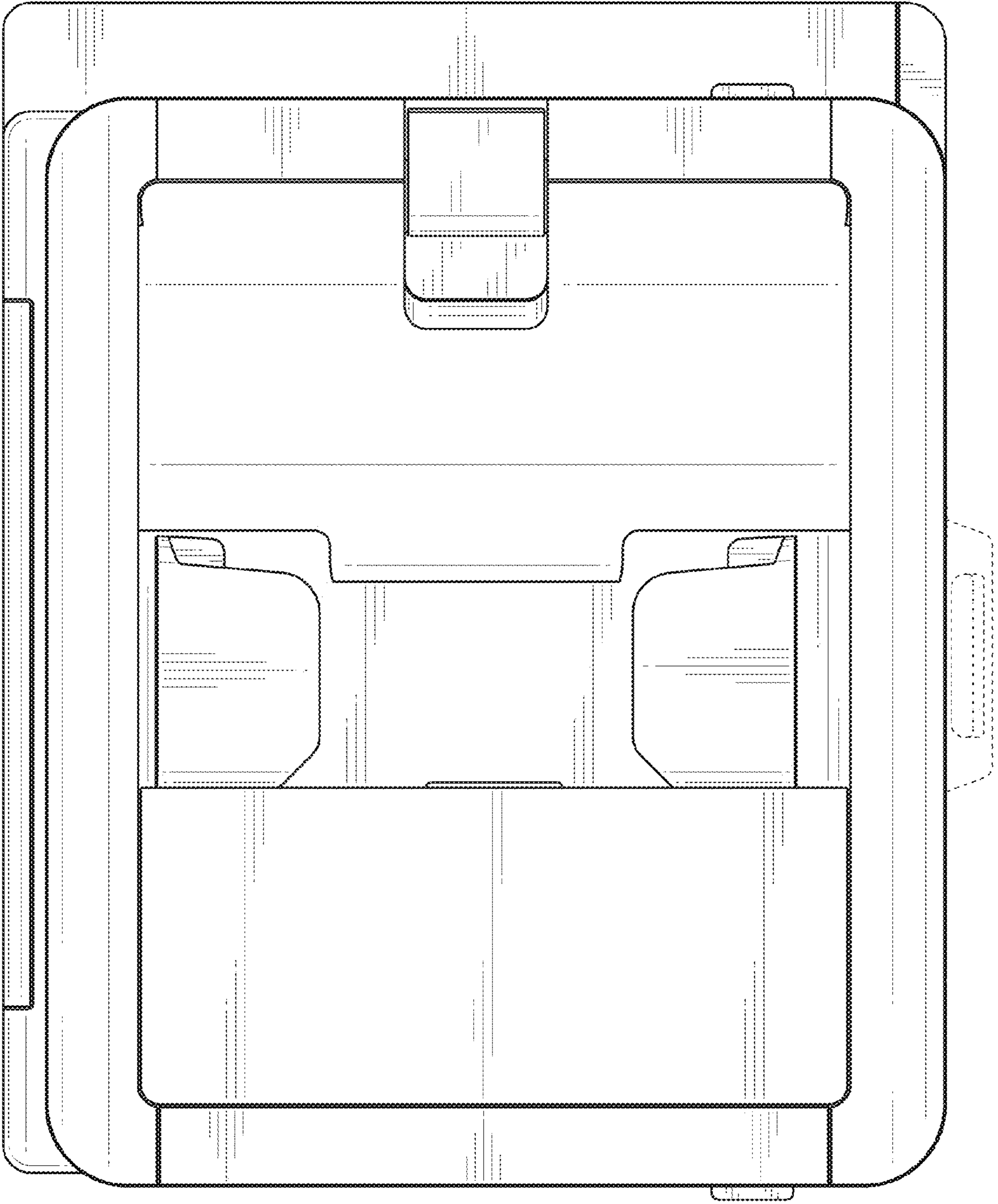

FIG. 6

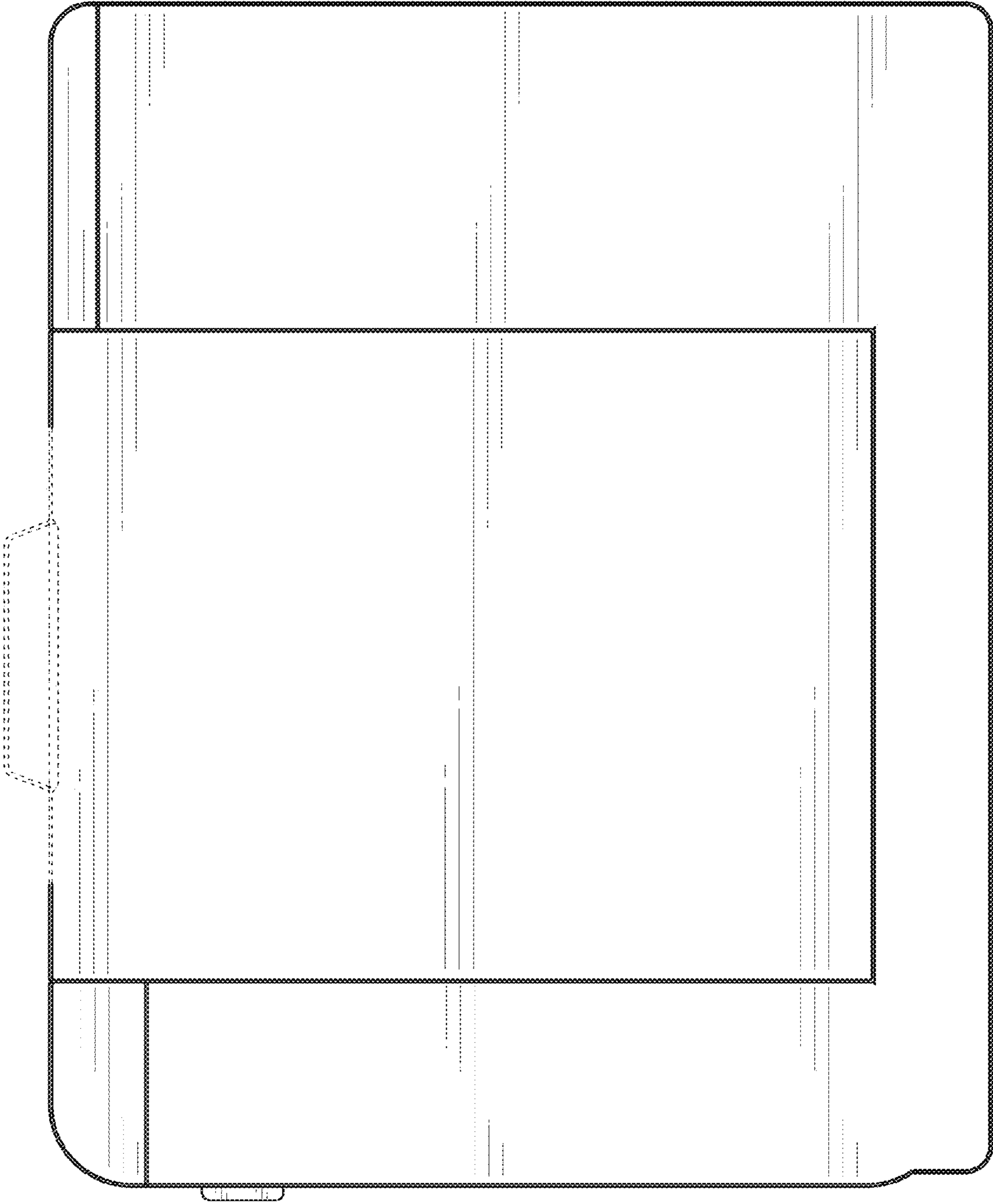

FIG. 7