



US0D1022374S

(12) **United States Design Patent** (10) **Patent No.:** **US D1,022,374 S**  
**Levy et al.** (45) **Date of Patent:** **\*\* Apr. 9, 2024**

(54) **SHOPPING CART COVER**

D1,003,560 S \* 10/2023 Tang ..... D34/27  
2002/0150714 A1 \* 10/2002 Digangi ..... B32B 27/12  
150/154

(71) Applicant: **Navajo Manufacturing Company, Inc.**, Denver, CO (US)

2006/0202438 A1 9/2006 Helmy et al.  
2011/0285098 A1 11/2011 Fragale

(72) Inventors: **Gordon Levy**, Golden, CO (US);  
**Shawn Shelton**, Highlands Ranch, CO (US)

2022/0340189 A1 \* 10/2022 Erickson ..... B62B 5/069

(73) Assignee: **Navajo Manufacturing Company, Inc.**, Denver, CO (US)

**OTHER PUBLICATIONS**

Bobby compact shopping cart cover, site visited Nov. 8, 2023,  
<https://www.amazon.com/Boppy-Antibacterial-Shopping-Playground-Integrated/dp/B09PZFQR66> (Year: 2023).\*

(\*\*) Term: **15 Years**

\* cited by examiner

(21) Appl. No.: **29/769,524**

*Primary Examiner* — Cynthia Ramirez

(22) Filed: **Feb. 5, 2021**

(74) *Attorney, Agent, or Firm* — Studebaker & Brackett PC

(51) **LOC (14) Cl.** ..... **12-02**

(52) **U.S. Cl.**  
USPC ..... **D34/27**

(57) **CLAIM**

(58) **Field of Classification Search**  
USPC ..... D34/27; D6/333  
CPC ..... B62B 3/1464; B62B 3/1436; B62B 5/069  
See application file for complete search history.

The ornamental design for a shopping cart cover, as shown and described.

**DESCRIPTION**

(56) **References Cited**

FIG. 1 is a front perspective view for a shopping cart cover showing our new design in condition of use;  
FIG. 2 is a rear perspective view thereof,  
FIG. 3 is a rear view thereof,  
FIG. 4 is a front view thereof,  
FIG. 5 is a top view thereof,  
FIG. 6 is a bottom view thereof,  
FIG. 7 is a right side view thereof,  
FIG. 8 is a left side view thereof; and,  
FIG. 9 is a top unassembled view thereof, the opposite bottom view being identical.  
The broken lines in FIG. 1 show environment and form no part of the claimed design.  
The dashed lines in FIG. 9 of the drawings depict perforation of the shopping cart cover that form part of the claimed design.

**U.S. PATENT DOCUMENTS**

- D308,614 S \* 6/1990 Gordon ..... D6/611
- D357,784 S \* 4/1995 Ince ..... B62B 5/069  
D34/27
- D368,566 S \* 4/1996 Glaeser ..... D34/27
- 5,722,672 A \* 3/1998 Frederick
- D416,368 S \* 11/1999 Brewer ..... D34/27
- 6,491,996 B2 \* 12/2002 Digangi ..... B62B 3/144  
297/229
- D492,830 S \* 7/2004 Rogers ..... D34/27
- 6,869,085 B2 3/2005 Pettigrew et al.
- D505,754 S \* 5/2005 Cohen-Fyffe ..... D30/118
- D633,683 S \* 3/2011 Parness ..... D34/27
- 8,109,524 B1 \* 2/2012 Toohey ..... B62B 5/069  
297/256.17
- D911,251 S \* 2/2021 Wheeler ..... D12/401
- 11,242,079 B1 \* 2/2022 Chehebar ..... B62B 5/069
- D945,108 S \* 3/2022 Walker ..... D34/27

**1 Claim, 6 Drawing Sheets**

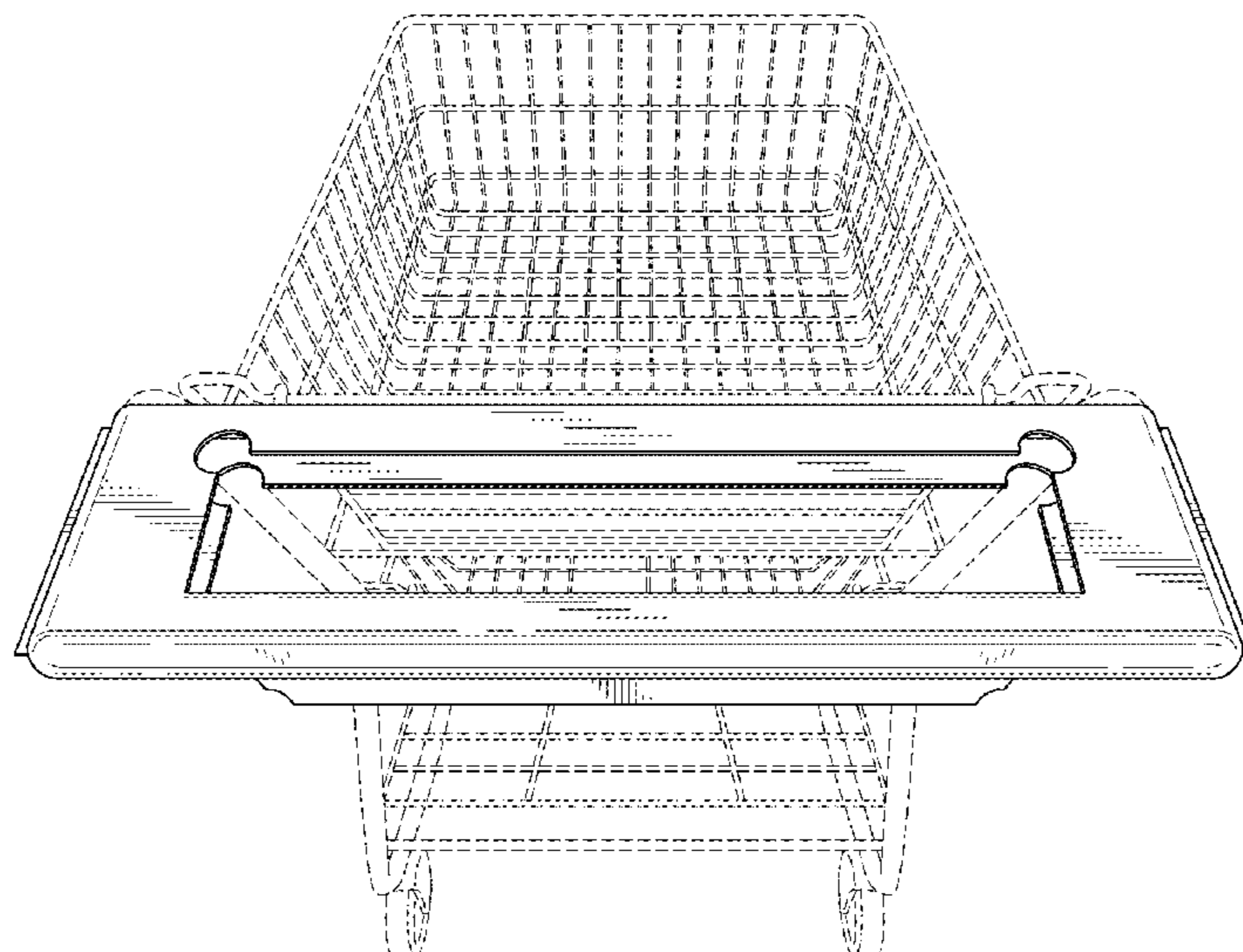

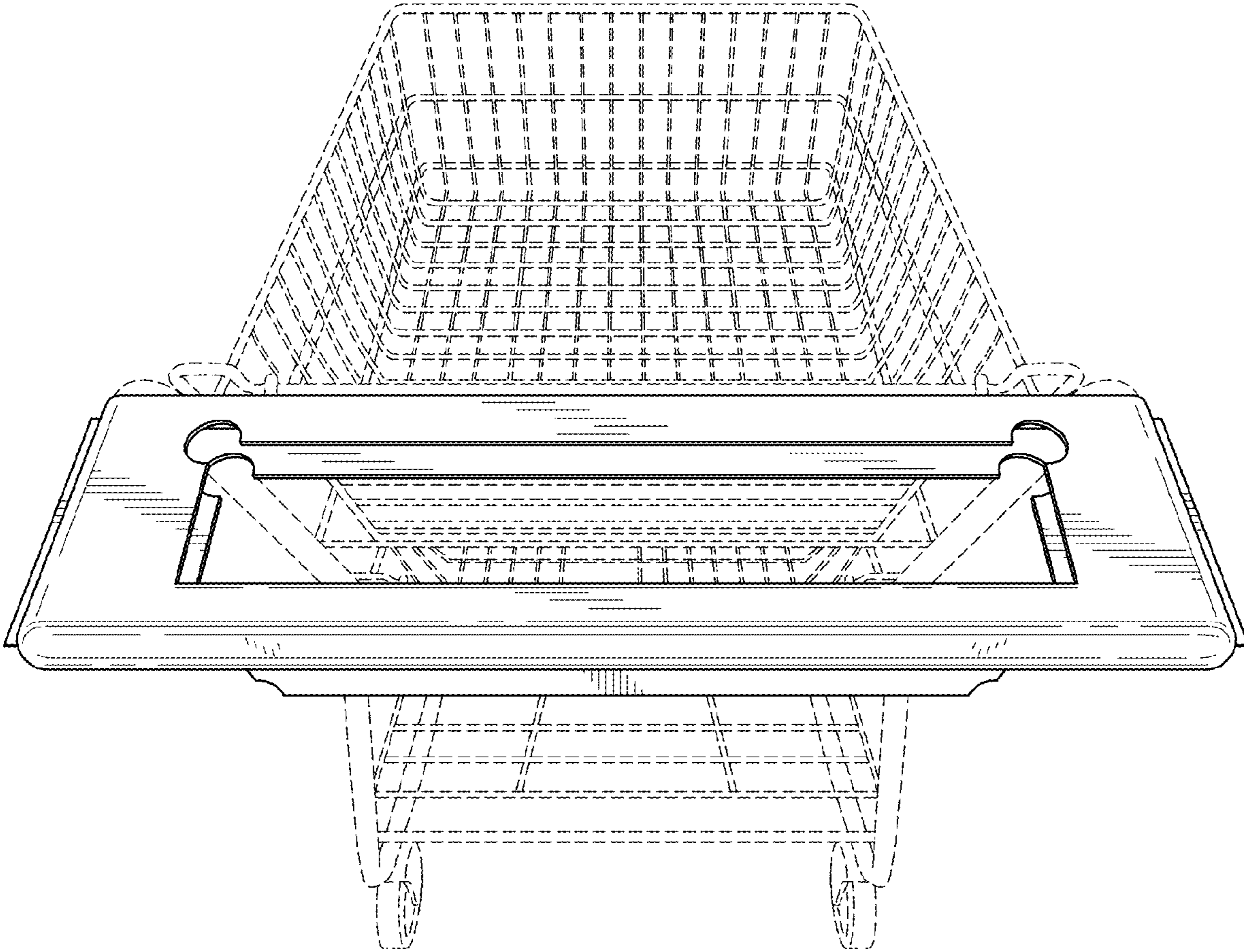

FIG. 1

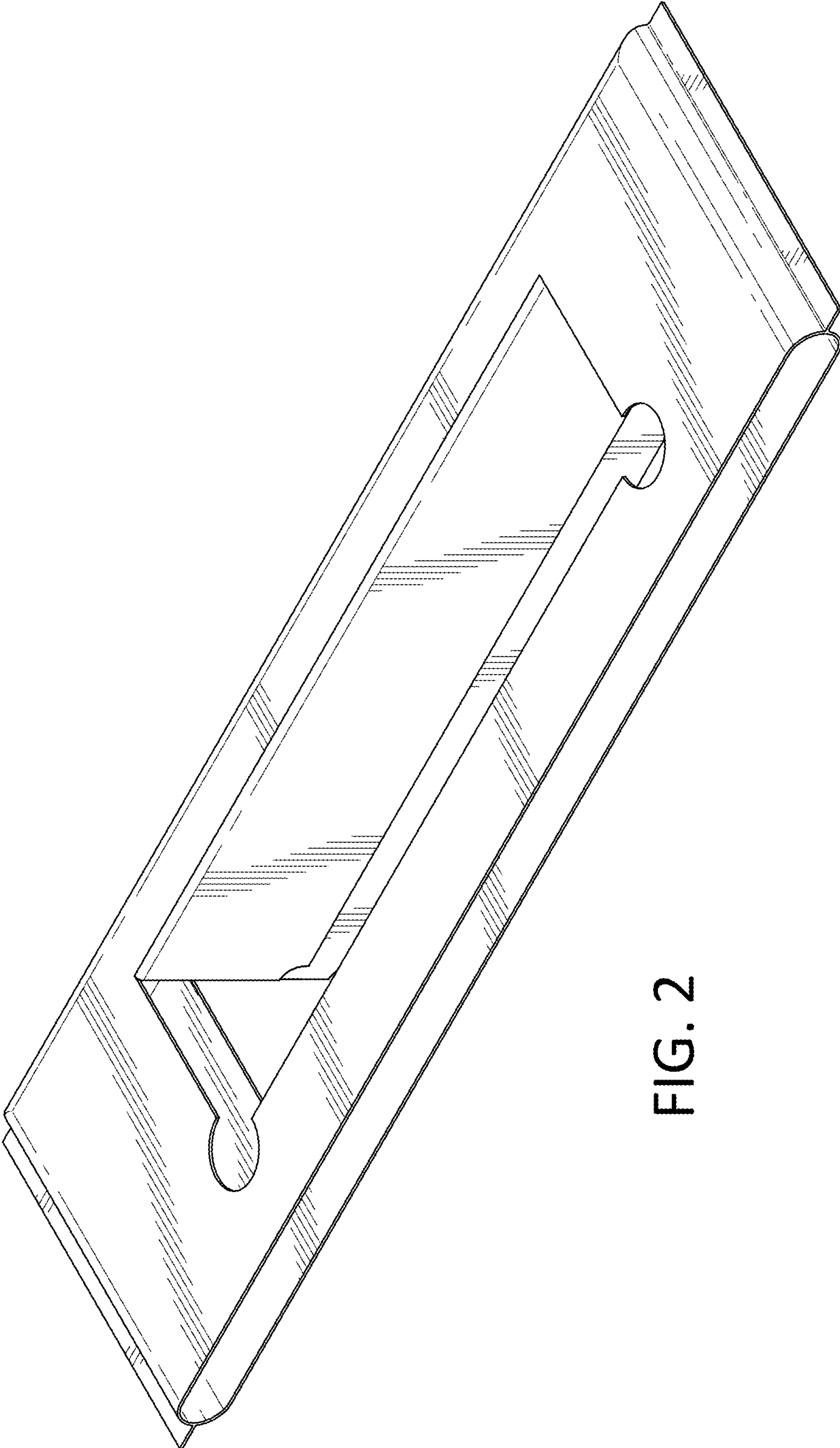

FIG. 2

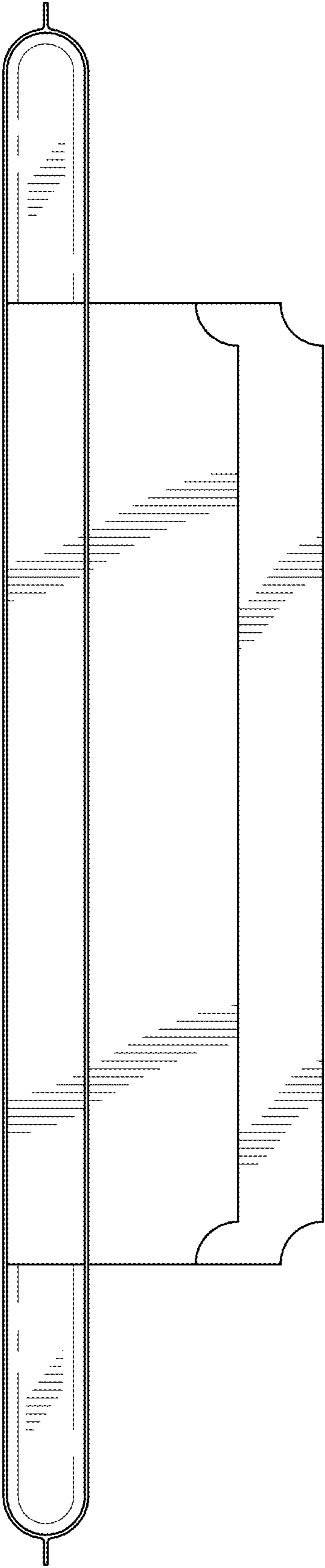

FIG. 3

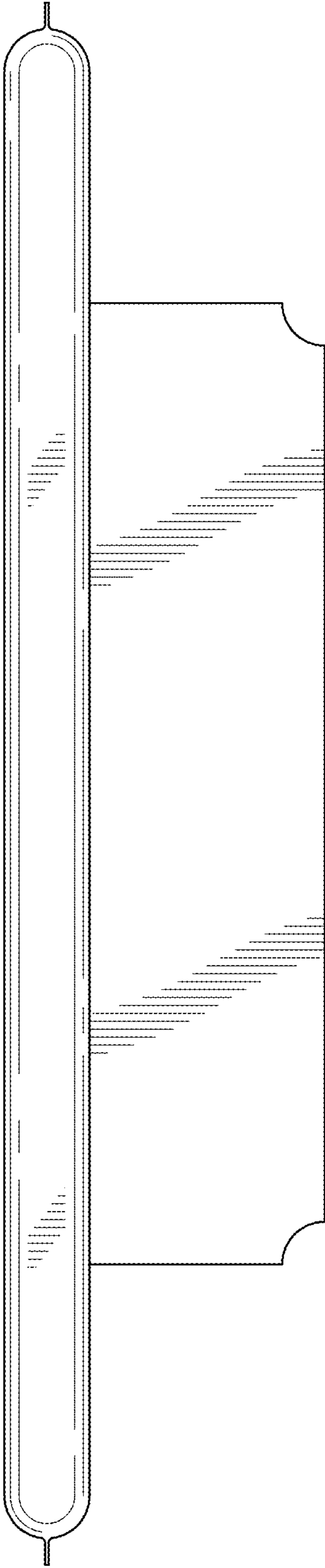

FIG. 4

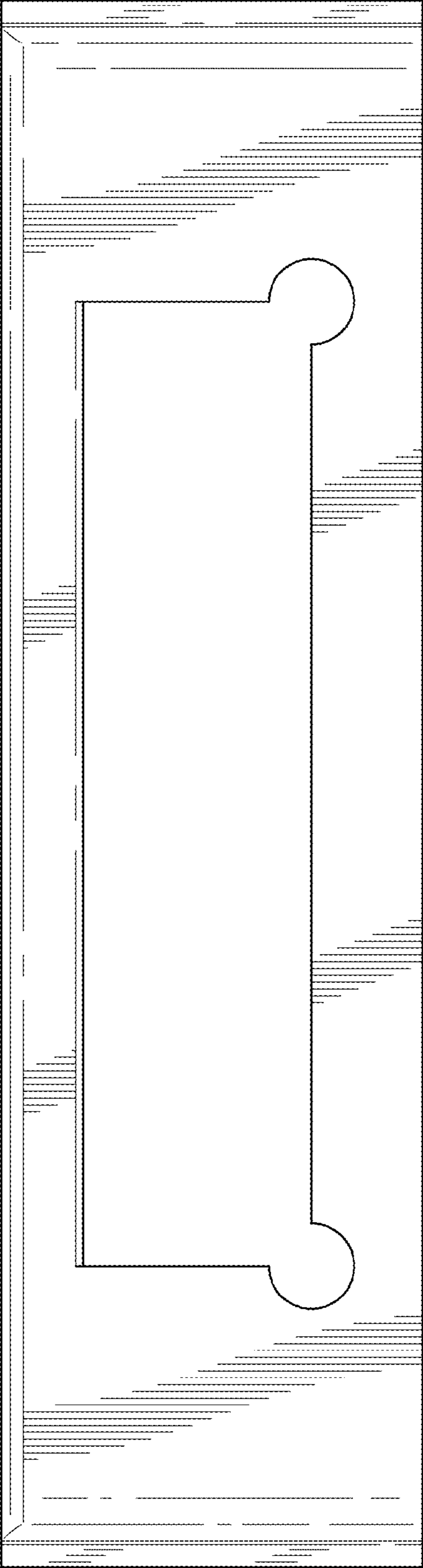

FIG. 5

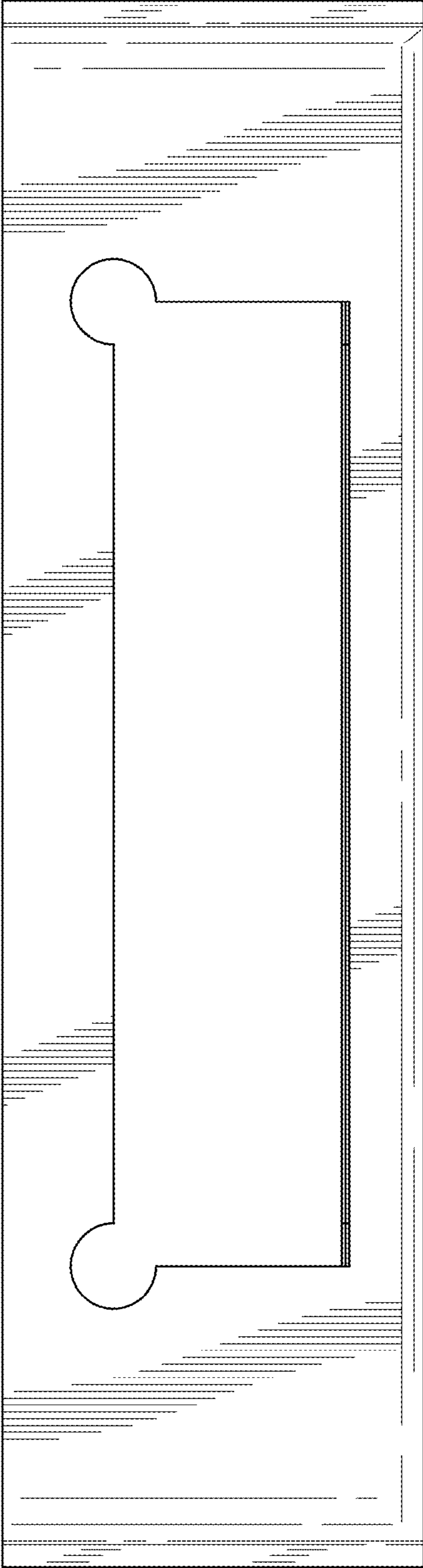

FIG. 6

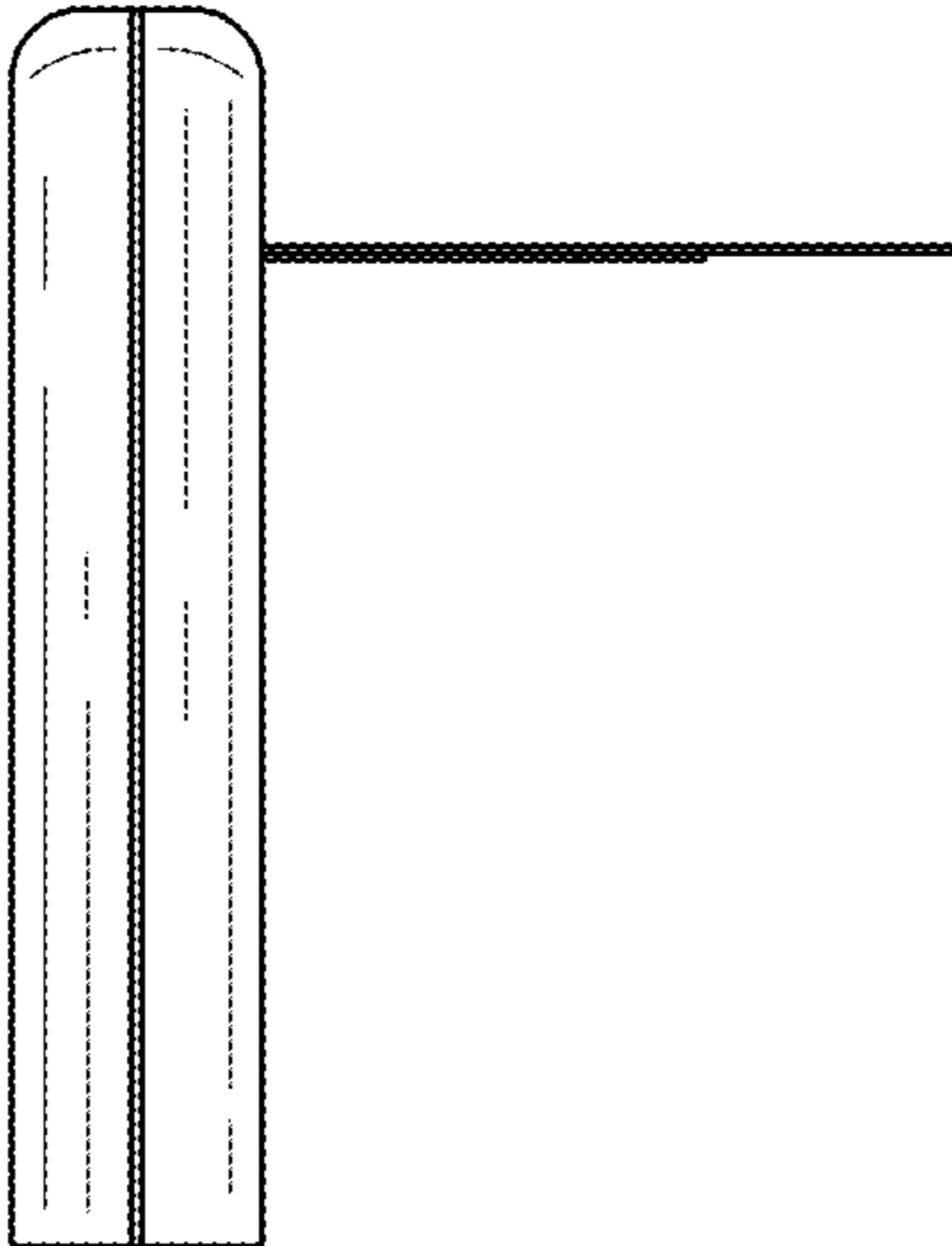

FIG. 8

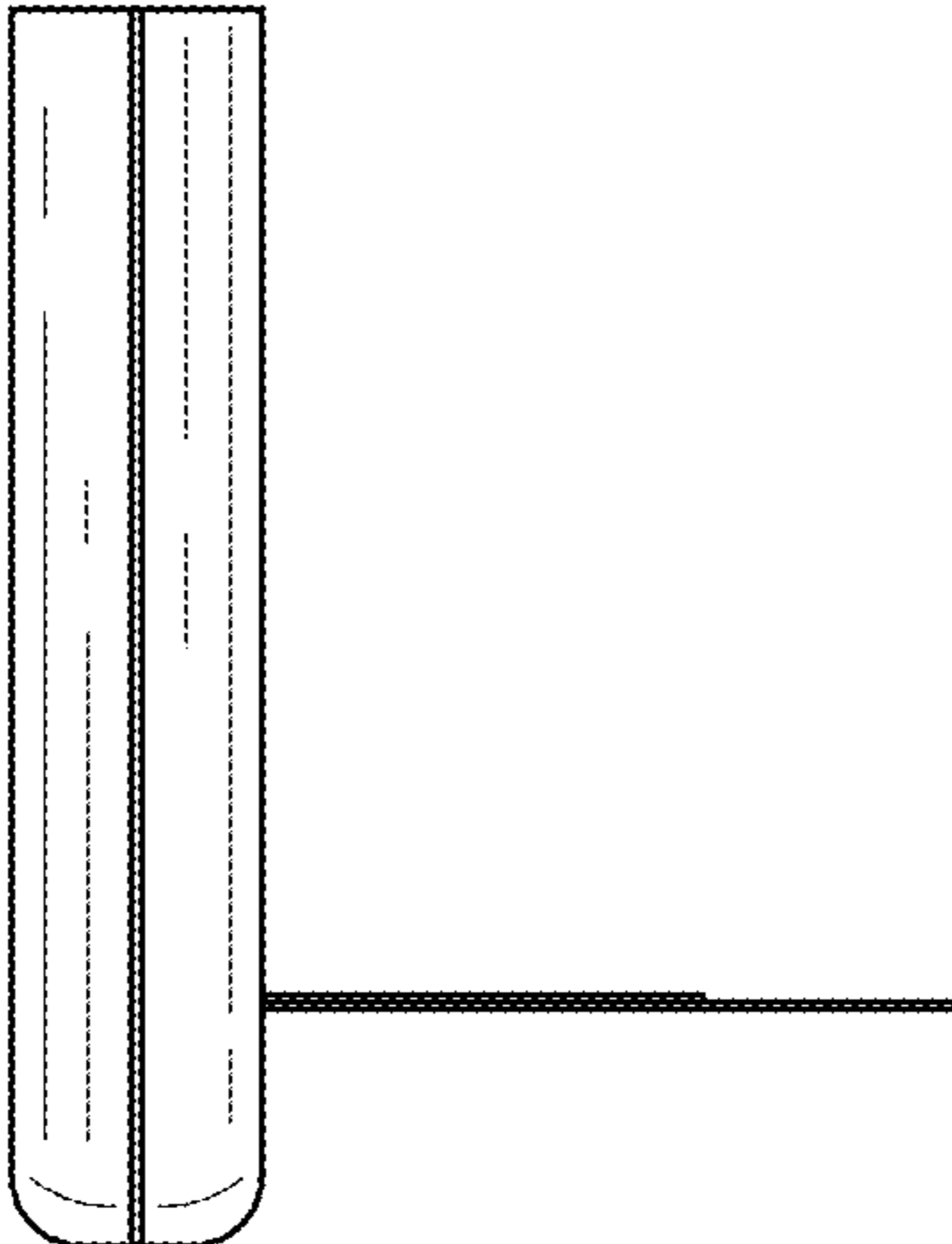

FIG. 7

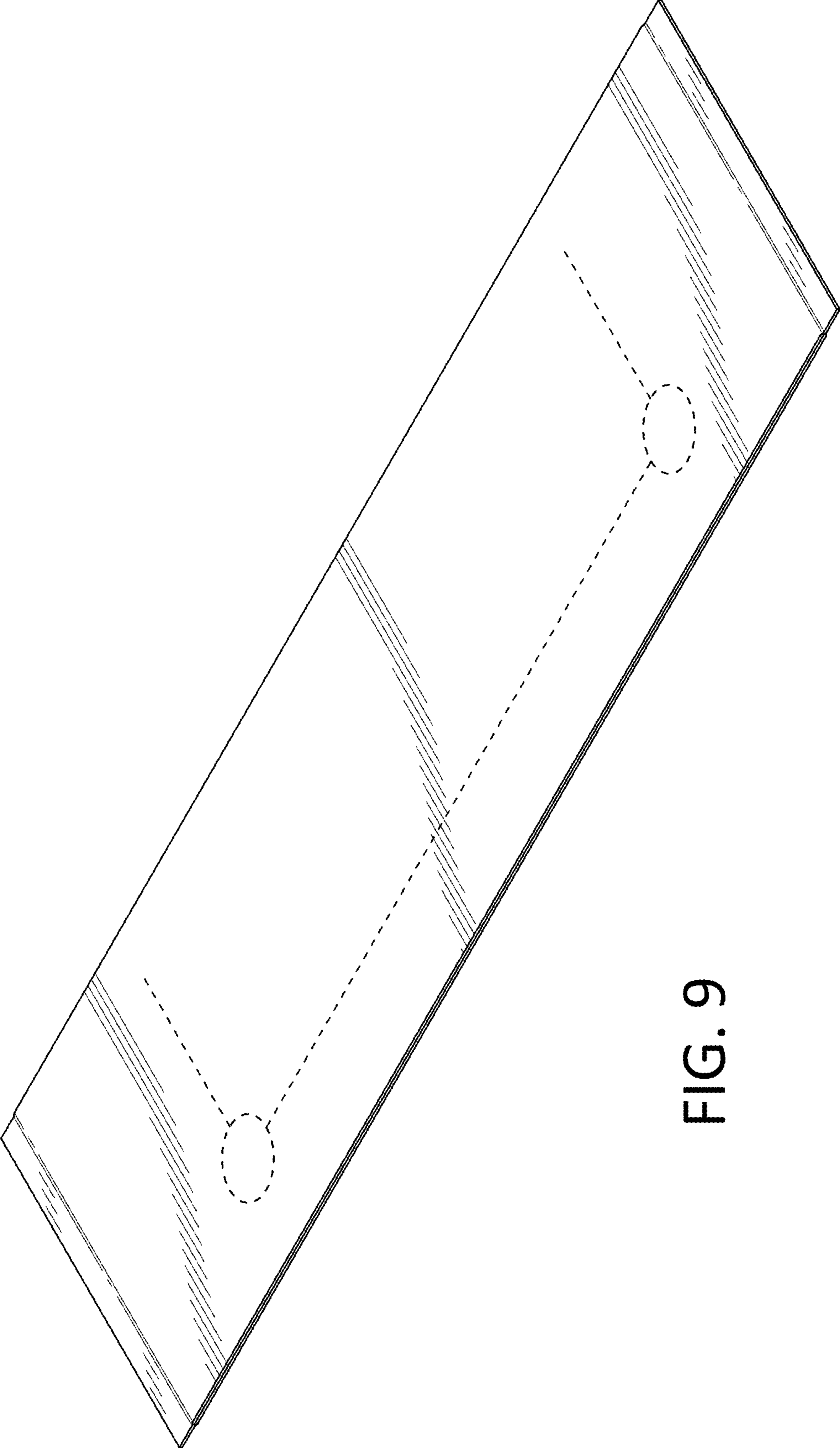

FIG. 9