



US0D1020943S

(12) **United States Design Patent** (10) **Patent No.:** **US D1,020,943 S**
Xu (45) **Date of Patent:** **** Apr. 2, 2024**

(54) **GOLF TEE**

(71) Applicant: **Jian Xu**, Great Neck, NY (US)

(72) Inventor: **Jian Xu**, Great Neck, NY (US)

(**) Term: **15 Years**

(21) Appl. No.: **29/840,415**

(22) Filed: **May 27, 2022**

(51) **LOC (14) Cl.** **21-02**

(52) **U.S. Cl.**
USPC **D21/717**

(58) **Field of Classification Search**
USPC D21/789, 791, 793, 796, 698, 715-718,
D21/795, 499, 398
CPC . A63B 57/0012; A63B 57/0037; A63B 57/10;
A63B 57/12; A63B 57/13; A63B 57/15;
A63B 57/18; A63B 57/19; A63B 57/16;
A63B 69/0075

See application file for complete search history.

(56) **References Cited**

U.S. PATENT DOCUMENTS

478,377 A	7/1892	Smith	
2,079,387 A	5/1937	Sickmiller	
4,162,071 A	7/1979	Fish et al.	
D368,503 S *	4/1996	Bess	D21/717
D376,830 S *	12/1996	Bess	D21/717
D382,928 S *	8/1997	Bess	D21/717
9,302,163 B1	4/2016	Maldonado	
D836,165 S *	12/2018	Peng	D21/499
D848,541 S *	5/2019	Peng	D21/499

D865,078 S *	10/2019	Peng	D21/499
D921,127 S *	6/2021	Kendall	D21/499
2007/0262522 A1	11/2007	Lu	

FOREIGN PATENT DOCUMENTS

CN 215427247 U 1/2022

* cited by examiner

Primary Examiner — W. A. Teddy Falloway

Assistant Examiner — Yuan Yuan

(57) **CLAIM**

The ornamental design for a golf tee, as shown and described.

DESCRIPTION

FIG. 1 is a top-front perspective view of a golf tee showing my new design;
 FIG. 2 is a bottom perspective view thereof;
 FIG. 3 is a front side view thereof;
 FIG. 4 is a back side view thereof;
 FIG. 5 is a right side view thereof;
 FIG. 6 is a left side view thereof;
 FIG. 7 is a top plan view thereof;
 FIG. 8 is a bottom plan view thereof;
 FIG. 9 is a perspective view of the golf tee, shown without unclaimed subject matter;
 FIG. 10 is a right side view thereof; and,
 FIG. 11 is a left side view thereof.
 The broken lines in the drawings depict environment and form no part of the claimed design.

1 Claim, 11 Drawing Sheets

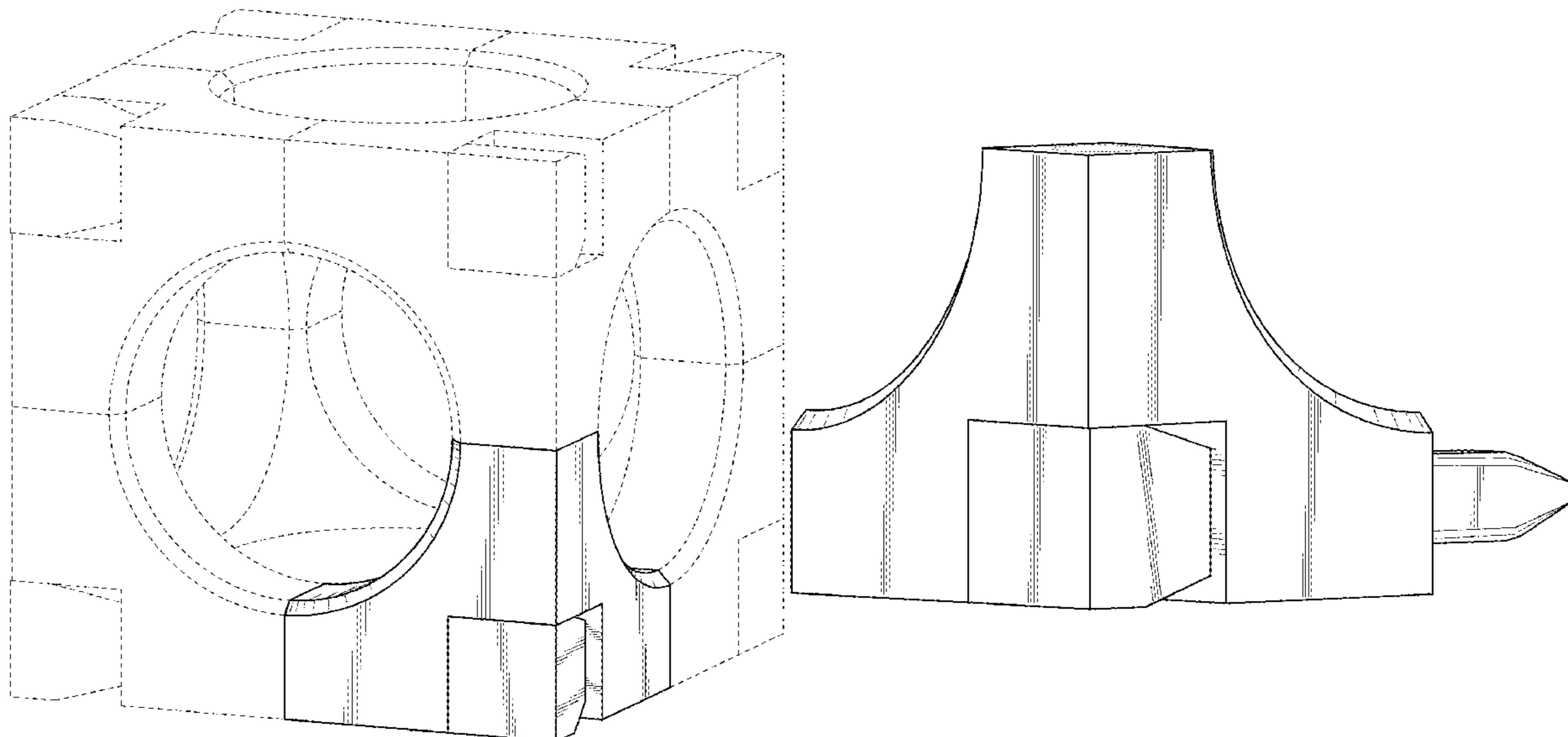

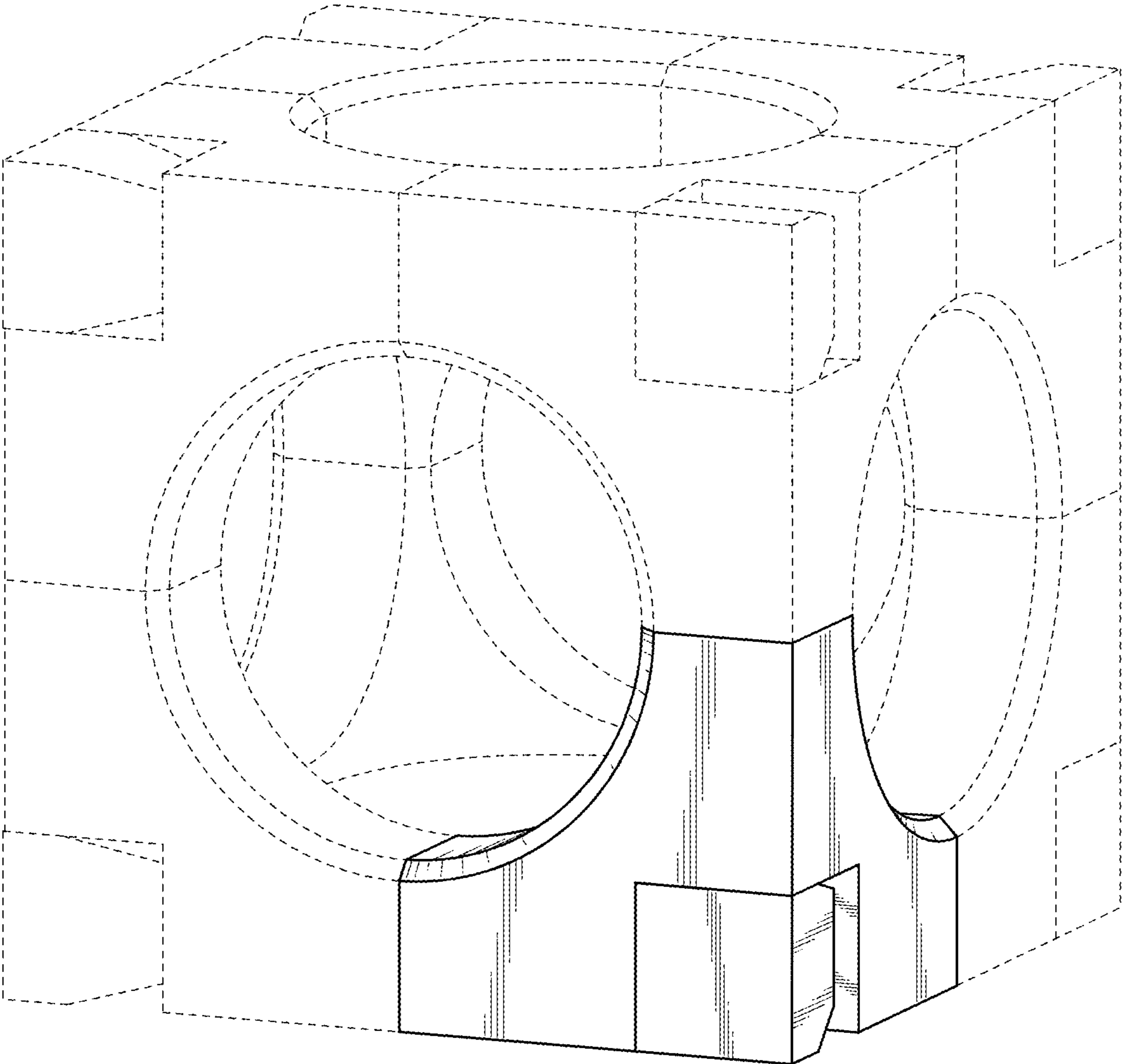

FIG. 1

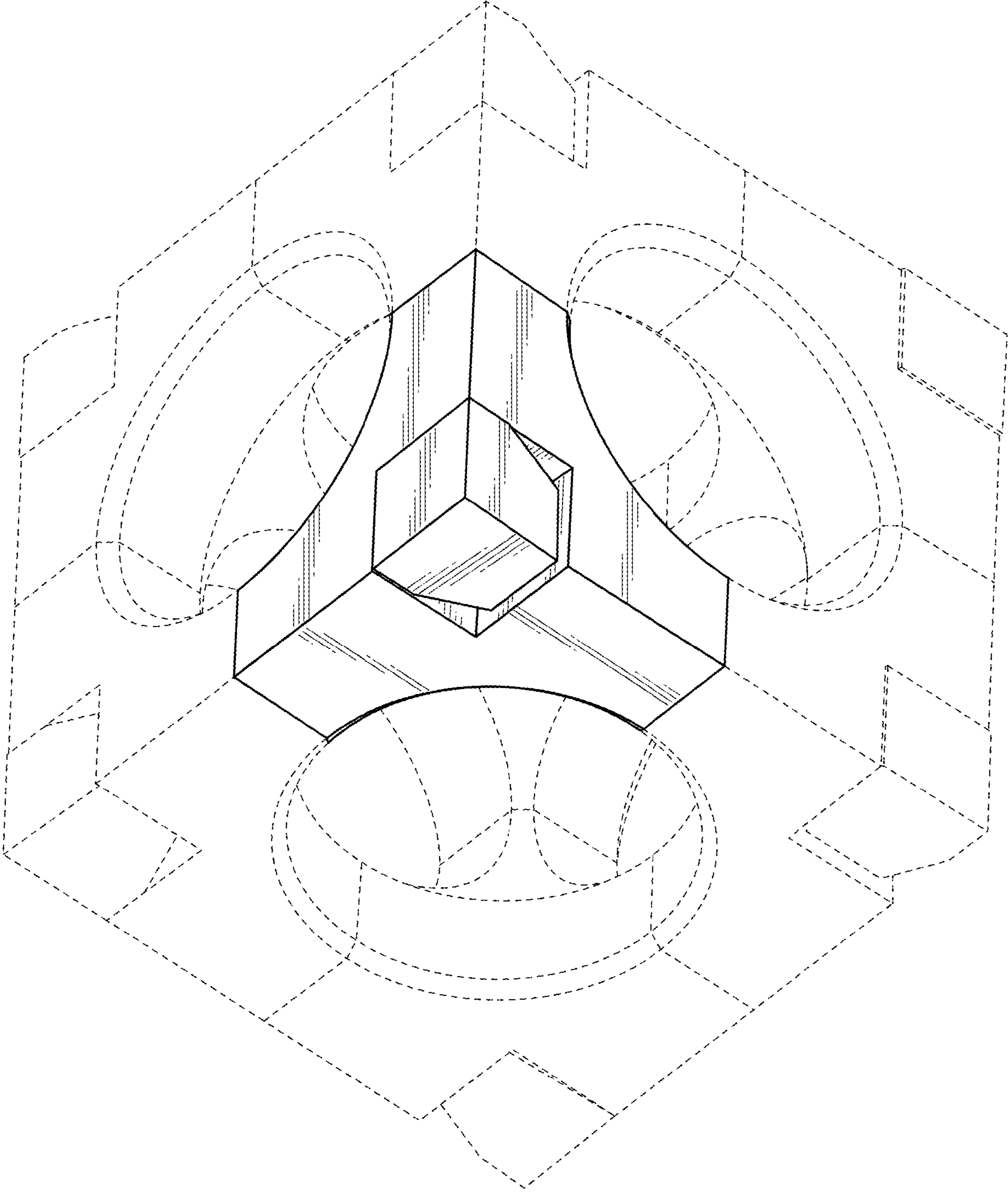

FIG. 2

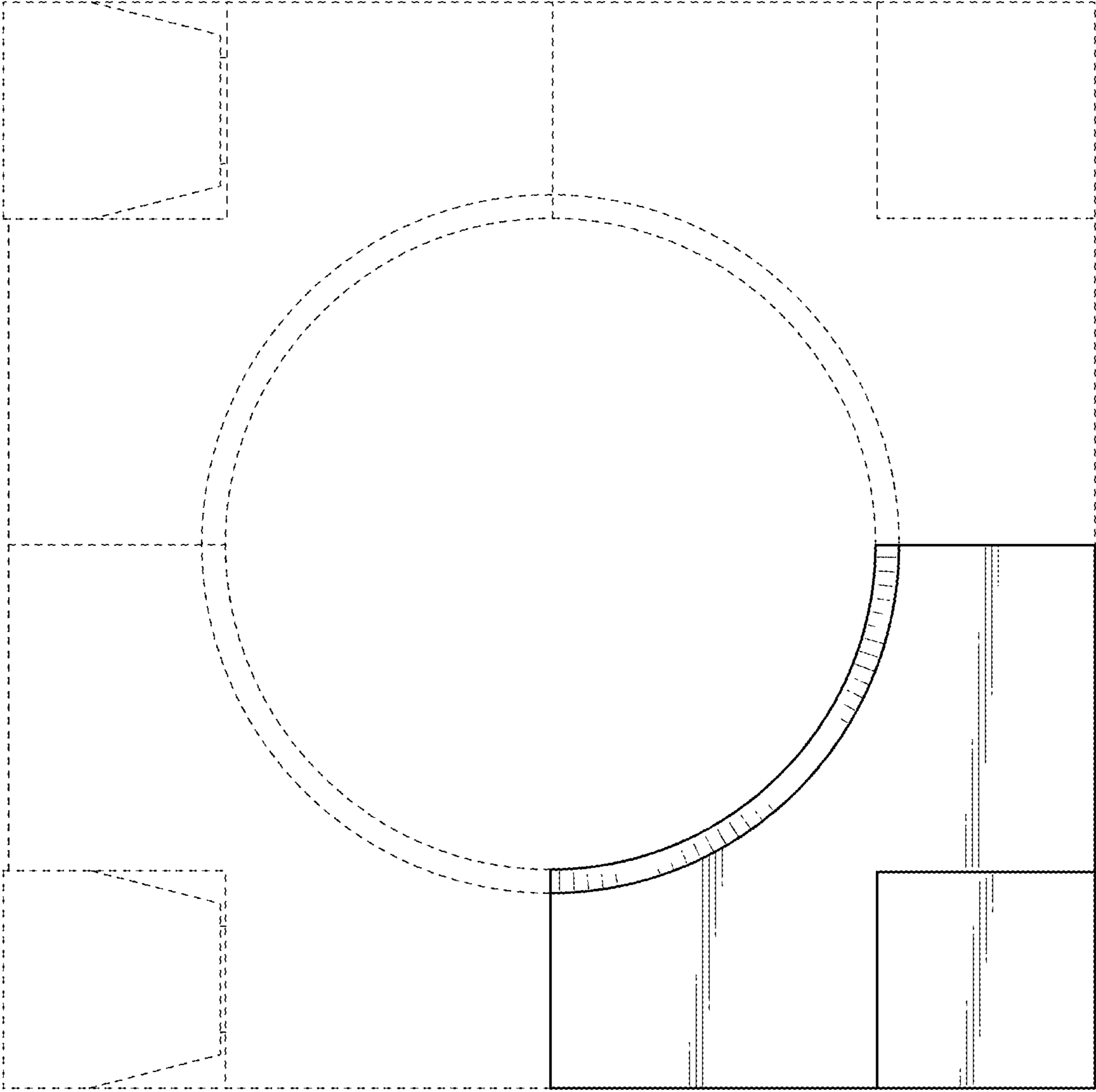

FIG. 3

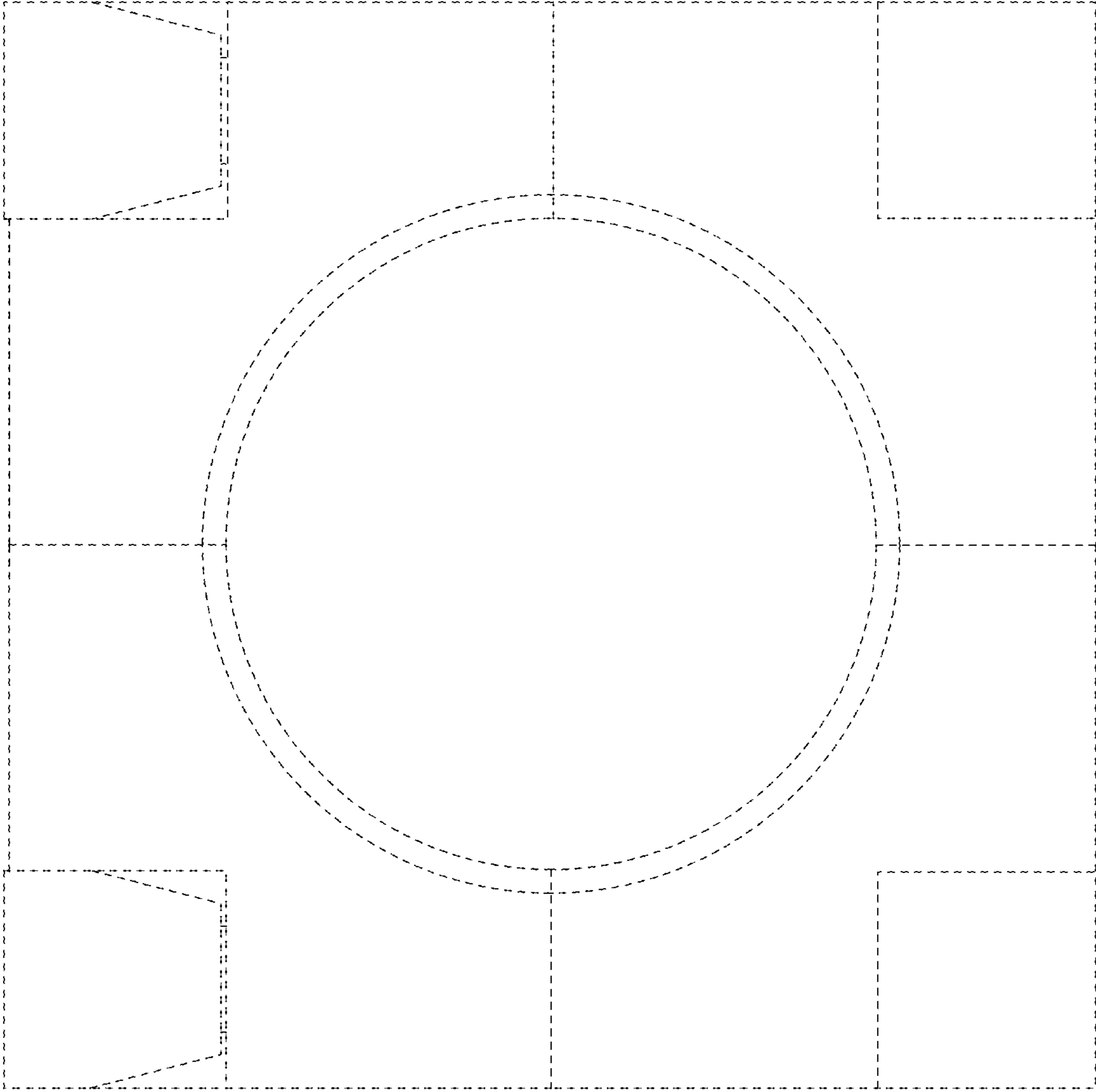

FIG. 4

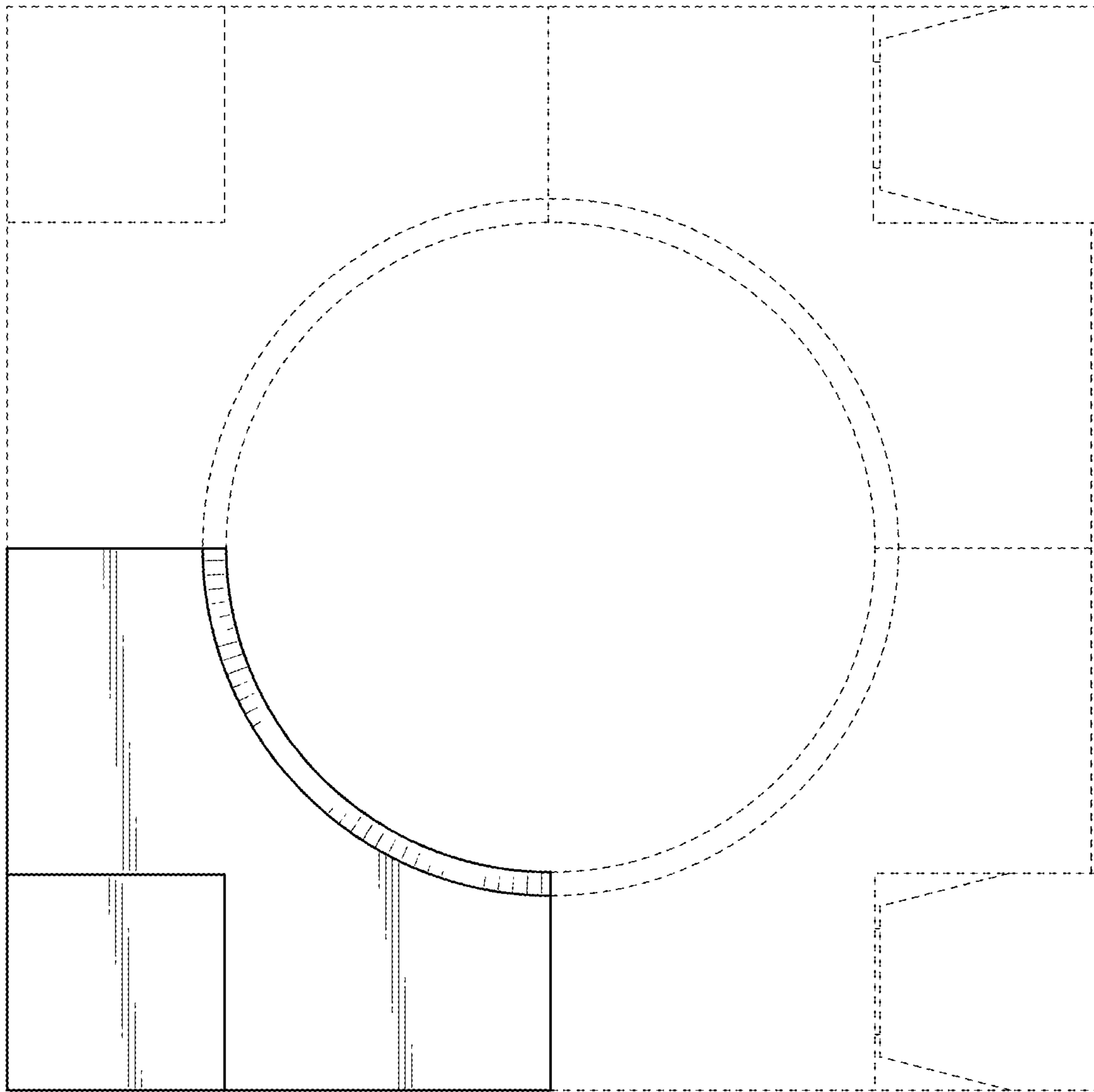

FIG. 5

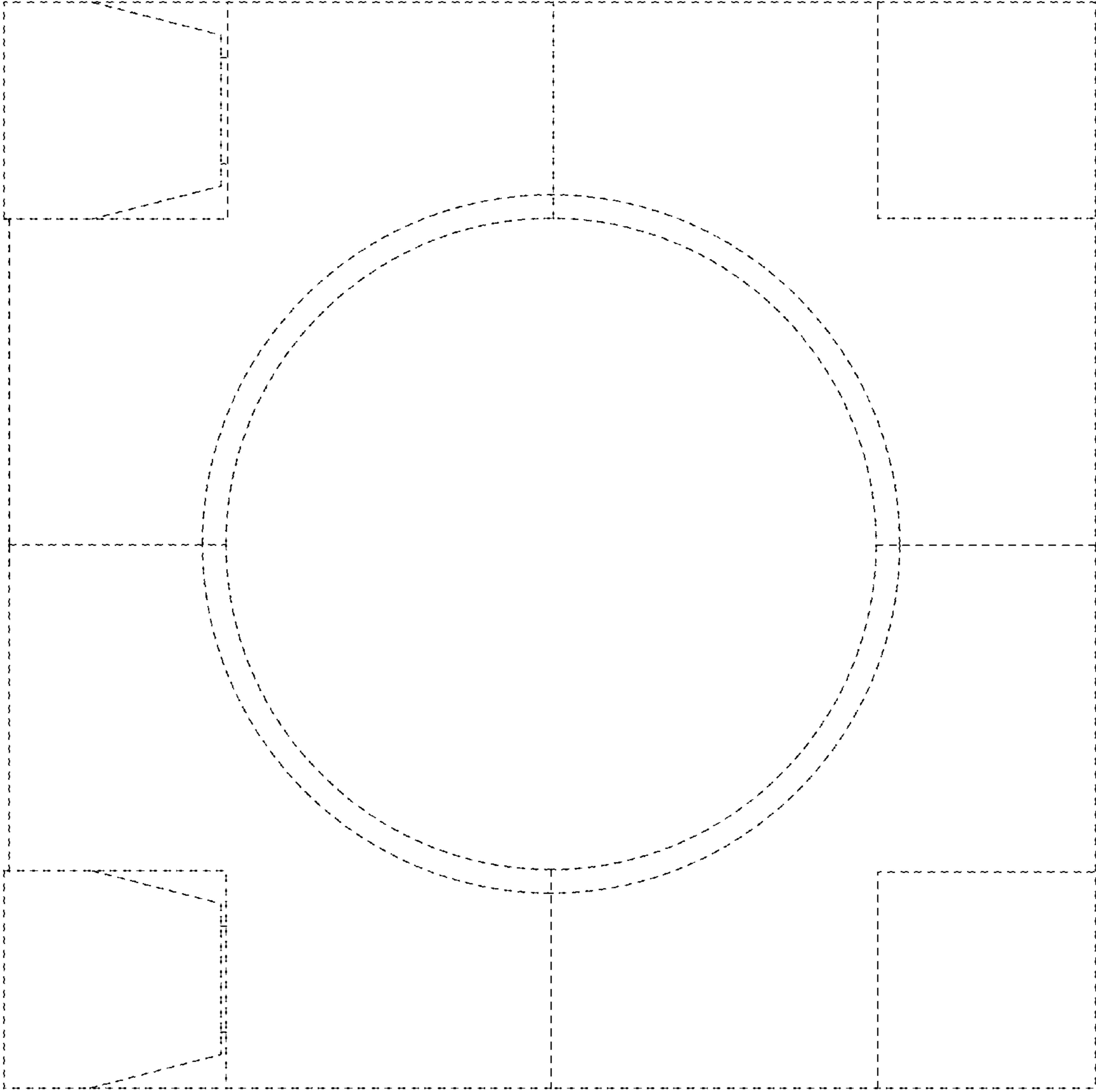

FIG. 6

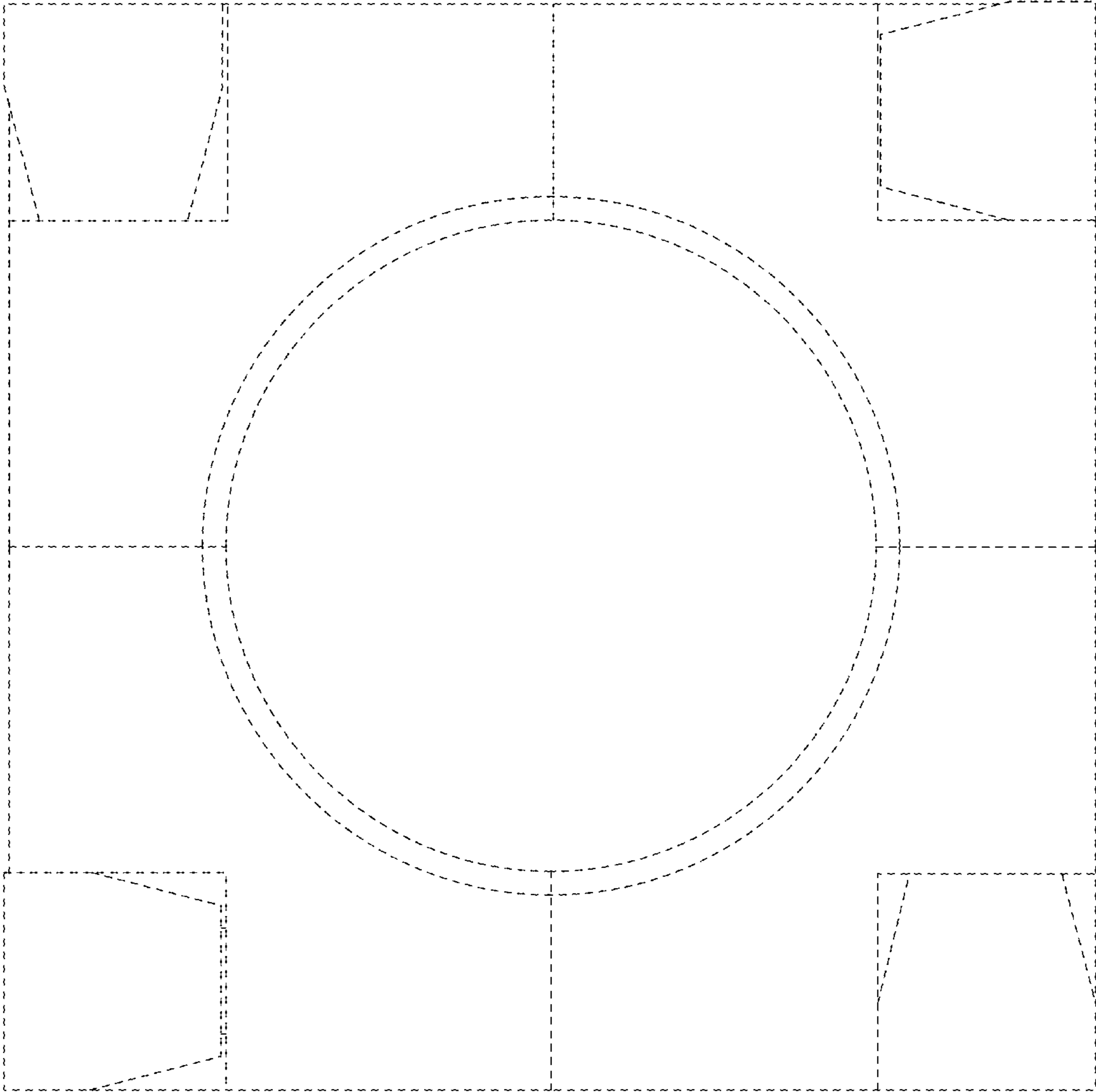

FIG. 7

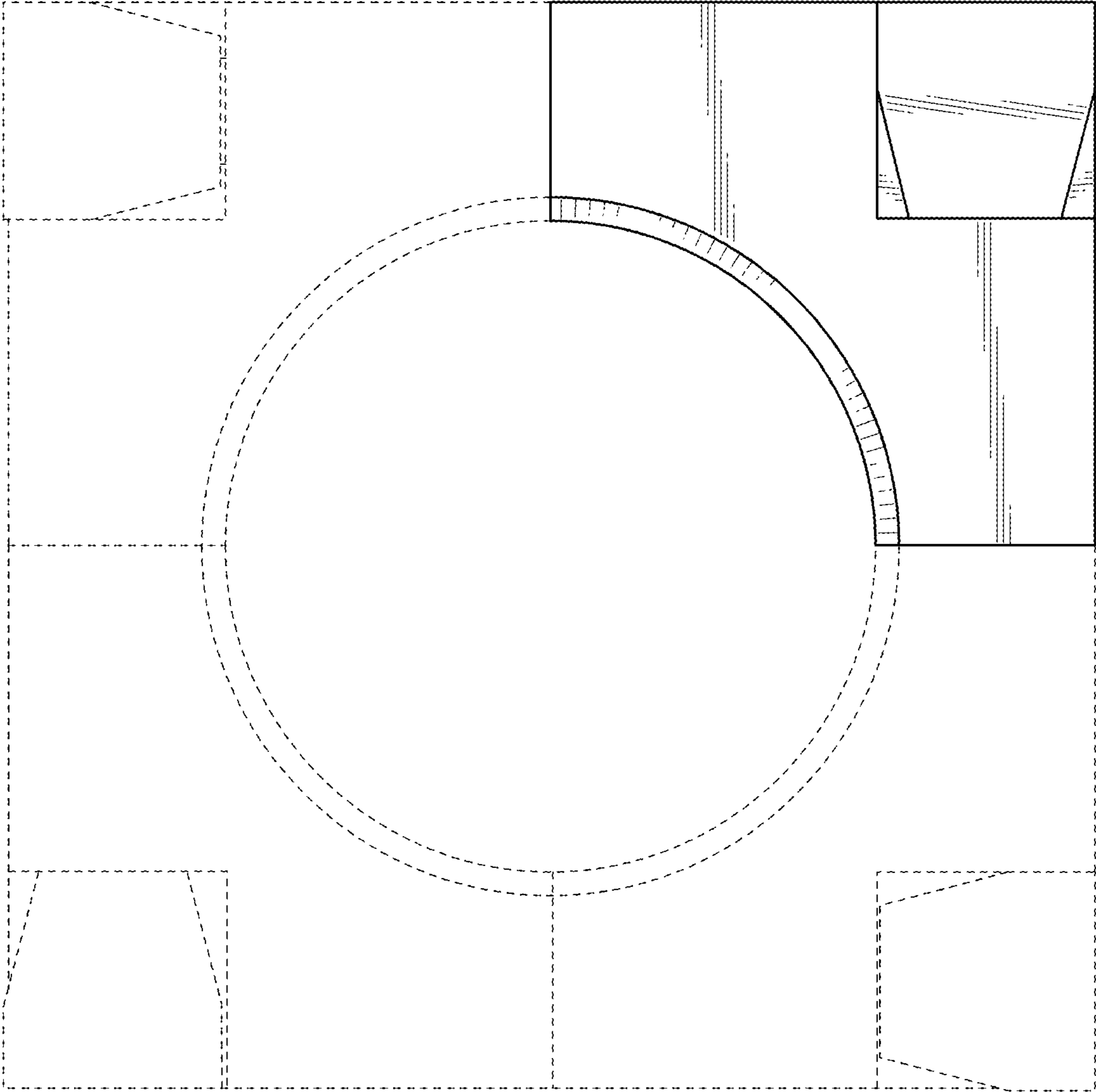

FIG. 8

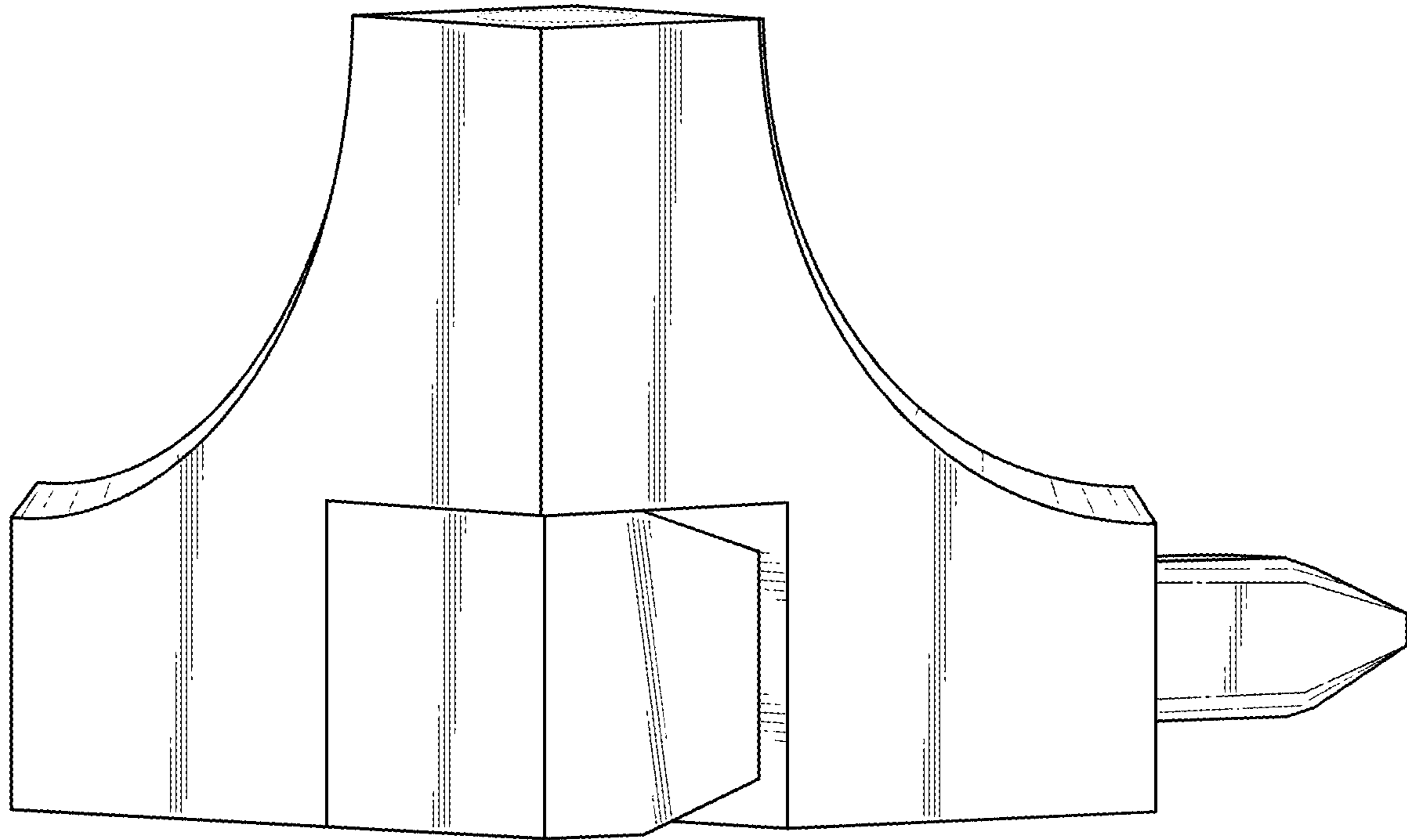

FIG. 9

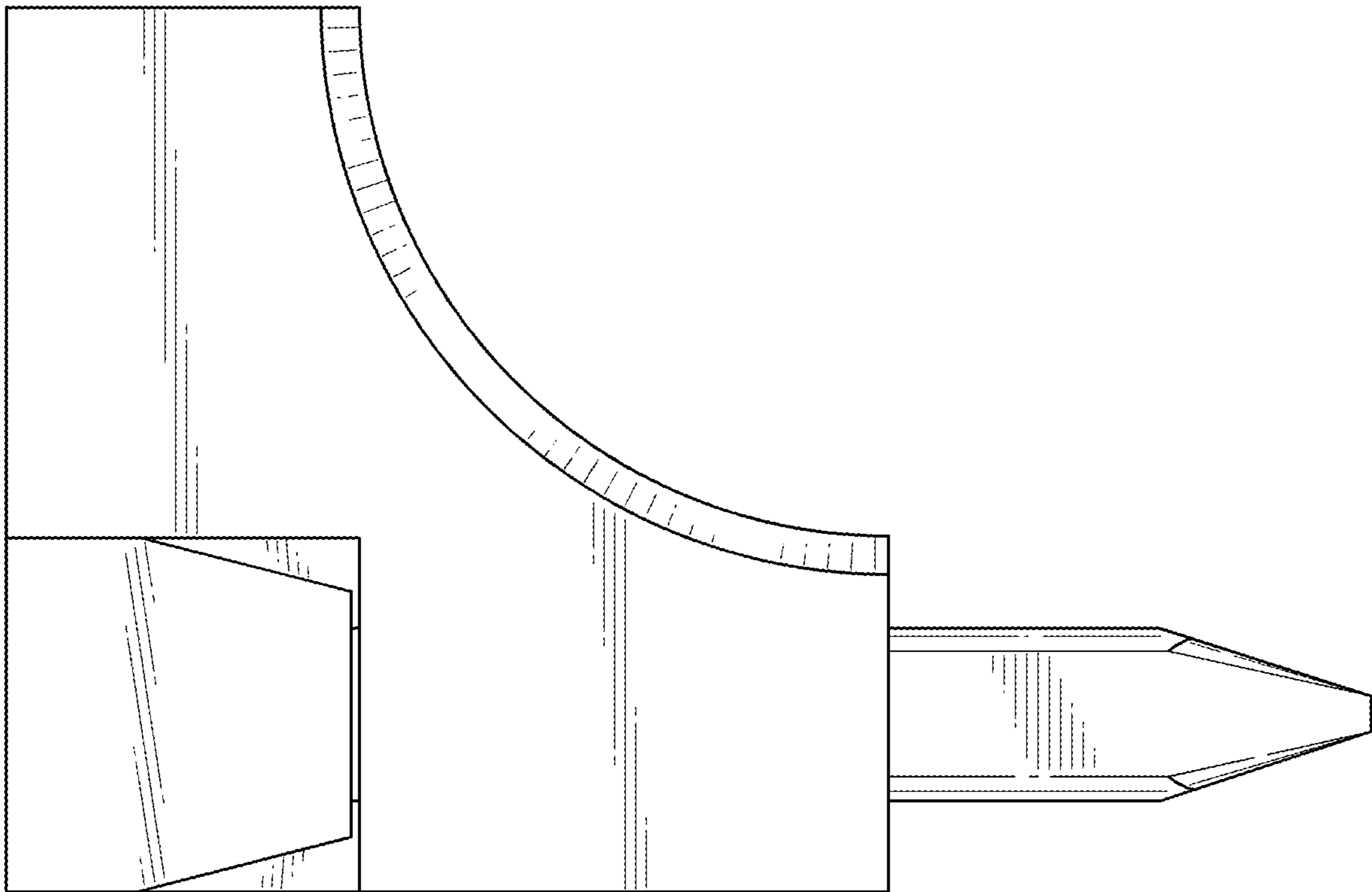

FIG. 10

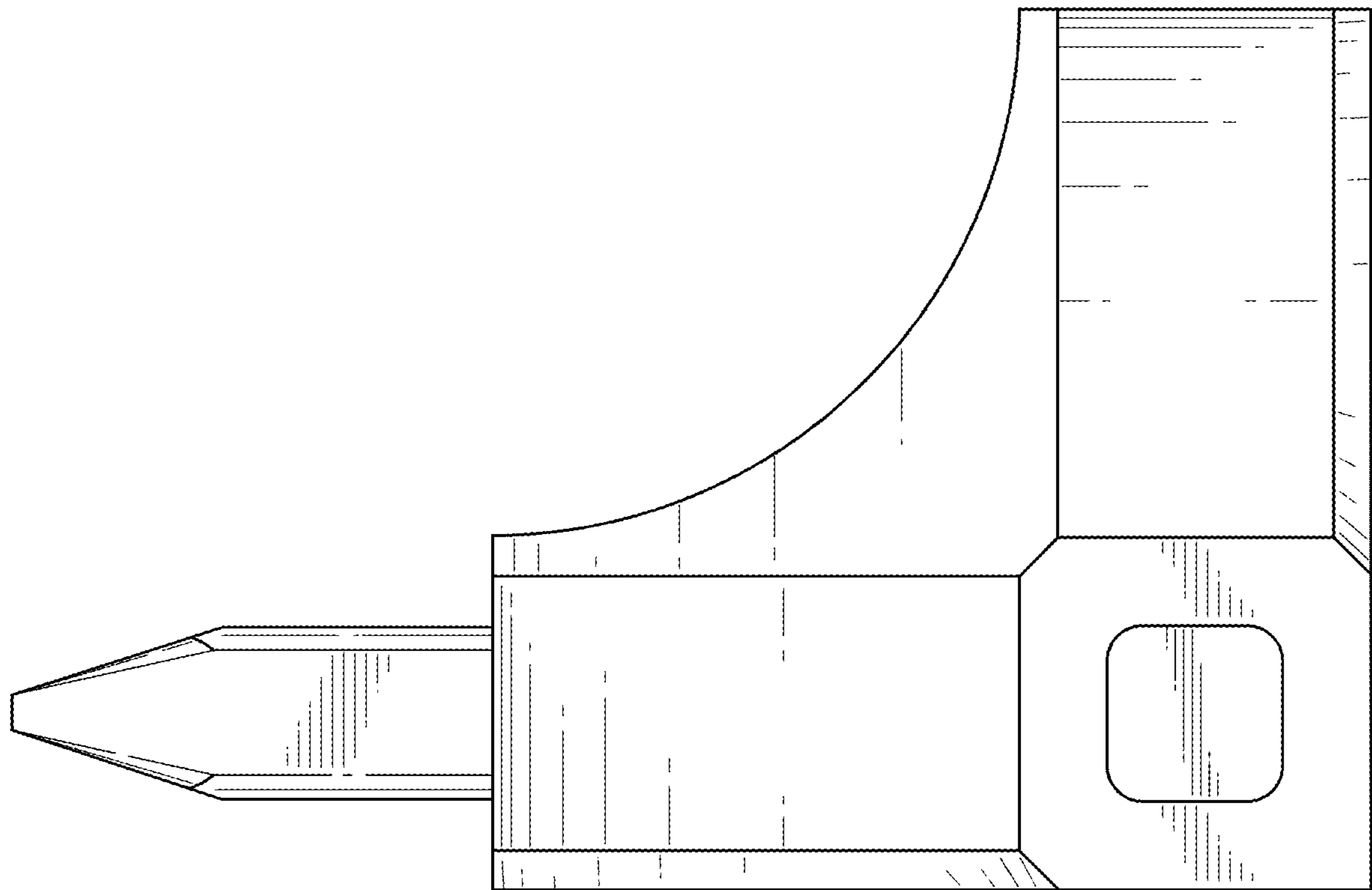

FIG. 11