



US0D1018348S

(12) **United States Design Patent** (10) **Patent No.:** **US D1,018,348 S**
Matsumoto (45) **Date of Patent:** **** Mar. 19, 2024**

(54) **WRISTWATCH DIAL**

(71) Applicant: **SEIKO WATCH KABUSHIKI KAISHA**, Tokyo (JP)

(72) Inventor: **Takuya Matsumoto**, Tokyo (JP)

(73) Assignee: **SEIKO WATCH KABUSHIKI KAISHA**, Tokyo (JP)

(**) Term: **15 Years**

(21) Appl. No.: **29/770,821**

(22) Filed: **Feb. 17, 2021**

(30) **Foreign Application Priority Data**

Aug. 21, 2020 (JP) 2020-017555 D

(51) **LOC (14) Cl.** **10-07**

(52) **U.S. Cl.**
USPC **D10/126**

(58) **Field of Classification Search**
USPC D10/30-39, 122-126

(Continued)

(56) **References Cited**

U.S. PATENT DOCUMENTS

D355,096 S * 2/1995 Lang D10/126
D526,923 S * 8/2006 Okaya D10/126

(Continued)

OTHER PUBLICATIONS

Chopard LUC XPS 1860 Officer Watch Hands-On | ablogtowatch.com; posted Jul. 13, 2017 [online]. © 2007-2023. aBlogtoWatch [retrieved Aug. 1, 2023] from Internet: <<https://www.ablogtowatch.com/chopard-xps-1860-officer-watch/>> (Year: 2017).*

(Continued)

Primary Examiner — Katherine Glennon

(74) *Attorney, Agent, or Firm* — Saidman DesignLaw Group, LLC

(57) **CLAIM**

The ornamental design for a wristwatch dial, as shown and described.

DESCRIPTION

FIG. 1 is a perspective view of a first embodiment of a wristwatch dial showing my new design; FIG. 2 is a front elevational view thereof; FIG. 3 is a rear elevational view thereof; FIG. 4 is a left side elevational view thereof; FIG. 5 is a right side elevational view thereof; FIG. 6 is a top plan view thereof; FIG. 7 is a bottom plan view thereof; FIG. 8 is an enlarged detail of a portion as defined by dash-dotted circle 8 in FIG. 2; FIG. 9 is a cross sectional view thereof, taken along lines 9-9 of FIG. 8; FIG. 10 is a cross sectional view thereof, taken along lines 10-10 of FIG. 8; FIG. 11 is a perspective view of a second embodiment thereof; FIG. 12 is a front elevational view thereof; FIG. 13 is a rear elevational view thereof; FIG. 14 is a left side elevational view thereof; FIG. 15 is a right side elevational view thereof; FIG. 16 is a top plan view thereof; FIG. 17 is a bottom plan view thereof; FIG. 18 is an enlarged detail of a portion as defined by dash-dotted rectangle 18 in FIG. 12; FIG. 19 is an enlarged detail of a portion as defined by dash-dotted circle 19 in FIG. 18; FIG. 20 is a cross sectional view thereof, taken along line 20-20 of FIG. 19; and, FIG. 21 is a cross sectional view thereof, taken along lines 21-21 of FIG. 19.

The broken lines shown in the drawings illustrate portions of the wristwatch dial that form no part of the claimed design.

(Continued)

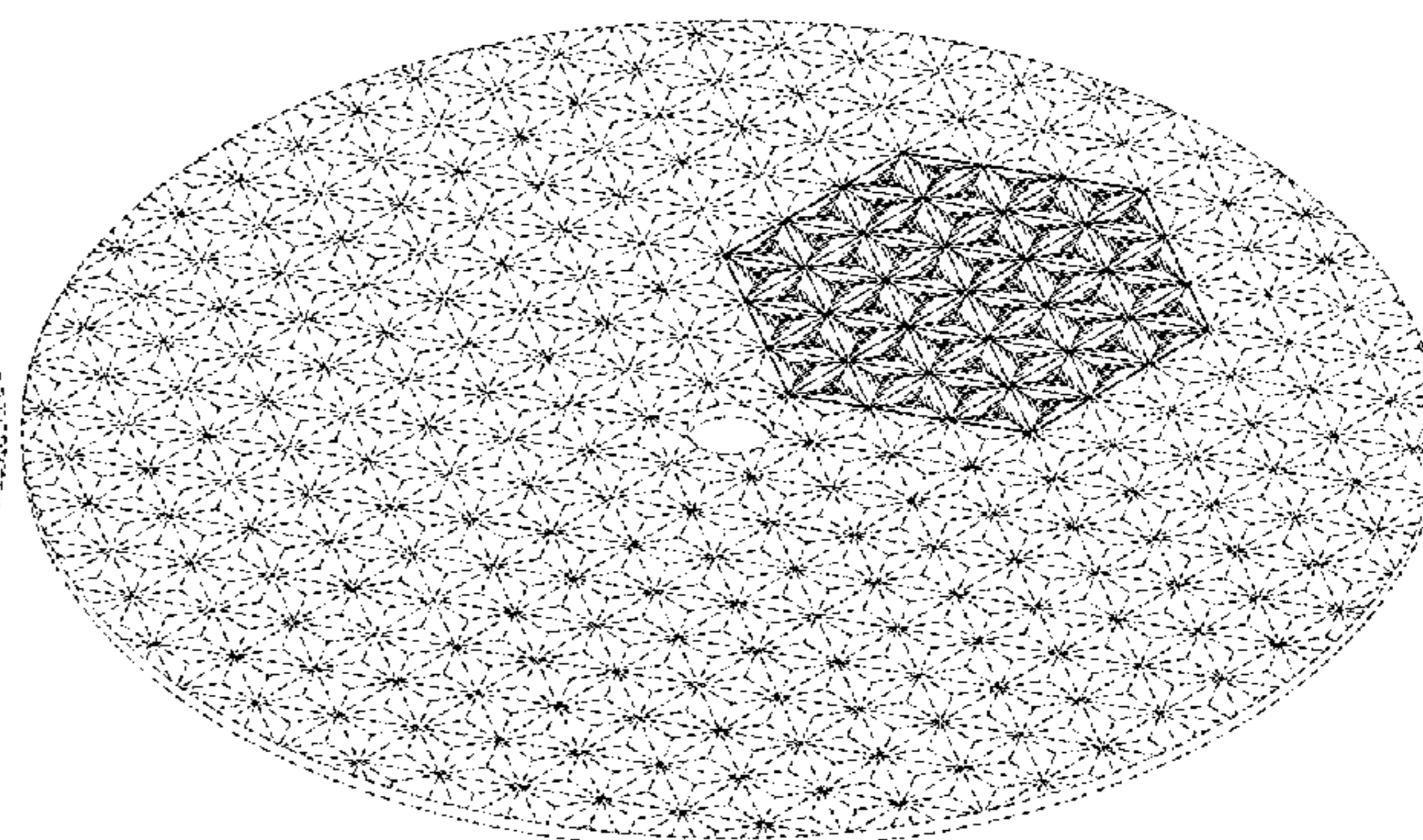
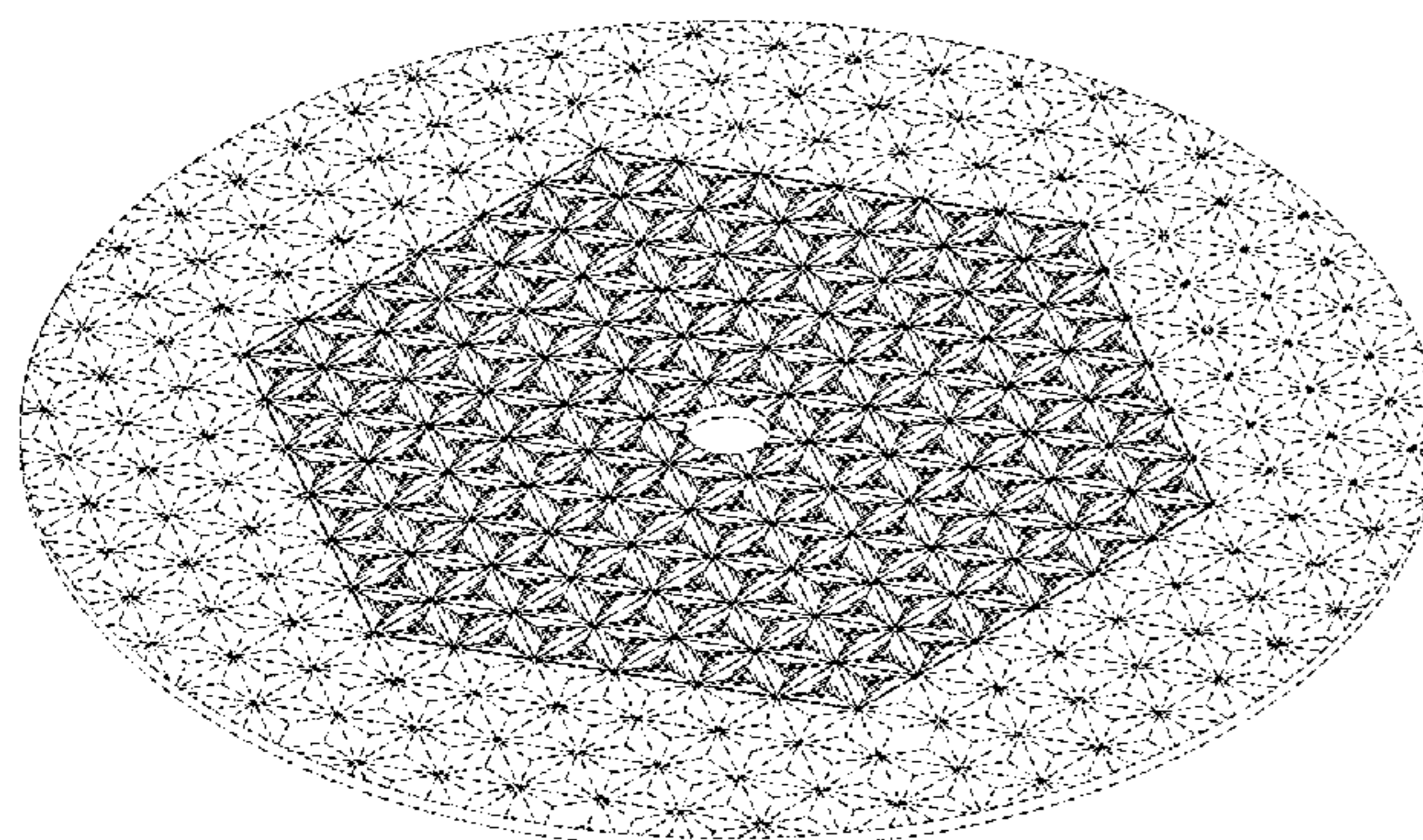

The dash-dotted lines illustrate the boundaries of the enlarged detail views and form no part of the claimed design.

1 Claim, 21 Drawing Sheets

(58) Field of Classification Search

CPC G04B 19/00; G04B 19/06; G04B 19/065;
G04B 19/12

See application file for complete search history.

(56)

References Cited

U.S. PATENT DOCUMENTS

| | | | | | | |
|----------|---|---|--------|-----------|-------|---------|
| D527,297 | S | * | 8/2006 | Calvani | | D10/126 |
| D572,620 | S | * | 7/2008 | Schoepfer | | D10/125 |
| D594,350 | S | * | 6/2009 | Arpa | | D10/32 |
| D615,882 | S | * | 5/2010 | Laucella | | D10/39 |
| D618,575 | S | * | 6/2010 | Duport | | D10/126 |
| D620,827 | S | * | 8/2010 | Cerrato | | D10/126 |

| | | | | | | |
|--------------|----|---|---------|------------|-------|------------------------|
| D727,755 | S | * | 4/2015 | Laucella | | D10/39 |
| D760,105 | S | * | 6/2016 | Monachon | | D10/126 |
| D833,314 | S | * | 11/2018 | Duport | | D10/126 |
| D880,335 | S | * | 4/2020 | Lasserre | | D10/126 |
| D898,602 | S | * | 10/2020 | Lasserre | | D10/126 |
| D942,884 | S | * | 2/2022 | Gaiddon | | D10/126 |
| D945,902 | S | * | 3/2022 | Parmigiani | | D10/126 |
| D974,946 | S | * | 1/2023 | Stern | | D10/123 |
| 2005/0219626 | A1 | * | 10/2005 | Moncrieff | | G06K 15/00 358/3.12 |

OTHER PUBLICATIONS

Introducing Vacheron Constantin Traditionnelle Harrods Editions | watchesbysjx.com; posted Jun. 3, 2019 [online]. © SJX Watches 2011-2023 [retrieved Aug. 1, 2023] from Internet: <<https://watchesbysjx.com/2019/06/03>> (Year: 2019).*

KOMO Asanoha Dial | komoworks.com; no date [online]. [retrieved Aug. 5, 2023] from Internet: <<https://komoworks.com/products/asanoha-dial>> (Year: 2023).*

* cited by examiner

Fig. 1

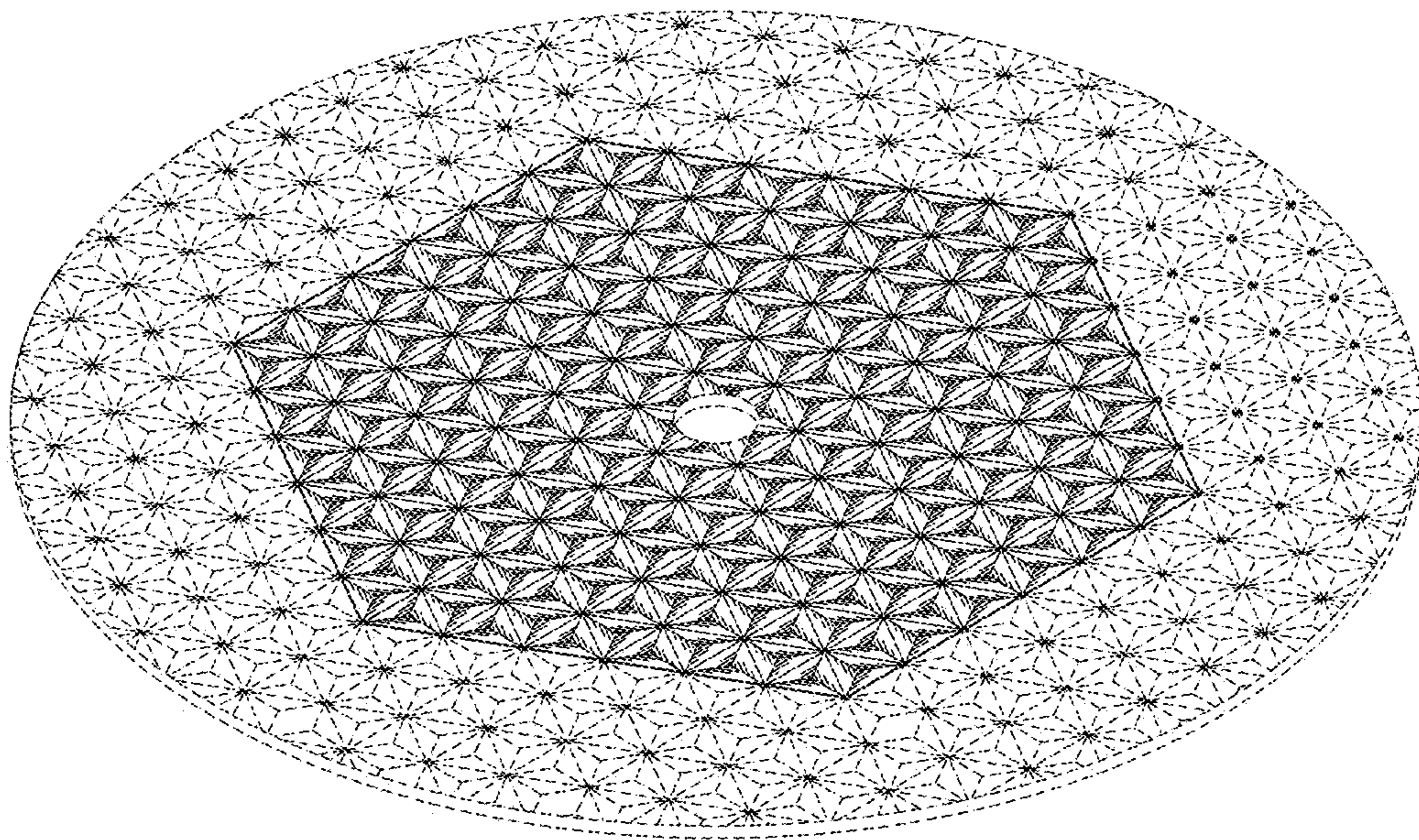

Fig.2

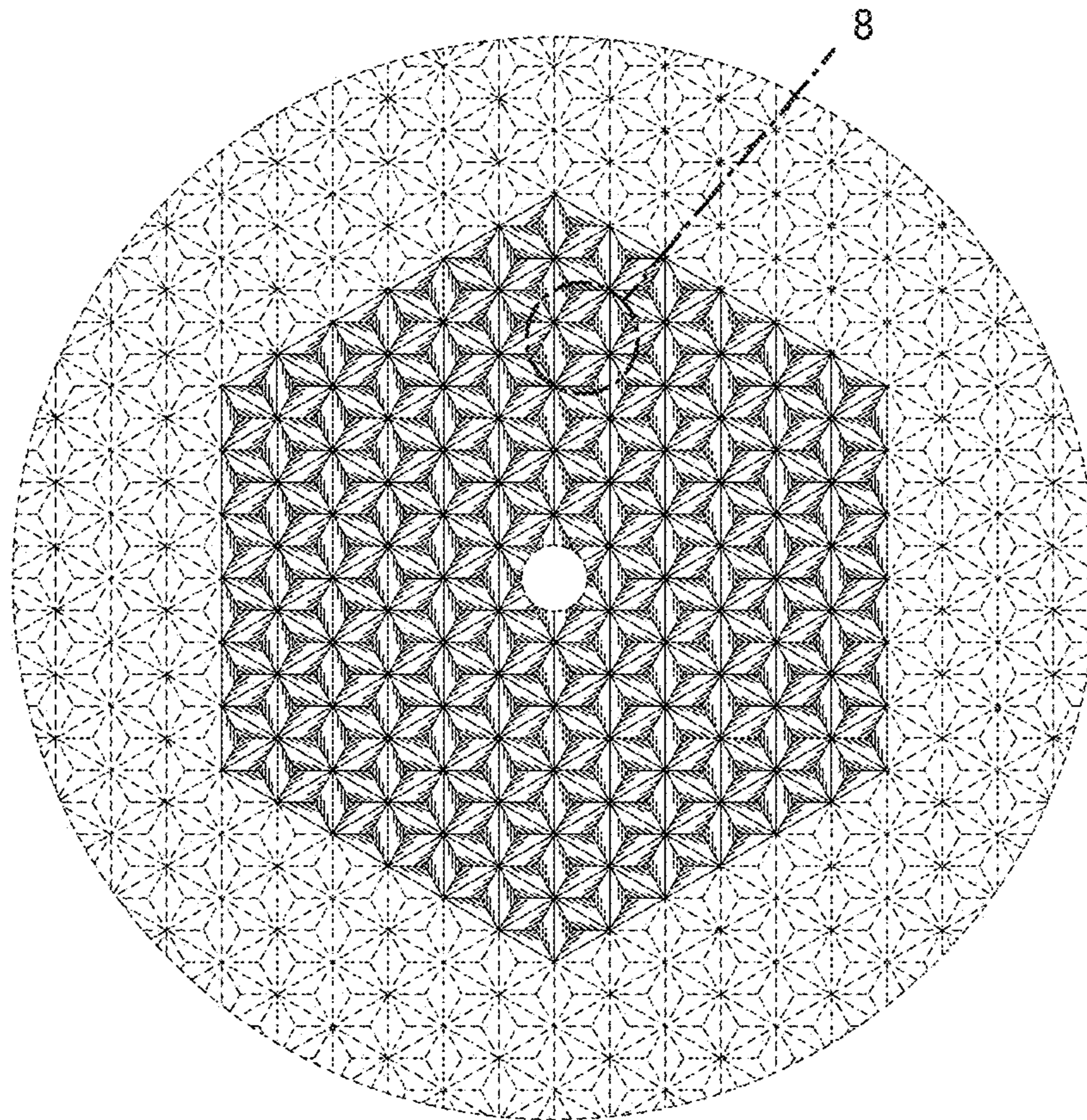

Fig.3

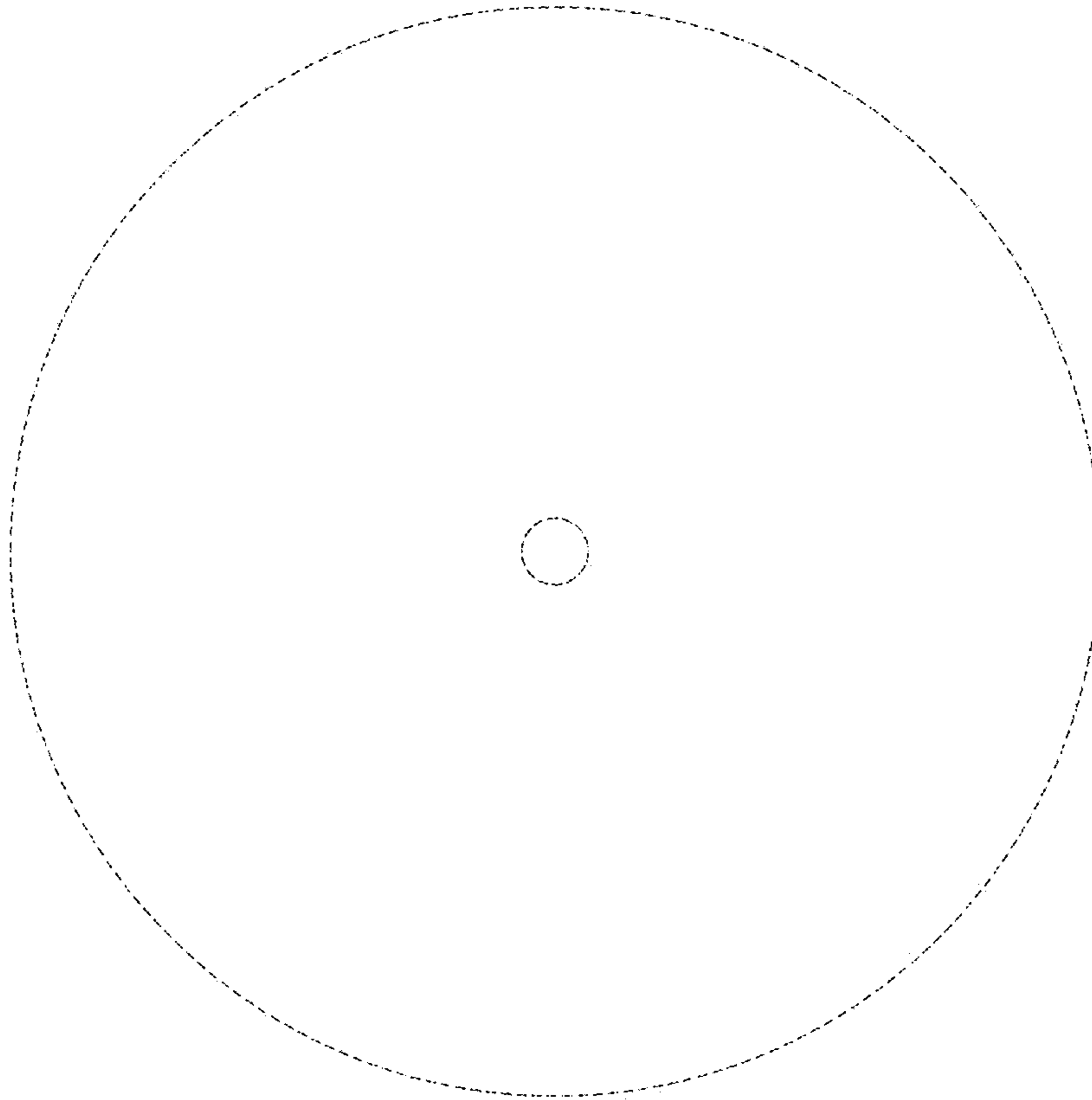

Fig.4

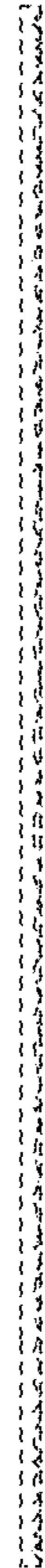

Fig.5

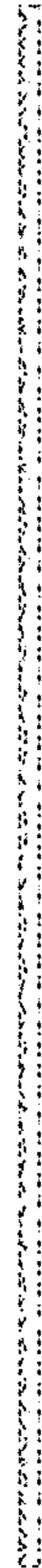

Fig.6

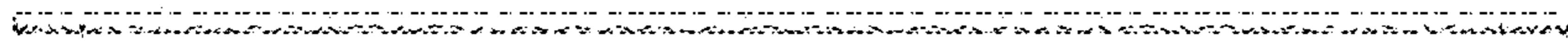

Fig.7

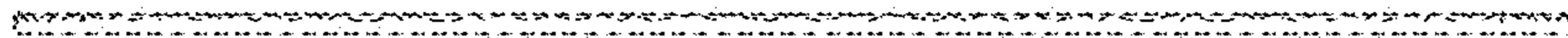

Fig.8

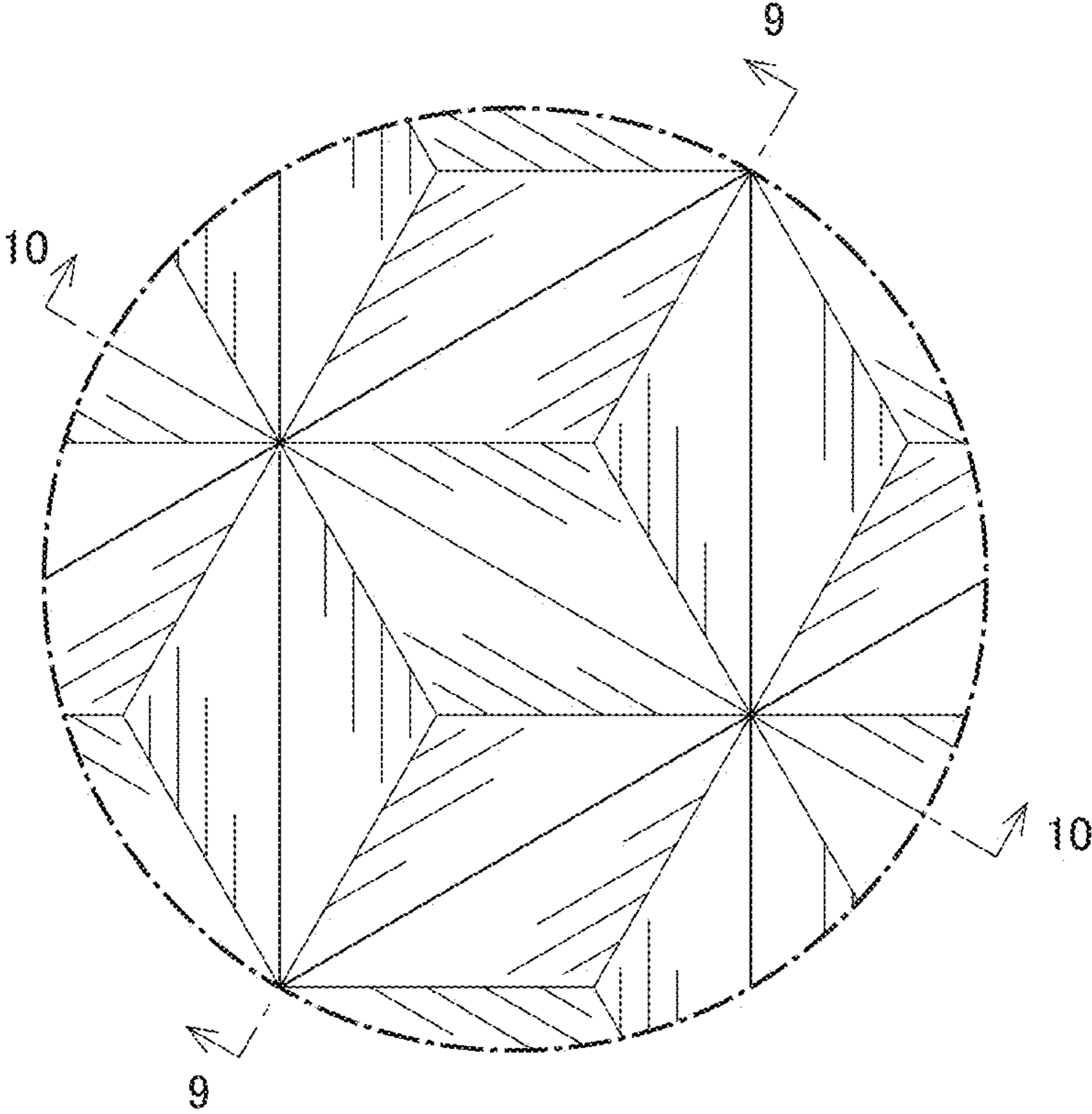

Fig.9

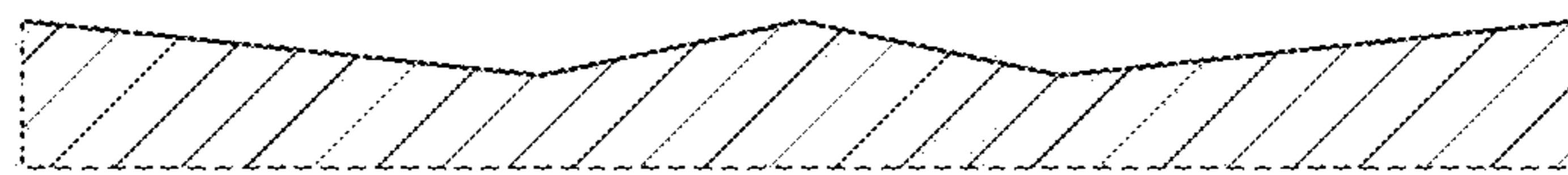

Fig. 10

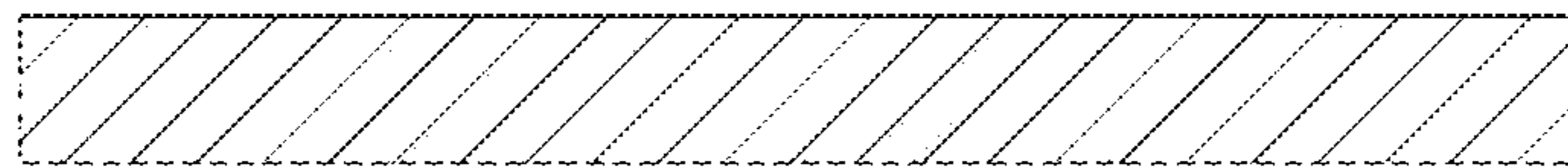

Fig. 11

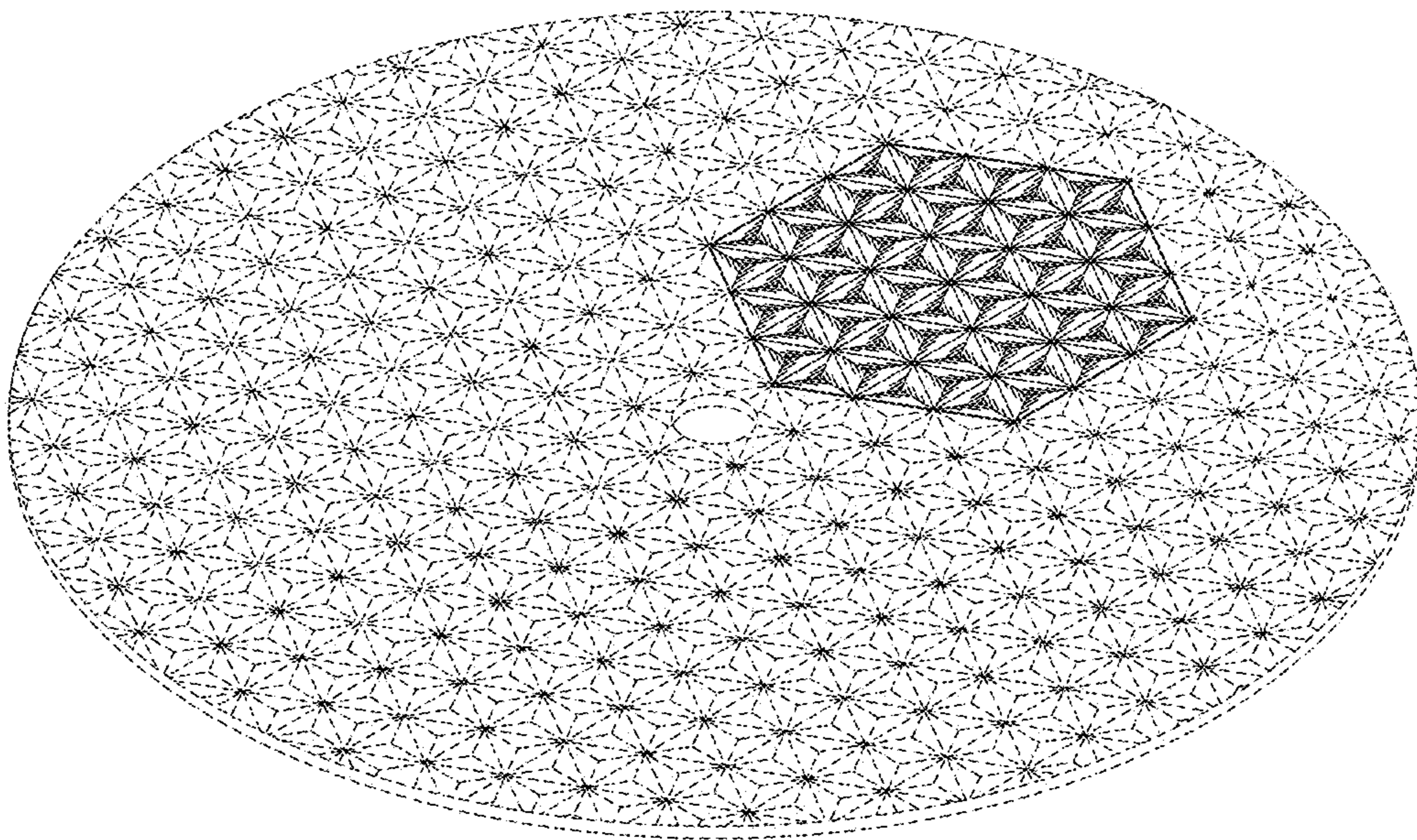

Fig.12

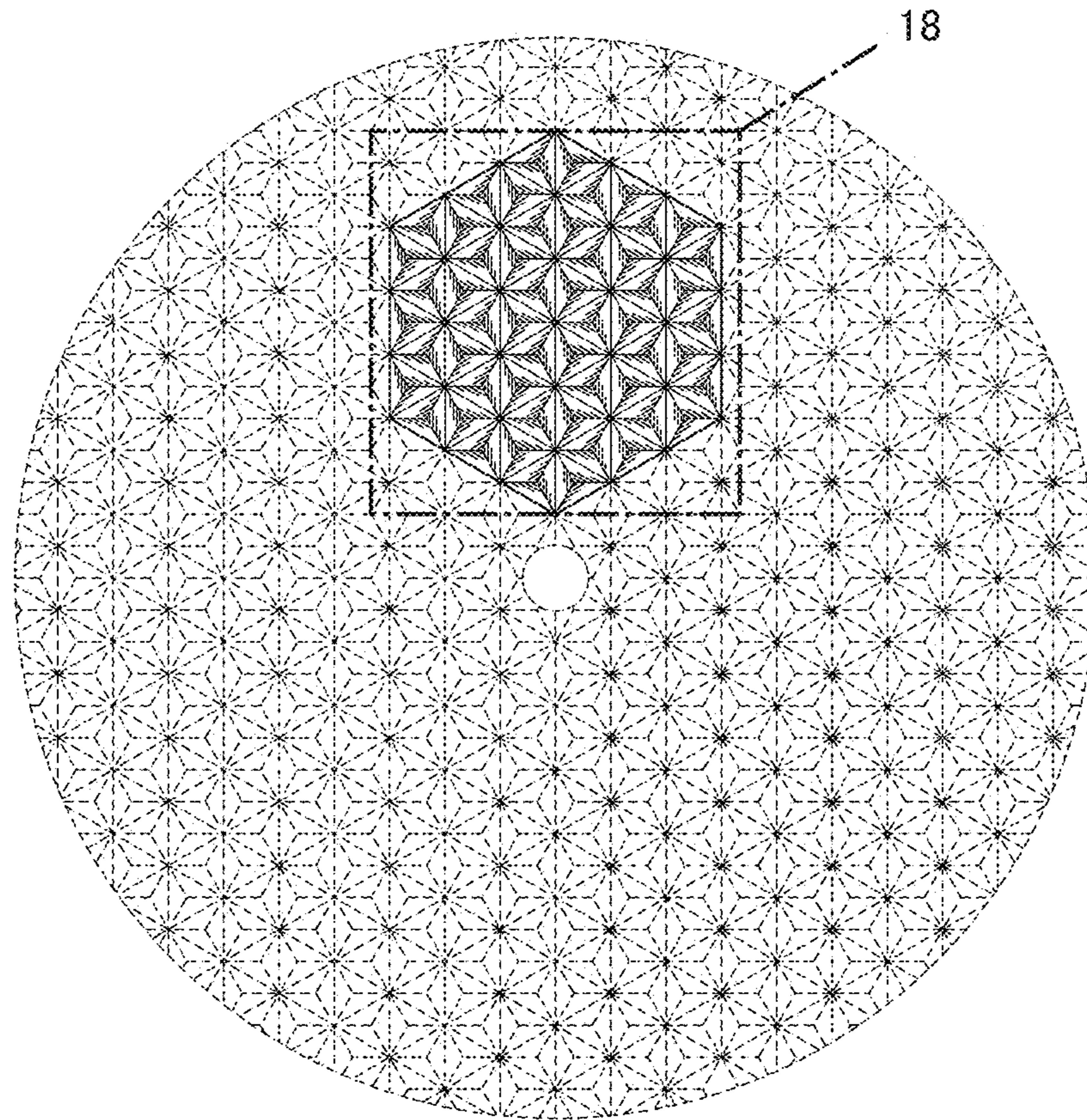

Fig.13

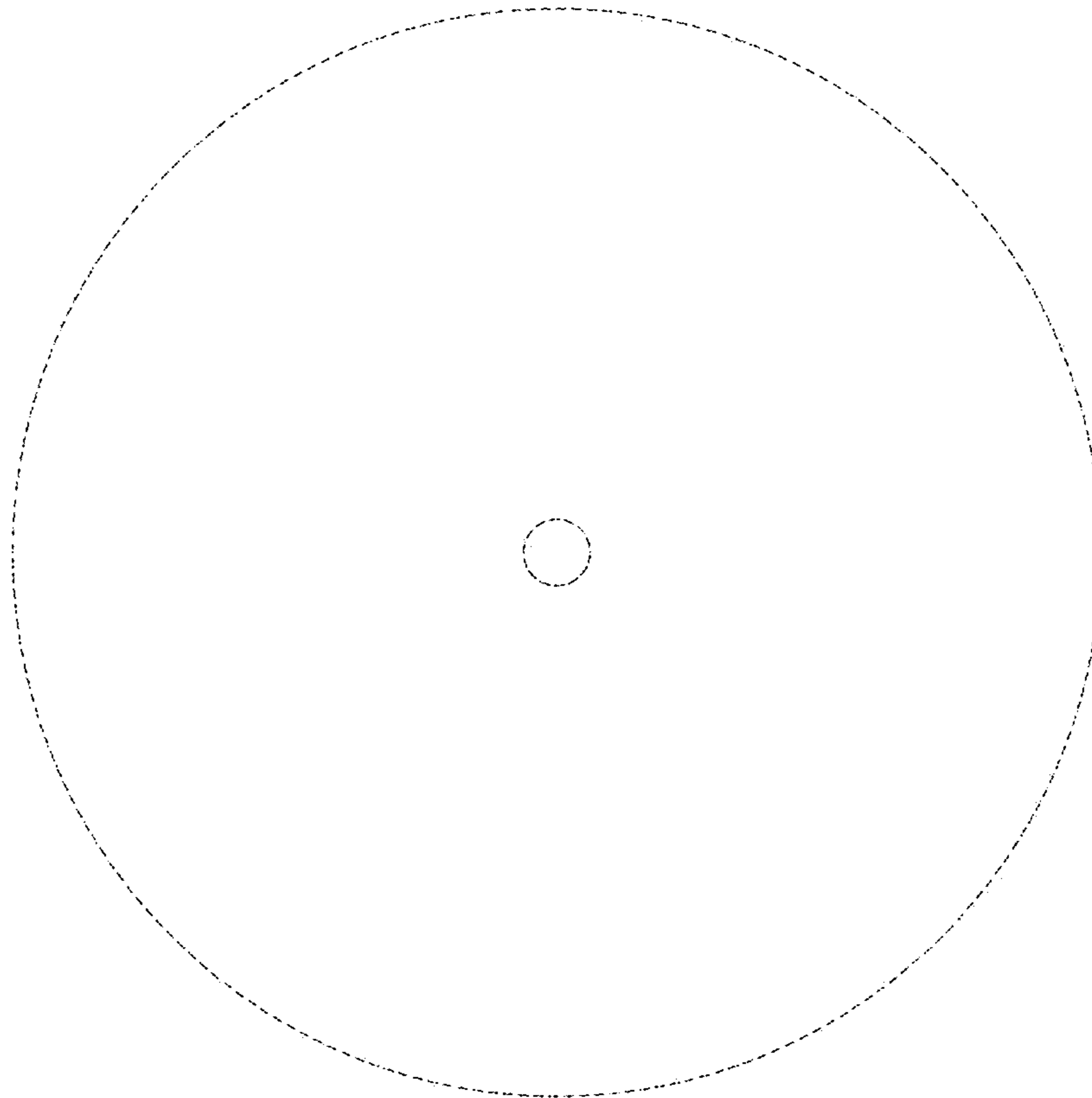

Fig. 14

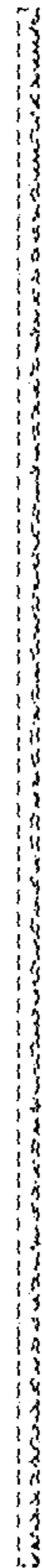

Fig. 15

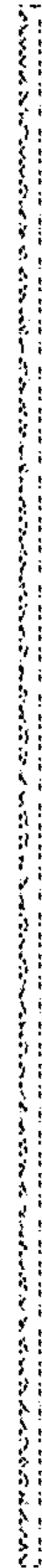

Fig.16

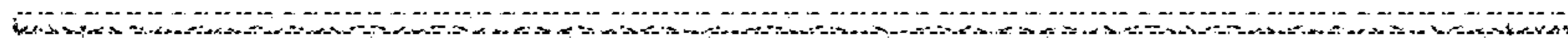

Fig.17

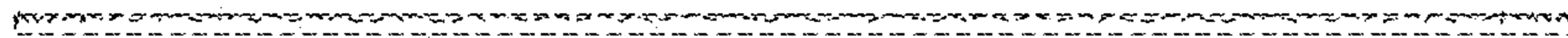

Fig. 18

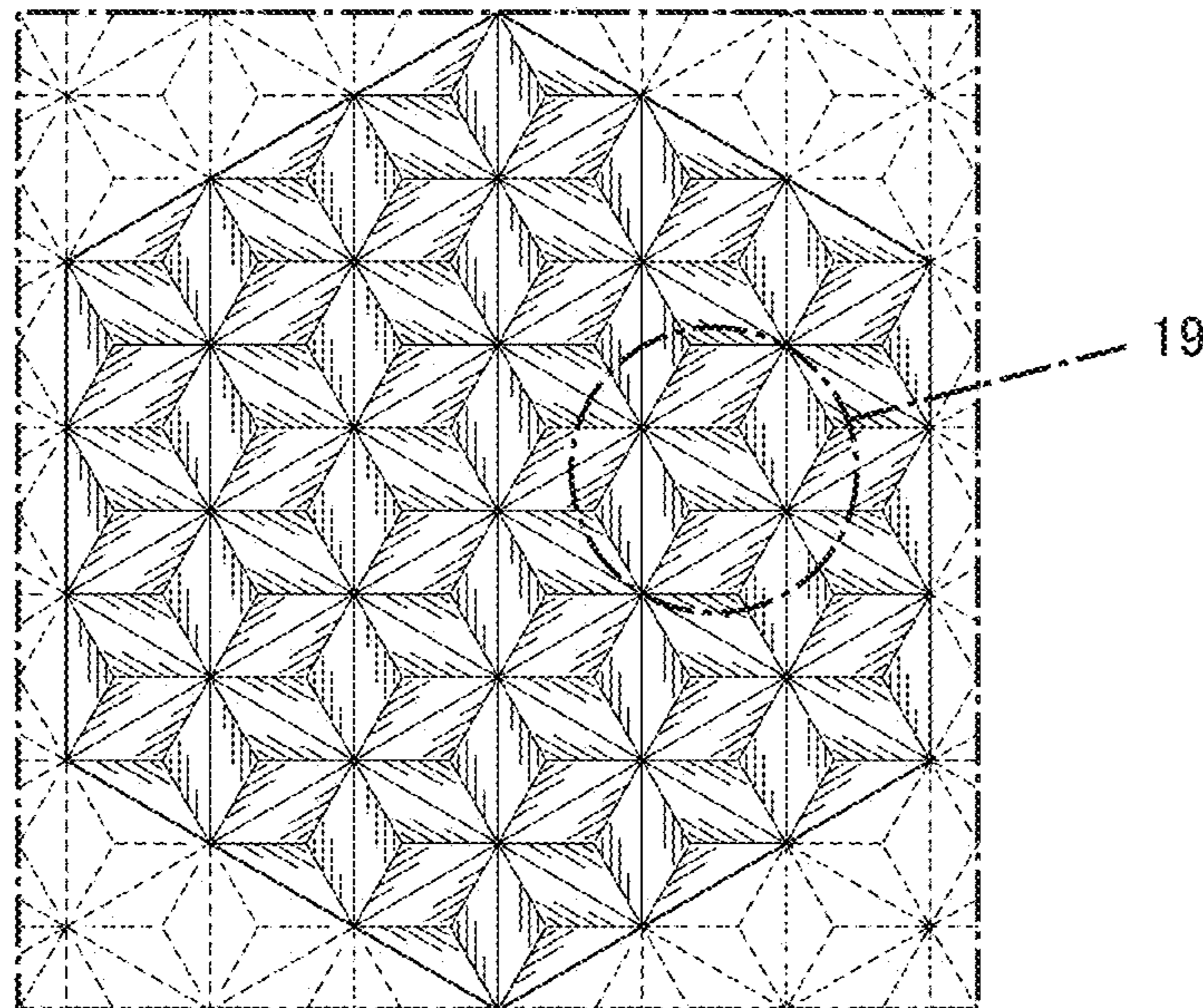

Fig. 19

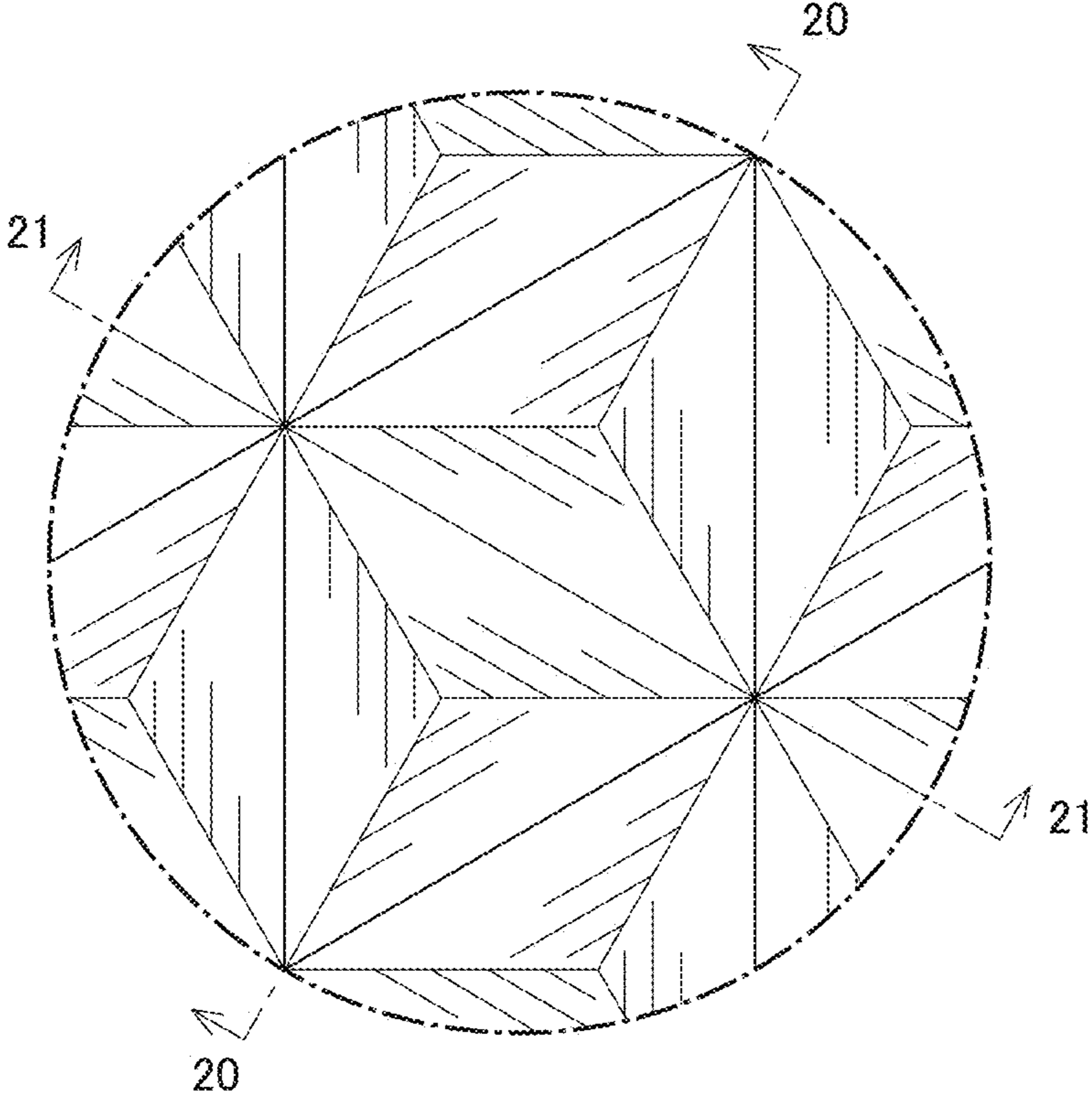

Fig.20

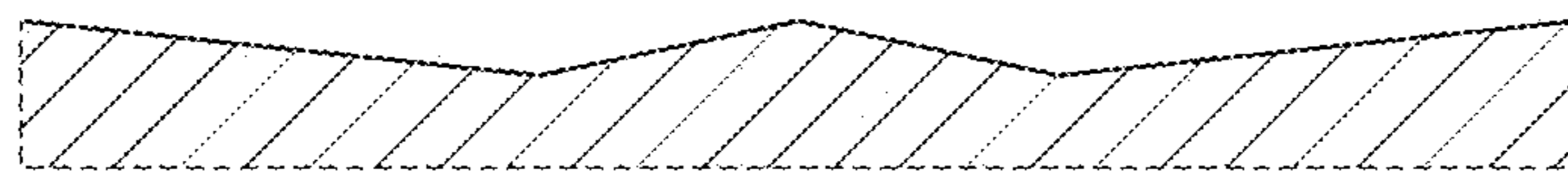

Fig.21

