



US0D1012798S

(12) **United States Design Patent**
Chiang

(10) **Patent No.:** **US D1,012,798 S**

(45) **Date of Patent:** **** Jan. 30, 2024**

(54) **MUD FLAP SET**

(71) Applicant: **Man Kit Chiang**, Dublin, CA (US)

(72) Inventor: **Man Kit Chiang**, Dublin, CA (US)

(**) Term: **15 Years**

(21) Appl. No.: **29/787,029**

(22) Filed: **Jun. 3, 2021**

(51) **LOC (14) Cl.** **12-16**

(52) **U.S. Cl.**

USPC **D12/185**

(58) **Field of Classification Search**

USPC D12/90-92, 93, 96, 181, 184, 185, 196,
D12/202

CPC B62D 25/18; B62D 25/188

See application file for complete search history.

(56) **References Cited**

U.S. PATENT DOCUMENTS

D267,864 S *	2/1983	Watanabe	D12/185
D281,774 S *	12/1985	Ward	D12/185
D308,847 S *	6/1990	Price	D12/185
D310,345 S *	9/1990	Iacovelli	D12/185
D315,133 S *	3/1991	Charet	D12/185
D316,536 S *	4/1991	Charet	D12/185
5,407,229 A *	4/1995	Garrett	B62D 25/18 280/851
D415,460 S *	10/1999	Ward	D12/185
D808,314 S *	1/2018	Johnson	D12/185
D818,914 S *	5/2018	Johnson	D12/185
D826,120 S *	8/2018	DiCanzio	B62D 25/18 D12/185
D848,914 S *	5/2019	Haga	D12/185
D850,342 S *	6/2019	DiCanzio	D12/185
D859,250 S *	9/2019	Johnson	D12/185
D904,257 S *	12/2020	DiCanzio	D12/185
D904,951 S *	12/2020	Morgan, Jr.	D12/185
D973,564 S *	12/2022	Spencer	D12/185
2018/0009485 A1 *	1/2018	Johnson	B62D 25/18

OTHER PUBLICATIONS

Amazon, Extreme Online Store Replacement for 2020 Chevrolet Corvette C8, published Mar. 25, 2018 [retrieved Oct. 7, 2022]. Retrieved from the internet<<https://www.amazon.com/Extreme-Online-Store-Replacement-2020-Present/dp/B08Q2WJNV3>> (Year: 2018).*

Ebay, For 2014-2019 Chevy C7 Corvette Stingray/Z06 Front and Rear splash Guards Mud Flap, published Sep. 28, 2022 [retrieved Oct. 7, 2022]. Retrieved from the internet<<https://www.ebay.com/itm/174955146218>> (Year: 2022).*

* cited by examiner

Primary Examiner — Joseph Kukella

Assistant Examiner — Lavon M. Amerson

(57) **CLAIM**

The ornamental design for a mud flap set, as shown and described.

DESCRIPTION

FIG. 1 is a top-front-left perspective view of a mud flap set showing my new design;
FIG. 2 is a top-rear-right perspective view thereof;
FIG. 3 is a bottom-front-left perspective view thereof;
FIG. 4 is a bottom-rear-right perspective view thereof;
FIG. 5 is a front elevational view thereof;
FIG. 6 is a rear elevational view thereof;
FIG. 7 is a top plan view thereof;
FIG. 8 is a bottom plan view thereof;
FIG. 9 is a right elevational view thereof; and,
FIG. 10 is a left elevational view thereof.
The broken lines showing fastening members in FIGS. 1-10 are included for the purpose of illustrating environmental structure and form no part of the claimed design.

1 Claim, 10 Drawing Sheets

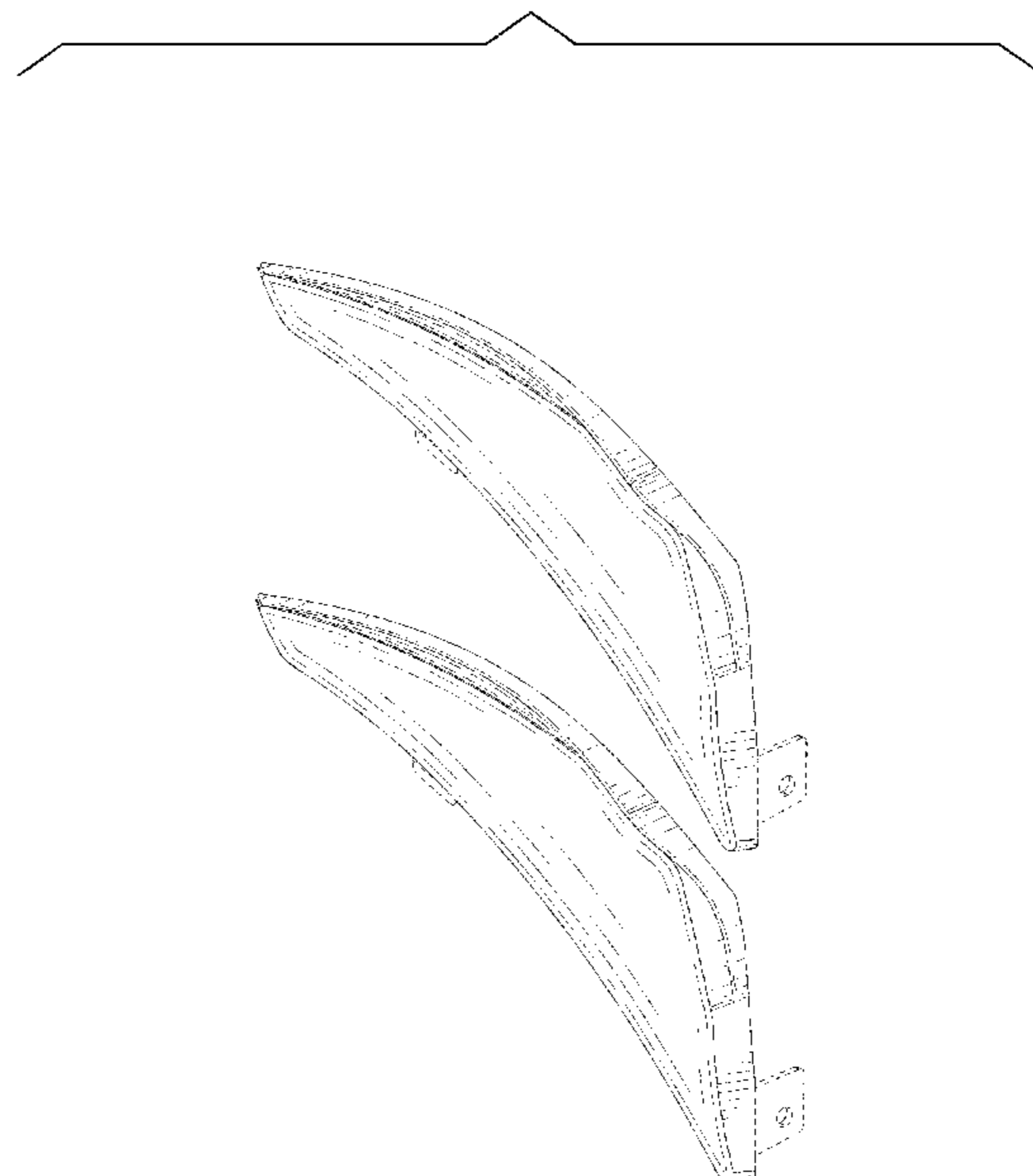

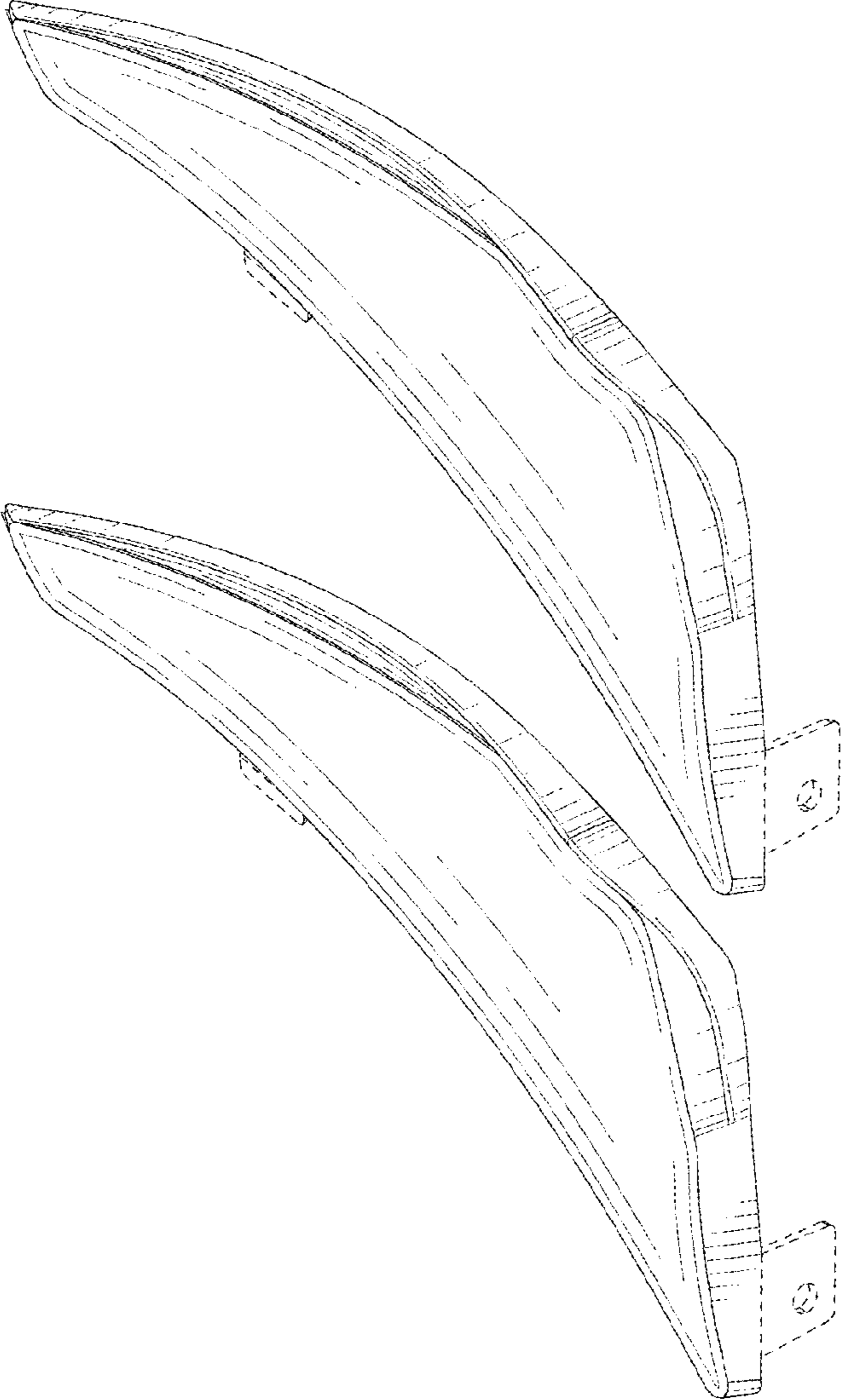
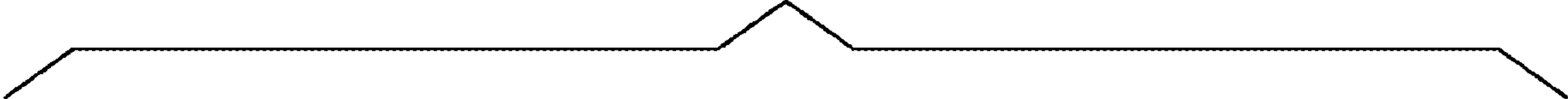

FIG. 1

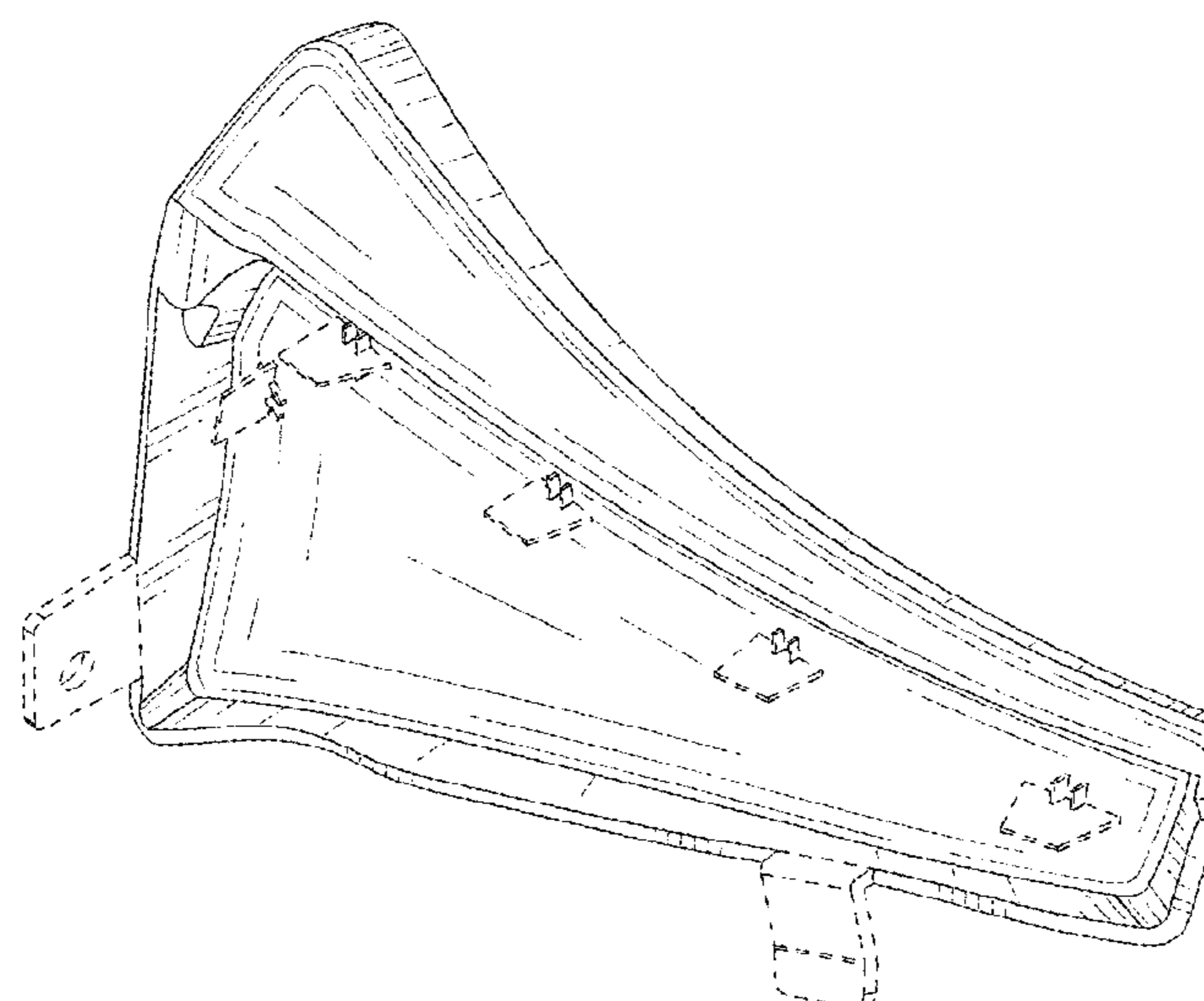
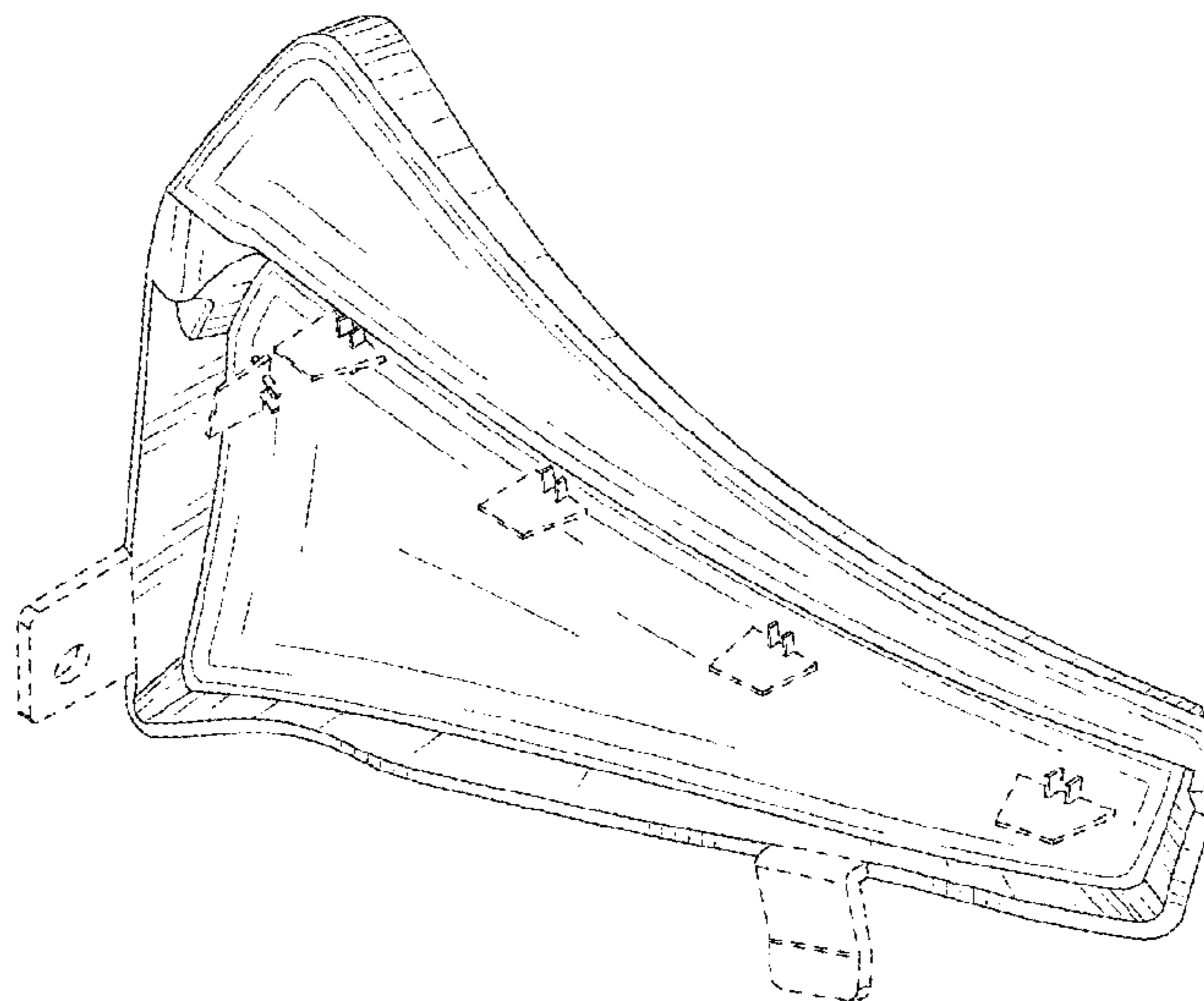

FIG. 2

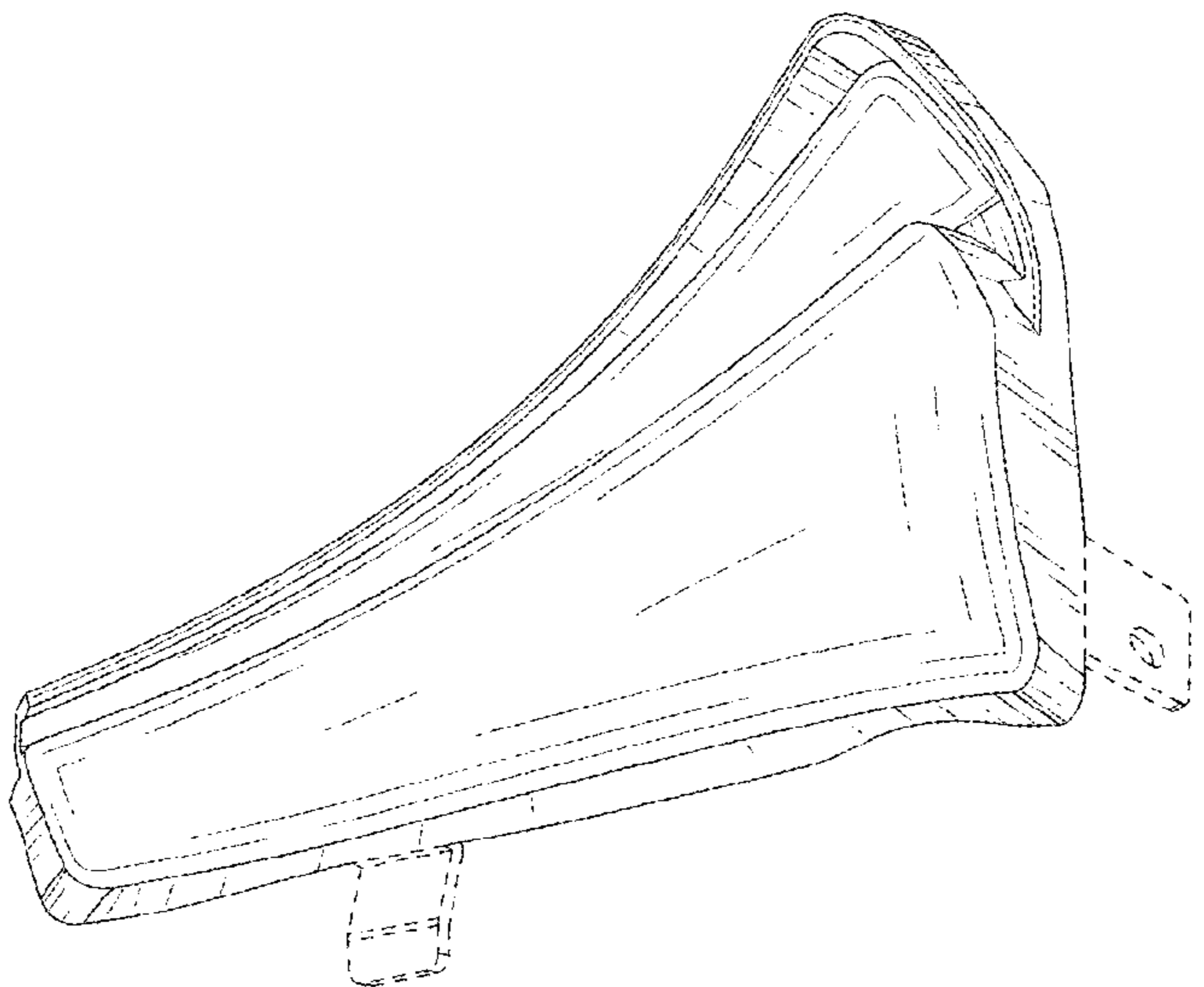
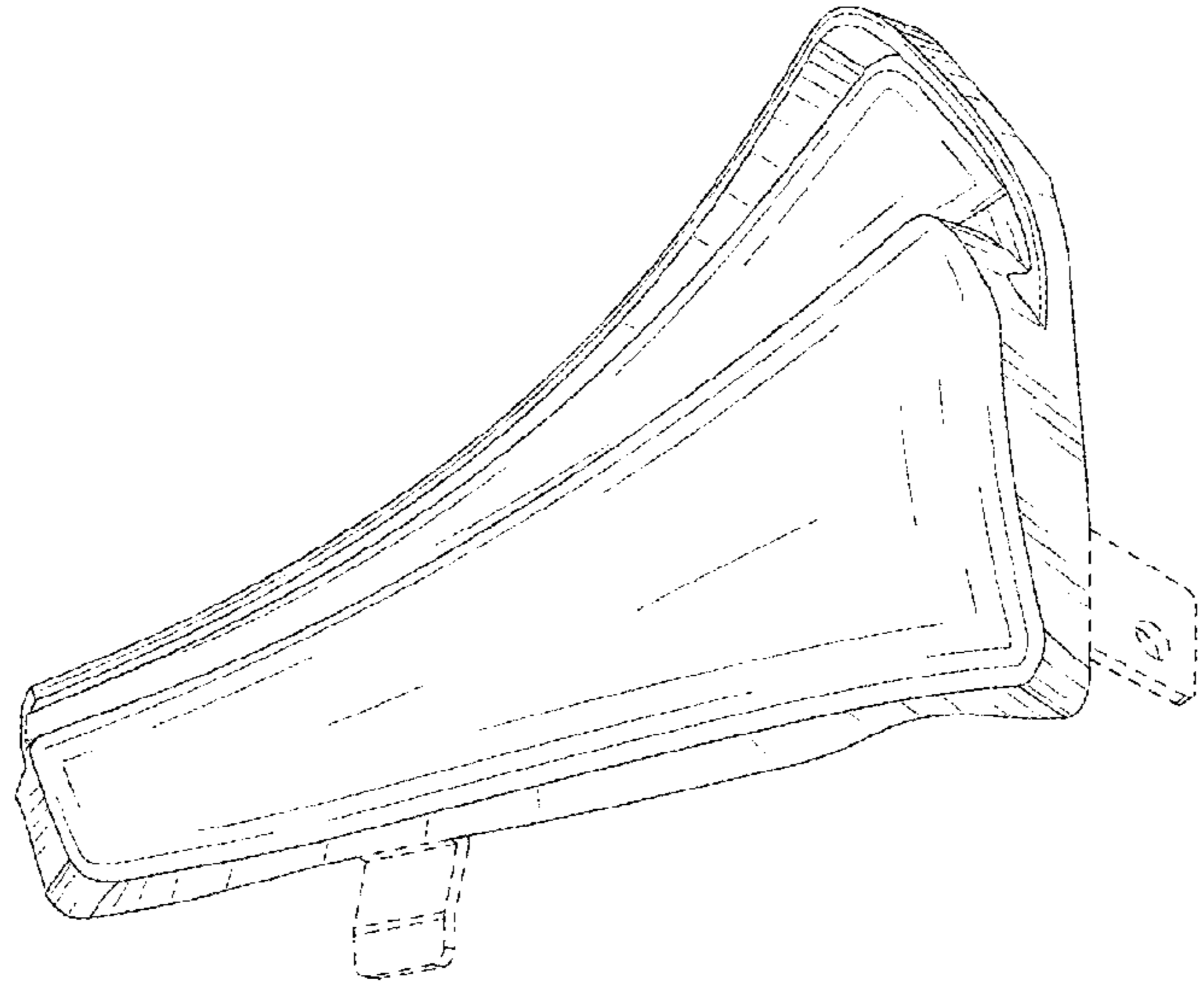

FIG. 3

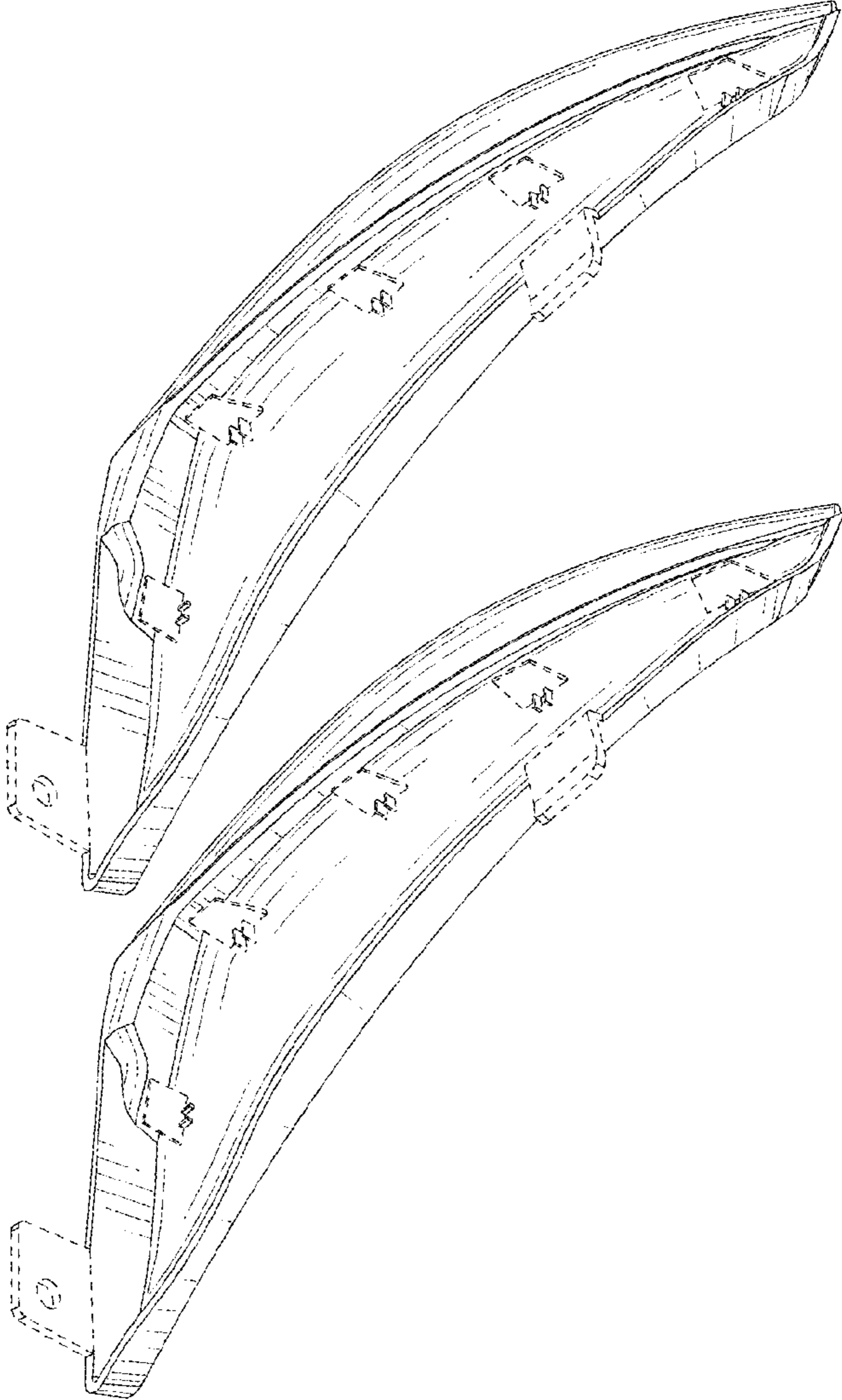
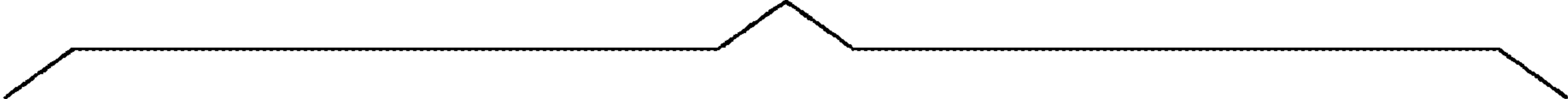

FIG. 4

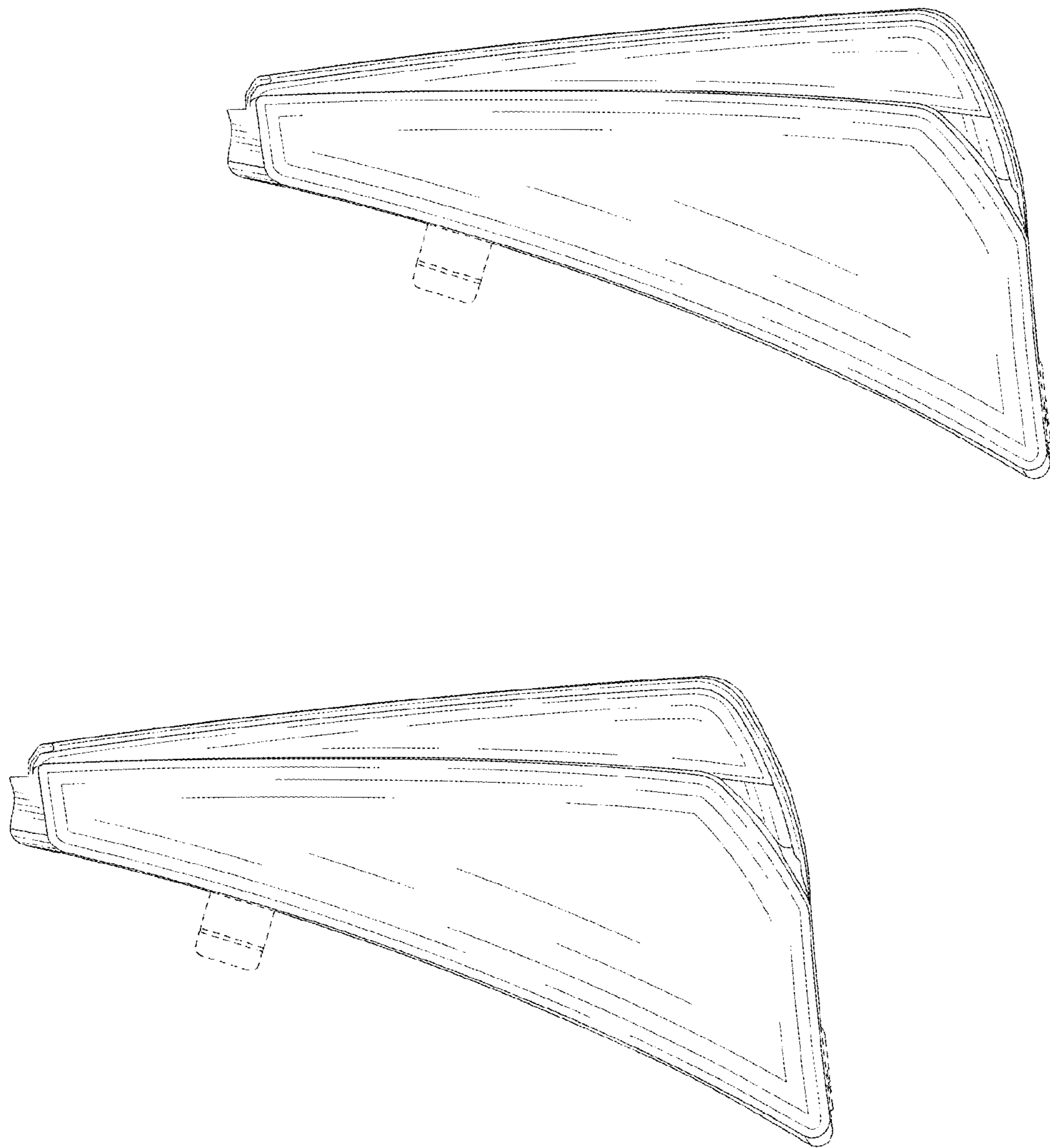
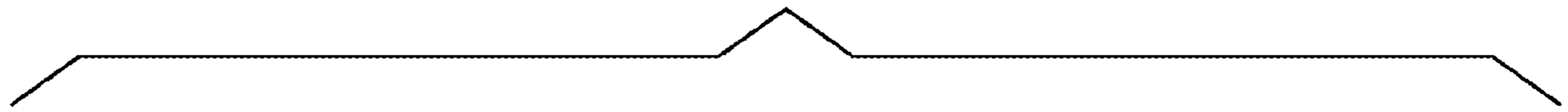

FIG. 5

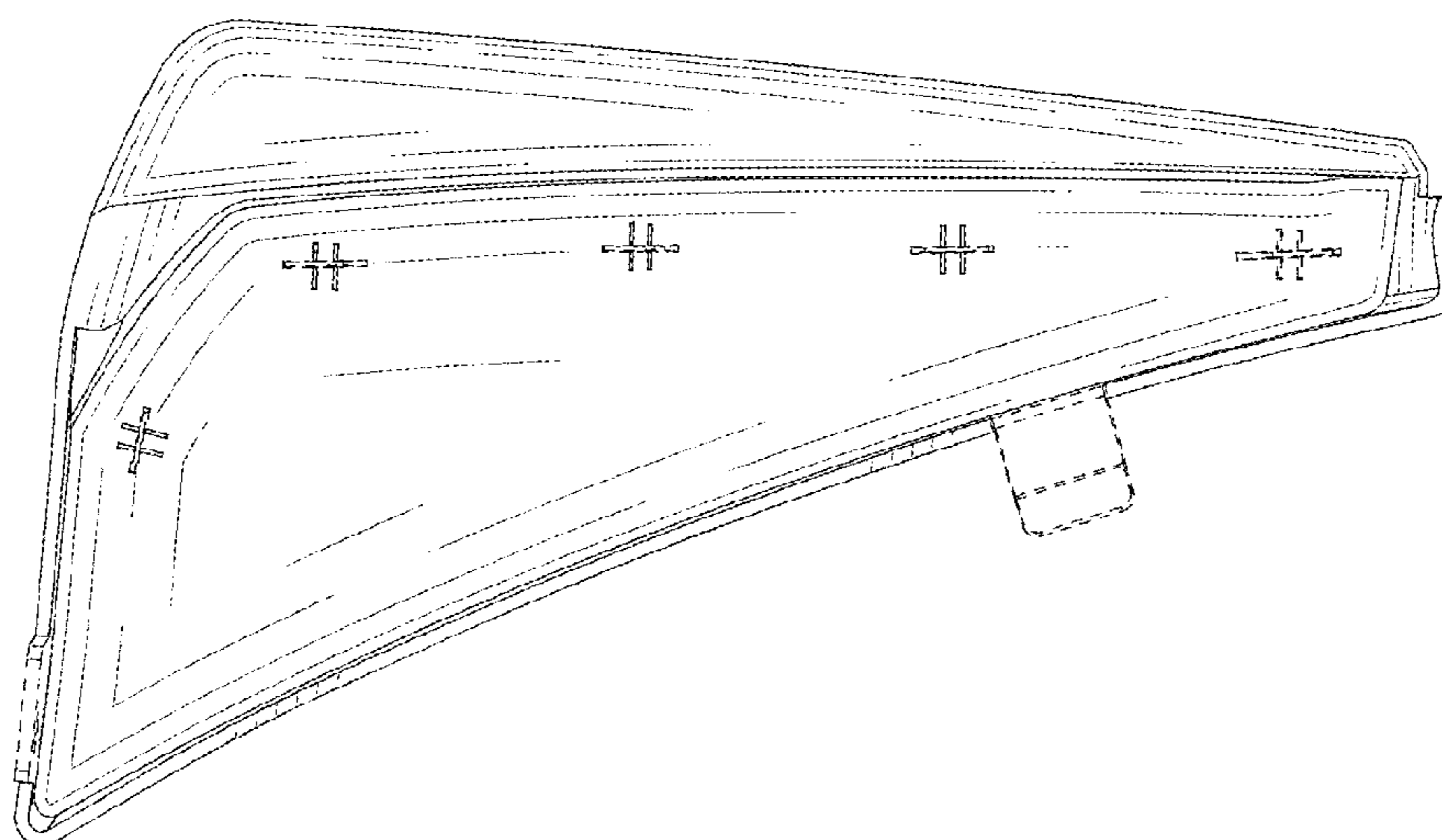
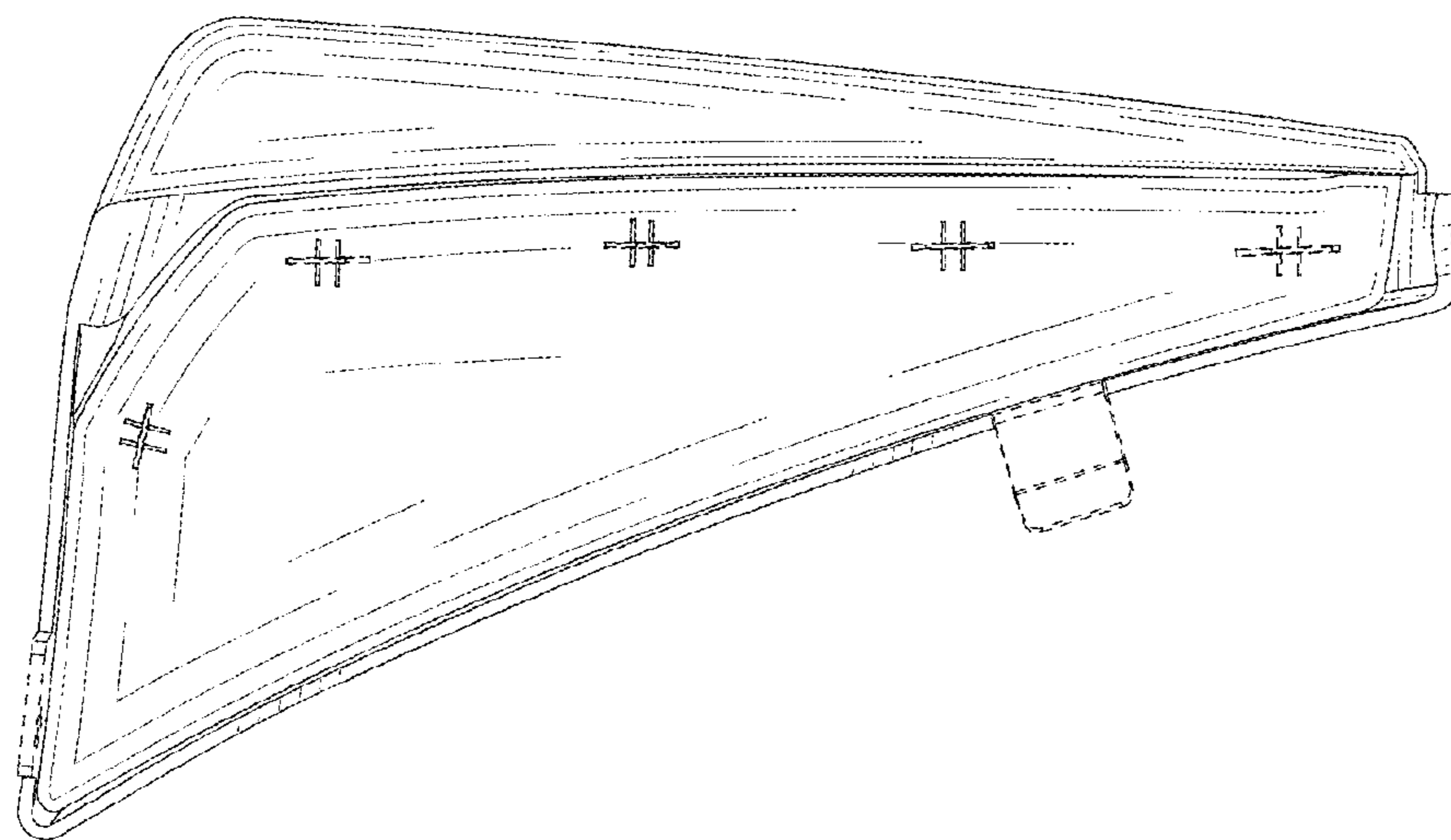

FIG. 6

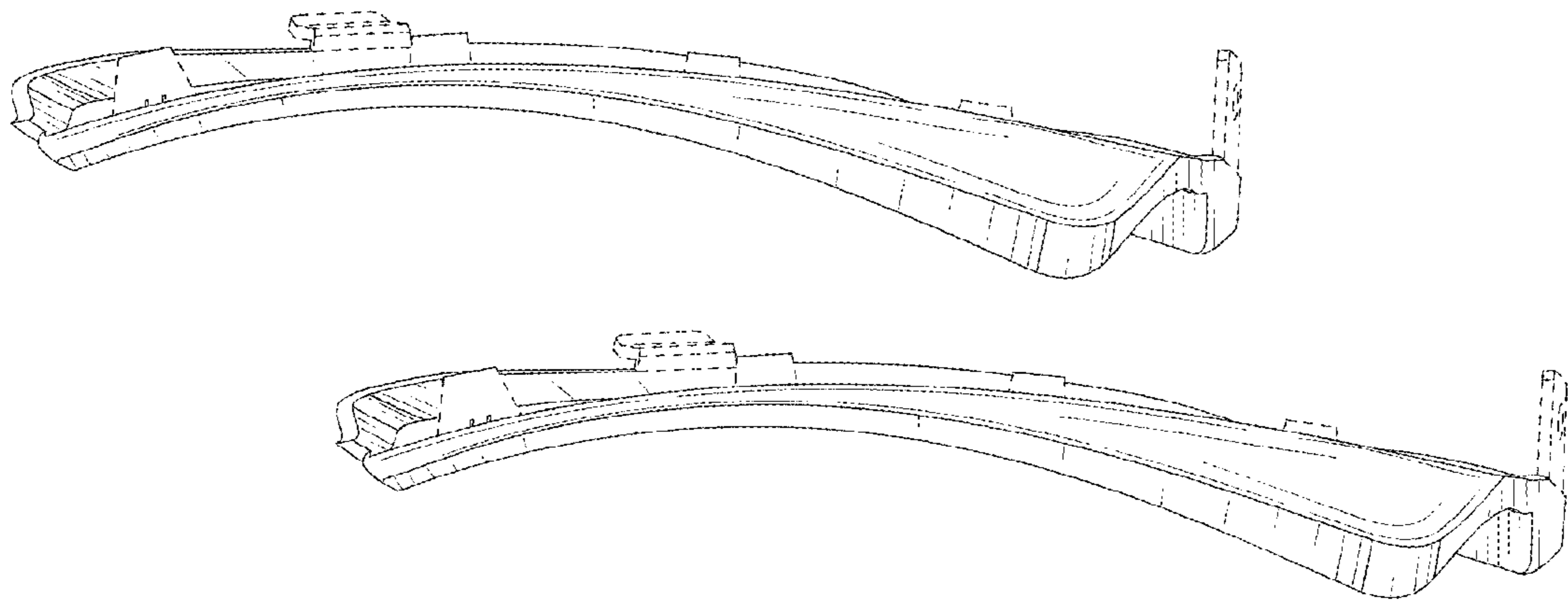
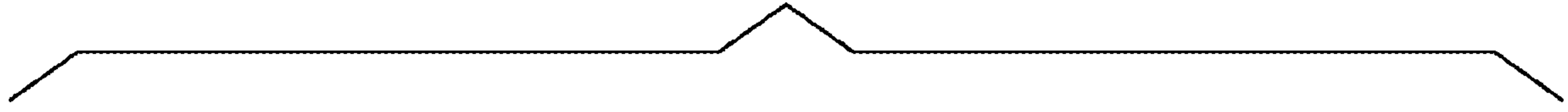

FIG. 7

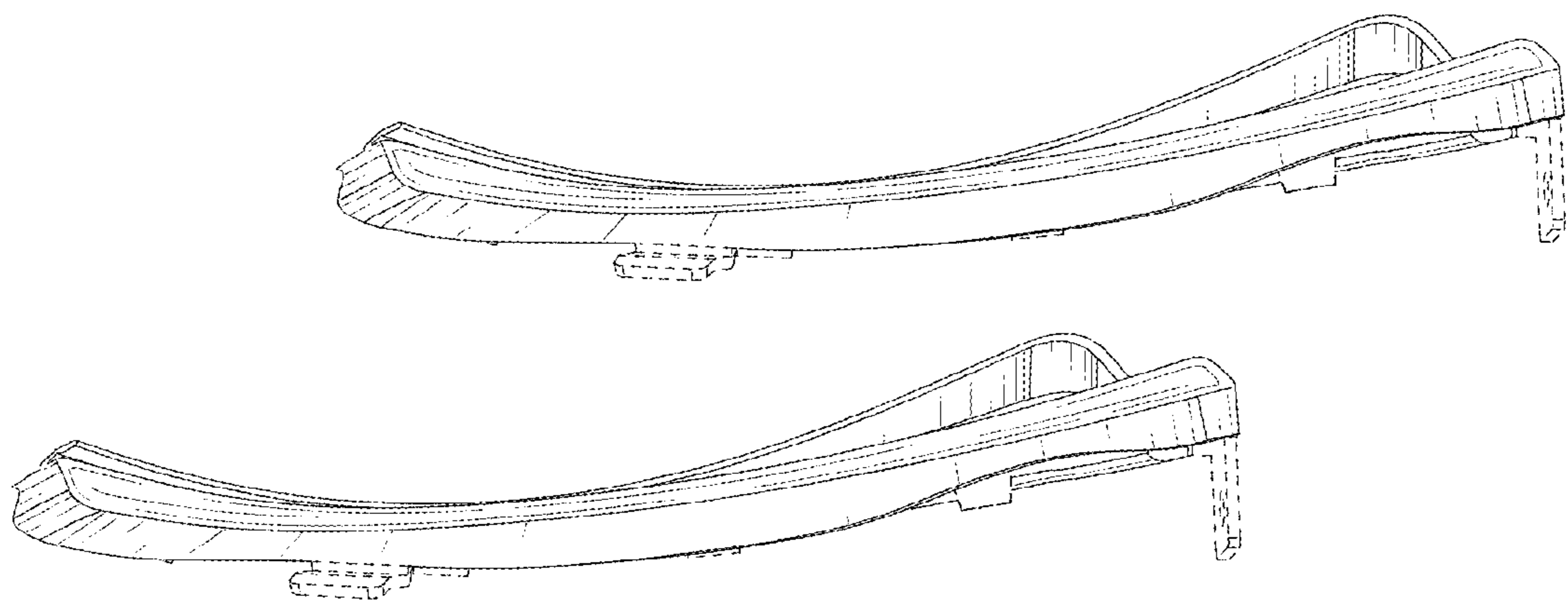
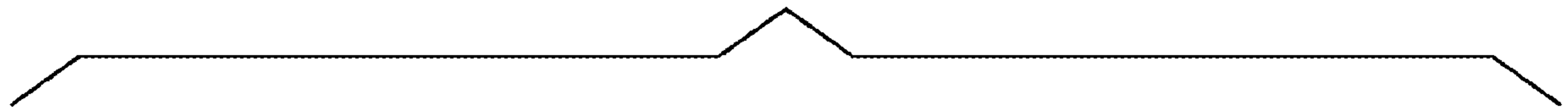

FIG. 8

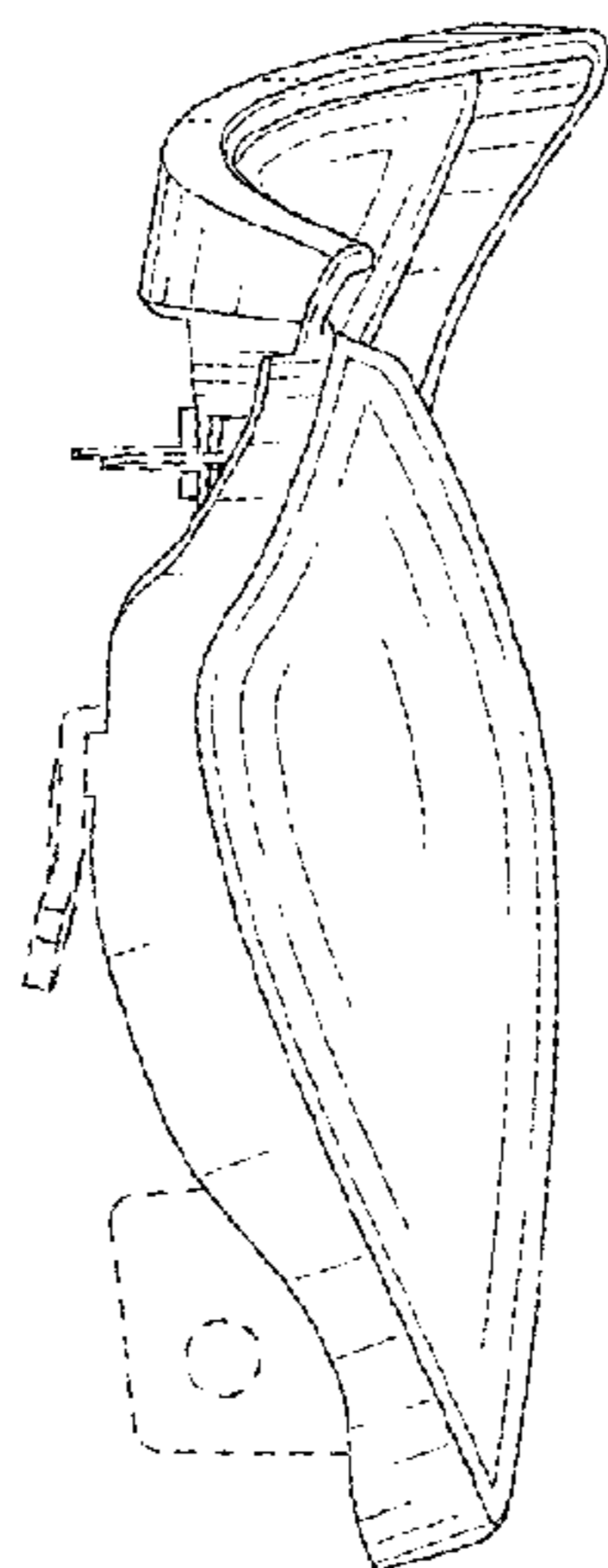
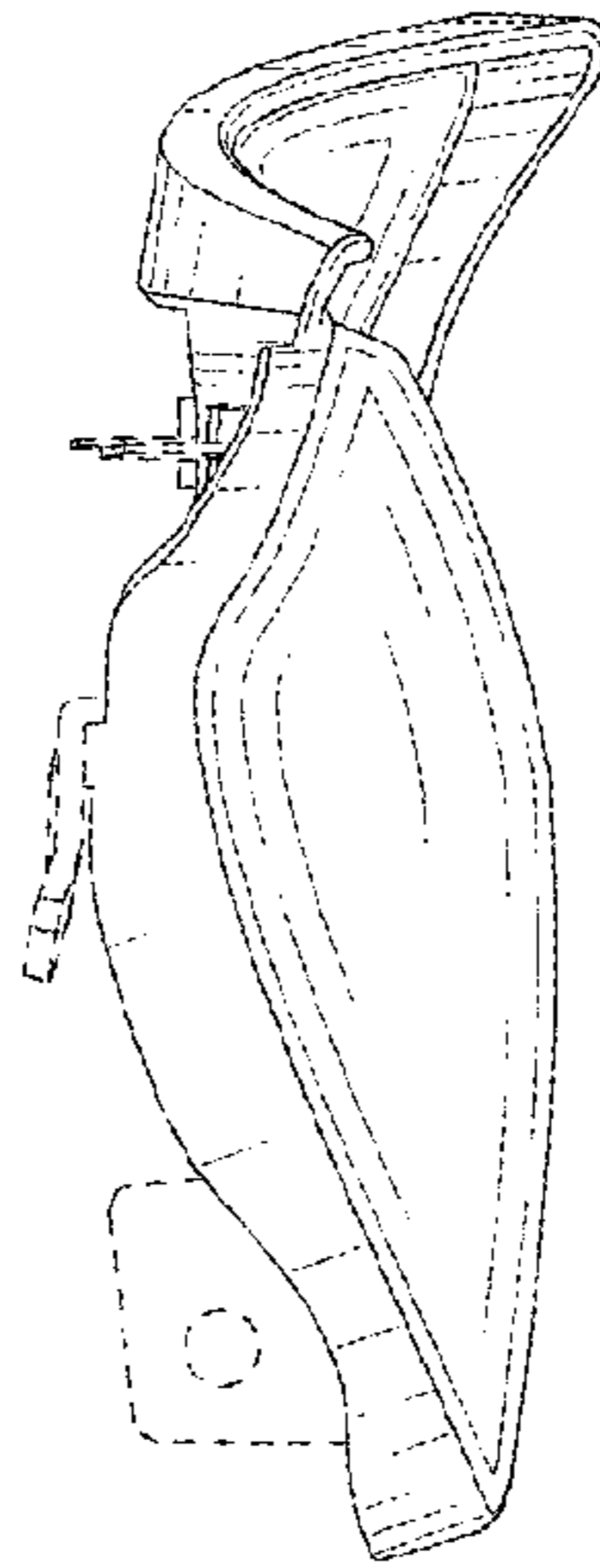

FIG. 9

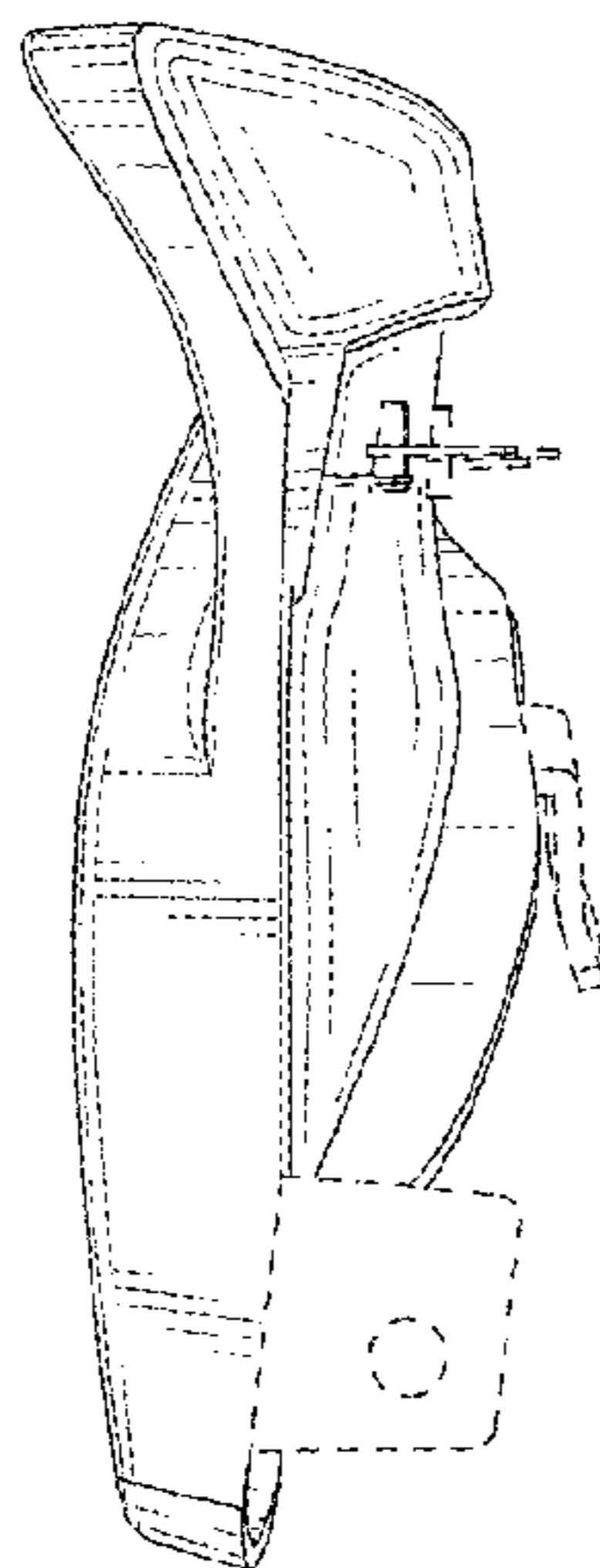
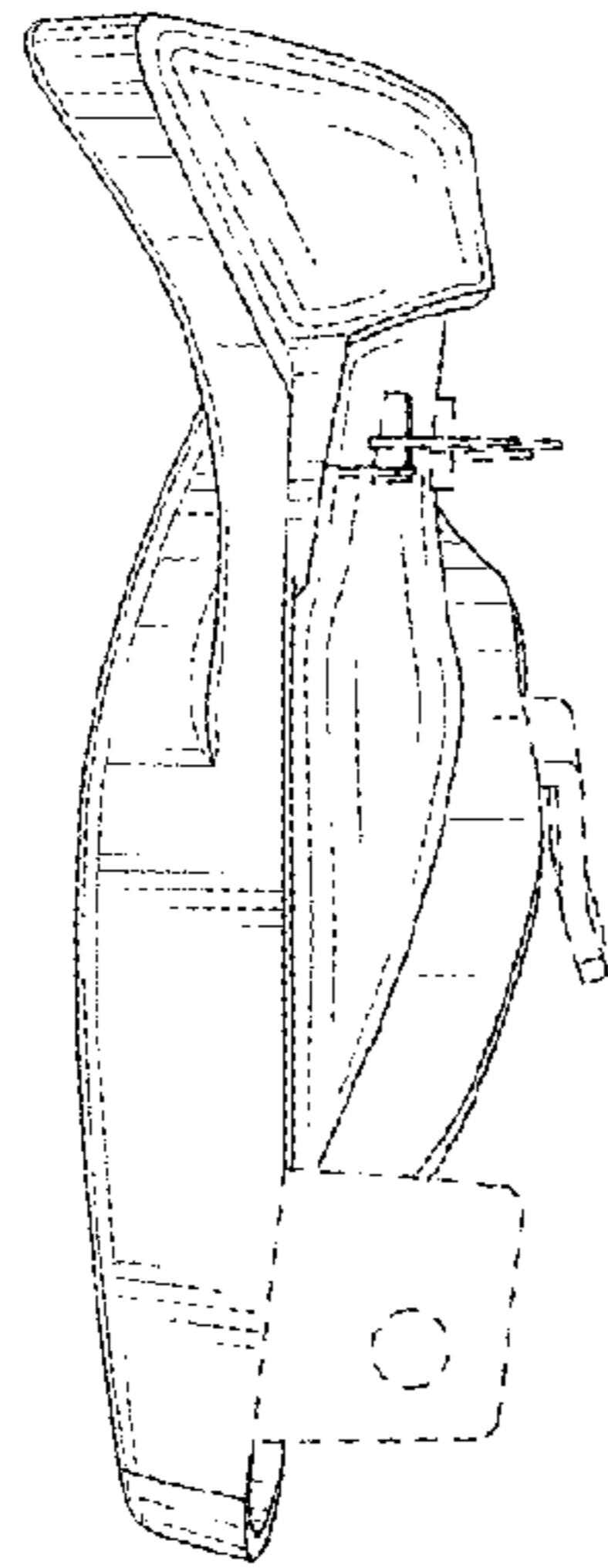

FIG. 10