



US0D1010074S

(12) **United States Design Patent** (10) **Patent No.:** **US D1,010,074 S**  
**Tanenbaum** (45) **Date of Patent:** **\*\* Jan. 2, 2024**

(54) **GUTTER COVER**  
(71) Applicant: **Israel Joshua Tanenbaum**, Los Angeles, CA (US)  
(72) Inventor: **Israel Joshua Tanenbaum**, Los Angeles, CA (US)  
(\*\*) Term: **15 Years**  
(21) Appl. No.: **29/730,918**  
(22) Filed: **Apr. 9, 2020**  
(51) **LOC (14) Cl.** ..... **23-01**  
(52) **U.S. Cl.**  
USPC ..... **D23/267**  
(58) **Field of Classification Search**  
USPC ..... D23/267, 259  
CPC . E04D 13/076; E04D 13/064; E04D 13/0762;  
E04D 13/103; E04D 13/04  
See application file for complete search history.

(56) **References Cited**  
U.S. PATENT DOCUMENTS  
D314,235 S \* 1/1991 Stuart ..... D23/267  
5,181,350 A \* 1/1993 Meckstroth ..... E04D 13/076  
52/12  
5,842,311 A 12/1998 Morin  
D416,079 S \* 11/1999 Hallett, II ..... D23/267  
D425,605 S \* 5/2000 Palmisano ..... D23/267  
6,951,077 B1 10/2005 Higginbotham  
D523,538 S \* 6/2006 Brochu ..... D23/267  
D559,957 S \* 1/2008 Rasmussen ..... D23/267  
RE43,555 E 7/2012 Higginbotham  
D683,827 S \* 6/2013 Ealer, Sr. .... D23/267  
D770,602 S \* 11/2016 Ealer, Sr. .... D23/267  
9,938,722 B1 4/2018 Voress  
D853,536 S \* 7/2019 Cullen ..... D23/267  
D923,760 S \* 6/2021 Graves ..... D23/267  
2006/0107603 A1 5/2006 Brownridge

2007/0169423 A1\* 7/2007 Brochu ..... E04D 13/076  
52/12  
2009/0025303 A1\* 1/2009 Gramling ..... E04D 13/076  
248/48.1  
2022/0356708 A1\* 11/2022 Brochu ..... E04D 13/076

FOREIGN PATENT DOCUMENTS  
AU 2010100555 B4 11/2010

OTHER PUBLICATIONS  
Clean Screen Leaf & Debris Filtration Device, Gutter Guard That is Inexpensive, Very Strong; Video on YouTube Frame 0:27/0:51; Published May 21, 2020; Visited Online Mar. 14, 2023; <https://www.youtube.com/watch?v=REL9kdttd4ZA> (Year: 2021).  
A Plus Gutter Systems Seamless Rain Gutters & Sheet Metal Website; Internet Archive WayBack Machine Earliest Date Feb. 14, 2013; Visited Online Mar. 14, 2023; <https://www.gutter4u.com/index.html#> (Year: 2013).\*

\* cited by examiner  
*Primary Examiner* — Amy C Wierenga

(57) **CLAIM**  
The ornamental design for a gutter cover, as shown and described.

**DESCRIPTION**  
FIG. 1 is a front top left perspective view of a gutter cover; FIG. 2 is a rear bottom right perspective view thereof; FIG. 3 is a front elevational view thereof; FIG. 4 is a rear elevational view thereof; FIG. 5 is a top plan view thereof; FIG. 6 is a bottom plan view thereof; FIG. 7 is a right elevational view thereof; and, FIG. 8 is a left elevational view thereof.  
The gutter cover is shown with a symbolic break in its length. The appearance of any portion of the article between the break lines forms no part of the claimed design.

**1 Claim, 8 Drawing Sheets**

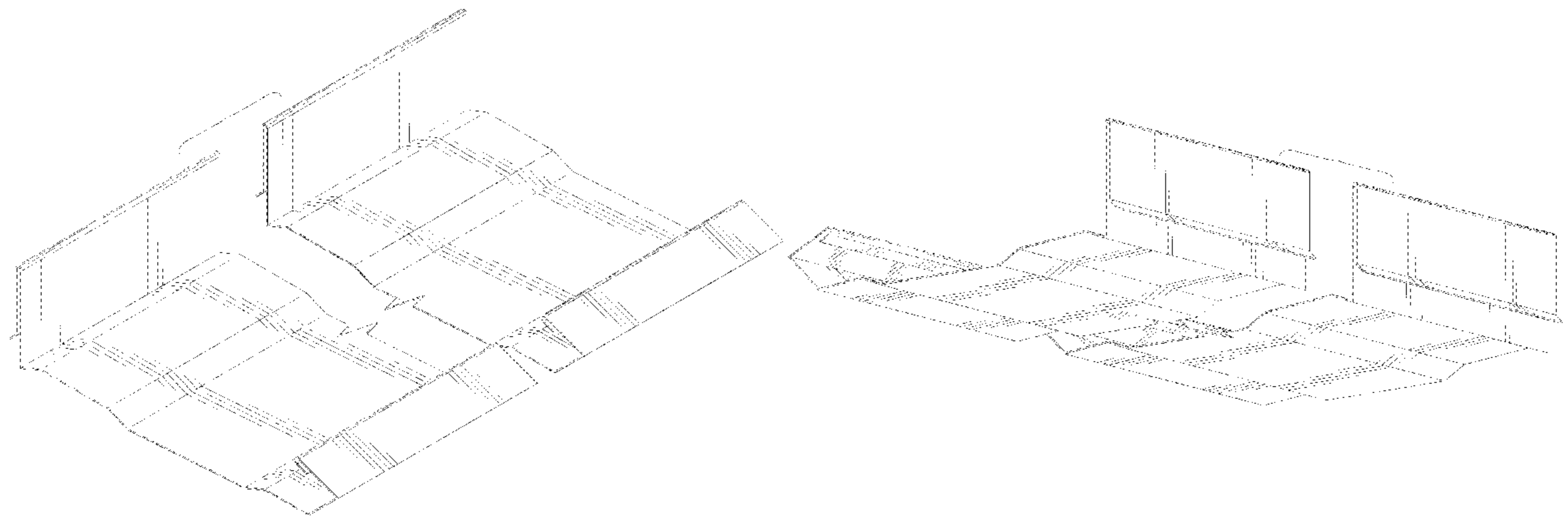

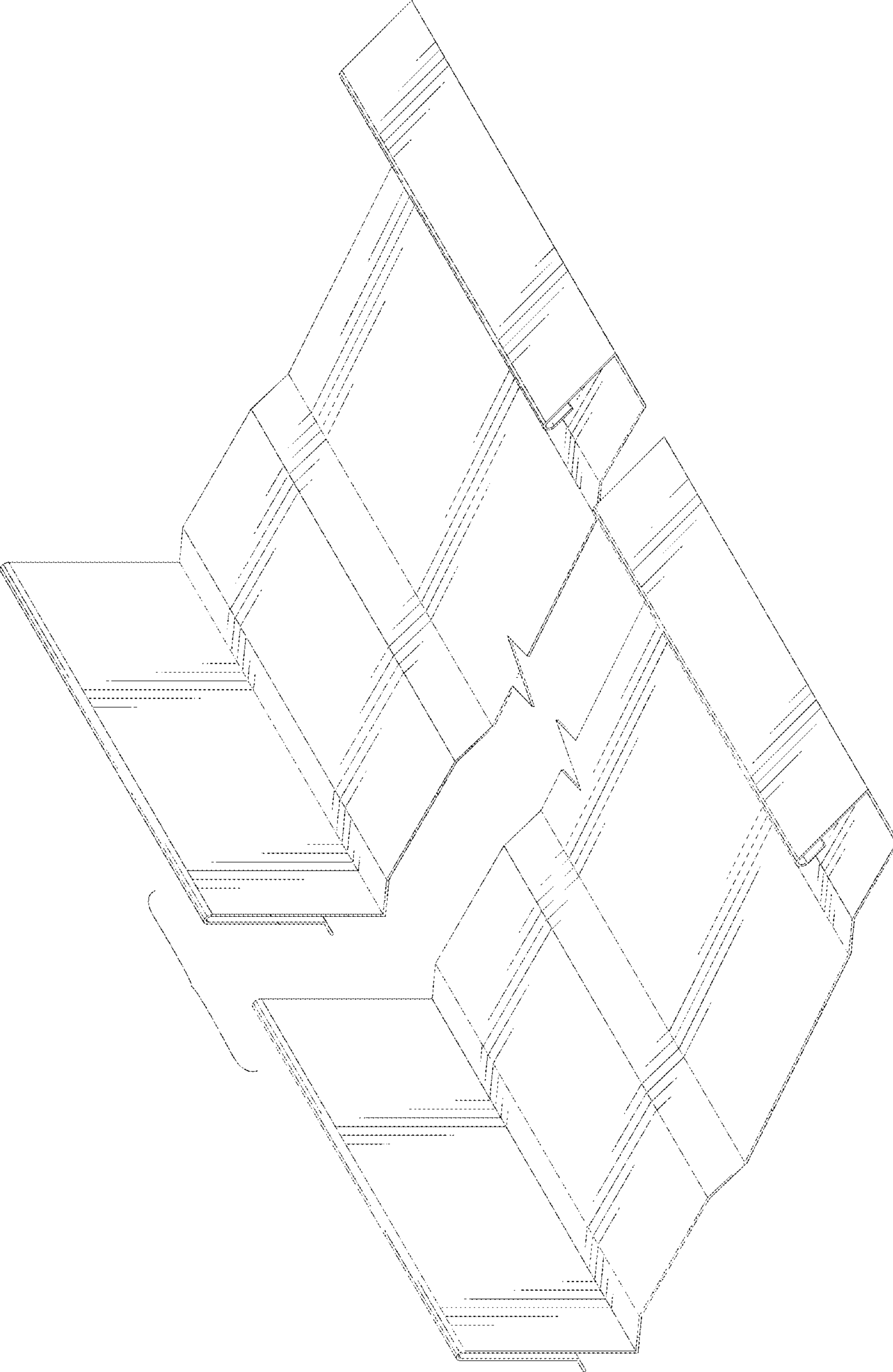

FIG. 1

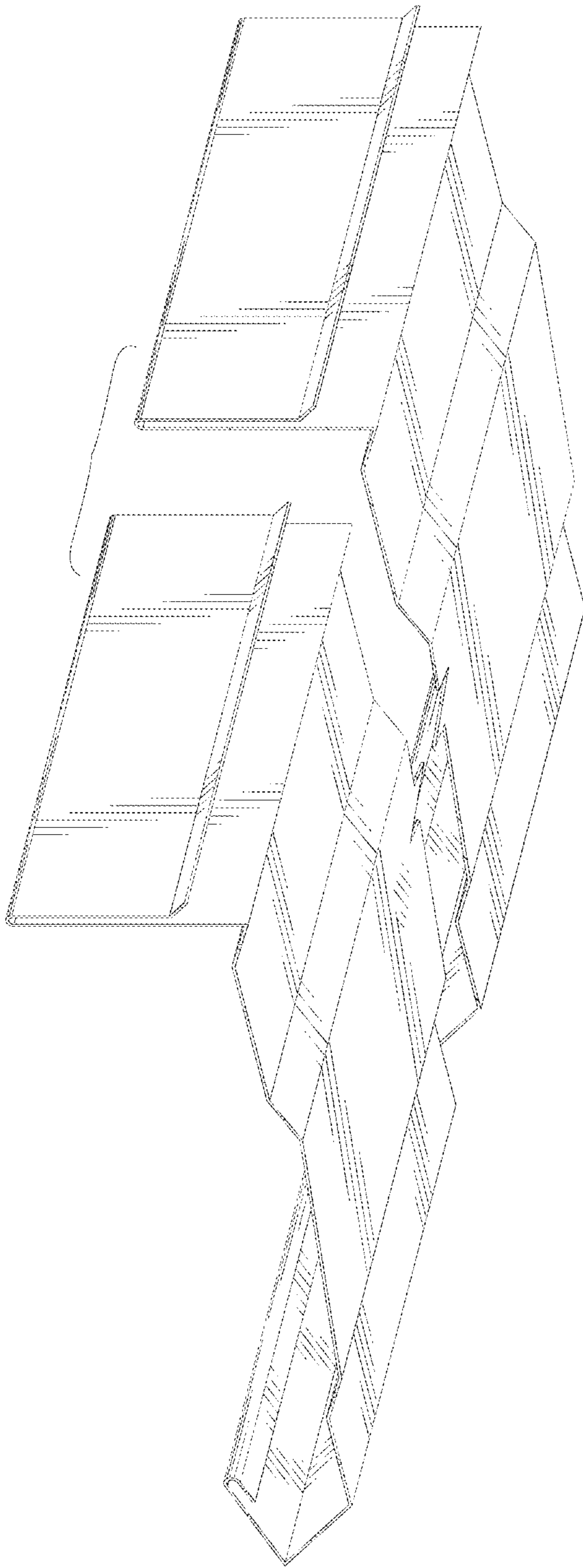

FIG. 2

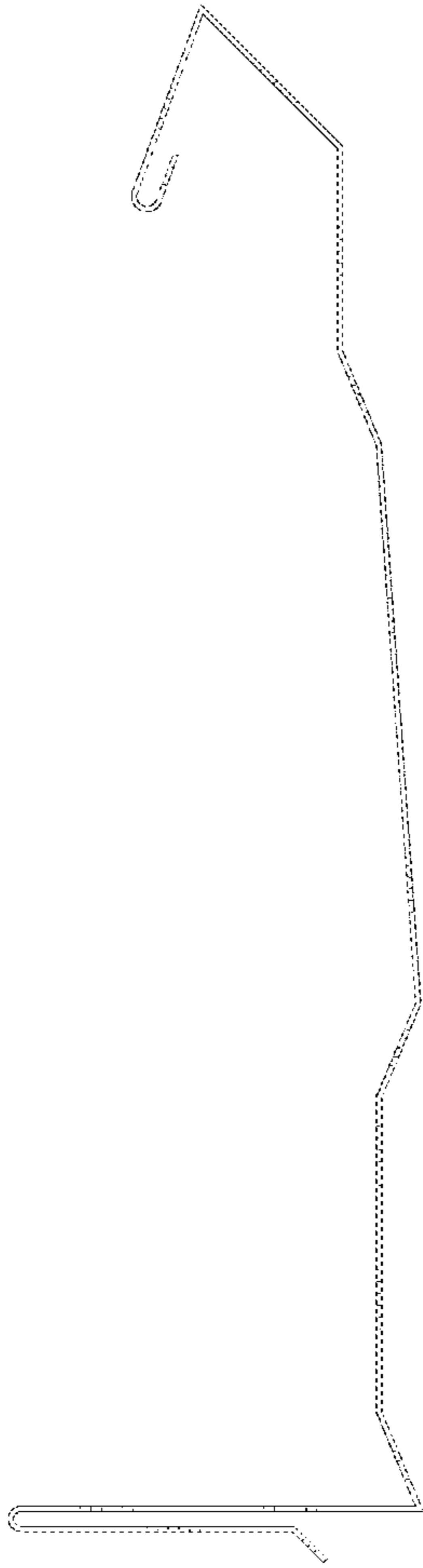

FIG. 3

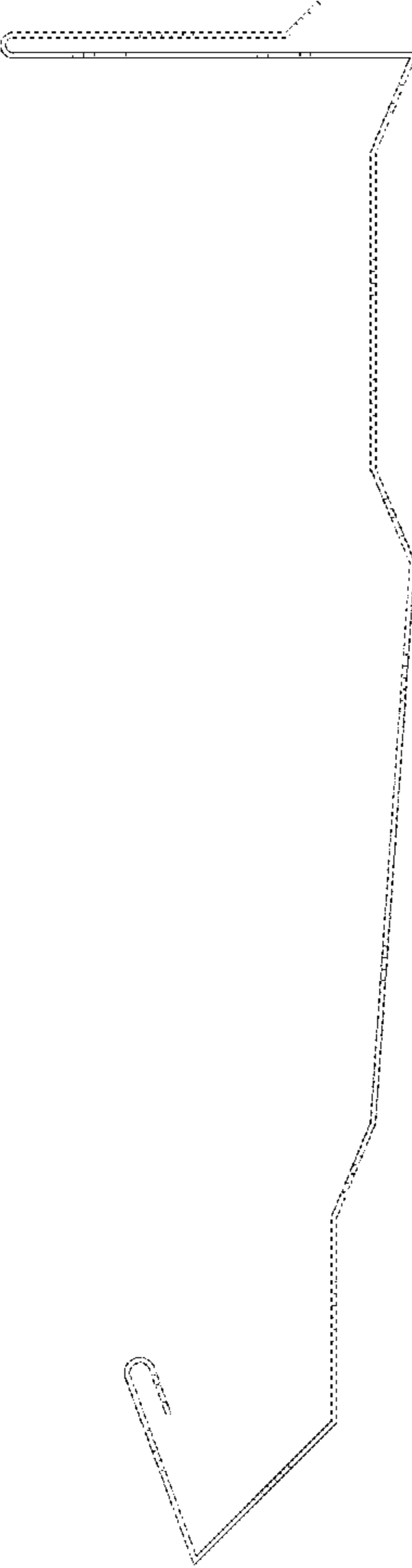

FIG. 4

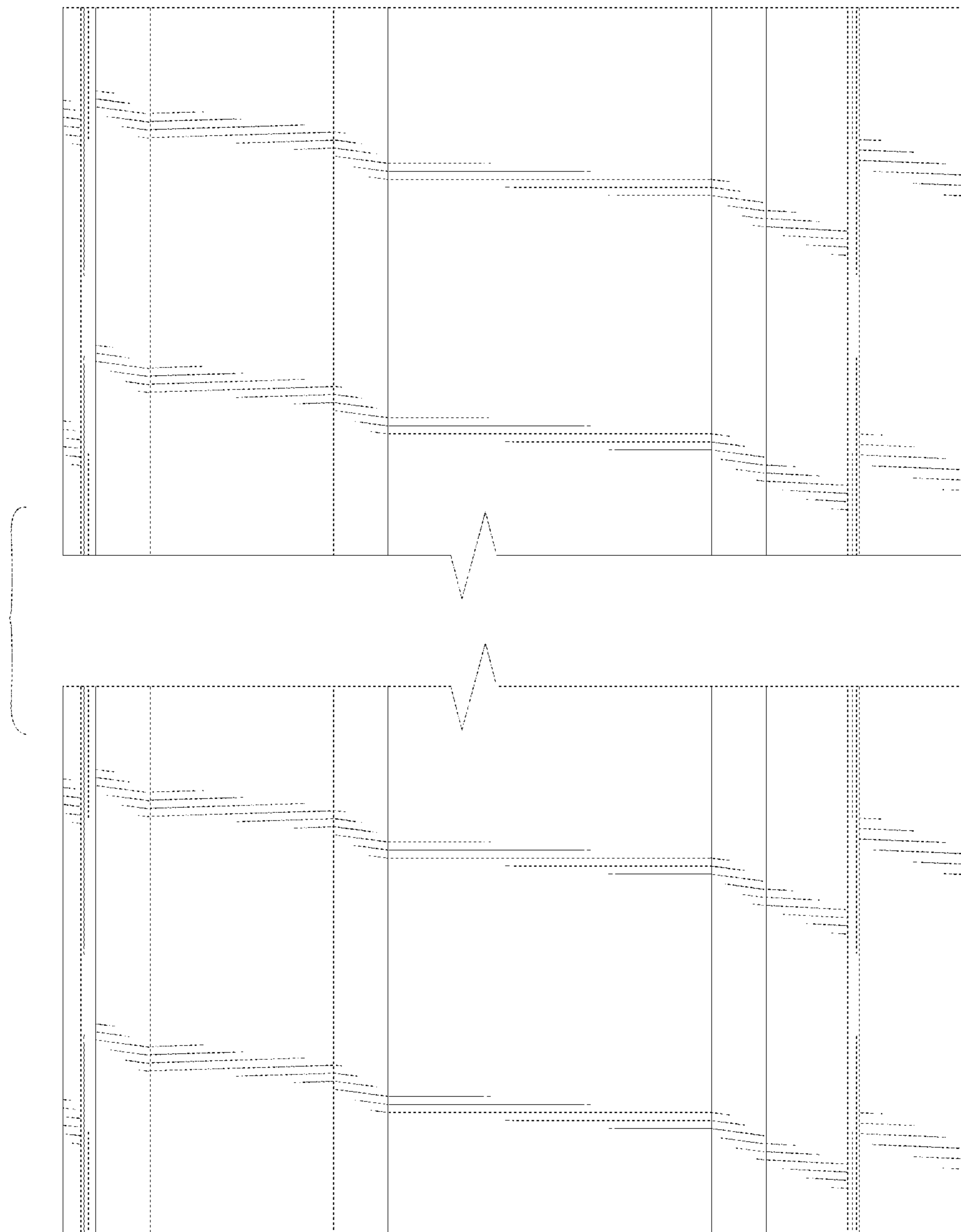

FIG. 5

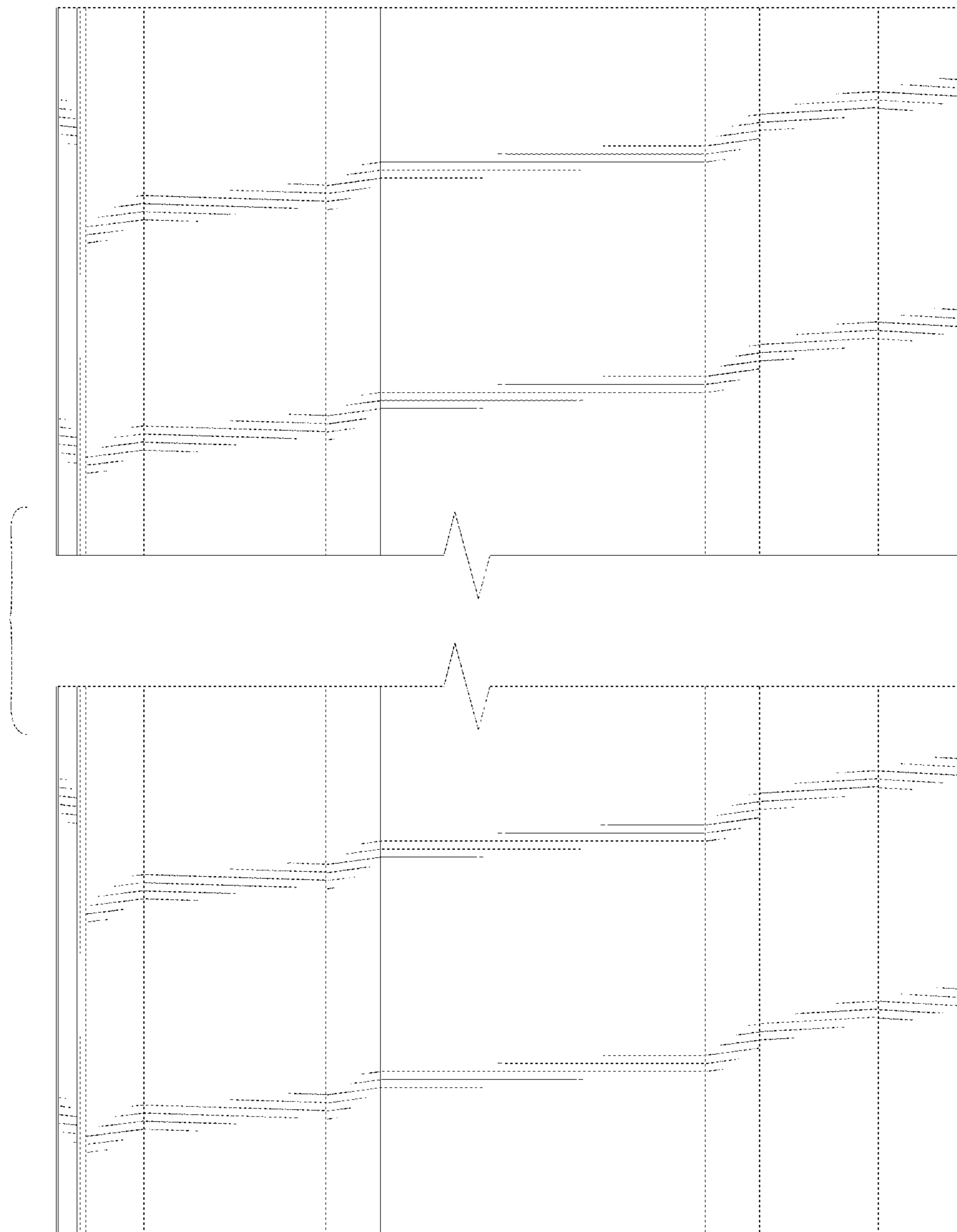

FIG. 6

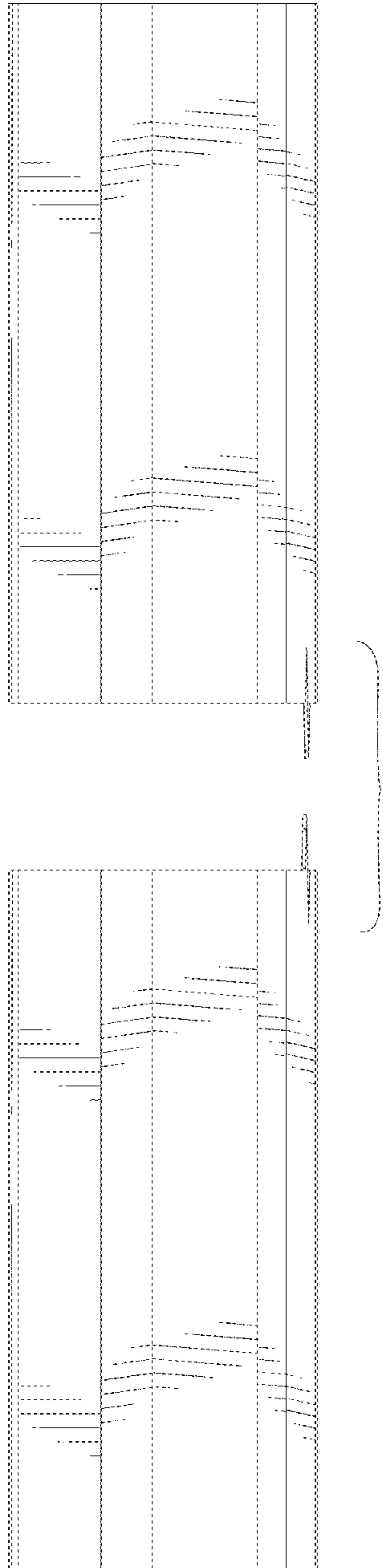

FIG. 7



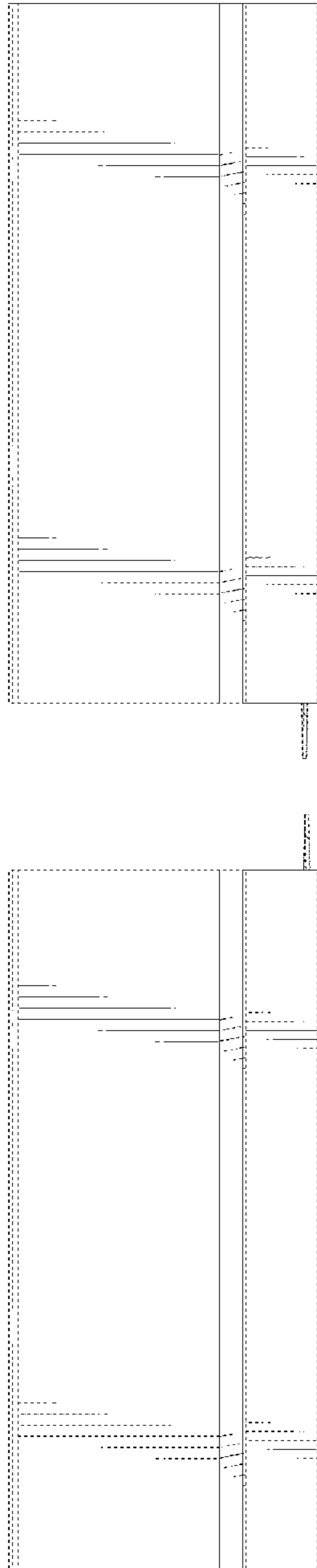

FIG. 8