



US0D1007239S

(12) **United States Design Patent** (10) **Patent No.:** **US D1,007,239 S**  
**Ott et al.** (45) **Date of Patent:** **\*\* Dec. 12, 2023**

(54) **LIQUID AND STEAM SEPARATOR**

(71) Applicant: **Voith Patent GmbH**, Heidenheim (DE)

(72) Inventors: **Elmar Ott**, Ravensburg (DE); **Sven Eisenhauer**, Bad Wurzach (DE)

(\*\*) Term: **15 Years**

(21) Appl. No.: **35/515,501**

(22) Filed: **Sep. 26, 2022**

(80) **Hague Agreement Data**

Int. Filing Date: **Sep. 26, 2022**

Int. Reg. No.: **DM/224257**

Int. Reg. Date: **Sep. 26, 2022**

Int. Reg. Pub. Date: **Oct. 28, 2022**

(51) **LOC (14) Cl.** ..... **31-00**

(52) **U.S. Cl.**  
USPC ..... **D7/412; D7/372; D7/376; D7/378; D7/384**

(58) **Field of Classification Search**

USPC ..... **D7/372, 376-386, 412-413, 590, 602, D7/629, 630, 665-666, 669, 679, D7/693-694**

CPC .... **A21C 1/02; A21C 1/04; A23N 1/00; A23N 1/02; A47J 43/04; A47J 43/25; A47J 43/27; A47J 43/28; A47J 43/042; A47J 43/044; A47J 43/046; A47J 43/075; A47J 43/0716; A47J 43/0722; A47J 43/0727; A47J**

(Continued)

(56) **References Cited**

**U.S. PATENT DOCUMENTS**

5,302,021 A \* 4/1994 Jennett ..... B01F 35/00 366/349

D383,643 S \* 9/1997 Mendenhall ..... D7/415

(Continued)

*Primary Examiner* — **Ricky Pham**

(57) **CLAIM**

The ornamental design for a liquid and steam separator, as shown and described.

**DESCRIPTION**

The patent or application file contains at least one drawing executed in color. Copies of this patent or patent application

publication with color drawing(s) will be provided by the Office upon request and payment of the necessary fee.

- 1. Liquid and steam separator
- 2. Liquid and steam separator
- 3. Liquid and steam separator
- 4. Liquid and steam separator
- 5. Liquid and steam separator

1.1: Front

1.2: Perspective

1.3: Top

1.4: Bottom

2.1: Front

2.2: Perspective

2.3: Top

2.4: Bottom

3.1: Front

3.2: Perspective

3.3: Top

3.4: Bottom

4.1: Front

4.2: Perspective

4.3: Top

4.4: Bottom

5.1: Front

5.2: Perspective

5.3: Top

5.4: Bottom

This design patent belongs to the field of cleaning systems for cleaning a suspension, especially suspensions containing fibers; the design patent is directed on a transparent cone element, wherein the cone element contains grooves or paint markings extending in direction of the narrowing cone.

**1 Claim, 20 Drawing Sheets**  
**(16 of 20 Drawing Sheet(s) Filed in Color)**

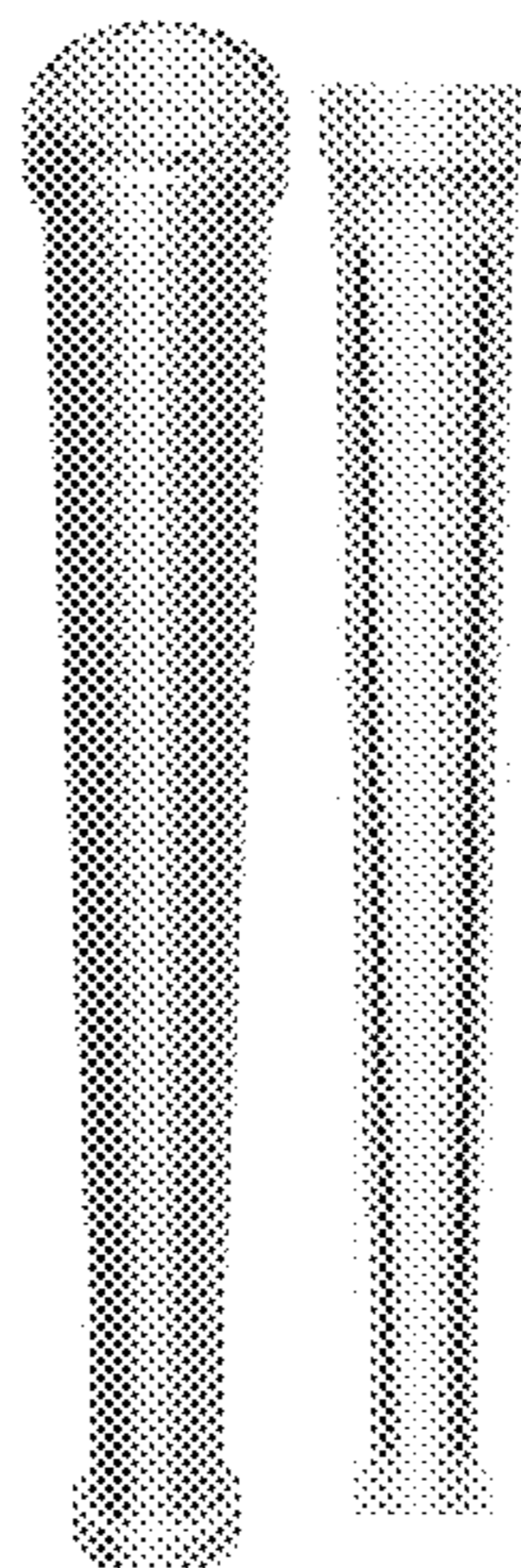

(58) **Field of Classification Search**

CPC ..... 43/0794; A47J 43/085; B01F 3/00; B01F  
3/0807; B01F 3/0853; B01F 13/0059;  
B01F 13/0064; B01F 35/00; B02C 1/08;  
B02C 2/04; B02C 4/42; B02C 4/142;  
B02C 4/143; B02C 4/423; B02C 13/1835;  
B26D 7/2628; B28C 5/10; B28C 5/12;  
B28C 5/14; B28C 5/16

See application file for complete search history.

(56) **References Cited**

U.S. PATENT DOCUMENTS

5,662,032 A \* 9/1997 Baratta ..... A47J 43/0722  
366/205  
D495,926 S \* 9/2004 Nikkhah ..... D7/412  
6,935,767 B2 \* 8/2005 Nikkhah ..... A47J 43/0794  
366/129  
7,040,799 B2 \* 5/2006 Pryor, Jr. .... A47J 43/0716  
366/205  
7,648,264 B2 \* 1/2010 Breviere ..... A47J 43/0716  
366/205  
8,172,454 B2 \* 5/2012 Choi ..... A47J 43/0716  
366/147  
D666,056 S \* 8/2012 Boozer ..... D7/378  
9,474,419 B2 \* 10/2016 Schneider ..... A47J 43/28  
D789,734 S \* 6/2017 Ayres ..... D7/378  
D969,552 S \* 11/2022 McConnell ..... D7/412  
11,503,958 B2 \* 11/2022 Miller ..... A47J 43/0716  
2010/0202244 A1 \* 8/2010 Choi ..... A47J 43/0716  
366/144

\* cited by examiner

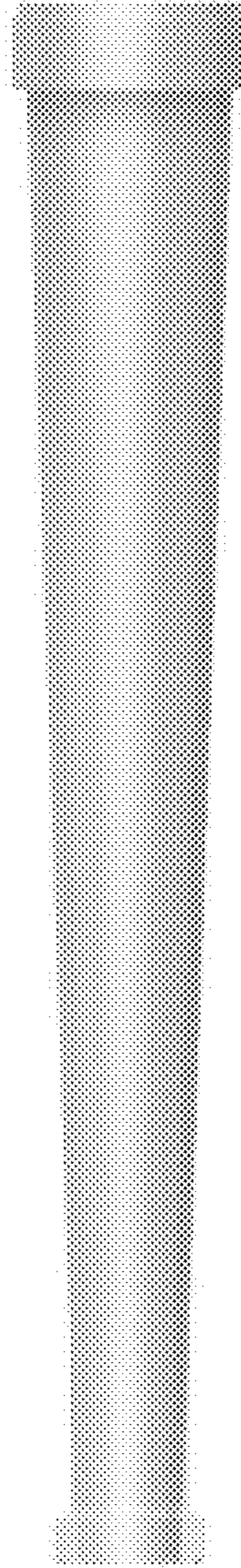

1.1

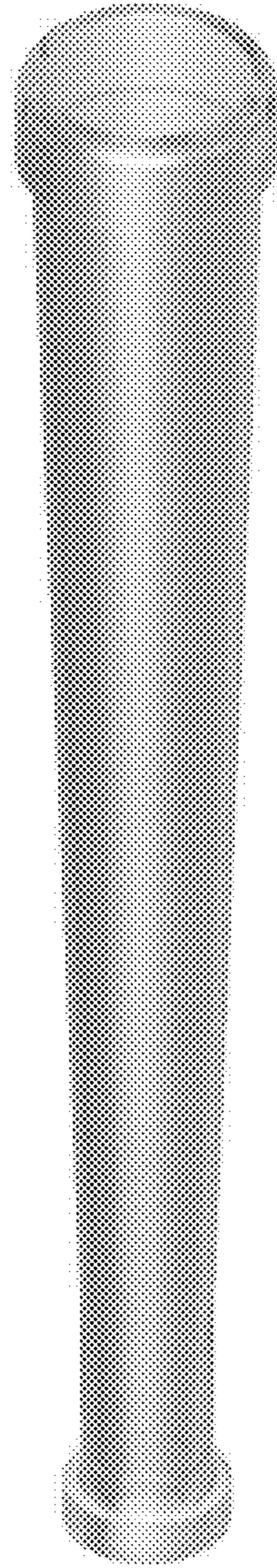

1.2

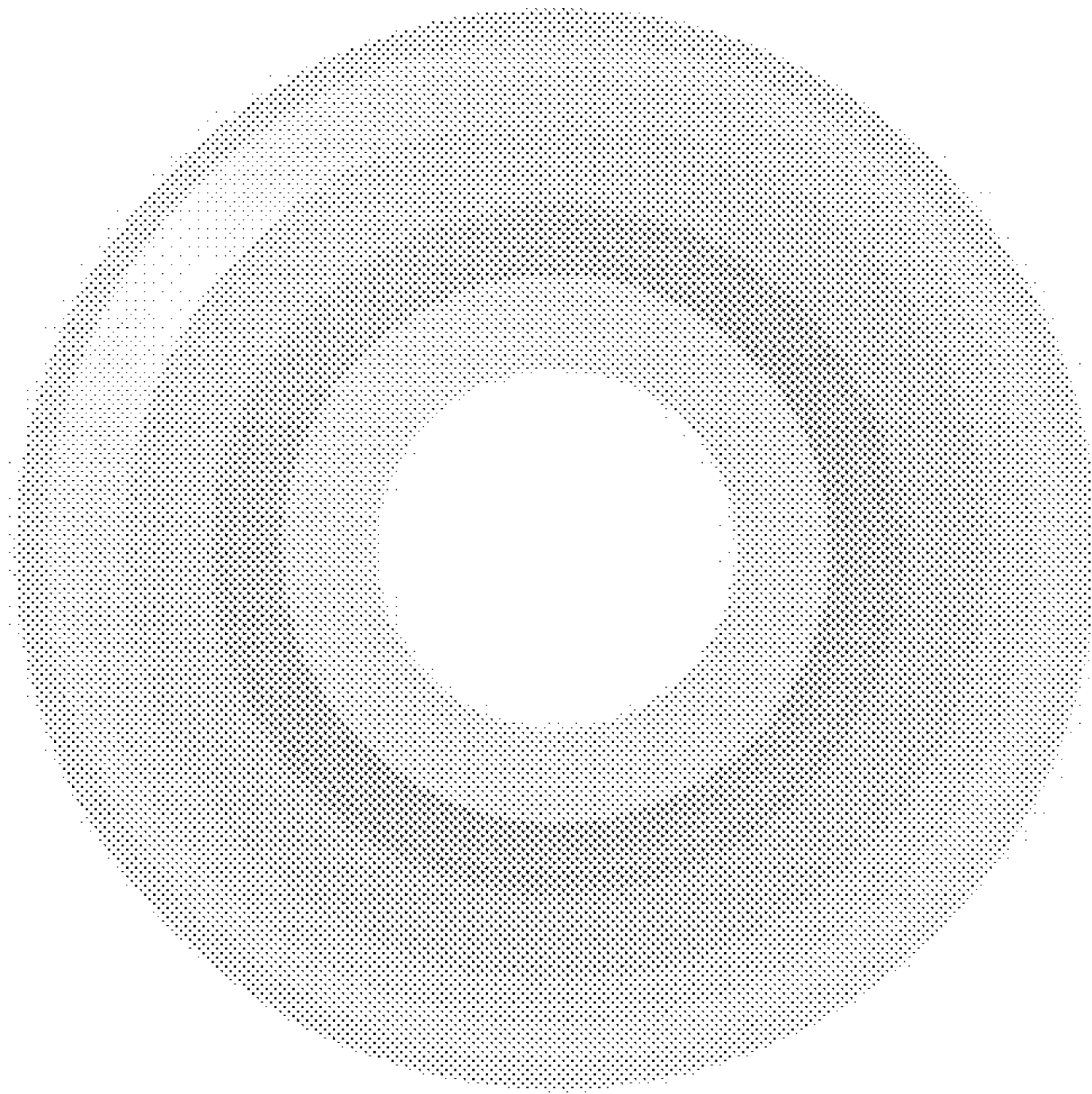

1.3

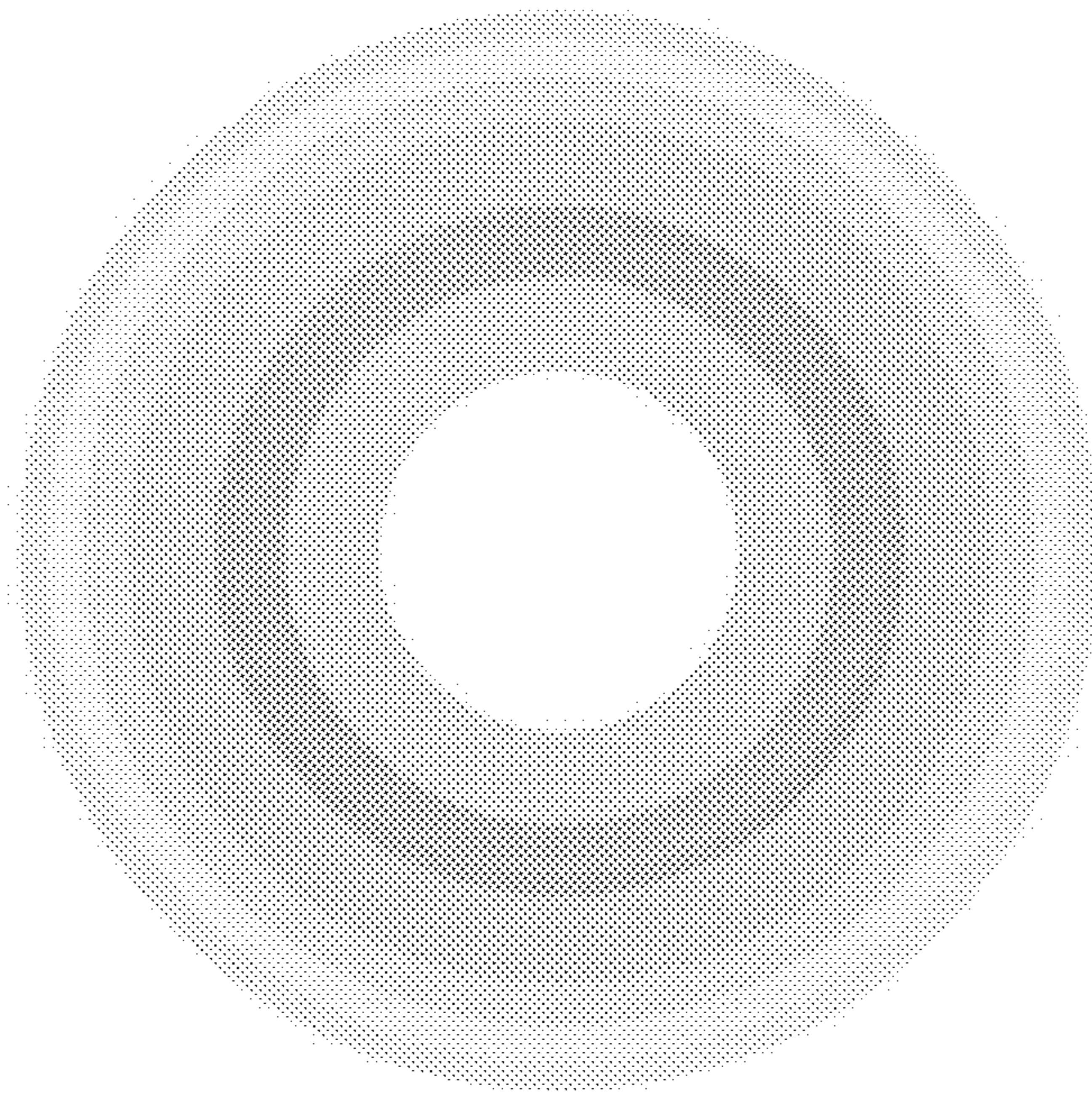

1.4

2.1

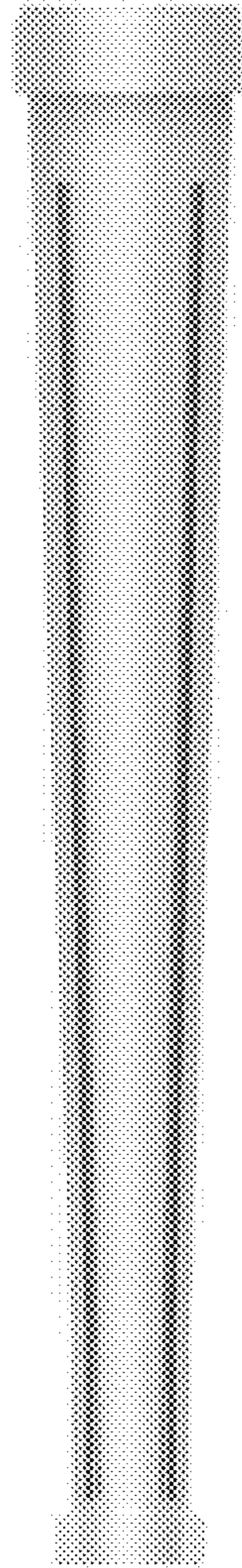

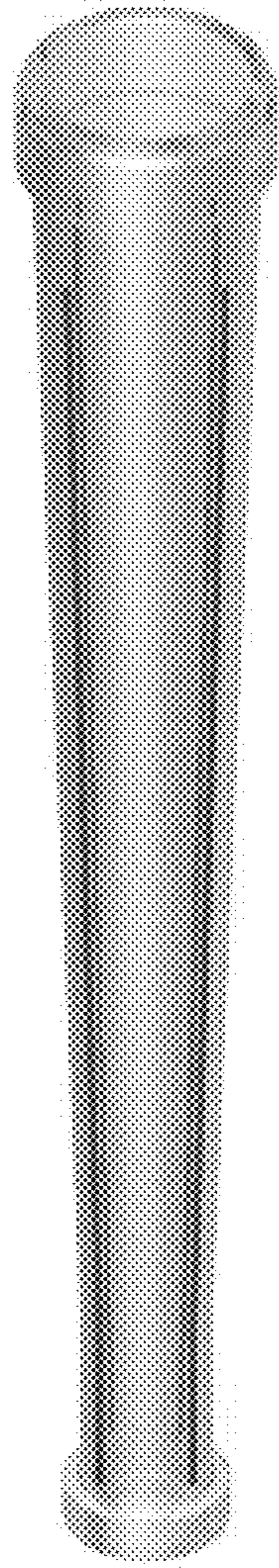

2.2



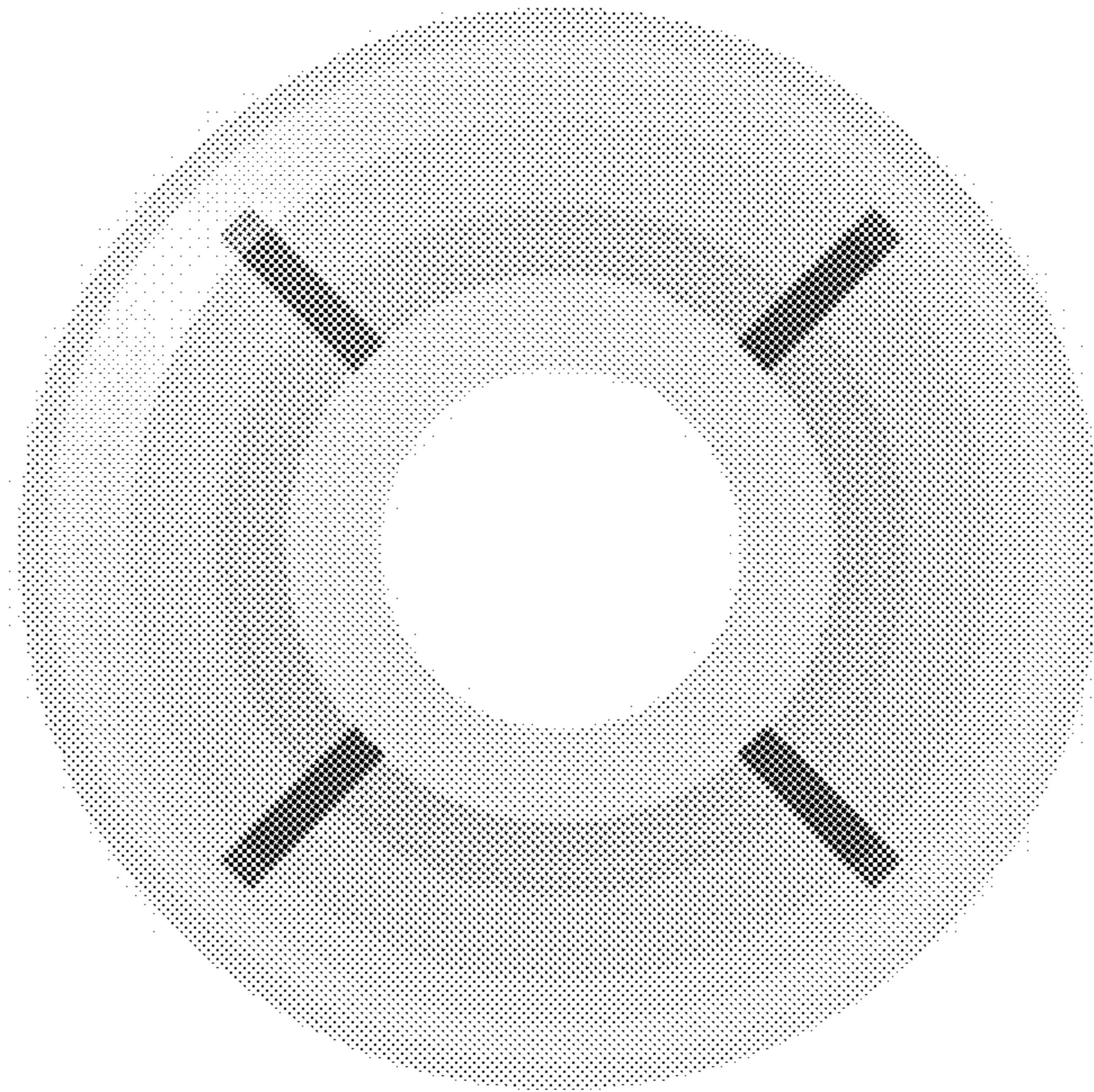

2.3

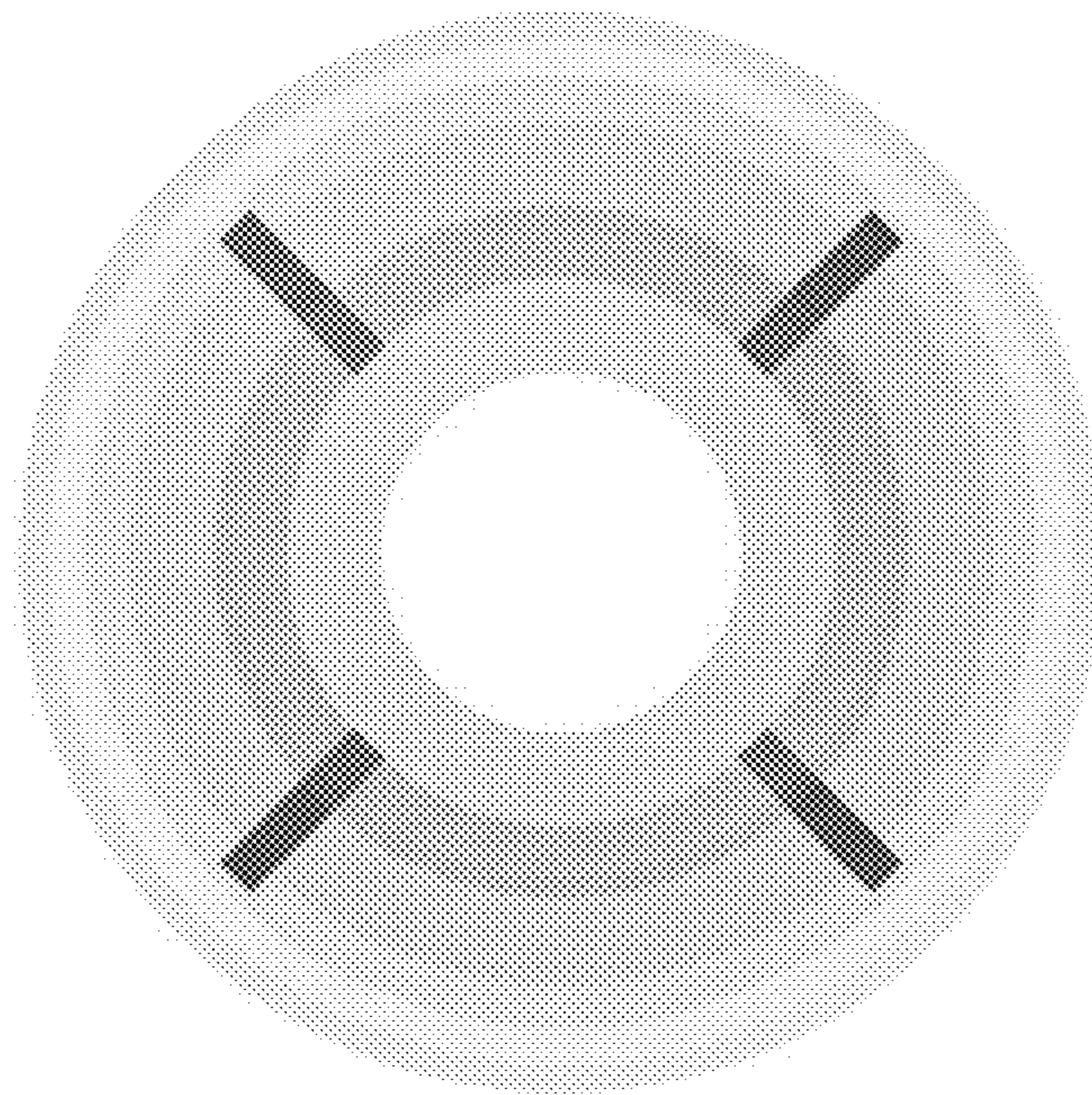

2.4

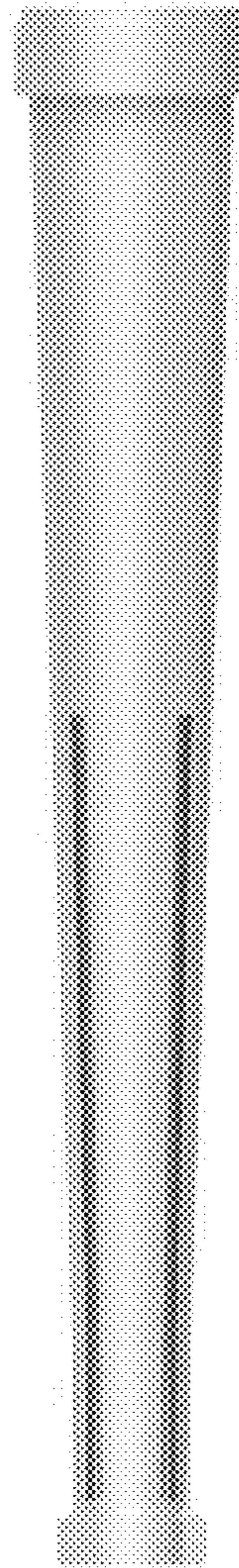

3.1

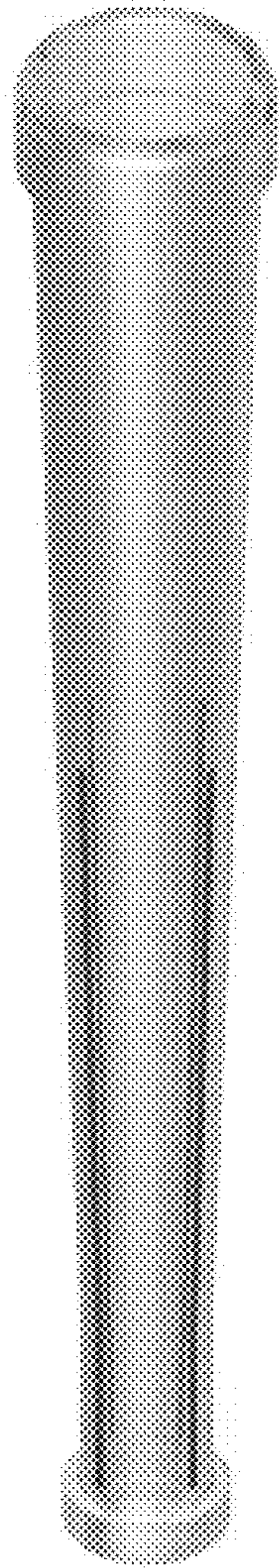

3.2

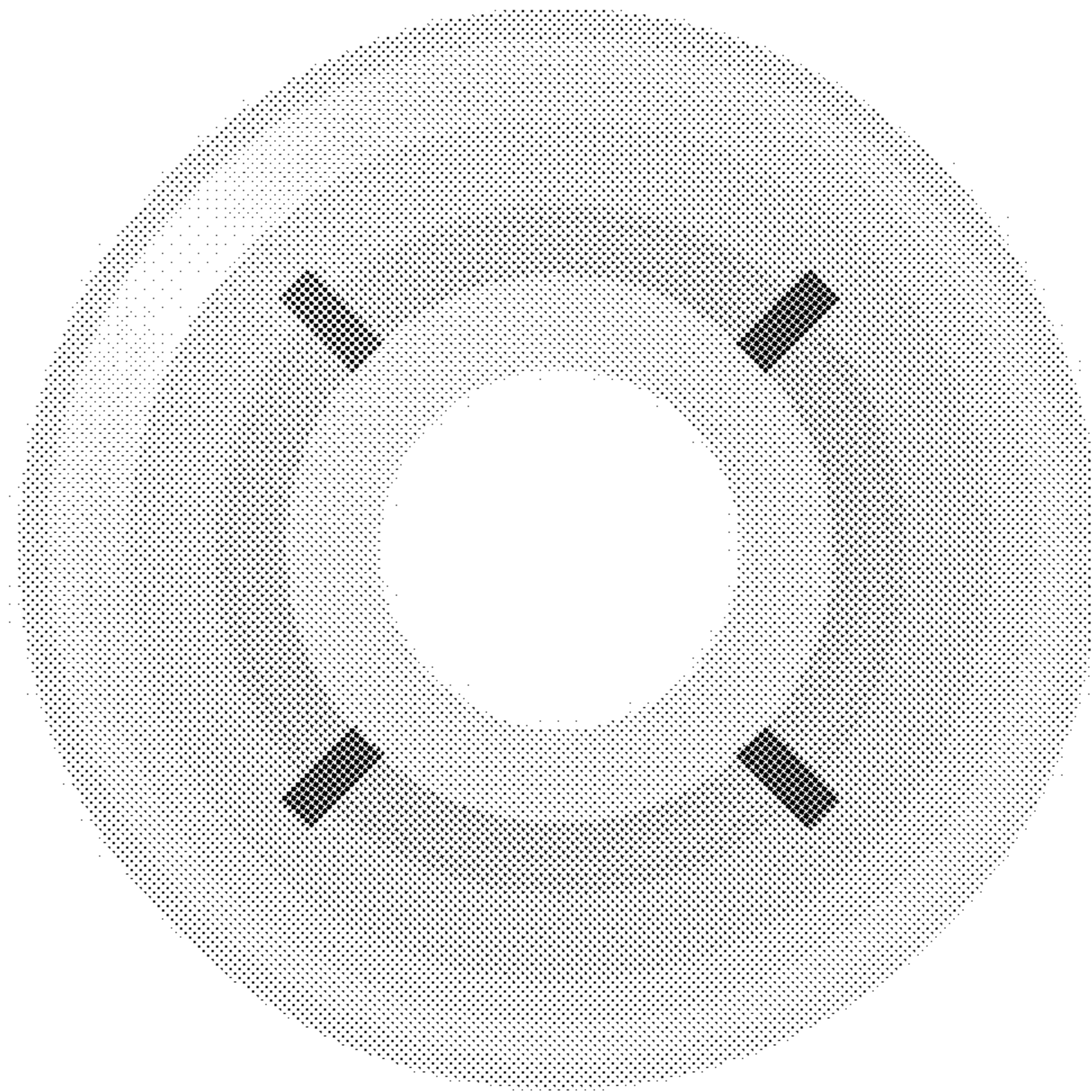

3.3

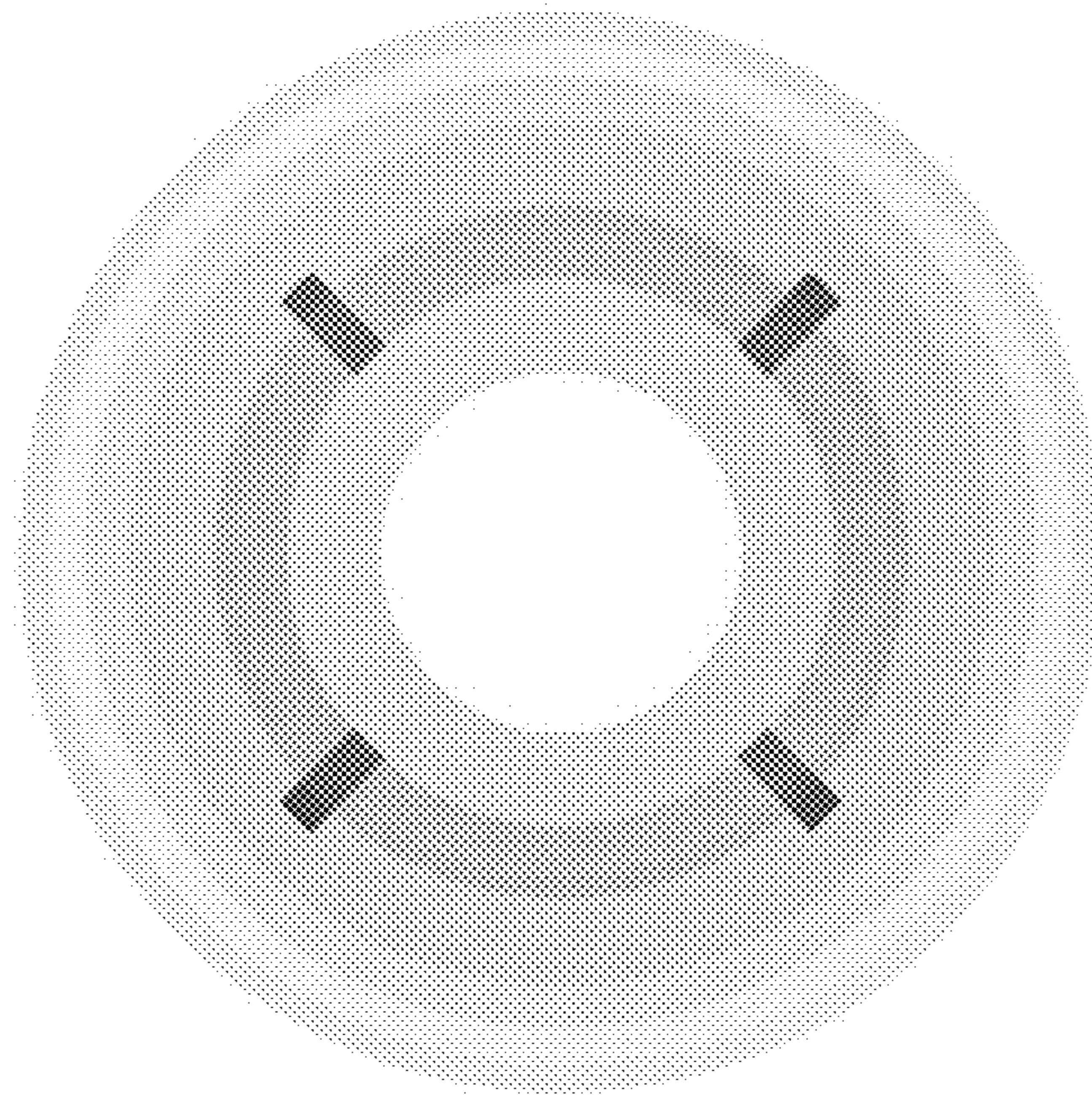

3.4

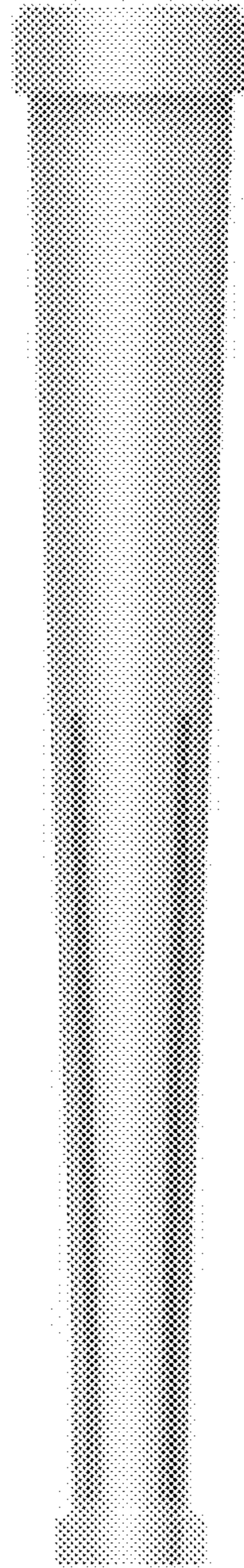

4.1

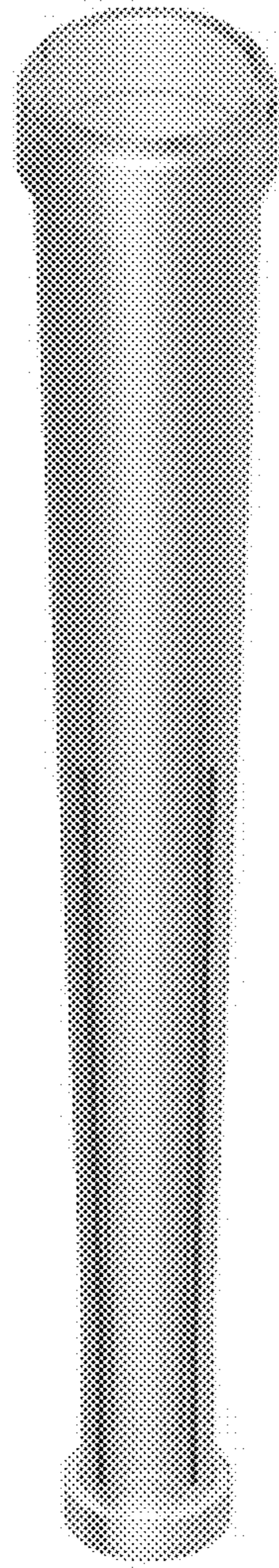

4.2



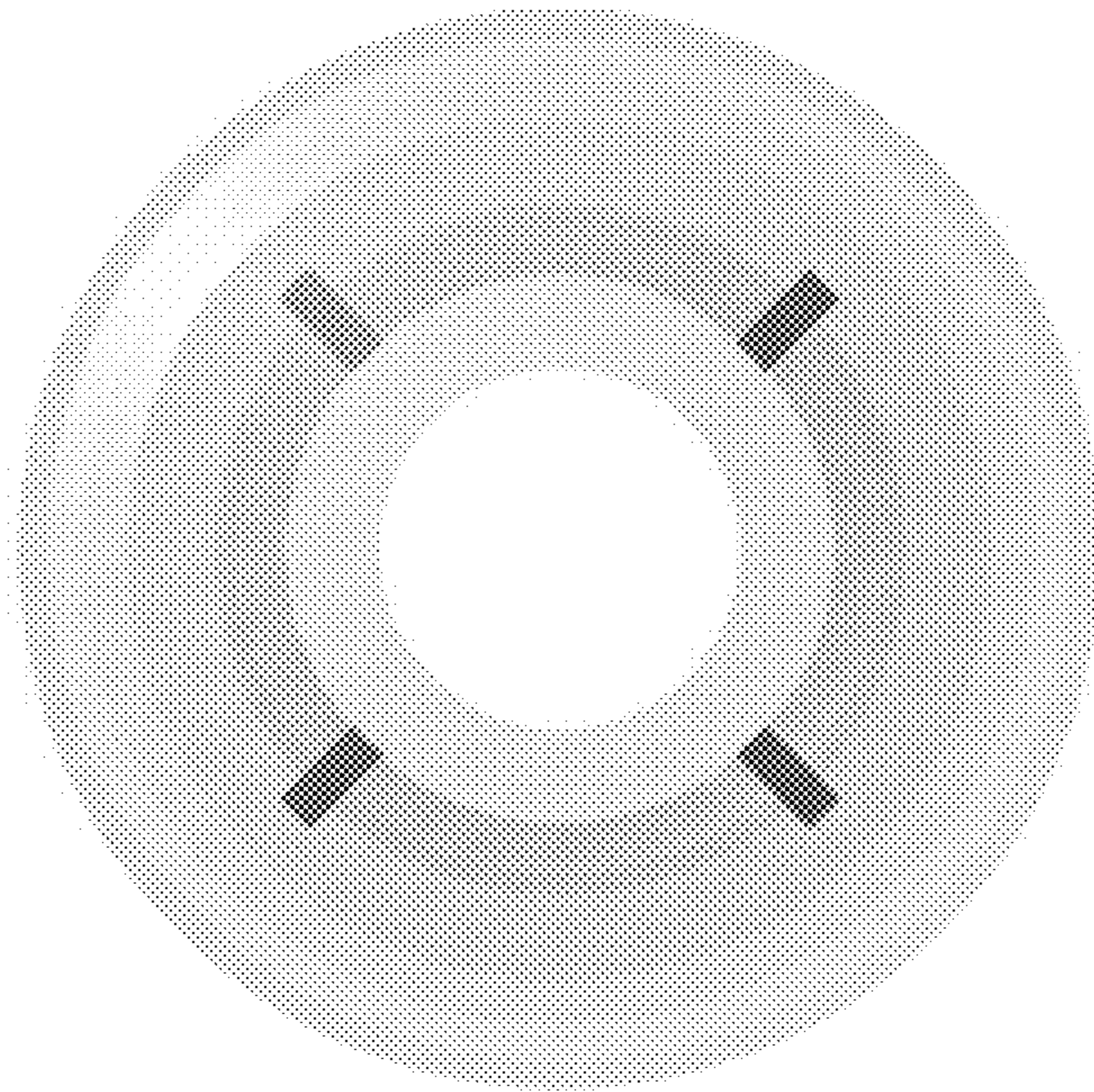

4.3

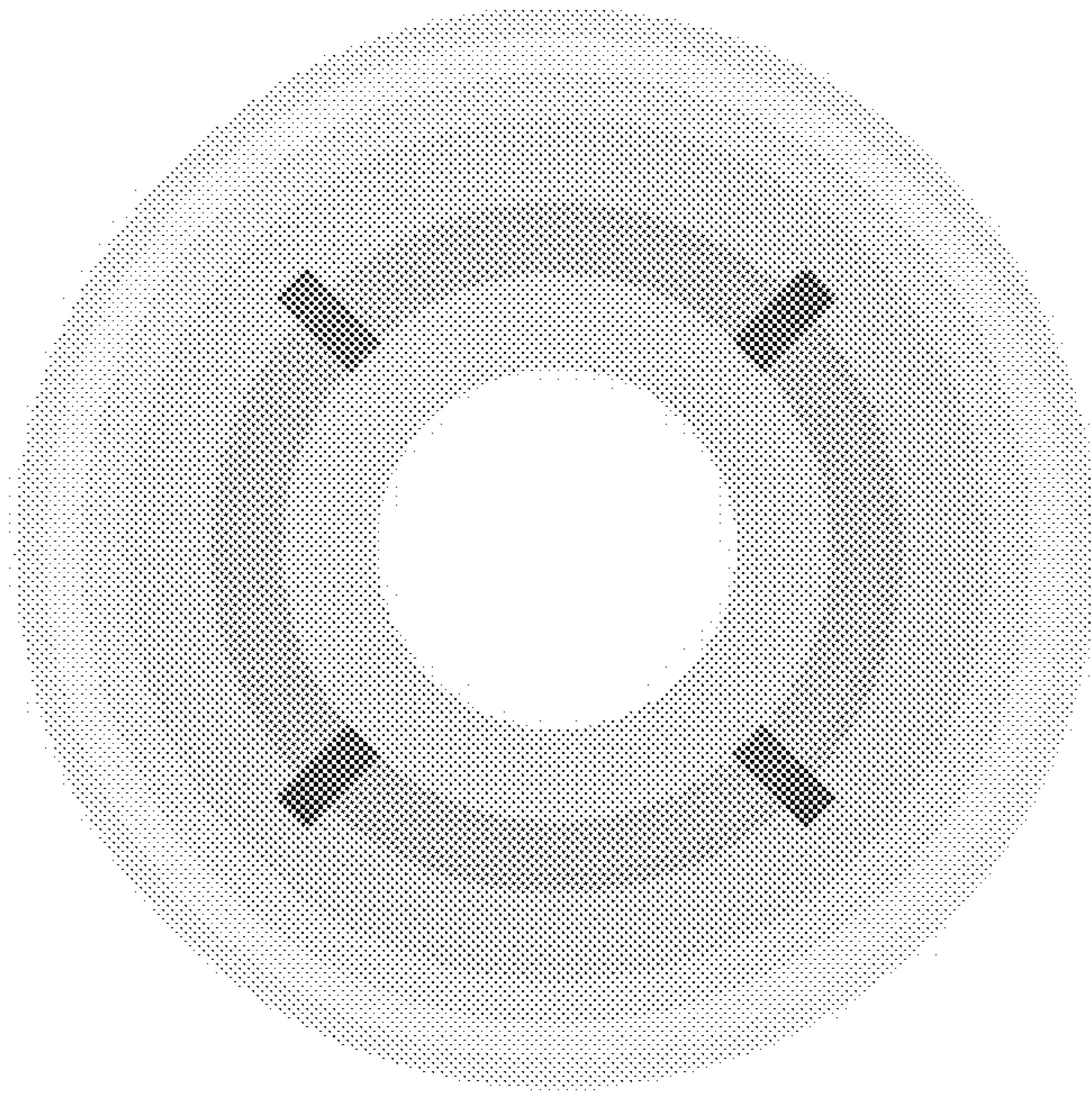

4.4

5.1

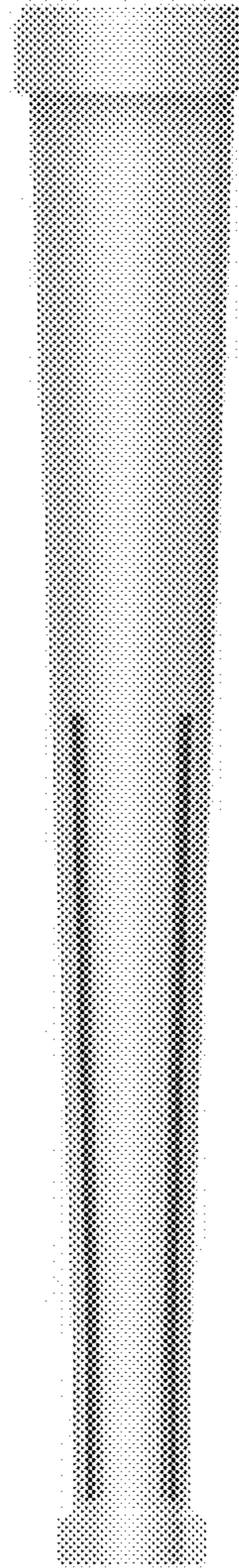

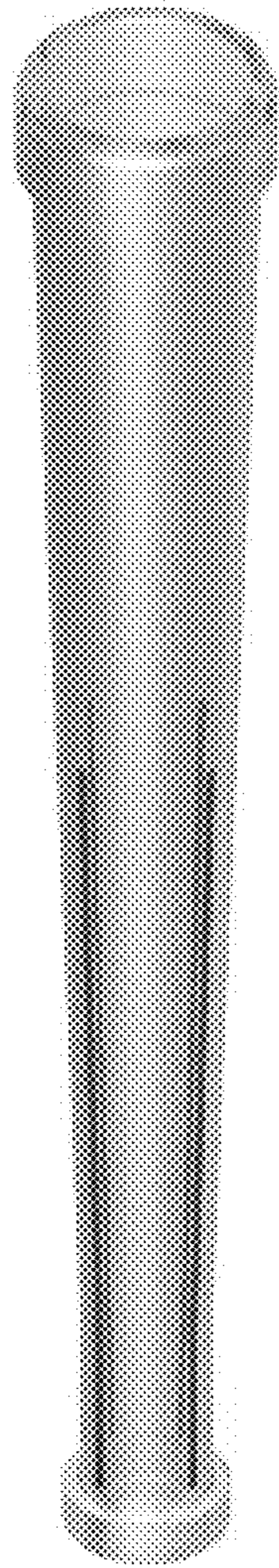

5.2

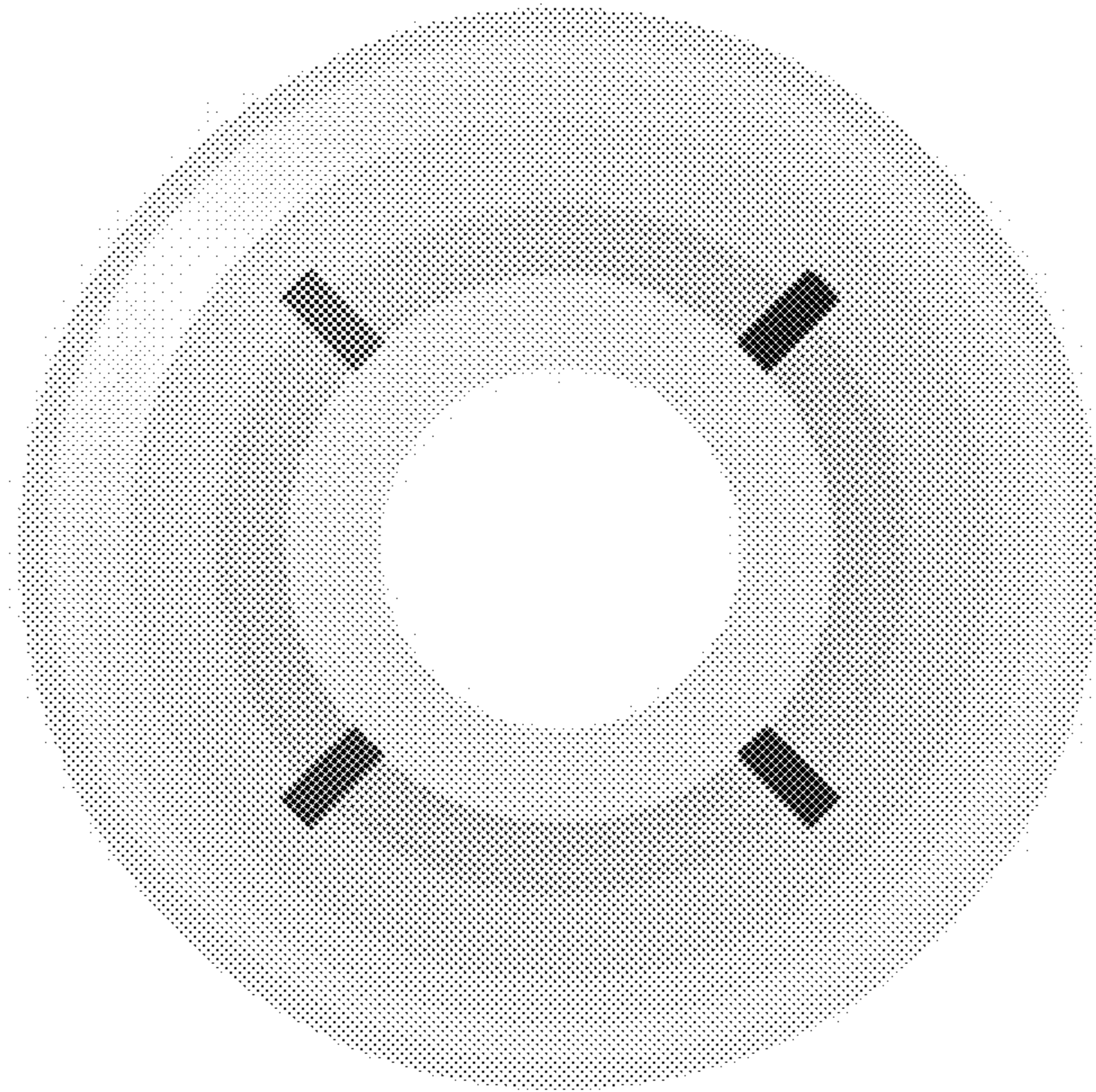

5.3

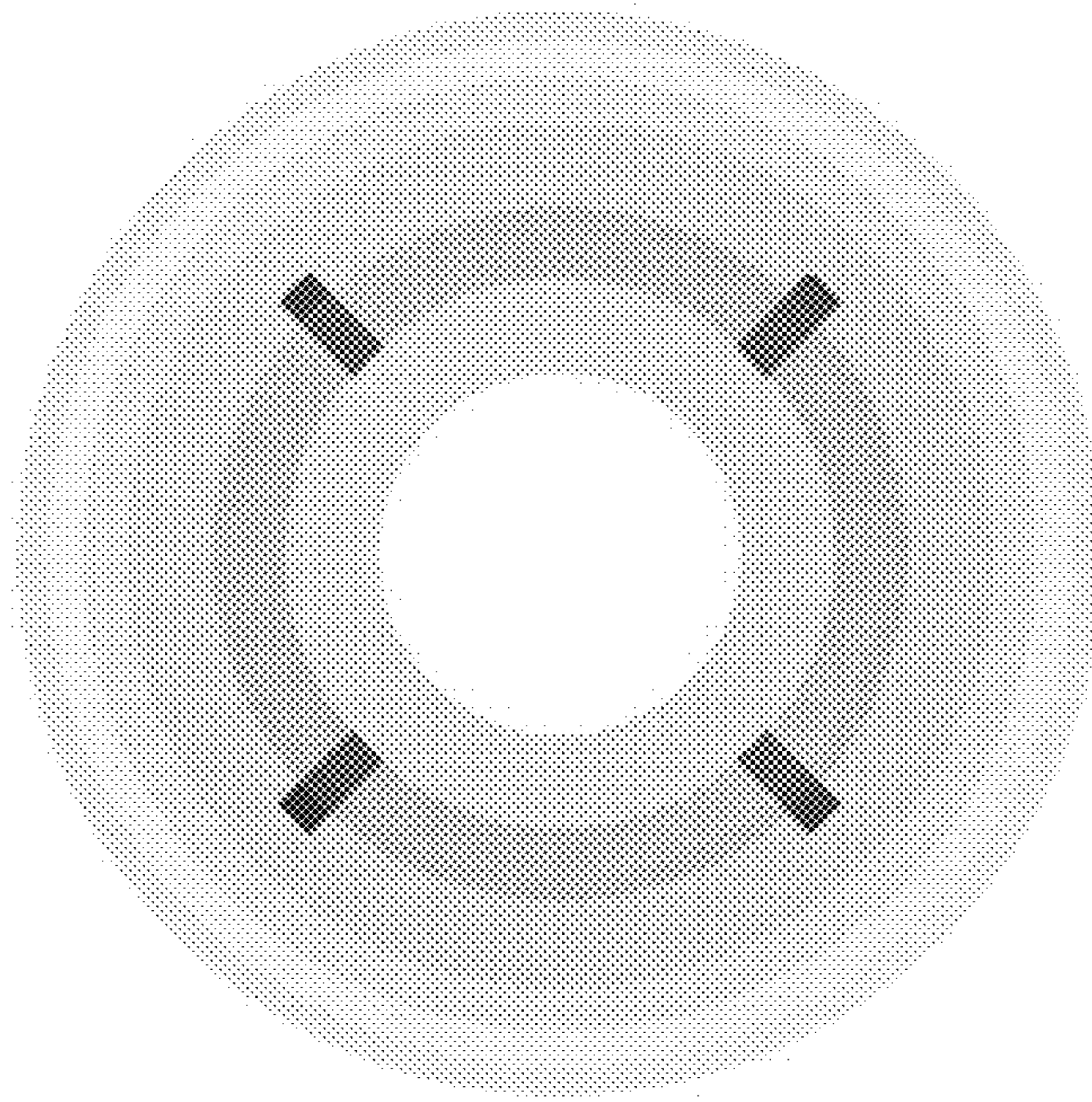

5.4