



US0D1006985S

(12) **United States Design Patent** (10) **Patent No.:** **US D1,006,985 S**
Zeka (45) **Date of Patent:** **** Dec. 5, 2023**

(54) **BOTTLE WITH NOZZLE**
(71) Applicant: **Lansinoh Laboratories UK Limited,**
Leeds (GB)
(72) Inventor: **Osman Zeka,** Izmir (TR)
(73) Assignee: **LANSINOH LABORATORIES UK LIMITED,** Leeds (GB)
(**) Term: **15 Years**
(21) Appl. No.: **29/770,281**
(22) Filed: **Feb. 10, 2021**

(30) **Foreign Application Priority Data**
Nov. 10, 2020 (EM) 008265326-0001
Nov. 10, 2020 (EM) 008265326-0002
(Continued)

(51) **LOC (14) Cl.** **24-02**
(52) **U.S. Cl.**
USPC **D24/121; D9/525**
(58) **Field of Classification Search**
USPC D23/295, 296, 297, 298, 299, 300, 301,
D23/302, 303; D24/107, 108, 11,
(Continued)

(56) **References Cited**
U.S. PATENT DOCUMENTS
2,848,997 A * 8/1958 Miskel A61D 1/02
604/212
3,118,573 A * 1/1964 Krogsdale B05B 11/047
222/491
(Continued)

FOREIGN PATENT DOCUMENTS
CN 203122254 U 8/2013
CN 303289776 S 7/2015
(Continued)

Primary Examiner — Richard Kearney

Assistant Examiner — Michael Hoffman
(74) *Attorney, Agent, or Firm* — J. Miguel Hernandez;
James R. Gourley; Carstens, Allen & Gourley, LLP

(57) **CLAIM**
The ornamental design for a bottle with nozzle, as shown and described.

DESCRIPTION
FIG. 1 is a front, left side, top, perspective view of a bottle with nozzle;
FIG. 2 is a rear view of the bottle with nozzle of FIG. 1;
FIG. 3 is a front view of the bottle with nozzle of FIG. 1;
FIG. 4 is a right side view of the bottle with nozzle of FIG. 1;
FIG. 5 is a left side view of the bottle with nozzle of FIG. 1;
FIG. 6 is a top plan view of the bottle with nozzle of FIG. 1;
FIG. 7 is a bottom plan view of the bottle with nozzle of FIG. 1;
FIG. 8 is a front, left side, top, perspective view of a bottle;
FIG. 9 is a rear view of the bottle of FIG. 8;
FIG. 10 is a front view of the bottle of FIG. 8;
FIG. 11 is a right side view of the bottle of FIG. 8;
FIG. 12 is a left side view of the bottle of FIG. 8;
FIG. 13 is a top plan view of the bottle of FIG. 8;
FIG. 14 is a bottom plan view of the bottle of FIG. 8;
FIG. 15 is a front, left side, top, perspective view of a nozzle;
FIG. 16 is a rear view of the nozzle of FIG. 15;
FIG. 17 is a front view of the nozzle of FIG. 15;
FIG. 18 is a right side view of the nozzle of FIG. 15;
FIG. 19 is a left side view of the nozzle of FIG. 15;
FIG. 20 is a top plan view of the nozzle of FIG. 15; and,
FIG. 21 is a bottom plan view of the nozzle of FIG. 15.

1 Claim, 18 Drawing Sheets

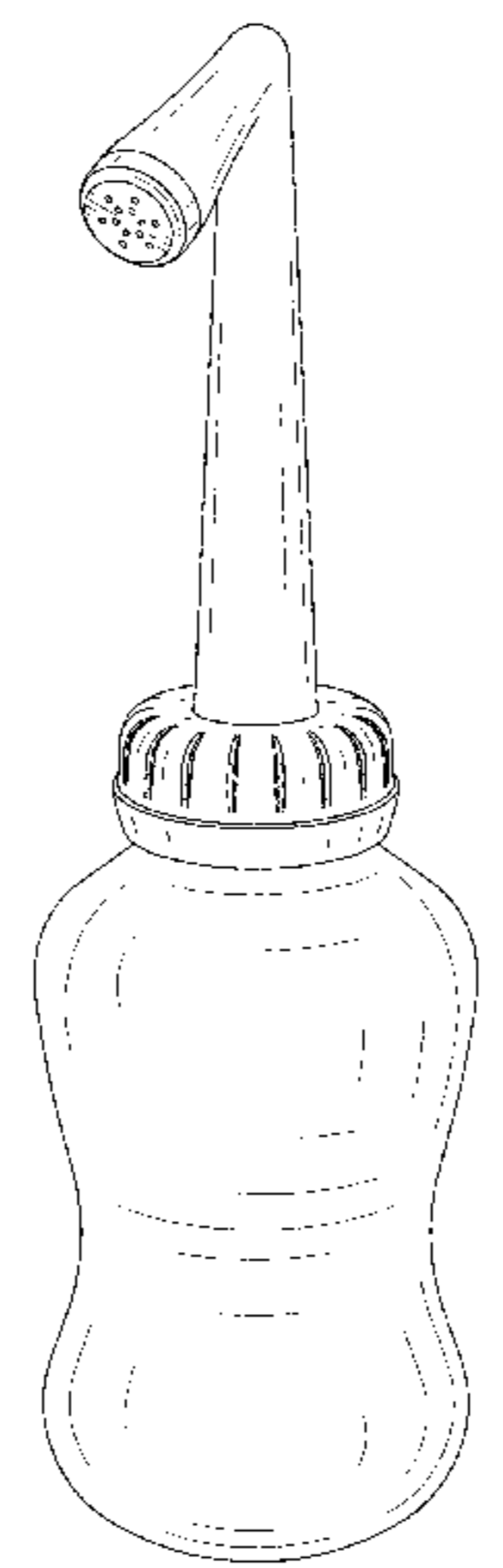

US D1,006,985 S

(30) Foreign Application Priority Data

Nov. 10, 2020 (EM) 008265326-0003
Nov. 10, 2020 (EM) 008265326-0004
Nov. 10, 2020 (EM) 008265326-0005
Nov. 10, 2020 (EM) 008265326-0006

D875,244 S * 2/2020 Wainberg D24/130
D896,368 S * 9/2020 Zhang D24/121
2005/0159713 A1* 7/2005 McPherson A47K 7/08
604/279
2005/0187526 A1* 8/2005 Horne A47K 7/08
604/279
2005/0210572 A1* 9/2005 Fogel A47K 3/26
4/443

(58) Field of Classification Search

USPC D24/110.1-110.6, 111, 112, 115, 117,
D24/121; D9/447, 500, 525, 549, 552;
606/181, 185; 604/181, 184, 187, 227,
604/264, 272
CPC A61M 5/178; A61M 3/00; A61M 25/0043;
A61M 25/0067; A61M 25/0097; A61M
2210/0618
See application file for complete search history.

FOREIGN PATENT DOCUMENTS

CN 303340322 S 8/2015
CN 303618616 S 3/2016
CN 303656594 S 4/2016
CN 303692915 S 6/2016
CN 303989438 S 12/2016
CN 303989440 S 12/2016
CN 304152298 S 5/2017
CN 304229184 S 8/2017
CN 304698586 S 6/2018
CN 304698587 S 6/2018
CN 304888549 * 11/2018
CN 304888549 S 11/2018
CN 304919700 S 11/2018
CN 304975709 S 1/2019
CN 305018443 S 1/2019
CN 305204818 S 6/2019
CN 305298346 S 8/2019
CN 305343724 S 9/2019
CN 305612792 S 2/2020
CN 305656369 S 3/2020
CN 305690834 S 4/2020
CN 305830027 S 6/2020
CN 305889358 S 6/2020
CN 306107816 S 10/2020
CN 306132491 S 10/2020

(56) References Cited

U.S. PATENT DOCUMENTS

4,140,120 A * 2/1979 Yamauchi A61M 3/0262
4/443
D294,986 S * 3/1988 Atchley D30/132
4,925,128 A * 5/1990 Brody B29C 45/261
222/211
D328,421 S * 8/1992 Weiler D24/115
5,937,451 A * 8/1999 Mihara E03D 9/085
239/586
7,971,761 B1 * 7/2011 Kudlu A61M 3/0245
222/481.5
D702,830 S * 4/2014 Hannah D24/108
D743,020 S * 11/2015 Mehta D24/108
D750,771 S * 3/2016 Malin D24/121
D872,852 S * 1/2020 Mechor D24/108

* cited by examiner

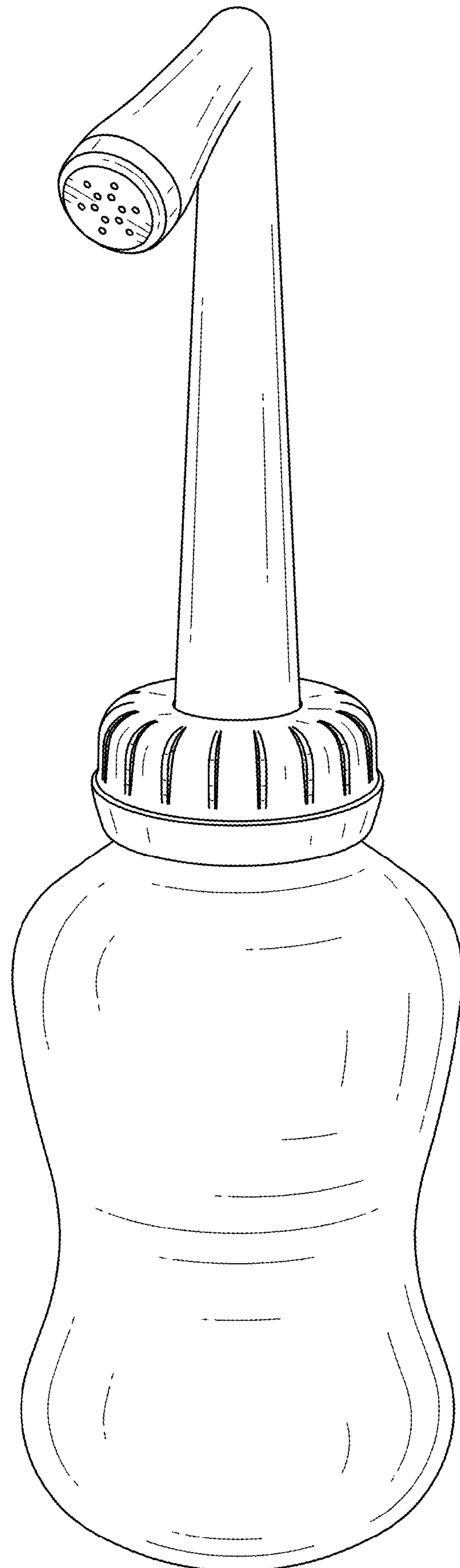

FIG. 1

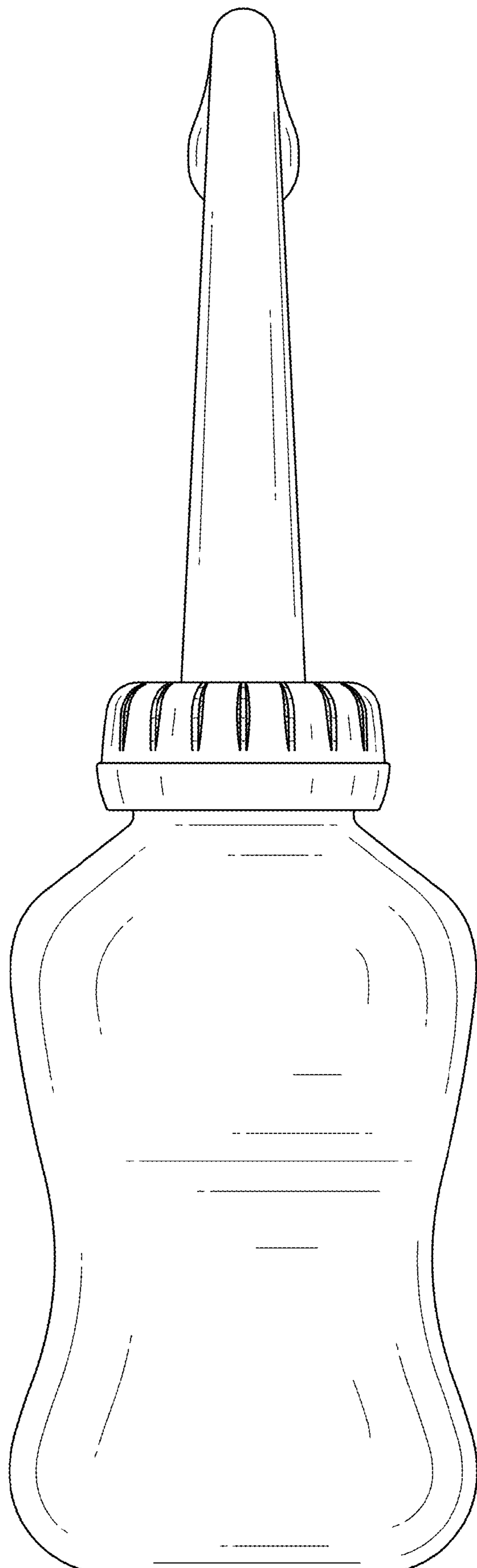

FIG. 2

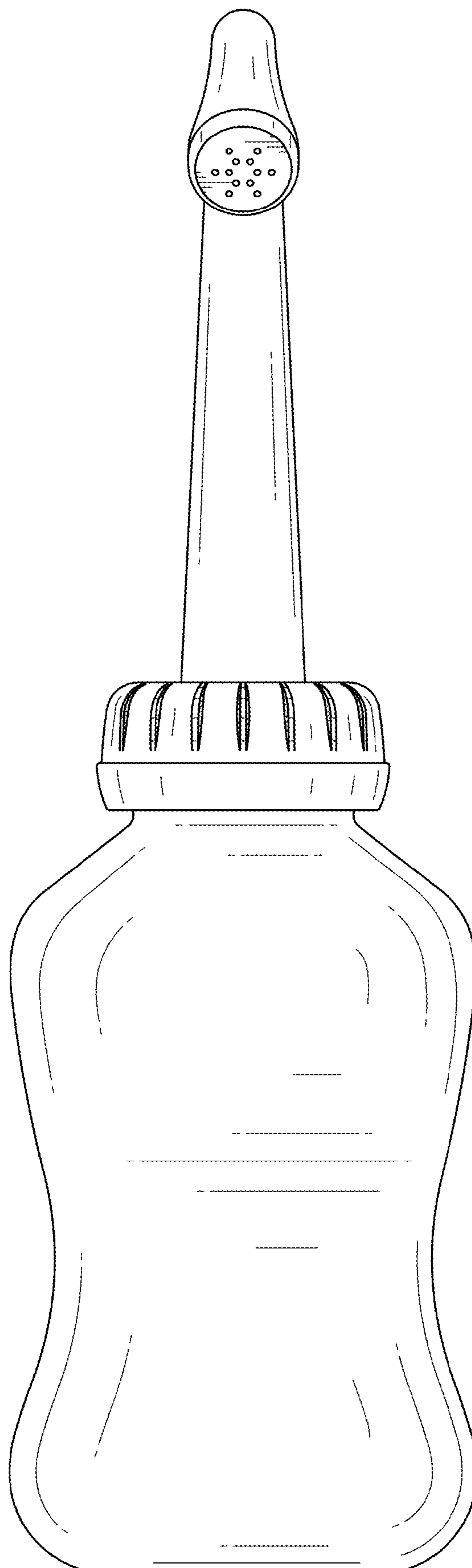

FIG. 3

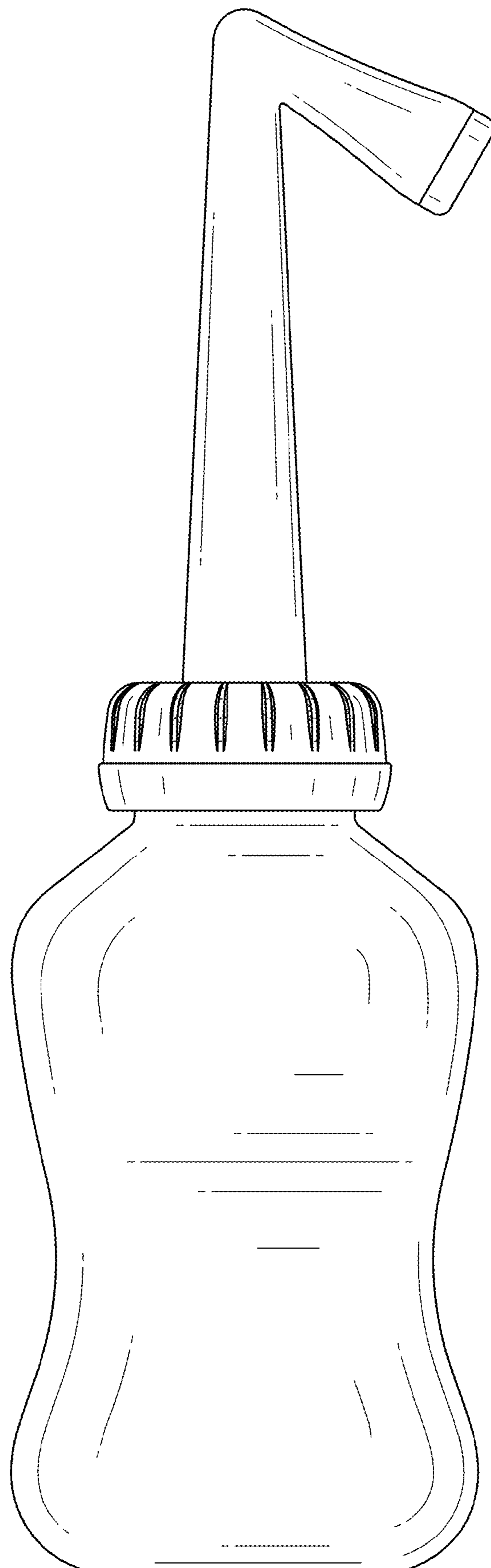

FIG. 4

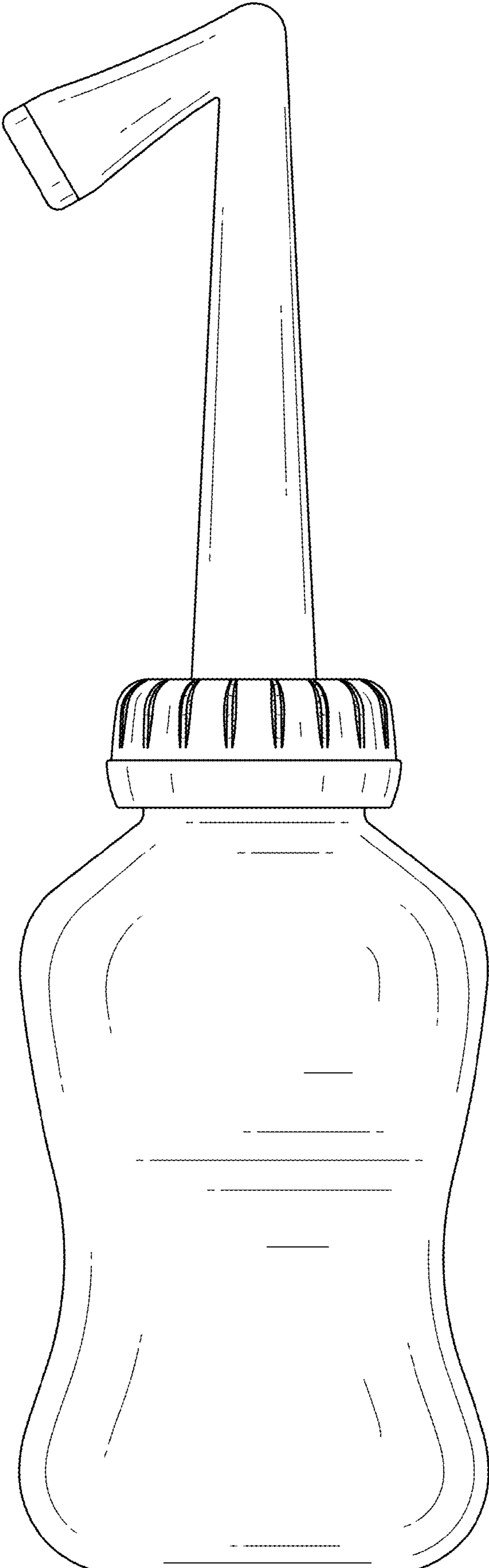

FIG. 5

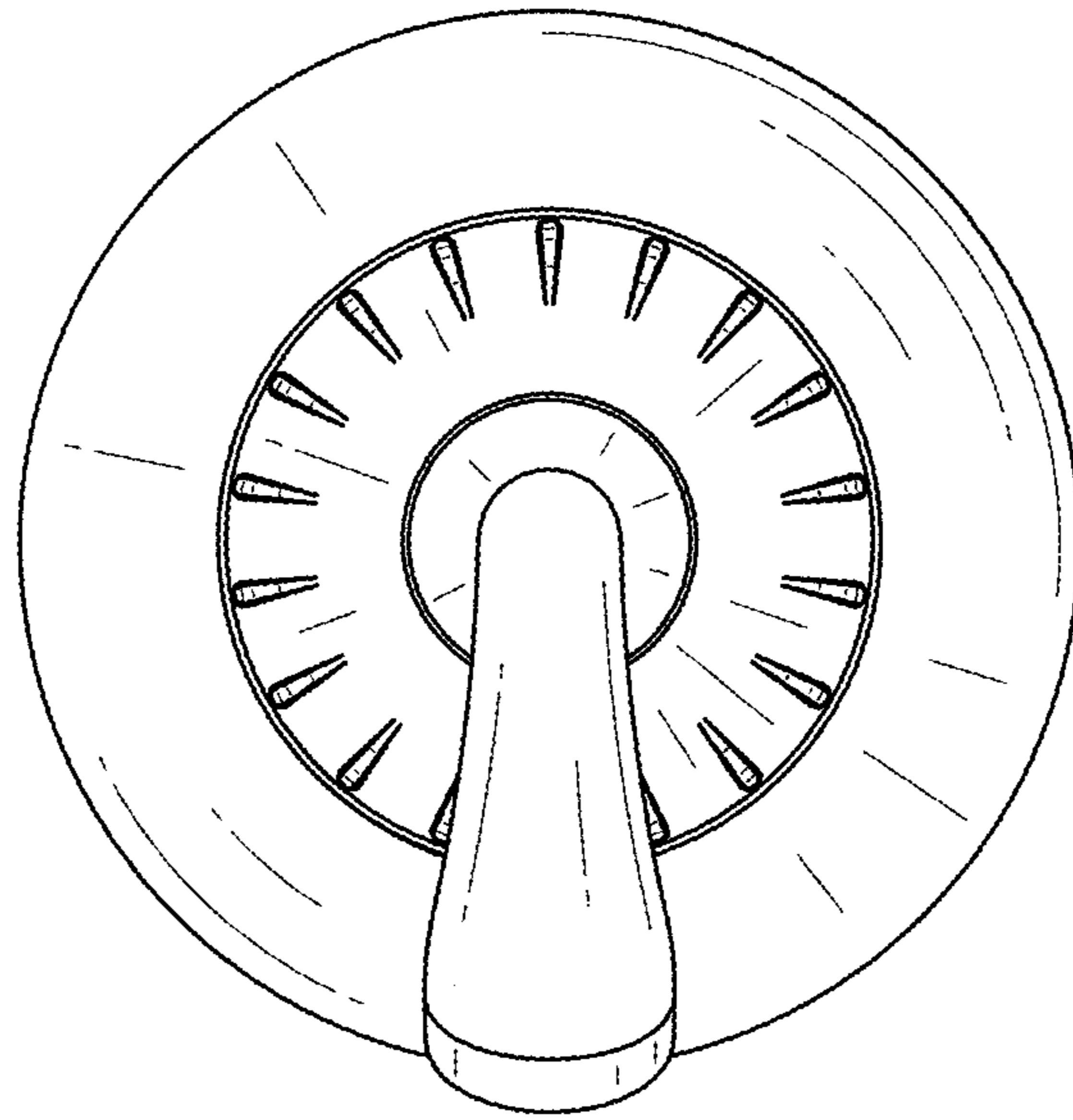

FIG. 6

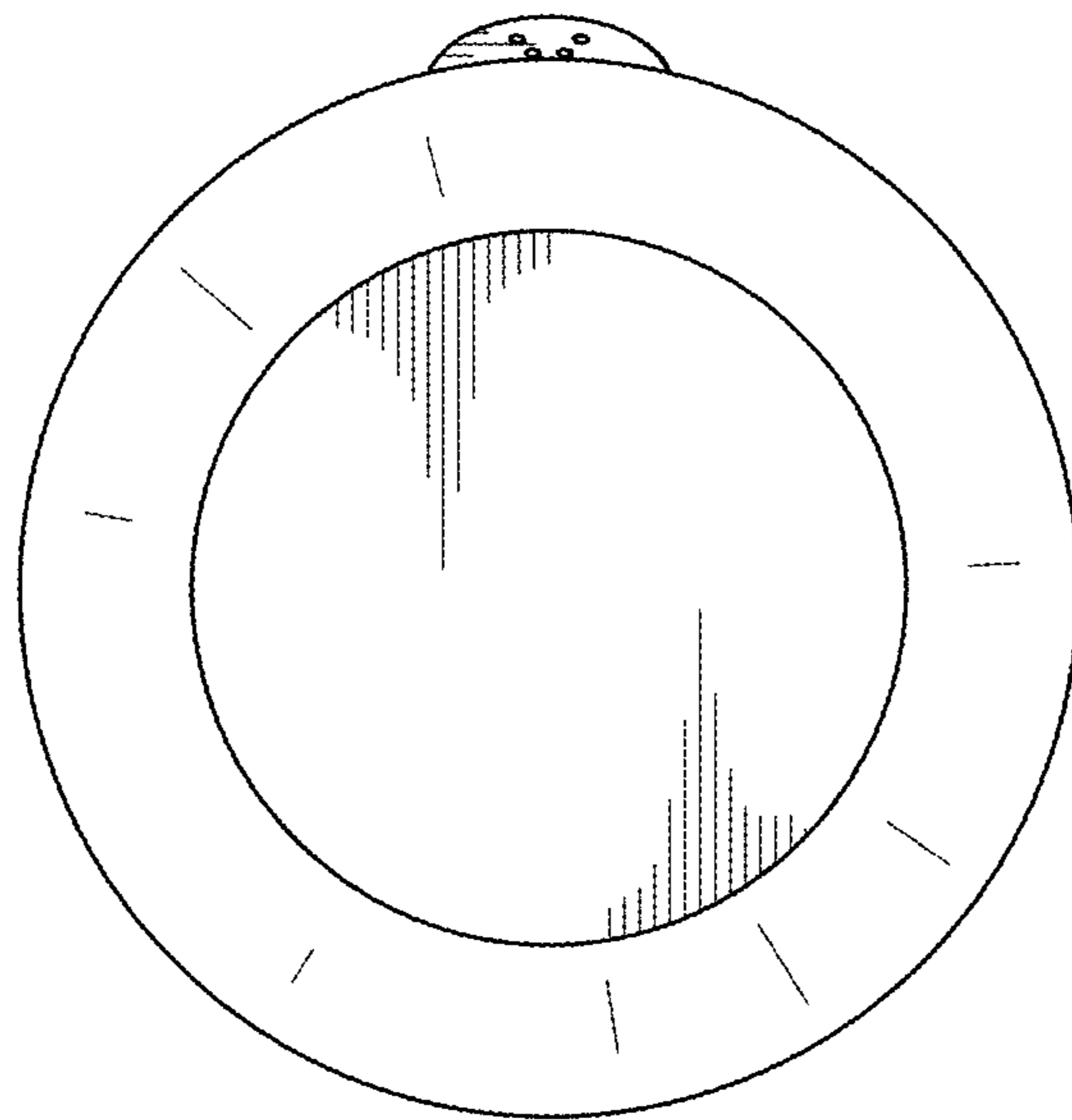

FIG. 7

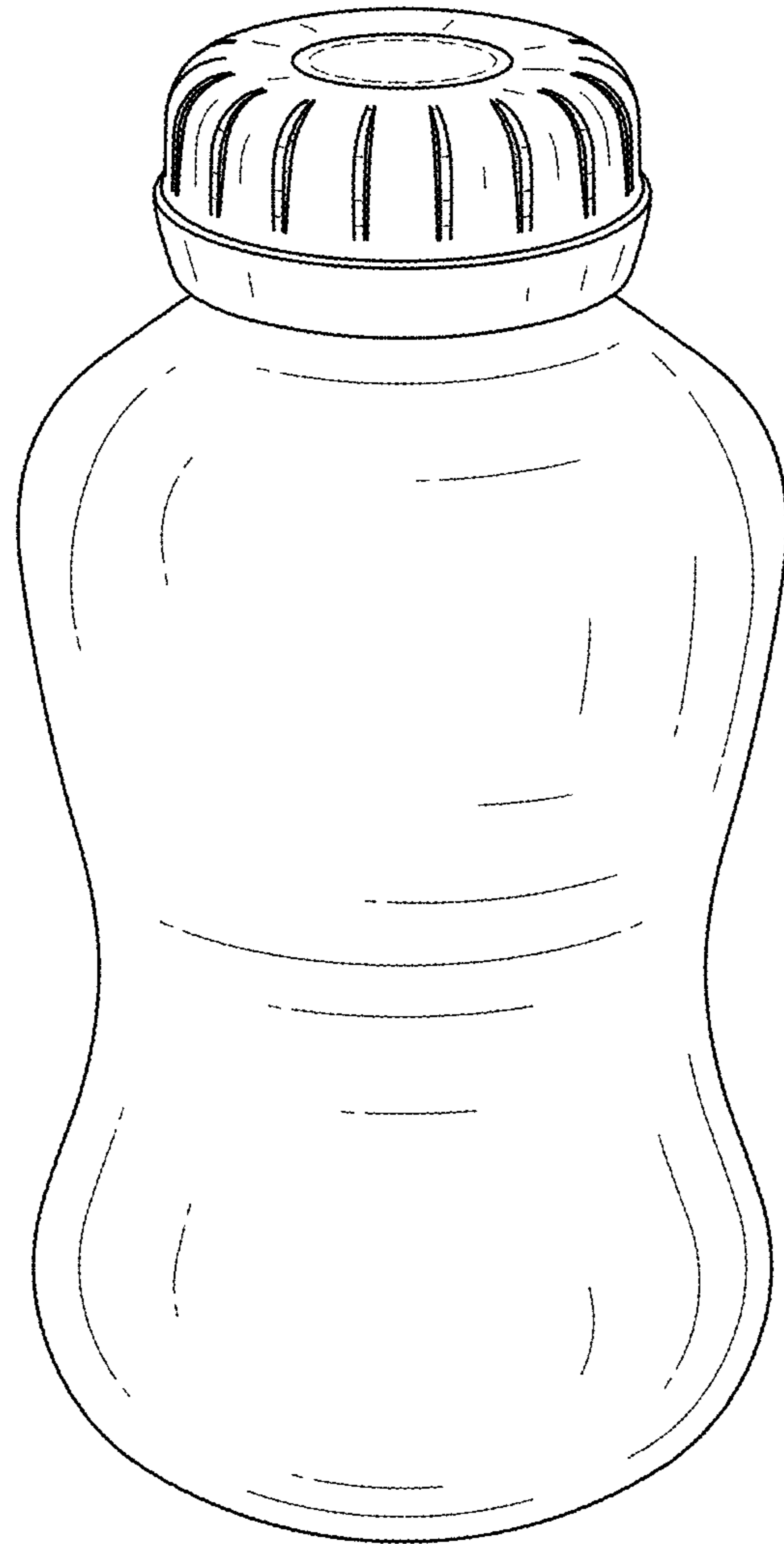

FIG. 8

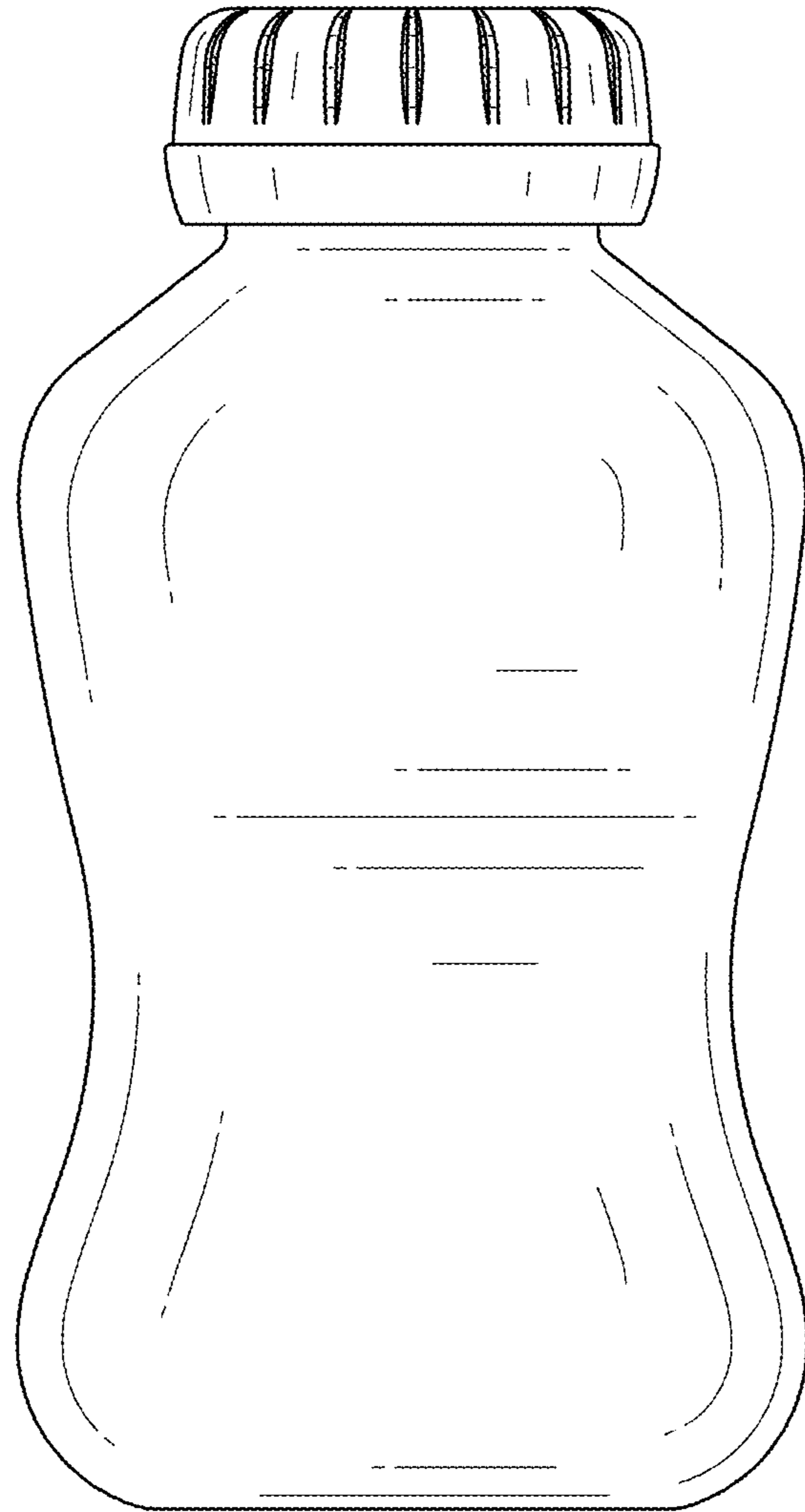

FIG. 9

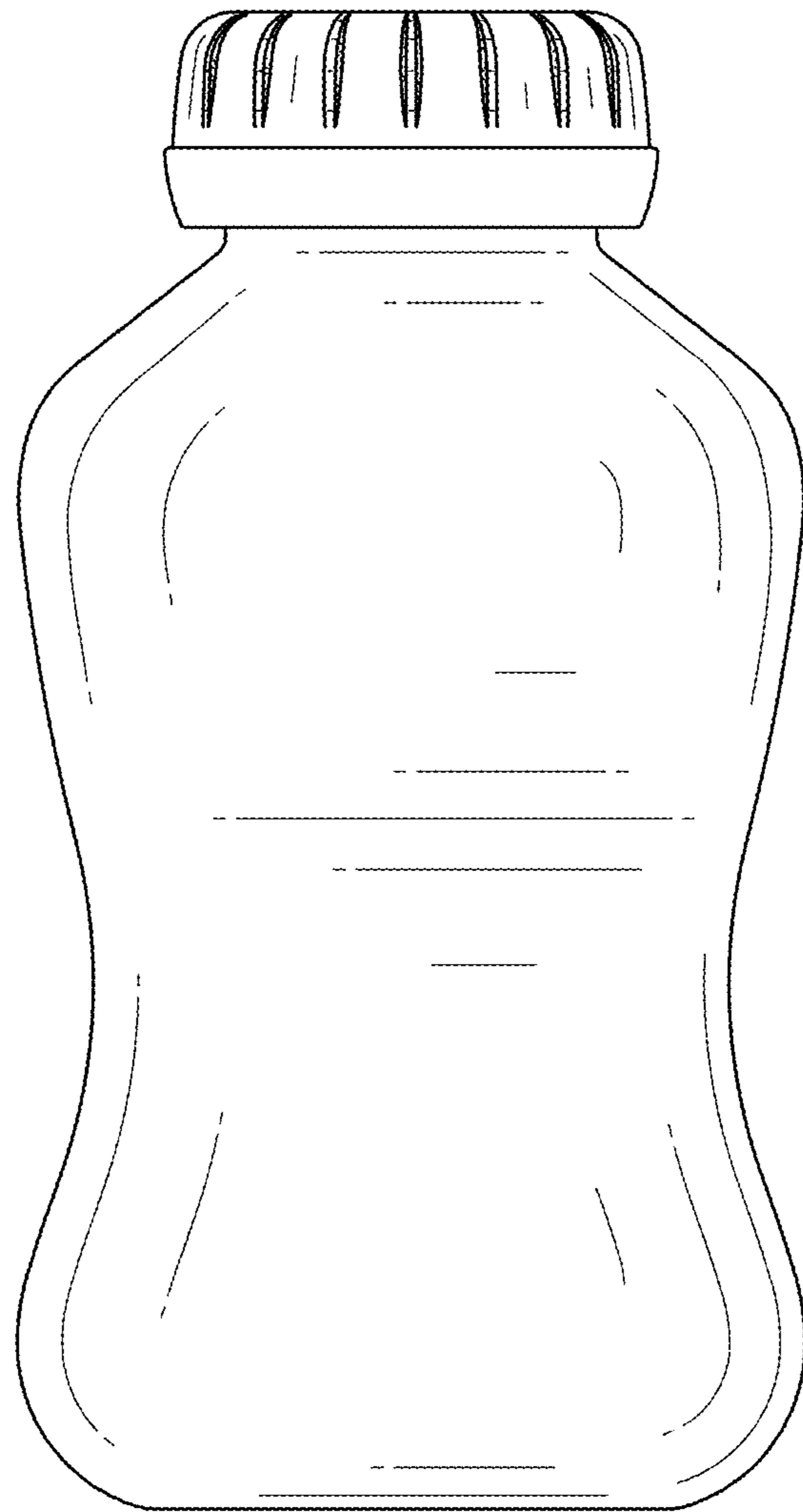

FIG. 10

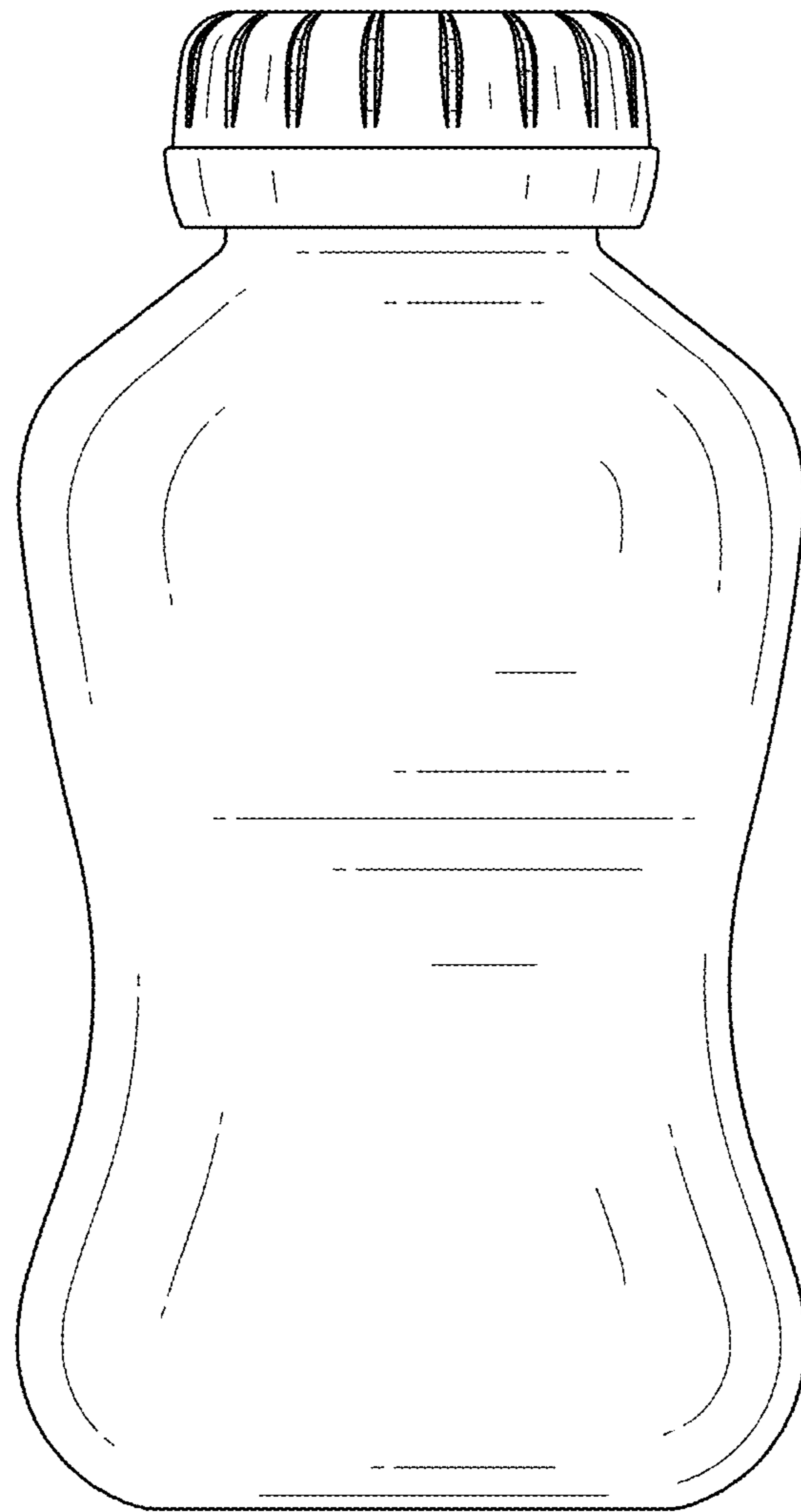

FIG. 11

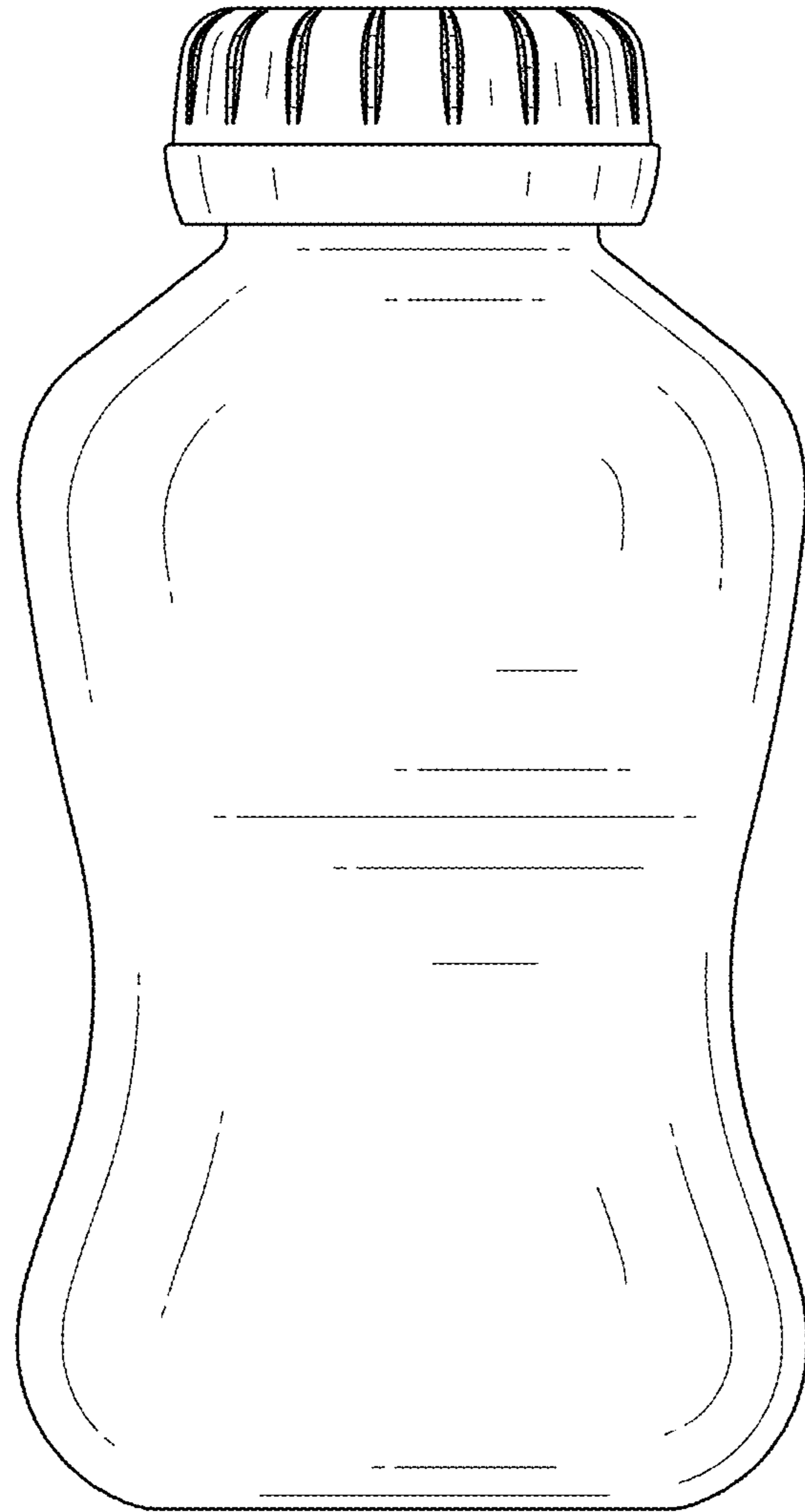

FIG. 12

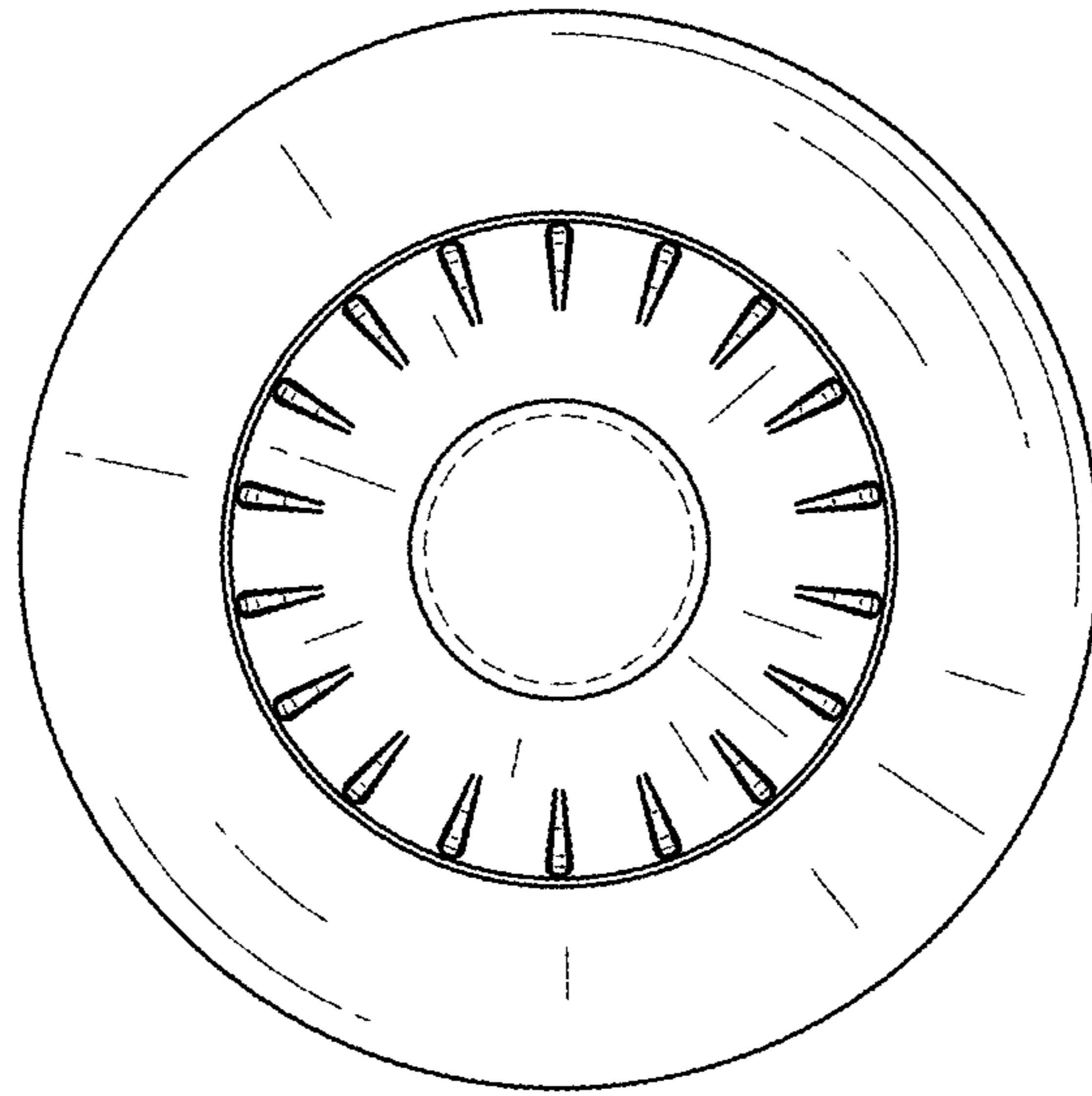

FIG. 13

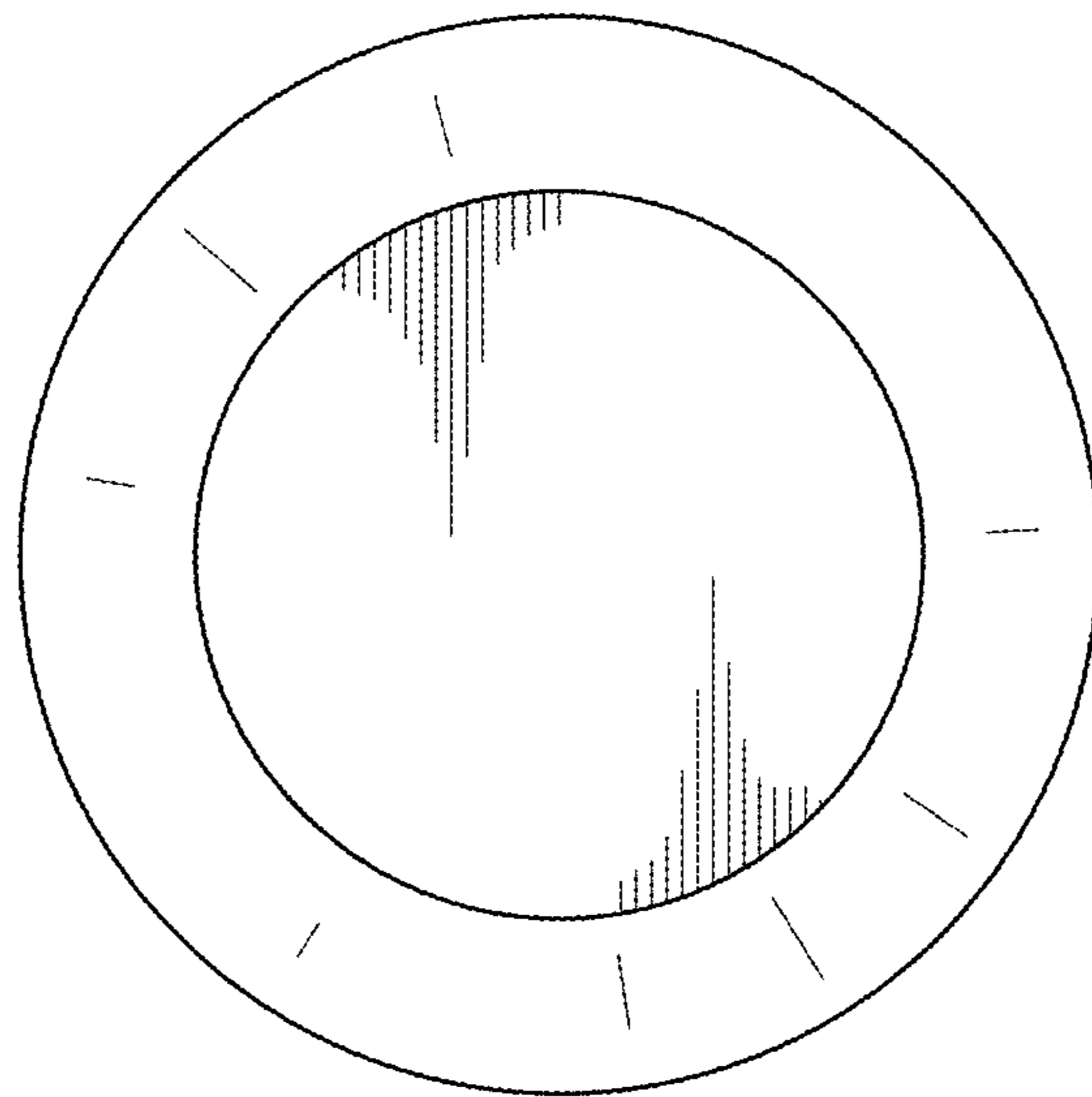

FIG. 14

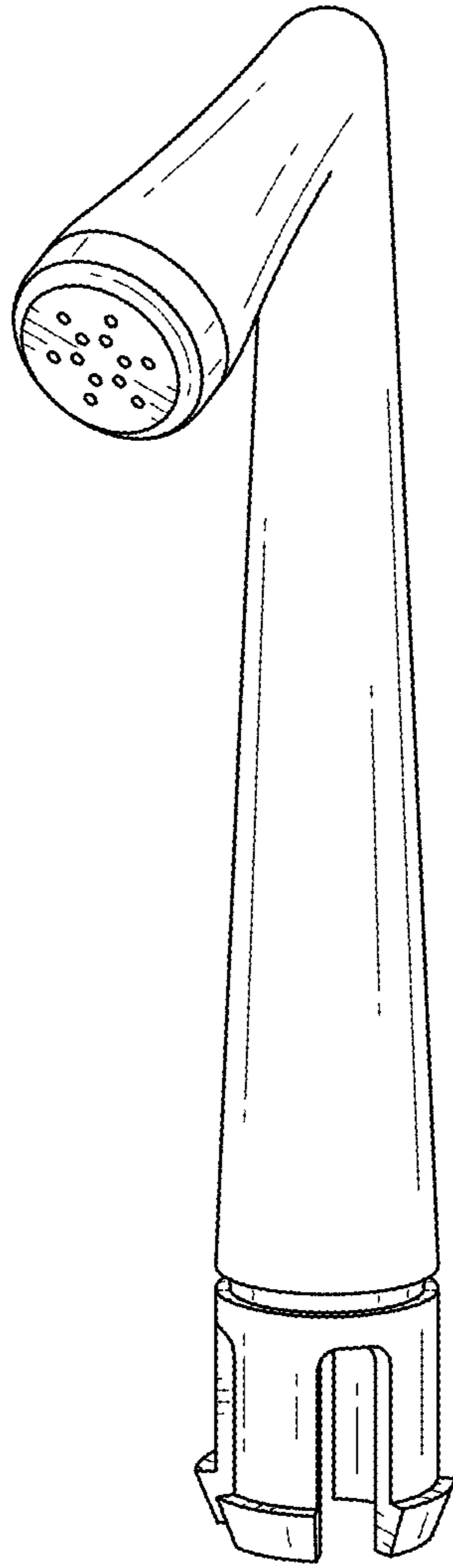

FIG. 15

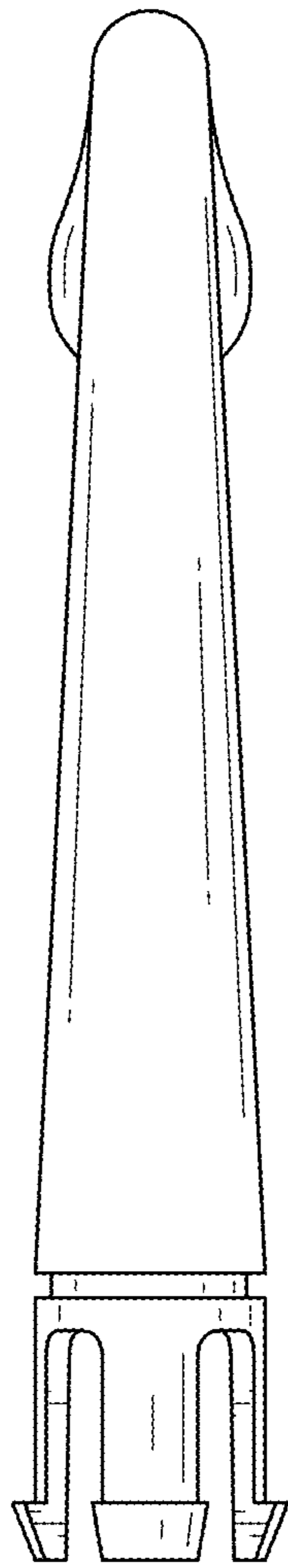

FIG. 16

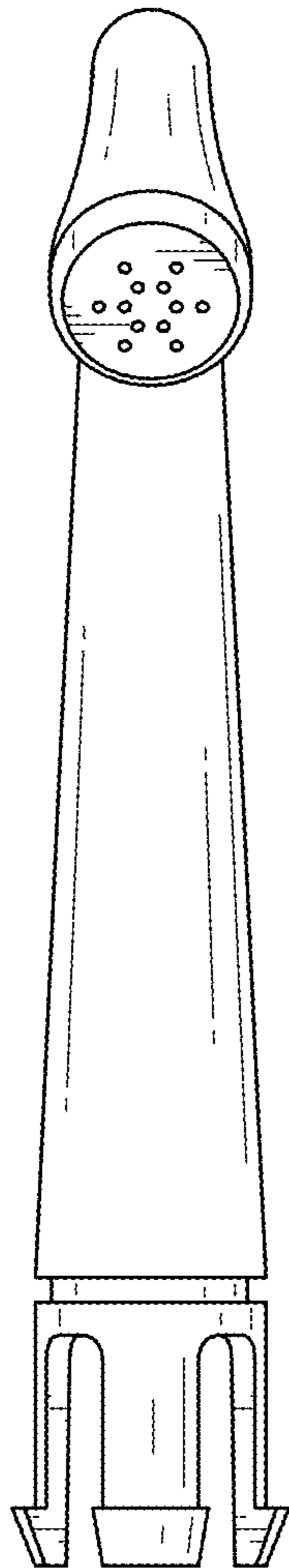

FIG. 17

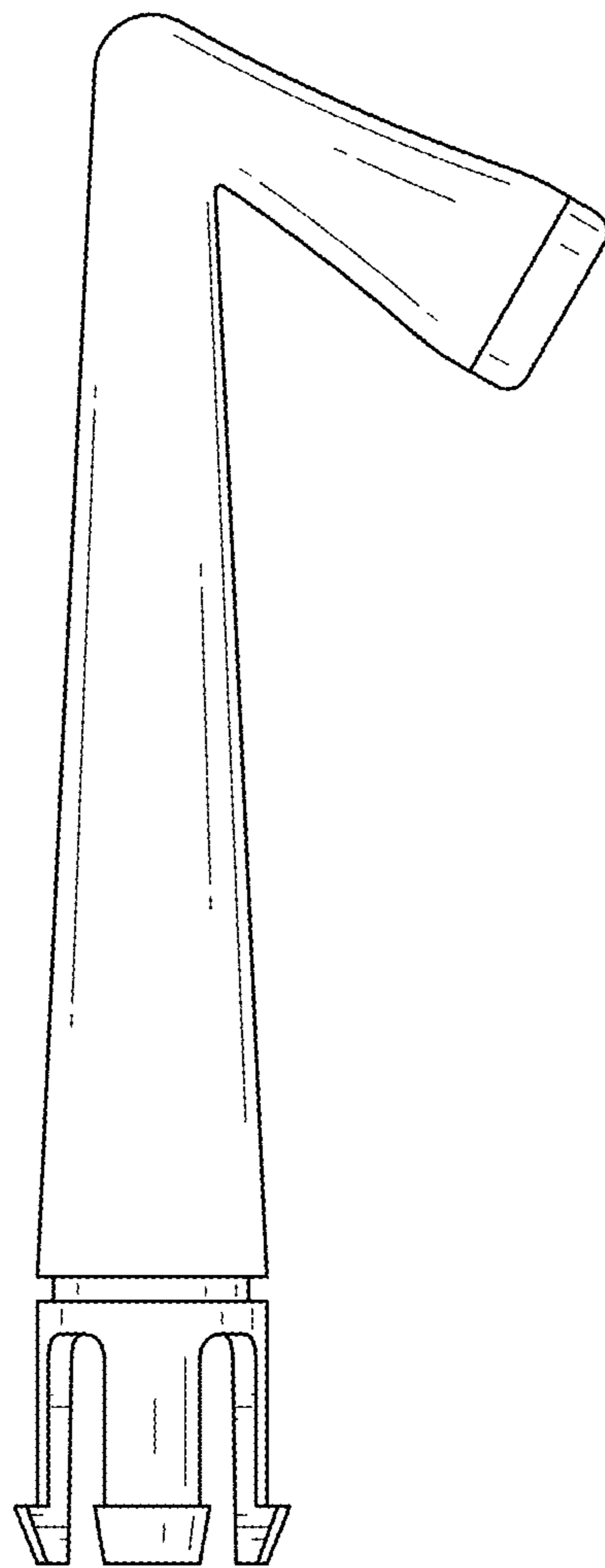

FIG. 18

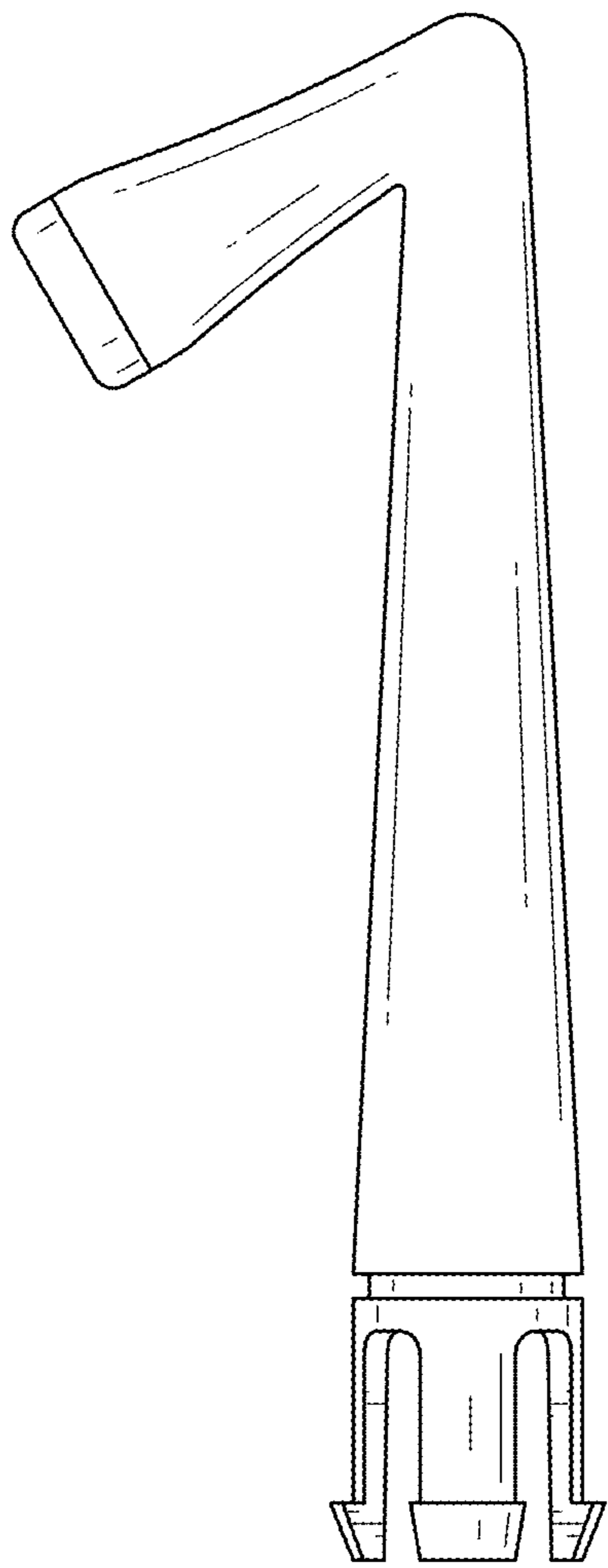

FIG. 19

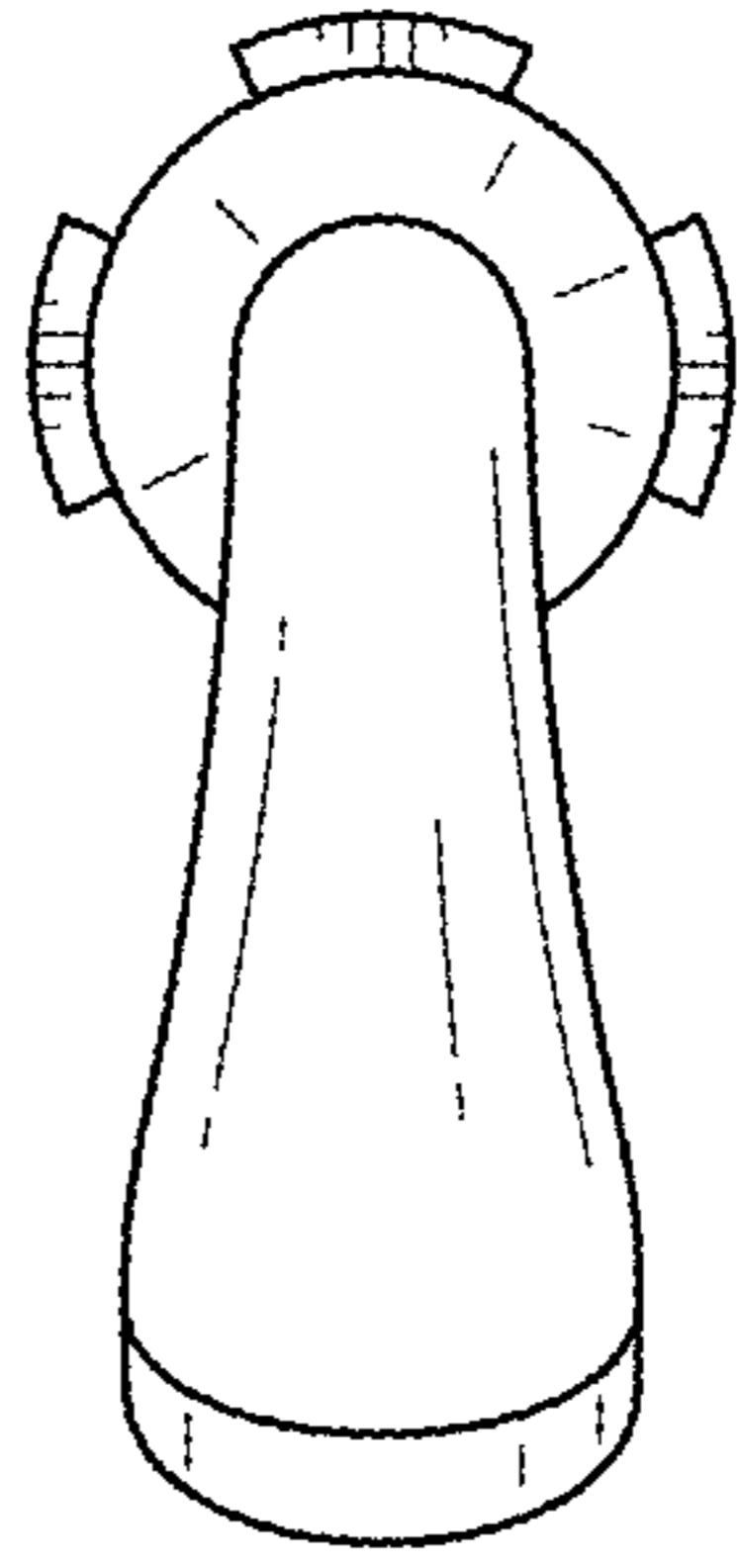

FIG. 20

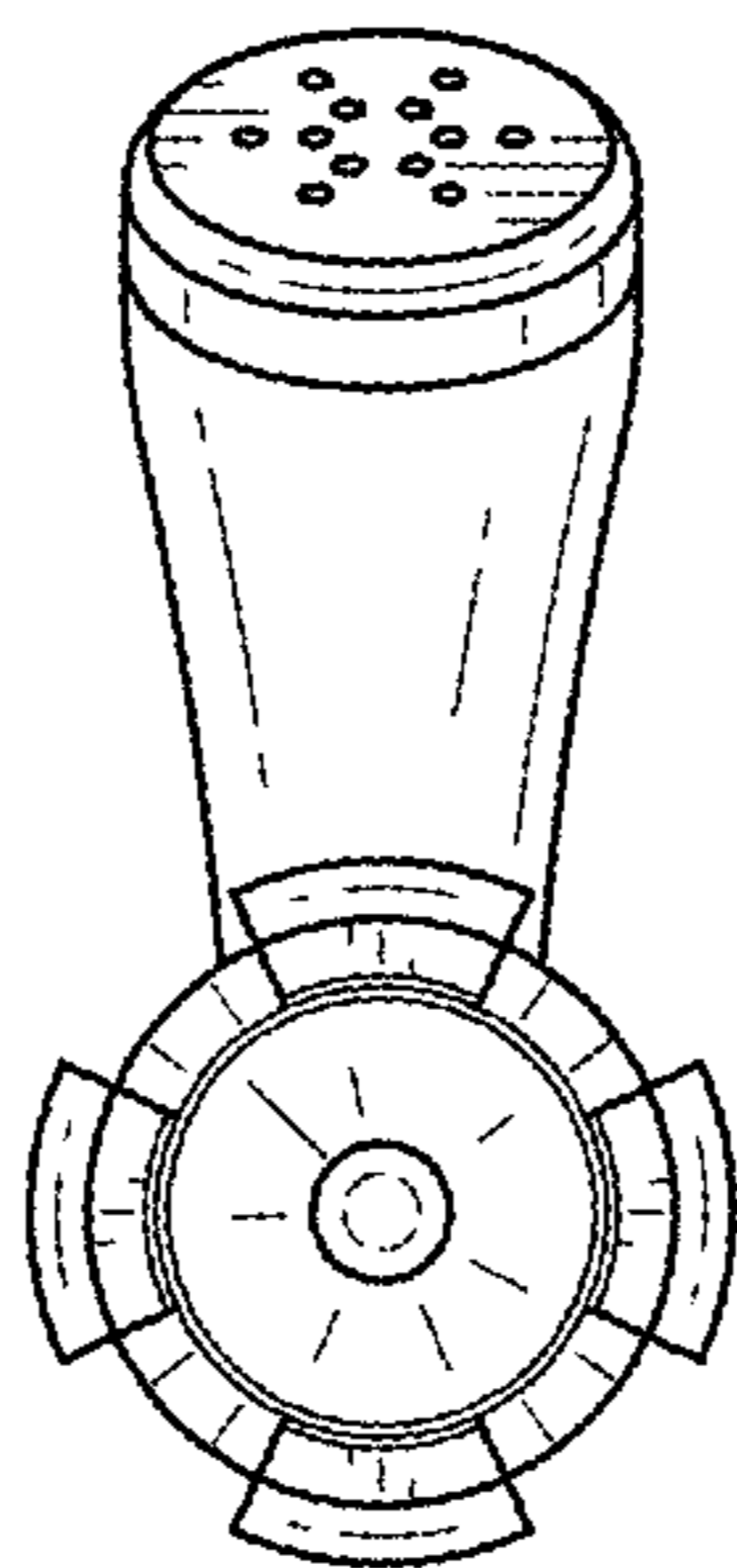

FIG. 21