



US009959674B2

(12) **United States Patent**
Chen et al.

(10) **Patent No.:** **US 9,959,674 B2**
(45) **Date of Patent:** **May 1, 2018**

(54) **DIRECTIONAL AND X-RAY VIEW
TECHNIQUES FOR NAVIGATION USING A
MOBILE DEVICE**

FOREIGN PATENT DOCUMENTS

CN 101379369 A 3/2009
EP 2 228 625 A2 * 9/2010 G01C 21/36

(Continued)

(71) Applicant: **QUALCOMM Incorporated**, San Diego, CA (US)

(72) Inventors: **Jiajian Chen**, San Jose, CA (US); **Hui Chao**, San Jose, CA (US)

(73) Assignee: **QUALCOMM Incorporated**, San Diego, CA (US)

OTHER PUBLICATIONS

Avery, "X-ray vision for mobile outdoor augmented reality", X-ray vision for mobile outdoor augmented reality, University of South Australia, Adelaide, South Australia, May 31, 2009.*

(Continued)

(*) Notice: Subject to any disclaimer, the term of this patent is extended or adjusted under 35 U.S.C. 154(b) by 93 days.

Primary Examiner — Maurice L McDowell, Jr.

Assistant Examiner — Donna J Ricks

(21) Appl. No.: **13/777,861**

(22) Filed: **Feb. 26, 2013**

(65) **Prior Publication Data**

US 2014/0240350 A1 Aug. 28, 2014

(51) **Int. Cl.**
G06T 19/00 (2011.01)
G01C 21/20 (2006.01)

(52) **U.S. Cl.**
CPC **G06T 19/006** (2013.01); **G01C 21/206** (2013.01); **G09G 2340/10** (2013.01)

(58) **Field of Classification Search**
None
See application file for complete search history.

(56) **References Cited**

U.S. PATENT DOCUMENTS

7,893,963 B2 * 2/2011 Gallagher H04N 5/23248
348/208.6
8,223,012 B1 * 7/2012 Diem G06Q 10/00
340/5.2
8,848,970 B2 * 9/2014 Aller H04M 1/72522
345/632

2006/0213386 A1 9/2006 Funakura
(Continued)

(57) **ABSTRACT**

Techniques for displaying navigation information on a mobile device are provided that include a method that includes obtaining an indication of a position and an indication of a direction associated with the mobile device, using the indication of the position, the indication of the direction, information regarding identities of POIs within a geographic region of interest, and information regarding areas associated with the POIs to determine at least one relevant POI, of the POIs, that is associated with the position and direction, and displaying at least one visual indication associated with each of the at least one relevant POI on the mobile device. The appearance of the at least one visual indication is dependent on at least one of a distance from the mobile device of the relevant POI associated with the visual indication or presence of a known physical barrier between the mobile device and that relevant POI.

39 Claims, 11 Drawing Sheets

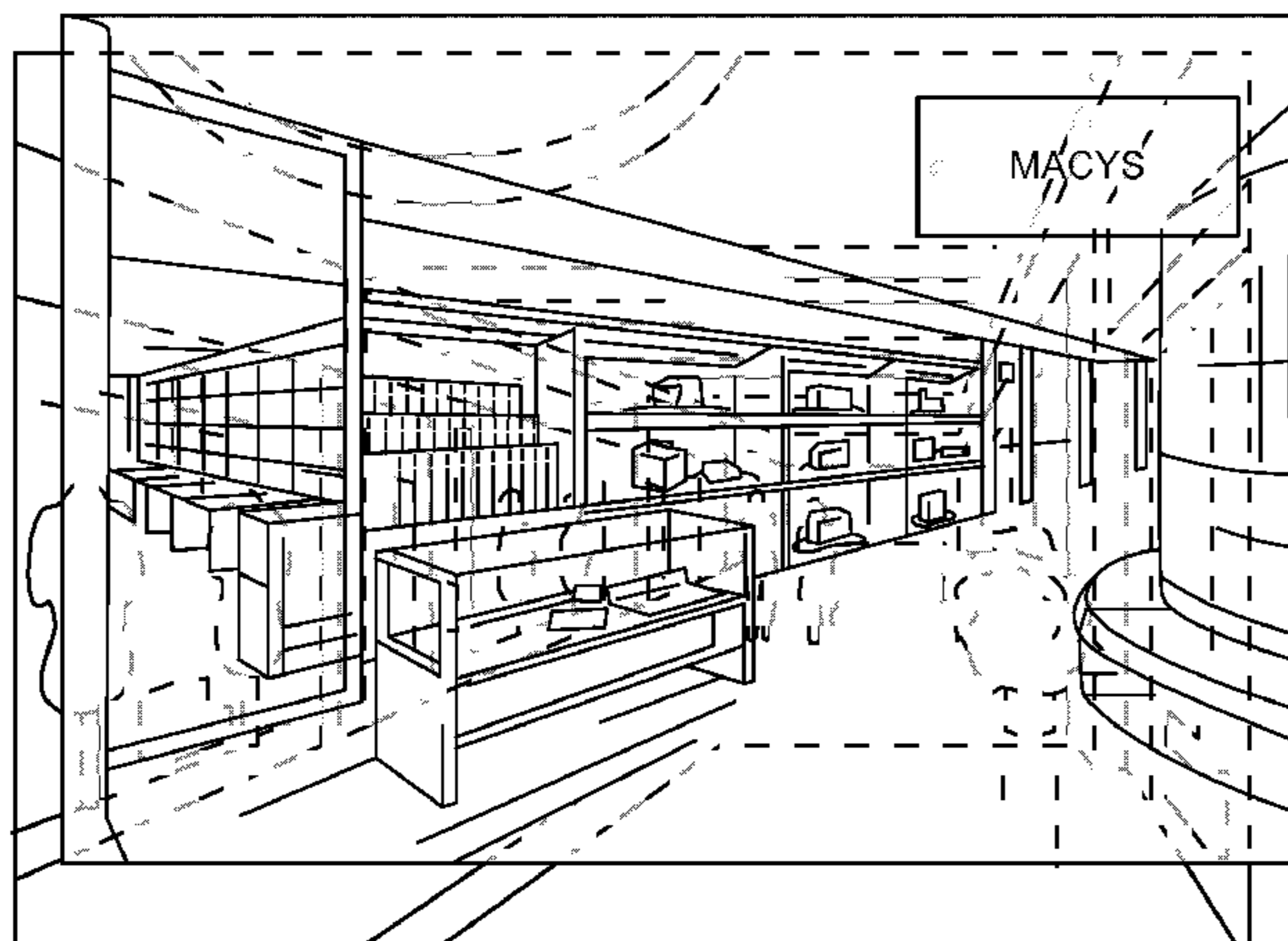

(56)

References Cited

U.S. PATENT DOCUMENTS

2006/0259574 A1* 11/2006 Rosenberg H04L 67/18
709/217

2007/0160942 A1 7/2007 Chen

2007/0162942 A1* 7/2007 Hamynen G06F 3/147
725/105

2009/0171570 A1* 7/2009 Chiba 701/208

2009/0228201 A1 9/2009 Liu

2009/0315776 A1* 12/2009 Khosravy et al. 342/452

2010/0268451 A1 10/2010 Choi

2011/0273575 A1* 11/2011 Lee 348/222.1

2011/0287811 A1* 11/2011 Mattila et al. 455/566

2011/0306304 A1* 12/2011 Forutanpour G06F 3/04883
455/67.11

2012/0105475 A1 5/2012 Tseng

2012/0143500 A1* 6/2012 Taylor G09B 27/04
701/454

2012/0154425 A1* 6/2012 Kim 345/592

2012/0176410 A1* 7/2012 Meier et al. 345/633

2012/0194547 A1 8/2012 Johnson et al.

2012/0259732 A1* 10/2012 Sasankan et al. 705/26.9

2012/0264457 A1 10/2012 Khosravy et al.

2013/0045751 A1* 2/2013 Chao G01C 21/206
455/456.1

2013/0093787 A1* 4/2013 Fulks et al. 345/629

2013/0095855 A1* 4/2013 Bort G06T 17/05
455/456.2

2015/0049080 A1* 2/2015 Purayil H04L 67/2847
345/419

2015/0332505 A1* 11/2015 Wang G06T 15/06
345/633

FOREIGN PATENT DOCUMENTS

EP 2228625 A2 9/2010

JP 2006304265 A 11/2006

JP 2010210257 A 9/2010

JP 2010266256 A 11/2010

WO 2012125269 A1 9/2012

WO 2014094881 A1 6/2014

OTHER PUBLICATIONS

“An Augmented Reality X-Ray System Based on Visual Saliency (ISMAR 2010)”, Oct. 10, 2010 (Oct. 10, 2010), XP054975375, Retrieved from the Internet: URL:<https://www.youtube.com/watch?v=du72tgJxrPY#t=119>.

Avery B, “X-Ray Vision for Mobile Outdoor Augmented Reality”, X-Ray Vision for Mobile Outdoor Augmented Reality, University of South Australia, Adelaide, South Australia May 31, 2009 (May 31, 2009), pp. I-XIX,1, XP002716488, Retrieved from the Internet: URL:<http://ura.unisa.edu.au/R/?func=dbin-jump-full&objectid=56780>.

Second Written Opinion from International Application No. PCT/US2014/011788, dated Nov. 14, 2014, 9 pgs.

International Search Report and Written Opinion—PCT/US2014/011788—ISA/EPO—dated Apr. 22, 2014.

International Preliminary Report on Patentability—PCT/US2014/011788, The International Bureau of WIPO—Geneva, Switzerland, dated Feb. 17, 2015, 33 pgs.

* cited by examiner

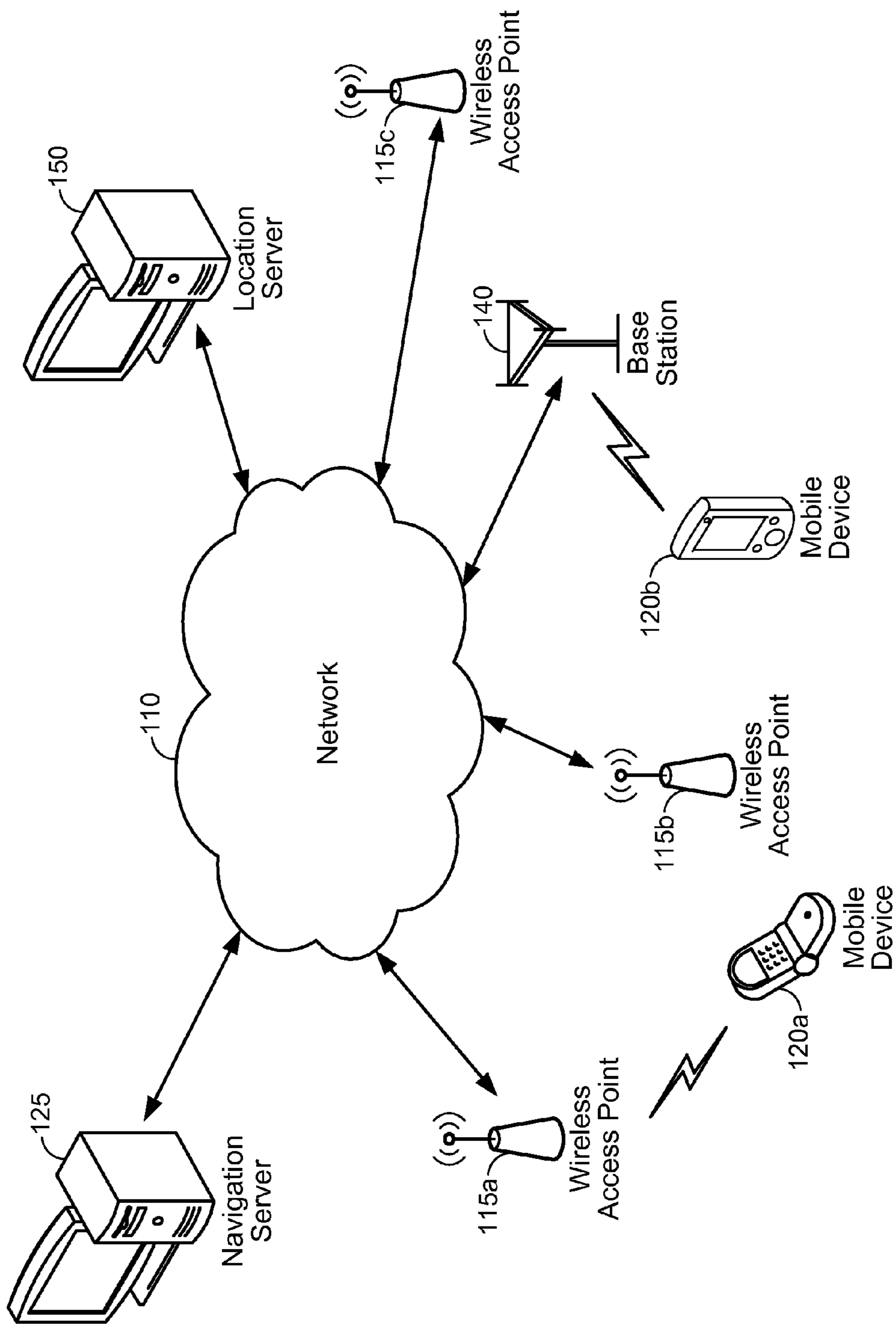

FIG. 1

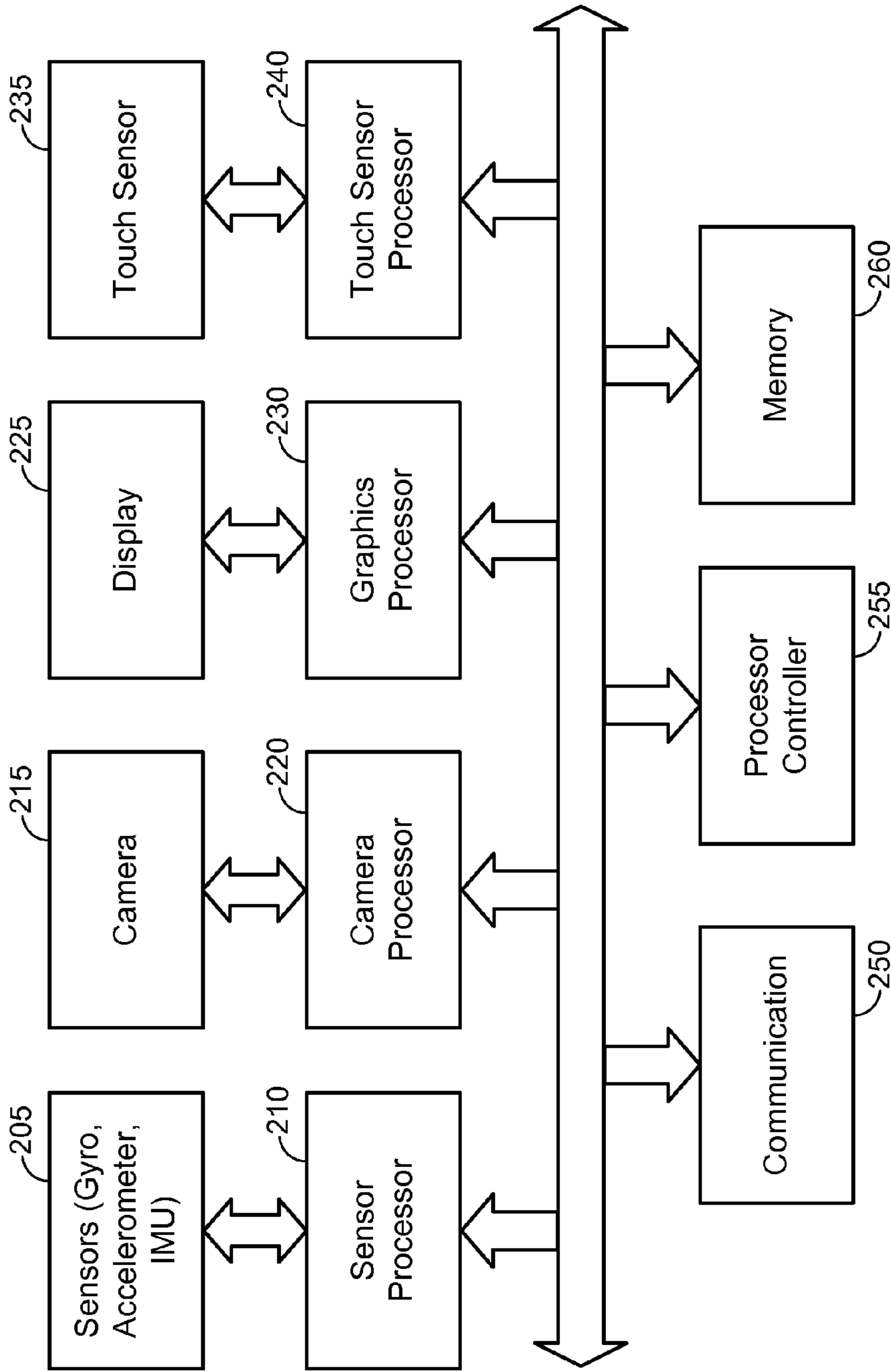

FIG. 2
Mobile Device

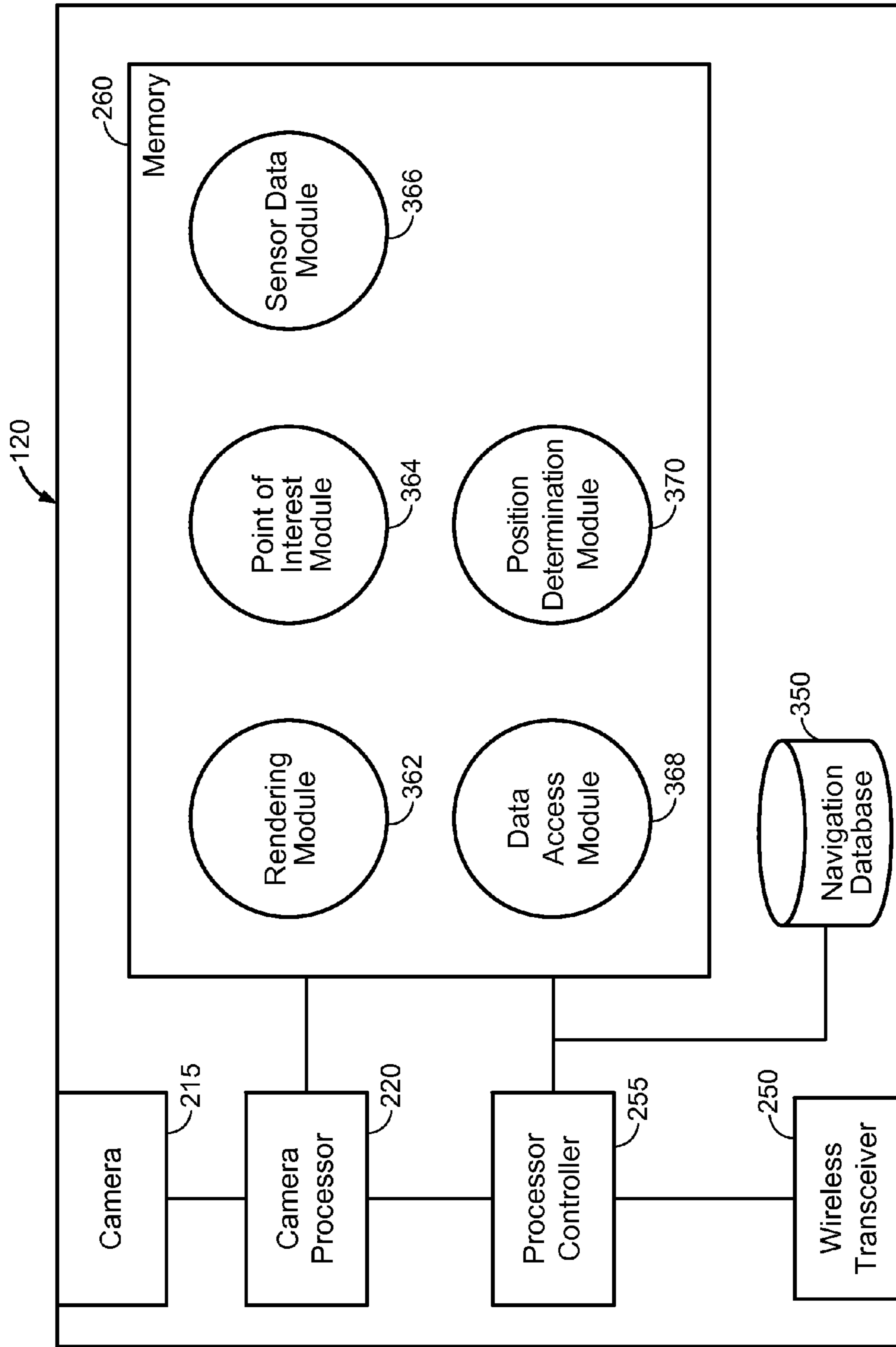

FIG. 3
Mobile Device

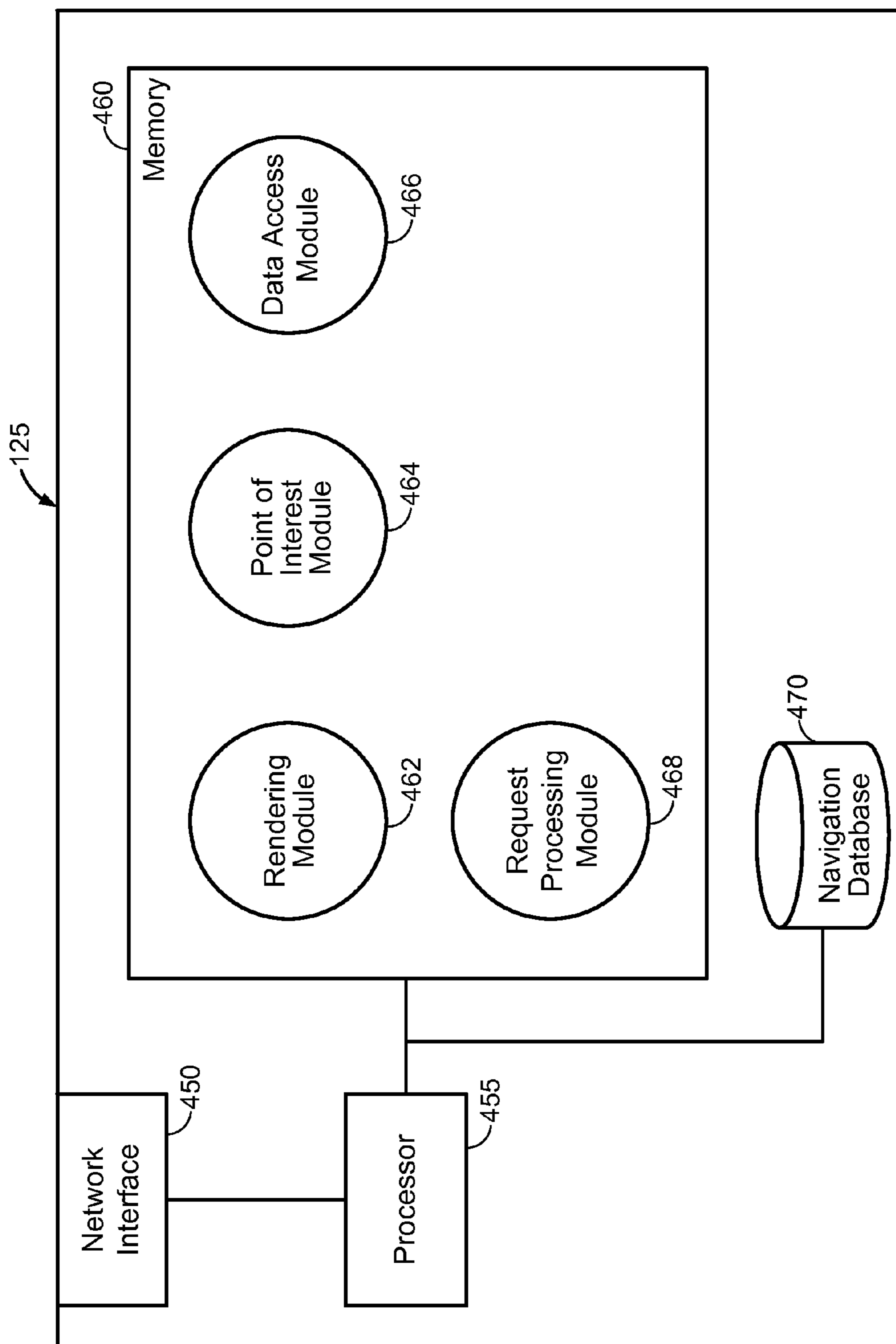

FIG. 4
Navigation Server

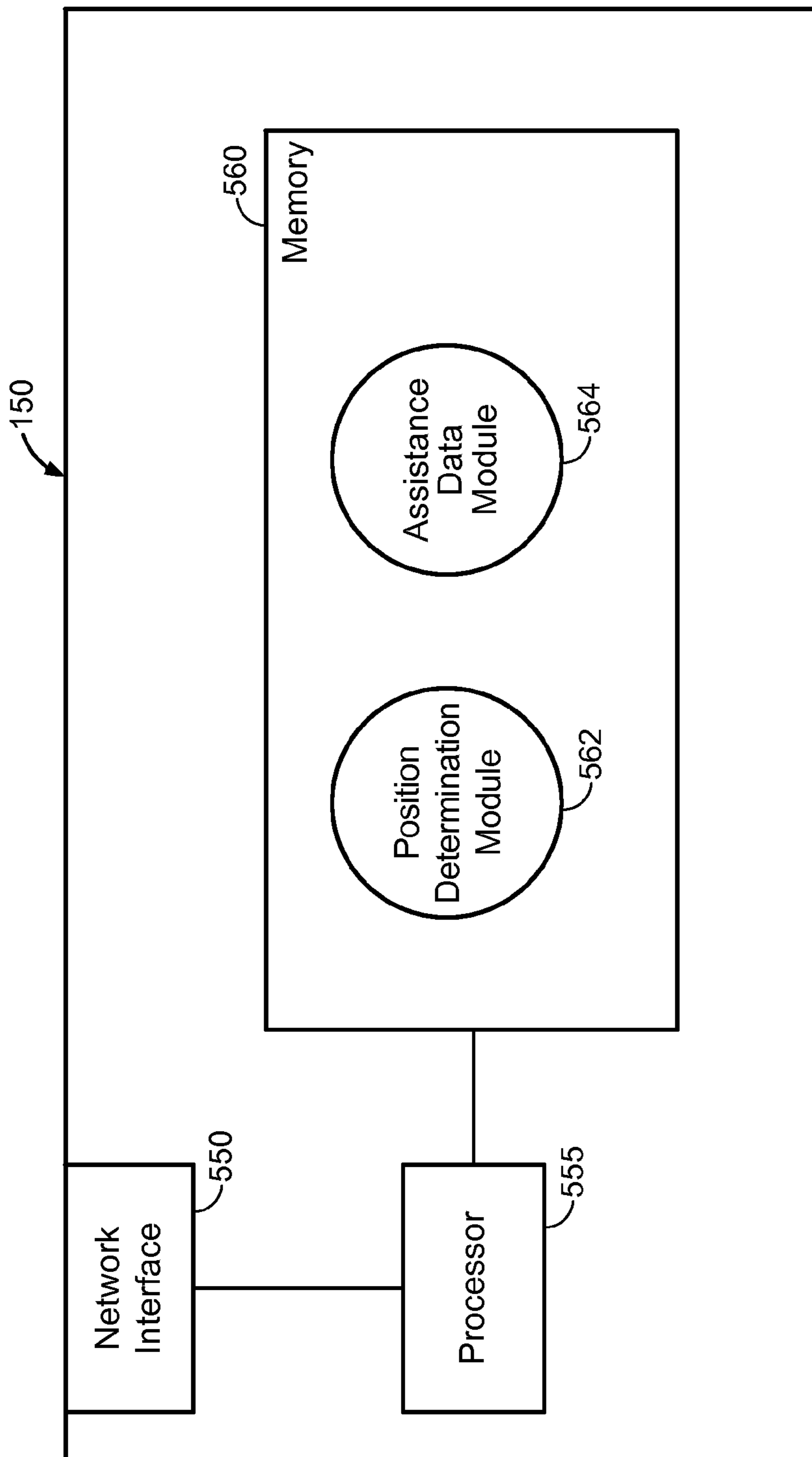

FIG. 5
Location Server

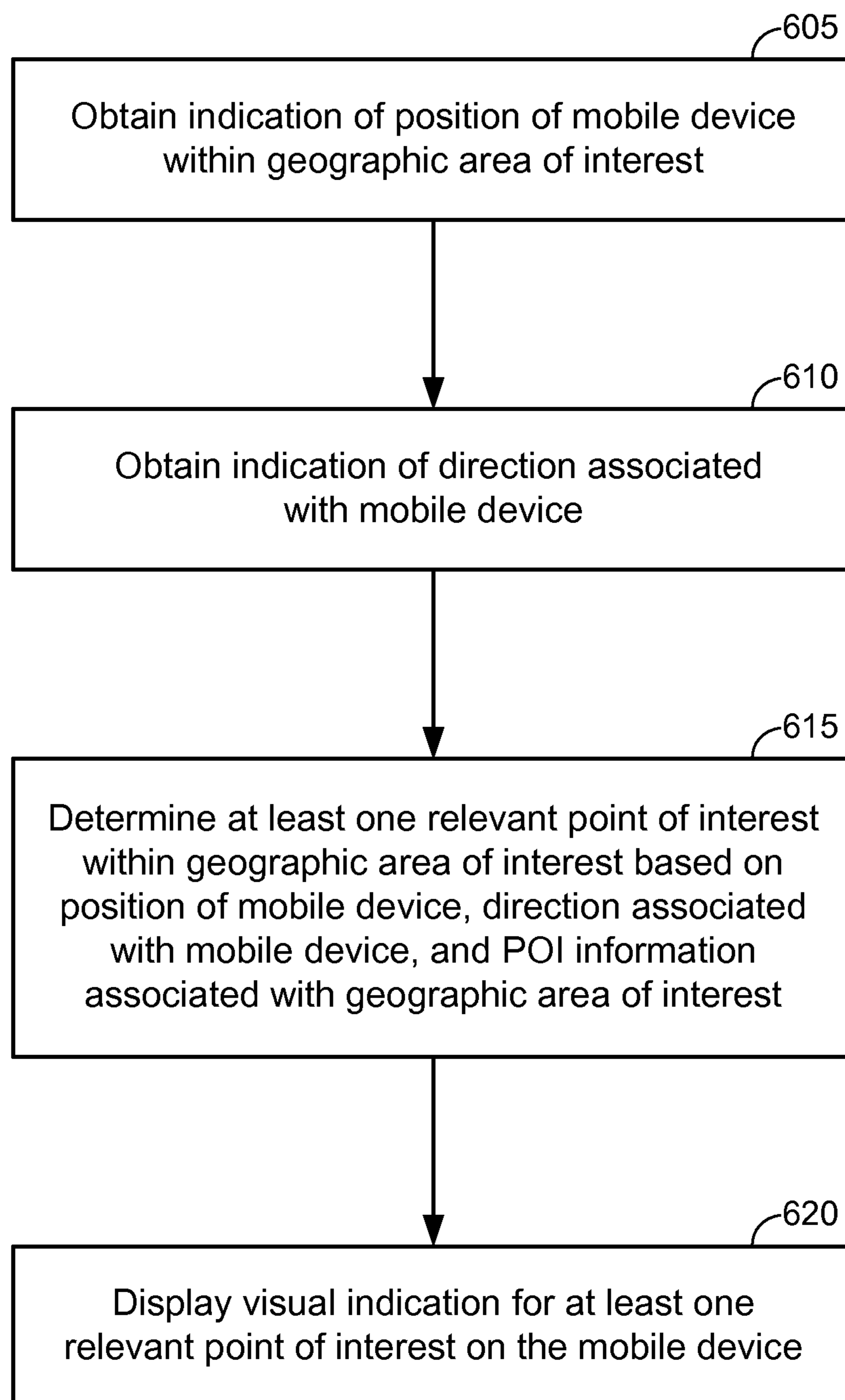

FIG. 6
Displaying Navigation
Information

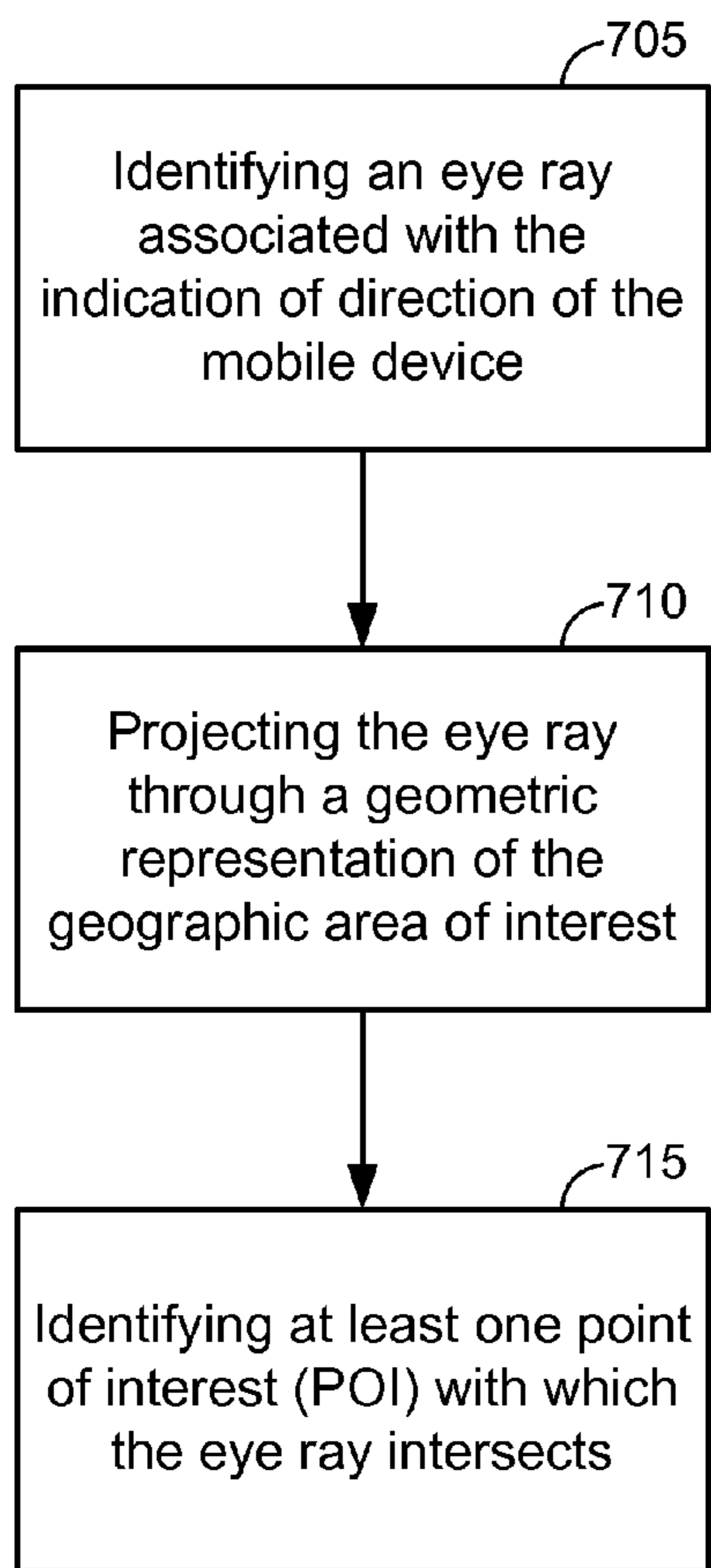

FIG. 7
Determining Relevant POIs

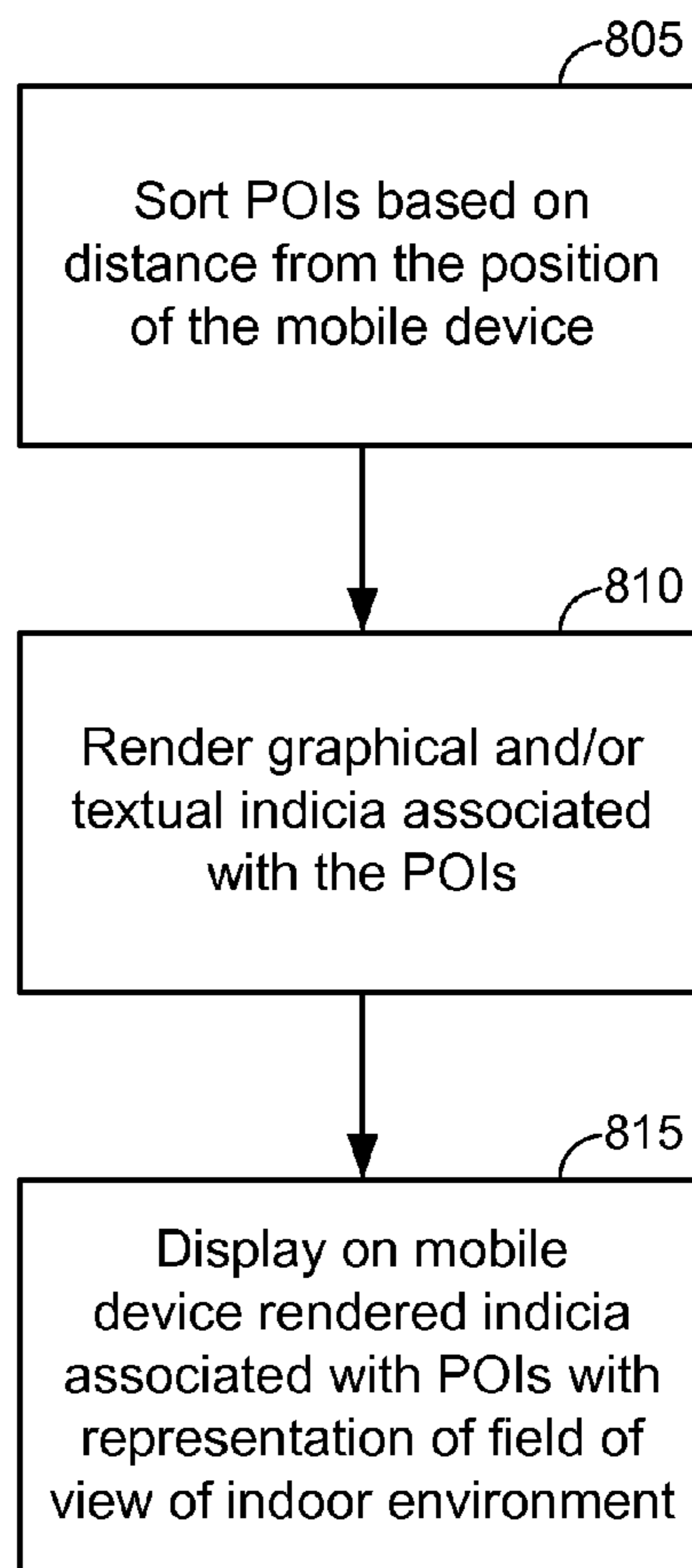

FIG. 8
Directional View

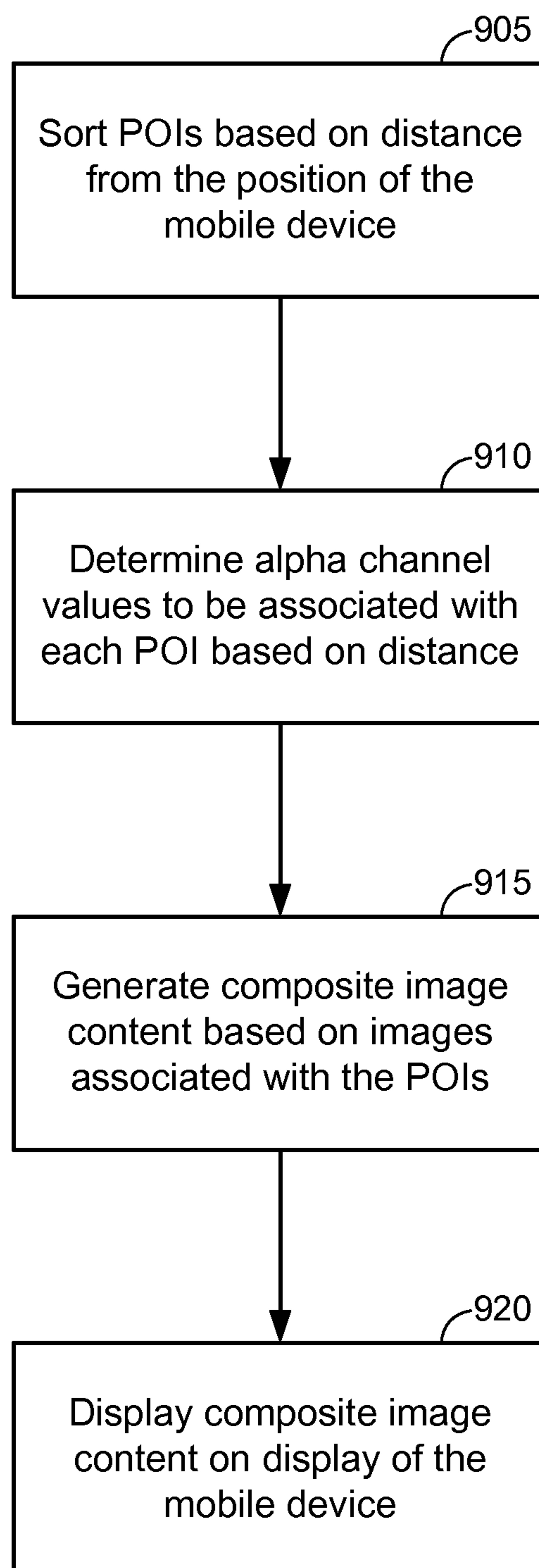

FIG. 9
X-Ray View

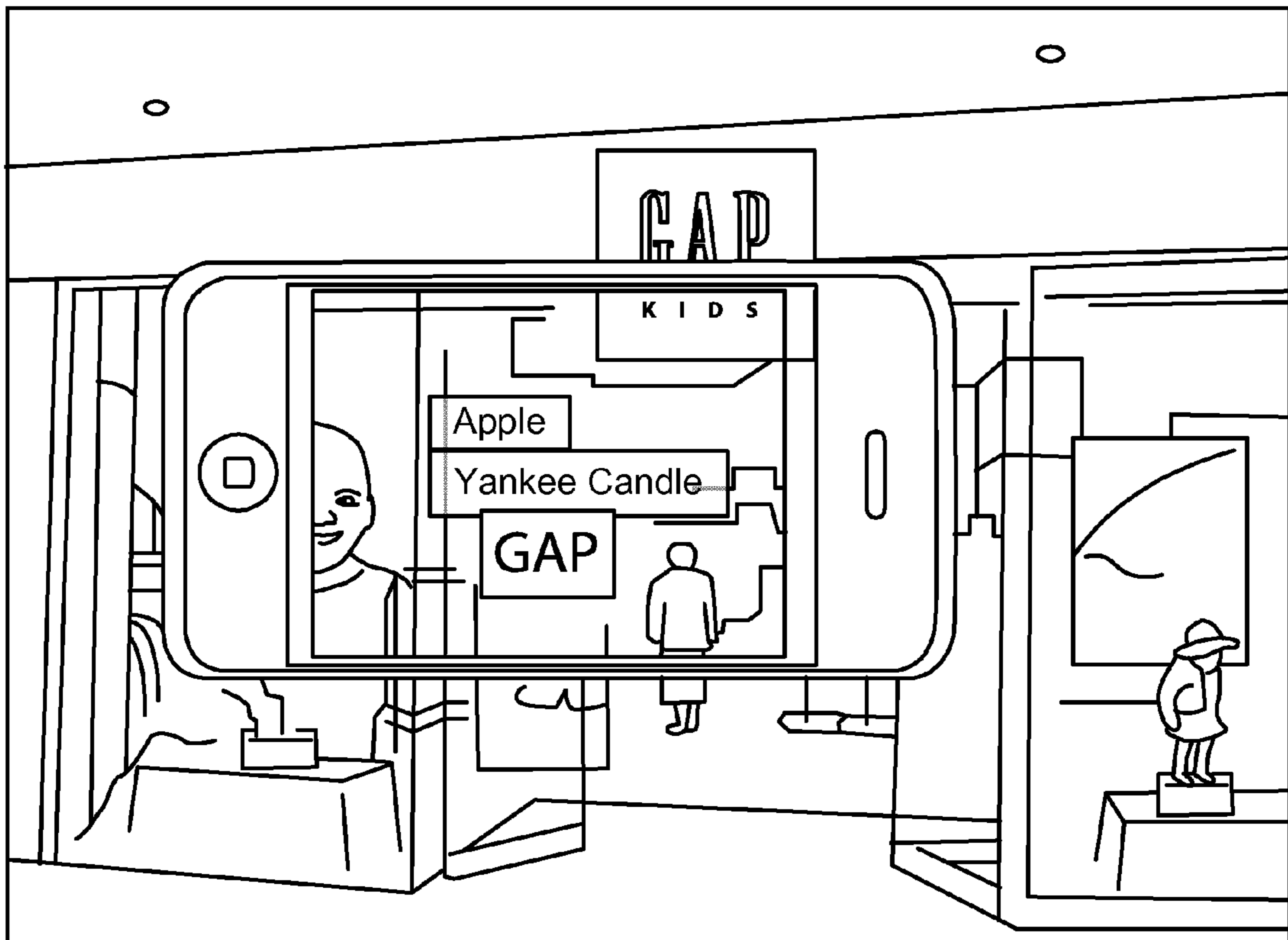

FIG. 10
Directional View

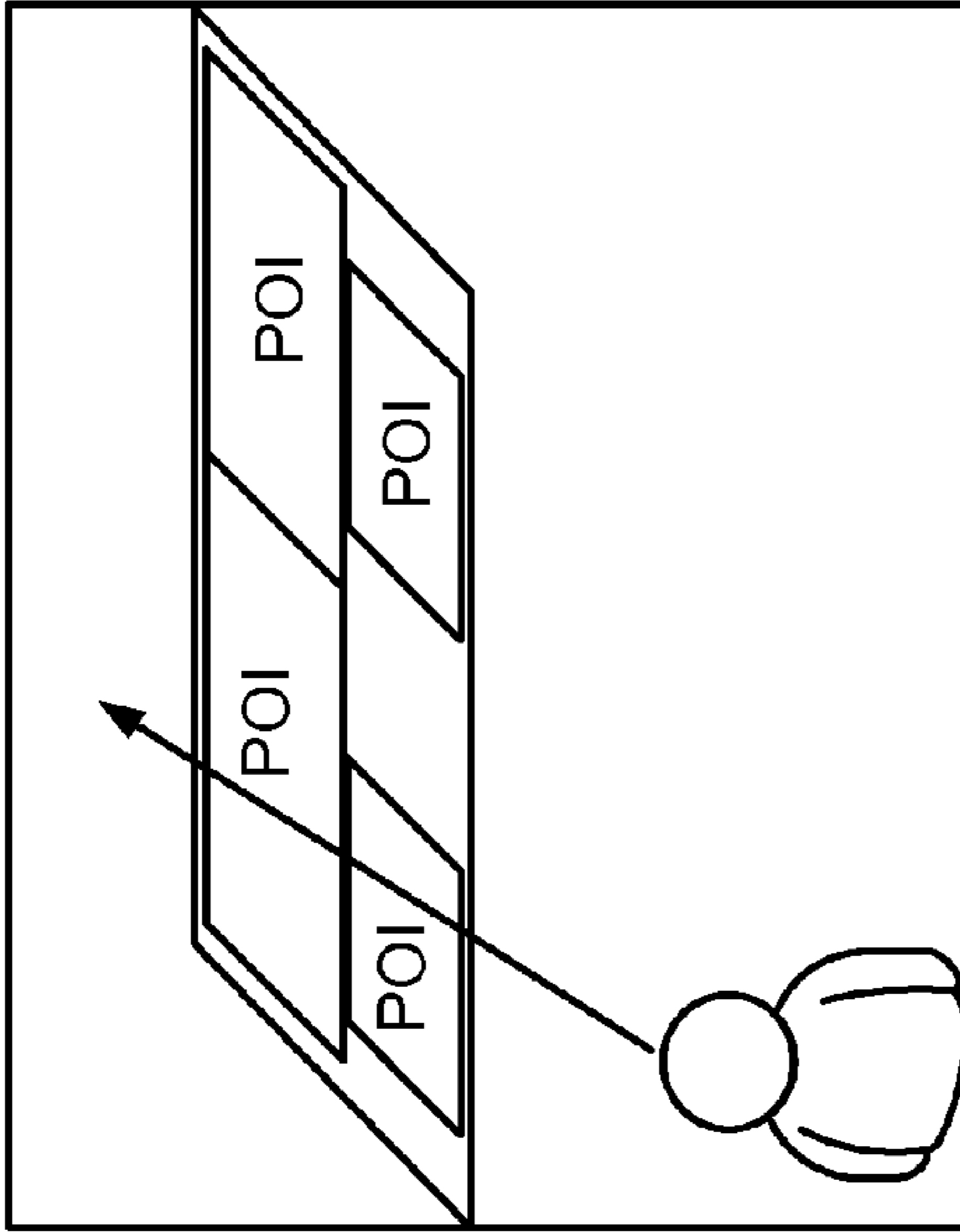

FIG. 11C
Projecting Eye Ray

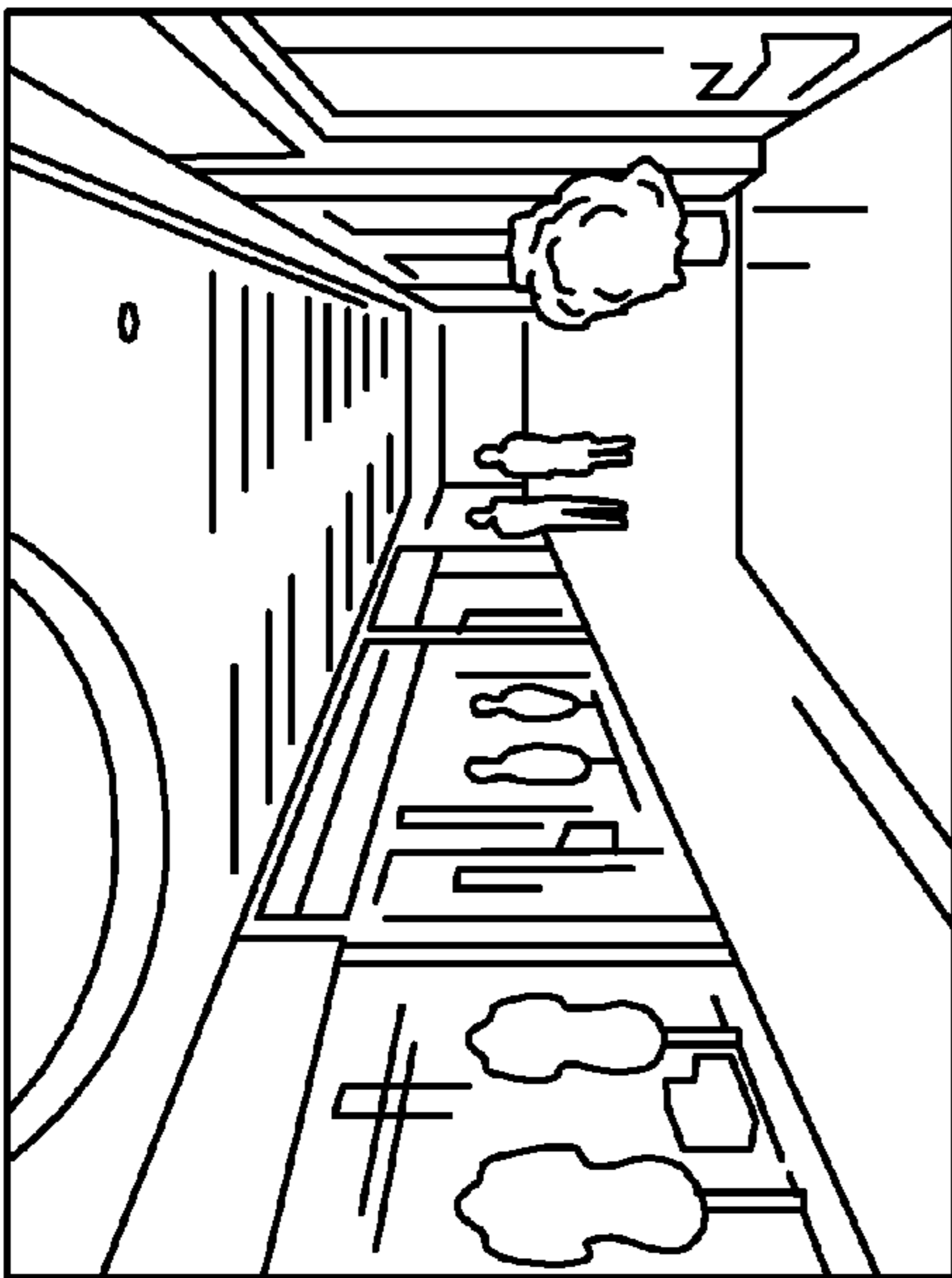

FIG. 11A
View of Corridor

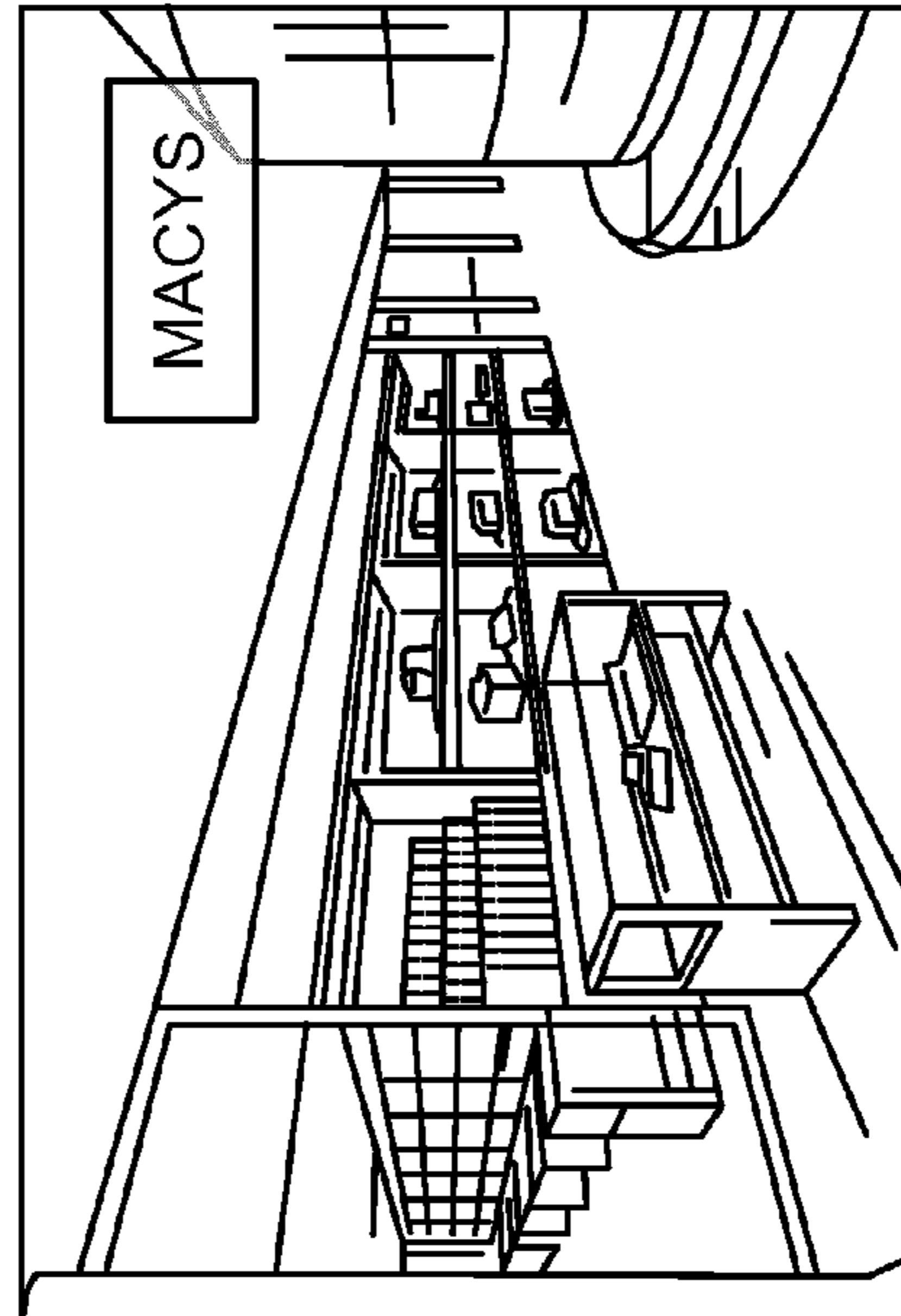

FIG. 11B
View of Inside of Store

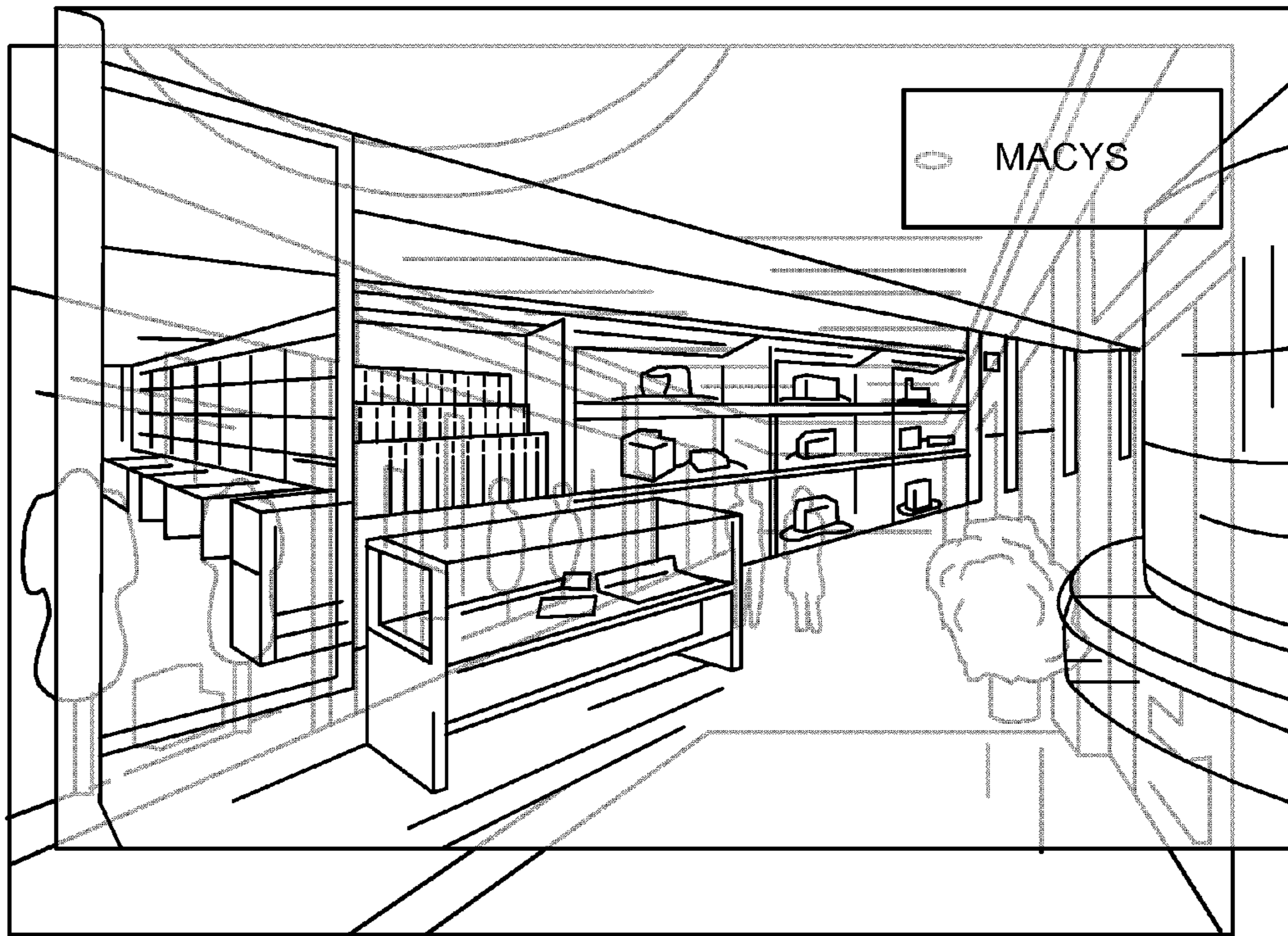

FIG. 11D
X-Ray View

1

**DIRECTIONAL AND X-RAY VIEW
TECHNIQUES FOR NAVIGATION USING A
MOBILE DEVICE**

BACKGROUND

Indoor navigation presents issues different from outdoor navigation. For example, in complex indoor environments with large open spaces, such as large departments stores or sports stadiums, navigation may be different than in outdoor environments, e.g., because “streets” or “hallways” may not be well defined, and a user may be permitted to move freely or nearly so. Providing directional guidance to a user in an indoor environment using outdoor environment techniques may therefore not work well.

SUMMARY

An example method of displaying navigation information on a mobile device according to the disclosure includes obtaining, at the mobile device, an indication of a position of the mobile device, obtaining, at the mobile device, an indication of a direction associated with the mobile device, using the indication of the position of the mobile device, the indication of the direction associated with the mobile device, information regarding identities of points of interest within a geographic region of interest, and information regarding areas associated with the points of interest to determine at least one relevant point of interest, of the points of interest, that is associated with the position and direction of the mobile device, and displaying at least one visual indication associated with each of the at least one relevant point of interest on the mobile device. An appearance of the at least one visual indication for each of the at least one relevant point of interest is dependent on at least one of a distance from the mobile device of the relevant point of interest associated with the visual indication or presence of a known physical barrier between the mobile device and that relevant point of interest associated with the visual indication.

Implementations of such a method may include one or more of the following features. The at least one visual indication associated with each of the at least one relevant point of interest has at least one of a size or a transparency of the visual indication dependent on the distance from the mobile device of the relevant point of interest. The using further comprises determining a first relevant point of interest at a first different distance from the mobile device and a second relevant point of interest at a second different distance from the mobile device that is greater than the first distance, and the displaying further comprises displaying first and second visual indications corresponding to the first and second relevant points of interest, respectively, with the first visual indication being at least one of larger or less transparent than the second visual indication. The at least one visual indication associated with each of the at least one relevant point of interest has a transparency of the visual indication dependent on the presence of the known physical barrier between the mobile device and the relevant point of interest, and wherein the relevant point of interest is disposed beyond the known physical barrier relative to the mobile device and the visual indication is transparent. The geographic area of interests comprises an indoor environment. Using the indication of the position of the mobile device, the indication of the direction associated with the mobile device, information regarding identities of points of interest within a geographic region of interest, and information regarding areas associated with the points of interest to

2

determine the at least one relevant point of interest, of the points of interest, that is associated with the position and direction of the mobile device includes: identifying at least one eye ray associated with the position of the mobile device and the indication of direction of the mobile device; projecting the eye ray through a geometric representation of the indoor environment; and identifying at least one point of interest with which the eye ray intersects as the at least one relevant point of interest. Displaying the at least one visual indication associated with each of the at least one relevant point of interest on the mobile device includes: sorting the at least one relevant point of interest based on a distance of each of the at least one relevant point of interest from the position of the mobile device; rendering at least one visual indication associated with each of the relevant points of interest; and displaying the at least one visual indication associated with each of the at least one relevant point of interest and a representation of a field of view of a camera of the mobile device. The at least one visual indication associated with each of the at least one relevant point of interest has at least one of a size or a transparency of the visual indication dependent on the distance from the mobile device of the relevant point of interest. Displaying the at least one visual indication associated with each of the at least one relevant point of interest on the mobile device includes: sorting the at least one relevant point of interest based on a distance of each of the at least one relevant point of interest from the position of the mobile device; determining an alpha channel value for each of the at least one relevant point of interest based on a distance of the at least one relevant point of interest from the position of the mobile device; generating composite image content based on a graphical indications associated with each of the at least one relevant point of interest and the alpha channel value associated with each of the at least one relevant point of interest; and displaying the composite image content on a display of the mobile device. The graphical indications associated with each of the at least one point of interest comprises an image of the relevant point of interest associated with the graphical indications.

An example apparatus for displaying navigation information on a mobile device according to the disclosure includes: means for obtaining, at the mobile device, an indication of a position of the mobile device; means for obtaining, at the mobile device, an indication of a direction associated with the mobile device; means for using the indication of the position of the mobile device, the indication of the direction associated with the mobile device, information regarding identities of points of interest within a geographic region of interest, and information regarding areas associated with the points of interest to determine at least one relevant point of interest, of the points of interest, that is associated with the position and direction of the mobile device; and means for displaying a visual indication for each of the at least one relevant point of interest on the mobile device. An appearance of the visual indication for each of the at least one relevant point of interest is dependent on at least one of a distance from the mobile device of the relevant point of interest associated with the visual indication or presence of a known physical barrier between the mobile device and that relevant point of interest associated with the visual indication.

Implementations of such an apparatus may include one or more of the following features. The at least one visual indication associated with each of the at least one relevant point of interest has at least one of a size or a transparency of the visual indication dependent on the distance from the mobile device of the relevant point of interest. The means for

3

using includes means for determining a first relevant point of interest at a first different distance from the mobile device and a second relevant point of interest at a second different distance from the mobile device that is greater than the first distance, and the means for displaying further includes means for displaying first and second visual indications corresponding to the first and second relevant points of interest, respectively, with the first visual indication being at least one of larger or less transparent than the second visual indication. The at least one visual indication associated with each of the at least one relevant point of interest has a transparency of the visual indication dependent on the presence of the known physical barrier between the mobile device and the relevant point of interest, and the relevant point of interest is disposed beyond the known physical barrier relative to the mobile device and the visual indication is transparent. The geographic area of interests comprises an indoor environment. The means for using the indication of the position of the mobile device, the indication of the direction associated with the mobile device, information regarding identities of points of interest within a geographic region of interest, and information regarding areas associated with the points of interest to determine the at least one relevant point of interest, of the points of interest, that is associated with the position and direction of the mobile device includes: means for identifying at least one eye ray associated with the position of the mobile device and the indication of direction of the mobile device; means for projecting the eye ray through a geometric representation of the indoor environment; and means for identifying at least one point of interest with which the eye ray intersects as the at least one relevant point of interest. The means for displaying the at least one visual indication associated with each of the at least one relevant point of interest on the mobile device includes: means for sorting the at least one relevant point of interest based on a distance of each of the at least one relevant point of interest from the position of the mobile device; means for rendering at least one visual indication associated with each of the relevant points of interest; and means for displaying the at least one visual indication associated with each of the at least one relevant point of interest and a representation of a field of view of a camera of the mobile device. The at least one visual indication associated with each of the at least one relevant point of interest has at least one of a size or a transparency of the visual indication dependent on the distance from the mobile device of the relevant point of interest. The means for displaying the at least one visual indication associated with each of the at least one relevant point of interest on the mobile device includes: means for sorting the at least one relevant point of interest based on a distance of each of the at least one relevant point of interest from the position of the mobile device; means for determining an alpha channel value for each of the at least one relevant point of interest based on a distance of the at least one relevant point of interest from the position of the mobile device; means for generating composite image content based on a graphical indications associated with each of the at least one relevant point of interest and the alpha channel value associated with each of the at least one relevant point of interest; and means for displaying the composite image content on a display of the mobile device. The graphical indications associated with each of the at least one point of interest comprises an image of the relevant point of interest associated with the graphical indications.

An example non-transitory computer-readable medium according to the disclosure, has stored thereon computer-

4

readable instructions for displaying navigation information on a mobile device. The instructions are configured to cause a computer to obtain, at the mobile device, an indication of a position of the mobile device; obtain, at the mobile device, an indication of a direction associated with the mobile device; use the indication of the position of the mobile device, the indication of the direction associated with the mobile device, information regarding identities of points of interest within a geographic region of interest, and information regarding areas associated with the points of interest to determine at least one relevant point of interest, of the points of interest, that is associated with the position and direction of the mobile device; and display at least one visual indication associated with each of the at least one relevant point of interest on the mobile device. An appearance of the at least one visual indication for each of the at least one relevant point of interest is dependent on at least one of a distance from the mobile device of the relevant point of interest associated with the visual indication or presence of a known physical barrier between the mobile device and that relevant point of interest associated with the visual indication.

Implementations of such a non-transitory computer-readable medium may include one or more of the following features. The at least one visual indication associated with each of the at least one relevant point of interest has at least one of a size or a transparency of the visual indication dependent on the distance from the mobile device of the relevant point of interest. The instructions configured to cause the computer to use include instructions to cause the computer to determine a first relevant point of interest at a first different distance from the mobile device and a second relevant point of interest at a second different distance from the mobile device that is greater than the first distance, and the instructions to cause the computer to display include instructions to cause the computer to display first and second visual indications corresponding to the first and second relevant points of interest, respectively, with the first visual indication being at least one of larger or less transparent than the second visual indication. The at least one visual indication associated with each of the at least one relevant point of interest has a transparency of the visual indication dependent on the presence of the known physical barrier between the mobile device and the relevant point of interest, and wherein the relevant point of interest is disposed beyond the known physical barrier relative to the mobile device and the visual indication is transparent. The geographic area of interests comprises an indoor environment. The instructions to cause the computer to use the indication of the position of the mobile device, the indication of the direction associated with the mobile device, information regarding identities of points of interest within a geographic region of interest, and information regarding areas associated with the points of interest to determine the at least one relevant point of interest, of the points of interest, that is associated with the position and direction of the mobile device include instructions to cause the computer to: identify at least one eye ray associated with the position of the mobile device and the indication of direction of the mobile device; project the eye ray through a geometric representation of the indoor environment; and identify at least one point of interest with which the eye ray intersects as the at least one relevant point of interest. The instructions to cause the computer to display the at least one visual indication associated with each of the at least one relevant point of interest on the mobile device include instructions to cause the computer to: sort the at least one relevant point of interest based on a distance of each of

5

the at least one relevant point of interest from the position of the mobile device; render at least one visual indication associated with each of the relevant points of interest; and display the at least one visual indication associated with each of the at least one relevant point of interest and a representation of a field of view of a camera of the mobile device.

The at least one visual indication associated with each of the at least one relevant point of interest has at least one of a size or a transparency of the visual indication dependent on the distance from the mobile device of the relevant point of interest. The instructions to cause the computer to display the at least one visual indication associated with each of the at least one relevant point of interest on the mobile device include instructions to cause the computer to: sort the at least one relevant point of interest based on a distance of each of the at least one relevant point of interest from the position of the mobile device; determine an alpha channel value for each of the at least one relevant point of interest based on a distance of the at least one relevant point of interest from the position of the mobile device; generate composite image content based on a graphical indications associated with each of the at least one relevant point of interest and the alpha channel value associated with each of the at least one relevant point of interest; and display the composite image content on a display of the mobile device. The graphical indications associated with each of the at least one point of interest comprises an image of the relevant point of interest associated with the graphical indications.

An example apparatus for displaying navigation information on a mobile device according to the disclosure includes a transceiver configured to transmit and receive data wirelessly; a memory configured to store processor-executable program code; and a processor. The processor is configured to obtain, at the mobile device, an indication of a position of the mobile device; obtain, at the mobile device, an indication of a direction associated with the mobile device; use the indication of the position of the mobile device, the indication of the direction associated with the mobile device, information regarding identities of points of interest within a geographic region of interest, and information regarding areas associated with the points of interest to determine at least one relevant point of interest, of the points of interest, that is associated with the position and direction of the mobile device; and display at least one visual indication associated with each of the at least one relevant point of interest on the mobile device. An appearance of the at least one visual indication for each of the at least one relevant point of interest is dependent on at least one of a distance from the mobile device of the relevant point of interest associated with the visual indication or presence of a known physical barrier between the mobile device and that relevant point of interest associated with the visual indication.

Implementations of such an apparatus may include one or more of the following features. The at least one visual indication associated with each of the at least one relevant point of interest has at least one of a size or a transparency of the visual indication dependent on the distance from the mobile device of the relevant point of interest. The processor being configured to use the indication of the position of the mobile device, the indication of the direction associated with the mobile device, information regarding identities of points of interest within a geographic region of interest, and information regarding areas associated with the points of interest to determine at least one relevant point of interest, of the points of interest, that is associated with the position and direction of the mobile device is further configured to

6

determine a first relevant point of interest at a first different distance from the mobile device and a second relevant point of interest at a second different distance from the mobile device that is greater than the first distance, and wherein the processor being configured to display at least one visual indication associated with each of the at least one relevant point of interest on the mobile device is further configured to display first and second visual indications corresponding to the first and second relevant points of interest, respectively, with the first visual indication being at least one of larger or less transparent than the second visual indication. The at least one visual indication associated with each of the at least one relevant point of interest has a transparency of the visual indication dependent on the presence of the known physical barrier between the mobile device and the relevant point of interest, and wherein the relevant point of interest is disposed beyond the known physical barrier relative to the mobile device and the visual indication is transparent. The geographic area of interests comprises an indoor environment. The processor being configured to use the indication of the position of the mobile device, the indication of the direction associated with the mobile device, information regarding identities of points of interest within a geographic region of interest, and information regarding areas associated with the points of interest to determine the at least one relevant point of interest, of the points of interest, that is associated with the position and direction of the mobile device is further configured to: identify at least one eye ray associated with the position of the mobile device and the indication of direction of the mobile device; project the eye ray through a geometric representation of the indoor environment; and identify at least one point of interest with which the eye ray intersects as the at least one relevant point of interest. The processor being configured to display at least one visual indication associated with each of the at least one relevant point of interest on the mobile device is further configured to: sort the at least one relevant point of interest based on a distance of each of the at least one relevant point of interest from the position of the mobile device; render at least one visual indication associated with each of the relevant points of interest; and display the at least one visual indication associated with each of the at least one relevant point of interest and a representation of a field of view of a camera of the mobile device. The at least one visual indication associated with each of the at least one relevant point of interest has at least one of a size or a transparency of the visual indication dependent on the distance from the mobile device of the relevant point of interest. The processor being configured to display the at least one visual indication associated with each of the at least one relevant point of interest on the mobile device is further configured to: sort the at least one relevant point of interest based on a distance of each of the at least one relevant point of interest from the position of the mobile device; determine an alpha channel value for each of the at least one relevant point of interest based on a distance of the at least one relevant point of interest from the position of the mobile device; generate composite image content based on a graphical indications associated with each of the at least one relevant point of interest and the alpha channel value associated with each of the at least one relevant point of interest; and display the composite image content on a display of the mobile device. The graphical indications associated with each of the at least one point of interest comprises an image of the relevant point of interest associated with the graphical indications.

Items and/or techniques described herein may provide one or more of the following capabilities, as well as other capabilities not mentioned.

BRIEF DESCRIPTIONS OF THE DRAWINGS

FIG. 1 is a simplified diagram of a wireless communication system.

FIG. 2 is a functional block diagram of a mobile device that can be used to implement the mobile devices illustrated in FIG. 1.

FIG. 3 is a functional block diagram of the mobile device illustrated in FIG. 1 that illustrates functional modules of a memory shown in FIG. 2.

FIG. 4 is a functional block diagram of a computer system that can be used to implement the navigation server illustrated in FIG. 1.

FIG. 5 is a functional block diagram of a computer system that can be used to implement the location server illustrated in FIG. 1.

FIG. 6 is a block flow diagram of a process for displaying navigation information on a mobile device.

FIG. 7 is a block flow diagram of a process for determining a relevant set of points of interest.

FIG. 8 is a block flow diagram of a process for determining displaying on the display of the mobile device a directional view of relevant points of interest within a field of view of a camera of a mobile device.

FIG. 9 is a block flow diagram of a process for determining displaying an X-ray view of points of interest within a field of view of a camera of a mobile device on a display of the mobile device.

FIG. 10 provides an example of a mobile device displaying a directional view of POIs within the field of view of the camera of the mobile device.

FIGS. 11A, 11B, 11C, and 11D provide an example of a how an X-ray review of a geographical area of interest can be created from an image of the area of geographical interest (FIG. 11A), an image associated with a POI (FIG. 11B), an illustration of an eye-ray being projected from the current position of the mobile device through a 2D model of the geographic area of interest (FIG. 11C), and an X-ray view generated based on the image of the geographical area of interest and the image associated with the POI (FIG. 11D).

DETAILED DESCRIPTION

Techniques are provided for assisting with navigation through an indoor environment and/or through a combination of indoor and outdoor environments using a mobile device. The indoor and/or combination of indoor and outdoor environment for which the navigation technique provided herein are generally referred to as a “geographical area of interest.” The techniques provided can assist with navigation through a geographical area of interest comprising an indoor environment, such as an office building, shopping mall, a hotel, government offices, event venue, or other indoor environment. The techniques provided can also assist with navigation thorough a geographical area of interest comprising a combination of indoor and outdoor environments, such as a corporate campus or a university campus that are a combination of both indoor and outdoor spaces. The techniques provided could also be applied to other areas where a user may wish to navigate from an outdoor area to an indoor area or vice versa, such as downtown area or a shopping district where the user may wish to navigate from

a street level into one or more buildings or vice versa and to be able to view POIs within the geographical area of interest.

The navigation techniques provided can present visual indications of points of interest (POIs) to a user of a mobile device. The POIs presented to the user can include POIs that are not visible to the user and/or to a camera of the mobile device. The visual indications of the POIs can include textual and/or graphical indications of the POIs. The visual indications of the POIs can be provided in the direction of the POIs from the mobile device and can include indications of how far the POIs are from the position of the mobile device. The visual indications can also indicate whether each POI is beyond a physical barrier (e.g., a wall, floor, or ceiling) of a building within the geographic area of interest. The visual indications can provide a sense of distances of the POIs from the position of the mobile device, e.g., with decreasing size of indications with increasing distance from the mobile device and/or increasing transparency of the indications with increasing distance from the mobile device.

In an example implementation, a mobile device, such as a mobile phone or tablet computer, can determine the position and orientation of the mobile device. Using the position and orientation, the mobile device can be configured determine a viewing direction or field of view (FOV) of a camera of the mobile device. The mobile device can compare the FOV with a two-dimensional (2D) or three-dimensional (3D) map that includes locations and areas corresponding to the POIs. The mobile device can provide visual indications on a display of the mobile device as to the POIs that are within the FOV of the camera of the mobile device based on the current position and orientation of the mobile device.

FIG. 1 is a simplified diagram of an example wireless communication system in which the techniques for improved navigation of an indoor environment disclosed herein can be implemented. In the example illustrated in FIG. 1, the wireless network environment includes wireless access points **115** (where each instance of a wireless access point is labeled with a separate letter—e.g., **115a**, **115b**, and **115c**), a base station **140**, a plurality of mobile devices **120** (where each instance of which is labeled with a separate letter—e.g., **120a**, **120b**), a network **110**, a navigation server **125**, a location server **150**.

The example network environment illustrated in FIG. 1 includes a three wireless access points **115a**, **115b**, and **115c**, but other network environments that can be used to implement the techniques disclosed herein may include more wireless access points. Furthermore, the wireless access points may be distributed throughout an indoor environment and may be placed on different floors within the indoor environment. The term “access point” is used for simplicity, but refers to communication devices, more generally, one example of which include access points in wireless local area networks, such as IEEE 802 series compliant networks including the IEEE 802.11 family of standards commonly referred to as Wi-Fi. For example, devices that use Bluetooth can be communication devices according to the disclosure. As such, the usage of the term access point is not exclusive of other kinds of communication networks. Furthermore, a wireless access point **115** can be configured to implement other wireless communications standards in addition or instead of standards from the IEEE 802 series. The wireless access point **115** can also be implemented as a femtocell or picocell that is configured to operate a base station for a mobile communications network. A wireless access point **115** can either be located at a fixed location or may be mobile. For example, a wireless access point **115** can be a

mobile device that is configured to provide a WiFi hotspot and is configured to wirelessly connect to a mobile communication network, e.g. a WAN to provide network connectivity to the WiFi hotspot.

The base station **140** can be configured to wirelessly communicate with a plurality of mobile devices, such as mobile devices **120a** and **120b**. The base station **140** may be located within the indoor environment and/or may provide a coverage area that overlaps with at least a portion of the indoor environment. The base station **140** can be associated with a mobile communications network provider and can be configured to communication using one or more wireless communications protocols for mobile devices. For example, the base station **140** can be configured to use on more of the wireless communications protocols, such as Code Division Multiple Access (CDMA), Time Division Multiple Access (TDMA), Frequency Division Multiple Access (FDMA), Orthogonal FDMA (OFDMA), and Single-Carrier FDMA (SC-FDMA), Long Term Evolution (LTE), and/or other wireless communications protocols. For example, the base station **140** can be an evolved Node B (eNB) in a wireless communication system implementing the LTE wireless communications standards. The wireless communications discussed herein are only examples of some of the types of wireless protocols that may be implemented by the base station **140**, and are not intended to limit the techniques discussed herein to wireless communication networks using these protocols. The network environment illustrated in FIG. **1** only illustrates a single base station **140**, but an indoor environment such as those where the techniques disclosed herein may be implemented may be within the coverage area of multiple base stations **140**.

The example network environment illustrated in FIG. **1** also includes two mobile devices **120a** and **120b**, but other network environments that can be used to implement the techniques disclosed herein may include either more or less mobile devices. The mobile devices **120a** and **120b** can be configured to communicate with one or more servers, such as navigation server **125** and/or location server **150**. The mobile devices **120a** and **120b** can be configured to communicate with the servers through one of the wireless access points **115** or the wireless base station **140**.

The navigation server **125** can be configured to store electronic content, such as applications, that can be provided to one or more mobile devices **120** and can be executed by the mobile devices **120**. In other implementations, the network environment may contain other servers (not shown) that can also be configured to provide information and/or electronic content to the mobile devices **120a** and **120b**. The navigation server **125** can be configured to provide 2D and/or 3D map information for indoor environments to the mobile devices **120**. The navigation server **125** may be implemented by an owner or manager of an indoor environment or may be implemented by a third party, such as a wireless network service provider. An example implementation of a navigation server that can be used to implement the navigation server **125** is provided in FIG. **4**.

The location server **150** can be configured to provide location based services, such as determining the position of the mobile device **120** and/or providing assistance data that the mobile devices **120** can use to determine the position of the mobile devices **120**. An example implementation of a navigation server that can be used to implement the navigation server **125** is provided in FIG. **5**. In some implementations, the navigation server **125** and the location server **150** can be implemented on the same server.

FIG. **2** is an example of a system architecture that can be used to implement a mobile device, such as the mobile devices **120a** and **120b** illustrated in FIG. **1**. A mobile device **120** may include some or all of the components illustrated in FIG. **2** and may include additional components illustrated in FIG. **3** and can be configured to implement various functions, such as the processes illustrated in FIGS. **6-9** described in detail below.

The mobile device **120** can include sensors **205** (e.g., gyros, accelerometers, an inertial measurement unit (IMU) and/or other types of sensors) and a sensor processor **210** for processing data collected by the sensors **205**. Data collected by the sensors or the camera may be used to determine an orientation of the mobile device, acceleration or velocity of the mobile device, and/or other information that may be useful in determining the location of the mobile device **120**. The data collected by the sensor **205** can also be used to provide inputs to one or more applications on the mobile device **120**. The mobile device **120** can be configured to use the data collected by the sensors **205** to determine how the mobile device **120** is oriented and can use that information in addition to the estimated position of the mobile device within an indoor environment to determine a field of view associated with the mobile device within the indoor environment and to display that field of view on the mobile device **120**. The field of view into the indoor environment can provide the user with an augmented view of the indoor environment in which they are located that can assist the user in navigating through the indoor environment.

The mobile device **120** can also include a camera **215** and a camera processor **220**. The camera **215** can be configured to capture images and/or video content. The camera processor **220** can be configured to process the data collected by the camera **215** and to convert the data collected by the camera into a format that can be used by one or more applications on the mobile device **120** and/or viewed on the display **225** of the mobile device **120**. The camera processor **220** can be configured to perform various types of image or video processing on the data collected from the camera to prepare the content for display on display **225**. For example, the camera of the mobile device **120** can be configured to capture images and/or video within the field of view of the camera **215** of the mobile device **120**. The mobile device **120** can be configured to use the captured images and/or video to provide an augmented view of the indoor environment to the user of the mobile device that can include point of interest (POI) information. For example, the mobile device **120** can be configured to provide a directional view that can include textual and/or graphical indications identifying the position of POIs relative to the position of the mobile device **120** and/or an X-ray view where POI information for POIs that may otherwise be occluded from view by components of the indoor environment, such as doors, walls, ceilings, and floors, can be displayed to the user. Camera processor **220** may also be used to determine how the mobile device **120** is oriented.

The display **225** can be a touch screen interface that includes touch sensor **235**. The graphics processor **230** can be used to generate graphical data for display on display **225**. Applications on the mobile station **12** and/or other executable programs, such as the operating system and the positioning engine, can be implemented in software and/or hardware and can be configured to send commands to the graphics processor **230** to display image or video content on the display **225**. The touch sensor processor **240** can process data output by the touch sensor **235** to identify when a user touches the touch screen. The touch sensor processor **240**

can be configured to identify various touch gestures, including multi-finger touches of the touch screen. The operating system, applications, and/or the positioning engine can use the gesture information determined by the touch sensor processor 240 to determine, at least in part, receive and respond to user input. The display 225 of the mobile device 120 can be a 2D display or can be a 3D display capable of displaying stereoscopic images. The mobile device 120 can be configured to render 2D and/or 3D content depending upon the capabilities of the display 225 and the configuration of the mobile device 120.

The communications controller 250 can be configured to enable the device to communicate using one or more wireless protocols and to enable the mobile device to communicate with one more devices via the network 110. The communications controller 250 can be configured to allow the device to send and receive data from nearby wireless devices, including wireless access point and other mobile devices 120. For example, the communications controller 250 can be configured to enable the mobile device 120 to communicate either directly or indirectly with the wireless access points 115, the base station 140, the navigation server 125, the location server 150, and other mobile devices 120. The communications controller 250 can also be configured to enable the mobile device 120 to receive navigation signals that the mobile device 120 can use to determine its location. For example, the communications controller 250 can be configured to receive signals from satellite vehicles (SVs) belonging to one or more Satellite Positioning Systems (SPSs), such as the GPS system, the GLONASS system, the Galileo system, and/or other SPSs.

The memory 260 includes volatile and/or persistent memory for storing data used by various components of the mobile device 120. The memory 260 can be used to store processor-executable program code for one or more of the processors included in the device. The processor controller 255 can be configured to control one or more of the sensor processor 210, camera processor 220, the graphics processor 230, and the touch sensor processor 240. One or more of the sensor processor 210, camera processor 220, the graphics processor 230, and the touch sensor processor 240 may also be implemented by the processor controller 255. The processor controller 255 can also be configured to execute processor-executable program code.

FIG. 3 is a functional block diagram of the mobile device illustrated in FIG. 1 that illustrates functional modules of a memory shown in FIG. 2. For example, the mobile device 120 can include a rendering module 362, a point of interest module 364, an orientation determination module 366, a data access module 368, and a position determination module 370. The mobile device 120 can also include a navigation database 350.

The rendering module 362 can be configured to render an augmented view of an indoor environment that can improve navigation through a geographic area of interest. The rendering module 362 can be configured to render a view of an indoor and/or outdoor environment that overlays and/or blends augmented content with images and/or video captured by the camera 215 of the mobile device 120. The rendering module 362 can be configured to display a representation of the “field of view” of the camera 215 of the mobile device 120 on the display 225 of the mobile device 120. The camera can be configured to capture a series of still images or video of a portion the geographic area of interest within the field of view of the camera 215 and the rendering module 362 can be configured to receive the series of still images and/or video captured by the camera and to augment

the received content with navigational aids. The navigational aids can provide visual indications of the locations of points of interest (POIs) relative to the position of the mobile device 120 within the indoor environment. The rendering module 362 can be configured to provide a directional view of the geographical area of interest and an X-ray view of the geographical area of interest that can provide navigational clues to a user of the mobile device 120 that can assist the user of the mobile device 120 in navigating the indoor and/or environments comprising the geographic area of interest. The mobile device 120 can be configured to display the directional view and/or the X-ray view.

The rendering module 362 can be configured to obtain the current position of the mobile device 120 from the position determination module 370 and/or the location server 150 and the orientation of the mobile device 120 from the orientation determination module 366. The rendering module 362 can be configured to provide the position and orientation of the mobile device to the point of interest (POI) module 364 to obtain POI information for points of interest within the field of view of the mobile device 120. The POI information can be sorted by relative distance of each of the POIs from the current position of the mobile device 120 and can include a graphical and/or textual indications associated with each of the POIs.

When the mobile device 120 is configured to operate in the directional view, the rendering module 362 can be configured to provide an augmented view of the geographic area of interest that includes overlays of textual and/or graphical indications illustrating the relative position of POIs within the geographic area of interest. Once the rendering module 362 has obtained the POIs from the POI module 364, the rendering module 362 can be configured to generate the augmented view of the geographic area of interest by overlaying the graphical and/or textual indications associated with each POI within the field of view of the camera onto the series of images and/or video content captured by the camera 215 of the mobile device 120. For example, when used in an indoor shopping mall, the directional view of an indoor environment could be used to display POIs typically founds in a shopping mall, such as restrooms, fitting rooms, store locations, and mall exits. FIG. 10 provides an example of a mobile device 120 displaying a directional view of POIs within the field of view of the camera 215 of the mobile device 120.

The rendering module 362 can be configured to include the textual and/or graphical indications associated with each of the POIs in the field view in the augmented view of the indoor environment generated by the rendering module 362. The rendering module 362 can be configured to place the textual and/or graphical indications associated with each of the POIs within the augmented view of the indoor environment based on their position of each of the POIs relative to the current position of the mobile device 120. The rendering module 362 can be configured to render the textual and/or graphical indications associated with POI to indicate the relative distance of the POI from the current position of the mobile device 120. For example, the rendering module 362 can be configured render the textual and/or graphical indications associated with POIs that are closer to current position of the mobile device 120 such that the textual and/or graphical indications are larger than the textual and/or graphical indications associated with POIs that are farther from the current position of the mobile device 120. The rendering module 362 can also be configured to use other methods to indicate the distance of the POIs from the current position of the mobile device, such as color coding the

textual and/or graphical indications, rendering the textual and/or graphical indications using different levels of transparency based on the distance of the POIs from the current position of mobile device, or using different textures when rendering the textual and/or graphical indications to represent different distances from the current position of the mobile device **120**. For example, the textual and/or graphical indications associated with POIs that are closer to the current position of the mobile device **120** can be rendered as opaque while the textual and/or graphical indications associated with POIs that are farther from the mobile device **120** can be rendered as increasingly transparent based on their distance from the current position of the mobile device **120**.

When the mobile device **120** is configured to operate in the X-ray view, the rendering module **362** can be configured to provide an augmented view of the indoor environment that can illustrate details of POIs that would otherwise be blocked by objects in the field of view of the mobile device **120**, including components of the indoor environment and/or other POIs. When rendering the X-ray view, the rendering module **362** can be configured to first obtain a set of POIs from the POI module **364** as described above. Each POI can include one or more images associated with the POI, and the rendering module **362** can be configured to render a composite image of the indoor environment based on the series of images and/or video captured by the mobile device **120** and the images associated with the POIs that fall within the field of view of the mobile device **120**. The rendering module **362** can be configured to request that the POIs retrieved by the POI module **364** be ordered based on the distance between each of the POIs and the current position of the mobile device **120**. The rendering module **362** can then generate an augmented view where an image associated with the POI is rendered as semi-transparent based on the distance of the POI from the current position of the mobile device **120**. In one implementation, the rendering module **362** can be configured to use alpha compositing to generate the augmented view where the image associated with each of the POIs is associated with an alpha channel value that falls within a range of completely opaque to completely transparent. The rendering module **362** can be configured to assign an alpha channel value representing a higher transparency to those POIs farther from the current position of the mobile device **120** and an alpha channel value representing a lower transparency to those POIs closer to the current position of the mobile device **120**. The rendering module **362** can then be configured to render a composite image of the field of view of the mobile device **120** by compositing the field of view content captured by the camera **225** with the POI images, starting with those POIs farther from the current position of the mobile device **120**. The resulting composite image provides X-ray view of the indoor environment that can allow the user to see through walls of the indoor environment to see details that the user would not otherwise be able to see from their vantage point.

FIGS. **11A**, **11B**, **11C**, and **11D** provide an example of how an X-ray review of a geographical area of interest can be created from an image of the area of geographical interest. The image illustrated in FIG. **11A** is an image of a geographical area of interest captured by the camera **215** of the mobile device **120**. In this example, the geographical area of interest is a shopping mall, and the image illustrated in FIG. **11A** is of a corridor of the shopping mall. FIG. **11B** is an image associated with that a POI. In this example, the POI is an image of the interior of a department store within the shopping mall. FIG. **11C** is a figure illustrating projecting an eye ray from the current position of the mobile device

120 through a 2D map of the geographic area of interest. The 2D map in this example is a 2D map of the shopping mall. The eye ray projection technique is illustrated in FIG. **7** and is discussed in greater detail below. The process illustrated in FIG. **7** can also be used to identify POIs relevant POIs that can be displayed using the directional view. FIG. **11D** provides an example of an X-ray view of a POI. In this example, the view of the corridor representing the field of view of the camera **215** of the mobile device **120** that is illustrated in FIG. **11A** has been rendered as transparent. The relevant POIs can then be overlaid over the image of the field of view of the camera **215** and rendered as partially transparent. In the example illustrated in FIG. **11D**, only one POI has been included. However, if multiple relevant POIs were identified within the field of view of the camera **215**, the POIs could be sorted based on their distance from the current position of the mobile device **120**, and the textual and/or graphical indications associated with those POIs can then be rendered from farthest away to closest to the current position of the mobile device **120**. A decreasing transparency level (alpha channel value) can be applied to the POIs that are closer to the current position of the mobile device **120**. The X-ray view illustrated in FIG. **11D** provides the user of the mobile device **120** with a view through the walls of the corridor to see a representation of the department store that is behind the walls of the corridor.

The rendering module **362** can be configured to request and receive updates to the position of the mobile device **120** from the position determination module **370** and/or the location server **150**. For example, the rendering module **362** can be configured to automatically receive updates from the position determination module **370** and/or the location server **150** when the position of the mobile device **120** changes. The rendering module **362** can also be configured to receive updates from the orientation determination module **366** when the orientation of the mobile device changes **120**. The rendering module **362** can be configured to automatically update the augmented view (directional view, X-ray view, or other augmented view) generated for display on the display **225** of the mobile device **120** in response to changes to the position and/or the orientation of the mobile device **120**.

The point of interest (POI) module **364** can be configured to identify points of interest within the field of view of the mobile device **120**. The rendering module **362** can be configured to obtain the current position of the mobile device **120** within the geographical area of interest from the position determination module **370** and/or from the location server **150** and to provide the location of the mobile device **120** to the point of interest module **364**. The rendering module **362** can also be configured to obtain orientation information for the mobile device **120** from the orientation determination module **366**. The POI module **364** can be configured use the position and orientation information to identify a set of one or more POIs that are in the direction of the field of view of the mobile device **120**. The POIs may or may not be visible from the current position of the mobile device **120**. The POIs may be behind other objects in the field of view of the camera. For example, the POIs may be behind physical barriers, such as components of the geographical area of interest, including walls, doors, floors, ceilings, or other components of the geographical area of interest. The POI module **364** can be configured to order the set of POIs by their relative distance from the current position of the mobile device **120** and can be configured to mark each POI to indicate whether the POI may be visible

from the current position of the mobile device or whether the POI is obscured behind another component of the geographical area of interest.

The POI module 364 can be configured to access POI data from the navigation database 350 via the data access module 368. The data access module 368 can be configured to access the POI information for the geographical area of interest, and to provide the POI data to the POI module 364. For example, the data access module 368 can be configured to access the POI information for a particular indoor environment or portion of an indoor environment associated with the geographic area of interest, such as a floor of the indoor environment.

The navigation database 350 can include POI information associated with POIs. For example, the POI information associated with the POI can include geometry information defining the boundaries of the POI. For example, the POI information can include a set of one or more polygons defining the boundaries of the POI. The POI information can also include coordinates associated with the POI. The coordinates can be expressed in geographic coordinates (e.g., latitude and longitude) or expressed in a self-defined coordinate system where the coordinates of each of the POIs for the geographic area of interest is normalized to a bounding area. The information associated with the POI can also include images of the POIs that can be used to represent the POI in the X-ray view of the geographic area of interest and can include textual and/or graphical labels that can be used to represent the POI in the directional view of the geographic area of interest provided by the rendering engine 362.

The POI module 364 can be configured to identify which POIs are relevant using a process similar to that illustrated in FIG. 7. The POI module 364 can be configured to project an “eye ray” through a 2D or 3D geometric representation of the geographic area of interest. The eye ray can be projected through the geometric representation of the geographic area of interest and those POIs which with the eye ray intersect can be selected as relevant POIs. The relevant POIs may not directly be within the line of sight of the camera 215 of the mobile device 120 and may be separated from the position of the mobile device 120 by one more physical barriers, including components of the geographic area of interest, such as walls, floors, ceiling, doors, etc. or by one more objects within the geographic area of interest.

The orientation determination module 366 can be configured to receive information collected by the sensors 205. The data collected by the sensors 205 can be received and processed by the sensor processor 210 and/or may be transferred to the orientation determination module 366 by the sensor processor 210 as the sensor data is received from the sensors 205. The orientation determination module 366 can be configured to provide sensor data to the rendering module 362, the position determination module 370, the field of view module 372, and/or other modules or applications on the mobile device 120. For example, the orientation determination module 366 can be configured to determine an orientation of the mobile device 120 based on information collected by the sensors 205 and/or the camera 215, and the orientation determination module 366 can provide the orientation to the rendering module 362 and/or the field of view module 372. In some implementations, the orientation determination module 366 can be configured to determine the orientation of the mobile device based on image content captured by the camera 215 of the mobile device 120. The orientation determination module 366 can be configured to use various techniques, such as the determining a vanishing

point for an image captured by the camera 215 of the mobile device 120 to determine the orientation of the mobile device 120.

The field of view module 372 can be configured to use the orientation information to determine a field of view of the mobile device 120, and the field of view module 372 can provide the field of view information to the point of interest module 364 which can be configured to use the field of view information to determine which POIs are included in the field of view of the mobile device 120. The rendering module 362 can be configured to use the field of view information 372 to determine which portion of the indoor environment should be rendered on the display 225 of the mobile device 120.

The data access module 368 can be configured to access data stored in the memory 460 of the mobile device 120 and/or in the navigation database 350. The data access module 368 can be configured to access data stored in or to store data in the memory 260 and/or in the navigation database 350 in response to requests from the rendering module 362, the orientation determination module 366, the field of view module 372, and/or other applications or modules implemented on the mobile device 120.

The position determination module 370 can be configured to determine the position of the mobile device 120 within an indoor environment and/or in an outdoor environment. In an indoor environment, the position determination module 370 can be configured to obtain measurements of signals from a plurality of wireless access points 115 to estimate the location of the mobile device 120 within an indoor environment in various ways. The position determination module 370 can be configured to determine the position of the mobile device 120 using signals from wireless access points 115 to determine the position of the mobile device 120 within an indoor environment. For example, the position determination module 370 can be configured to perform trilateration using signal measurements (e.g., RSSI (received signal strength indication), RTT (round-trip time)), time of arrival (TOA), and/or disambiguate between multiple possible disambiguation regions (e.g., floors) within an indoor environment, e.g., using RSSI and/or RTT measurements and known locations of the wireless access points 115 and/or wireless base stations 140. The position determination module 370 can also be configured to determine the position of the mobile device 120 using signals received from a Satellite Positioning System receiver associated with the mobile device 120 (e.g., associated with communications controller 250) to determine the position of the mobile device 120 when outdoors and a line of site to a sufficient number of satellites from one or more SPS constellations.

The position determination module 370 can also be configured to provide information to the location server 150 that the location server 150 can use to determine the location of the mobile device 120 and/or that the location server 150 can use to provide assistance data to the mobile device 120 such that the mobile device 120 determine the location of the mobile device 120. For example, location server 150 can send assistance data to the mobile device 120 that the mobile device 120 can use to acquire signals from satellites from one or more SPS constellations. The location server 150 can also be configured to provide the position determination module 370 of the mobile device 120 with an almanac of wireless access points 115 and/or base stations 140 which may be proximate to the mobile device 120. The position determination module 370 can use this information to identify wireless access points 115 and/or base stations 140 that may be proximate to the mobile device 120 and to use

signals from nearby wireless access points **115** and/or base stations **140** to determine the position of the mobile device **120**.

The position determination module **370** can be configured to provide the position of the mobile device **120** within an indoor environment to the rendering module **362**, which can use the position information and the field of view information obtained from the field of view module **372** to determine what to render in the augmented view of the indoor environment presented on the display **225** of the mobile device **120**.

FIG. **4** is a functional block diagram of a computer system that can be used to implement the navigation server **125** illustrated in FIG. **1**. The navigation server **125** can include a processor **455**, a network interface **450**, a memory **460**, and a navigation database **450**. The navigation server **125** can also include functional modules that can be implemented as processor executable software code stored in memory **460**. The functional modules illustrated in FIG. **4** can alternatively be stored either in part or in whole in a different computer-readable memory. For example, the functional modules may be stored in a removable computer-readable medium associated with the navigation server **125** **120**, such as a flash memory, a SD-Card, or other type of removable memory. The functional modules illustrated in FIG. **4** can also be implemented in part or in whole in firmware and/or hardware. The navigation server **125** can include a rendering module **462**, a point of interest module **464**, and a data access module **466**.

The processor **455** can be configured to execute software code stored in the memory **460**. For example, the processor **455** can be configured to execute the software code associated with the rendering module **462**, the point of interest module **464**, and the data access module **466**. The processor **455** can also be configured to execute other software code used by the navigation server **125**, such as operating system components, software drivers for peripheral devices, and/or other software code that may be executed by the navigation server **125** but the description of which is not required to understand the operation of the systems and methods disclosed herein.

The network interface **450** can be configured to provide bidirectional wireless and/or wired network communications to the navigation server **125**. The network interface **450** can be configured to allow the navigation server **125** to communicate with mobile devices **120** via one or more intermediate networks, such as the Internet, a wireless network service provider's core network, one or more wireless local area networks (WLANs), and/or other types of network. The network communications between the network interface **450** of the navigation server **125** and the mobile devices **120** may be routed through one or more other network elements, such as wireless access point **115** or base station **140**.

The memory **460** can comprise volatile and/or persistent memory for storing data used by various components of the navigation server **125**. The memory **460** can be used to store processor-executable program code for one or more of the processors included in the navigation server **125**, such as processor **455**.

The rendering module **462** can be configured to operate similarly to the rendering module **362** of the mobile device **120**. The rendering module **462** can be configured to render an augmented view of an indoor environment that can improve navigation through the indoor environment. In some implementations, the navigation server **125** can be configured to render and provide the augmented navigation

content to the mobile device **120** rather than the augmented navigation content being generated on the mobile device **120**. The augmented navigation content may be performed on the navigation server **125** rather than the mobile device **120** for various reasons. For example, the augmented navigation content may be generated on the navigation server **125** the mobile device **120** may not have sufficient resources to render the augmented navigation content or the augmented navigation content may be rendered by the navigation server **125** to conserve limited processing power, memory, and/or battery life on the mobile device **120**.

The rendering module **462** can be configured to render a view of the indoor environment that overlays and/or blends augmented content with images and/or video captured by the camera **215** of the mobile device **120**. The rendering module **462** can be configured to render a representation of the "field of view" of the camera **215** of the mobile device on the display **225** of the mobile device. The camera can be configured to capture a series of still images or video of a portion the indoor environment within the field of view of the camera **215** and the rendering module **462** can be configured to receive the series of still images and/or video captured by the camera and to augment the received content with navigational aids. The navigational aids can provide visual indications of the locations of points of interest (POIs) relative to the position of the mobile device **120** within the indoor environment. The rendering module **462** can be configured to provide a directional view of the indoor environment and an X-ray view of the indoor environment that can provide navigational clues to a user of the mobile device **120** that can assist the user of the mobile device in navigating the indoor environment.

The rendering module **462** can be configured to obtain the current position of the mobile device **120** from the position determination module **370** and/or the location server **150** and the orientation of the mobile device **120** from the orientation determination module **366**. The rendering module **462** can be configured to provide the position and orientation of the mobile device to the point of interest (POI) module **364** to obtain POI information for points of interest within the field of view of the mobile device **120**. The POI information can be sorted by relative distance of each POI from the current position of the mobile device **120** and can include a graphical and/or textual indications associated with each POI.

When the mobile device **120** is configured to operate in the directional view, the rendering module **462** can be configured to provide an augmented view of the indoor environment that includes overlays of textual and/or graphical indications illustrating the relative position of POIs within the indoor environment. Once the rendering module **362** has obtained the POIs from the POI module **464**, the rendering module **462** can be configured to generate the augmented view of the indoor environment by overlaying the graphical and/or textual indications associated with each POI within the field of view of the camera onto the services of images and/or video content captured by the camera **215** of the mobile device **120**. For example, when used in an indoor shopping mall, the directional view of an indoor environment could be used to display POIs typically found in a shopping mall, such as restrooms, fitting rooms, store locations, and mall exits. FIG. **10**, as described above, provides an example of a directional view of a geographical area of interest, which in this example is a shopping mall.

The rendering module **462** can be configured to include the textual and/or graphical indications associated with each of the POIs in the field view in the augmented view of the

indoor environment generated by the rendering module 462. The rendering module 462 can be configured to place the textual and/or graphical indications associated with each of the POIs within the augmented view of the indoor environment based on their position of each of the POIs relative to the current position of the mobile device 120. The rendering module 462 can be configured to render the textual and/or graphical indications associated with POI to indicate the relative distance of the POI from the current position of the mobile device 120. For example, the rendering module 462 can be configured to render the textual and/or graphical indications associated with POIs that are closer to current position of the mobile device such that the textual and/or graphical indications are larger than the textual and/or graphical indications associated with POIs that are farther from the current position of the mobile device 120. The rendering module 362 can also be configured to use other methods to indicate the distance of the POIs from the current position of the mobile device, such as color coding the textual and/or graphical indications, rendering the textual and/or graphical indications using different levels of transparency based on the distance of the POIs from the current position of mobile device, or using different textures when rendering the textual and/or graphical indications to represent different distances from the current position of the mobile device 120. For example, the textual and/or graphical indications associated with POIs that are closer to the current position of the mobile device 120 can be rendered as opaque while the textual and/or graphical indications associated with POIs that are farther from the mobile device 120 can be rendered as increasingly transparent based on their distance from the current position of the mobile device 120.

When the mobile device 120 is configured to operate in the X-ray view, the rendering module 462 can be configured to provide an augmented view of the indoor environment that can illustrate details of POIs that would otherwise be blocked by objects in the field of view of the mobile device 120, including components of the indoor environment and/or other POIs. When rendering the X-ray view, the rendering module 462 can be configured to first obtain a set of POIs from the POI module 464 as described above. Each POI can include one or more images associated with the POI, and the rendering module 462 can be configured to render a composite image of the indoor environment based on the series of images and/or video captured by the mobile device 120 and the images associated with the POIs that fall within the field of view of the mobile device 120. The rendering module 462 can be configured to request that the POIs retrieved by the POI module 464 be ordered based on the distance between each POI and the current position of the mobile device 120. The rendering module 462 can then generate an augmented view where an image associated with the POI is rendered as semi-transparent based on the distance of the POI from the current position of the mobile device 120. In one implementation, the rendering module 462 can be configured to use alpha compositing to generate the augmented view where the image associated with each POI is associated with an alpha channel value that falls within a range of completely opaque to completely transparent. The rendering module 462 can be configured to assign an alpha channel value representing a higher transparency to those POIs farther from the current position of the mobile device and an alpha channel value representing a lower transparency to those POIs closer to the current position of the mobile device 120. The rendering module 462 can then be configured to render a composite image of the field of view of the mobile device 120 by compositing

the field of view content captured by the camera 215 of the mobile device 215 with the POI images, starting with those POIs farther from the current position of the mobile device 120. The resulting composite image provides X-ray view of the indoor environment that can allow the user to see through walls of the indoor environment to see details that the user would not otherwise be able to see from their vantage point. As described above, FIGS. 11A, 11B, 11C, and 11D illustrate an example of an X-ray view.

The rendering module 462 can be configured to request and receive updates to the position of the mobile device 120 from the mobile device 120 and/or the location server 150. The rendering module 462 can be configured to automatically receive updates from the mobile device 120 and/or the location server 150 when the position of the mobile device 120 changes. The rendering module 462 can be configured to receive updates from the mobile device 120 when the orientation of the mobile device changes 120. The rendering module 120 can be configured to automatically update the augmented view (directional view, X-ray view, or other augmented view) generated for display on the display 225 of the mobile device in response to changes to the position and/or the orientation of the mobile device 120 and to send the updated augmented view to the mobile device 120.

The point of interest (POI) module 464 can be configured to identify points of interest within the field of view of the mobile device 120 based on position and orientation information for the mobile device 120. The position information can be received from the mobile device 120 and/or the location server 150, and the orientation information can be received from the mobile device 120. The rendering module 462 can be configured to obtain the current position of the mobile device 120 within the indoor environment from the mobile device 120 and/or from the location server 150 and to provide the location of the mobile device 120 to the point of interest module 464. The rendering module 462 can also be configured to obtain the orientation information for the mobile device 120. The POI module 464 can be configured to operate similarly as the POI module 464 of the mobile device 120. The POI module 464 can be configured to use the position and orientation information to identify a set of one or more POIs that are in the direction of the field of view of the mobile device 120. As indicated above, the POIs may or may not be visible from the current position of the mobile device 120. The POI module 464 can be configured to order the set of POIs by their relative distance from the current position of the mobile device 120 and can be configured to mark each POI to indicate whether the POI may be visible from the current position of the mobile device 120 or whether the POI is obscured behind another component of the indoor environment.

The POI module 464 can be configured to access POI data from the navigation database 450 via the data access module 466. The data access module 466 can be configured to access the POI information for a particular indoor environment or portion of an indoor environment, such as a floor of the indoor environment, and to provide the POI data to the POI module 464. The navigation database 450 can include similar data as the navigation database 350 of the mobile device 120 as described above. The navigation database 450 can include POI information associated with POIs, including geometry information defining the boundaries of the POI and/or coordinates of the POI in either a global or self-defined, local coordinate system associated with an indoor environment. The POI information can also include images of the POIs that can be used to represent the POI in the X-ray view of the indoor environment and can include textual

and/or graphical labels that can be used to represent the POI in the directional view of the indoor environment provided by the rendering engine **462**.

The request processing module **468** can be configured to receive requests for information from a mobile device **120** and to send requested data to the mobile device **120**. For example, the request processing module **468** can be configured to receive requests for augmented content for navigating through an indoor environment. The request processing module **468** can be configured to request information from the data access module **466** and/or the rendering module **462** if the requested information is not available in the navigation database **450**. The request processing module **468** can also be configured to send the requested information to the mobile device **120** once the requested information has been provided by the data access module **466** and/or the rendering module **462**.

The data access module **466** can be configured to access data stored in the memory **460** of the mobile device **120**, the user roles database **475**, and/or in the navigation database **450**. The data access module **466** can be configured to access data stored in or to store data in the memory **460** and/or in the navigation database **450** in response to requests from the rendering module **462**, the point of interest module **464**, and/or other applications or modules implemented on the navigation server **125**.

FIG. **5** is a functional block diagram of a computer system that can be used to implement the location server **150** illustrated in FIG. **1**. In the examples provided in the figures, the navigation server **125** and the location server **150** are illustrated as separate servers. However, in alternative implementations, some or all of the functionality of the navigation server **125** and the location server **150** may be implemented on the same server.

The location server **150** can include a processor **555**, a network interface **550**, and a memory **560**. The location server **150** can also include functional modules that can be implemented as processor executable software code stored in memory **560**. The functional modules illustrated in FIG. **5** can alternatively be stored either in part or in whole in a different computer-readable memory. For example, the functional modules may be stored in a removable computer-readable medium associated with the location server **150**, such as a flash memory, a SD-Card, or other type of removable memory. The functional modules illustrated in FIG. **5** can also be implemented in part or in whole in firmware and/or hardware. The navigation server **125** can include a position determination module **562** and an assistance data module **564**.

The processor **555** can be configured to execute software code stored in the memory **560**. For example, the processor **555** can be configured to execute the software code associated with the position determination module **562** and the assistance data module **564**. The processor **555** can also be configured to execute other software code used by the location server **150**, such as operating system components, software drivers for peripheral devices, and/or other software code that may be executed by the location server **150** but the description of which is not required to understand the operation of the systems and methods disclosed herein.

The network interface **550** can be configured to provide bidirectional wireless and/or wired network communications to the location server **150**. The network interface **550** can be configured to allow the location server **150** to communicate with mobile devices **120** via one or more intermediate networks, such as the Internet, a wireless network service provider's core network, one or more wire-

less local area networks (WLANs), and/or other types of network. The network communications between the network interface **550** of the location server **150** and the mobile devices **120** may be routed through one or more other network elements, such as wireless access point **115** or base station **140**.

The memory **560** can comprise volatile and/or persistent memory for storing data used by various components of the location server **150**. The memory **460** can be used to store processor-executable program code for one or more of the processors included in the location server **150**, such as processor **555**.

The position determination module **562** can be configured to provide location based services to mobile devices **120**. For example, the position determination module **562** can be configured to determine the position of a mobile device **120** and/or provide assistance data to the mobile device **120** that can be used to determine the position of the mobile device **120** within an indoor environment and/or in an outdoor environment. For determining the position of a mobile device **120** within an indoor environment, the position determination module **562** can be configured to obtain from the mobile device **120** measurements of signals from a plurality of wireless access points **115** to estimate the location of the mobile device **120** within an indoor environment in various techniques, such as RSSI, RTT, TOA, and/or other techniques. The position determination module **562** can also be configured to determine the position of the mobile device **120** using signals received from a Satellite Positioning System receiver associated with the mobile device **120** (e.g., associated with communications controller **250**) to determine the position of the mobile device **120** when outdoors and a line of site to a sufficient number of satellites from one or more SPS constellations.

The assistance data module **564** can be configured to identify assistance data that the mobile device **120** can use to determine the location of the mobile device **120**. The assistance data module **564** can be configured to provide the mobile device **120** with an almanac of wireless access points **115** and/or base stations **140** which may be proximate to the mobile device **120**. The mobile device **120** can use this information to identify wireless access points **115** and/or base stations **140** that may be proximate to the mobile device **120** and to use signals from nearby wireless access points **115** and/or base stations **140** to determine the position of the mobile device **120**.

FIG. **6** is a block flow diagram of a process for displaying navigation information on a mobile device **120**. The process illustrated in FIG. **6** can be implemented by the mobile device **120**. However, some or all of the stages of the process illustrated in FIG. **6** can be implemented either in whole or in part by the navigation server **125** and/or the location server **150**.

The process can begin with obtaining an indication of a position of the mobile device **120** within a geographical area of interest, such as an indoor environment (stage **605**). The position of the mobile device **120** can be determined by the mobile device **120** and/or by the location server **150**. For example, the position determination module **370** of the mobile device **120** can be configured to determine the location of the mobile device **120**. The position determination module **370** can be configured to use signals from wireless access points **115** and/or base stations **140** to determine the location of the mobile device **120**. The position determination module **370** can also be configured to use assistance data received from the location server **150** to determine the position of the mobile device **120**. The posi-

tion of the mobile device **120** can also be determined by the location server **150** and the location server **150** can be configured to send the position information to the mobile device **120**.

An indication of the direction associated with the mobile device **120** can also be obtained (stage **610**). The mobile device **120** can be configured to determine the orientation of the mobile device **120** based on sensor data collected by the orientation determination module **366**. The orientation of the mobile device **120** can be used to determine how the mobile device **120** is oriented relative to the floor, walls, ceiling, and/or other elements of an indoor environment. Based on the orientation of the mobile device **120**, it is possible to determine which POIs should fall within the field of view of the camera **225**. The POIs may not necessarily be visible and may be behind walls, floors, ceilings, and/or other components of an indoor environment.

At least one relevant point of interest within the geographical region of interest can be determined based on the position of the mobile device **120**, the direction associated with the mobile device **120**, and POI information associated with the geographic area of interest (stage **615**). Multiple POIs can be associated with a geographical area of interest. For example, an indoor environment, such as a shopping mall, can include POIs identifying the location of stores and restaurants and/or components of stores, such as cashier locations, the women's clothing section, menswear section, restroom facilities, changing rooms, and/or other aspects of a store that may be of interest of someone shopping at that location. In another example, POIs for a government building might include the location of the Department of Motor Vehicles, the County Recorder's Office, and the Department of Health and Human Safety. In yet another example, the POIs for an office building might include the location of a reception area or lobby, the location of restrooms, conference rooms, and/or specific companies if the building houses multiple tenants.

The at least one relevant point of interest can be determined using various techniques, including, but not limited to the process illustrated in FIG. 7, which is described in detail below. The at least one relevant point of interest can be determined by plotting a viewing direction or field of view of the camera **215** of the mobile device **120**. The camera **215** of the mobile device **120** can be configured capture video and/or a series of images of the area within the field of view of the camera **215** and to display the captured content on the display **225** of the mobile device **120**. The mobile device **120** can be configured to determine which POIs are within the field of view of the camera based on the position of the camera within the geographic region of interest, e.g. an indoor environment and the direction that the mobile device **120** is facing. A set of one or more POIs that fall within the field of view of the camera **215** of the mobile device **120** can be selected from a set of POIs associated with a geographic area of interests, such as an indoor environment. The point of interest module **364** of the mobile device **120** can be configured to identify the set of one or more relevant POIs and/or the mobile device **120** can be configured to receive the POI information from the navigation server **125**. The request processing module **468** of the navigation server **125** can be configured to receive a request for POI information from the mobile device **120**. The mobile device **120** can be configured to provide the location and orientation information associated with the mobile device **120** to the navigation server **125** with the request for the POI information. The POI information can include geometry information defining the boundaries of the POI and/or coordinates of the POI in either

a global or self-defined, local coordinate system associated with an indoor environment. The POI information can also include images of the POIs that can be used to represent the POI in the X-ray view of the indoor environment and can include textual and/or graphical labels that can be used to represent the POI.

A visual indication can then be displayed on the mobile device **120** for the at least one relevant point of interest (stage **620**). The mobile device **120** can be configured to display a directional view, an X-ray view, or a combination thereof on the display of the mobile device **120**. As described above the directional view can be provide an augmented view of an indoor environment that includes overlays of textual and/or graphical indications illustrating the position of POIs within the indoor environment relative to the position of the mobile device **120**. The textual and/or graphical indications can be scaled in size relative to their distance from the position of the mobile device **120**. Textual and/or graphical indications can also be displayed for POIs that fall within the field of view of the camera **215** but are not visible in the images and/or video content captured by the camera **215** because the POIs are blocked from view by one or more components of the indoor environment. The X-ray view can provide an augmented view of the indoor environment that can illustrate details of POIs that would otherwise be blocked by objects in the field of view of the mobile device **120**, including components of the indoor environment and/or other POIs. The X-ray view can provide a view of images and/or video content captured by the camera **215** of the mobile device **120** composited with images of the POIs that would otherwise be blocked from view by components of the indoor environment, such as floors, doors, walls, ceilings, and/or other components of the indoor environment. The composite image can be formed by ordering the POIs based on their relative distances from the position of the mobile device **120** and assigning an alpha channel value to images associated with each POI based on the relative distance of the POI from the position of the mobile device **120**. A composite image of the field of view of the mobile device **120** can then be rendered by compositing the field of view content captured by the camera **225** with the POI images, starting with those POIs farther from the current position of the mobile device **120**.

FIG. 7 is a block flow diagram of a process for determining a relevant set of POIs. Aspects of the process illustrated in FIG. 7 can be implemented by the mobile device **120** and/or by the navigation server **125**. The process illustrated in FIG. 7 can be used to implement, at least in part, stage **615** of the process illustrated in FIG. 6.

An eye ray associated with the position and the indication of direction of the mobile device **120** can be determined (stage **705**). The eye ray can comprise imaginary line extending from the position of the mobile device **120** in the direction associated with the indication of direction obtained for the mobile device **120** in stage **610** of the process illustrated in FIG. 6. The eye ray can be used to determine which POIs could fall within the field of view of the camera **215** of the mobile device **120**. The eye ray can also be used to determine which POIs could fall within the field of view of the camera **215** of the mobile device **120** if the camera **215** were able to peer through physical barriers in the geographic area of interest, such as floors, walls, ceilings, and other objects to view POIs that would otherwise be obscured.

In some implementations, the eye ray can be projected from a position centered at the position of the mobile device **120**. In some implementations, the height of mobile device **120** above the floor or ground plane of the geographic area

of interest can be taken into account when determining the eye ray. For example, the sensors **205** of the mobile device **120** may include one or more sensors that are capable of determining the altitude of the mobile device **120**. The mobile device **120** and/or the navigation server **125** can also be configured to determine an altitude of the mobile device **120** based on RSSI, RTT, and/or measurement of signals transmitted between the mobile device **120** and one or more wireless access points **115**, base stations **140**, or other mobile devices **120** at a known position. In some implementations, a default average value can be used for the height from the floor based on an average height for the typical user of a mobile device **120** and/or a typical height at which an average user would hold the mobile device **120** above the floor or ground plane of a geographic area of interest when using the mobile device **120** to navigate through the geographic area of interest.

In some implementations, multiple eye rays can be determined and projected through the geometric representation of the geographic area of interest. Sometimes a single eye ray may not be sufficient to identify all of the POIs that fall within the field of view. Accordingly, multiple eye rays may be determined to provide more complete information about which POIs that fall within the field of view of the mobile device **120** (and consequently a user of the mobile device **120**). In some implementations, multiple eye rays can be determined by uniformly sampling the angle of the field of view, and an intersection test similar to that used for the single eye ray example can be used to determine whether any of the eye rays intersect with a POI. If one or more eye rays intersect with a POI, that POI can be displayed in the augmented view of the region of geographic interest presented on the display of the mobile device **120**.

The eye ray can then be projected through a geometric representation of the geographic area of interest (stage **710**). As described above, each of the POIs can be associated with POI information that can include geometry information defining the boundaries of the POI and/or coordinates of the POI in either a global or self-defined, local coordinate system associated with an indoor environment. The geometry information can provide information defining 2D boundaries for a particular POI or can provide 3D boundaries of associated with the POI. In some implementations, an area of geographic interest can comprise a multistory building or buildings and the eye-ray can be projected across multiple floors of a multistory environment to determine whether the eye-ray intersects with one or more POIs on multiple floors of the multistory environment.

At least one POI with which the eye ray intersects can be identified (stage **715**). Based on the projection of the eye-ray through the geographic area of interest, POIs with which the eye ray intersections can be selected as relevant points of interest. The eye ray can be used to represent what the field of view of the camera might include if the camera **215** could view peer through physical barriers and/or objects in the geographical area of interest. The POIs identified using the process illustrated in FIG. **7** can be displayed on the display **225** of the mobile device **120** to provide a user of the mobile device **120** with contextual information that may be useful for navigating through the geographic area of interest.

The POI information can include geometry information defining the boundaries of the POI and/or coordinates of the POI in either a global or self-defined, local coordinate system associated with an indoor environment. The POI information can be used to determine how far each of the POIs are from the current position of the mobile device **120**

and the POIs can be sorted based on that distance from the current position of the mobile device **120**.

FIG. **8** is a block flow diagram of a process for determining displaying on the display **225** of the mobile device **120** a directional view of relevant POIs within a field of view of a camera **215** of a mobile device **120**. The process illustrated in FIG. **8** can be implemented by the mobile device **120** and/or by the navigation server **125**. The process illustrated in FIG. **7** can be used to implement, at least in part, stage **620** of the process illustrated in FIG. **6**. FIG. **10**, described above, provides an example of a mobile device **120** displaying directional view of a geographical area of interest that comprises an indoor shopping mall.

The POIs identified based on the position and direction of the mobile device **120** can be sorted based on their distance from the mobile device **120** (stage **805**). Each of the POIs can be associated with POI information. The POI information can include geometry information defining the boundaries of the POI and/or coordinates of the POI in either a global or self-defined, local coordinate system associated with an indoor environment. The POI information can be used to determine how far each of the POIs are from the current position of the mobile device **120** and the POIs can be sorted based on that distance from the current position of the mobile device **120**.

Textual and/or graphical indications associated with the POIs can then be rendered (stage **810**). The POI information associated with each of the POIs can include textual and/or graphical indications that can be rendered to represent that POI. For example, the POI information can contain textual information, such as a name or description of the POI. In one example implementation, the directional view can be provided for an indoor shopping mall, and the POIs can be associated with textual indications, such as a store or restaurant name and/or a description of the POI (e.g., fitting rooms, restrooms, etc.). The POI information can also include graphical indications, such as a store or restaurant logo or an icon representing a type of retailer (e.g. clothing, department store, furniture, shoes, appliances, etc.). In another example implementation, the POI information can be associated with an office building where the textual and/or graphical indications can be customized for an office environment. In such an implementation, the POI information can include textual and/or graphical indications identifying specific business and/or portions of a business, such as copy rooms, break rooms, conference rooms, supply rooms, etc.

The textual and/or graphical indications can be rendered as an overlay over images and/or video content captured by the camera **215** of the mobile device **120** to create an augmented view of the geographic area of interest within the field of view of the camera. In some implementations, the size of the textual and/or graphical indications rendered in the augmented view can be based how close the POI associated with the textual and/or graphical indications is to the current position of the mobile device **120**. The textual and/or graphical indications can be rendered larger if the POI is closer to the current position of the mobile device **120** and the textual and/or graphical indications can be rendered smaller if the POI is farther from the position of the mobile device **120**.

In some implementations, the POI may be obscured in the field of view in the images and/or video content by one or more obstacles between the current position of the camera and the position of the POI, but textual and/or graphical indications can be displayed for such POIs to provide the user of the mobile device **120** with contextual information

about the current position of the mobile device **120**. For example, a wall, floor, ceiling, or other component of the building may obscure the POI from the camera **215** at the current position of the mobile device **120**. In another example, one or more objects within the region of interest, such as people, fixtures within a store, etc. that are not structural components of a building could also obscure the POI from the field of view of the camera **215** of the mobile device, but textual and/or graphical indications could still be provided to guide a user of the mobile device **120** toward the obscured POIs. In some implementations, the rendering module **362** of the mobile device and/or the rendering module **462** of the navigation server **125** can be configured to render the textual and/or graphical indications associated with POIs that are obstructed from view by one or more components of a building or other indoor environment as partially transparent to indicate to a user of the mobile device **120** that the POI is obscured by components of the building or other indoor environment. The POIs that are obstructed from view by components of the indoor environment can be identified based on the current position of the mobile device **120**, the direction that the mobile device **120** is facing and/or the orientation of the device, 2D or 3D map information for an indoor environment, and POI information defining the geometry of the POIs within the indoor environment.

In some implementations, the sorting of stage **805** can be optional and the textual and/or graphical indications associated with the POIs can then be rendered based on their relative distance from the current position of the mobile device **120** without first sorting the POIs.

The rendered indications associated with the POIs can then be displayed with representation of geographic area of interest (stage **815**). The rendered textual and/or graphical indications associated with the POIs can be displayed on the display **225** of the mobile device **120**. In some implementations, the rendered textual and/or graphical indications can be displayed as an overlay to the image and/or video content captured of the field of view of the camera **215**. In other implementations, the rendering module **362** of the mobile device **120** and/or the rendering module **462** of the navigation server can be configured to generate image and/or video content for display on the display **225** that incorporates the textual and/or graphical indications associated with the POIs with the image and/or video content of the field of view of the camera **215** of the mobile device **120**. The latter approach can be used where the rendered textual and/or graphical indications are associated with a level of transparency and are not rendered completely as a complexly opaque overlay to the content captured by the camera **215**.

FIG. **9** is a block flow diagram of a process for determining displaying an X-ray view of POIs within a field of view of a camera **215** of a mobile device **120** on a display **225** of the mobile device **120**. The process illustrated in FIG. **8** can be implemented by the mobile device **120** and/or by the navigation server **125**. The process illustrated in FIG. **7** can be used to implement, at least in part, stage **620** of the process illustrated in FIG. **6**.

The POIs identified based on the position and direction of the mobile device **120** can be sorted based on their distance from the mobile device **120** (stage **905**). Each of the POIs can be associated with POI information. The POI information can include geometry information defining the boundaries of the POI and/or coordinates of the POI in either a global or self-defined, local coordinate system associated with an indoor environment. The POI information can be used to determine how far each of the POIs are from the

current position of the mobile device **120** and the POIs can be sorted based on that distance from the current position of the mobile device **120**.

An alpha channel value can be determined for each of the POIs based on the distance of the POI from the position of the mobile device **120** (stage **910**). In some implementations, the sorting of stage **905** can be optional and an alpha channel value can be determined for each POI based on its relative distance from the current position of the mobile device **120**. The alpha channel value associated with each of the POIs can indicate how transparent (or conversely how opaque) indications associated with a particular POI should be rendered. In some implementations, the alpha channel values can be determined such that indications associated with POIs that are within a predetermined distance from the position of the mobile device **120** are rendered as opaque, while the indications associated with those POIs that are farther than the predetermined distance from the position of the mobile device **120** are rendered as increasingly transparent the farther the POI is from the position of the mobile device **120**. A threshold distance can also be defined beyond which indications associated with POIs at or beyond that distance are not rendered at all (e.g., rendered at 100% transparency).

Composite image content can be generated based on the image associated with POI, the sort order of the POIs, and the alpha channel values associated with each of the POIs (stage **915**). For example, each of the POIs can be associated with an image of the POI or other graphical representation of the POI. The composite image content can be generated by combining the textual and/or graphical indications associated with each of the POIs with image and/or video content of the field of the view of the mobile device **120** captured by the camera **215**. In one example implementation, the image and/or video content of the field of view of the mobile device **120** captured by the camera can be associated with a predetermined transparency level and the textual and/or graphical indications associated with each of the POIs can then be rendered over the image and/or video content of the field of view of the mobile device **120** captured by the camera. In some implementations, the textual and/or graphical indications associated with the POIs can be rendered based on the distance of each of the POIs from the position of the mobile device **120**, starting with the POIs that is farthest from the position of the mobile device **120** first and ending with the POI that is closest to the position of the mobile device **120**.

The composite image content can then be displayed on the display **225** of the mobile device **120** (stage **920**). The composite augmented view of the field of view of the camera that includes the indications of the POI rendered in stage **915** can be displayed on the display **225** of the mobile device **120** to provide an X-ray view of a geographical area of interest.

Other Considerations

As used herein, including in the claims, “or” as used in a list of items prefaced by “at least one of” indicates a disjunctive list such that, for example, a list of “at least one of A, B, or C” means A or B or C or AB or AC or BC or ABC (i.e., A and B and C), or combinations with more than one feature (e.g., AA, AAB, ABBC, etc.).

As used herein, including in the claims, unless otherwise stated, a statement that a function or operation is “based on” an item or condition means that the function or operation is based on the stated item or condition and may be based on one or more items and/or conditions in addition to the stated item or condition.

A wireless communication network does not have all communications transmitted wirelessly, but is configured to have at least some communications transmitted wirelessly.

Other examples and implementations are within the scope and spirit of the disclosure and appended claims. For example, due to the nature of software, functions described above can be implemented using software executed by a processor, hardware, firmware, hardwiring, or combinations of any of these. Features implementing functions may also be physically located at various positions, including being distributed such that portions of functions are implemented at different physical locations. Also, as used herein, including in the claims, “or” as used in a list of items prefaced by “at least one of” indicates a disjunctive list such that, for example, a list of “at least one of A, B, or C” means A or B or C or AB or AC or BC or ABC (i.e., A and B and C), or combinations with more than one feature (e.g., AA, AAB, ABBC, etc.).

Further, more than one invention may be disclosed.

Substantial variations to described configurations may be made in accordance with specific requirements. For example, customized hardware might also be used, and/or particular elements might be implemented in hardware, software (including portable software, such as applets, etc.), or both. Further, connection to other computing devices such as network input/output devices may be employed.

Common forms of physical and/or tangible computer-readable media include, for example, a floppy disk, a flexible disk, hard disk, magnetic tape, or any other magnetic medium, a CD-ROM, any other optical medium, punch-cards, papertape, any other physical medium with patterns of holes, a RAM, a PROM, EPROM, a FLASH-EPROM, any other memory chip or cartridge, a carrier wave as described hereinafter, or any other medium from which a computer can read instructions and/or code.

The methods, systems, and devices discussed above are examples. Various configurations may omit, substitute, or add various procedures or components as appropriate. For instance, in alternative configurations, the methods may be performed in an order different from that described, and that various steps may be added, omitted, or combined. Also, features described with respect to certain configurations may be combined in various other configurations. Different aspects and elements of the configurations may be combined in a similar manner. Also, technology evolves and, thus, many of the elements are examples and do not limit the scope of the disclosure or claims.

Specific details are given in the description to provide a thorough understanding of example configurations (including implementations). However, configurations may be practiced without these specific details. For example, well-known circuits, processes, algorithms, structures, and techniques have been shown without unnecessary detail in order to avoid obscuring the configurations. This description provides example configurations only, and does not limit the scope, applicability, or configurations of the claims. Rather, the preceding description of the configurations provides a description for implementing described techniques. Various changes may be made in the function and arrangement of elements without departing from the spirit or scope of the disclosure.

Also, configurations may be described as a process which is depicted as a flow diagram or block diagram. Although each may describe the operations as a sequential process, many of the operations can be performed in parallel or concurrently. In addition, the order of the operations may be rearranged. A process may have additional stages or func-

tions not included in the figure. Furthermore, examples of the methods may be implemented by hardware, software, firmware, middleware, microcode, hardware description languages, or any combination thereof. When implemented in software, firmware, middleware, or microcode, the program code or code segments to perform the tasks may be stored in a non-transitory computer-readable medium such as a storage medium. Processors may perform the described tasks.

Having described several example configurations, various modifications, alternative constructions, and equivalents may be used without departing from the spirit of the disclosure. For example, the above elements may be components of a larger system, wherein other rules may take precedence over or otherwise modify the application of the invention. Also, a number of operations may be undertaken before, during, or after the above elements are considered. Accordingly, the above description does not bound the scope of the claims.

What is claimed is:

1. A method of displaying navigation information on a mobile device, the method comprising:
 - obtaining, at the mobile device, an indication of a position of the mobile device;
 - determining, at the mobile device, an indication of an orientation of the mobile device;
 - determining a plurality of points of interest within a geographic area of interest using the indication of the position of the mobile device, the indication of the orientation of the mobile device, and boundary information of the plurality of points of interest;
 - generating a composite image by overlaying a first visual indication associated with a first point of interest and a second visual indication associated with a second point of interest over an image of a portion of the geographic area of interest captured using a camera of the mobile device, wherein the first point of interest is disposed within the portion of the geographic area of interest at a first distance from the mobile device, wherein the second point of interest is disposed within the portion of the geographic area of interest at a second distance from the mobile device, and wherein the second visual indication is overlaid before the first visual indication based on the second distance being greater than the first distance;
 - setting a first transparency level of the first visual indication based on the first distance and a second transparency level of the second visual indication based on the second distance; and
 - displaying, on the mobile device, an augmented view of the portion of the geographic area of interest, the augmented view including the composite image.
2. The method of claim 1 wherein at least a portion of the first visual indication does not overlap the second visual indication in the image.
3. The method of claim 1 wherein the first transparency level has a lower transparency than the second transparency level.
4. The method of claim 1 wherein the second transparency level of the second visual indication is dependent on a presence of a known physical barrier between the mobile device and the second point of interest, and wherein the second point of interest is disposed beyond the known physical barrier relative to the mobile device.
5. The method of claim 1, wherein the geographic area of interest comprises an indoor environment.

31

6. The method of claim 1, further comprising:
 sorting the plurality of points of interest based on distances of the plurality of points of interest from the mobile device;
 determining transparency levels of visual indications 5
 associated with the plurality of points of interest based on the sorted plurality of points of interest;
 rendering at least one of the visual indications at one or more of the determined transparency levels; and
 displaying the at least one visual indication at the one or 10
 more determined transparency levels.
7. The method of claim 1 wherein at least one visual indication has a size that is dependent on a distance from the mobile device of a point of interest associated with the at least one visual indication.
8. The method of claim 1, further comprising:
 sorting the plurality of points of interest based on distances of the plurality of points of interest from the mobile device;
 determining alpha channel values for visual indications 20
 associated with the plurality of points of interest based on the sorted plurality of points of interest; and
 generating the composite image based on the visual indications and the alpha channel values determined for the visual indications associated with the plurality of 25
 points of interest.
9. The method of claim 8, wherein a visual indication associated with a point of interest comprises an image of the point of interest.
10. The method of claim 1, further comprising: 30
 determining a height of the mobile device over a floor of the geographic area of interest; and
 projecting at least one eye ray through a three-dimensional geometric representation of the geographic area of interest from the height of the mobile device. 35
11. The method of claim 1, further comprising:
 sending a request for point of interest information to a location server, the request comprising the indication of the position of the mobile device; and
 receiving the point of interest information from the loca- 40
 tion server.
12. The method of claim 1, wherein a visual indication for at least one point of interest is based on a type of environment in which the mobile device is located, wherein the type of environment is a building, and wherein the visual indication is based at least in part on where the at least one point 45
 of interest is within the building.
13. An apparatus for displaying navigation information on a mobile device, the apparatus comprising:
 means for obtaining, at the mobile device, an indication of 50
 a position of the mobile device;
 means for determining, at the mobile device, an indication of an orientation of the mobile device;
 means for determining a plurality of points of interest within a geographic area of interest using the indication 55
 of the position of the mobile device, the indication of the orientation of the mobile device, and boundary information of the plurality of points of interest;
 means for generating a composite image by overlaying a first visual indication associated with a first point of 60
 interest and a second visual indication associated with a second point of interest over an image of a portion of the geographic area of interest captured using a camera of the mobile device, wherein the first point of interest is disposed within the portion of the geographic area of interest at a first distance from the mobile device, 65
 wherein the second point of interest is disposed within

32

- the portion of the geographic area of interest at a second distance from the mobile device, and wherein the second visual indication is overlaid before the first visual indication based on the second distance being greater than the first distance;
 means for setting a first transparency level of the first visual indication based on the first distance and a second transparency level of the second visual indication based on the second distance; and
 means for displaying an augmented view of a portion of the geographic area of interest, the augmented view including the composite image.
14. The apparatus of claim 13 wherein at least a portion of the first visual indication does not overlap the second visual indication in the image.
15. The apparatus of claim 13 wherein the first transparency level has a lower transparency than the second transparency level.
16. The apparatus of claim 13 wherein the second transparency level of the second visual indication is dependent on a presence of a known physical barrier between the mobile device and the second point of interest, and wherein the second point of interest is disposed beyond the known physical barrier relative to the mobile device.
17. The apparatus of claim 13, wherein the geographic area of interest comprises an indoor environment.
18. The apparatus of claim 13, further comprising:
 means for sorting the plurality of points of interest based on distances of the plurality of points of interest from the mobile device;
 means for determining transparency levels of visual indications associated with the plurality of points of interest based on the sorted plurality of points of interest;
 means for rendering at least one of the visual indications at one or more of the determined transparency levels; and
 means for displaying the at least one visual indication at the one or more determined transparency levels.
19. The apparatus of claim 18, wherein at least one visual indication has a size that is dependent on a distance from the mobile device of a point of interest associated with the at least one visual indication.
20. The apparatus of claim 13, further comprising:
 means for sorting the plurality of points of interest based on distances of the plurality of points of interest from the mobile device;
 means for determining alpha channel values for visual indications associated with the plurality of points of interest based on the sorted plurality of points of interest; and
 means for generating the composite image based on the visual indications and the alpha channel values determined for the visual indications associated with the plurality of points of interest.
21. The apparatus of claim 20, wherein a visual indication associated with a point of interest comprises an image of the point of interest.
22. A non-transitory computer-readable medium, having stored thereon computer-readable instructions for displaying navigation information on a mobile device, comprising instructions configured to cause a computer to:
 obtain, at the mobile device, an indication of a position of the mobile device;
 determine, at the mobile device, an indication of an orientation of the mobile device;
 determine a plurality of points of interest within a geographic area of interest using the indication of the

33

position of the mobile device, the indication of the orientation of the mobile device, and boundary information of the plurality of points of interest;
 generate a composite image by overlaying a first visual indication associated with a first point of interest and a second visual indication associated with a second point of interest over an image of a portion of the geographic area of interest captured using a camera of the mobile device, wherein the first point of interest is disposed within the portion of the geographic area of interest at a first distance from the mobile device, wherein the second point of interest is disposed within the portion of the geographic area of interest at a second distance from the mobile device, and wherein the second visual indication is overlaid before the first visual indication based on the second distance being greater than the first distance;
 set a first transparency level of the first visual indication based on the first distance and a second transparency level of the second visual indication based on the second distance; and
 display an augmented view of the portion of the geographic area of interest, the augmented view including the composite image.

23. The non-transitory computer-readable medium of claim **22** wherein at least a portion of the first visual indication does not overlap the second visual indication in the image.

24. The non-transitory computer-readable medium of claim **22** wherein the first transparency level has a lower transparency than the second transparency level.

25. The non-transitory computer-readable medium of claim **22** wherein the second transparency level of the second visual indication is dependent on a presence of a known physical barrier between the mobile device and the second point of interest, and wherein the second point of interest is disposed beyond the known physical barrier relative to the mobile device.

26. The non-transitory computer-readable medium of claim **22**, wherein the geographic area of interest comprises an indoor environment.

27. The non-transitory computer-readable medium of claim **22**, further comprising instructions to cause the computer to:

sort the plurality of points of interest based on distances of the plurality of points of interest from the mobile device;

determine transparency levels of visual indications associated with the plurality of points of interest based on the sorted plurality of points of interest;

render at least one of the visual indications at one or more of the determined transparency levels; and

display the at least one visual indication at the one or more determined transparency levels.

28. The non-transitory computer-readable medium of claim **27**, wherein at least one visual indication has a size that is dependent on a distance from the mobile device of a point of interest associated with the at least one visual indication.

29. The non-transitory computer-readable medium of claim **22**, further comprising instructions to cause the computer to:

sort the plurality of points of interest based on distances of the plurality of points of interest from the mobile device;

34

determine alpha channel values for visual indications associated with the plurality of points of interest based on the sorted plurality of points of interest; and
 generate the composite image based on the visual indications and the alpha channel values determined for the visual indications associated with the plurality of points of interest.

30. The non-transitory computer-readable medium of claim **29**, wherein a visual indication associated with a point of interest comprises an image of the point of interest.

31. An apparatus for displaying navigation information on a mobile device, the apparatus comprising:

a transceiver configured to transmit and receive data wirelessly;

a memory configured to store processor-executable program code;

a processor configured to:

obtain, at the mobile device, an indication of a position of the mobile device;

determine, at the mobile device, an indication of an orientation of the mobile device;

determine a plurality of points of interest within a geographic area of interest using the indication of the position of the mobile device, the indication of the orientation of the mobile device, and boundary information of the plurality of points of interest;

generate a composite image by overlaying a first visual indication associated with a first point of interest and a second visual indication associated with a second point of interest over an image of a portion of the geographic area of interest captured using a camera of the mobile device, wherein the first point of interest is disposed within the portion of the geographic area of interest at a first distance from the mobile device, wherein the second point of interest is disposed within the portion of the geographic area of interest at a second distance from the mobile device, and wherein the second visual indication is overlaid before the first visual indication based on the second distance being greater than the first distance;

set a first transparency level of the first visual indication based on the first distance and a second transparency level of the second visual indication based on the second distance; and

display an augmented view of the portion of the geographic area of interest, the augmented view including the composite image.

32. The apparatus of claim **31** wherein at least a portion of the first visual indication does not overlap the second visual indication in the image.

33. The apparatus of claim **31** wherein the first transparency level has a lower transparency than the second transparency level.

34. The apparatus of claim **31** wherein the second transparency level of the second visual indication is dependent on a presence of a known physical barrier between the mobile device and the second point of interest, and wherein the second point of interest is disposed beyond the known physical barrier relative to the mobile device.

35. The apparatus of claim **31**, wherein the geographic area of interest comprises an indoor environment.

36. The apparatus of claim **31**, wherein the processor is further configured to:

sort the plurality of points of interest based on distances of the plurality of points of interest from the mobile device;

determine transparency levels of visual indications associated with the plurality of points of interest based on the sorted plurality of points of interest;

render at least one of the visual indications at one or more of the determined transparency levels; and 5

display the at least one visual indication at the one or more determined transparency levels.

37. The apparatus of claim **36**, wherein at least one visual indication has a size that is dependent on a distance from the mobile device of a point of interest associated with the at 10 least one visual indication.

38. The apparatus of claim **31**, wherein the processor is further configured to:

sort the plurality of points of interest based on distances of the plurality of points of interest from the mobile 15 device;

determine alpha channel values for visual indications associated with the plurality of points of interest based on the sorted plurality of points of interest; and

generate the composite image based on the visual indi- 20 cations and the alpha channel values determined for the visual indications associated with the plurality of points of interest.

39. The apparatus of claim **38**, wherein a visual indication associated with a point of interest comprises an image of the 25 point of interest.

* * * * *