

US009928547B2

(12) **United States Patent**  
**Del Vecchio et al.**

(10) **Patent No.:** **US 9,928,547 B2**  
(45) **Date of Patent:** **Mar. 27, 2018**

(54) **SYSTEMS AND METHODS FOR PROVIDING BALANCE NOTIFICATIONS TO CONNECTED DEVICES**

(71) Applicant: **The Toronto-Dominion Bank**, Toronto (CA)

(72) Inventors: **Orin Del Vecchio**, Richmond Hill (CA); **Nigel Lall**, Toronto (CA); **Paul Mon-Wah Chan**, Markham (CA); **Jonathan K. Barnett**, Oakville (CA); **Garima Aggarwal**, Toronto (CA)

(73) Assignee: **The Toronto-Dominion Bank**, Toronto (CA)

(\*) Notice: Subject to any disclaimer, the term of this patent is extended or adjusted under 35 U.S.C. 154(b) by 112 days.

(21) Appl. No.: **14/589,848**

(22) Filed: **Jan. 5, 2015**

(65) **Prior Publication Data**

US 2015/0193869 A1 Jul. 9, 2015

**Related U.S. Application Data**

(63) Continuation-in-part of application No. 14/585,069, filed on Dec. 29, 2014.  
(Continued)

(51) **Int. Cl.**  
**G06Q 40/02** (2012.01)

(52) **U.S. Cl.**  
CPC ..... **G06Q 40/02** (2013.01)

(58) **Field of Classification Search**  
CPC ..... **G06Q 40/02**  
(Continued)

(56) **References Cited**

U.S. PATENT DOCUMENTS

5,831,167 A 11/1998 Bhukhanwala  
5,903,881 A 5/1999 Schrader et al.  
(Continued)

FOREIGN PATENT DOCUMENTS

CA 2716137 3/2012  
CN 203287793 11/2013  
(Continued)

OTHER PUBLICATIONS

BBVA Compass upgrades mobile banking apps, adding Mobile Deposit® for small business Nov. 2013, NPL.\*  
(Continued)

*Primary Examiner* — Bruce I Ebersman

(74) *Attorney, Agent, or Firm* — Duane Morris LLP

(57) **ABSTRACT**

The disclosed embodiments include methods and systems for providing account and event status notifications. The disclosed embodiments include, for example, a communications device including a memory storing software instructions and one or more processors configured to execute the software instructions to perform operations. In one aspect, the operations may include receive a notification of a status of an account parameter. The operations may also include identifying a device eligible to access the notification in accordance with a user-specified data restriction, and identifying at least a portion of the notification that is consistent with the data restriction. The communications device provide the identified portion of the notification to the eligible device without receiving input from the user, and the eligible device may present at least one of a visual, audible, or tactile indicator of the status of the account parameter.

**28 Claims, 18 Drawing Sheets**

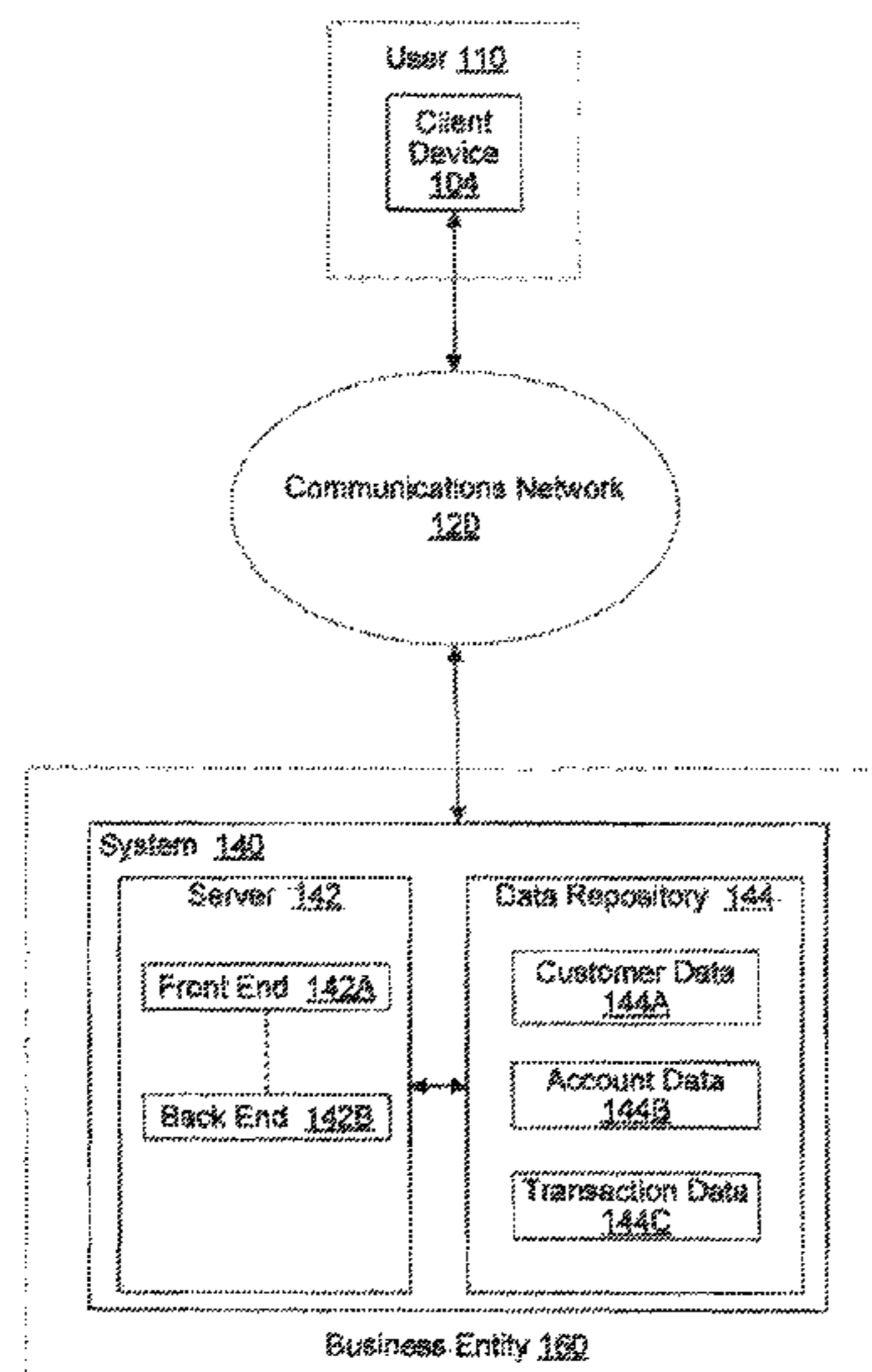

**Related U.S. Application Data**

- (60) Provisional application No. 61/923,355, filed on Jan. 3, 2014.
- (58) **Field of Classification Search**  
USPC ..... 705/42  
See application file for complete search history.

**References Cited**

U.S. PATENT DOCUMENTS

6,246,383	B1	6/2001	Ophey	
6,405,177	B1	6/2002	DiMattina	
6,448,987	B1	9/2002	Easty et al.	
6,988,248	B1	1/2006	Tang et al.	
7,493,573	B2	2/2009	Wagner	
7,844,519	B2	11/2010	Wehunt et al.	
7,899,750	B1	3/2011	Klieman et al.	
7,941,371	B1 *	5/2011	Guinan	G06Q 20/10 705/39
8,061,592	B1	11/2011	Clem et al.	
8,069,113	B2	11/2011	Eiterich	
8,112,062	B2	2/2012	Pattabiraman	
8,156,041	B2	4/2012	Jun et al.	
8,160,959	B2	4/2012	Rackley, III et al.	
8,175,961	B2	5/2012	Reid et al.	
8,215,560	B2	7/2012	Granucci et al.	
8,270,944	B1	9/2012	Gailloux et al.	
8,423,452	B1	4/2013	Ley et al.	
8,500,031	B2	8/2013	Naelon	
8,538,827	B1	9/2013	Dryer et al.	
8,600,863	B2	12/2013	Jain et al.	
8,659,605	B1	2/2014	Perttunen	
8,707,178	B2	4/2014	Paas et al.	
8,799,066	B1	8/2014	Nesladek et al.	
8,820,632	B1	9/2014	West	
2002/0143594	A1	10/2002	Kroeger	
2004/0143659	A1	7/2004	Milliken et al.	
2005/0234820	A1	10/2005	MacKouse	
2007/0150986	A1	6/2007	Jung et al.	
2007/0129955	A1	7/2007	Dalmia et al.	
2008/0006685	A1	1/2008	Rackiey, III et al.	
2008/0017704	A1	1/2008	Vandeberg et al.	
2008/0046349	A1 *	2/2008	Elberg et al.	705/35
2008/0103972	A1	5/2008	Lanc	
2008/0167000	A1	7/2008	Wentker et al.	
2010/0114724	A1	5/2010	Ghosh et al.	
2010/0125495	A1	5/2010	Smith et al.	
2010/0138338	A1	6/2010	Hammad et al.	
2010/0153247	A1	6/2010	DiPaolo et al.	
2010/0162260	A1	6/2010	Ibrahim	
2010/0223569	A1	9/2010	Vuong et al.	
2010/0312700	A1	12/2010	Coulter et al.	
2011/0010232	A1 *	1/2011	Bhojwani et al.	705/14.17
2011/0022516	A1	1/2011	Gao et al.	
2011/0029430	A1	2/2011	Norris et al.	
2011/0071893	A1	3/2011	Malhotra et al.	
2011/0134804	A1 *	6/2011	Maes	H04M 7/0012 370/259
2012/0030043	A1	2/2012	Ross et al.	
2012/0099715	A1	4/2012	Ravishankar et al.	
2012/0150736	A1	6/2012	Dickerson et al.	
2012/0167162	A1 *	6/2012	Raleigh	G06F 21/57 726/1
2012/0215767	A1	8/2012	Myer et al.	
2012/0265618	A1	10/2012	Bullock	
2012/0267432	A1	10/2012	Kuttava	
2012/0299962	A1	11/2012	White et al.	
2013/0030925	A1	1/2013	Calman et al.	
2013/0033522	A1	2/2013	Calman et al.	
2013/0080898	A1	3/2013	Lavian et al.	
2013/0138534	A1	5/2013	Herwig	

2013/0204785	A1	8/2013	Monk et al.	
2013/0231080	A1	9/2013	Cheuk et al.	
2013/0304587	A1	11/2013	Ralston	
2013/0325679	A1	12/2013	Yeri et al.	
2013/0331067	A1 *	12/2013	Coussemaeker et al.	455/412.2
2013/0343353	A1	12/2013	Maytal	
2014/0006114	A1	1/2014	Nuzzi et al.	
2014/0012745	A1	1/2014	Hanson et al.	
2014/0012746	A1	1/2014	Hanson et al.	
2014/0058912	A1	2/2014	Bajaj	
2014/0076965	A1	3/2014	Becorest et al.	
2014/0207666	A1	4/2014	Wottowa et al.	
2014/0297435	A1	10/2014	Wong	
2014/0320533	A1	10/2014	Soon-Shiong	
2015/0106267	A1	4/2015	Lee	

FOREIGN PATENT DOCUMENTS

KR	20050017699	2/2005
WO	WO 2004053786	6/2004
WO	WO 2012122248	9/2012
WO	WO 2013068768	5/2013

OTHER PUBLICATIONS

Gusev et al., "Models of Mobile Payments," Institute of Informatics, Faculty of Natural Sciences and Mathematics, Ss. Cyril and Methodius University, Jan. 2002 (6 pages).

Marous, "Moven: From Mobile Banking to Mobile Money," <http://www.banknxt.com>, Feb. 26, 2013 (9 pages).

"Finance PM—Expense manager," Android Apps on Google Play, retrieved from <https://play.google.com/store/apps/details?id=com.fingerssaver> on Mar. 13, 2014 (5 pages).

"Check: Pay bills, credit cards," Android Apps on Google Play, retrieved from <https://play.google.com/store/apps/details?id=com.netgate> on Mar. 13, 2014 (4 pages).

"MasterPass heralds new age in digital payments," Philippine Daily Inquirer, Jan. 18, 2014 (3 pages).

Malykhina et al., "The phone as bank central," InformationWeek, Issue 1133, Apr. 9, 2007, pp. 31-32.

Sluis, Customer Relationship Management, May 2014 (2 pages).

Duffy, "Best Mobile Finance Apps," [pcmag.com](http://pcmag.com), Jul. 24, 2014 (9 pages).

Samimi et al., "Analysis of ordered categorical data to develop control charts for monitoring customer loyalty," Applied Stochastic Models in Business and Industry, vol. 26, No. 6, 2010, pp. 668-688.

Larivière et al., "Value fusion: The blending of consumer and firm value in the distinct context of mobile technologies and social media," Journal of Service Management, vol. 24, No. 3, 2013, pp. 268-293.

Korousic et al., "Predictable hard real-time scheduling," Real Time Systems, 1992 (6 pages).

Wood, "Using Special Characters from Windows Glyph List 4 (WGL4) in HTML," retrieved from <http://www.alanwood.net/demos/wgl4.html>, Jan. 18, 2008 (29 pages).

"Sending Buyer Email," retrieved from <http://pages.ebay.com/help/sell/email-buyer.html>, Mar. 3, 2006 (4 pages).

Zuckerman, "How to Create Progress Bars in Excel With Conditional Formatting," retrieved from <http://www.howtogeek.com/howto/45677/how-to-create-progress-bars-in-excel-with-conditional-formatting>, Jan. 8, 2012 (6 pages).

Chilton et al., "Why We Customize the Web," chapter within Cypher et al., No Code Required: Giving Users Tools to Transform the Web, Elsevier, 2010 (11 pages).

Piechnick, "Six Font Styles that Make Text Stand Out," 2008 (retrieved <http://www.pegaweb.com/tutorials/contrast-font-style/contrast-font-style.htm> on Nov. 30, 2016; 3 pages).

\* cited by examiner



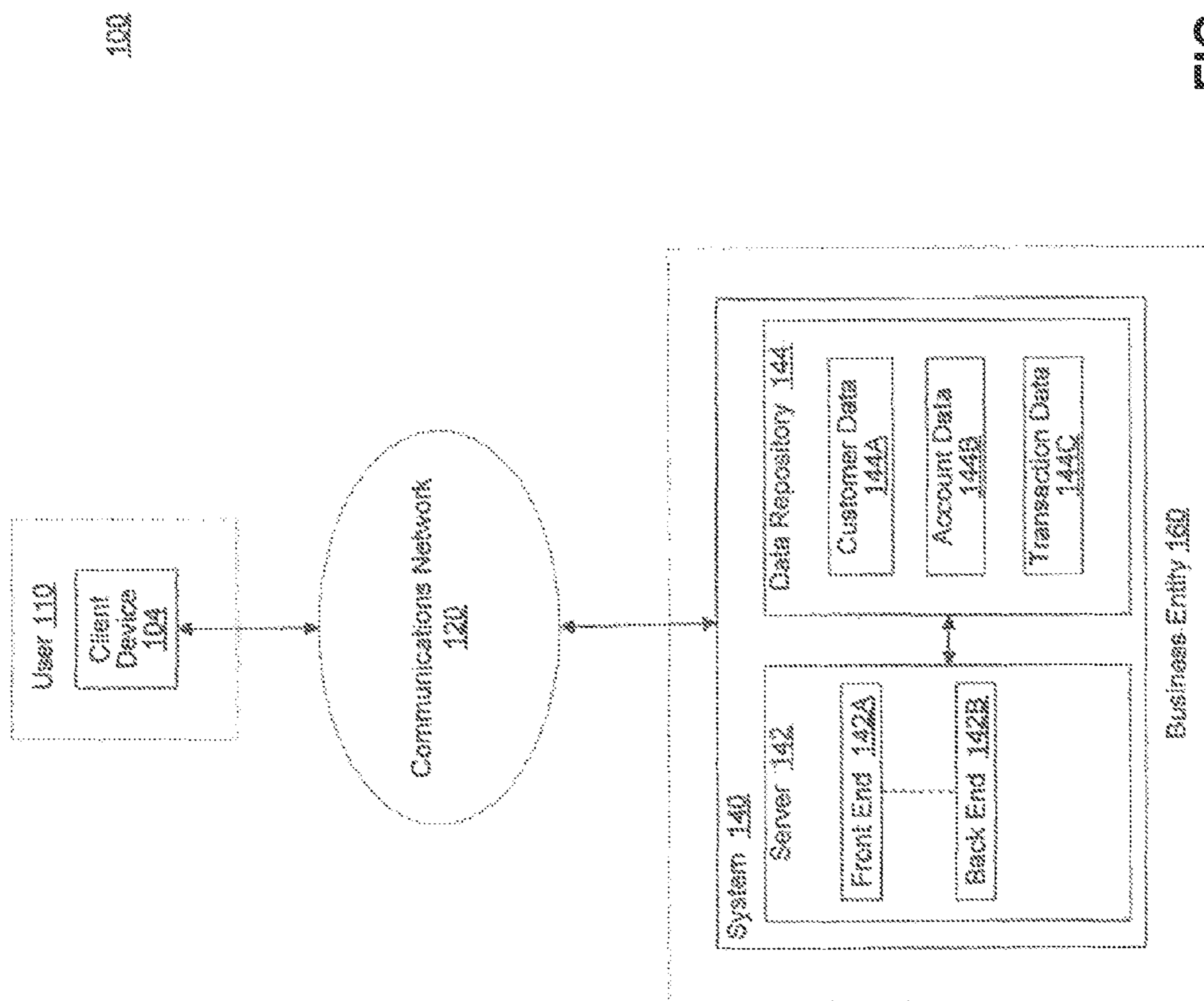

FIG. 1

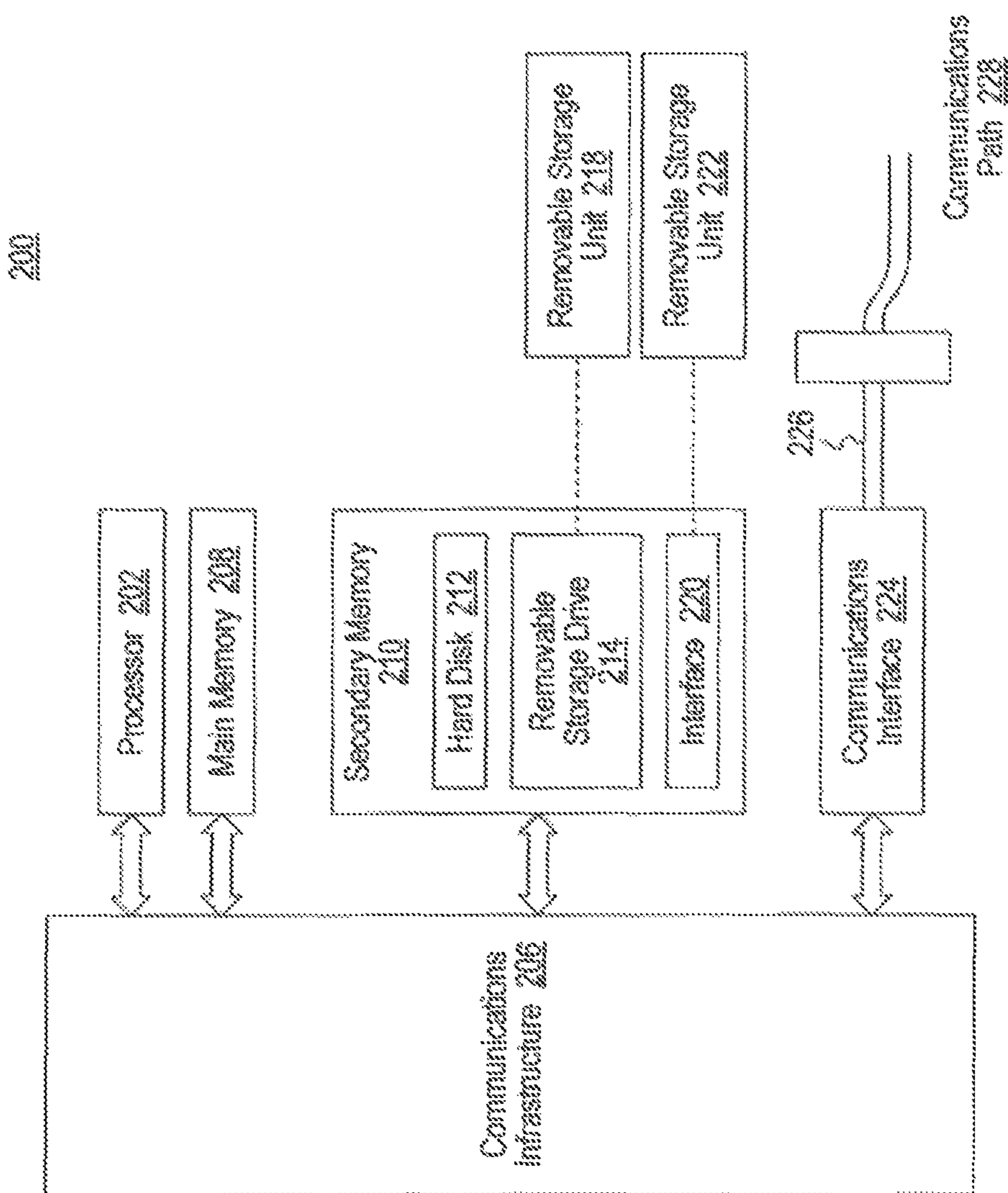

FIG. 2

300A

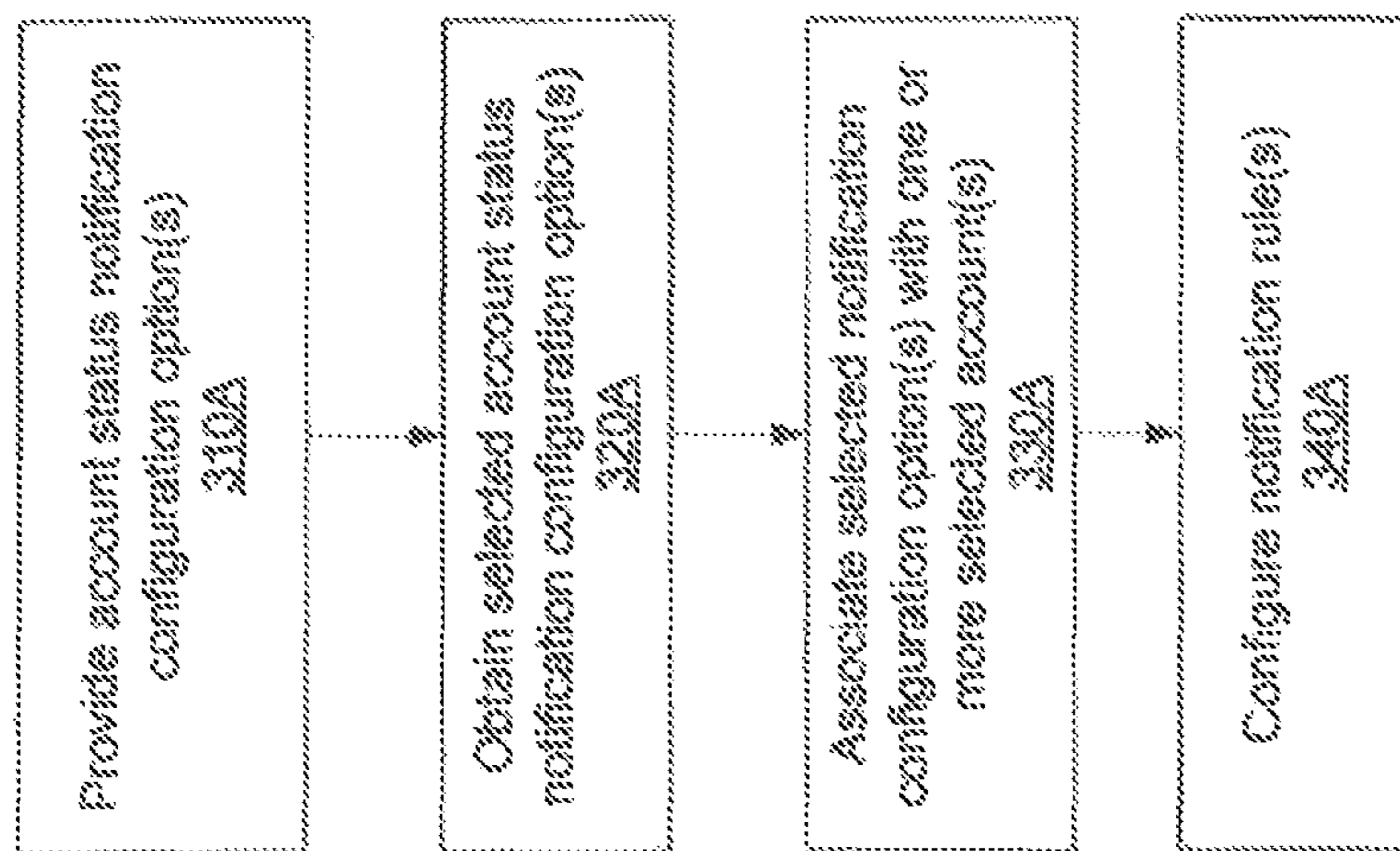

FIG. 3A

3000

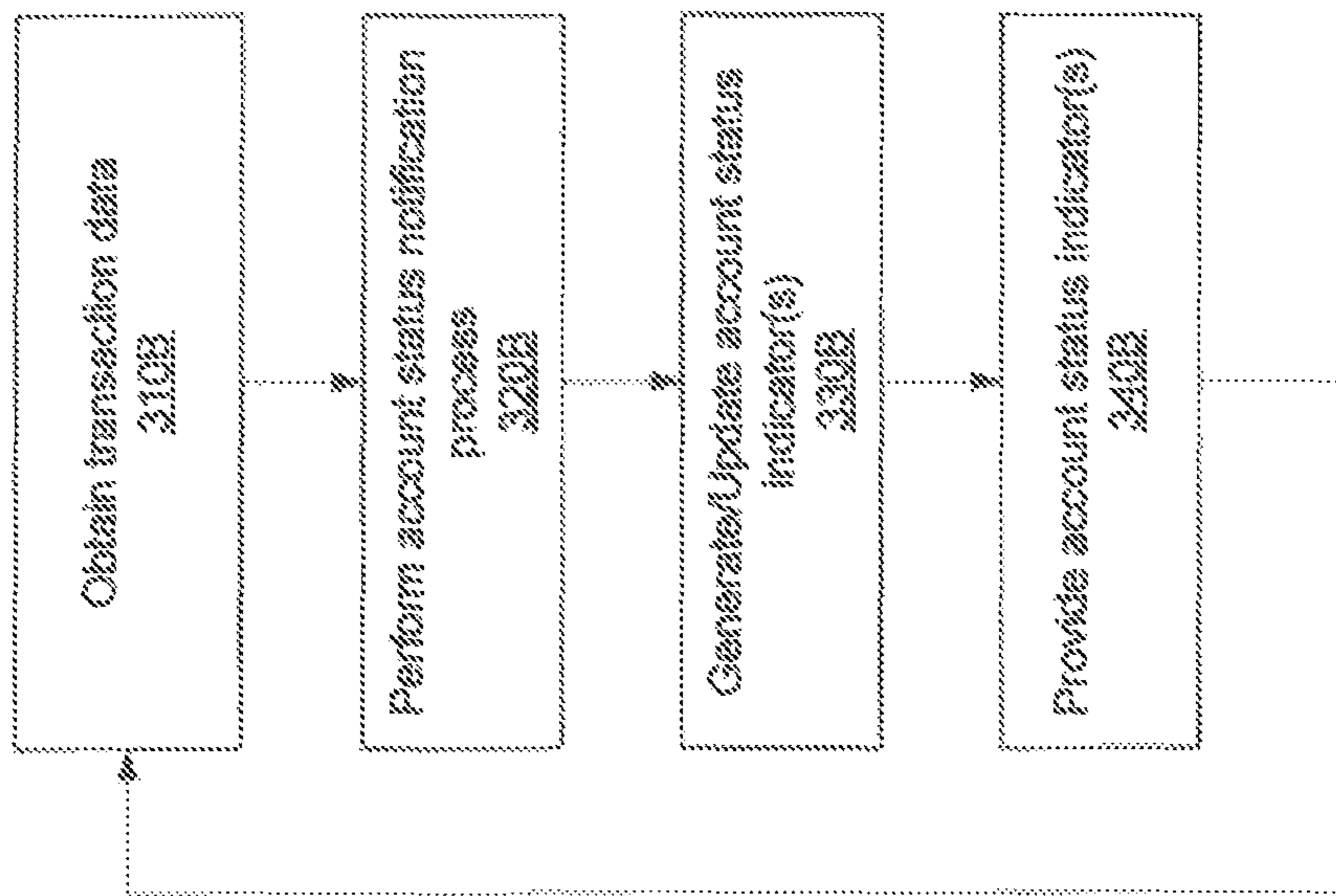

FIG. 3B



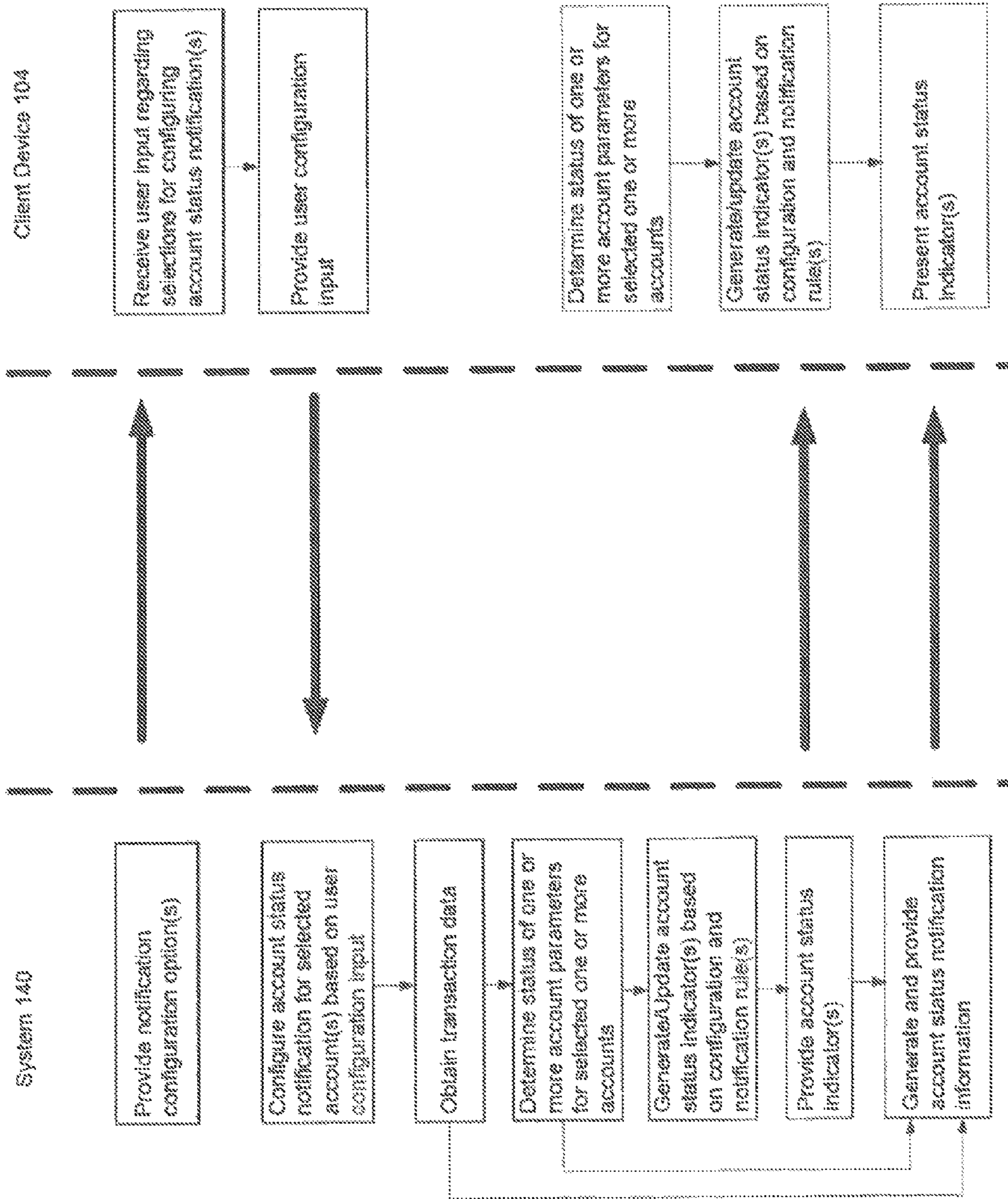

FIG. 3C

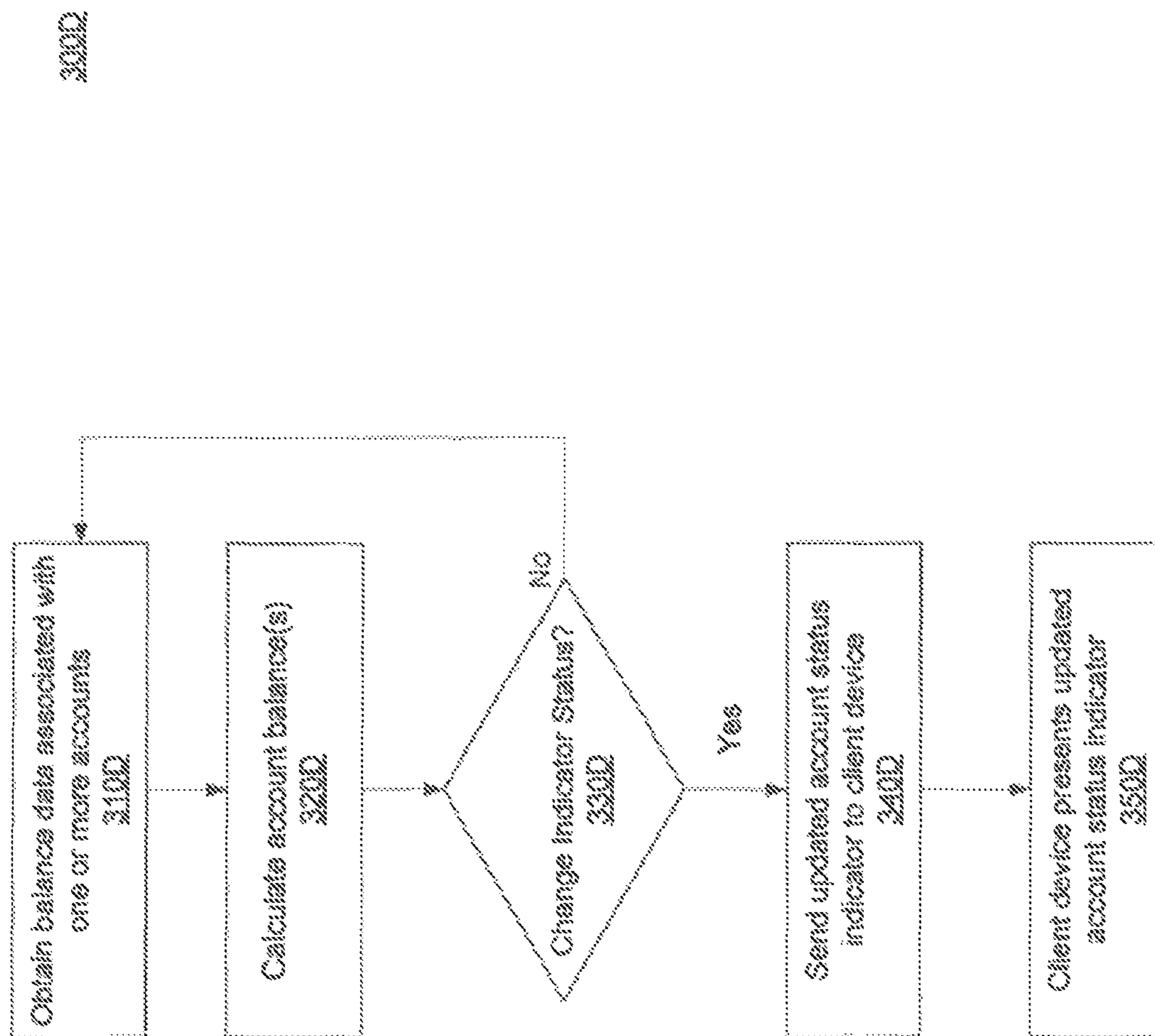

FIG. 30



400

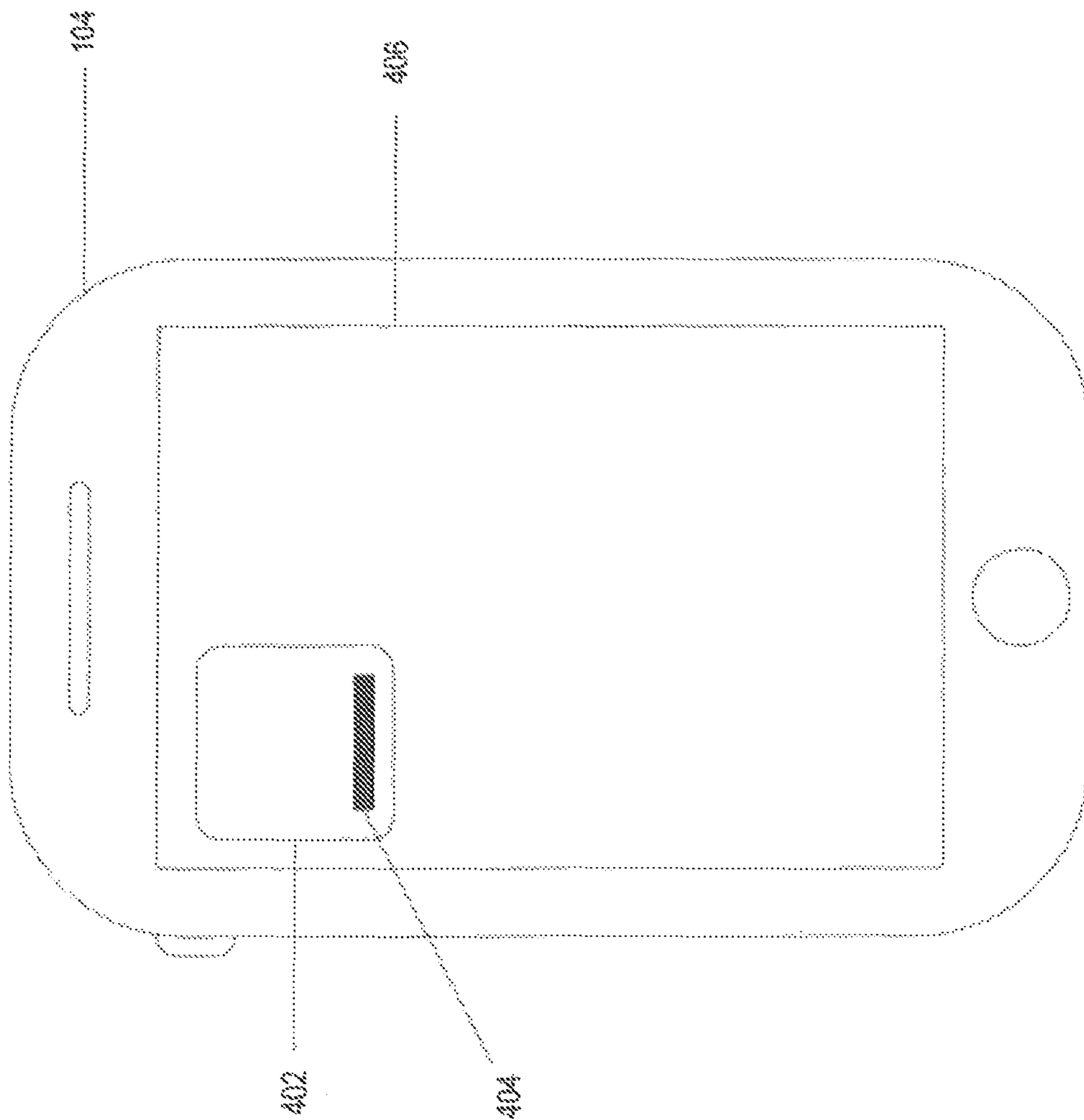

FIG. 4

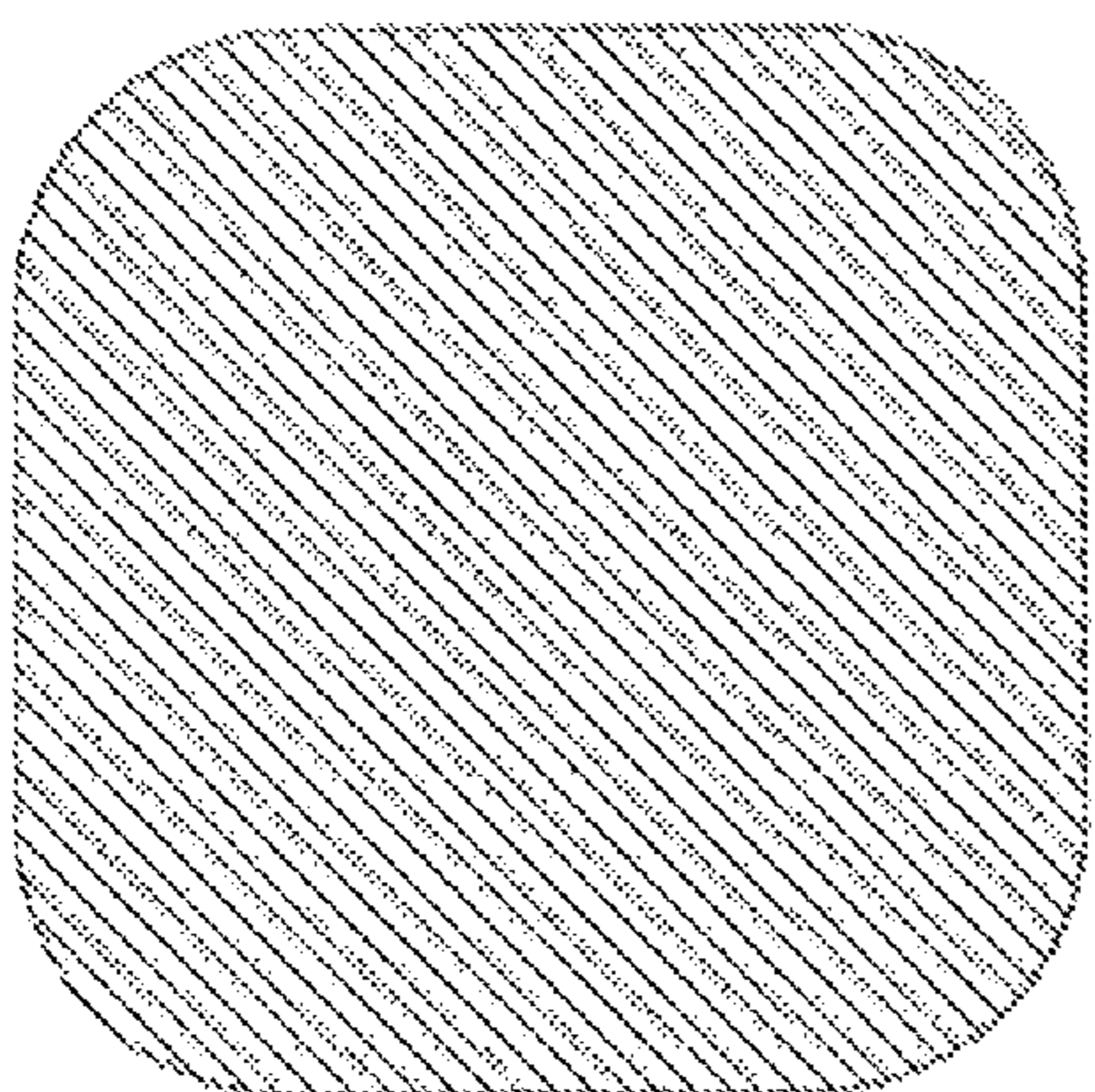

FIG. 5A

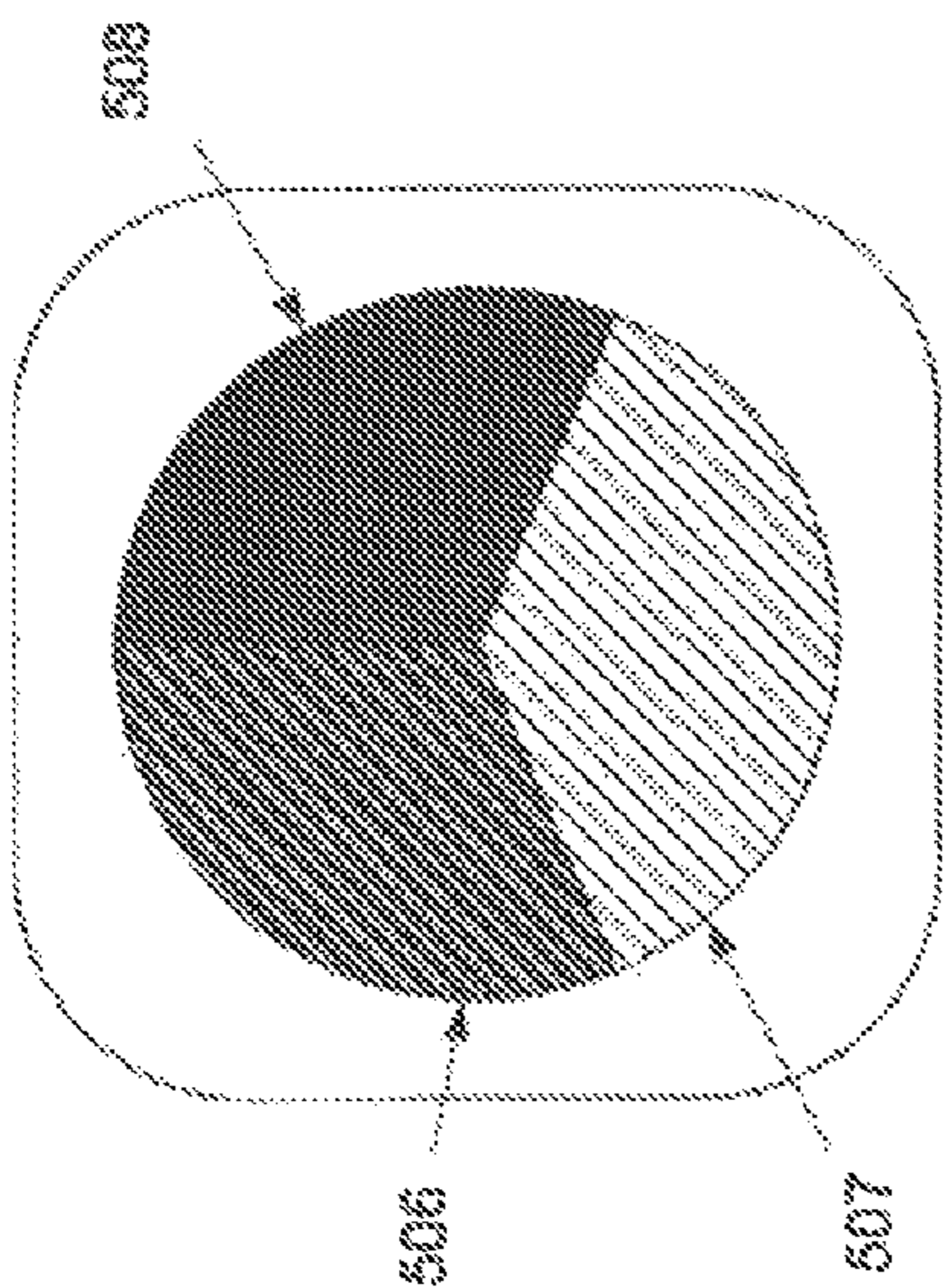

FIG. 5B

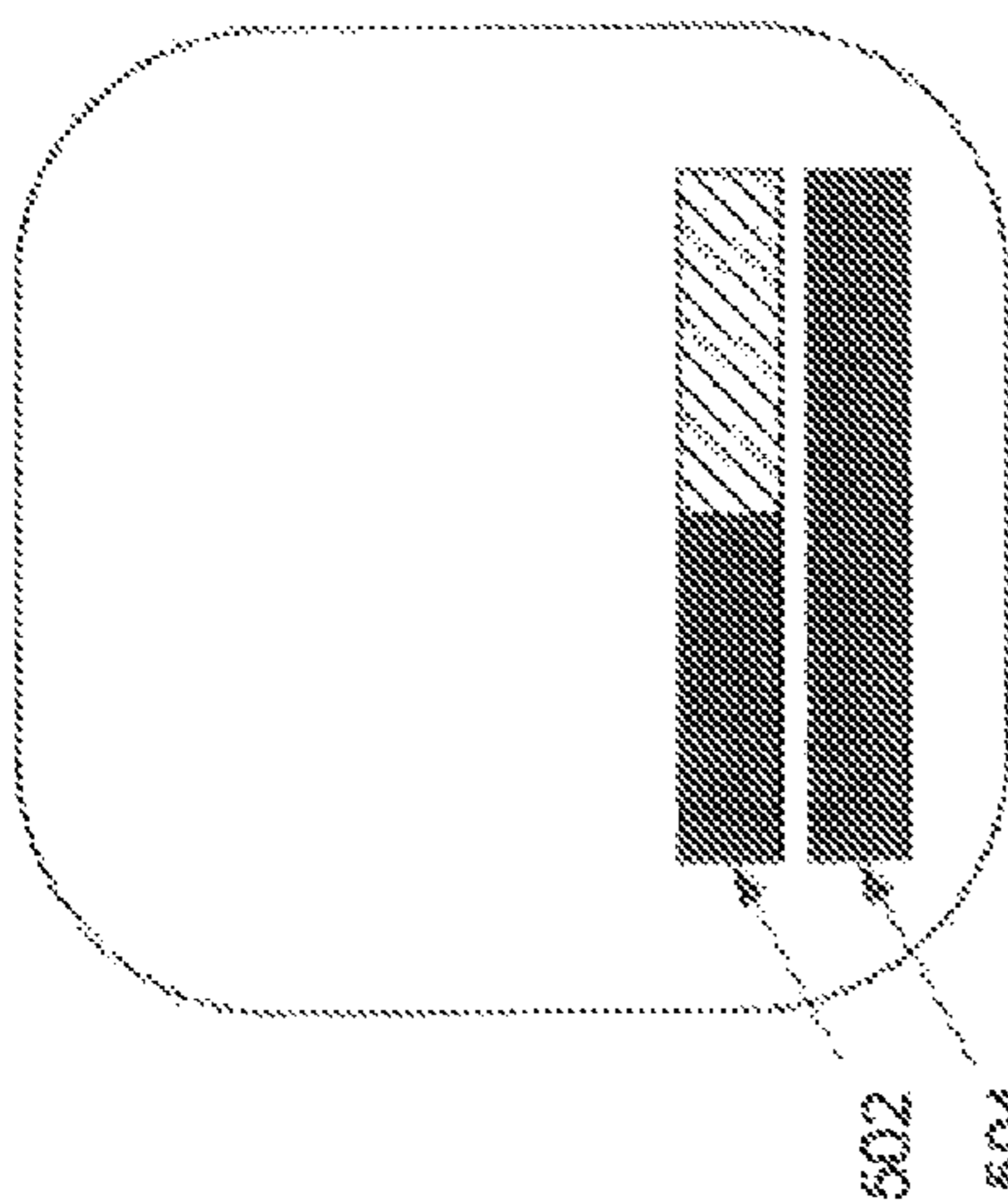

FIG. 5C

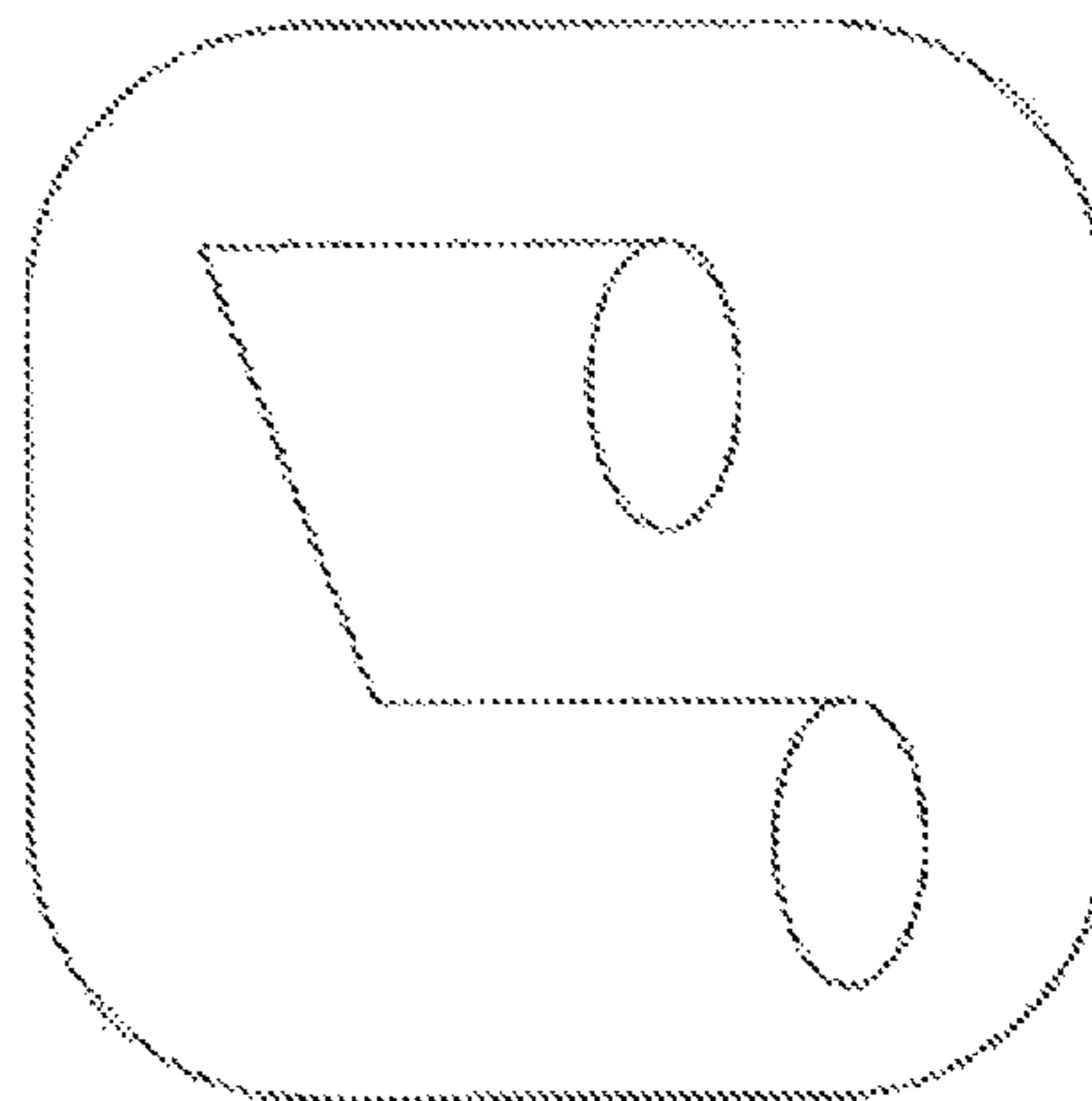

FIG. 5D

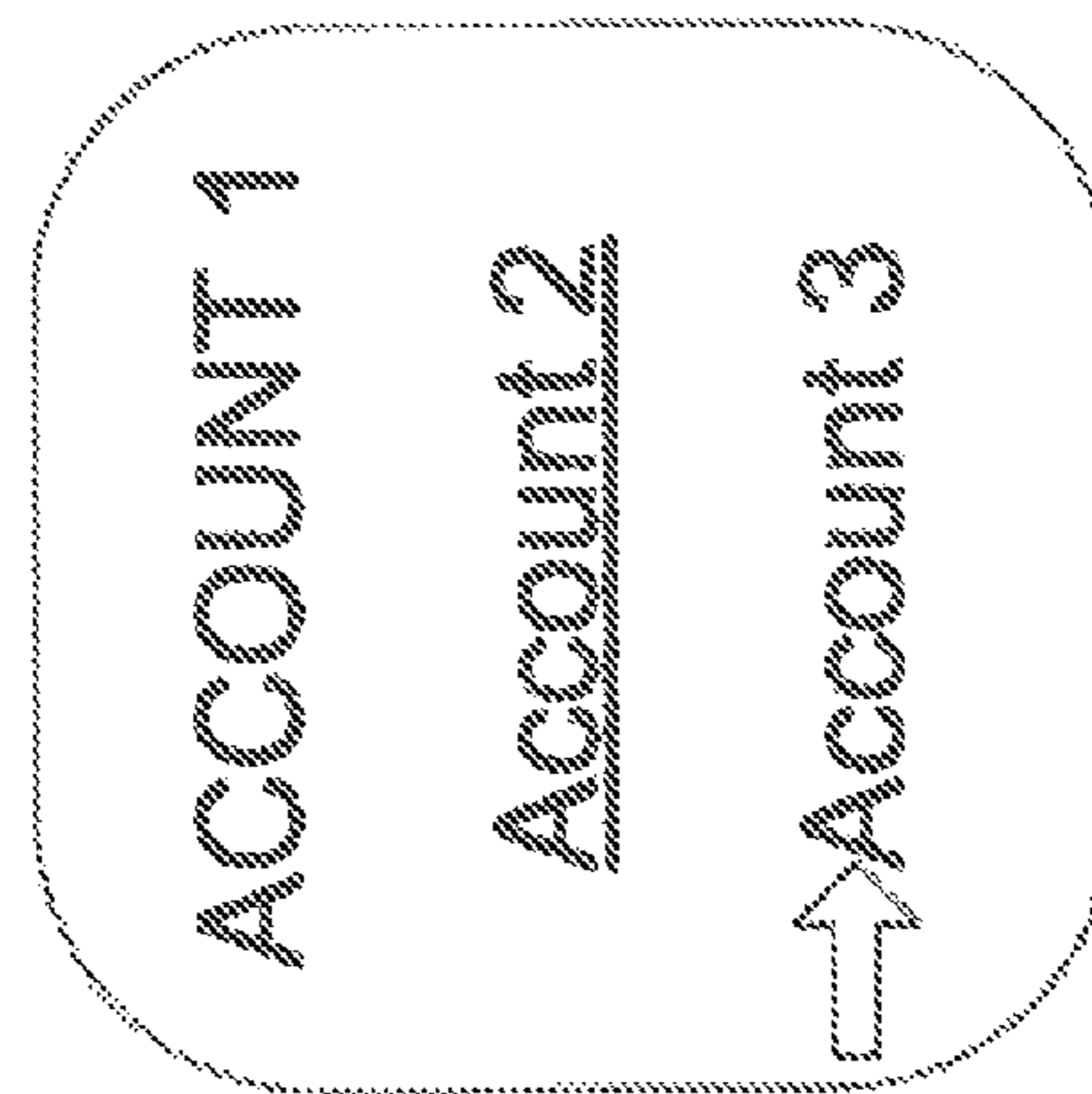

FIG. 5E

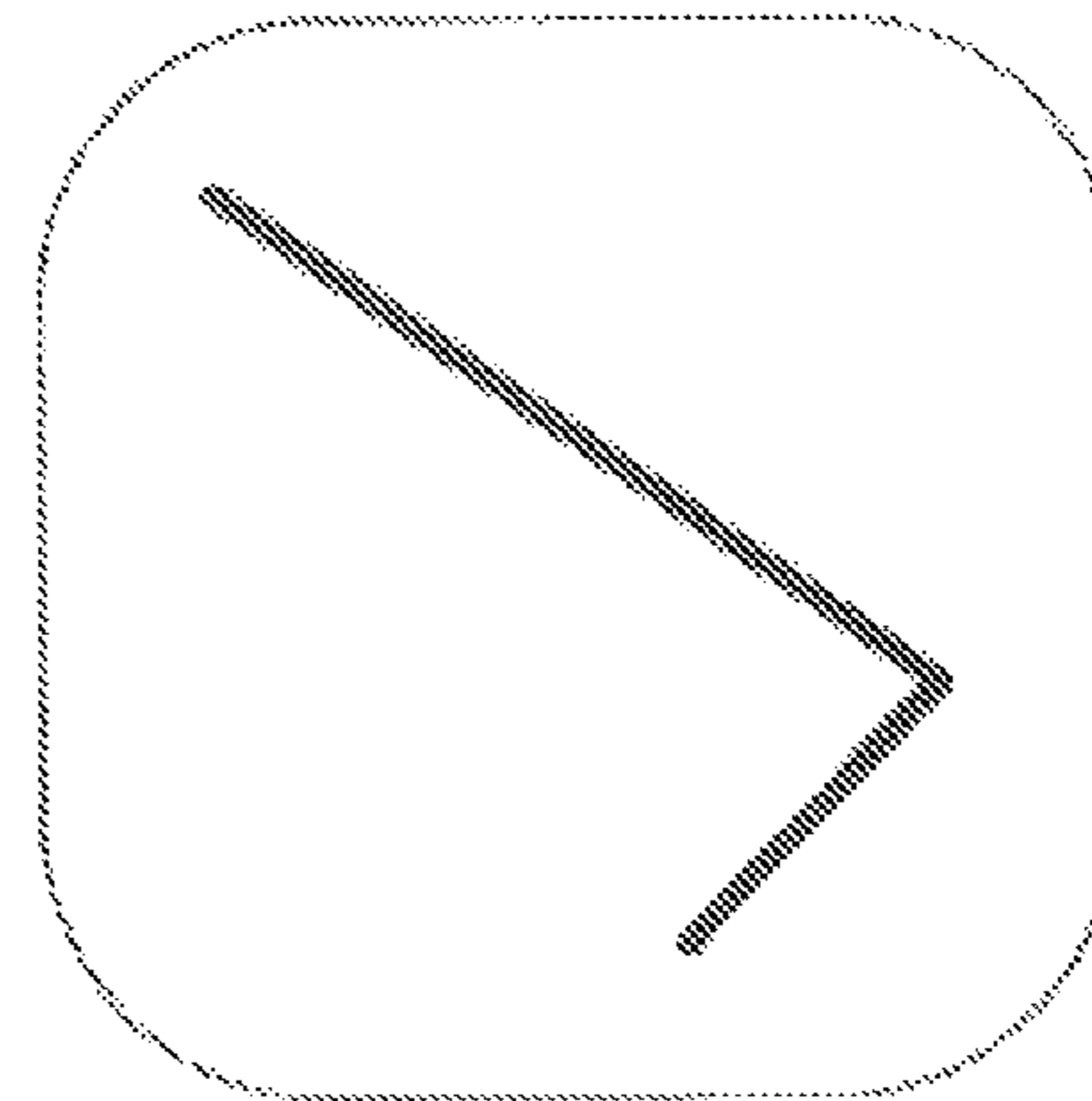

FIG. 5F

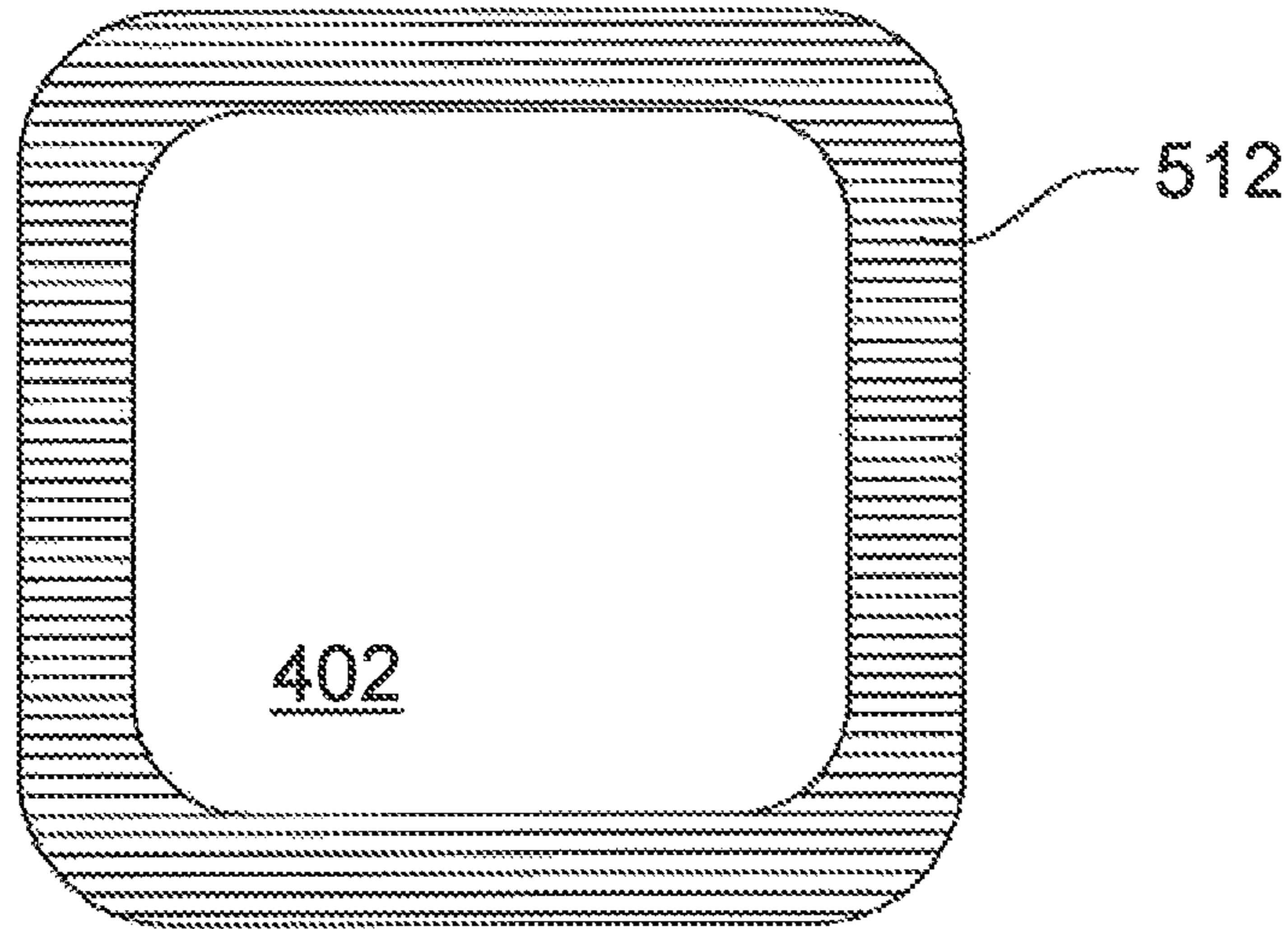

FIG. 5G

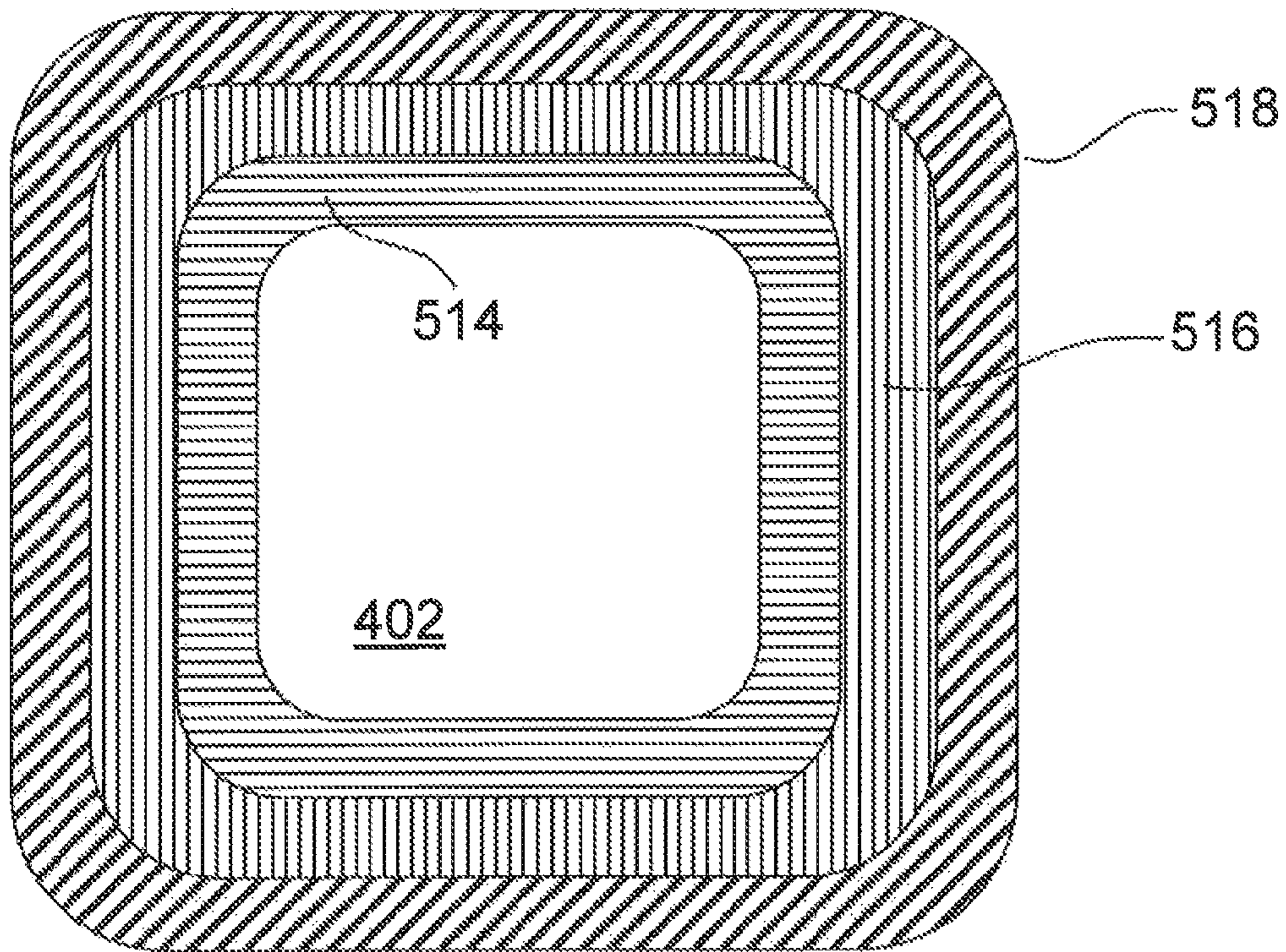

FIG. 5H



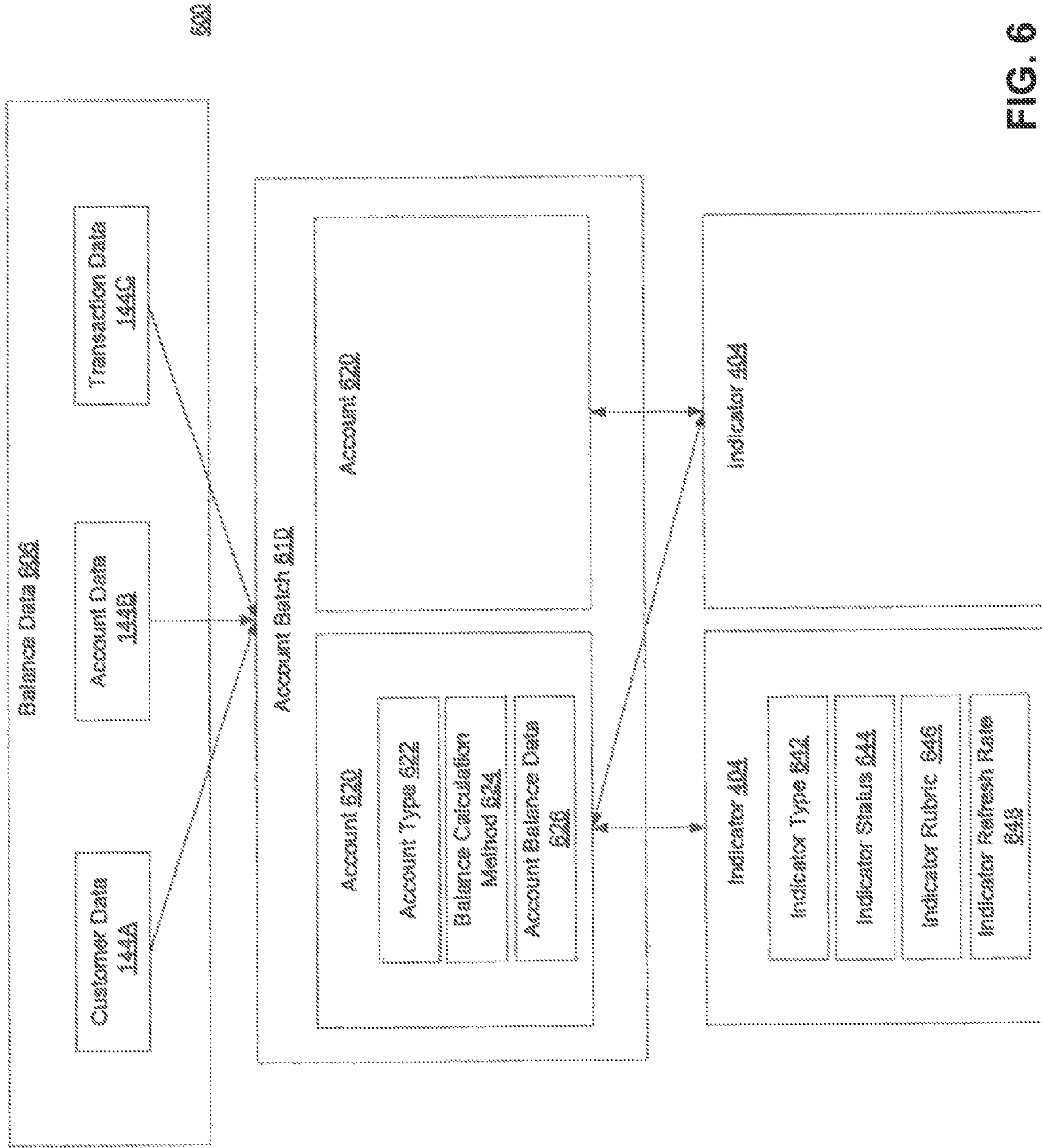

FIG. 6

700	User Account 1 (620)	User Account 2 (620)	User Account 3 (620)
Account Type (622)	Savings	Checking	Student Meal Plan
Balance Calculation Method (624)	Straight	Include monthly expenses, income, and purchases	Include yearly expenditure rates
Current Balance (626)	\$20,000	\$10,000	100 meals
Average Monthly Income (626)	\$500	\$5,000	30 meals
Average Monthly Expenses (626)	\$0	\$3,000	30 meals
Potential Transactions (626)	None	TV: \$1,500 Bill Payment: \$700	None
Effective Account Balance (EAB) (626)	\$20,000	\$9,800	40 meals
Indicator 1 (404)	Bar	Indicator 2 (404)	Indicator 2 (404)
Indicator Type (642)	Bar	Indicator 2 (404)	Indicator 2 (404)
Indicator Rubric (646)	If AB < \$5,000, color = red; else color = green	Red X if EAB of TA2 < \$10,000 or EAB of TA3 < 10	Red X if EAB of TA2 < \$10,000 or EAB of TA3 < 10
Indicator Status (644)	Color = Green	Glyph = Red X	Glyph = Red X

FIG. 7

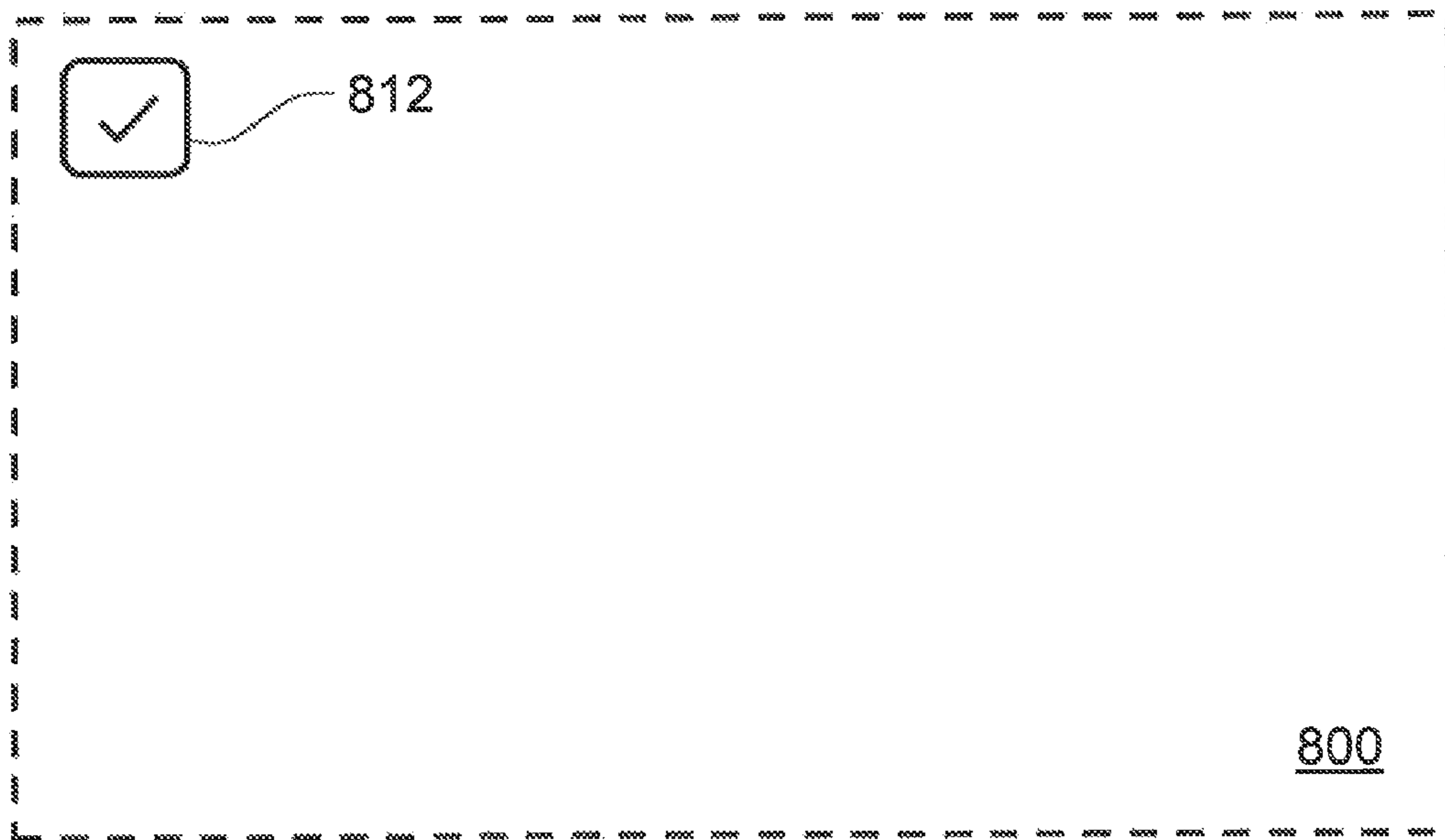

FIG. 8A

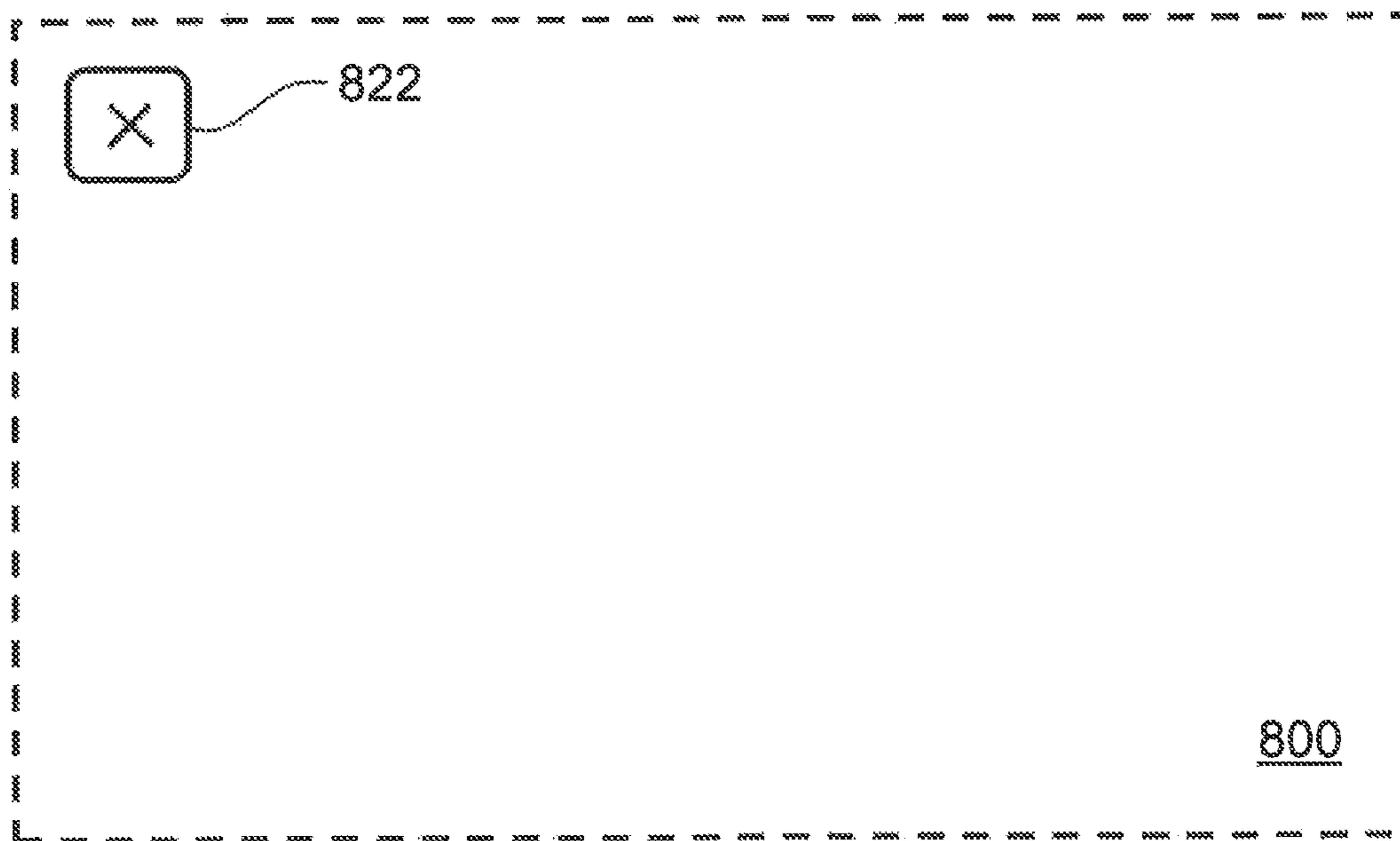

FIG. 8B



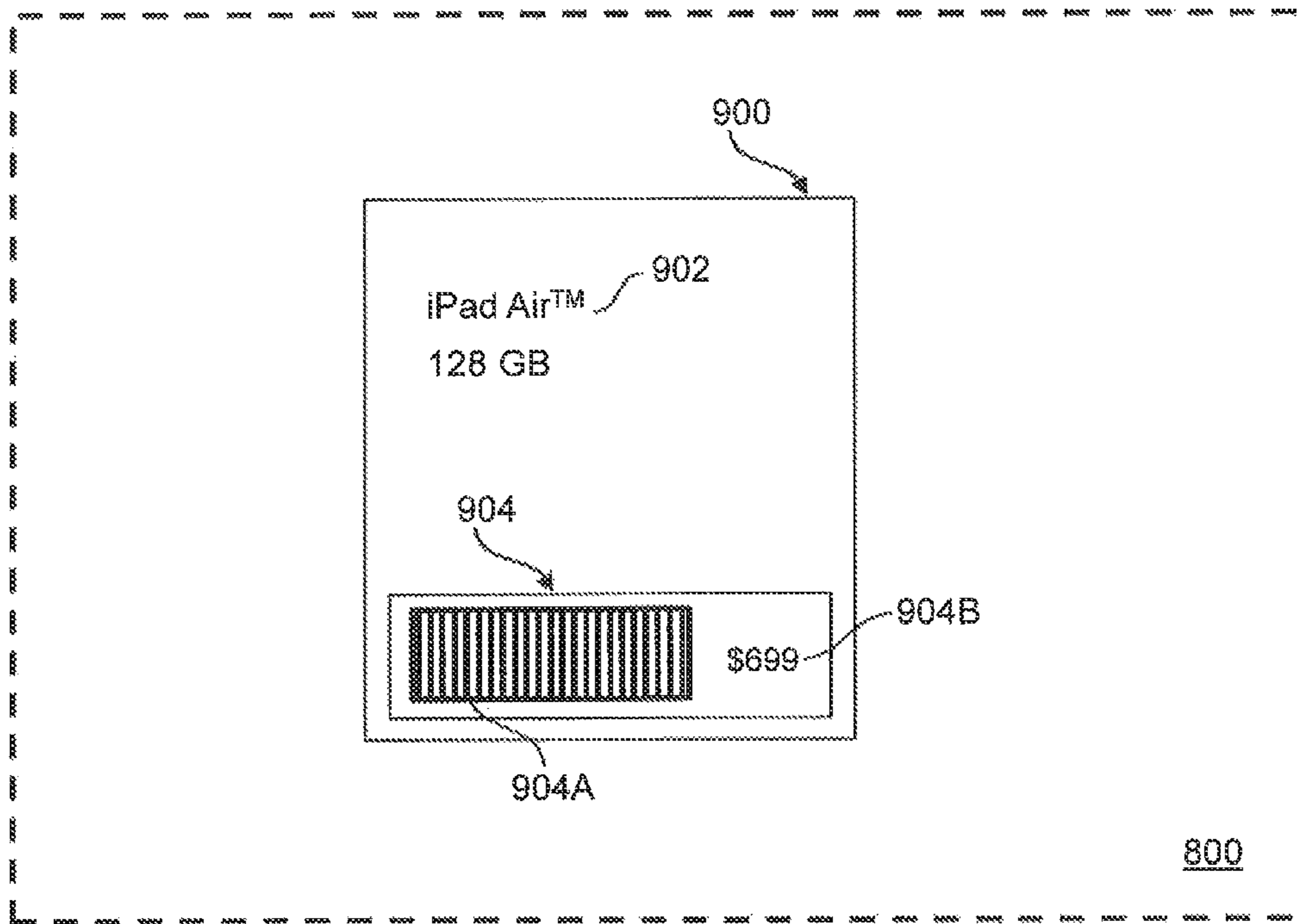

FIG. 9A

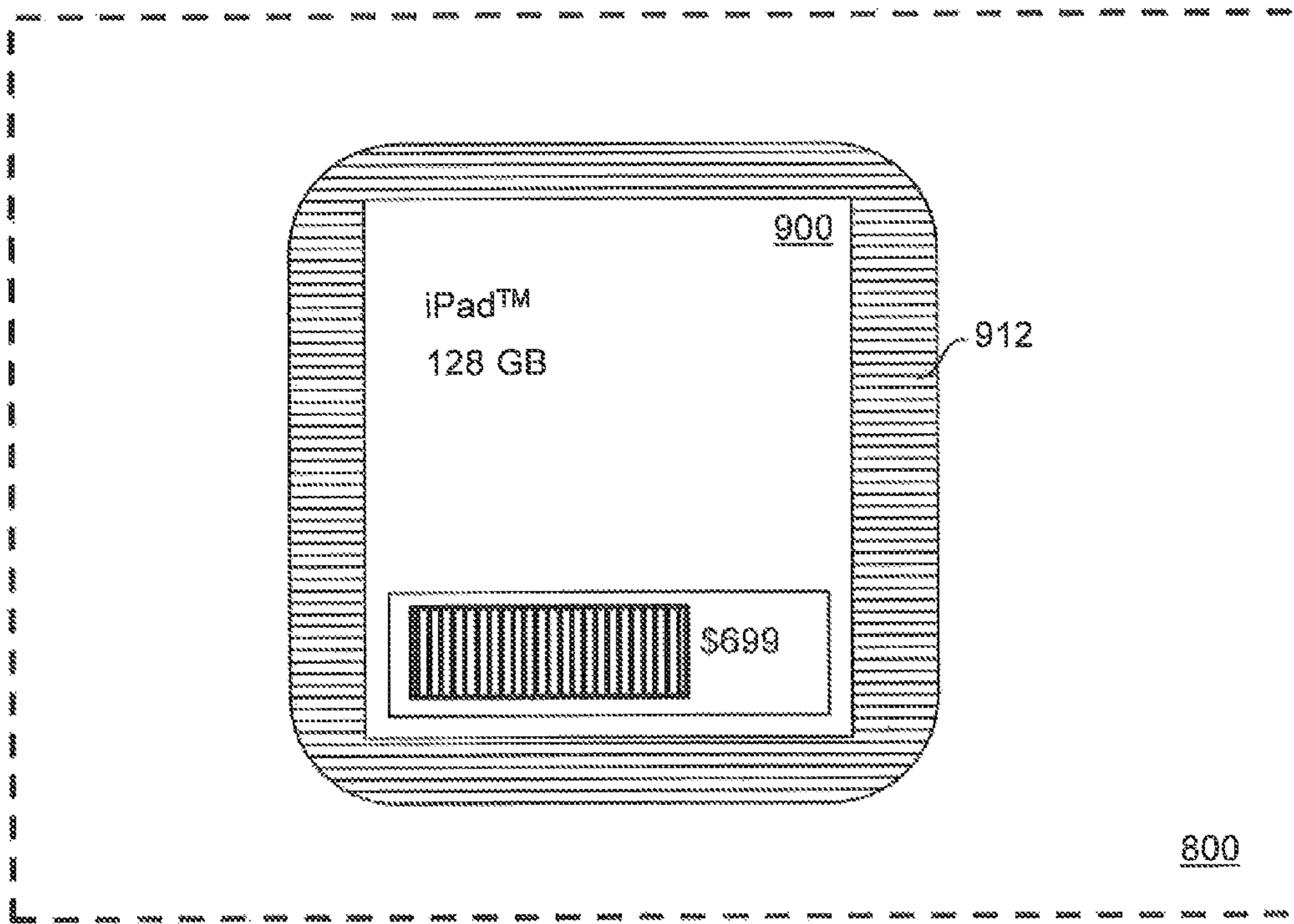

FIG. 9B

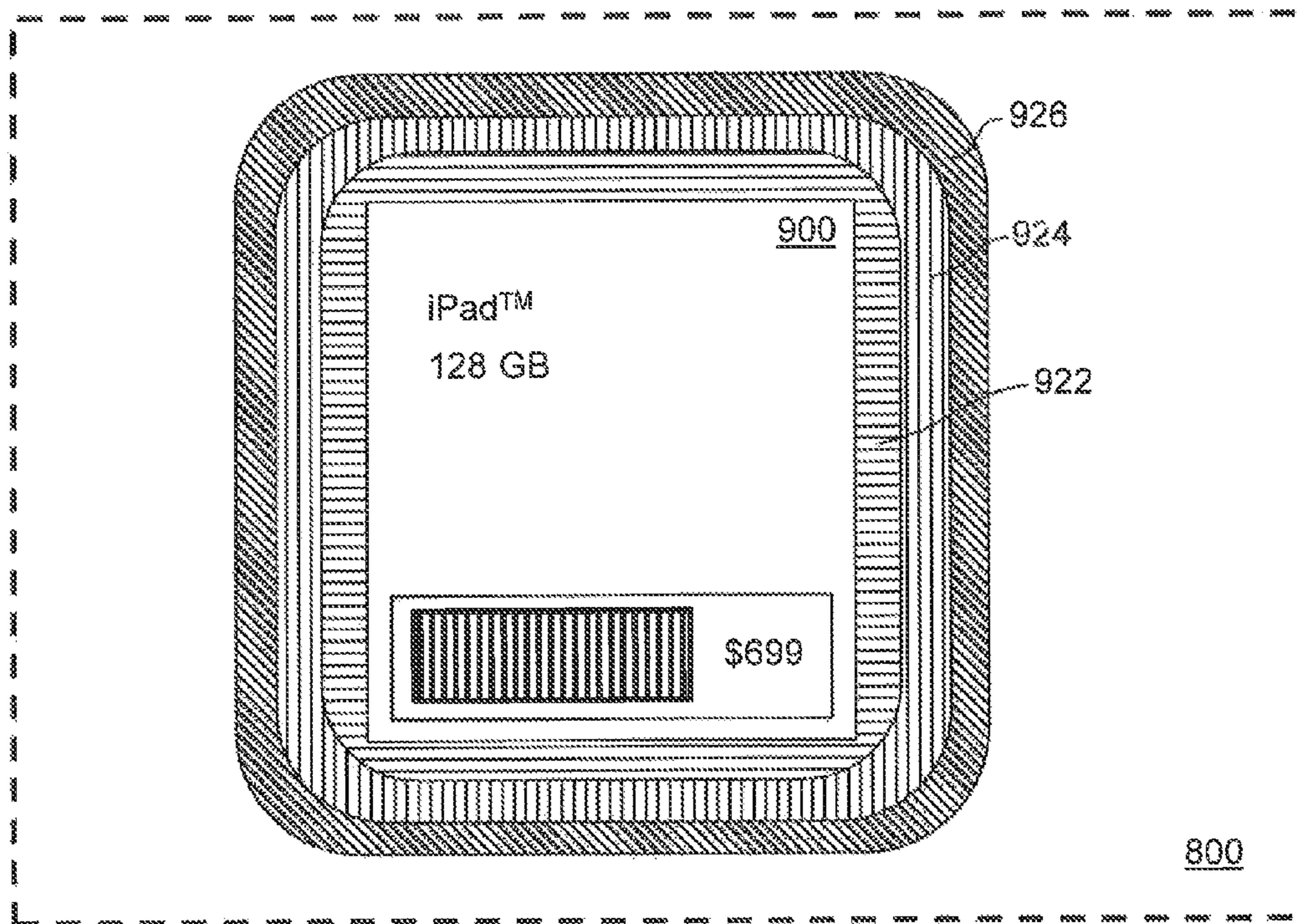

FIG. 9C



1000

<i>Device Name</i>	<i>Address</i>	<i>Eligible</i>	<i>Access Type</i>	<i>Indicator Type</i>
Mini Cooper	xxxa:95:xd:00:16	Yes	Authenticated	Status Bar, Pie Chart, Background, Picture, Symbol, Glyph, Text, Auditory
Lighting System	xxyb:90:xe:47:15	Yes	Indirect	Background
Security System	zLya:25:8t:44:33	No	-	-

1002

1004

1006

FIG. 10

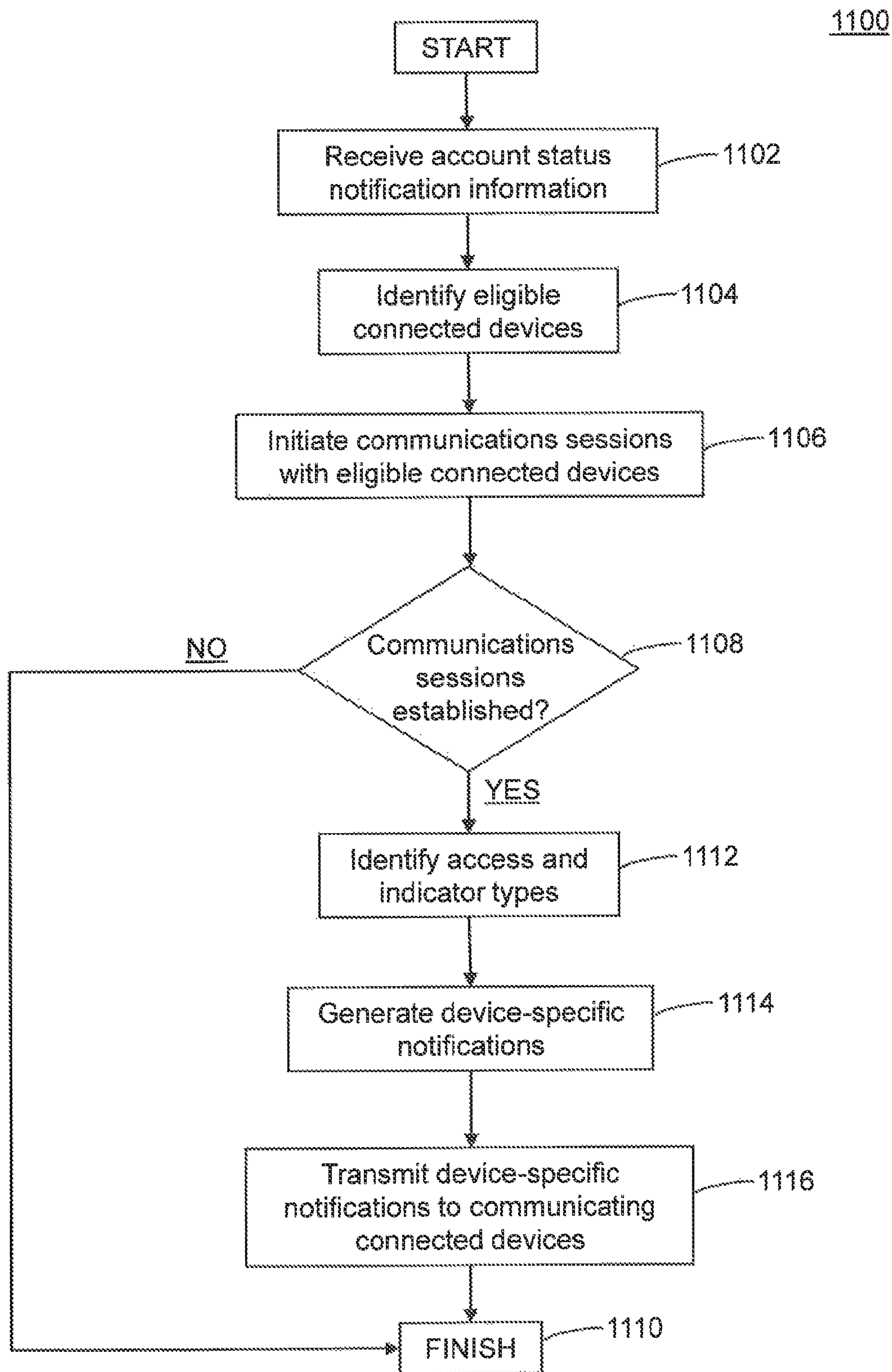

FIG. 11

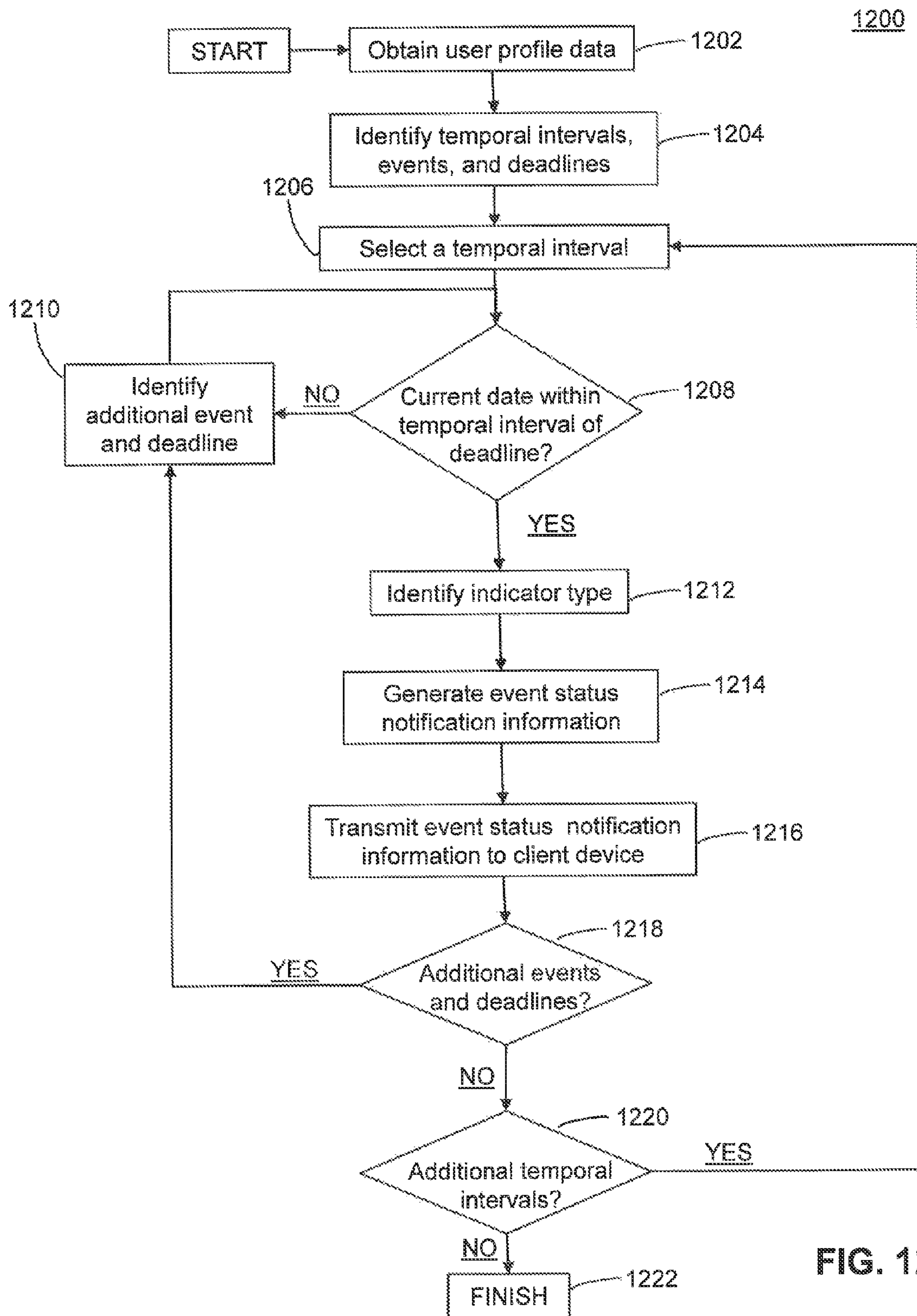

FIG. 12



**SYSTEMS AND METHODS FOR PROVIDING  
BALANCE NOTIFICATIONS TO  
CONNECTED DEVICES**

CROSS-REFERENCE TO RELATED  
APPLICATION

This application is a continuation-in-part of U.S. patent application Ser. No. 14/585,069, filed Dec. 29, 2014, which claims the benefit of priority to U.S. Provisional Patent Application No. 61/923,355, filed Jan. 3, 2014, the entire disclosure of which are expressly incorporated herein by reference to their entireties

BACKGROUND

Technical Field

The present disclosure generally relates to systems and methods for portraying information, and more particularly, and without limitation, to systems and methods for providing notifications for accounts.

Background

Status notifications provide users with information that may be helpful in assessing current situations relating to monitored items. In the financial service industry, for example, users benefit from systems that provide updates to the status of certain account parameters. Such mechanisms, however, are cumbersome for users and may require multiple operations to view the notification, such as logging in to an online banking site, opening an application to review notifications, and the like.

Aspects of the disclosed embodiments provide user-friendly visual, audial, or haptic (tactile) indicators that relay the status of one or more items in an accurate and efficient manner.

SUMMARY

The disclosed embodiments include methods and systems for providing account status notifications.

The disclosed embodiments include, for example, an apparatus having a storage device and at least one processor coupled to the storage device. The storage device may store instructions for controlling the at least one processor when executed by the at least one processor. The at least one processor may be operative with the instructions and configured to receive first notification information for an account of a user. In some aspects, the first notification information may be generated based on at least one notification rule and account information associated with the user account, and the first notification information may be indicative of a status of a parameter of the user account. The at least one processor may be further configured to obtain information identifying a device eligible to access the first notification information in accordance with a data restriction specified by the user. The at least one processor may be further configured to identify at least a portion of the first notification information for transmission to the eligible device. The identified portion may be consistent with the data restriction. The at least one processor may be further configured to provide the identified portion of the first notification information to the eligible device without receiving input from the user. In some aspects, the portion of the first notification information may instruct the eligible device to present at least one of a visual, audible, or tactile indicator of the status of the account parameter.

The disclosed embodiments also include a computer-implemented method that receives, by at least one processor, first notification information for an account of a user. In some aspects, the first notification information may be generated based on at least one notification rule and account information associated with the user account, and the first notification information may be indicative of a status of a parameter of the user account. The method also includes obtaining, by the at least one processor, information identifying a device eligible to access the first notification information in accordance with a data restriction specified by the user, and identifying, by the at least one processor, at least a portion of the first notification information for transmission to the eligible device. The identified portion may be consistent with the data restriction. The method also provides, by the at least one processor, the identified portion of the first notification information to the eligible device without receiving input from the user. In some aspects, the portion of first notification information may instruct the eligible device to present at least one of a visual, audible, or tactile indicator of the status of the account parameter.

In other embodiments, a tangible, non-transitory computer-readable medium stores instructions that, when executed by at least one processor, perform a method. In embodiment, the method includes receiving first notification information for an account of a user. In some aspects, the first notification information being generated based on at least one notification rule and account information associated with the user account, and the first notification information being indicative of a status of a parameter of the user account. The method also obtains information identifying a device eligible to access the first notification information in accordance with a data restriction specified by the user, and identifies at least a portion of the first notification information for transmission to the eligible device. The identified portion may be consistent with the data restriction. The method further provides the identified portion of the first notification information to the eligible device without receiving input from the user. In some aspects, the portion of the first notification information instructing the eligible device to present at least one of a visual, audible, or tactile indicator of the status of the account parameter.

The accompanying drawings constitute a part of this specification. The drawings illustrate several embodiments of the present disclosure and, together with the description, serve to explain the principles of the disclosed embodiments as set forth in the accompanying claims.

BRIEF DESCRIPTION OF THE DRAWINGS

FIG. 1 depicts an exemplary computing environment consistent with disclosed embodiments.

FIG. 2 depicts an exemplary computing system consistent with the disclosed embodiments.

FIGS. 3A, 3B, 3C, and 3D depict flowcharts of an exemplary process for providing a balance notification indicator consistent with disclosed embodiments.

FIG. 4 depicts an exemplary client device portraying a pictorial balance indicator consistent with disclosed embodiments.

FIGS. 5A, 5B, 5C, 5D, 5E, 5F, 5G, and 5H depict exemplary pictorial balance indicators consistent with disclosed embodiments.

FIG. 6 depicts an exemplary transaction account and indicator environment consistent with disclosed embodiments.



FIG. 7 depicts an exemplary transaction account and indicator environment for a single user associated with multiple accounts consistent with disclosed embodiments.

FIGS. 8A, 8B, 9A, 9B, and 9C depict exemplary account status indicators presented within a user's field-of-view, consistent with the disclosed embodiments.

FIG. 10 illustrates an exemplary data structure for storing connected device data, consistent with the disclosed embodiments.

FIG. 11 is a flow chart of an exemplary process for providing account status notifications to eligible connected devices, consistent with disclosed embodiments.

FIG. 12 is a flow chart of an exemplary process for generated and providing event notification information to networked devices.

### DESCRIPTION OF THE EMBODIMENTS

Reference will now be made in detail to embodiments, examples of which are illustrated in the accompanying drawings. Wherever possible, the same reference numbers will be used throughout the drawings to refer to the same or like parts.

In this application, the use of the singular includes the plural unless specifically stated otherwise. In this application, the use of "or" means "and/or" unless stated otherwise. Furthermore, the use of the term "including," as well as other forms such as "Includes" and "included," is not limiting. In addition, terms such as "element" or "component" encompass both elements and components comprising one unit, and elements and components that comprise more than one subunit, unless specifically stated otherwise.

FIG. 1 illustrates an exemplary computing environment consistent with certain disclosed embodiments. In one aspect, computing environment 100 may include a client device 104, system 140, and communications network 120 connecting one or more of the components of environment 100.

In one embodiment, system 140 may include one or more computer systems configured to gather, process, and store information. System 140 may be further configured to execute software instructions stored in memory performing one or more processes consistent with the disclosed embodiments. In certain aspects, system 140 may be associated with business entity 160, although such association is not required. In one embodiment, business entity 160 may be any type of entity (e.g., business, service provider, etc.) that may provide and maintain one or more accounts for one or more users (e.g., user 110). For example, business entity 160 may include, for example, a financial institution, retail store, university, merchant, online retail service provider, restaurant, hotel, or the like. In some embodiments, business entity 160 may be a commercial bank, investment bank, a provider of a payment instrument or financial service accounts, etc. As an example, a financial service account may be a checking, savings, credit, debit, gift card, reward, trading, investment, and/or loyalty account. In some aspects, a payment instrument may include, but is not limited to, a personal or corporate credit card, debit card, prepaid credit or debit card, gift card, or check instrument. In certain embodiments, an account may be used in a transaction, such as a purchase transaction, a banking transaction, or other forms of financial service transactions.

While the present disclosure sometimes describes certain aspects of business entity 160 as a financial institution, the disclosed embodiments are not so limited. In other embodiments, system 140 may be associated with a business entity

160 providing accounts for users 110 associated with other types of transactions, such as online services (e.g., an online retailer), merchant related services (e.g., purchasing goods or services at a physical retailer or restaurant, etc.), educational institution related services (e.g., student meal plans, etc.), and the like. Moreover, aspects of the disclosed embodiments are not limited to financial service accounts. In certain embodiments, an account may be associated with one or more account parameters, such as account balance, account limit, usage limit, remaining usage credit, or other parameters. The disclosed embodiments may be configured to determine, access, or generate information associated with one or more account parameters relating to one or more accounts for one or more users (e.g., user 110).

In one embodiment, system 140 may include one or more servers 142 and one or more memories, such as data repository 144. In one embodiment, server 142 may include a front end 142A, and a back end 142B in communication with front end 142A, although the configuration of server 142 is not limited to such configurations. In one example, front end 142A and back end 142B of server 142 may be incorporated into a single computer, or any additional or alternate computing device apparent to one or skill in the art. In other embodiments, front end 142A and backend 142B may be distributed computing elements. In certain aspects, front end 142A may be one or more software programs, such as a software application (e.g., a web service) executed by one or more processors included in server 142. Similarly, backend 142B may be one or more software programs executed by one or more processors included in server 142. Server 142 is not limited to such configurations. In additional embodiments, front end 142A software can be executed by a server or computing system separate from a server or computing system that executes back end 142B. In other embodiments, server 140 may be configured without front end 142A and/or back end 142B.

Server 142 may be configured to execute software instructions to perform one or more processes consistent with the disclosed embodiments. Server 142 may be implemented with one or more processors or computer-based systems. In one embodiment, client device 104 may exchange information and parameters facilitating execution of one or more transactions associated with system 140 as described herein.

Data repository 144 may be one or more data storages configured to store information consistent with the disclosed embodiments. In one aspect, data repository 144 may include customer data 144A, account data 144B, and transaction data 144C. In one aspect, customer data 144A may include one or more data records uniquely identifying one or more users 110 of business entity 160 associated with system 140. By way of example, a customer of a financial institution (e.g., business entity 160) may access a web page associated with system 140 (e.g., through a web server executed by front end 142A), and subsequently register for online banking services and provide data. The data may be linked to the customer and stored within customer data 144A.

In certain aspects, customer data 144A may include personal information associated with a user 110 (e.g., a name, home address, or date of birth). Customer data 144A may also include one or more authentication credentials associated with registered customers of the issuing bank. For example, the authentication credentials may include, but are not limited to, a user name, a user-specified password, a system-generated password, or an alphanumeric identification number (e.g., a PIN number) specified by the user or



assigned by system **140**. Other types of customer information may be stored and used by the disclosed embodiments.

Additionally or alternatively, customer data **144A** may include information facilitating enhanced authentication techniques. For example, customer data **144A** may store information identifying a security question associated with a customer (e.g., “What is your mother’s maiden name?”) and the customer’s registered answer to the security question. Customer data **144A** may also include information identifying a particular security image or avatar selected by the user and displayed by the user during the authentication process.

Customer data **144A** may include client device identification information identifying one or more client devices **104** registered to user **110**. In one embodiment, the user may provide the client device identification information (e.g., a mobile telephone number provided by the user when registering for online banking services, a mobile access control (MAC) address associated with client device **104**, etc.). Alternatively, server **142** may be configured to execute processes that automatically collect client device identification information (e.g., collecting an Internet Protocol (IP) address associated with the customer’s smartphone).

In an embodiment, customer data **144A** may include geographic position data associated with user **110** and/or at least one of client devices **104** registered to user **110**. For instance, the geographic position data may identify a current geographic position of user **110** and/or client devices **104**, and additionally or alternatively, one or more prior geographic positions of user **110** and/or client devices **104**. Geographic position data consistent with the disclosed embodiments may include, but is not limited to, a latitude, longitude, and/or altitude of a current or prior geographic position, additional geospatial coordinates or position information (e.g., a Where On Earth Identified (WOEID)), a geographic region associated with a current or prior geographic position, and/or a postal code associated with a current or prior geographic position.

In certain aspects, system **140** may obtain a portion of the geographic position data from client device **104** across communications network **120**. By way of example, client device **104** may include a global position system (e.g., a GPS) that tracks a current geographic position of client device **104**, and client device **104** may transmit geographic position data indicative of the current geographic position of client device **104** to system **140** across communication network **120**. For instance, client device **104** may append the geographic position data to data transmitted to system **140** in response to a completed transaction, and/or a required update to system **140**. In other instances, client device **104** may transmit the geographic position data to a third-party system (e.g., a mobile telecommunications provider), and system **140** may obtain portions of the geographic position data from the third-party system across network **140** through an appropriate application programming interface (API). Upon receipt of the geographic position data from client device **104** and/or the third party system, system **140** may be configured to format and store the received positional information within database **144** (e.g., as portions of customer data **144A**).

In certain aspects, account data **144B** may include account information identifying one or more accounts (e.g., account **620** of FIG. **6**) of users **110** of a business entity **160** associated with system **140**. In one embodiment, account information may include financial service account information for a business entity **160** such as a financial institution or a merchant. For example, such account information may

include information associated with a checking account, a savings account, a credit account, a debit account, a brokerage account, and any other type of account provided by business entity **160**. In other embodiments, account data **144B** may include information identifying investment portfolios held by one or more customers of business entity **160** (e.g., positions in one or more securities held by the customers of the financial institution).

In some aspects, account data **144B** may also include account parameter information associated with the one or more accounts of user **110**. For example, account parameter information consistent with the disclosed embodiments may include, but is not limited to, an account balance, an account limit, account identification information (e.g., account number, expiration date information, and/or card security code data), and other parameters associated with an account held by user **110**.

In other instances, the account parameter information may reflect a current usage and/or a remaining available usage of the one or more accounts. For example, user **110** may hold a debit card issued by the financial institution, which may provide a predetermined number of “free” transactions involving the debit card at participating ATMs (e.g., a predetermined number of withdrawal transactions without accruing fees). In certain aspects, the account parameter information may identify a number of transactions involving the debit card at the participating ATMs, a number of remaining free transactions, and any additional or alternate parameters describe user **110**’s current or remaining available usage.

Further, in additional embodiments, user **110** may participate in loyalty and/or rewards programs (e.g., referred to collectively as “loyalty programs”) provided by the financial institution, and additionally or alternatively, by one or more physical or electronic retailers associated with business entity **160**. In some aspects, account data **144B** may include information identifying the one or more loyalty programs in which the user participates and account information associated with the one or more loyalty programs (e.g., account numbers, account holders, addresses, etc.). Account data **144B** may also include information identifying one or more parameters of the loyalty programs. Loyalty program account parameters consistent with the disclosed embodiments include, but are not limited to, a current balance of points associated with the loyalty programs (e.g., “loyalty points”), a number of loyalty points required to achieve one or more rewards or dividends, information identifying an impact of specific purchases on user **110**’s accrued loyalty points (e.g., a loyalty program may accrue double points based on purchases of specific good and/or specific retailers), and numbers of loyalty points remaining before user **110** achieves one or more rewards. In certain aspects, the loyalty program information and/or loyalty program parameter information may enable system **140** and/or client device **104** to determine an impact of a potential purchase on user **110**’s loyalty points and determine whether the potential purpose would enable user **110** to achieve a reward.

In other aspects, account data **144B** may include account information associated with other types of accounts, such as student meal plans, gift cards, store credit, wireless communications plans, or any other kind of account capable of maintaining a balance associated with system **140**. For example, account data **144B** may include information associated with a meal plan on system **140** for a student at a university (e.g., business entity **160**). In another example, account data **144B** may include information associated with a gift card for customer **110** on a merchant’s (e.g., business



entity **160**) system **140**. Further, in some instances, account data **144B** may include information associated with a wireless plan (e.g., cellular telephone and data) provided by a wireless carrier (e.g., business entity **160**).

In some aspects, the account information may reflect one or more account parameters associated with current or remaining usage of the account for a service. For example, account parameters consistent with the disclosed embodiments may identify transportation credits used to gain access to public transportation (e.g., bus, train, etc.), a number of meals remaining on the student's meal plan, a number of cellular minutes, text messages, and/or data remaining on user **110**'s wireless plan, etc.

Transaction data **144C** may include information reflecting one or more transactions involving one or more accounts associated with business entity **160** and/or system **140**. For example, transaction data **144C** may relate to one or more purchase transactions involving an account associated with a user (e.g., user **110**) and provided by business entity **160**. Transaction data **144C** may also include information relating to activities associated with one or more accounts provided by business entity **160** and processed by system **140**. For example, transaction data **144C** may include data reflecting past bill payments that occur electronically through online bill payment processes provided by system **140**. The data may include information such as payment amount, payee, date(s) of payments, descriptions of the type of payment and/or payee, etc. Transaction data **144C** may also include information related to prior transactions, historical transactions, or scheduled transactions associated with one or more accounts provided by business entity **160**.

In other aspects, transaction data **144C** may include information identifying one or more potential transactions involving one or more accounts of business entity **160** associated with system **140**. In one embodiment, potential transactions may include, but are not limited to, potential purchase transactions (e.g., purchases of goods and/or services from electronic or physical retailers), potential financial service transactions (e.g., fund transfers), potential bill payment transactions (e.g., electronic bill payment transactions), potential financial instrument or security transactions (e.g., purchases of securities), potential deposits or withdrawals of funds, or potential applications for credit from the financial institution or other entity. In certain aspects, system **140** may receive from client device **104** information reflecting a potential purchase transaction involving one or more accounts associated with one or more users (e.g., user **110**). System **140** may store the potential purchase transaction information as transaction data **144C** for respective users. In other aspects, system **140** may execute software processes that track the potential purchase transactions for respective account(s), determine and maintain a running total of purchase price(s) associated with goods/services associated with the potential purchase transactions on an account basis, a user basis (e.g., multiple accounts held by a user), or other data configurations.

Client device **104** may include one or more client devices. In certain embodiments, client device **104** may be associated with one or more users **110**. In one example, user **110** may use client device **104** to perform one or more processes consistent with the disclosed embodiments. Client device **104** may include, but is not limited to, a personal computer, a laptop computer, a tablet computer, a notebook computer, a hand-held computer, a personal digital assistant, a portable navigation device, a mobile device (e.g., mobile phone), a wearable device (e.g., a smart watch, a wearable activity monitor, wearable smart jewelry, and glasses and other

optical devices that include optical head-mounted displays (OHMDs), an embedded device (e.g., in communication with a smart textile or electronic fabric), a set top box, an optical disk player (e.g., a DVD player), a digital video recorder (DVR), and any other computing device. In other instances, client device **104** may include optical devices capable of providing a "heads-up" display to user **110** (e.g., vehicle-based heads-up displays), and other optical devices capable of presenting an augmented reality (AR) view that "pop-ups" within a field of view of user **110**. In additional instances, the heads-up display and/or the AR view provided by the optical devices may modify an object visible within user **110**'s environment (e.g., an "in-view" object within user **110**'s field-of-view, and additionally or alternatively, within an image or video presented user **110** by the optical devices) to indicate a status of an account of user **110** by, for example, generating and presenting information that "overlays" a portion of the in-view object (e.g., overlaying interface element over a top portion of the in-view object, surrounding the in-view object, and/or within the in-view object). In certain aspects, client device **104** may blend computer-generated graphics with user **110**'s real-world or virtual environments to visually indicate a status of one or more of user **110**'s accounts. Client device **104** may be implemented with one or more processors or computer-based systems, such as for example, computer system **200** of FIG. 2.

Communications network **120** may include one or more communication networks or medium of digital data communication. Examples of communication network **120** include a local area network ("LAN"), a wireless LAN, a RF network, a Near Field Communication (NFC) network, (e.g., a "WiFi" network), a wireless Metropolitan Area Network (MAN) connecting multiple wireless LANs, NFC communication link(s), and a wide area network ("WAN"), e.g., the Internet. Consistent with embodiments of the present disclosure, communications network **120** may include the Internet and any publicly accessible network or networks interconnected via one or more communication protocols, including, but not limited to, hypertext transfer protocol (HTTP) and transmission control protocol/internet protocol (TCP/IP). Communications protocols consistent with the disclosed embodiments also include protocols facilitating data transfer using radio frequency identification (RFID) communications and/or NFC. Moreover, communications network **120** may also include one or more mobile device networks, such as a GSM network or a PCS network, allowing client device **104** to send and receive data via applicable communications protocols, including those described herein.

Although FIG. 1 illustrates computing environment **100** with one client device **104**, the disclosed embodiments may include a plurality of client devices **104**. Similarly, while FIG. 1 depicts computing environment **100** with a single system **140** and user **110**, persons of ordinary skill in the art will appreciate environment **100** may include any number of systems **140** and users **110**, which may be associated with one or more client devices **104**. In one embodiment, a single business entity **160** may employ several systems **140** that may communicate with each other (e.g., over a LAN, WAN, or other communications network **120**). System(s) **140** may also be configured to communicate with one or more other systems, which may or may not be associated with other business entities.

Further, in some aspects, client device **104** may be configured to establish peer-to-peer communications sessions with other client devices disposed within computing envi-



ronment **100** (e.g., “connected devices”) using one or more of the communications protocols outlined above. For example, client device **104** and the connected devices may be uniquely identifiable and addressable within communications network **120**, and may be capable of transmitting and/or receiving data across the established communications sessions. Further, in some aspects, client device **104** may be configured to establish the communications sessions with one or more of the connected devices, and to exchange data with the connected devices autonomously and without input or intervention from a user of client device **104** (e.g., user **110**). For instance, the disclosed embodiments may enable client device **104** to receive data from system **140**, to identify a connected device capable of receiving transmitted data from client device **104**, and further, to autonomously transmit the received data (e.g., to “push” the received data) to the identified connected device without input from user **110**. By way of example, connected devices consistent with the disclosed embodiments may include, but are not limited to mobile communications devices (e.g., mobile telephones, smart phones, tablet computers, etc.) and other devices capable of communicating with client device **104** (e.g., internet-ready televisions, internet-ready appliances and lighting fixtures, computing devices disposed within motor vehicles, etc.).

FIG. **2** illustrates an exemplary computer system **200** with which embodiments consistent with the present disclosure may be implemented. In certain embodiments, computer system **200** may reflect computer systems associated with server **142** or client device **104**. In certain embodiments, computer system **200** may include one or more processors **202**. Processor **202** may be connected to a communication infrastructure **206**, such as a bus or communications network, e.g., a communications network **120** depicted in FIG. **1**.

Computer system **200** may also include a main memory **208**, for example, random access memory (RAM), and may include a secondary memory **210**. Memory **208** may represent a tangible and non-transitory computer-readable medium having stored therein computer programs, sets of instructions, code, or data to be executed by processor **202**. Secondary memory **210** may include, for example, a hard disk drive **212**, and/or a removable storage drive **214**, representing a magnetic tape drive, flash memory, an optical disk drive, CD/DVD drive, etc. The removable storage drive **214** may read from and/or write to a removable storage unit **218** in a well-known manner. Removable storage unit **218** may represent a magnetic tape, optical disk, or other storage medium that is read by and written to by removable storage drive **214**. Removable storage unit **218** may represent a tangible and non-transitory computer-readable medium having stored therein computer programs, sets of instructions, code, or data to be executed by processor **202**.

In alternate embodiments, secondary memory **210** may include other means for allowing computer programs or other program instructions to be loaded into computer system **200**. Such means may include, for example, a removable storage unit **222** and an interface **220**. An example of such means may include a removable memory chip (e.g., EPROM, RAM, ROM, DRAM, EEPROM, flash memory devices, or other volatile or non-volatile memory devices) and associated socket, or other removable storage units **222** and interfaces **220**, which allow instructions and data to be transferred from the removable storage unit **222** to computer system **200**.

Computer system **200** may also include one or more communications interfaces, such as communications interface **224**. Communications interface **224** allows software and data to be transferred between computer system **200** and external devices. Examples of communications interface **224** may include a modem, a network interface (e.g., an Ethernet card), a communications port, a PCMCIA slot and card, etc. Communications interface **224** may transfer software and data in the form of signals **226**, which may be electronic, electromagnetic, optical or other signals capable of being received by communications interface **224**. These signals **226** may be provided to communications interface **224** via a communications path (i.e., channel **228**). Channel **228** carries signals **226** and may be implemented using wire, cable, fiber optics, RF link, and/or other communications channels. In a disclosed embodiment, signals **226** comprise data packets sent to processor **202**. Information representing processed packets can also be sent in the form of signals **226** from processor **202** through communications path **228**.

In certain embodiments in connection with FIG. **2**, the terms “storage device” and “storage medium” may refer to particular devices including, but not limited to, main memory **208**, secondary memory **210**, a hard disk installed in hard disk drive **212**, and removable storage units **218** and **222**. Further, the term “computer-readable medium” may refer to tangible devices including, but not limited to, a hard disk installed in hard disk drive **212**, any combination of main memory **208** and secondary memory **210**, and removable storage units **218** and **222**, which may respectively provide computer programs and/or sets of instructions to processor **202** of computer system **200**. Such computer programs and sets of instructions can be stored within one or more computer-readable media. Additionally or alternatively, computer programs and one or more sets of instructions may also be received via communications interface **224** and stored on the one or more computer-readable media.

Such computer programs and instructions, when executed by processor **202**, enable processor **202** to perform one or more processes consistent with the disclosed embodiments. Examples of program instructions include, for example, machine code, such as code produced by a compiler, and files containing a high-level code that can be executed by processor **202** using an interpreter.

Furthermore, the computer-implemented methods of the disclosed embodiments may be performed via one or more processors of a single or multiple computer systems, such as processor **202** of system **200**.

In certain aspects, the disclosed embodiments include systems and methods for providing account status notifications. In one embodiment, account status notifications may be provided in the form of account status indicators. In one aspect, system **140** may perform processes that generate and provide account status indicators to client device **104** for presentation. In another aspect, system **140** may generate account status notification information that is provided to client device **140** for generating and presenting account status indicators. Client device **104** may be configured to execute software instructions that perform operations, such as generating account status indicators based on account status notification information or account information received from system **140**. An account status indicator may be associated with one or more accounts, and an account may be associated with one or more account status indicators. The one or more accounts may be associated with a single user **110**. Alternatively, the one or more accounts may be associated with one or more users **110**. In one embodiment, an account status indicator may represent information



associated with one or more accounts provided by system **140** and/or business entity **160** and associated with one or more users (e.g., user **110**).

In certain embodiments, an account status indicator may reflect the status of one or more account parameters of one or more accounts, such as an account balance, account usage, credit balance, one or more thresholds associated with such parameters, etc. In certain aspects, an account status indicator may be a visual indicator, an audio indicator, and/or a tactile indicator (e.g., a vibrate feature). For example, an account status indicator may include a graphical representation that visually reflects the status of one or more parameters of one or more accounts. Examples of graphical account status indicators may include icons that are displayed on an interface of a display device, such as a display of a mobile device (e.g., client device **104**). The icon may take the shape of an image corresponding to business entity **160** (e.g., corporate logo, or other representation). A graphical account status indicator may also include a status bar, dashboard type graphical images, glyphs, personal photos, and any other type of graphical representation that may be displayed on an interface. The graphical representations may be color coded, such that, for example, the account status indicator dynamically changes based on the status of one or more account parameters associated with one or more accounts. An audio account status indicator may include a sound or sequence of sounds, music, etc. that may be presented through a speaker of client device **104**, for example. In one aspect, an audio account status indicator may dynamically change (e.g., change sound(s), music, etc.) based on the status of one or more account parameters associated with one or more accounts. The above examples are not limiting to the type, configuration, format, and representations of account status indicators consistent with the disclosed embodiments.

In certain aspects, system **140** may be configured to generate an indicator and send the indicator to client device **104**. The generated indicator may represent information associated with one or more transaction accounts including past, present, predicted, predefined, or potential effective balances for the one or more transaction accounts. The generated indicator may also incorporate potential transactions affecting the one or more transaction accounts associated with user **110**. The indicator may take the form of pictorial, audible, or tactile responses consistent with disclosed embodiments.

In one aspect, the disclosed embodiments may allow one or more account status indicators to be presented in a non-obtrusive manner. For example, the disclosed embodiments may allow one or more account status indicators to be presented without a user request for the status of one or more parameters of one or more accounts. For instance, client device **104** may be configured to automatically present an account status indicator reflecting the status of an account parameter for an account associated with user **110**, such as updating the color, format, configuration, size, etc. of a graphical representation on an interface displayed on a display device of client device **104**. Further, aspects of the disclosed embodiments may allow characteristic(s) of an account status indicator to reflect one or more account parameters in relation to one or more thresholds. As an example, a graphical account status indicator may change color or size, etc. when an account balance falls below, is equal to, or exceeds a determined balance threshold amount or a balance threshold range(s) (e.g., green, yellow, red).

The disclosed embodiments may also facilitate a presentation of account status indicators based on geographic

position information associated with user **110** and/or client device **104**. For example, client device **104** may be configured to present one or more of the account status indicators when system **140**, and additionally or alternatively, client device **104**, determines that a current geographic position of user **110** falls within a predefined geographic region or is disposed proximate to a predefined geographic location (e.g., a point-of-interest, a retailer, a bus stop or train station, etc.). In further aspects, system **140** (and additionally or alternatively, client device **104**) may be configured to select an account status indicator for presentation based on a relationship between the account status indicator and a current geographic position of user **110**. For example, system **140** and/or client device **104** may select, for presentation to user **110**, an account status indicator associated a merchant's loyalty program when user **110** is disposed proximate to a physical location of the merchant. Other aspects of account status indicators are described herein and the above examples are not limiting to the disclosed embodiments.

FIG. 3A shows a flowchart of an exemplary account status notification configuration process **300A** consistent with disclosed embodiments. In one embodiment, process **300A** may be performed by system **140**. System **140** may be configured to generate and provide access to a configuration process that allows a user (e.g., user **110**) to configure and control how account status notifications are provided for one or more accounts. In one aspect, system **140** may generate one or more interfaces that enable user **110** to select and/or provide controls defining the type of account status indicator(s) that may be presented via client device **104** (e.g., select graphical indicators and/or audio indicators, etc.) System **140** may provide options in the form of menus, hyperlink selections, user-provided representations, etc. Further, system **140** may allow user **110** to define one or more threshold values that determine when and how one or more account status indicators will be presented.

Referring to FIG. 3A, in one embodiment system **140** may generate and provide account status notification configuration option(s) (step **310A**). Account status notification configuration option(s) may include selections of account status indicator types and selections of account status notification parameter(s). For instance, user **110** may select, via the option(s), one or more account status indicators. System **140** may also allow user **110** to select one or more accounts to be associated with the selected one or more account status indicators. The selected one or more accounts may be account(s) associated with user **110** or may be one or more accounts associated with a different user (e.g., a family member, employee, etc.)

In response to the configuration option(s), user **110** may select and/or define one or more account status configuration option(s). System **140** may obtain the selected one or more account status configuration option(s) from client device **140** or other system associated with user **110** (step **320A**). System **140** may associate the selected notification configuration option(s) with the user **110**'s selected one or more accounts (step **330A**). Based on the determined account status indicator(s) and configuration option(s), system **140** may configure one or more notification rule(s) to apply to the one or more accounts and associated account status indicators identified by user **110** during the configuration process **300A** (step **340A**).

As explained, the disclosed embodiments may allow a user to configure the manner and way account status notifications may be determined, provided, and presented. For example, the disclosed embodiments may allow a user to customize the format and way an account status indicator



changes when an update to the indicator is to occur. For instance, a user may select colors of graphical indicators for different status levels (e.g., green for above a threshold, red for below, etc.). In certain aspects, the disclosed embodiments may allow a user to choose one or more colors for the graphical indicators. As another example, the disclosed embodiments may allow a user to configure the notifications such that a graphical indicator, such as an icon, can change format or type. For instance, a user may, through the configuration process 300A, configure the notification for an account to allow an icon background to change to a selected picture from the user's photo album stored on client device 104 when the account status indicator is to be updated. In certain aspects, using symbols, glyphs, pictures, or other types of images to reflect certain status levels for one or more parameters of an account may provide increased security of the information should the account status indicator be viewed by another person viewing the display of client device 104 when the account status indicator is displayed. For instance, user 110 may configure a status notification for a first account such that a default icon image changes to a first image (e.g., picture of a family member) when a first account parameter is above a determined threshold (e.g., account balance is above or equal to \$200). The default icon may also be configured to change to a second image when the first account parameter is below the determined threshold (e.g., account balance is below \$200).

FIG. 3B shows a flowchart of an exemplary account status notification process 300B consistent with disclosed embodiments. In one example, system 140 may obtain transaction data associated with one or more transactions involving one or more of the selected one or more accounts identified in the configuration process 300A (step 310B). For example, user 110 may use a first account to purchase goods from one or more merchants. System 140 may receive transaction data associated with the purchase(s) from, for example, merchant systems associated with the merchant(s) involved in the transaction. The disclosed embodiments may also obtain transaction data in other ways. System 140 may perform an account status notification process based on the obtained transaction data (step 320B). In one embodiment, system 140 may determine changes to one or more parameters of the user's selected one or more account(s) based on the transaction data (e.g., determine updated balance(s), updated credit limit(s), etc.). Based on the results from that analysis, system 140 may execute software instructions that perform processes that apply the one or more notification rule(s) determined in process 300A. For example, depending on the type of notification that user 110 may have configured, system 140 may determine a current balance of a first account (e.g., a checking account held by user 110 or an account associated with a loyalty program in which user 110 participates) after one or more purchase transactions reflected in the obtained transaction data. System 140 may apply the rule(s) to compare determined current one or more account parameter(s) (e.g., balance, remaining usage, loyalty program points, etc.) against one or more threshold values or ranges to determine whether an account status indicator is to be generated or updated. Based on that analysis, system 140 may generate or update one or more account status indicator(s) associated with the account(s) under analysis (step 330B). System 140 may provide the generated or updated account status indicator(s) for presentation (step 340B). For example, system 140 may provide an updated account status indicator to client device 104 that is displayed on an interface of client device 104 without a user request for an account status.

In certain embodiments, system 140 may be configured to generate account status notification information that is used to generate account status indicator(s) at the client device 104. In another aspect, client device 104 may be configured to execute software processes that perform process steps 320B-340B based on account information provided by system 140. For example, in one embodiment, system 140 may perform account status notification process (step 320B) and provide notification information to client 104. Client device 104 may generate or update one or more account status indicator(s) based on the notification information and one or more configuration rule(s) defined during configuration process 300A. In another embodiment, client device 104 may obtain account information from system 140 (e.g., account balance information, usage data, etc.). Based on the account information, client 104 may perform an account status notification process (e.g., step 320B) and generate or update account status indicator(s) (e.g., step 330B) for presentation by client device 104 (e.g., step 340B).

FIG. 3C shows a flowchart of an exemplary process flow consistent with disclosed embodiments. The process flow of FIG. 3C shows exemplary operations and exemplary relationships between operations that may be performed by system 140 and a client device (e.g., client device 104). The disclosed embodiments are not limited to the exemplary operations and the relationships shown in FIG. 3C. Further, one or more of the operations and/or one or more relationships between the operations shown in FIG. 3C may be optional, not implemented, or performed in a different process relationship than that illustrated in FIG. 3C. For example, where client device 104 may be configured to generate or update account status indicators, or determine the status of one or more account parameters, system 140 may not be required to perform those operations for selected accounts. Further, in configurations where system 140 generates and provides account status indicator(s) to client device 104, the same operations may not be performed by client device 104.

FIG. 3D illustrates a flowchart of another exemplary process 300D for providing one or more generated or updated (from a previously generated) account status indicators for presentation by client device 104 consistent with disclosed embodiments. Exemplary method 300D may provide the functionality enabling client device 104 or server 142 of system 140 to generate or update an account status indicator for presentation by user device 104. In some aspects, system 140 may be configured to execute software instructions to obtain balance data associated with one or more accounts associated with user 110 (step 310D). System 140 may obtain the balance data from server 142, data repository 144, client device 104, or another system. As previously discussed, balance data may include customer data 144A, account data 144B, transaction data 144C, or any combination thereof. In another embodiment, client device 104 may be configured to obtain the balance data associated with one or more accounts associated with user 110.

System 140 may also be configured to calculate an account balance for one or more accounts associated with user 110 (step 320D). For example, system 140 may determine the account balances for a set of accounts that have been selected by user 110 during a configuration process (e.g., process 300A). System 140 may be configured to execute software instructions for calculating the account balance for certain accounts using the obtained balance data. In one embodiment, system 140 may select one or more portions of the balance data to compute an account balance for the associated one or more accounts. The disclosed embodiments are not limited to the portions of balance data



15

used to calculate the account balance, nor are they limited in kind or number to the accounts that system 140 may process to determine account balance(s).

In certain embodiments, system 140 or client device 104 may calculate account balances for associated accounts using one or more factors. For exemplary purposes only, the present disclosure may refer to these types of account balances as effective account balances. Examples of effective account balances include account balances that may be calculated based on one or more past, present, predicted, predefined, or potential conditions. For example, in some embodiments, an effective account balance may consist of the actual balance of an account. In other embodiments, the effective account balance may use the actual account balance in conjunction with estimated expenses, payments, or potential purchases. In other aspects, the effective account balance may not use the actual account balance at all, and may instead use some combination of the above conditions consistent with the disclosed embodiments.

System 140 may be configured to determine whether to send an account status indicator to client device 104. As previously discussed, in certain embodiments, the account status indicator may reflect a status of one or more accounts associated with one or more users (e.g., user 110). In some embodiments, system 140 may determine whether to send the indicator to client device 104 based on whether a status of one or more account parameters of one or more accounts associated with one or more account status indicators has changed (step 330D). In some aspects, an existing account status indicator may change based on received the received balance data from step 310, one or more effective account balance(s) that may be calculated in step 320, or both. By way of example, system 140 may determine the account status indicator for a particular account has changed when the funds (or other type of account element) available in an account fall below, exceeds, and/or equal to below one or more threshold values (e.g., \$200) or is within a range of threshold value(s) (e.g., \$200 to \$400).

If system 140 determines that the status for the account status indicator status has changed for one or more indicators, system 140 may be configured to send an updated indicator to client device 104 (step 340D). System 140 may be configured to execute software instructions for sending the updated account status indicator to device 104 based on whether the indicator status of one of the indicators has changed (e.g., step 330D). In other embodiments, as discussed above, system 140 may generate and provide account status notification information (e.g., account balance information, etc.) that client device 104 may use to generate or update the account status indicator for the associated account(s).

In other embodiments, system 140 may be configured to receive balance data (step 310D), compute one or more effective account balances (step 320D), determine whether the generate an updated account status indicator based on the effective account balance(s) (step 330D) and send the updated account status indicator to client device 104 (step 350D). In certain aspects, the disclosed embodiments allow client device 104 (or other system or device that receives the account status indicator) to automatically present the generated or updated account status indicator without any input from user 110, such as, for example, logging into an account and checking an account balance or other account parameter for the associated account.

In certain aspects, client device 104 may be configured to obtain the updated indicator from system 140 without any input from a user. For example, system 140 may push the

16

account status indicator to client device 104 without a user request to obtain account information, status information, etc. Further, as mentioned, client device 104 may be configured to generate and/or update account status indicator(s) for one or more accounts associated with user 110. In one aspect, based on the updated account status indicator obtained from system 140, client device 104 may present the updated account status indicator (step 350D). Client device 104 may present the account status indicator visually or audibly depending on the configuration of the account status indicator defined during the configuration process 300A. Alternatively, system 140 may configure account status indicators using default indicators (graphical or audio).

FIG. 4 depicts an exemplary client device 104 consistent with certain disclosed embodiments. In one embodiment, client device 104 may be a smartphone with a display device having touchscreen capabilities via viewing pane 406. Client device 104 may be any type of computing device, however, and the representation of FIG. 4 is for exemplary purposes only. In the exemplary FIG. 4, client device 104 may include one or more viewing panes 406 that display on an interface one or more graphical representations, such as icon 402. In some aspects, icon 402 may comprise only a portion of the viewing pane 406 of client device 104 (e.g., as depicted in FIG. 4). In other embodiments, icon 402 may comprise the entire viewing pane 406 of client device 104. In yet other embodiments, icon 402 may comprise no portion of the viewing pane 406. Similarly, viewing panes 406 may constitute none, some, or all of one or more surfaces of client device 104.

In some embodiments, icon 402 may include one or more account status indicators 404 associated with one or more accounts. In other embodiments, icon 402 may represent an account status indicator. The number and type of indicators displayed within icon 402 may vary based on the configuration of the status notification aspects for one or more associated accounts, and/or based on the status of one or more account parameters that are monitored for status notifications. As described in exemplary embodiments below, for example, a user may configure the status notification for one or more accounts such that an account status indicator(s) is presented that alerts a change in one or more account parameters associated with the one or more accounts. As explained, the alert provided by the account status indicator may take the form of a tactile mechanism (e.g., a vibrate feature) or audio mechanism (e.g., music or sounds), in which case a pictorial representation of the indicator may be unnecessary. In other embodiments, icon 402 may graphically depict one or more account status indicators 404 depending on the status of the one or more account parameters for the one or more associated accounts. For instance, account status indicator 404 may change based on balance data or effective account balances of one or more associated accounts.

FIGS. 5A-5F illustrate exemplary graphical indicators and/or account status indicators. In accordance with certain embodiments, the manner, timing, and appearance of an account status indicator may depend in part on, for instance, the status of one or more account parameters associated with one or more associated accounts, indicator type, notification rule(s), etc. For example, FIG. 5A shows an exemplary icon including multiple account status indicators 502, 504 taking the form of colored status bars (e.g., status bar indicators). In certain aspects, account status indicators 502, 504 may be associated with the status of a respective account parameter of a single account. For instance, indicator 502 may reflect the status of an account balance and indicator 504 may



reflect the status of a credit limit of the account. In other instances, indicator **502** may reflect a status of a balance of points available to user **110** through a corresponding loyalty program, and indicator **504** may reflect a number of points required for user **110** to obtain a reward associated with the corresponding loyalty program.

In other aspects, account status indicator **502** may reflect an account parameter of a first account and account status indicator **504** may reflect an account parameter of a second account. The first and second accounts may be associated with a single user (e.g., user **110**), or the first account may be associated with a first user and the second account may be associated with different users. Further, the account parameter that is associated with the status reflected in the first and second account indicators may be the same account parameter (e.g., account balance or points balance), of the account parameter associated with status indicator **502** may be a different account parameter than the account parameter associated with status indicator **504**. The disclosed embodiments may include more than two account status indicators each relating to account parameter(s) of a single or separate accounts. The disclosed embodiments may allow a user to configure the number, format, and associations of account status indicators in the configuration process **300A**.

In certain embodiments, the properties of each account status indicator **502**, **504** may change according to the status of the one or more account parameters associated with the indicators. In other aspects, the properties of each account status indicator **502**, **504** may change according to the status of an effective account balance associated with the one or more accounts relating to the indicators. In one embodiment, the properties of a bar indicator may vary with respect to its indicator status derived from an indicator rubric incorporating one or more effective account balances. System **140** or client device **104** may be configured to execute software instructions that perform processes that enable user **110** to establish one or more rules comprising the indicator rubric governing the indicator status, such as during configuration process **300A**. In some embodiments, the exemplary status bar indicators **502**, **504** may change size (e.g., width, length, height, etc.), color (e.g., green, red, etc.), fill effects (e.g., solid, striped, dotted), and/or transparency (e.g., alpha) based on an indicator status derived from an underlying indicator rubric. For example, user **110** may wish to set up a bar indicator associated with a single account such that the bar appears red when the effective account balance of the account falls below a defined threshold. In this example, the user may further define the indicator rubric to color the bar indicator green when the effective account balance exceeds the threshold, turn yellow when the balance is within a certain range of the threshold, incorporate both effects, and the like.

The disclosed embodiments allow for different account status indicator formats, types, size, and color schemes that will be readily apparent to those skilled in the art. For instance, the disclosed embodiments may configure an account status bar indicator such that a color gradient is continuous instead of discrete (e.g., the entire visual spectrum between two defined points). Additionally or alternatively, the exemplary bar indicators **502**, **504** may elongate or contract (e.g., a small or “empty” bar for low effective account balances and a long or “full” bar for high balances) depending on the underlying rubric (e.g., bar **502**). The exemplary bar indicators **502**, **504** may also be configured to span horizontally or vertically. Moreover, system **140** may provide processes that enable user **110** to configure the status notification such that multiple bar indicators appear in

parallel or in series, such that, for instance, a single bar includes two bar indicators, each associated with their own accounts.

FIG. **5B** illustrates another exemplary account status indicator consistent with disclosed embodiments. In FIG. **5B**, the exemplary account status indicator may be in the form of a pie chart (“pie indicator”) whose properties may vary according to one or more associated notification rules, indicator rubrics, and/or statuses of one or more account parameters of one or more associated accounts. As discussed in reference to FIG. **5A**, user **110** may establish one or more notification rules comprising the indicator rubrics governing the presentment of the exemplary account status indicator. In some embodiments, a pie indicator, or a portion of the pie indicator, may change color (e.g., green, red), fill effects (e.g., solid, striped, dotted), relative size, and/or transparency (e.g., alpha) based on the status of one or more account parameters, such as, for example, an account balance, a balance of points available through a loyalty program, an effective balance of the accounts, an effective balance of a loyalty program account (e.g., an effect of a potential purchase of a product on the loyalty program account), relative size of the included indicators. The indicator may be colored, filled, sized, and shaded in any of the manners previously described.

Taking FIG. **5B** as an example, during the configuration process **300A**, a system **140** may perform processes that enable user **110** to define three account status indicators in a pie indicator arrangement, where each portion of the pie indicator arrangement is associated with a single account, or each portion may be associated with a separate account, or two portions may be associated with a single account and the third associated with a different account. In the example shown in FIG. **5B**, the user may have defined each status indicator to comprise equal areas of the pie indicator, although the user need not define the pie indicator in this way. In this example, the user may elect to color or shade each of the account status indicators included in the pie status indicator based on preferences, notification rules, rubrics, etc. that take into account one or more account parameters (e.g., effective account balances). As shown in FIG. **5B**, for example, each account status indicator **506**, **507**, **508** in the pie indicator may have its own coloring and/or shading scheme that may change based on a status of one or more accounts associated with a respective account status indicator. In addition, in one aspect, the pie indicator may be included in an icon.

FIG. **5C** illustrates another exemplary account status indicator icon consistent with certain embodiments. In this embodiment, the account status indicator may be included in an icon such that it encompasses the entire or a portion of the background of the icon (e.g., background indicator). In some embodiments, the color, fill effects, and/or transparency of the background indicator may vary according to the status of one or more parameters associated with an account relating to the indicator. In certain aspects, system **140** may be configured to allow user **112** to select the color of the background indicator (e.g., red, green, etc.) to be used when a notification status is to be provided based on a status of one or more parameters of the associated account(s), such as an effective balance, balance data, loyalty program data, current or remaining usage data, etc.

FIG. **5D** illustrates another exemplary embodiment of an account status indicator consistent with certain embodiments. The disclosed embodiments may provide an account status indicator in the form of a picture (picture indicator), symbol (symbol indicator), or glyph (glyph indicator). FIG.



5D shows an example of a glyph indicator. In certain aspects, properties of the glyph indicator (e.g., colors, animation, size, shape, type, etc.) may change according to one or more account parameters of one or more associated accounts, such as effective account balances. In some embodiments, the glyph indicator may change between indicator types. This feature is not unique to glyph indicators as the disclosed embodiments may allow any type of account status indicator to be replaced with a second type of account status indicator as a way of reflecting a status of one or more account parameters of one or more accounts (e.g., switch from status bar indicator to background indicator when the status of an account parameter triggers a notification). For example, a glyph indicator image (e.g., check mark, large “X,” happy face, cloud, thunderbolt, thumbs up, fuel gauge ticker, stop sign, etc.) or its properties (e.g., size, shape, color, transparency, orientation, position, animation, etc.) may change based on, for example, one or more notification rules and/or account status notification information. For example, user 110 may define a glyph indicator in such a way as to display a green check mark when an associated effective account balance of a monitored account exceeds or equals a threshold value (e.g., a threshold balance of a checking or savings account, or a threshold balance of points associated with a loyalty program) and display a red “X” when the effective account balance fall below the threshold value.

FIG. 5E shows an exemplary account status indicator consistent with disclosed embodiments. The indicator of FIG. 5E may be colored text (e.g., text indicator) that may change based on the status of one or more parameters associated with one or more accounts. A text indicator can include a single line of text that is associated with one account, or a text indicator may include multiple account status indicators in the form of lines of text that each are associated with one or more different parameters of a single account, or associated with one or more different accounts. For example, in one aspect, each line of text of the text indicator of FIG. 5E may reflect an account status indicator associated with one or more accounts, each with their own account parameters, such as effective account balances. One or more properties of the text may change according to, for example, the effective account balances of the associated accounts, which may be defined by one or more notification rules. In some embodiments, the text may change its font, size, capitalization (e.g., all caps, small caps), style (e.g., bold, underline, italic, etc.), color, transparency, or accompanying glyph as governed by the notification rules, which may be configured by a user during configuration process 300A.

While the foregoing discussion describes account status indicators as visual indicators, the disclosed embodiments may also implement other types of indicators that may consist of nonvisual cues such as musical tones, songs, vibration, or other non-pictorial elements. The disclosed embodiments may allow client device 104, for example, to present such indicators based on the same criteria set forth for visual indicators (e.g., notification rules, status of account parameter(s), etc.). In certain aspects, nonvisual indicators may be presented with visual indicators. For example, FIG. 5F illustrates a visual indicator displaying a musical note in an icon. The note may indicate, for instance, the indicator is set to present certain nonvisual tones or music based on statuses of account parameters. When a nonvisual indicator is presented, client device 104 may be configured to present a visual indicator at the same time to provide multiple mechanisms to notify a user of a change in

status of one or more account parameters for one or more accounts. In some embodiments, client device 104 may not display any indication of a nonvisual indicator at all. For example, a nonvisual indicator may alert user 110 of a changed indicator status by playing a tone, playing a certain song, playing different tones of different lengths, vibrating in different durations and amplitudes, and the like.

Moreover, while the foregoing discussion described the various indicator forms separately, the present disclosure also contemplates combining any number of indicator types together (e.g., the glyph and text indicators of FIG. 5E). For example, a user could establish a bar indicator, pie indicator, background indicator, glyph indicator, and text indicator simultaneously. In such embodiments, one or more of the account status indicators may correspond to one or more accounts.

Returning to FIG. 4, user 110 may interact with icon 402 in response to, for example, the account status indicator 404. In some embodiments, if account status indicator 404 reflects a particular account status (e.g., a red bar for a bar indicator), the user may interact with icon 402 to obtain additional information and initiate additional follow-on processing. For example, user 110 may notice a bar indicator 404 is red, and such indication may signify that an effective account balance for one or more associated accounts have fallen below a defined threshold as disclosed herein. In certain embodiments, the user may then interact with the icon to perform a variety of functions, such as opening a new account, extending an account balance, viewing account transaction history, or accessing and participating in a configuration process to define or change properties, rules, and associations of accounts with indicators, etc. (such as the configuration process 300A). It should be appreciated that user 110 may interact with icon 402 for any reason, and need not be motivated by a particular account status indicator 404.

For example, client device 104 may perform follow-on processes in response to the user’s selection of the notification icon requesting input from the user. In some embodiments, these requests may arise via interface(s) allowing the user to assign an account status indicator to one or more accounts, change an underlying indicator rubric, change rules that affect the balance calculation method for associated accounts, and any other such variable change consistent with the disclosed embodiments. This may allow user 110 to view, inspect, change, or cancel one or more parameters, or value derived from one or more parameters (e.g., an indicator rubric), in real-time using client device 104. For example, a user may physically press icon 402 to view transaction history associated with one or more accounts, change an indicator rubric to extend an account balance, change an indicator type or status, or affect any value derived from one or more account parameters. In some embodiments, such follow-on processing may be performed by client device 104, or a server 142 associated with system 140, or both.

The disclosed embodiments allow one or more users to be associated with one or more accounts. Further, the disclosed embodiments allow one or more accounts to be associated with one or more account status indicators. The one or more account status indicators may correspond to one or more account parameters (e.g., an effective account balance) of its one or more corresponding accounts. The one or more account status indicators may also be associated with one or more indicator rubrics, which in one example may define an indicator status based on the effective account balances of the associated accounts. In certain embodiments, the effec-



tive account balances of the associated accounts may relate to past, present, predicted, predefined, and potential transactions.

Furthermore, the disclosed embodiments are not limited to displayable icons (e.g., icon **402** of FIG. **4**) that incorporate one or more status indicators within corresponding icon boundaries (e.g., account status indicators **502** and **504** of FIG. **5A** and/or account status indicators **506**, **508**, and **510** of FIG. **5B**). In additional embodiments, client device **104** may execute software processes to present, to a user (e.g., through viewing pane **406** of FIG. **4**), an icon surrounded by one or more account status indicators that reflect statuses of account parameters associated with one or more accounts. For example, FIG. **5G** illustrates an exemplary account status indicator **512** in the form of a “ring” indicator that surrounds an outer boundary of an icon **402**, and FIG. **5H** illustrates exemplary account status indicator **514**, **516**, and **518** that collectively establish concentric ring indicators surrounding the outer boundary of icon **402**. In certain aspects, and as described above in reference to account status bar **502** of FIG. **5A**, account status indicators **512**, **514**, **516**, and/or **518** may reflect the status of an account parameter of a single account, or may reflect statuses of account parameters of multiple accounts (e.g., a total balance, total credit limit, etc., of multiple accounts held by user **110**).

By way of example, account status indicators **512**, **514**, **516**, and/or **518** may reflect the status of an account balance of a checking account held by user **110**, a credit limit of a credit account held by user **110** (e.g., a Visa™ card issued by a financial institution associated with business entity **160**), a balance of accrued points associated with a loyalty program in which user **110** participates (e.g., a loyalty program sponsored by a merchant), and/or a number of loyalty points remaining until user **110** qualifies for a benefit or reward provided by the loyalty program. Further, as described above, client device **104** may be configured to modify one or more visual characteristics of account status indicator **512**, **514**, **516**, and **518** to indicate a change in the status of the account parameter(s) associated with the indicators (e.g., an actual or effective balance of a checking, credit, and/or loyalty program account). In some instances, the visual properties of account status indicator **512**, **514**, **516**, and **518** may vary with respect to its indicator status derived from an indicator rubric incorporating one or more of the actual or effective account balances (e.g., as established by user **110** using the exemplary processes described above). In some embodiments, the exemplary status indicators **512**, **514**, **516**, and/or **518** may change size (e.g., width, length, height, etc.), color (e.g., green, red, etc.), fill effects (e.g., solid, striped, dotted), and/or transparency (e.g., alpha) based on a change in an indicator status derived from an underlying indicator rubric.

In some aspects, user **110** may, through a graphical user interface (GUI) presented by client device **104**, associate account status indicator **514** with an effective balance of a checking account, account status indicator **516** with an effective balance of a credit card account, and further, associate account status indicator **518** with an effective balance of a loyalty program account. In some instances, user **110** may establish threshold balances for each of the checking, credit card, and loyalty programs accounts, and may establish notification rules that instruct client device **104** (and/or system **140**) to color account status indicators **514**, **516**, and/or **518** green when a corresponding one of the effective account balances exceeds the corresponding

threshold balance, and red when the corresponding effective balance falls below the threshold balance.

Although described in terms of one or three status indicators, the disclosed embodiments may enable user **110** to establish, through a corresponding GUI, notification rules that configure client device **104** to present any additional or alternate number of account status indicators linked to corresponding account parameters of accounts held by user **110**. In certain aspects, through the GUI, user **110** may add or remove “layers” of concentric account indicators to produce customized notification rules that enable user **110** to make informed decisions regarding potential purchases based on impacts of the potential purchase on various aspects of user **110**’s current financial situation.

FIG. **6** depicts an exemplary relationship arrangement **600** regarding an exemplary account status indicator implementation, consistent with disclosed embodiments. In one example, system **140** may be configured to obtain balance data **606** comprising all or a portion of customer data **144A**, account data **144B**, and/or transaction data **144C** for one or more accounts **620** that may be associated with user **110**. Balance data **606** may include information relating to an account batch **610**, comprising one or more user accounts **620** (signified through phantom lines for a second transaction account **620** in FIG. **6**). The one or more accounts may be associated with one or more account status indicators **404** that may be configured and operate in a manner consistent with the disclosed embodiments. While FIG. **6** depicts at two accounts **620** and indicators **404**, the disclosed embodiments are not limited to these configurations. Indeed, the disclosed embodiments may be configured to allow user **110** to be associated with any number of accounts **620** that may relate to other users, and those accounts may be associated with any number of indicators **404**.

In the exemplary arrangement **600**, account **620** may associate with information contained in balance data **606**. In some embodiments, account **620** may include account balance data **626**. Account balance data **626** may include any subset of customer data **144A**, account data **144B**, and transaction data **144C** (e.g., balance data **606**) related to a particular account **620**. The account balance data **626** may vary according to the type of associated account. For example, for a particular account **620**, account balance data **626** may include information signifying the type of account (e.g., checking, savings, credit card, securities account, college meal plan, store credit, loyalty program, or any such account previously discussed), data associated with the account (e.g., current balance, pending transactions, transaction history, other historical data, account number, routing number, card number, expiration date, etc.), data associated with the owner or accessor of the account (e.g., login information, security measures, etc.), and/or transaction data related to potential purchases as explained below.

Account **620** may also associate with one or more rules that may relate how to calculate an effective account balance for the account (e.g., balance calculation method **624** in FIG. **6**). System **140** may perform process that generate and apply the rules and comprising balance calculation method **624**. In one aspect, system **140** may provide interfaces over network **120** to client device **104** to allow user **110** to define one or more of these rules. Alternatively, client device **104** may perform such processes.

In some embodiments, balance calculation method **624** may include software instructions that when executed by a processor perform balance calculation processes consistent with the disclosed embodiments. In one example, balance calculation method **624** may comprise a straight balance



determination. In such embodiments, the effective account balance may reflect a current available balance for account **620**. In other embodiments, balance calculation method **624** may provide effective balances, such as predictive and intelligent balances that are determined through predictive and intelligent balance calculation processes.

For example, in some embodiments, balance calculation method **624** may include software-based processes that when performed obtains and analyzes information relating to scheduled future expenses of user **110**, (e.g., an upcoming trip, a wedding, a future purchase of a good or service such as a car, etc.), periodic expenses of user **110** (e.g., a mortgage, average weekly grocery bills, average monthly utility costs, annual insurance premiums, rent, etc.), future or periodic wages or other payments relating to user **110** (e.g., a salary, a bonus, average periodic pay for hourly workers, annuity payments, etc.), and/or potential purchases of user **110**. This information may be obtained directly from the user **110** via client device **104**, through software processes executed on server **142** associated with system **140**, or both. In some embodiments, for example, a user may input this information directly through processing systems associated with client device **104**. Client device **104** or system **140** may then store the user's information consistent with the disclosed embodiments. Additionally or alternatively, system **140** may be configured to obtain information associated with an account for user **110** without input from the user. In some aspects, system **140** may be configured to obtain this information for an account it itself provides, an account provided by another system, or the like. System **140** may also be configured to send instructions to client device **104** designed to query user **110** for such information without prior affirmative input from the user.

In some aspects, for example, user **110** may associate with a checking account associated with system **140** for business entity **160** (e.g., a financial institution). System **140** of business entity **160** may be configured to analyze the purchasing habits of user **110** over a period of time (e.g., a flat duration, weekly, monthly, user-defined, etc.). The system **140** may analyze a variety of aspects of the user's spending habits including the expenditures' source (e.g., by merchant), type (e.g., by product or kind of expense, e.g., groceries, rent, mortgage, etc.), amount, location, or similar characteristic. Based on the results of its analysis, system **140** may be further configured to calculate a user's expected expenses resulting from certain sources, certain expenditure types, certain geographical locations, or all sources combined. In this example, for instance, system **140** may calculate a user's monthly expenditures on groceries for which user **110** uses the checking account associated with financial institution **160**. User **110** may then use the value of these calculated expenses as she defines her balance calculation method **624**. In other embodiments, processes running on client device **104** may be configured to calculate these expenses. Additionally or alternatively, user **110** may provide the information directly to client device **104** without the need of background processing.

As an illustrative example of some aspects of the disclosed embodiments, user **110** may specify she wishes to calculate an effective account balance for account **620** incorporating both her mortgage payment and salary information in addition to the current account balance. In such an example, the effective account balance for user **110** may reflect the existing actual balance of an associated account and a future account balance after certain determined periodic (e.g., weekly, monthly, semimonthly, etc.) expenses and wages. For instance, system **140** may perform processes that

obtain transaction information associated with associated account(s) for user **110** to determine one or more expenses that may be configured for automatic payment (e.g., configured bill pay mechanisms in online banking portals). As another example, system **140** may analyze historical transaction data for the associated account(s) to identify periodic expenses (e.g., similar payments made to a mortgage lender entity, utility payments, etc.) and determine an average monthly expense that applies to an associated account for user **112**. Based on the determined expenses, system **140** may calculate an effective balance for the account by subtracting the determined expenses from the actual balance. The disclosed embodiments may allow the account status indicator(s) for the account to reflect a status of the calculated effective balance, thus providing user **112** with a status of the account that takes into consideration known expenses to be withdrawn from the account. In one embodiment, a status indicator may simultaneously show the status of an actual balance and effective balance of an account, through for example, a status bar indicator.

The disclosed embodiments may be configured to enable user **110** or system **140** to specify one or more notification rules that may direct the disclosed processes to determine statuses of one or more account parameters (e.g., actual and/or effective balances, etc.), not limited in kind, amount, and/or periodicity. The disclosed embodiments may allow the configuration of such rules to occur automatically (e.g., as a default background process performed by system **140** (e.g., during configuration process **300A**)), manually (e.g., user **110** inputs the configuration input information), or some combination thereof. Thus, as explained, for example, system **140** may be configured to determine the average periodic expenses for user **110** given the user's historical expense information (e.g., a mortgage, grocery bills, utility bills, etc). In one embodiment, system **140** may do so regardless of whether historical expenses are periodic (e.g., a user may not purchase groceries in a particular week). In one embodiment, user **110** may have control through configuration process **300A** what kind of predictive purchases and payments may be considered for performing a balance calculation method **626** (e.g., user **110** could override results from a balance calculation process performed by system **140**).

In certain embodiments, the status notification aspects of the disclosed embodiments may provide account status notifications based on potential transactions (e.g., potential purchase transactions by user **110** that may affect an account balance). In one embodiment, for example, balance calculation method **624** may determine an effective balance (e.g., **620**) based on information relating to one or more potential transactions. In one aspect, this information may subsist in some portion of account balance data **626** that may be derived from balance data **606**, which in turn may be derived from transaction data **144C**. In one embodiment, client device **104** may be configured to communicate transaction data **1440** to system **140** in contemplation of potential transactions. Such communication may occur over any communications network (e.g., communications network **120** of FIG. 1). Contemplated potential transactions may include any kind of transaction previously discussed in relation to transaction data **144C** including, but not limited to, potential purchases, fund transfers, bill payments, security transactions, and so on.

In some embodiments, client device **104** may be configured to receive, track, and transmit transaction data **144C** to system **140** via any network previously discussed. In some embodiments, for example, client device **104** may be con-



figured to scan a bar code for one or more particular goods at a physical retailer and relay the relevant information (e.g., location, cost of the goods, accounts affected, etc.) to system 140. In these embodiments, client device 104 may be configured to obtain such transaction data using any method known to those skilled in the art (e.g., NFCs, optical scanners, Bluetooth communications, etc.). In another embodiment, a user may instead input such information directly into client device 104 without the use of a scanner or code reader.

Moreover, client device 104 may be configured to assimilate and aggregate several potential transactions together, even transactions affecting different accounts 620. For example, user 110 may aggregate multiple potential purchase transactions affecting a first account with a funds transfer for a second account to determine the effect, if any, on the effective balances on those accounts as well as their effects on one or more associated account status indicators 404. The disclosed embodiments may be configured to allow user 110 to incorporate any number of potential transactions associated with any number of accounts. Such transactions, if any, may adjust the calculated effective account balance for one or more accounts 620, which may in turn change the indicator status 644 of associated indicators 620.

FIG. 6 also illustrates how one or more accounts 620 may be associated with one or more account status indicators 404 (e.g., a first account relates to two different indicators). Similarly, an account status indicator 404 may associate with one or more accounts 620 (e.g., the second indicator relates to two accounts). An account status indicator 404 may further associate with one or more properties. In one example, indicator 404 may include an indicator type property 642. Indicator type 642 may include information signifying the form of the indicator when presented by client device 104, such as a bar indicator, a glyph indicator, or any combination of pictorial and non-visual indicator types, such as those described in relation to FIGS. 5A-5F. Indicator type 642 may also include properties signifying how client device 104 presents the indicator 404 on client device 104 (e.g., the color of a bar indicator, the length of a vibration, a kind of music played, the pictures of a glyph indicator, the fill of a pie indicator, or any other configuration that may be assigned consistent with disclosed embodiments).

Indicator 404 may also include indicator status property 644. In one aspect, indicator status 644 may include information signifying a present status of an indicator 404. Indicator status information 644 may depend in part on the indicator type 642, underlying indicator rubric 646, effective account balances of related account(s) 624, other balance data 626, or other account data. For example, given an indicator rubric 646 consistent with disclosed embodiments, an indicator status may signify a bar indicator is colored green, a glyph indicator is a red "X," or any other such indicator status described in connection with FIGS. 5A-5F.

An account status indicator 404 may include an indicator rubric property 646. In one embodiment, an indicator rubric 646 may include information that defines a set of logical rules promulgating how to generate an indicator status 644 for a particular indicator type 642 given one or more account parameters, such as the effective account balance and/or balance data for account(s) 620 associated with indicator 404. The logical rules associated with indicator rubric 646 may be configured and applied automatically by system 140 when performing status notification processes consistent with the disclosed embodiments. The logical rules may be configured manually from user 110 during a configuration process (e.g., configuration process 300A). By way of

example, one exemplary indicator rubric may, when processed by system 140 and/or client device 104, determine to set the color of a bar indicator to "green" when an effective account balance of an associated account exceeds or is equal to a threshold value. In another example, an indicator rubric may, when processed by system 140 and/or client device 104, change a glyph associated with a glyph indicator to another format (e.g., a storm cloud image) if the sum of the effective account balances for all associated accounts drops below a threshold value, which may result from considerations of monthly expenses, income, and/or potential purchases associated with the account.

Consistent with the disclosed embodiments, rubric indicator 646 may provide a hierarchy of rules providing for multiple possible outcomes (e.g., multiple coloring schemes, several pictures, etc.). Furthermore, while embodiments of indicator rubric 646 may employ some aspect of the effective account balance for associated accounts, certain embodiments of the present disclosure may eschew the effective account balance entirely, generating an account status indicator from balance data (e.g., potential transactions, monthly expenses in relation to income, etc.).

Indicator 404 may also include an indicator refresh rate property 648, which may include information that is used to determine how often system 140 and/or client device 104 updates an account status indicator 404. Indicator refresh rate property 648 may be configured and applied automatically by system 140 when performing status notification processes consistent with the disclosed embodiments. In another example, indicator refresh rate property 648 may be configured manually from user 110 during a configuration process (e.g., configuration process 300A). In some embodiments, indicator refresh rate may depend on a certain amount of time (e.g., every ten minutes), a certain number of transactions or item purchases (e.g., after the user purchases five items), a certain amount of money spend (e.g., every \$1,000, all purchases over \$3,000, etc.), and the like. For example, user 110 may specify she wishes the notification processes consistent with the disclosed embodiments to check for an updated indicator status 644 every five minutes.

FIG. 7 illustrates a block diagram of exemplary data structures and relationships consistent with the disclosed embodiments. FIG. 7 shows an example of various aspects of how indicator rubrics 646 may generate indicator statuses 644 for indicators 404 associated with several accounts 620. FIG. 7 depicts an exemplary user associated with three accounts (e.g., a saving account, a checking account, and a student meal plan), each having their own balance calculation method 624. For example, in FIG. 7, the user may have elected to use the current balance of her savings account for that account's parameter (e.g., actual account balance). The balance calculation method 624 for the user's checking account and meal plans, however, may relate to other account parameters, such as expenditures that provide an effective account balance parameter. The effective balance for the checking account further contemplates expected monthly income.

Consistent with these exemplary settings, system 140 may determine that the account balance 626 for the savings account is \$20,000 (e.g., the current balance). Similarly, system 140 may determine the effective account balance for the checking account is \$9,800 (e.g., \$10,000 current balance + \$5,000 income - \$3,000 average expenses - \$2,200 potential purchases). As an example, the disclosed embodiments may obtain information that is used to adjust the parameter status assigned to the accounts for status notification. For example, the student meal plan shown in FIG. 7



assumes there are, for example, two months left in the current semester, although other aspects consistent with the disclosed embodiments may include any other relevant information from account balance data 626. The exemplary configuration of FIG. 7 also assumes the yearly allotment of meal plans for the user is 360 meals (resulting in thirty meals per month). Given a current balance of 100 meals, system 140 may determine that the effective account balance for the meal plan is 40 meals (100 current balance-2 months\*30 meals/month).

In the example associated with FIG. 7, a single indicator 404 (Indicator 1) is associated with the savings account and is a bar indicator (defined via indicator type 642). System 140 and/or client device 104 may be configured to use account status Indicator 1's indicator rubric 646 to determine to set the color of the account status bar indicator to red if the account balance (AB) of the savings account drops below \$5,000. Otherwise, the system colors the bar green. In the illustrated example, user account 1's balance exceeds \$5,000, and thus the disclosed embodiments may set the indicator status 644 of the bar indicator to green.

Further in the exemplary configuration of FIG. 7, Indicator 2 associates with both user account 2 and account 3. In this example, Indicator 2 takes the form of a glyph indicator (indicator type 642). Under Indicator 2's indicator rubric 646, the glyph appears as a red "X" if either (1) the effective account balance of the checking account drops below \$10,000 or (2) the effective account balance of the meal plan drops below ten meals. In this example, while the effective account balance of the meal plan (account 3) exceeds ten meals, the effective account balance for the checking account (account 2) is below \$10,000 due in part to the potential purchases the user desires to make and identified in the "potential transactions" entry. Thus, in this example, system 140 and/or client device 104 may determine based on indicator rubric 646 that the appropriate glyph for indicator 2 comprises a red "X."

The information reflected in arrangement 700 may be obtained and/or determined by system 140 and/or client device 104, or any other computer system that performs processes consistent with the disclosed embodiments. The information, properties, etc. described in connection with arrangement 700 (and variations thereof) may be stored in one or more memories, accessed by one or more processors, and used by the one or more processors to perform processes consistent with the disclosed embodiments. Further, while FIG. 7 includes various exemplary calculations and properties that may be used by the disclosed embodiments to determine the status of an account and the type of relevant account status indicator 644, the disclosed embodiments are not limited to such configurations and relationships. Instead, the disclosed embodiments may implement other relationships and settings for providing account status indicators, may weigh other factors or information, may obtain and use other inputs, different timeframes, and the like.

In some aspects, system 140 may enable user 110 to specify (e.g., through a graphical user interface (GUI) presented by client device 104) threshold balances that facilitate system 140's determination of indicator statuses (e.g., status 644) based on corresponding indicator rubrics (e.g., rubric 644). In other embodiments, system 140 may establish a default threshold balance for accounts associated with one or more of the account status indicators. For instance, a financial institution may require user 110 to maintain a minimum balance in a checking account to avoid transaction fees. In certain aspects, system 140 may establish the required minimum balance as the default threshold balance for the

checking account without requiring input from user 110. In further embodiments, system 140 may enable user 110 to establish a "window" that brackets a user-defined or default threshold balance values for purposes of determining the indicator statuses. For example, through the GUI presented by client device 104, user 110 may specify a threshold balance of \$5,000 for user account 1 of FIG. 7, and may also specify a \$250 window that brackets the threshold balance of \$5,000. System 140 may, in some instances, establish a status of "green" for the bar indicator associated with user account 1 when the balance of user account 2 falls between \$4,750 and \$5,250.

In further aspects, the threshold balance specified by user 110 for a particular account (e.g., through the GUI presented by client device 104) may represent a budget established by the user over a corresponding temporal period (e.g., a week, month, a holiday season, etc.). For instance, user 110 may establish a budget of \$1,000 for charges on a particular credit card account through the GUI presented by client device 104. Using the disclosed embodiments, system 140 and/or client device 104 may determine an indicator status based on a comparison of the recent charges on the credit card account against the establish budget, and may generate and present to user 110 an account indicator consistent with the determined indicator status (e.g., a red bar when spending exceeds the \$1,000 budget or a green bar when spending falls below the \$1,000 budget).

Further, although described in terms of a savings account, a checking account, and a student meal plan held by or associated with user 110, the data structures, relationships, and rubrics of FIG. 7 are not limited to such exemplary types of accounts or number of accounts. In some instances (not illustrated in FIG. 7), accounts 620 may also include a fourth user account associated with loyalty program in which user 110 participates. As described above, user 110 may elect, through a graphical user interface (GUI) presented by client device 104, a current balance of available rewards points as an account parameter associated with the loyalty program account. Based on user 110's input through the GUI, system 140 may establish a balance calculation method (e.g., method 624) for the loyalty program account that accounts for a potential and recurring transaction (e.g., potential transaction 626) in which user 110 may exchange 1,000 loyalty points to obtain access to a streaming content service (e.g., Netflix™, etc.). System 140 may further establish, based on user 110's input through the GUI, that user 110's loyalty program account accrues an average of 1,500 points each month (e.g., income 626) based on purchase transactions at participating retailers.

Furthermore, and as described above, system 140 may determine that user 110's loyalty program account is associated with a current balance (e.g., balance 626) of 3,325 points, and may compute an effective account balance for user 110's loyalty program account of 3,385 points. In certain aspects, user 110 may, through the GUI, associate the loyalty program account to an existing indicator (e.g., "Indicator 2" of FIG. 7), and establish an rubric (e.g., indicator rubric 646) specifying that the glyph appears as a red "X" if either (1) the effective account balance of the checking account drops below \$10,000, (2) the effective account balance of the meal plan drops below ten meals, or (3) the effective account balance of the loyalty program account falls below 1,000 points. User 110's linkage of the threshold loyalty point balance of 1,000 points to Indicator 2 may, in some instances, ensure that user 110's checking account includes funds sufficient to complete the monthly transaction for the streaming content service in the event that the loyalty



program account balance is insufficient to complete the transaction. The disclosed embodiments are, however, not limited to such exemplary links and associations, and in other embodiments, user **110** may associate the balance of the loyalty program account (or any other parameters describing the loyalty program account) with user indicator **1** or to any other existing indicator linked to other accounts **620**. Further, in other aspects, user **110** may associate the balance of the loyalty program account to a new indicator and establish a corresponding indicator rubric.

In certain exemplary embodiments, client device **104** may be configured to present icons that include multiple account status indicators associated with parameters of corresponding accounts. For example, client device **104** may be configured to present, to user **110**, a first account status indicator **502** reflective of an account parameter of a first account and a second account status indicator **504** may reflect an account parameter of a second account within an icon (e.g., icon **402** of FIG. 4). In some aspects, client device **104** may be configured to present account status indicators **502** and **504** automatically without receiving input from user **110** requesting presentation of account status indicators **502** and **504**.

In further embodiments, system **140** and/or client device **104** may be configured to automatically generate, present, and/or modify one or more of account status indicators **502** and **504** based on a current or prior geographic position of user **110**. For instance, and as described above, account status indicators **502** and **504** may be associated logical rules (e.g., notification rules) that establish a correspondence between presentation statuses of account status indicators **502** and **504** (e.g., a type of indicator, visual, tactile, and/or audible characteristics of the indicator type, etc.) and one or more account parameters. In other aspects, the notification rules may also specify particular geographic regions or locations associated with account status indicators **502** and **504**, and further, may establish the presentation statuses of account status indicators **502** and **504** based on a current or prior geographic position of user **110**. The notification rules may also establish a link between the current or prior geographic position of user **110** and a generation, presentation, and/or modification of account status indicators **502** and **504** by client device **104** and/or system **140**.

For example, account status indicator **502** may reflect an actual or effective account balance of a checking account held by user **110**. In some instances, a notification rule associated account status indicator **502** may associate account status indicator **502** with geographic regions that include a shopping mall and other clusters of retail outlets regularly patronized by user **110**. The indicator rubric may also stipulate that client device **104** presents account status indicator **502** to user **110** when a current geographic position of client device **104** falls within the associated geographic regions or within a threshold distance of the associated geographic regions.

Further, by way of example, account status indicator **504** may reflect an effective balance of a transportation credit account that enables user **110** to access modes of public transportation (e.g., bus, subway, train, etc.). In certain aspects, a notification rule for account status indicator **504** may associate account status indicator **504** with geographic regions that include a train station, subway station, bus station, or other predetermined geographic locations at which user **110** may access public transportation. As described above, the notification rule may specify that client device **104** presents account status indicator **504** to user **110** when a current geographic position of user **110** falls within or within a threshold distance of the associated geographic

regions or locations (e.g., client device **104** is disposed within subway station, or within 100 meters of the subway station).

In other embodiments, a device of a proximity system (e.g., an iBeacon™ device) may be disposed within or near a train station, subway station, bus station, and/or an individual mode of public transportation (e.g., at a point-of-sale (POS) terminal on a bus). Client device **104** may be configured to detect the proximity detection device, and in some aspects, the notification rule for account status indicator **504** may specify that client device **104** presents account status indicator **504** to user **110** in response to the detected proximity system device.

In some instances, system **140** may determine a current geographic position of user **110** based on positional data received from client device **104** (e.g., GPS data transmitted to system **140** from client device **104** in response to a completed transaction, and/or a required update to system **140**) or from a third-party system associated with client device **104** (e.g., a mobile telecommunications provider). In certain aspects, system **140** may obtain the notification rules associated with account status indicators **502** and **504**. Based on a comparison of the current geographic position and the notification rules, system **140** may determine whether to instruct client device **104** to present or modify a presentation of account status indicator **502** and/or account status indicator **504**. In other instances, client device **104** may determine the current geographic position based on positional data obtained from the GPS, and may compare the current geographic position with the notification rules of account status indicators **502** and **504**. Based on the comparison, client device **104** may determine whether to generate, present, and/or modify a presentation of account status indicator **502** and account status indicator **504**.

Further, in additional aspects, client device **104** may be configured to detect a proximity system device associated with one or more of account status indicators **502** and **504** (e.g., an iBeacon™ device disposed on a bus fundable by user **110**'s transportation credit account). By way of example, and responsive to the detected proximity system device, client device **104** may be configured to generate, present, and/or modify a presentation of account status indicators **502** and/or account status indicator **504** in accordance with the notification rules.

By way of example, system **140** may determine that client device **104** is disposed within a shopping mall that, based on the corresponding notification rule, would trigger a presentation or a modification of account status indicator **502**. In response to the determination, system **140** may generate and transmit account status notification information to client device **104** that instructs client device **104** to present account status indicator **502** to user **110**, or alternatively, to modify a portion of previously presented account status indicator **502**. In other aspects, client device **104** may determine that its current geographic position falls within the shopping mall, and based on the notification rule, client device **104** may generate, present, and/or modify account status indicator **502** to user **110** in accordance with account status notification information received from system **140**.

In further embodiments, system **140** (and additionally or alternatively, client device **104**) may continue to monitor the geographic position of client device **104** and may determine that the user **110** is currently a portion of the shopping mall that includes a subway station. The notification rules may, for example, indicate that user **110**'s position within the subway station triggers a presentation or modification of account status indicator **504**. Based on the notification rules,



and using processes consistent with the disclosed embodiments, system **140** may generate and transmit account status notification information to client device **104** that instructs client device **104** to present account status indicator **504** to user **110**, or alternatively, to modify a portion of previously presented account status indicator **504**. Alternatively, client device **104** may generate, present, and/or modify account status indicator **504** to user **110** in accordance with account status notification information received from system **140** and using processes consistent with the disclosed embodiments. Account status indicator **504**, as presented or modified by client device **104**, may indicate an effective balance of user **110**'s transportation credit account that reflects a potential debit of a subway fare. Further, in some embodiments, client device **104** may present or modify account status indicator **504** in response to the change in geographic position without modifying a presentation of account status indicator **502**.

Through the disclosed embodiments, client device **104** may execute software processes that present account status indicators to user **110** based on a correspondence between a current geographic position of client device **104** and geographic regions or locations linked to the account status indicators. In certain aspects, client device **104** may present a graphical user interlace (GUI) that enables user **110** to establish a link between a specific geographic region and one or more of the account status indicators. Client device **104** may store information associated with the established link to define portions of the notification rules for the account status indicators, and additionally or alternatively, may transmit the information across network **120** to system **140**, which may generate the corresponding portions of the notification rules.

In other aspects, system **140** may execute software instructions that establish associations between account status indicators and corresponding geographic regions without input from user **110**. For example, system **140** may identify an account status indicator associated with a credit card account held by user **110**. In some instances, system **140** may access transaction data identifying purchase transactions involving the credit card account (e.g., within stored transaction data **144C**), may identify retailers associated with the purchase transactions, and further, may determine geographic locations of the identified retailers. System **140** may, for example, link the determined geographic locations to the account status indicator associated with a credit card account, and additionally or alternatively, link geographic regions that include clusters of the determined geographic locations the account status indicator associated with a credit card account. As described above, the linkage of the geographic regions and locations to the account status indicator may define at least a portion of the notification rule associated with the credit card account indicator.

Further, by way of example, system **140** may identify an account status indicator corresponding to an account associated with a loyalty program in which user **110** participates. The loyalty program may, for example, be sponsored by a merchant, and system **140** may obtain information identifying the particular loyalty program account (e.g., account number, points balance, etc.) from a corresponding data repository (e.g., stored account data **144B**). In some instances, system **140** may identify geographic positions of retail locations of the merchant, and may associate the identified geographic positions to the account status indicator associated with a loyalty program account. The association between of the geographic regions and locations to the

account status indicator may define at least a portion of the notification rule associated with the loyalty program account indicator.

Through the disclosed embodiments, system **140** and/or client device **104** may selectively generate, present, and/or modify account status indicators based on detected changes in user **110**'s current geographic position. In additional aspects, system **140** and/or client device **140** may be configured to selectively modify an account type associated with the indicator based on a geographic location of user **110**.

By way of example, user **110** may hold a checking account issued by a financial institution (e.g., business entity **160**), may participate in a loyalty program sponsored by a merchant having multiple retail locations, and may hold a transportation credit account loaded with funds or tokens facilitating a use of public transportation. In an embodiment, a notification associated with an account status indicator may be associated with a default account type (e.g., user **110**'s checking account), and system **140** and/or client device **104** may be configured to modify the default account type based on user **110**'s current geographic position and in accordance with the notification rules.

For instance, the notification rules may establish the loyalty program account as the account type for the account status indicator when user **110**'s current geographic position falls within a threshold distance of a retailer location of the merchant. Further, by way of example, the notification rules may establish the transportation credit account type as the account type for the account status indicator when user **110**'s current geographic position falls within the threshold distance of a subway or bus station (or in response to a detection of a proximity system device associated with subway or bus station). In certain aspects, user **110** may establish portions of the notification rules (e.g., threshold distances or geographic region) through a corresponding GUI presented by client device **104**, or system **140** may establish portions of the notification rules programmatically and without input from user **110** (e.g., based on a geographic analysis of prior purchase transactions).

By way of example, system **140** may receive positional data from client device **104**, and may determine that a current geographic position of user **110** falls within the threshold distance of a retail location of a merchant that sponsors user **110**'s loyalty program account. In response to the determination, system **140** may transmit data associated with the loyalty program account to client device **104**, which modify the account status indicator to present data associated with the loyalty program account in accordance with the notification rules and using processes consistent with the disclosed embodiments. In some instances, the modified account status indicator may include a modification of a color, shape, or other visual characteristic, which indicates to user **110** that the account status indicator reflects an account parameter of the loyalty program account.

Further, in some instances, system **140** may receive additional positional data that indicates user **110**'s current geographic position falls within the threshold distance of a subway station. In response to the change in user **110**'s current geographic position, system **140** may transmit data associated with the transportation credit account to client device **104**, which may modify the account data indicator to present data associated with transportation credit account in accordance with the notification rules and using processes consistent with the disclosed embodiments. For example, the modified account status indicator may indicate an effective balance of the transportation credit account that reflects a



potential debit of a subway fare. By way of example, the presented account status indicator may modify a color, shape, or other visual characteristic that renders the account status indicator specific to the transportation credit account.

Furthermore, if system **140** were to determine that user **110**'s current geographic position falls outside of the threshold distance of either the subway station or the retail locations, system **140** may transmit data associated with the default checking account to client device **104**. In some aspects, the transmitted data may instruct client device **104** to modify the account status indicator to present data indicative of a status (e.g., a balance) of the default checking account.

In other embodiments, the notification rules may define other parameters of an account status indicator (e.g., a type of balance (effective or actual), a type of indicator (glyph, bar, pie chart, etc.) and/or a visual, tactile, or audible characteristic of the indicator, etc.) based on a geographic location of user **110**. In one aspect, the notification rules for the account status indicator may establish a bar indicator (e.g., indicators **502** or **504** of FIG. **5A**) as a default indicator type, and may define a modification of the default indicator type to a glyph (e.g., FIG. **5D**) or a solid-color indicator (e.g., FIG. **5C**) when user **110**'s geographic position falls within a specific geographic region or regions. By way of example, user **110** may regularly purchase goods and services in crowded areas (e.g., stadiums, etc.), and the notification rules may require client device **104** (or system **140**) to display a solid-color indicator when user **110** is disposed within the stadium. In certain instances, client device **104**'s modification of the default bar indicator to a solid color indicator may continue to provide user **110** with non-obtrusive information identifying a status of an account without disclosing details regarding magnitudes and values of account parameters, such as account balance or credit limits.

In additional embodiments, system **140** and/or client device **104** may modify a type of balance associated with a presented account status indicator based on a current geographic position of user **110**. For instance, the notification rules may establish an actual or effective balance as a default account parameter for an account status indicator associated with a credit card account held by user **110**. The notification rules may further specify a remaining amount of available credit as the account parameter of the account status indicator when user **110** is disposed within a geographic region having a concentration of merchants (e.g., a shopping mall). In certain instances, system **140** may determine that user **110**'s current geographic position falls within the shopping mall, and may transmit credit card account data instructing client device **104** to modify the presented account data to reflect not the actual or effective account balance of the credit card account, but instead the remaining amount of available credit for the credit card account. In certain aspects, the presented account status indicator may modify a color, shape, or other visual, tactile, or audible characteristic of the indicator to enable user **110** to readily perceive the modified balance type.

In the embodiments disclosed above, reference is made to icons that include one or more account status indicators (e.g., account status indicators **502** and **504**). The disclosed embodiments are, however, not limited to the presentation and modification of two account status indicators, and in other embodiments, system **140** and/or client device **104** may selectively generate, present, and/or modify any additional or alternate numbers and types of account status indicators appropriate for presentation by client device **104**.

In certain embodiments, client device **104** may represent a computing device having a display unit capable of presenting one or more account status indicators within an augmented reality (AR) interface presented to a user. For example, client device **104** may represent "smart glasses" that include an optical head-mounted display (OHMD) configured to present interface elements as an AR view that "pop-ups" within a field of view of user **110** and modifies a visual appearance of an object within user **110**'s field-of-view (or within a presented image or video) to reflect a status of one or more accounts of user **110**. The smart glasses may, in some instances, communicate with system **140** across network **120**, and may be configured to receive account status notification information from system **140** at predetermined intervals, based on a geographic location of user **110**, and/or in response to predetermined triggering events established by user **110** or system **140** (e.g., a potential purchase of a product or service, a change in a status of one or more of user **110**'s accounts detected by system **140**). In response to the received account status notification information, and in accordance with notification rules established by user **110** and/or system **140**, the smart glasses may generate instructions that cause the OHMD to present one or more corresponding account status indicators within user **110**'s field-of-view, and additionally or alternatively, to modify visual characteristics of one or more previously presented account status indicators to reflect updates or changes in corresponding accounts held by user **110**.

The disclosed embodiments are, however, not limited to client devices having OHMDs capable of displaying interface elements within user **110**'s field-of-view, and in other embodiments, client device **104** may include a non-head-mounted device configured to generate a "head-up" display that projects one or more interface elements within user **110**'s field of view. For instance, client device **104** may represent a vehicle-based computing device having a display unit that projects interface elements onto an interior portion of a windshield of user **110**'s vehicle. The vehicle-based computing device may be in communication with system **140** via network **120**, and additionally or alternatively, may be in communication with a mobile communications device of user **110** using a Bluetooth™ connection, a NFC connection, or other appropriate communications protocol. In certain aspects, the vehicle-based computing device may receive account status notification information (e.g., directly from system **140** over communication network **120** or indirectly through user **110**'s mobile communications device) and may generate instructions that cause the display unit to project one or more corresponding account status indicators within user **110**'s field-of-view, and additionally or alternatively, to modify visual characteristics of one or more previously presented account status indicators to reflect updates or changes in corresponding accounts held by user **110**.

For example, using the exemplary techniques described above, user **110** may associate a glyph indicator (e.g., the indicator of FIG. **5D**) with an effective account balance of user **110**'s checking account and with an effective account balance of user **110**'s loyalty program account. The disclosed embodiments may also enable user **110** to establish (e.g., using a graphical user interface (GUI) presented by client device **104**) an indicator rubric specifying that the glyph indicator appears as a red "X" if either (1) the effective account balance of the checking account drops below \$10,000 or (2) the effective account balance of the loyalty program account falls below 1,000 points. Furthermore, user **110** may configure notification processes consistent with the



disclosed embodiments to check for an updated indicator status at specified temporal intervals (e.g., every five minutes), in response to a purchase of a product or service using the checking account (e.g., using a debit card linked to user 110's checking account), or in response to a change in a point balance of user 110's loyalty program account (e.g., a purchase transaction that accrues loyalty points, or a transaction in which user 110 exchanges loyalty program points for a product or service).

In one instance, after the specified temporal interval, system 140 may access stored account data associated with user 110's checking account and user 110's loyalty program account (e.g., within account data 144B), and may determine that the effective account balance of user 110's checking account is \$11,375, and that the effective account balance of user 110's loyalty program account is 1,100 points. Applying the established indicator rubric to the effective account balances, system 140 may determine that client device 104 should present a green "check mark" as the glyph indicator (e.g., that the indicator status is that of a green check mark). System 140 may also generate account status notification information that identifies the indicator type (e.g., glyph) and specifies the indicator status (e.g., green check mark). In some instances, the account status notification may also include information identifying the checking account and/or loyalty program account (e.g., account numbers, names of issuing financial institution or retailers, etc.), and further, information identifying the effective account balances of the checking account and/or the loyalty program accounts. System 140 may be configured to transmit the account status notification information to client device 104 across network 120 using any of the communications protocols outlined above.

In some embodiments, client device 104 (e.g., a pair of smart glasses) may include an OHMD configured to present one or more account status indicators as an AR view that "pop-ups" within a field of view of user 110 and modifies a visual appearance of an object within user 110's field-of-view (and/or within an image or video presented by the OHMD) to reflect a status of one or more accounts of user 110. Client device 104 may, in certain aspects, be configured to receive the account status notification information from system 140, generate an account status indicator in accordance with the account status notification information, and instruct the OHMD to render the generated account status indicator for presentation to user 110 at a corresponding position within the field-of-view of user 110, as illustrated in FIG. 8A.

FIG. 8A schematically illustrates an exemplary field-of-view 800 provided by an exemplary pair of smart glasses having an OHMD. In certain aspects, the smart glasses (e.g., client device 104) may receive the account status notification information from client device 104 (e.g., specifying a glyph indicator having a green check mark), and may generate the specified glyph indicator for rendering and presentation within field-of-view 800. By way of example, as illustrated in FIG. 8A, client device 104 may instruct the OHMD to present glyph indicator 812 within an upper-left corner of field-of-view 800. In some aspects, a size and/or a position of glyph indicator 814 within field-of-view 800 may be established by user 110 (e.g., within corresponding notification rules using a GUI presented by client device 104), and additionally or alternatively, by client device 104 or system 140 based on operational parameters and limitations of the OHMD.

Further, as described above, system 140 may be configured to monitor transaction data associated with user 110's

checking account, and in some aspects, system 140 may detect that, e.g., a hotel in Toronto, Canada, placed a hold of \$2,000 on user 110's checking account. In response to the detected transaction, system 140 may determine that the effective account balance of user 110's checking account is currently \$9,375 (i.e., below the \$10,000 threshold). In certain aspects, and based on the corresponding notification rules and/or indicator rubrics, system 140 may determine to modify the indicator status for the glyph indicator to correspond to a red "X," and transmit updated account status notification information to client device 104. As described above, the updated account status notification information may include the modified indicator status, and additionally or alternatively, information identifying the modified effective account balance of user 110's checking account.

Client device 104 may receive the updated account status notification information, and using the exemplary techniques described above, may instruct the OHMD to render and present a modified account status indicator consistent with the changed status of user 110's checking account. For example, as outlined in FIG. 8B, client device 104 may instruct the OHMD to present to user 110 a modified account status indicator 822 in the form of a red "X," which indicates to user 110 that the effective account balance of the checking account has fallen below the user-specified threshold balance. In certain aspects, the modification to the account indicator, which the OHMD presents within user 110's field-of-vision, may act as a reminder that user 110 should consider alternate forms of payment that do not immediately impact user 110's checking account, or alternatively, that user 110 should top off the checking account with reserve funds in order to maintain the desired threshold balance.

Furthermore, as described above, the disclosed embodiments may be configured to present visual, audible, and/or tactile indicators that reflect an impact of a potential purchase of a product or service on one or more accounts held by user 110. By way of example, user 110 may wear a pair of "smart glasses" that include an OHMD (e.g., client device 104), and user 110 may browse products offered for sale by a retailer of consumer electronics. In certain aspects, client device 104 may modify an appearance of at least a portion of a product disposed within user 110's field-of-view (e.g., the field-of-view defined by user 110's smart glasses) to reflect a status of one or more financial services accounts and loyalty program accounts held by user 110.

By way of example, user 110 may browse products offered for sale by a merchant of consumer electronics. In certain instances, and as illustrated in FIG. 9A, user 110 may view a portion of a tablet computer (e.g., tablet computer portion 900) through a corresponding field-of-view 800 of user 110's smart glasses. In FIG. 9A, user 110 may view information 902 identifying a model of the tablet computer (e.g., an iPad Air™) and a configuration of the tablet computer (e.g., 128 GB of storage). User 110 may also view a label 904 affixed to tablet computer portion 900 that includes a machine-readable code 904A and a list price 904B of the tablet computer (e.g., \$699). In some aspects, machine-readable code 904A may correspond to an optical machine-readable representation of data identifying the tablet computer, characteristics of the tablet computer (e.g., list price, etc.), and/or the merchant that offers the tablet computer for sale. For example, machine-readable code 904A may include, but is not limited to, a bar code, a QR code, and other one and two-dimensional optical machine-readable codes.

In some aspects, client device 104 (e.g., the smart glasses having the OHMD) may execute software processes that



cause a digital camera associated with client device **104** to capture an image of tablet computer portion **900**. Client device **104** may, for instance, perform optical character-recognition (OCR) processes on the captured image data to obtain product information, which includes, but is not limited to, the tablet model (e.g., iPad Air™), the tablet configuration (e.g., 128 GB), and the tablet price (e.g., \$699). In other instances, client device **104** may process the captured image data in order to obtain product and/or retailer information encoded within machine-readable code **904B**. By way of example, the obtained product and/or merchant information may include, but is not limited to, a Universal Product Code (UPC) number associated with the tablet computer, a model, configuration, and/or price of the tablet computer, or the merchant offering the tablet computer for sale.

In an embodiment, the digital camera associated with client device **104** may be configured to capture the image data of tablet computer portion **900** automatically and without input from user **110**. For example, the digital camera may continuously obtain image data corresponding to tablet computer portion **900**, and client device **104** may execute software processes that automatically capture and store a portion of the obtained image data having image characteristics (e.g., image focus, image resolution, etc.) sufficient for OCR and code processing, as described above. In other aspects, however, client device **104** may capture and store a portion of the obtained image data based on user input, e.g., a gestural input, a verbal input, or other appropriate input appropriate to client device **104**.

In some aspects, client device **104** may be configured to transmit the obtained product and/or merchant information to system **140**, which may process the received information to determine an impact of user **110**'s potential purchase on one or more of user **110**'s accounts. The disclosed embodiments are, however, not limited to exemplary processes in which client device **104** performs OCR and code-reading processes on captured image data. In other instances, client device **104** may be configured to transmit the captured image data to system **140**, which may perform the OCR and/or code-reading processes to generate information identifying the tablet computer and additionally or alternatively, the merchant offering the tablet computer for sale, using any of the techniques described above.

In certain aspects, system **140** may be configured to identify and obtain additional product and/or merchant information necessary to determine an impact of the potential purchase on user **110**'s accounts. By way of example, the received product information may include a UPC number associated with the tablet computer and information identifying the merchant that offers the tablet computer for sale, but may not include a price of the tablet computer. In some instances, system **140** may be configured to query an additional computing system associated with the merchant (e.g., across network **120** through a corresponding API), and in response to the query, system **140** may receive the price of the tablet from the merchant system.

Further, in some embodiments, system **140** may execute software processes that assess an impact of the potential purchase of the tablet computer on one or more accounts held by user **110**. By way of example, user **110** and/or system **140** may establish notification rules and/or indicator rubrics using any of the exemplary processes outlined above, which system **140** may store in a corresponding data repository (e.g., data repository **144**). In certain aspects, system **140** may retrieve the stored notification rules and/or indicator rubrics associated with user **110**, and may deter-

mine that one of the retrieved notification rules requires that client device **104** modify an appearance of a product in user **110**'s field-of-view whose purchase is deemed eligible for loyalty points. For example, the notification rule may specify that client device **104** notify user **110** of the tablet computer's eligibility for loyalty points by presenting a blue ring or halo that surrounds the tablet computer within user **110**'s field-of-view (e.g., field-of-view **800** of user **110**'s smart glasses in FIG. **9A**).

In response to the notification rule and the determined eligibility of the tablet computer for loyalty points, system **104** may generate account status notification information that identifies the eligibility of the table computer for loyalty points, and further, instructs client device **104** to present the blue ring or halo surrounding the table computer within user **110**'s field-of-view. System **140** may, for example, transmit the generated account status information to client device **104** across network **120** using any of the communications protocols outlined above.

Client device **104** may be configured to receive the account status notification information from system **140**, and may execute software processes that generate and present an interface element within user **110**'s field-of-view that surrounds the table computer with the blue ring or halo. For instance, as illustrated in FIG. **9B**, client device **104** may instruct the OHMD to present an interface element **912** within user **110**'s field-of-view in a manner that surrounds tablet computer portion **900**, and further, to color interface element **912** blue within field-of-view **800**. In some aspects, the OHMD may present ring **912** as an augmented reality (AR) view that "pop-ups" within the field-of-view of user **110** and modifies a visual appearance of an object within user **110**'s field-of-view (or within a presented image or video) to reflect a status of one or more accounts of user **110**.

In some embodiments, client device **104** may execute software processes that generate an interface element corresponding to ring **912**, which the OHMD may render and present within user **110**'s field-of-view **800**. For example, as described above, the digital camera associated with client device **104** may continuously sample image data from user **110**'s field-of-view, and using one or more image processing techniques, client device **104** may establish a boundary of the visible portion of the tablet computer within the sampled image data, and further, may determine a centroid of the portion of user **110**'s field-of-view enclosed by the boundary (e.g., the centroid of the visible portion of the table computer). In some aspects, the interface element corresponding to ring **912** of FIG. **9B** may be generated initially as a two-dimensional circular element centered on the determined centroid of the visible portion of the tablet computer, with the portion of the circular element enclosed within the determined boundary eliminated. The dimensions of the ring **912** may, in some instances, be established by user **110** within the corresponding notification rule (e.g., using any of the processes described above), or alternatively, may be established by client device **104** and/or system **140** based on one or more properties of the OHMD or a dimension of field-of-view **800**.

In other embodiments, system **140** may determine that the notification rules and/or indicator rubrics associated with user **110** require client device **104** to modify an appearance of a product within user **110**'s field-of-view to reflect an impact of a potential purchase of the product on one or more accounts held by user **110**. For instance, notification rules consistent with the disclosed embodiments may specify that client device **104** notify user **110** of the impact of the potential purchase of the tablet computer on user **110**'s



checking account, credit card account, and loyalty program account by presenting corresponding account status indicators within user **110**'s field-of-view.

In certain aspects, the account status indicators may represent concentric rings disposed about the tablet computer within user **110**'s field-of-view, and the concentric ring indicators may visually characterize the impact of user **110**'s potential purchase of the table computer on effective account balances of corresponding ones of user **110**'s checking account (e.g., a through a purchase using a linked debit card), user **110**'s credit card account (e.g., a Visa™ card), and user **110**'s loyalty program account. Further, client device **104** may characterize the status of actual or effective account balances of the checking, credit card, and loyalty program accounts by establishing and/or varying one or more visual characteristics of the concentric ring indicators (e.g., a color, color gradient, or pattern) based on a corresponding indicator rubric or notification rule established using any of the techniques outlined above.

By way of example, system **140** may obtain notification rules and/or indicator rubrics that associate a first concentric ring indicator with the effective balance of user **110**'s checking account, that associate a second concentric ring indicator (e.g., disposed proximate to an outer circumference of the first concentric ring indicator) with the effective balance of user **110**'s credit card account, and further, that associate a third concentric ring indicator (e.g., disposed proximate to an outer circumference of the second concentric ring indicator) with an actual balance of user **110**'s loyalty program account. In further aspects, an indicator rubric obtained by system **140** may specify that the first concentric ring indicator appear as red when the effective balance of user **110**'s checking account drops below a \$10,000 threshold, or green when the effective balance remains about the \$10,000 threshold. Additionally, indicator rubrics consistent with the disclosed embodiments may specify that the third concentric ring indicator appears as red when the actual balance of user **110**'s loyalty program account remains below a 10,000-point threshold associated with a \$100 cash reward, and as green when the actual balance exceeds the 10,000-point threshold. Finally, an indicator rubric obtained by system **140** may specify that the second concentric ring indicator appear as green when an effective account balance of user **110**'s credit card account, when adjusted to account for a cash reward from user **110**'s loyalty program, remains below a \$5,000 threshold, or red when the adjusted effective account balance rises above the \$5,000 threshold. In certain instances, user **110** and/or system **140** may establish portions of one or more of the notification rules and/or indicator rubrics using any of the exemplary techniques outlined above.

In certain aspects, using any of the exemplary techniques identified above, system **140** may determine that user **110**'s checking account is associated with a current effective account balance of 10,250, that user **110**'s credit card is associated with a current effective balance of \$4,350, and that user **110**'s loyalty program account is associated with an actual balance of 9,885 points. Further, the received and/or generated product information may indicate a cost of \$699 for user **110**'s potential purchase of the tablet computer. Applying the notification rules and/or indicator rubric to user **110**'s checking account, system **140** may determine that the purchase of the tablet computer would reduce the effective account balance of user **110**'s checking account to \$9,551, and that the first concentric ring indicator should appear red when presented by client device **104**.

Based on stored loyalty program information (e.g., information stored in account data **144B** that specifies the loyalty program accrues one point for each dollar sent), system **140** would determine that the purchase of the tablet computer would result in an actual loyalty point balance of 10,257 points, which would provide user **110** with a \$100 cash reward. System **140** may, in some instances, determine that the third concentric ring indicator should appear green when presented to user **110** by client device **104**.

Further, applying the notification rules and/or indicator rubric to user **110**'s credit card account, system **140** may determine that the \$100 cash reward issued by user **110**'s loyalty program offsets the purchase price of the tablet computer, which would increase the effective balance of user **110**'s credit card account to \$4,949. In certain aspects, system **140** may determine that the second concentric ring indicator should appear green when presented to user **110** by client device **104**.

In some embodiments, system **140** may generate account status notification information that specifies the presentation of the first, second, and third concentric ring indicators (e.g., corresponding, respectively, to an effective balance of user **110**'s checking account, an effective balance of user **110**'s credit card account, and an actual balance of user **110**'s loyalty program account), and further, includes information identifying the status (e.g., red or green) of the concentric ring indicators. In some aspects, the generated account status notification information may further identify the effective balance of user **110**'s checking account, the effective balance of user **110**'s credit card account, and/or the actual balance of user **110**'s loyalty program account that would result from the potential purchase of the tablet computer, and additionally or alternatively, the \$100 cash reward obtained from the potential purchase of the tablet computer. System **140** may be configured to transmit the generated account status notification information to client device **104** across network **120** using any of the communications protocols outlined above.

Client device **104** may be configured to receive the account status notification information from system **140**, and may execute software processes that generate and present the first, second, and third concentric ring indicators as interface elements that surround the portion of the tablet computer visible within user **110**'s field of view. For example, client device **104** may execute software processes that generate the interface elements corresponding to the first, second, and third concentric ring indicators using any of the exemplary techniques described above, and the OHMD may render the generated interface elements for presentation within user **110**'s field of view.

FIG. **9C** illustrates an exemplary augmented reality (AR) view presented by client device **104** within user **110**'s field-of-view **800**, in accordance with disclosed embodiments. For instance, as illustrated in FIG. **9C**, client device **104** may instruct the OHMD to render and present a red interface element **922** corresponding to the first concentric ring indicator and indicative of an impact of the potential purchase of the tablet computer on the effective balance of user **110**'s checking account. Further, for example, client device **104** may instruct the OHMD to present green interface elements **924** and **926** that correspond, respectively, the second and third concentric ring indicators (which indicate the impact of the potential purchase of the table computer on the effective balance of respective ones of user **110**'s credit card account and on user **110**'s loyalty program account). In some embodiments, the OHMD may present interface elements **922**, **924**, and **926** an augmented reality (AR) view that "pop-ups" within the field-of-view **800** and surrounds



the visible portion **900** of the tablet computer within field-of-view **800**. In certain aspects, interface elements **922**, **924**, and **926** may modify an appearance of visible portion **900** of the tablet computer (e.g., as perceived by user **110**) to indicate to user **110** an impact of the potential purchase of the tablet computer on the effective balance of user **110**'s checking account, credit card account, and loyalty program account.

In certain aspects, by viewing interface elements **922**, **924**, and **926** within field-of-view **800**, user **110** may readily determine an impact of the potential purchase of the tablet computer on the checking account, credit card account, and loyalty account. For instance, as interface element **924** is colored green, user **110** may determine that the purchase of the tablet computer would not increase the effective balance of the credit card account beyond the threshold specified in the corresponding notification rule and/or indicator rubric. Further, since the OHMD presents interface element **926** as green, user **110** may determine that the purchase of the laptop would entitle user **110** to a cash reward of \$100 (e.g., based on a potential increase in loyalty points above the 10,000 threshold established by user **110**).

Further, the disclosed embodiments also enable user **110** to link (e.g., through a corresponding GUI presented by client device **104**) any additional or alternate numbers and types of accounts to concentric ring indicators forming portions of the AR view presented by the OHMD. In certain aspects, user **110**'s ability to "layer" multiple ring indicators linked to status of corresponding account parameters, and to filter the layered ring indicators adaptively and dynamically using the GUI, may assist the user **110** in making an optimal decision regarding not only a potential purchase, but also the account or accounts impacted by the purchase.

The disclosed embodiments are, however, not limited to an optical device (e.g., the OHMD of client device **104**) that generates and presents interface elements within an AR view that modifies a visual appearance of a physical object disposed within user **110**'s field-of-view (e.g., portion **900** of the tablet computer). In other embodiments, the optical device (e.g., the OHMD or a device capable of generating a "heads-up" display) may be configured to present to user **110** multimedia content (e.g., stored or streaming digital image or digital video content) within user **110**'s field of view. In certain aspects, the OHMD may be configured to generate and present interface elements that modify an appearance of an object within the presented multimedia content (e.g., as perceived by the user) to reflect a status of one or more accounts of user **110**. For instances, client device **104** may instruct the OHMD to present one or more of interface elements **922**, **924**, and **926** within user **110**'s field-of-view to modify a visual appearance of an object or individual within the presented multimedia content and convey a status of user **110**'s checking account, credit card account and/or loyalty program account.

Further, the disclosed embodiments may enable client device **104** of user **110** to receive account status notification information from system **110**, and based on the received information, to generate and present to user **110** one or more graphical, tactile, or audible indicators reflective of a status of parameters of one or more accounts held by user **110**. In some aspects, the presented indicators may include information identifying a relationship of an account parameter (e.g., an effective account balance) to a user-defined or default threshold, and further, may indicate a particular value associated with the account parameter. As described above, indicators consistent with the disclosed embodiments may include, but are not limited to, colored status bar

indicators, glyph indicators, symbol indicators, picture indicators, and concentric ring indicators.

In certain instances, the account status indicators generated and presented by client device **104** may indicate a status of an account parameter, such an effective account balance or a loyalty point balance, relative to a user- or system-established threshold. For example, a glyph indicator may correspond to a green "check mark" when an effective account balance of user **110**'s checking account exceeds a threshold balance, or alternatively, a red "X" when the effective account balance falls below the threshold balance. In other aspects, and in addition to reflecting a relationship between the account parameter and the established threshold, the generated and presented account status indicator may also indicate to user **110** the actual value of the account parameter. For example, client device **104** may generate and present to user **110** a status bar indicator that is not only shaded red or green depending on the relationship between an effective account balance of user **110**'s checking account and an established threshold, but also takes the form of a bar graph that presents to user **110** a current value of the effective account balance. In one embodiment, user **110** may associate a particular type of account status indicator with a corresponding account in a notification rule and/or indicator rubric using any of the exemplary techniques described above. In other instances, system **140** may assign default types of account status indicators (e.g., less descriptive glyph indicators) to corresponding ones of user **110**'s accounts without input from user **110**.

The disclosed embodiments may also enable client device **104** to receive account status notification information from system **140**, and to transmit the received information to one or more additional devices (e.g., "connected" devices) that are capable of establishing communication sessions with client device **104** and capable of displaying account status indicators of varying detail and complexity. By way of example, communications between client device **104** and the connected devices may occur across network **120** (e.g., a wired or wireless LAN, a RF network, a NFC network, a WiFi network, a Bluetooth™ network) using any of the communications protocols outlined above.

In certain aspects, client device **104** may execute software processes that receive account status notification information from system **140**, that identify one or more of the connected devices eligible to receive notifications and present indicators (e.g., based on previously established connected device information), and further, that automatically transmit or "push" portions of the received notification information to the eligible connected devices without input or intervention from user **110**. In some instances, client device **104** may select portions of the received notification information for transmission to the connected devices, or may modify portions of the received information, to comport with corresponding capabilities and functionalities of the connected devices, which may be set forth in the previously established connected device information.

In some aspects, user **110** may, through a graphical user interface (GUI) presented by client device **104**, establish portions of the connected device information that identify one or more connected devices capable of establishing communications with client device **104**, identify whether the connected devices are eligible to receive notification information and present indicators, and further, identify a type of account indicator the eligible connected devices may present to user **110**. In one embodiment, user **110** may establish the connected device information using techniques similar to those outlined above that establish notification rules and/or



indicator rubrics. In other embodiments, system **140** and/or client device **104** may establish, without user input or intervention, at least a portion of the connected device information by associating corresponding connected devices with default indicator types for specific accounts. In certain aspects, client device **104** may store the established connected device information in a data structure within a corresponding local data storage, or may periodically upload the established connected device information for storage in a data repository locally accessible to system **140** (e.g., data repository **144**).

FIG. **10** illustrates and exemplary tabular data structure **1000** within which client device **140** may store established connected device information, in accordance with disclosed embodiments. For example, and as described above, client device **104** may present to user **110** a graphical user interface (GUI) that enable user **110** to identify one or more connected devices capable of establishing communications sessions with client device **104**, and further, to establish corresponding notification parameters for the identified connected devices. Client device **104** may, in some instances, propose a set of candidate connected devices that previously established communications sessions with client device **104** (e.g., a computing device disposed within user **110**'s Mini Cooper™ and with which client device **104** previously coupled and established communications sessions) or alternatively, that are capable of establishing a communications session with client device across network **120** (e.g., based on a response to a broadcast query message).

In certain aspects, the GUI may allow user **110** to establish one or more notification parameters for the connected devices identified by client device **104**. As outlined in FIG. **10**, notification parameters consistent with the disclosed embodiments include, but are not limited to, a device name, a device address, an eligibility parameter, an access type parameter, and an indicator type parameter. Upon specification of the notification parameters for the corresponding connected devices, client device **104** may generate data records for the corresponding devices, which may be incorporated into and stored within data structure **1000**. In some instances, user **110** may specify values for the notification parameters within the GUI for one or more of the connected devices. In other instances, however, client device **104** may establish or suggest values appropriate to notification parameters for one or more of the connected devices (e.g., devices names that comport with system or communications protocol requirement, or addresses identified programmatically by client device **104**), and user **110** may be invited by the GUI to confirm the established or suggested values.

For example, in FIG. **10**, data record **1002** corresponds to a computing device disposed within user **110**'s Mini Cooper™ vehicle (e.g., the “connected” Mini Cooper™). In certain aspects, client device **104** may establish a device address for the connected Mini Cooper™ (e.g., xx:xa:95:xd:68:16). Further, by way of example, user **110** may specify within the GUI that the connected Mini Cooper™ device is eligible to receive notifications, and further, that the connected Mini Cooper™ should be afforded an “Authenticated” type of access to user **110**'s account information. In certain aspects, user **110**'s establishment of “Authenticated” access for the connected Mini Cooper™ implies that account status notification information provided to the connected Mini Cooper™ may include not only information that identifies a relationship between an account parameter and an established threshold (e.g., whether an effective balance of user **110**'s checking account exceeds a threshold value), but also information that identifies the value of the

effective balance (e.g., user **110**'s checking account includes an effective balance of \$11,500, which exceeds the threshold of \$10,000). Further, user **110**'s ability to establish the “Authenticated” access for the connected Mini Cooper™ may be based on an ability of client device **140** to communicate securely with the connected Mini Cooper™ across communications network **120**. Further, as illustrated in FIG. **10**, the connected Mini Cooper™ may be capable of generating and presenting status bar indicators, pie chart indicators, background color indicators, picture indicators, symbol indicators, glyph indicators, text-based indicators, and/or auditory indicators.

Referring back to FIG. **10**, data record **1004** corresponds to a connected lighting system capable of communicating with client device **104** over network **120**. As described above, client device **104** may establish a device address for the connected lighting system (e.g., xx:yb:90:xe:47:15), and user **110** may specify within the GUI that connected lighting system is eligible to receive account status notifications. User **110** may also specify within the GUI that the connected lighting system is afforded “Indirect” access to user **110**'s account information, and further, that the connected lighting system is capable of presenting only a background color account status indicator to user **110**. In certain aspects, user **110**'s establishment of “Indirect” access for the connected lighting system implies that account status notification information communicated from client device **104** to the connected lighting system may only identify a relationship between an account parameter and an established threshold (e.g., whether an effective balance of user **110**'s checking account exceeds a threshold value), and may not include information identifying a value of the account parameter.

Further, by way of example, data record **1006** of FIG. **10** may correspond to a connected security system disposed within user **110**'s home and capable of communicating with client device **104** over network **120**. As described above, client device **104** may establish a device address for the security system (e.g., zz:ya:25:8f:44:33). As illustrated in FIG. **10**, however, user **110** may specify that the security system is ineligible to receive account status notification information or to present account status indicators to user **110**. In certain aspects, user **110**'s establishment of the security system as ineligible for notifications may be a personal decision that ensures the individuals in user **110**'s home do not mistake the presentation of an account status indicator by the security system as an actual alarm.

In some embodiments, and upon receipt of account status notification information from system **140**, client device **104** may access data record **1000** and may identify one or more connected devices eligible to receive notification information and present account status indicators to user **110**. If client device **104** were to identify eligible connected devices, client device **104** may establish communications within the eligible connected devices (if such communications were not previously established), generate device-specific notifications tailored to the access and indicator type associated with the eligible connected devices, and transmit the generated device-specific notifications to the eligible connected devices directed over network **120** without user **110**'s input or intervention, as described below in reference to FIG. **11**.

FIG. **11** illustrates an exemplary process **1100** for present and relay account status notifications to eligible connected devices, consistent with disclosed embodiments. In one embodiment, a client device associated with a user (e.g., client device **104** associated with user **110**) may be in communication with a system associated with a financial



institution (e.g., system **140** of business entity **160**) and may be configured to receive notification information identifying a status of one or more account parameters of one or more accounts held by user **110**. In some aspects, client device **104** may identify one or more identifiable and addressable devices (e.g., connected devices) capable of communicating with client device **104** and presenting visual, tactile, and/or audible indicators of the account status to user **110**. Client device **104** may, in some embodiments, transmit notification information to the connected devices that instructs the connected devices to present account status indicators consistent with capabilities and levels of access assigned to the connected devices by user **110**.

In certain aspects, client device **104** may be configured to receive account status notification information from system **140** (e.g., in step **1102**). As described above, account status notification information consistent with the disclosed embodiments may reflect a status of an account parameter (e.g., an effective balance) associated with a single account of user **110** (e.g., user **110**'s checking account), and additionally or alternatively, statuses of multiple account parameters associated with one or more of user **110**'s accounts (e.g., an effective balance and remaining available credit associated with a credit card account of user **110**, and an actual balance of loyalty points associated with a loyalty program account of user **110**). In some instances, the received account status notification information may include actual values of the account parameters and established threshold values (user **110**'s effective checking account balance of \$11,500 exceeds the threshold balance of \$10,000), and further, information instructing client device **104** to generate a particular account status indicator based on the actual values and established threshold (e.g., a status bar indicator). Further, system **140** may monitor user **110**'s accounts and generate the account status notification information (e.g., based on notification rules and/or indicator rubrics) using any of the exemplary techniques described above.

In one aspect, client device **104** may generate and present an account status indicator consistent with the received account status notification information. For example, system **140** may generate and transmit the account status notification information to client device **104** in response to user **110**'s purchase of a particular good or service user a debit card linked to user **110**'s checking account. In some instances, the account status notification information may include a current effective balance of user **110**'s checking account (e.g., \$11,500), which may reflect user **110**'s recent purchase, and a threshold effective account balance for user **110**'s checking account (e.g., \$12,000). The account status notification may also instruct client device **104** to generate a color-coded status bar that conveys a magnitude of user **110**'s current effective account balance and that is colored red to convey that the current effective account balance falls below the user-specified threshold.

In some instances, client device **104** may generate and present the corresponding account status indicator using any of the exemplary techniques described above. In other instances, however, client device **104** may delegate the generation and/or presentation of the corresponding account status indicator to one or more additional devices capable of communicating with client device **104** across network **120**.

For instance, and in response to the received account status notification information, client device **104** may access profile information associated with user **110** to identify the one or more additional device (e.g., "connected" devices) capable of communicating with client device **104** and

deemed eligible by user **110** to receive notification information and present account status indicators (e.g., in step **1104**). As described above, client device **104** may access connected device information stored within a corresponding data structure (e.g., data structure **1000** of FIG. **10**), may determine that a computing device disposed within user **110**'s Mini Cooper™ (e.g., a "connected" Mini Cooper™) and a "connected" lighting system disposed within user **110**'s home are eligible to receive account status notifications and present account status indicators.

In step **1106**, client device **104** may attempt to establish a communications session with the connected Mini Cooper™ and the connected lighting system, if suitable communications sessions do not already exist. For example, user **110** may be disposed in the connected Mini Cooper™, and client device **104** may be capable of establishing communications with the connected Mini Cooper™ across network **120** using any appropriate communications protocol outlined above. Additionally or alternatively, user **110** may be disposed within or near his or her home, and client device **104** may also be capable of establishing communications with the connected lighting system across network **120** using any appropriate communications protocol outlined above.

Client device **104** may be configured to determine whether any communications sessions were successfully established with the eligible connected devices (e.g., in step **1108**). If client device determines that no communications sessions with the connected devices could be established (e.g., step **1108**; NO), then exemplary process **110** is complete in step **1110**. In certain aspects, when communications cannot be successfully established with connected devices, client device **104** may generate and present the account status indicator corresponding to the received account status notification information using any of the exemplary techniques described above.

If, however, client device **104** were to establish a communications session with a corresponding one of the connected devices (e.g., step **1108**; YES), client device **104** may obtain additional information identifying a type of access associated with the corresponding connected device, and further, a type of indicator presentable by the corresponding connected device (e.g., in step **1112**). In certain aspects, client device **104** may generate a device-specific notification for the corresponding connected device that includes (i) a portion of the received account status notification deemed consistent with the identified access type and (ii) information specifying an account status indicator consistent with the identified indicator type (e.g., in step **1114**).

Client device **104** may be configured to transmit the device-specific notification to the corresponding connected device across network **120** using any appropriate communications protocol outlined above (e.g., in step **1116**). As described above, client device **104** may be configured to transmit the device-specific notification to the corresponding connected device automatically and without intervention or input from user **110**. Upon receipt of the device-specific notification, the corresponding connected device may be configured to present generate and present the specified account status indicator to user **110**. Upon transmission of the device-specific notification to the corresponding connected device, exemplary process **1100** is complete in step **1110**.

By way of example, client device **104** may establish a communication session with the connected Mini Cooper™ (e.g., in step **1108**). As described above, client device **104** may data associated with the connected Mini Cooper™ (e.g., data record **1002** of FIG. **10**), and may determine that



user 110 specified an “Authenticated” access type for the connected Mini Cooper™ (e.g., in step 1112). In certain aspects, user 110’s establishment of an “Authenticated” access type for the connected Mini Cooper™ implies that account status notification information provided to the connected Mini Cooper™ may include actual values of the account parameters and established threshold values. Client device 104 may also determine in step 1112 that the connected Mini Cooper™ is capable of generating and presenting status bar indicators, pie chart indicators, background color indicators, picture indicators, symbol indicators, glyph indicators, text-based indicators, and/or auditory indicators.

In certain aspects, client device 104 may establish that the account status notification information received from system 140 is consistent with the access type and indicator type established by user 110 for the connected Mini Cooper™ (e.g., in step 1112). Client device 104 may, for example, forward the received account status notification information to the connected Mini Cooper™, which may process the account status notification information to generate and present an appropriate account status indicator (e.g., in step 1114). By way of example, and in response to the account status notification information, the connected Mini Cooper™ may be configured to generate a color-coded status bar that conveys a magnitude of user 110’s current effective account balance (e.g., \$11,500) and that is colored red to convey that the current effective account balance falls below the user-specified threshold (e.g., \$12,000). The connected Mini Cooper™ may render the generated color-coded status bar for presentation to user 110 through a corresponding display unit (e.g., a touch-screen display or head-up display).

Further, in some embodiments, the connected Mini Cooper™ may be capable of presenting additional notifications and indicators to user 110 through the corresponding display unit. For example, the connected Mini Cooper™ may be configured to generate and present a low-fuel indicator to user 110 once an amount of remaining fuel falls below a predetermined level (e.g., 10% of capacity). Similarly, the connected Mini Cooper™ may be configured to display a scheduled service indicator to user 110 at a predetermined point prior to the scheduled service (e.g., when an odometer falls within 3,000 miles of a scheduled 20,000-mile service).

In certain aspects, when the effective balance of user 110’s checking account falls below or within predetermined range of the established threshold balance, the connected Mini Cooper™ may increase the predetermined level of fuel that triggers the low-fuel indicator, and further, may present the scheduled service indicator at a mileage closer to that associated with the scheduled service. For example, as the current effective balance of \$11,500 falls below the threshold balance of \$12,000, the connected Mini Cooper™ may display the low-fuel indicator when the remaining fuel falls below 20% capacity and/or display the scheduled service indicator when the odometer reading falls within 1,000 miles the scheduled 20,000-mile service. In some instances, the additional time before refueling or servicing may allow user 110 to bring the effective account balance of the checking account above the established threshold.

In other instances, client device 104 may establish a communication session with the connected lighting system (e.g., in step 1108). As described above, client device 104 may obtain device data associated with the connected lighting system (e.g., data record 1004 of FIG. 10), and may determine that user 110 specified an “Indirect” access type for the connected lighting system (e.g., in step 1112). In certain aspects, user 110’s establishment of an “Indirect”

access type implies that the account status notification information provided to the connected lighting system may identify a relationship between an account parameter and an established threshold (e.g., whether an effective balance of user 110’s checking account exceeds a threshold value), but may not include actual values of the account parameters and established threshold values. Client device 104 may also determine in step 1112 that the connected lighting system is capable of generating and presenting only a background color indicator.

In certain aspects, client device 104 may modify the account status notification information received from system 140 to generate a device-specific notification, which may identify that the current effective account balance of user 110’s checking account falls below the establish threshold value, and may instruct the connected lighting system to glow red for a predetermined period to alert user 110 status of user 110’s checking account (e.g., in step 1114). Client device 104 may transmit the device-specific notification to the connected lighting system automatically and without input or intervention from user 110, and the connected lighting system may process the device-specific notification and adjust its display properties to glow red for the predetermined time period.

The disclosed embodiments may enable client device 104 to receive account status notification information and relay or “push” that portions of that account status notification information to eligible connected devices for presentation to user 110. Although described in reference to a notifications and indicators for a single account, system 140 may perform one or ore of the exemplary processes described above to provide client device 104 with account notification information for multiple accounts (e.g., user 110’s checking account and loyalty program account), which client device 104 may process and selectively push to one or more eligible devices to presentation in accordance with user-specified access types and indicator types. For instance, user 110 may specify (e.g., via a GUI presented by client device 104) that vehicle-based eligible devices may receive notification information for any account, while home-based eligible devise (e.g., connected lighting systems) may receive notification information corresponding to only loyalty account.

In some aspects, the disclosed embodiments may enable client device 104 to relay or “push” portions of account status notification information to eligible connected devices based on geographic positional information. For instance, client device 104 may identify a particular geographic region or location associated with an account of user 110 (or alternatively, with user 110) based on notification rules, indicator rubrics, and/or profile data specified by user 110 using any of the techniques described above. In one aspects, client device 104 may determine its current geographic position (e.g., based GPS information), and may relay or push portions of the account status notification information to eligible devices when the current geographic position falls within a threshold distance of the particular geographic region or location. In other aspects, client device 104 may receive positional data identifying current geographic positions of eligible devices within environment 100 (e.g., when establishing or confirming communications sessions between client device 104 and the eligible devices). Additionally or alternative, client device 104 may relay or push portions of the account status notification information to eligible devices whose current geographic position falls within the threshold distance of the particular geographic region or location.



The disclosed embodiments may also enable client device **104** to selectively relay or push portions of received account status notification information to one or more eligible connected devices operating within computing environment **100** without input of intervention from user **110**. For example, system **140** may be configured to monitor a status of one or more accounts held by user **110**, and upon detection of a change in an actual or effective account parameter (e.g., a change in an actual balance of user **110**'s checking account based on a purchase of a good or service, or a change in an effective balance of user **110**'s credit card account and loyalty program account in response to a potential purchase of a good or service), system **140** may generate and provide account status notification information to client device **104**.

In certain aspects, client device **104** may be configured to receive the account status notification information, generate visual, audible, and/or or tactile account status indicators based on corresponding notification rules and indicator rubrics, and present the generated account status indicators to user **110** using any of the exemplary techniques outlined above. In other aspects, however, client device **104** may be incapable of presenting at least one of the visual, audible, and/or tactile account status indicators to user **110**. For instance, user **110** may configure client device **104** in an inactive state that powers down or reduces a functionality of a corresponding display screen, speaker, and/or vibratory output (e.g., by placing the client device in a standby mode). While client device **104** may be capable of processing account status notification information received from system **140**, client device **104** may be incapable of presenting the corresponding account status indicator(s) to user **110**. Client device **104** may, in certain embodiments, execute software processes that detect the reduced visual, auditory, and/or tactile functionality, and in response to the detection, identify and establish communications with one or more eligible connected devices, generate device-specific notifications tailored to access and indicator types associated with the eligible connected devices, and transmit the generated device-specific notifications to the eligible connected devices without user **110**'s input or intervention.

By way of example, client device **104** may receive account status notification information indicating that a potential purchase of a good or service would reduce an effective balance of user **110**'s checking account below a user-specified threshold. The received account status notification information may, in some instances, specify that client device **104** generate and present to user **110** a graphical status bar indicator that conveys a current effective account balance of user **110**'s checking account and further, a visual status bar colored red and indicating a relationship between the current effective account balance and the user-specified threshold.

In some aspects, client device **104** may determine that a current device status (e.g., in standby mode, etc.) renders client device **104** incapable of presenting an account status indicator reflecting the current effective balance of user **110**'s checking account. In response to the determination, client device **104** may access connected device information stored within a corresponding data structure (e.g., data structure **1000** of FIG. **10**), and may determine that a computing device disposed within user **110**'s Mini Cooper™ (e.g., a "connected" Mini Cooper™) and a "connected" lighting system disposed within user **110**'s home are eligible to receive account status notifications and present account status indicators.

For example, user **110** and client device **104** may be disposed within user **110**'s home, and as described above,

user **110** may establish a communication session with the connected lighting system that, for example, may include multiple color light-emitting-diode (LED) lamps capable of presenting colored account status indicators to user **110**. In certain instances, client device **104** may determine a current geographic position of client device **104** (e.g., as a portion of received data responsive to a broadcast query message), and may attempt to establish communications when a current geographic position of client device **104** falls within a threshold, user-specified distance (e.g., within corresponding profile data) of the position associated with the connected lighting system. In other instances, the connected device information may establish a geographic position associated with the connected lighting system, and client device **104** may establish communications based on a proximity of client device **104** to the established geographic position.

Upon establishing the communications sessions with the connected lighting system (or upon identification of an existing communication session with client device **104**), client device **104** may perform any of the exemplary processes described above to generate a device-specific notification instructing the connected lighting system to present an account status indicator to user **110** that reflects the status of user **110**'s effective checking account balance. In certain aspects, client device **104** may determine (e.g., based on the connected device information) that user **110** specified an "Indirect" access type for the connected lighting system, further, that the connected lighting system is capable of generating and presenting a background color indicator indicative of user **110**'s effective checking account balance.

For example, the device-specific notification may instruct the connected lighting system to emit two pulse of red light having a pre-determined duration or frequency (e.g., as specified by user **110** within notification rules or indicator rubrics, or alternatively, based on the connected device information) to indicate the current effective balance of user **110**'s checking account falls below the user-specified threshold. In alternate embodiments, the generated device-specific notification may instruct the connected lighting system to present a pulse of green light having a predetermined duration or frequency when the effective account balance remains above the user-specified threshold, and/or a pulse of yellow light having predetermined duration or frequency when the effective account balance falls within a predetermined or user-specified range of the threshold.

In certain instances, client device **104** may transmit the generated device-specific notification to the connected lighting system, which may present an account status indicator reflective of the current effective account balance of user **110**'s checking account without user input or intervention using any of the exemplary techniques outlined above. In certain aspects, the connected lighting system may be configured to repeatedly present the account status indicator (e.g., the pulsing red light) until user **110** acknowledges the account status indicator (e.g., by turning off the connected lighting system or by providing input to a graphical user interface (GUI) presented by client device **104**). In other aspects, the connected lighting system may repeatedly present the account status interval during a predetermined time period (e.g., as specified by user **110** within the connected device information, notification rules, and/or indicator rubrics), and additionally or alternatively, until a current geographic position of client device **104** is no longer disposed within the threshold distance of the geographic position of the connected lighting system.



In certain instances, the connected lighting system may present the pulsing red light as an indicator to user 110 that the effective account balance of user 110's checking account falls below the threshold balance. User 110 may, for example, ignore the pulsing red light, and may exit the home and enter user 110's vehicle (e.g., a connected Mini Cooper™). In some embodiments, client device 104 may establish communications within the connected Mini Cooper™ (e.g., based on a determination that a current geographic position of client device 104 falls within the threshold distance of a geographic position of the connected Mini Cooper™), and may generate a device-specific notification that instructs the connected Mini Cooper™ to present an account status indicator reflective of the current effective balance of user 110's checking account.

For example, and using any of the exemplary techniques described above, client device 104 may determine that the connected Mini Cooper™ is associated with an "Authenticated" access type that enables access to include actual values of the account parameters and established threshold values. Further, by way of example, client device 104 may also determine that the connected Mini Cooper™ is capable of generating and presenting the colored status bar indicators specified within the account status notification information received from system 140.

In certain aspects, client device 104 may establish that the account status notification information received from system 140 is consistent with the access and indicator type established by user 110 for the connected Mini Cooper™, and may forward the received account status notification information to the connected Mini Cooper™ as a device-specific notification. By way of example, and in response to the device-specific notification, the connected Mini Cooper™ may be configured to generate a color-coded status bar that conveys a magnitude of user 110's current effective account balance and is colored red to convey that the current effective account balance falls below the user-specified threshold. The connected Mini Cooper™ may render the generated color-coded status bar for presentation to user 110 through a corresponding display unit (e.g., a touch-screen display or head-up display) without user input or intervention.

Using the exemplary techniques described above, client device 104, in conjunction with system 140, may generate and present indicators that reflect statuses of account parameters associated with one or more of accounts held by user 110. For instance, accounts consistent with the disclosed embodiments may include financial services accounts (e.g., checking accounts, savings accounts, brokerage accounts, investment accounts, credit card accounts, etc.), student meal plans, gift cards, store credit, wireless communications plans, or any other kind of account capable of maintaining a balance associated with system 140.

The disclosed embodiments are, however, not limited to techniques that generate and present visual, tactile, and audible indicators of accounts held by user 110. In other embodiments, client device 104 may generate and present visual, tactile, and audible indicators that alert user 110 to an upcoming deadline associated with an event. For example, user 110 may, via client device 104, establish profile data that specifies one or more events to be tracked by system 140, specifies one or more temporal intervals that trigger a generation of an event notification by system 140, and associated the event and/or the event notification with a corresponding indicator presentable by client device 104. When system 140 determines that a current date falls within the established temporal interval of an event deadline,

system 140 may generate and transmit event notification information to client device 104, as described below in reference to FIG. 12.

FIG. 12 illustrates an exemplary process 1200 for generated and providing event notification information to networked devices, consistent with disclosed embodiments. In one embodiment, a system (e.g., system 140) may be configured to access profile data associated with a corresponding user (e.g., user 110), and based on the accessed profile data, generate and transmit information that, when presented by a client device (e.g., client device 104), notifies user 110 of the deadline.

In certain aspects, system 140 may access profile data associated with user 110 (e.g., in step 1202). By way of example, the obtained profile data may identify one or more events specified by user 110, which may be associated with corresponding deadlines. In an embodiment, user 110 may specify the events and corresponding deadline by providing input to a graphical user interface (GUI) presented by client device 104. For instance, user 110 may specify an event corresponding to a mortgage payment, and may specify a payment due date that reoccurs on the 1<sup>st</sup> day of each month. In additional aspects, user 110 may, through the GUI, link an electronic calendar application to client device 104 (e.g., through a corresponding API) and automatically populate the user profile data within events and corresponding deadlines established by the electronic calendar application.

Further, in some instances, the obtained user profile data may identify one or more temporal intervals that mark dates on which system 140 should generate and provide an event notification to client device 104 for presentation to user 110. By way of example, user 110 may specify, through the GUI presented by client device 104, that system 140 should generate event notifications two weeks prior to the payment due date, one week prior to the payment due date, and one day prior to the payment due date.

In additional aspects, the obtained user profile data may also associate the one or more events with corresponding indicator types (e.g., glyph indicators, symbol indicators, image-based indicators, video-based indicators, audible indicators, etc.) and further, that associate a change to a visible, audible, or tactile characteristic of the indicator types with corresponding one or the temporal indicators. In some aspects, user 110's mortgage payment due date may be associated with a glyph indicator corresponding to a flashing green dollar sign presented two weeks prior to the due date, a flashing orange dollar sign presented one week prior to the due date, and a flashing red dollar sign presented one day prior to the due date. In other aspects, however, the obtained user profile data may specify a different indicator type for each combination of event, deadline, and temporal interval. By way of example, user 110 may associate a colored visual indicator (e.g., a green dollar sign) with a notification presented two weeks prior to the mortgage payment due date, may associate an animated indicator (e.g., including visual and audible elements) with a notification presented two weeks prior to the mortgage payment due date, and may associate an audible and tactile indicator with a notification presented one day prior to the mortgage payment due date. In further aspects, the indicator type may correspond to a text-based indicator that includes information identifying an initial time period in which the deadline falls (e.g., "two weeks"), which system 140 and/or client device 104 may modify as the deadline approaches (e.g., change "two weeks" to "one week," etc.).

The disclosed embodiments are not limited the above-described combinations of indicator types, events, and tem-



poral intervals, and in additional embodiments the obtained user profile data may associated any additional or alternate types of indicators or combinations of indicators types with events, deadlines, and/or temporal intervals. Furthermore, as described above, user 110 may identify the events, deadlines, corresponding temporal intervals, and associated indicators or combinations of indicators through a GUI presented by client device 104, which may collect the information input by user 110 as profile data, and which may transmit the profile data to system 140 for storage (e.g., within stored customer data 144A).

In certain aspects, system 140 may execute software processes that parse the obtained profile data to extract one or more temporal intervals specified by user 110, one or more of the events specified by user 110, and further, one or more of the deadlines associated with the specified events (e.g., in step 1204). By way of example, system 140 may determine that user 110 specified a deadline of Jan. 1, 2015, for an event corresponding to a monthly mortgage payment. Further, in some aspects, system 140 may be configured to identify one or more temporal intervals associated with a desired notification. For example, the temporal intervals may specify that user 110 desires a notification of the upcoming deadline two weeks prior to the deadline, one week prior to the deadline, and one day prior to the deadline.

System 140 may, in some instances, select one of the temporal intervals (e.g., in step 1206) and determine whether a current date falls within the temporal interval of the identified deadline (e.g., in step 1208). By way of example, system 140 may initially select the smallest temporal interval specified by user 110 within the corresponding user profile data (e.g., one day), and may determine whether the current date (i.e., December 31<sup>st</sup>) falls within the one-day temporal interval of the identified January 1<sup>st</sup> due date for the mortgage payment.

If system 140 determines that the current date does not fall within the selected temporal interval (e.g., step 1208; NO), system 140 may identify an additional event and corresponding deadline from the access user profile data (e.g., in step 1210). Exemplary process 1200 may pass back to step 1208, and system 140 may execute software processes that establish whether the current date falls within the selected temporal interval of the newly identified deadline.

If, however, system 140 determines that the current date falls within the temporal interval of the deadline for the mortgage payment (e.g., step 1208; YES), system 140 may execute software processes that identify an indicator type associated with the combination of event, deadline, and temporal interval (e.g., in step 1212). For instance, and as described above, system 140 may identify that user 110 specified that a flashing red dollar sign be presented within a notification that user 110's mortgage payment is due on the next calendar day. In some aspects, system 140 may be configured to generate event status notification information (e.g., in step 1214) that identifies the pending deadline of January 1<sup>st</sup>, identifies the event (e.g., a mortgage payment), and further, includes information instructing client device 104 to present the specified indicator type to user 110.

System 140 may be configured to transmit the generated event status notification information to client device 104 across network 120 using any of the communications protocols outlined above (e.g., in step 1216). Client device 104 may, in some instances, be configured to process the received information, generate the specified event status indicator (e.g., a flashing red dollar sign), and render the event status indicator for presentation to user 110. In certain aspects, the flashing red indicator, when presented by client

device 104, may draw user 110's attention to client device 104 may enable user 110 to confirm the timely submission of the mortgage payment.

In some aspects, and upon transmission of the event status notification information to client device 104, system 140 may determine whether the accessed user profile data includes additional events and corresponding deadlines (e.g., in step 1218). If system 140 determines that additional events and due dates requires processing (e.g., step 1218; YES), system 140 may execute software processes that identify an additional one of the remaining events and corresponding due dates, as described above (e.g., in step 1210).

If, however, system 140 determines that no additional events and corresponding due dates require analysis under the selected temporal interval (e.g., step 1218; NO), system 140 may determine in step 1220 whether additional temporal intervals within the user profile data require analysis. If additional temporal intervals require analysis (e.g., step 1220; YES), system 140 may select one of the additional temporal intervals (e.g., in step 1206), and system 140 may pass back to step 1208, at which time system 140 determines whether identified deadlines fall within the newly selected temporal interval. For instance, as described above, system 140 may initially select the most restrictive time interval specified within the user profile data (e.g., one day prior to a deadline), and upon processing each specified event and due date with respect to the most restrictive temporal interval, system 140 may select a less restrictive temporal interval in passing back to step 1206. Alternatively, if no additional temporal intervals require analysis, exemplary process 1200 is complete in step 1222.

Further, in some aspects, system 140's selection of a temporal interval, and the processing of user-established events and deadlines based on that interval, may be updated at period, regular, and/or user-specified intervals. For instance, user 110 may establish, via a GUI presented by client device 104, and that the exemplary event notification generation and presentation techniques outlined above may be updated and reinitiated every hour, day, etc. In certain aspects, the user-specified interval may define a position of a notification rule, indicator rubric, and/or profile data.

The disclosed embodiments may enable client device 104 to present a graphical, audible, and/or tactile notification of a current date's proximity to a deadline for a user-established event. In some aspects, client device 104 and/or system 140 may generate and present the event status notification using any of the exemplary techniques described above. For instance, a device component of client device 104 (e.g., an OHMD or heads-up display) may present one or more of the disclosed event status indicators as an AR view that "pops-up" into user 110's field-of-view using the techniques described above. Further, in some aspects, client device 104 may perform one or more of the exemplary techniques described above to identify one or more devices eligible to receive event notifications, and to transmit or "push" the receive at least a portion of event notification information to the eligible device for presentation. In additional embodiments, client device 104 and/or system 140 may determine whether to present the event status indicators to user 110 based on geographic locations or regions associated with user 110, an event, and/or specified within at least one notification rule or indicator rubric. For instance, client device 104 and/or system 140 may perform one or more of the exemplary processes described above to identify a geographic location of region associated with the user or an event (e.g., as specified by the user within at least one



notification rule), and to present a corresponding event status indicator when the user's geographic position falls within a threshold distance of the geographic location of the user and/or the event. In other aspects, the disclosed embodiments may enable client device **104** and/or system **140** to generate, present, and subsequently modify a presentation of not only event status indicators, but also account status indicators. For instance, client device **104** and/or system **140** may generate, present, and modify one or more account status indicators associated with corresponding parameters of accounts held by or associated with user **110** (and others associated with user **110**) using any of the exemplary techniques described above. In some aspects, using one or more of the exemplar techniques described above, client device **104** and system **140** may generate, present, and modify one or more event status indicators corresponding user-specified events and deadlines. In certain embodiments, client device **104** may present one or more of the account status indicators to user **110** simultaneously with the event status indicators. For example, client device **104** may present first and second account status indicators, and/or event status indicators as concentric-ring indicators surrounding an object within a field-of-view of user **110**, as described above.

Other embodiments will be apparent to those skilled in the art from consideration of the specification and practice of the embodiments disclosed herein. It is intended that the specification and examples be considered as exemplary only, with a true scope and spirit of the disclosed embodiments being indicated by the following claims.

What is claimed is:

**1.** A communications device, comprising:

a storage device; and

at least one processor coupled to the storage device, the storage device storing software instructions for controlling the at least one processor when executed by the at least one processor, the at least one processor being operative with the software instructions and being configured to:

receive, from a computing system across a communications network, first notification information indicative of a status of a parameter of an account of a user, the first notification information being generated by the computing system based on at least one notification rule and account information associated with the user account;

detect an operational mode of the communications device, the detected operational mode being associated with a reduction in at least one of a visual, audible, or tactile functionality of the communications device;

determine that the reduction in the at least one of the visual, audible, or tactile functionality renders the communications device incapable of presenting at least one of a visual, audible, or tactile indicator of the status of the account parameter to the user;

in response to the determination, detect an additional device connected to the communications device through a corresponding communications session;

obtain device information identifying at least one type of data accessible to the additional device and an indicator type consistent with at least one device characteristic of the additional device, the at least one accessible data type being specified by the user, and the indicator type comprising at least one of a graphical status bar, a dynamic graphical icon, or a glyph;

generate second notification information for transmission to the additional device, the second notification information comprising at least a portion of the first notification information, the portion being consistent with the at least one accessible data type; and

transmit the second notification information to the additional device without receiving input from the user, the second notification information instructing the additional device to present the at least one of the visual, audible, or tactile status indicator to the user through a corresponding interface, the at least one presented visual, audible, or tactile status indicator bring consistent with the indicator type.

**2.** The communications device of claim **1**, wherein the obtained device information identifies a plurality of candidate devices permitted to access the first notification information in accordance with corresponding accessible data types.

**3.** The communications device of claim **2**, wherein the at least one processor is further configured to:

generate a graphical configuration interface based on configuration information received by the communications device;

present the graphical configuration interface to the user via a device component; and

receive, as input to the graphical configuration interface, data specifying at least one of the candidate devices and at least one of the corresponding accessible data types.

**4.** The communications device of claim **3**, wherein:

the obtained device information identifies an indicator type, the indicator type being consistent with at least one device characteristic of the additional device; and the at least one processor is further configured to receive, as input to the configuration interface, data specifying the indicator type.

**5.** The communications device of claim **2**, wherein the at least one processor is further configured to:

determine that a subset of the candidate devices are capable of establishing an additional communications session with the communications device; and

in response to the determination, establish the additional communication session with at least one of the subset of candidate devices as the additional device.

**6.** The communications device of claim **1**, wherein the account parameter comprises at least one of:

an actual balance of the user account;

an effective account balance that reflects whether the actual account balance can accommodate a potential purchase of a product or service from a merchant;

a predictive account parameter that reflects a predicted balance of the user account based on at least one prior payment;

a balance of a loyalty program associated with the user account corresponding one of the first or second accounts; or

a potential balance of the loyalty program that reflects a potential purchase of the product or service from the merchant.

**7.** The communications device of claim **1**, wherein the first notification information comprises (i) first data specifying at least one value of the user account parameter and a value of a user-specified parameter criterion, and (ii) second data indicative of a relationship between the at least one user account parameter value and the user-specified parameter criterion value.



57

8. The communications device of claim 7, wherein:  
the second data is consistent with the at least one accessible data type; and  
the at least one processor is further configured to:  
filter the first notification information to remove the first data from the first notification information; and  
establish the second data as at least a portion of the second notification information.
9. The communications device of claim 7, wherein the additional device comprises at least one of a first device disposed within a motor vehicle of the user or a second device disposed within a home of the user.
10. The communications device of claim 1, wherein:  
the at least one notification rule associates a geographic region with the user account; and  
the at least one processor is further configured to:  
determine whether a geographic position of the additional device falls within a threshold distance of the associated geographic region; and  
when the geographic position of the additional device is determined to fall within the threshold distance, transmit the second notification information to the additional device.
11. The communications device of claim 1, wherein the at least one processor is further configured to:  
obtain product information associated with a product offered for sale by a merchant; and  
modify the second notification information to reflect a change in the status of the user account parameter, the change reflecting a potential purchase of the product by the user; and  
transmit the modified second notification information to the additional device without receiving input from the user, the modified second notification information instructing the additional device to modify at least one of a visual, audible, or tactile characteristic of the presented account status indicator to reflect the potential purchase of the product.
12. The communications device of claim 1, wherein the at least one processor is further configured to:  
receive third notification information for the user account, the third notification information being indicative of a change in the status of the user account parameter, the change reflecting at least one of a potential or actual purchase of a product by the user; and  
transmit at least a portion of the third notification information to the additional device without receiving input from the user, the transmitted portion being consistent with the at least one data restriction, and the transmitted provided portion instructing the additional eligible device modify at least one of a visual, audible, or tactile characteristic of the presented account status indicator to reflect the at least one potential or actual purchase of the product.
13. The communication device of claim 1, wherein the at least one processor is further configured to receive the first notification information at predetermined intervals.
14. The communication device of claim 1, wherein the at least one processor is further configured to:  
modify the second notification information to include the indicator type; and  
transmit the modified second notification information to the additional device without receiving input from the user, the modified second notification information instructing the additional device to present, to the user, an indicator of the status of the user account parameter in accordance with the indicator type.

58

15. The communications device of claim 1, wherein:  
the at least one processor is further configured to modify at least a portion of the first notification information in accordance with the obtained device information, the modified portion of first notification information being consistent with the at least one accessible data type; and  
the generated second notification comprises the modified portion of first notification information.
16. A computer-implemented method, comprising:  
receiving, by at least one processor of a communications device, first notification information for indicative of a status of a parameter of an account of a user from a computing system across a communications network, the first notification information being generated by the computing system based on at least one notification rule and account information associated with the user account;  
detecting, by the at least one processor, an operational mode of the communications device, the detected operational mode being associated with a reduction in at least one of a visual, audible, or tactile functionality of the communications device;  
determining, by the at least one processor, that the reduction in the at least one of the visual, audible, or tactile functionality renders the communications device incapable of presenting at least one of a visual, audible, or tactile indicator of the status of the account parameter to the user;  
in response to the determination, detecting, by the at least one processor, an additional device connected to the communications device through a corresponding communications session;  
obtaining, by the at least one processor, device information at least one type of data accessible to the additional device and an indicator type consistent with at least one device characteristic of the additional device, the at least one accessible data type being specified by the user, and the indicator type comprising at least one of a graphical status bar, a dynamic graphical icon, or a glyph;  
generating, by the at least one processor, second notification information for transmission to the additional device, the second notification information comprising at least a portion of the first notification information, the portion being consistent with the at least one accessible data type; and  
transmitting, by the at least one processor, the second notification information to the additional device without receiving input from the user, the second notification information instructing the additional device to present the at least one of the visual, audible, or tactile status indicator to the user through a corresponding interface, the at least one presented visual, audible, or tactile status indicator being consistent with the indicator type.
17. The method of claim 16, wherein the obtained device information identifies a plurality of candidate devices permitted to access the first notification information in accordance with corresponding accessible data types.
18. The method of claim 17, further comprising:  
generating a graphical configuration interface based on configuration information received by the communications device; and  
presenting the graphical configuration interface to the user via a device component; and



59

receiving, as input to the configuration interface, data specifying at least one of the candidate devices and at least one of the corresponding accessible data types.

**19.** The method of claim **17**, further comprising:

determining that a subset of the candidate devices are capable of establishing an additional communications session with the communications device; and in response to the determination, establishing the additional communication session with at least one of the subset of candidate devices as the additional device.

**20.** The method of claim **16**, wherein the account parameter comprises at least one of:

an actual balance of the user account;  
 an effective account balance that reflects whether the actual account balance can accommodate a potential purchase of a product or service from a merchant;  
 a predictive account parameter that reflects a predicted balance of the user account based on at least one prior payment;  
 a balance of a loyalty program associated with the user account corresponding one of the first or second accounts; or  
 a potential balance of the loyalty program that reflects a potential purchase of the product or service from the merchant.

**21.** The method of claim **16**, wherein the first notification information comprises (i) first data specifying at least one value of the user account parameter and a value of a user-specified parameter criterion, and (ii) second data indicative of a relationship between the at least one user account parameter value and the user-specified parameter criterion value.

**22.** The method of claim **21**, wherein:

the second data is consistent with the at least one accessible data type; and

the method further comprises:

filtering the first notification information to remove the first data from the first notification information; and establishing the second data as at least a portion of the second notification information.

**23.** The method of claim **16**, wherein:

the at least one notification rule comprises associates a geographic region with the user account; and the method further comprises:

determining whether a geographic position of the additional device falls within a threshold distance of the associated geographic region; and when the geographic position of the additional device is determined to fall within the threshold distance, transmitting the identified portion of the first notification information to the additional device.

**24.** The method of claim **16**, further comprising:

obtaining product information associated with a product offered for sale by a merchant; and

modifying the second notification information portion to reflect a change in the status of the user account parameter, the change reflecting a potential purchase of the product by the user; and

transmitting the modified second notification information to the additional device without receiving input from the user, the modified first notification information instructing the additional device to modify at least one of a visual, audible, or tactile characteristic of the presented account status indicator to reflect the potential purchase of the product.

60

**25.** The method of claim **16**, further comprising:

receiving third notification information for the user account, the third notification information being indicative of a change in the status of the user account parameter, the change reflecting at least one of a potential or actual purchase of a product by the user; and;

transmitting at least a portion of the third notification information to the additional device without receiving input from the user, the transmitted portion being consistent with the at least one restriction, and the transmitted portion instructing the additional device modify at least one of a visual, audible, or tactile characteristic of the presented account status indicator to reflect the at least one potential or actual purchase of the product.

**26.** The method of claim **16**, wherein the device information identifies an indicator type, the indicator type being consistent with at least one device characteristic of the additional device.

**27.** The method of claim **16** further comprising:

modifying the second notification information to include the indicator type; and

transmitting the modified second notification information to the additional device without receiving input from the user, the modified second notification information instructing the additional device to present, to the user, an indicator of the status of the user account parameter in accordance with the indicator type.

**28.** A tangible, non-transitory computer-readable medium storing instructions that, when executed by at least one processor, perform a method comprising the steps of:

receiving, at a communications device, first notification information indicative of a status of a parameter of an account of a user from a computing system across a communications network, the first notification information being generated by the computing system based on at least one notification rule and account information associated with the user account;

detecting an operational mode of the communications device, the detected operational mode being associated with a reduction in at least one of a visual, audible, or tactile functionality of the communications device;

determining that the reduction in the at least one of the visual, audible, or tactile functionality renders the communications device incapable of presenting at least one of a visual, audible, or tactile indicator of the status of the account parameter to the user;

in response to the determination, detecting an additional device connected to the communications device through a corresponding communications session;

obtaining device information at least one type of data accessible to the additional device and an indicator type consistent with at least one device characteristic of the additional device, the at least one accessible data type being specified by the user, and the indicator type comprising at least one of a graphical status bar, a dynamic graphical icon, or a glyph;

generating second notification information for transmission to the additional device, the second notification information comprising at least a portion of the first notification information, the portion being consistent with the at least one accessible data type; and

transmitting the second notification information to the additional device without receiving input from the user, the second notification information instructing the additional device to present the at least one of the visual, audible, or tactile status indicator to the user



through a corresponding interface, the at least one presented visual, audible, or tactile status indicator bring consistent with the indicator type.

\* \* \* \* \*