



US009880978B2

(12) **United States Patent**
Duga et al.

(10) **Patent No.:** **US 9,880,978 B2**
(45) **Date of Patent:** **Jan. 30, 2018**

(54) **SYSTEM AND METHOD FOR SELECTIVE CONTROL OF ZOOM ADJUSTMENTS IN AN ELECTRONIC PUBLICATION**

(71) Applicant: **Google Inc.**, Mountain View, CA (US)

(72) Inventors: **Brady Duga**, Carlsbad, CA (US);
Garth Conboy, La Jolla, CA (US);
William Leshner, San Diego, CA (US);
John Rivlin, Palo Alto, CA (US);
Vincent Le Chevalier, San Jose, CA (US)

(73) Assignee: **Google LLC**, Mountain View, CA (US)

(*) Notice: Subject to any disclaimer, the term of this patent is extended or adjusted under 35 U.S.C. 154(b) by 576 days.

(21) Appl. No.: **14/450,696**

(22) Filed: **Aug. 4, 2014**

(65) **Prior Publication Data**

US 2014/0344676 A1 Nov. 20, 2014

Related U.S. Application Data

(63) Continuation of application No. 12/563,498, filed on Sep. 21, 2009, now Pat. No. 8,832,548.

(51) **Int. Cl.**

G06F 3/0481 (2013.01)
G06F 17/21 (2006.01)

(Continued)

(52) **U.S. Cl.**

CPC **G06F 17/211** (2013.01); **G06F 3/0481** (2013.01); **G06F 17/212** (2013.01);
(Continued)

(58) **Field of Classification Search**

CPC .. G06F 3/0485; G06F 3/04845; G06F 3/0482;
G06F 17/211; G06F 17/212; G06F 2203/04806; G06F 17/30274

See application file for complete search history.

(56) **References Cited**

U.S. PATENT DOCUMENTS

7,434,174 B2 * 10/2008 Sellers G06F 3/0481
715/765

7,627,814 B1 12/2009 Soldan et al.
(Continued)

OTHER PUBLICATIONS

Communication pursuant to Article 94(3) EPC for European Patent Application No. EP 10818016.7, dated Jun. 17, 2016, 7 Pages.

(Continued)

Primary Examiner — Tadeese Hailu

(74) *Attorney, Agent, or Firm* — Shumaker & Sieffert, P.A.

(57) **ABSTRACT**

A system and method for selective control of zoom adjustments in an electronic publication is disclosed. The method may include generating content for display on an electronic reading device; generating at least one style for the content, and storing the content and the at least one style on a computer readable medium. The generation of at least one style may include identifying at least a portion of the content for which at least one zoom level will be specified; specifying a base text size for the portion of the content; and specifying a first value to increment the base text size to a first zoom state text size. A method for rendering an electronic document on an electronic device may include storing content representing an electronic publication in a computer memory of the electronic device, the content including at least one style for a portion of the content, the at least one style including a base text size for the portion of the content and at least a first value to increment the base text size to a first zoom state text size; rendering the contents according to the at least one style; and incrementing the base text size for the portion of the content by the first value in response to a user input to zoom.

19 Claims, 6 Drawing Sheets

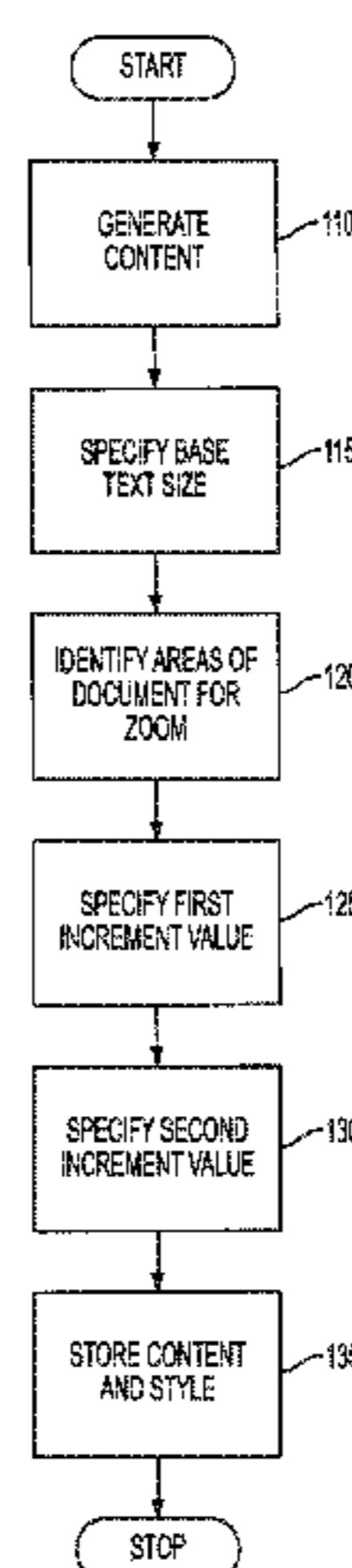

- (51) **Int. Cl.**
G06F 17/30 (2006.01)
G06F 17/22 (2006.01)
- (52) **U.S. Cl.**
 CPC *G06F 17/2247* (2013.01); *G06F 17/30905*
 (2013.01); *G06F 2203/04806* (2013.01)

(56) **References Cited**

U.S. PATENT DOCUMENTS

2003/0095135	A1	5/2003	Kaasila et al.	
2003/0187744	A1	10/2003	Goodridge	
2004/0103371	A1	5/2004	Chen et al.	
2005/0071364	A1*	3/2005	Xie	G06F 17/30905
2005/0198571	A1	9/2005	Kramer et al.	
2006/0195784	A1	8/2006	Koivisto et al.	
2007/0079236	A1	4/2007	Schrier et al.	
2007/0150829	A1*	6/2007	Eschbach	G06F 17/211 715/781
2008/0022197	A1	1/2008	Barger et al.	
2008/0077880	A1	3/2008	Oygar	
2008/0082911	A1	4/2008	Sorotokin et al.	
2008/0209533	A1	8/2008	Abrams et al.	
2008/0235585	A1	9/2008	Hart et al.	
2008/0301545	A1	12/2008	Zhang et al.	
2009/0089448	A1	4/2009	Sze et al.	
2009/0150766	A1	6/2009	Fukuda et al.	
2009/0189920	A1	7/2009	Chiu et al.	
2009/0198767	A1	8/2009	Jakobson et al.	
2009/0225086	A1	9/2009	Tomida	
2009/0319888	A1	12/2009	Oygar	
2010/0315326	A1	12/2010	Le Chevalier et al.	
2010/0315399	A1	12/2010	Jacobson et al.	
2010/0325529	A1	12/2010	Sun	

OTHER PUBLICATIONS

PCT International Preliminary Report and Written Opinion dated Apr. 5, 2012 for International Application No. PCT/ US2010/ 049633.

United States Office Action for U.S. Appl. No. 12/563,498, dated Dec. 13, 2011, 13 pages.

United States Office Action for U.S. Appl. No. 12/563,498, dated Apr. 18, 2012, 17 pages.

Rutter, R., "How to Size Text Using ems," Clagnut, May 18, 2004, 4 pages [online] [retrieved on May 28, 2015] Retrieved from the Internet <URL:http://clagnut.com/blog/348/>.

Walsh, D., "Change Text Size on Click With Javascript," Archived on web.archive.org on Sep. 17, 2009, 7 Pages, [online][retrieved on May 28, 2015] Retrieved from the Internet <URL: http://web.archive.org/web/20090917025223/http://davidwalsh.name/change-text-size-on-click-with-javascript>.

"CSS—Increase Page Font Size [duplicate]," Stack Overflow, Sep. 6, 2009, 2 pages, pages [online] [retrieved on May 28, 2015] Retrieved from the Internet <URL:http://stackoverflow.com/questions/1386531/css-increase-pages-font-size>.

Extended European Search Report for European Patent Application No. EP 10818016.7, dated Jun. 5, 2015, 6 Pages.

Summons to Attend Oral Proceedings Pursuant to Rule 115(1) EPC for European Patent Application No. EP10818016.7, Mar. 1, 2017, 6 Pages.

"Cascading Style Sheets Level 2 Revision 1 (CSS 2.1) Specification", W3C Jun. 7, 2011, 430 pps.

Notice of Intent to Grant and Text Intended to Grant from European Application No. 10818016.7, dated Oct. 27, 2017, 36 pages.

* cited by examiner

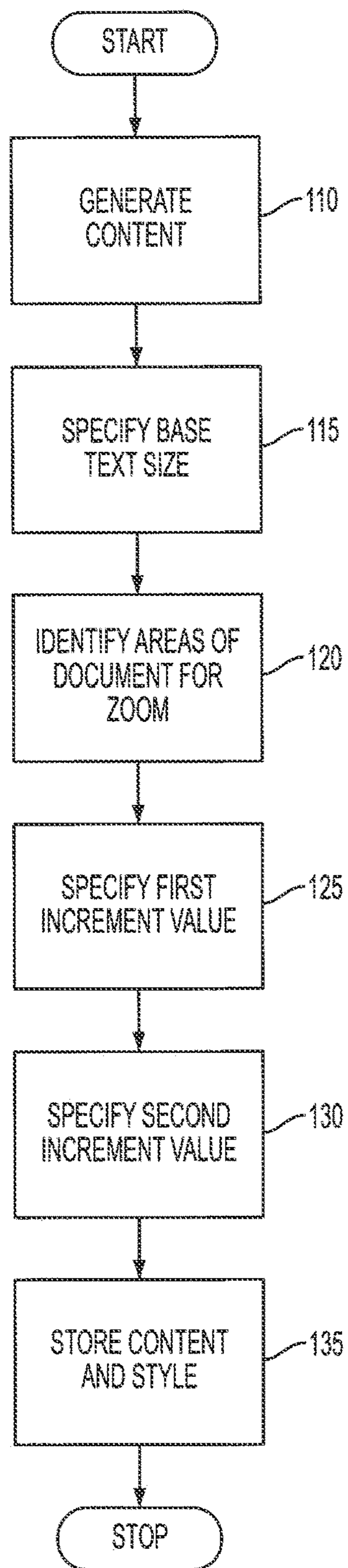

FIG. 1

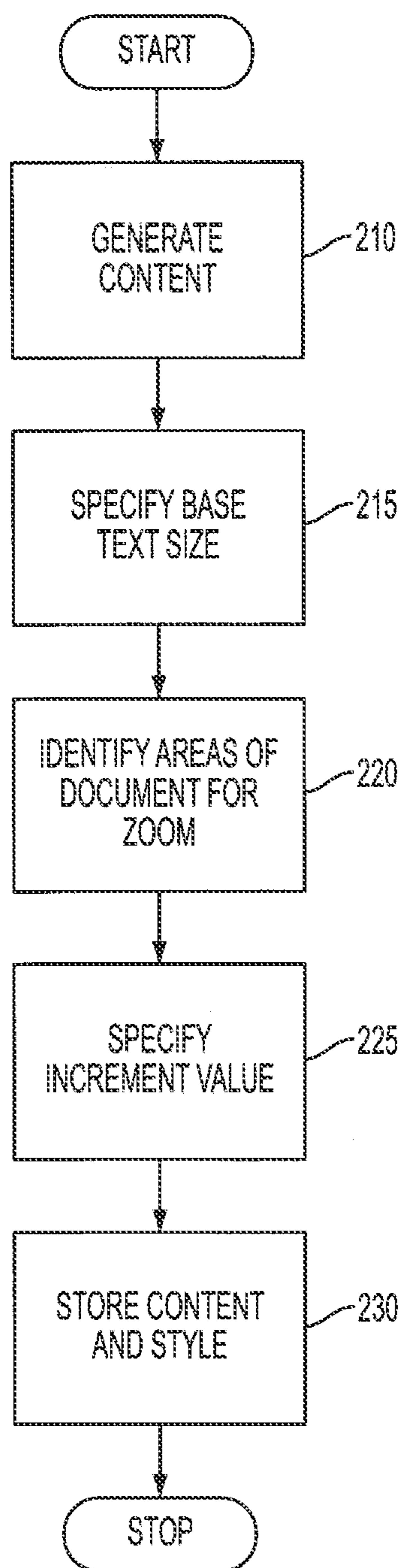

FIG. 2

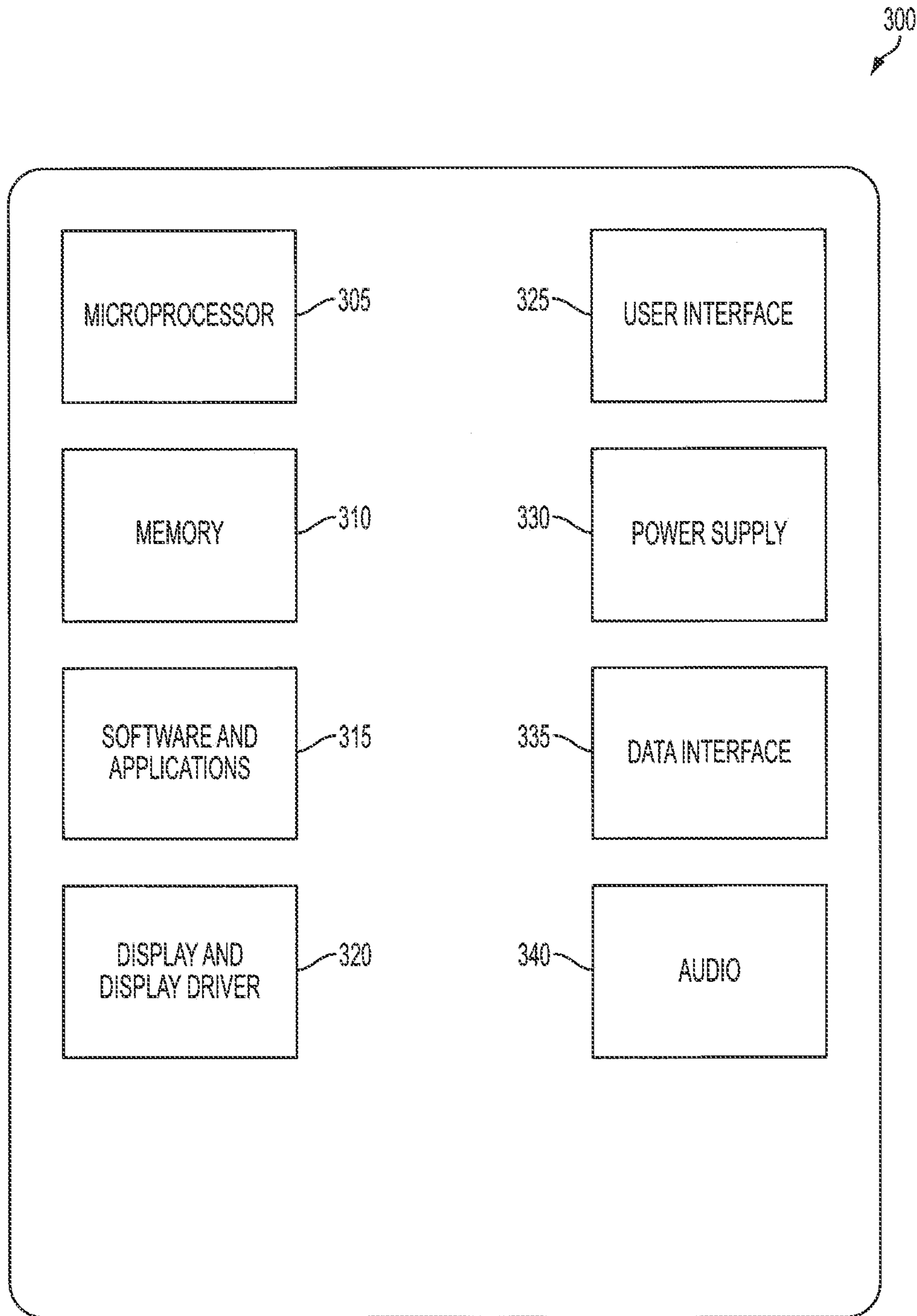

FIG. 3

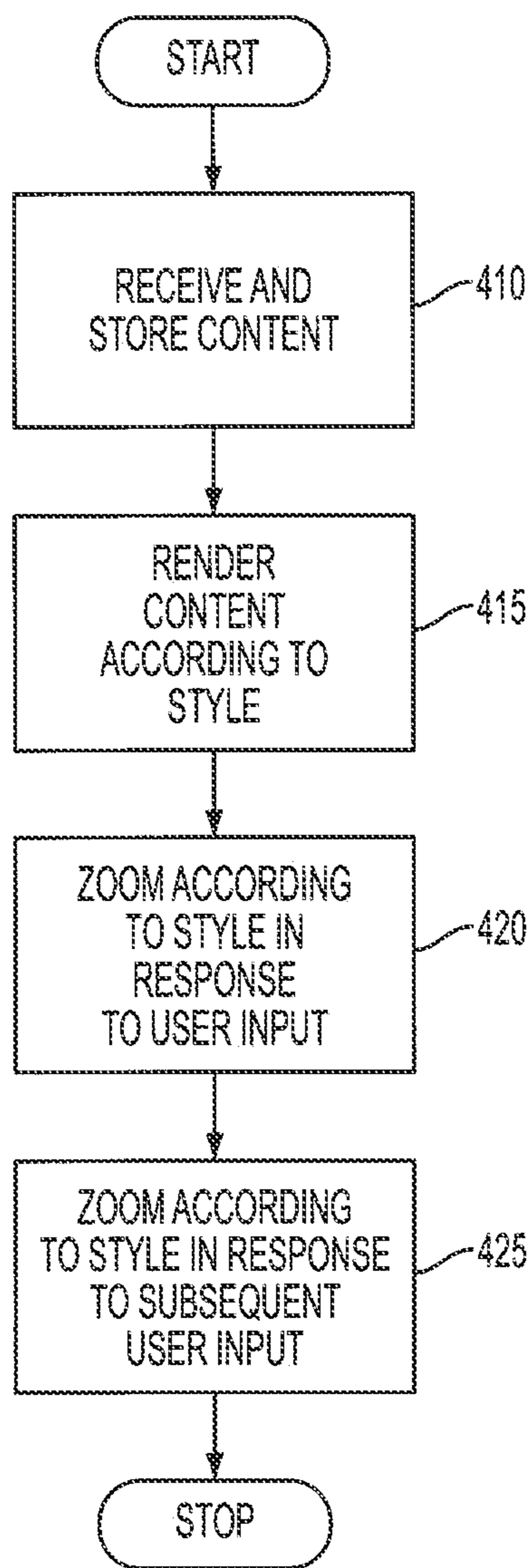

FIG. 4



Sections

Front Page

Wednesday, January 7, 2009 - 6:16am

Russia Cuts Gas; Europe Shivers

In one sign of the extent of the shutoff, Ukraine's president, Viktor A. Yushchenko, said Gazprom intended to halt all shipments passing through his country, which account for about 80 percent of Russian gas exports to Europe. Europe, in turn, depends on Russia for 40 percent of its imported fuel.

While each side blamed the other for the scope of the latest drop in gas shipments, Russia's prime minister, Vladimir V. Putin, had personally announced Monday evening on state television that he was ordering a sharp reduction in gas flows, saying Ukraine was siphoning gas from the pipelines without paying.

For Mr. Putin, the escalation comes at a perilous time, as slumping energy prices threaten the fiscal health and political stability that have underpinned his popularity at home.

Some analysts of Russian politics had expected Mr. Putin to become more conciliatory as energy prices fell. Instead, he has taken a hard line in seeking to raise gas prices in Ukraine and perhaps create panic-buying on the international market,

Pool photo by Alexei Druzhinin Prime Minister Vladimir V. Putin of Russia conferring Tuesday with the chief executive of Gazprom, Aleksei B. Miller. Gazprom said Ukraine had shut the gas pipeline. Ukraine denied it.

By ANDREW E. KRAMER

MOSCOW - Gazprom, the Russian gas monopoly, halted nearly all its natural gas exports to Europe on Tuesday, sharply escalating its pricing dispute with neighboring Ukraine. The cutoff led to immediate shortages from France to Turkey and underscored Moscow's increasingly confrontational posture toward the West.

Across Europe, countries reported precipitous drops in gas pressure in their pipelines at the peak of the winter heating season in a bitterly cold January.

PREVIOUS
ARTICLE 1 of 53
NEXT

FIG. 5

	<input data-bbox="1382 608 1692 650" type="text"/>	
Sections	Front Page	
Wednesday, January 7, 2009 - 6:16am		
Russia Cuts Gas; Europe Shivers		
	neighboring Ukraine. The cutoff led to immediate shortages from France to Turkey and underscored Moscow's increasingly confrontational posture toward the West.	
Pool photo by Alexei Druzhinin Prime Minister Vladimir V. Putin of Russia conferring Tuesday with the chief of Gazprom, Aleksei B. Miller. Gazprom said Ukraine had shut the gas pipeline. Ukraine denied it.	Across Europe, countries reported precipitous drops in gas pressure in their pipelines at the peak of the winter heating season in a bitterly cold January.	
By ANDREW E. KRAMER	In one sign of the extent of the shutoff, Ukraine's president, Viktor A. Yushchenko, said Gazprom intended to halt all shipments passing through his country, which account for about 80 percent of Russian gas exports to Europe.	
MOSCOW - Gazprom, the Russian gas monopoly, halted nearly all its natural gas exports to Europe on Tuesday, sharply escalating its pricing dispute with		
<input type="checkbox"/> PREVIOUS	ARTICLE 1 of 53	NEXT <input type="checkbox"/>

FIG. 6

1

SYSTEM AND METHOD FOR SELECTIVE CONTROL OF ZOOM ADJUSTMENTS IN AN ELECTRONIC PUBLICATION

CROSS-REFERENCE TO RELATED APPLICATION

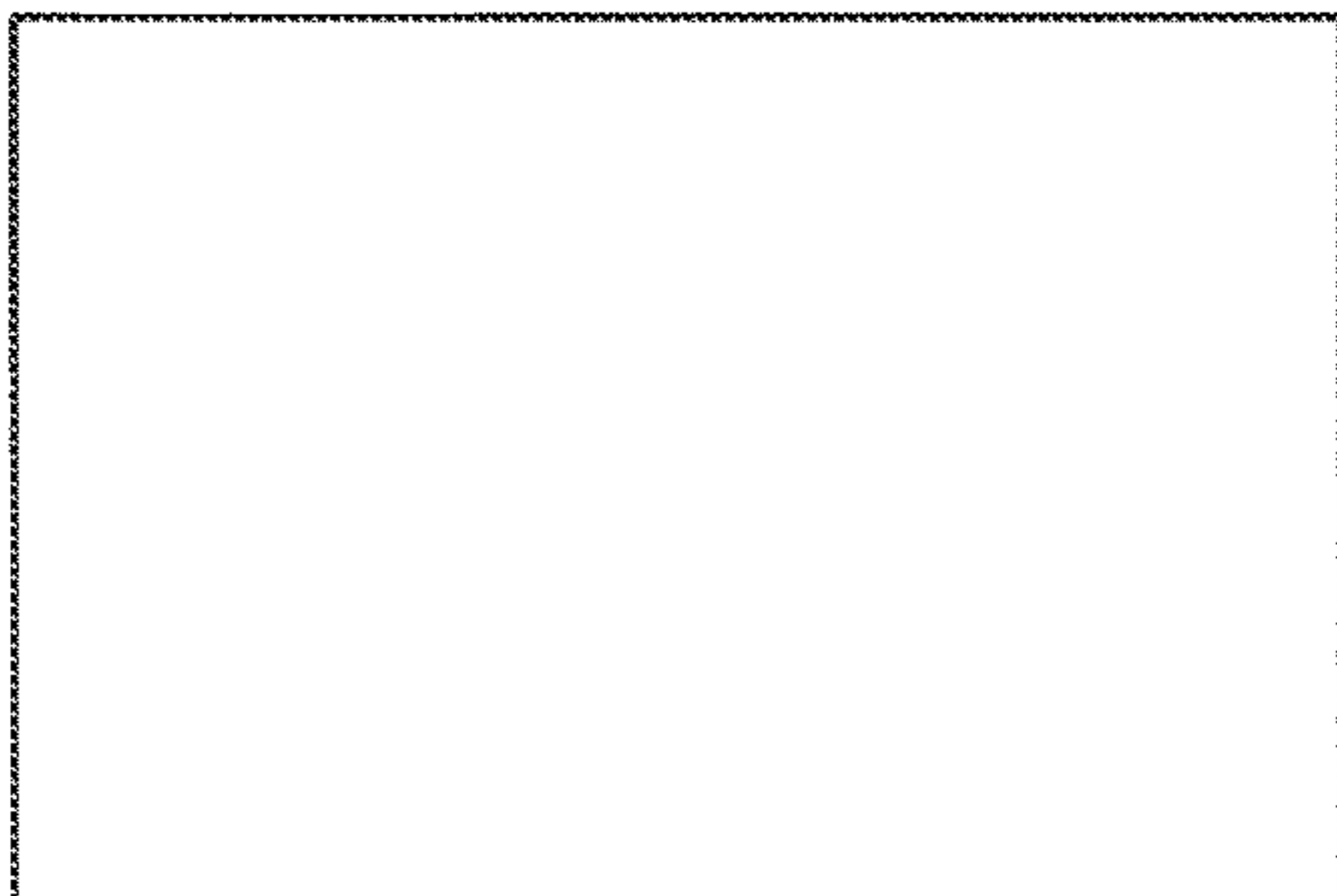
This application claims the benefit of U.S. application Ser. No. 12/563,498, filed Sep. 21, 2009, entitled "System and Method for Selective Control of Zoom Adjustments in an Electronic Publication," which is incorporated herein by reference in its entirety.

BACKGROUND INFORMATION

One of the benefits of using reflowable text (e.g., text that automatically wraps words to the next line as the user changes window size and thereby relocates the right margin of the page) in electronic publications is that display properties can be changed to suit a user's preferences. A common use of this control is to change the size of text when rendering the electronic publication. As the size of the text increases, words can be "forced" from the right margin to the next line.

Many electronic book ("eBook") applications limit the number of text sizes that a user may select to a fixed number (for instance, small, medium and large), although the actual number of potential text sizes may be much greater. This is because allowing users such control over the display of content causes a dilemma for those tasked with designing content—such as content creators and content editors—to be rendered. While certain areas of content may have no issues being viewed in multiple sizes, other areas of the same content may not be as simple to change. For example, an electronic newspaper may have a complex layout to the front page. While full article pages can easily be zoomed, a complex front page with multiple stories in small boxes may become entirely unreadable when text size is changed.

For such complex layouts, prior efforts have taken two approaches. The first is to simply forbid text size changes. An example of this approach is the Portable Document Format file format, or "PDF." Such an approach limits the usefulness of an electronic publication, by eliminating a desired feature. Producing multiple fixed-size documents to address user requirements (for instance a large print version for the visually impaired) is time-consuming, costly and creates problems for content distribution.

The other approach is to simply allow the user—the reader—full control over the content. While this approach can work, especially in an environment where the content is limited to a single "page" that can be scrolled, it does not work very well in complex layouts as all areas of a page may reflow.

BRIEF DESCRIPTION OF THE DRAWINGS

The present invention, together with further objects and advantages, may best be understood by reference to the following description taken in conjunction with the accompanying drawings, in the several figures of which like reference numerals identify like elements, and in which:

FIG. 1 is a flowchart depicting a method for selective control of zoom adjustments in an electronic publication according to one embodiment;

FIG. 2 is a flowchart depicting a method for selective control of zoom adjustments in an electronic publication according to one embodiment;

2

FIG. 3 is a block diagram of an electronic device according to one embodiment of the present invention;

FIG. 4 is a flowchart depicting a method for rendering electronic content on an electronic device according to one embodiment;

FIG. 5 is an example of a rendering of content at a base text size according to one embodiment; and

FIG. 6 is an example of a rendering of the content of FIG. 5 in response to a zoom instruction.

DETAILED DESCRIPTION OF PREFERRED EMBODIMENTS

Several embodiments of the present invention and their advantages may be understood by referring to FIGS. 1-6, wherein like reference numerals refer to like elements.

According to one embodiment, the present invention provides electronic publication authors, content creators and/or content editors with the ability to select complex layouts for content while still providing the user with the ability to customize his or her reading experience. Specifically, in one embodiment, the user is provided with the ability to zoom generic content, e.g., the text of an electronic publication, with little or no restrictions imposed by the content creator/editor. Further, the content creator/editor may identify areas of content (e.g., titles, headers, footers, etc.) for which zooming is not permitted and/or restricted. In one embodiment, the default zoom behavior may be altered by changing the zoom increment for each zoom state. In one embodiment, the content creator may be able to easily specify changes to the allowed sizes for large (e.g., the entire document) and small portions (e.g., one paragraph) of the content.

Cascading Style Sheets, or "CSS," is a style sheet language that allows authors and users to attach style, such as fonts and spacing, to structured documents. CSS allows the separation of the presentation style of documents from the content of documents. The Cascading Style Sheets Level 2 Revision 1 (CSS 2.1) Specification is hereby incorporated by reference in its entirety.

According to one embodiment, a new CSS property, called "-shadowbox-zoom-deltas", provides the content author and rendering software rich control of text size across multiple zoom states. Like other CSS properties, -shadowbox-zoom-deltas inherits to child elements and participates in the cascade. In one embodiment, elements that descend from an element that has this property will have the same value for the property unless otherwise specified.

The syntax for this property is:
shadowbox-zoom-deltas: [length|ems|exs]+
where length, ems and exs are as defined in the CSS specification.

In one embodiment, at least one value for length, ems, or exs must be provided. The value specifies the increment to add to the text size for the next zoom state. Thus, the first value specifies the amount to add or subtract to or from the base text size to get the value for the second zoom state. The second value is the amount to add or subtract to or from the second zoom state's total size to get the size of the third state. Additional values and zoom states may be provided as necessary and/or desired.

In one embodiment, the first value and/or the second value can have negative values. The negative first value will cause the text size to decrease in the first zoom state. Similarly, a negative second value will cause the text size to decrease in the second state.

For example, for a publication with three distinct zoom states (e.g., small, medium and large), and given these values:

-shadowbox-zoom-deltas: 2 pt 1 in;

if the original text had a font size of 12 points, the three zoom states would have the following values:

small: 12 pt

medium: 14 pt(12 pt+2 pt)

large: 86 pt(14 pt+1 in=14 pt+72 pt)

In the event that there are more zoom states than specified sizes, the remaining states use the last increment value. Given the same three zoom states above, an element with this setting:

-shadowbox-zoom-deltas: 2 pt;

Would have these sizes:

small: 12 pt

medium: 14 pt(12 pt+2 pt)

large: 16 pt(14 pt+2 pt)

In one embodiment, if there are more increments than zoom states, the remaining increments may be ignored.

The actual number of zoom states may be determined by, for example, the content creator, the user interface, the electronic reading device, etc.

In one embodiment, it may be desired to prevent an increment. To do this, 0 (zero, with or without a unit) may be supplied. For example, in the three zoom state case, to make the first and second states the same, but allow the third state to be 2 pt larger, the rule:

-shadowbox-zoom-deltas: 0 2 pt;
may be used.

In one embodiment, it may be desired to prevent zoom for a particular element, for example, in a repeating heading, footer, etc. The following may be used:

-shadowbox-zoom-deltas: Opt;

In one embodiment, because this property may inherit to child elements, the default zooming behavior for the entire electronic document may be altered with a single CSS rule.

For instance, to make all content zoom by 1 pt for every zoom state, the following CSS can be provided:

body {-shadowbox-zoom-deltas: 1 pt;}

In one embodiment, like any CSS property, shadowbox-zoom-deltas can be supplied in a separate style sheet, in the head section of a source document or directly on an element via the style attribute.

A specific block of text can have its size increment specified for every zoom state in a document. In addition, this increment can be applied to all remaining states. The increment can be any CSS value, including zero or negative values. This gives precise size control over elements at any zoom state.

Referring to FIG. 1, a method for selective control of zoom adjustments in an electronic publication according to one embodiment is disclosed. In step 110, content that is for display on an electronic display device is generated. Any sort of content may be provided. In one embodiment, an electronic publication may be provided. In another embodiment, an electronic book may be provided. In yet another embodiment, digital photographs may be provided. Any content that may be displayed for a user on an electronic display device may be used.

In one embodiment, the content may be provided from a third party, for example, a newspaper or book publisher, on-line publisher, etc. In another embodiment, the content may be generated at the same time that styles are identified.

In step 115, the base text size is specified. In one embodiment, the content may have multiple text sizes, and a selected portion may have multiple text sizes.

In step 120, at least one portion of the content that will have its zoom properties defined is identified. This may be any amount of the content, ranging from a small portion (e.g., a page number, title, etc.) to the entire content.

In step 125, a first increment value is set. In one embodiment, the first increment value may range from a negative increment size to a positive increment size specifying a desired increment size. If a negative value is set, the size of the text will decrease. If the value is set to zero, then the base text size will not be increased if the user attempts to zoom on the portion. If a positive value is set, the size of the text will increase. Other portions, however, that have a first increment set, will be zoomed by that value.

Any increment value may be used. In one embodiment, however, the size of the increments may range between 2 and 4 points.

In step 130, a second increment value may be set. In one embodiment, this is the additional amount over the first increment value. The second increment value may range from a negative value to a positive value specifying desired increment size. If the value is set to zero, then the base text size will not be increased beyond the first increment value if the user attempts a second zoom on the portion.

In one embodiment, if a second increment value is not set, then each successive zoom will increase the text size by the first increment value.

In one embodiment, the content creator/editor may specify the increment values for the content. In one embodiment, the content creator/editor may set a fixed number of zoom levels, ranging from one level (e.g., the base text size) to any desired number of levels. Therefore, although two increment values are described, a greater or fewer number of increment values may be used as necessary and/or desired.

Theoretically, there is no limit to the number of zoom states that may be used. Practically, however, the number of zoom states may be set to, for example, 3, 5, 10, etc. as necessary and/or desired.

In step 135, the content and style may be stored. In one embodiment, the content and style may be saved separately (e.g., one file for the content, a second file for the style sheet). In another embodiment, the style may be included in the head section of the content document or directly on an element via the style attribute.

The calculation of a zoom-state specific layout may be performed by a content layout engine. This may be run on a server at the time of content layout compilation. In another embodiment, the calculation of the zoom-state specific layout may be performed by the electronic reading device. Other methods and/or mechanisms for calculating the zoom-state specific layout may be used as necessary and/or desired.

Referring to FIG. 2, a method for selective control of zoom adjustments in an electronic publication using one increment value according to one embodiment is disclosed. In step 210, content that is for display on an electronic display device is generated. Similar to step 110, any sort of content may be provided.

In step 215, the base text size is specified. This is similar to step 115.

In step 220, at least one portion of the content that will have its zoom properties defined is identified. This is similar to step 120.

In step 225, an increment value is set. In one embodiment, the first increment value may range from a negative value to a positive value specifying a desired increment size. If a negative value is set, the size of the text will decrease. If the value is set to zero, then the base text size will not be increased if the user attempts to zoom on the portion. If a

5

positive value is set, the size of the text will increase. Other portions, however, that have a first increment set, will be zoomed by that value.

Additional increment values may be specified as necessary and/or desired.

In step **230**, the content and style may be stored. This is similar to step **135**.

The rendering of the content is performed by software executing on an electronic device. Suitable electronic devices include electronic reading devices, including electronic book readers, electronic newspaper readers, electronic paper readers, etc. An example of an electronic display device is disclosed in U.S. patent application Ser. No. 12/481,677, entitled "Flexible Electronic Device And Method Of Manufacture," the disclosure of which is incorporated by reference in its entirety. Other examples of electronic reading devices include the Amazon Kindle, the Sony Reader, and the Plastic Logic Reader.

Other examples of electronic devices include computers (desktop, notebook, laptop, tablet, etc.), personal digital assistants (PDAs), music players, telephones, etc. Any electronic device that is capable of rendering electronic content may be used as necessary and/or desired.

Referring to FIG. **3**, a block diagram of an electronic device is provided. In general, electronic device **300** may include microprocessor **305**, memory **310**, software and applications **315**, display and display driver **320**, user interface **325**, power supply **330**, data interface **335**, and audio **340**. Other features may be provided as necessary and/or desired.

Processor **305** provides the processing power for electronic device **300**. Processor **305** may be any suitable processor or integrated circuit, including microprocessors, programmed microprocessors micro-controllers, peripheral integrated circuit elements, CSICs (Customer Specific Integrated Circuit) or ASICs (Application Specific Integrated Circuit), logic circuits, digital signal processors, programmable logic devices such as FPGAs, PLDs, PLAs or PALs, or any other device or arrangement of devices that is capable of performing the function of a microprocessor.

Memory **310** may be any suitable memory, and may be used to store software and applications **315**. Memory **310** may be volatile or non-volatile as necessary and/or desired. Memory **310** may include static RAM, dynamic RAM, flash memory, magnetic memory, etc.

In one embodiment, memory **310** may store data files, including electronic content files, style sheets, etc. In one embodiment, software and applications **315** render an image on the display of electronic device **300**. In one embodiment, software and applications **315** responds to the "-shadowbox-zoom-deltas" property by allowing a user to zoom certain areas of an electronic document, while preventing the user from zooming other areas of the electronic document.

Display and drivers **320** are provided for displaying characters, graphics, videos, pictures, etc. for the user. The display may be any suitable display, including flexible displays, touch-sensitive displays, etc.

User interface **325** may be provided for the user to interact with electronic device **300**. Any suitable input mechanism may be provided. In one embodiment, buttons may be provided. In another embodiment, a touch-sensitive screen may be provided. In still another embodiment, a microphone may be provided to detect speech. In another embodiment, a camera may be provided. Other inputs may be provided as necessary and/or desired, depending on application.

In one embodiment, the user may use user interface **325** to zoom on the content.

6

Electronic device **300** may be powered by power supply **330**, such as a battery, AC power, DC power through an AC adapter, etc.

Electronic device **300** may also be provided with data interface **335**. In one embodiment, data interface may be any suitable wired or wireless communication method, including cellular communications, a USB interface, unshielded twisted pair interface, radio frequency (RF), infrared (IR), Bluetooth, near field communication, WiFi (e.g., any suitable IEEE 802.11 protocol), etc.

In one embodiment, electronic device **300** may be provided with audio capability **340**.

Referring to FIG. **4**, a flowchart depicting a method of rendering electronic content on an electronic device is disclosed. As noted above, the electronic device may be any device that is capable of rendering electronic content.

In step **410**, the electronic device receives and stores content representing, for example, an electronic publication. In one embodiment, the content may be stored in computer memory of the electronic device.

In one embodiment, the content may include several styles, and each style may be specific to a portion of the content. In one embodiment, each style may specify a base text size and a value to increment or decrement the base text size, and one or more subsequent values. In one embodiment, the style may include the "-shadowbox-zoom-deltas" property as described above.

In one embodiment, the base size may be selected such that the text size may be incremented or decremented.

In step **415**, the content is rendered on the electronic device according to its at least one style.

In step **420**, in response to a user entry indicating a zoom to the next zoom state, the content is rendered according to the "-shadowbox-zoom-deltas" property. Thus, depending on the values set for the "-shadowbox-zoom-deltas" property, the content may remain the same size, or it may increase in size, or decrease in size.

In step **430**, in response to a subsequent user entry indicating a zoom to the next zoom state, the content is rendered according to the "-shadowbox-zoom-deltas" property. Thus, depending on the values set for the "-shadowbox-zoom-deltas" property, the content may remain the same size, or it may increase or decrease in size.

Referring to FIGS. **5** and **6**, an example of the "-shadowbox-zoom-deltas" property use according to an embodiment is shown. In FIG. **5**, content is rendered for the user with its base text size. In FIG. **6**, in response to a user instruction to zoom by one level, the content is rendered so that the text size for the article increases according to "-shadowbox-zoom-deltas" property for each portion of the content. In this example, the "Front Page" header, which has its "-shadowbox-zoom-deltas" increment set to zero, does not zoom in response to the user request. The text of the article, however, does increase in size.

A system and method for selective control of zoom adjustments in an electronic publication are disclosed. According to one embodiment, a method for selective control of zoom adjustments in an electronic publication may include (1) generating content for display on an electronic reading device; (2) generating at least one style for the content; and (3) storing the content and the at least one style on a computer readable medium. The step of generating at least one style for the content may include identifying at least a portion of the content for which at least one zoom level will be specified; specifying a base text size for the portion of the content; and specifying a first value to increment the base text size to a first zoom state text size.

The step of generating at least one style for the content may also include specifying a second value to increment the first zoom state text size to a second zoom state text size.

According to another embodiment, a method for selective control of zoom adjustments in an electronic publication includes (1) generating content for display on an electronic reading device; and (2) generating at least one style for the content. The step of generating at least one style for the content may include identifying at least a portion of the content for which a plurality of zoom levels will be specified; specifying a base text size for the portion of the content; and specifying a value to increment the base text size and subsequent text sizes at each zoom level.

According to another embodiment, a method for rendering an electronic document on an electronic device includes (1) storing content representing an electronic publication in a computer memory of the electronic device, the content including at least one style for a portion of the content, the at least one style including a base text size for the portion of the content and at least a first value to increment the base text size to a first zoom state text size; (2) rendering the contents according to the at least one style; and (3) incrementing the base text size for the portion of the content by the first value in response to a user input to zoom. The method may also include (4) incrementing the first zoom state text size by a second value to a second zoom state text size in response to a user input to zoom. The at least one style further includes the second value to increment the first zoom state text size to the second zoom state text size.

The system of the invention or portions of the system of the invention may be in the form of a "processing machine," such as a general purpose computer, for example. As used herein, the term "processing machine" is to be understood to include at least one processor that uses at least one memory. The at least one memory stores a set of instructions. The instructions may be either permanently or temporarily stored in the memory or memories of the processing machine. The processor executes the instructions that are stored in the memory or memories in order to process data. The set of instructions may include various instructions that perform a particular task or tasks, such as those tasks described above in the flowcharts. Such a set of instructions for performing a particular task may be characterized as a program, software program, or simply software.

As noted above, the processing machine executes the instructions that are stored in the memory or memories to process data. This processing of data may be in response to commands by a user or users of the processing machine, in response to previous processing, in response to a request by another processing machine and/or any other input, for example.

The processing machine used to implement the invention may utilize a suitable operating system. Thus, embodiments of the invention may include a processing machine running the Microsoft Windows™ Vista™ operating system, the Microsoft Windows™ XP™ operating system, the Microsoft Windows™ NT™ operating system, the Windows™ 2000 operating system, the Unix operating system, the Linux operating system, the Xenix operating system, the IBM AIX™ operating system, the Hewlett-Packard UX™ operating system, the Novell Netware™ operating system, the Sun Microsystems Solaris™ operating system, the OS/2™ operating system, the BeOS™ operating system, the Macintosh operating system, the Apache operating system, an OpenStep™ operating system or another operating system or platform.

As described above, a set of instructions may be used in the processing of the invention. The set of instructions may be in the form of a program or software. The software may be in the form of system software or application software, for example. The software might also be in the form of a collection of separate programs, a program module within a larger program, or a portion of a program module, for example. The software used might also include modular programming in the form of object oriented programming. The software tells the processing machine what to do with the data being processed.

Further, it is appreciated that the instructions or set of instructions used in the implementation and operation of the invention may be in a suitable form such that the processing machine may read the instructions. For example, the instructions that form a program may be in the form of a suitable programming language, which is converted to machine language or object code to allow the processor or processors to read the instructions. That is, written lines of programming code or source code, in a particular programming language, are converted to machine language using a compiler, assembler or interpreter. The machine language is binary coded machine instructions that are specific to a particular type of processing machine, i.e., to a particular type of computer, for example. The computer understands the machine language.

Any suitable programming language may be used in accordance with the various embodiments of the invention. Illustratively, the programming language used may include assembly language, Ada, APL, Basic, C, C++, COBOL, dBase, Forth, Fortran, Java, Modula-2, Pascal, Prolog, RUM Visual Basic, and/or JavaScript, for example. Further, it is not necessary that a single type of instructions or single programming language be utilized in conjunction with the operation of the system and method of the invention. Rather, any number of different programming languages may be utilized as is necessary and/or desirable.

Also, the instructions and/or data used in the practice of the invention may utilize any compression or encryption technique or algorithm, as may be desired. An encryption module might be used to encrypt data. Further, files or other data may be decrypted using a suitable decryption module, for example.

In the system and method of the invention, a variety of "user interfaces" may be utilized to allow a user to interface with the processing machine or machines that are used to implement the invention. As used herein, a user interface includes any hardware, software, or combination of hardware and software used by the processing machine that allows a user to interact with the processing machine. A user interface may be in the form of a dialogue screen for example. A user interface may also include any of a mouse, touch screen, light pen, keyboard, voice reader, voice recognizer, dialogue screen, menu box, list, checkbox, toggle switch, a pushbutton or any other device that allows a user to receive information regarding the operation of the processing machine as it processes a set of instructions and/or provides the processing machine with information. Accordingly, the user interface is any device that provides communication between a user and a processing machine. The information provided by the user to the processing machine through the user interface may be in the form of a command, a selection of data, or some other input, for example.

It will be readily understood by those persons skilled in the art that the present invention is susceptible to broad utility and application. Many embodiments and adaptations of the present invention other than those herein described, as

well as many variations, modifications and equivalent arrangements, will be apparent from or reasonably suggested by the present invention and foregoing description thereof, without departing from the substance or scope of the invention.

In the preceding specification, various preferred embodiments have been described with references to the accompanying drawings. It will, however, be evident that various modifications and changes may be made thereto, and additional embodiments may be implemented, without departing from the broader scope of invention as set forth in the claims that follow. The specification and drawings are accordingly to be regarded in an illustrative rather than restrictive sense.

We claim:

1. A method for selective control of zoom adjustments in an electronic publication, comprising:
 - generating content for display on an electronic reading device, the context including text;
 - generating at least one style for the text, comprising:
 - identifying a first portion of the text;
 - specifying a first base size value of the at least one style, the first base size value defining a base display size of the first portion of the text, wherein the first portion of the text is a paragraph;
 - specifying a first zoom increment value of the at least one style, the first zoom increment value defining an amount to increment the base display size of the first portion of the text when displaying the first portion of text in a first zoom state, wherein a size of the first portion of the text in the first zoom state is based on the first base size value and the first zoom increment value;
 - identifying a second portion of the text, the second portion of the text being different than the first portion of the text, wherein the second portion of the text is at least one of a different paragraph, a page number, a header, and a footer;
 - specifying a second base size value of the at least one style, the second base size value defining a base display size of the second portion of the text; and
 - specifying a second zoom increment value of the at least one style, the second zoom increment value defining an amount to increment the base display size of the second portion of the text when displaying the second portion of text in a second zoom state, the second zoom increment value being different than the first zoom increment value, wherein a size of the second portion of text in the second zoom state is based on the second base size value and the second zoom increment value;
 - receiving, by the electronic reading device, a request to zoom the content of the electronic device; and
 - responsive to receiving the request to zoom the content, displaying, by the electronic reading device, the first portion of text in the first zoom state and the second portion of the text in the second zoom state different from the first zoom state.
2. The method of claim 1, wherein the second zoom increment value is 0.
3. The method of claim 1, wherein generating the at least one style for the text further comprises:
 - specifying a third zoom increment value of the at least one style, the third zoom increment value defining a second amount to increment the base display size of the first portion of the text different from the first amount to increment the base display size of the first portion of the text.

4. The method of claim 3, wherein one of the first zoom increment value and the third zoom increment value is 0.

5. The method of claim 1, wherein a style of the at least one style is inherited by a child element of the first portion.

6. The method of claim 1, wherein the at least one style includes a first style corresponding to the first portion and a second style corresponding to the second portion, the first style including the first base size value and the first zoom increment value, and the second style including the second base size value and the second zoom increment value.

7. The method of claim 1, wherein the content and the at least one style are separate files.

8. An electronic reading device, comprising:

at least one processor;

a display for displaying an electronic publication content; and

a computer readable medium storing instructions that when executed by the at least one processor cause the electronic reading device to:

receive content for display on the display, the content including a first portion of text of the content and a second portion of text of the content, the second portion of the text being different than the first portion of the text, wherein the first portion of the text is a paragraph, and wherein the second portion of the text is at least one of a different paragraph, a page number, a header, and a footer;

receiving at least one style for the text, the at least one style comprising:

a first base size value defining a base display size of the first portion of the text;

a first zoom increment value defining an amount to increment the base display size of the first portion of the text when displaying the first portion of text in a first zoom state, wherein a size of the first portion of the text in the first zoom state is based on the first base size value and the first zoom increment value;

a second base size value defining a base display size of the second portion of the text; and

a second zoom increment value defining an amount to increment the base display size of the second portion of the text when displaying the second portion of text in a second zoom state, the second zoom increment value being different than the first zoom increment value, wherein a size of the second portion of text in the second zoom state is based on the second base size value and the second zoom increment value; and

responsive to receiving a request to zoom the content of the electronic device, output, for display by the display, the first portion of text in the first zoom state and the second portion of the text in the second zoom state, different from the first zoom state.

9. The electronic reading device of claim 8, wherein the second zoom increment value is 0.

10. The electronic reading device of claim 8, wherein the at least one style further comprises:

a third zoom increment value defining a second amount to increment the base display size of the first portion of the text different from the first amount to increment the base display size of the first portion of the text.

11. The electronic reading device of claim 8, wherein a style of the at least one style is inherited by a child element of the first portion.

12. The electronic reading device of claim 8, wherein the at least one style is in a head section of the content.

11

13. The electronic reading device of claim 8, wherein the at least one style includes a first style corresponding to the first portion and a second style corresponding to the second portion, the first style including the first base size value and the first zoom increment value, and the second style including the second base size value and the second zoom increment value.

14. A non-transitory a computer readable medium storing executable computer program code for selective control of zoom adjustments in an electronic publication, the computer program code comprising instructions for:

receiving content for display on the display, the content including a first portion of text of the content and a second portion of text of the content, the second portion of the text being different than the first portion of the text, wherein the first portion of the text is a paragraph, and wherein the second portion of the text is at least one of a different paragraph, a page number, a header, and a footer;

receiving at least one style for the text, the at least one style comprising:

a first base size value defining a base display size of the first portion of the text;

a first zoom increment value defining an amount to increment the base display size of the first portion of the text when displaying the first portion of text in a first zoom state, wherein a size of the first portion of the text in the first zoom state is based on the first base size value and the first zoom increment value;

a second base size value defining a base display size of the second portion of the text; and

a second zoom increment value defining an amount to increment the base display size of the second portion

12

of the text when displaying the second portion of text in a second zoom state, the second zoom increment value being different than the first zoom increment value, wherein a size of the second portion of text in the second zoom state is based on the second base size value and the second zoom increment value; and responsive to receiving a request to zoom the content of the electronic device, displaying the first portion of text in the first zoom state and the second portion of the text in the second zoom state, different from the first zoom state.

15. The non-transitory a computer readable medium of claim 14, wherein the second zoom increment value is 0.

16. The non-transitory a computer readable medium of claim 14, wherein the at least one style further comprises: a third zoom increment value defining a second amount to increment the base display size of the first portion of the text different from the first amount to increment the base display size of the first portion of the text.

17. The non-transitory a computer readable medium of claim 14, wherein a style of the at least one style is inherited by a child element of the first portion.

18. The non-transitory a computer readable medium of claim 14, wherein the at least one style is in a head section of the content.

19. The non-transitory a computer readable medium of claim 14, wherein the at least one style includes a first style corresponding to the first portion and a second style corresponding to the second portion, the first style including the first base size value and the first zoom increment value, and the second style including the second base size value and the second zoom increment value.

* * * * *