



US009658756B2

(12) **United States Patent**
Freeman et al.

(10) **Patent No.:** **US 9,658,756 B2**
(45) **Date of Patent:** **May 23, 2017**

(54) **EMS DECISION SUPPORT INTERFACE, EVENT HISTORY, AND RELATED TOOLS**

(71) Applicant: **ZOLL MEDICAL CORPORATION**, Chelmsford, MA (US)

(72) Inventors: **Gary A. Freeman**, Newton Center, MA (US); **Annemarie Elizabeth Silver**, Bedford, MA (US)

(73) Assignee: **ZOLL Medical Corporation**, Chelmsford, MA (US)

(*) Notice: Subject to any disclaimer, the term of this patent is extended or adjusted under 35 U.S.C. 154(b) by 377 days.

(21) Appl. No.: **14/151,602**

(22) Filed: **Jan. 9, 2014**

(65) **Prior Publication Data**
US 2014/0201627 A1 Jul. 17, 2014

Related U.S. Application Data

(60) Provisional application No. 61/818,334, filed on May 1, 2013, provisional application No. 61/751,743, filed on Jan. 11, 2013.

(51) **Int. Cl.**
G06F 3/048 (2013.01)
G06F 3/0484 (2013.01)
(Continued)

(52) **U.S. Cl.**
CPC **G06F 3/04847** (2013.01); **G06F 3/0481** (2013.01); **G06F 3/0485** (2013.01); **G06F 19/345** (2013.01); **G06F 19/3406** (2013.01)

(58) **Field of Classification Search**
None
See application file for complete search history.

(56) **References Cited**

U.S. PATENT DOCUMENTS

5,414,644 A * 5/1995 Seaman G06F 17/30017 702/183

5,813,403 A 9/1998 Soller et al.
(Continued)

FOREIGN PATENT DOCUMENTS

WO WO-2012148934 A1 11/2012

OTHER PUBLICATIONS

Hernandez, et al., "C.A.U.S.E.: Cardiac Arrest Ultra-Sound Exam—A Better Approach to Managing Patients in Primary Non-Arrhythmogenic Cardiac Arrest", *Resuscitation*, 76(2):198-206, Feb. 2008, Published online Sep. 6, 2007.

(Continued)

Primary Examiner — William Trapanese
(74) *Attorney, Agent, or Firm* — Wilmer Cutler Pickering; Hale and Dorr LLP

(57) **ABSTRACT**

Embodiments of the present invention include systems and methods for display and navigation of a clinical decision support process with portions thereof on separate display screens, as well as systems and methods for dynamically changing visual characteristics of softkeys on a patient monitor/defibrillator user interface screen based on clinical decision support or differential diagnosis processes, as well as a code review interface configured to permit a user to see what was displayed on a patient monitor/defibrillator user interface screen at any time during a medical event, as well as to see snapshots of other recorded parameters over the course of the medical event for purposes of code review, patient transfer, and improved patient care.

26 Claims, 30 Drawing Sheets

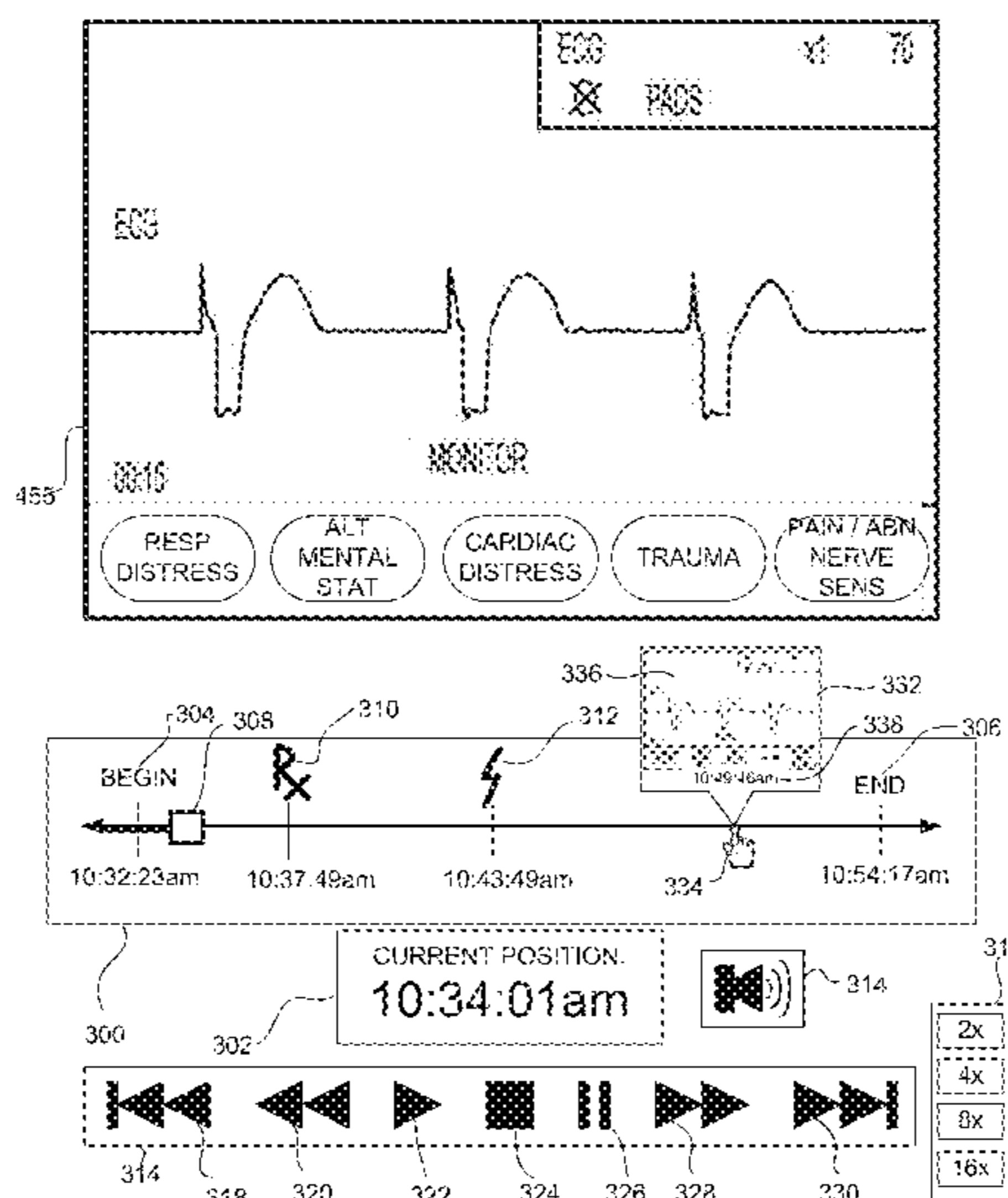

- (51) **Int. Cl.**
G06F 3/0485 (2013.01)
G06F 3/0481 (2013.01)
G06F 19/00 (2011.01)

(56) **References Cited**

U.S. PATENT DOCUMENTS

6,055,447 A 4/2000 Weil et al.
6,073,033 A * 6/2000 Campo H04M 1/05
348/14.02
6,564,088 B1 5/2003 Soller et al.
6,766,188 B2 7/2004 Soller
2006/0173501 A1 8/2006 Stickney et al.
2006/0229557 A1 * 10/2006 Fathallah G06F 19/3406
604/131
2009/0073114 A1 * 3/2009 Bay G06F 3/0482
345/156
2010/0131293 A1 5/2010 Linthicum et al.
2011/0055720 A1 3/2011 Potter et al.
2011/0172550 A1 7/2011 Martin et al.
2012/0278099 A1 11/2012 Kelly et al.

OTHER PUBLICATIONS

International Search Report and Written Opinion issued in PCT/
US14/10906, mailed Aug. 11, 2014, 5 pages.
Zoorob, et al., "Acute Dyspnea in the Office", American Family
Physician, 68(9):1803-1811, Nov. 1, 2003, 6 Pages.

* cited by examiner

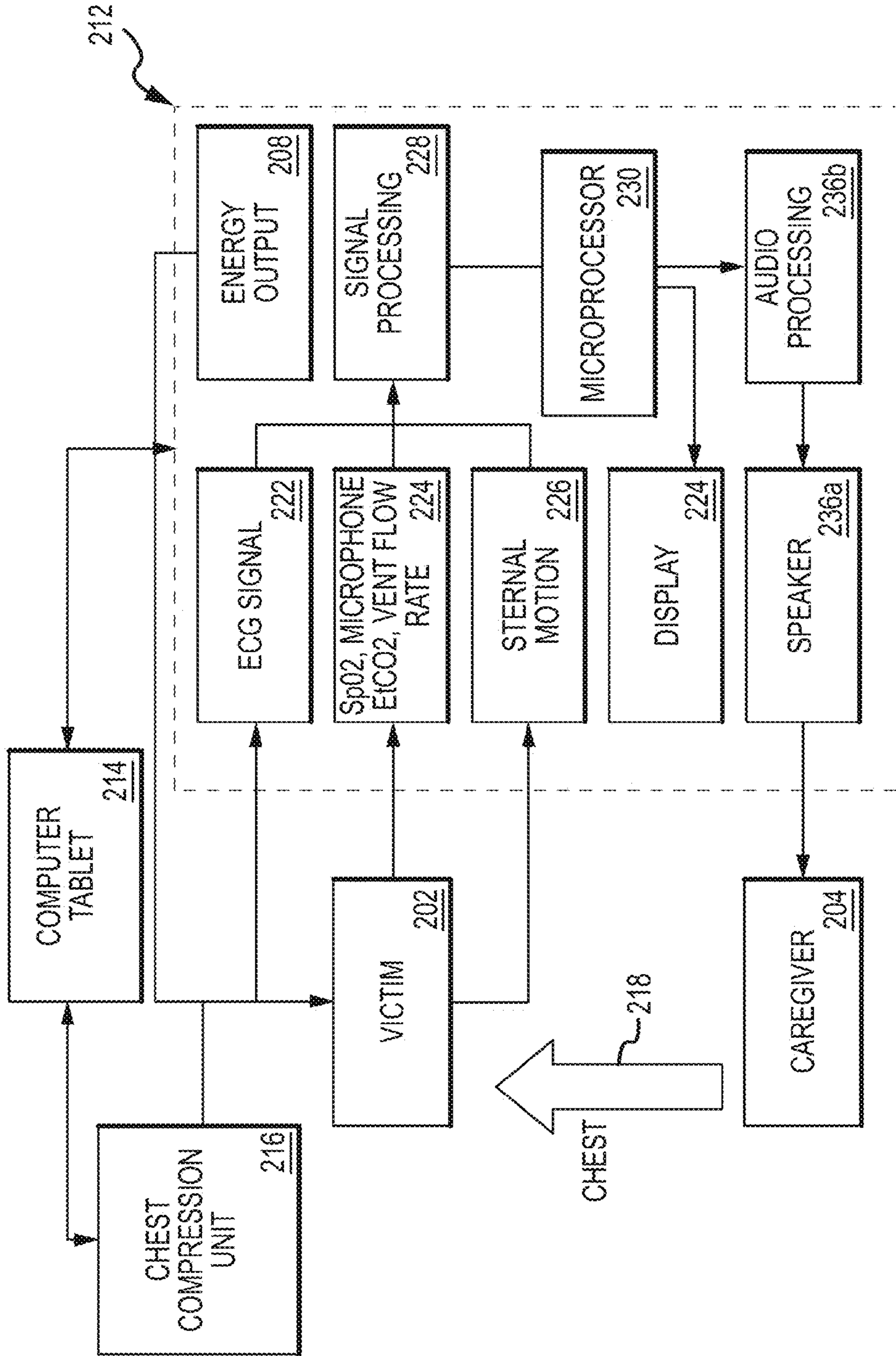

FIG. 1

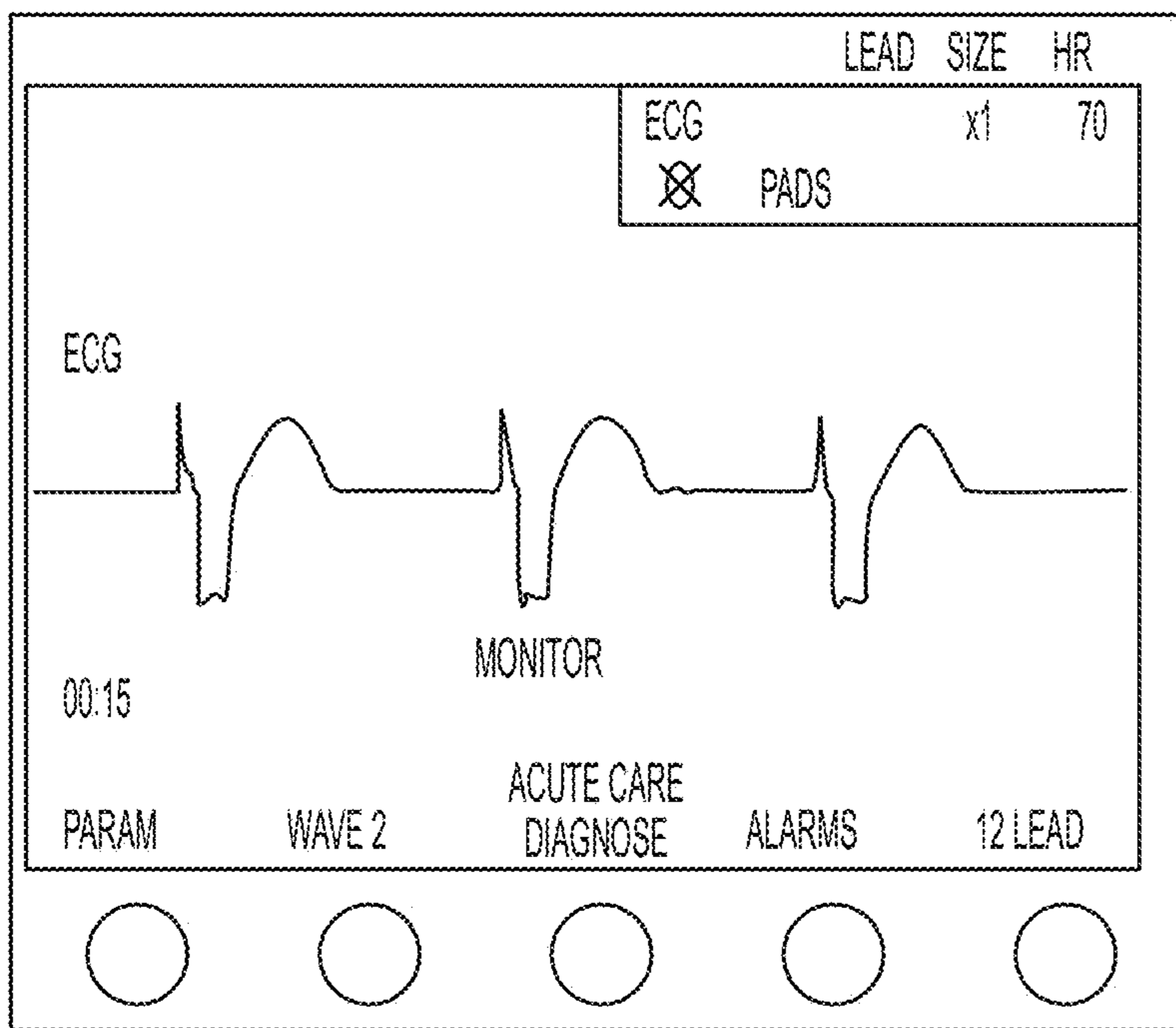

FIG. 2

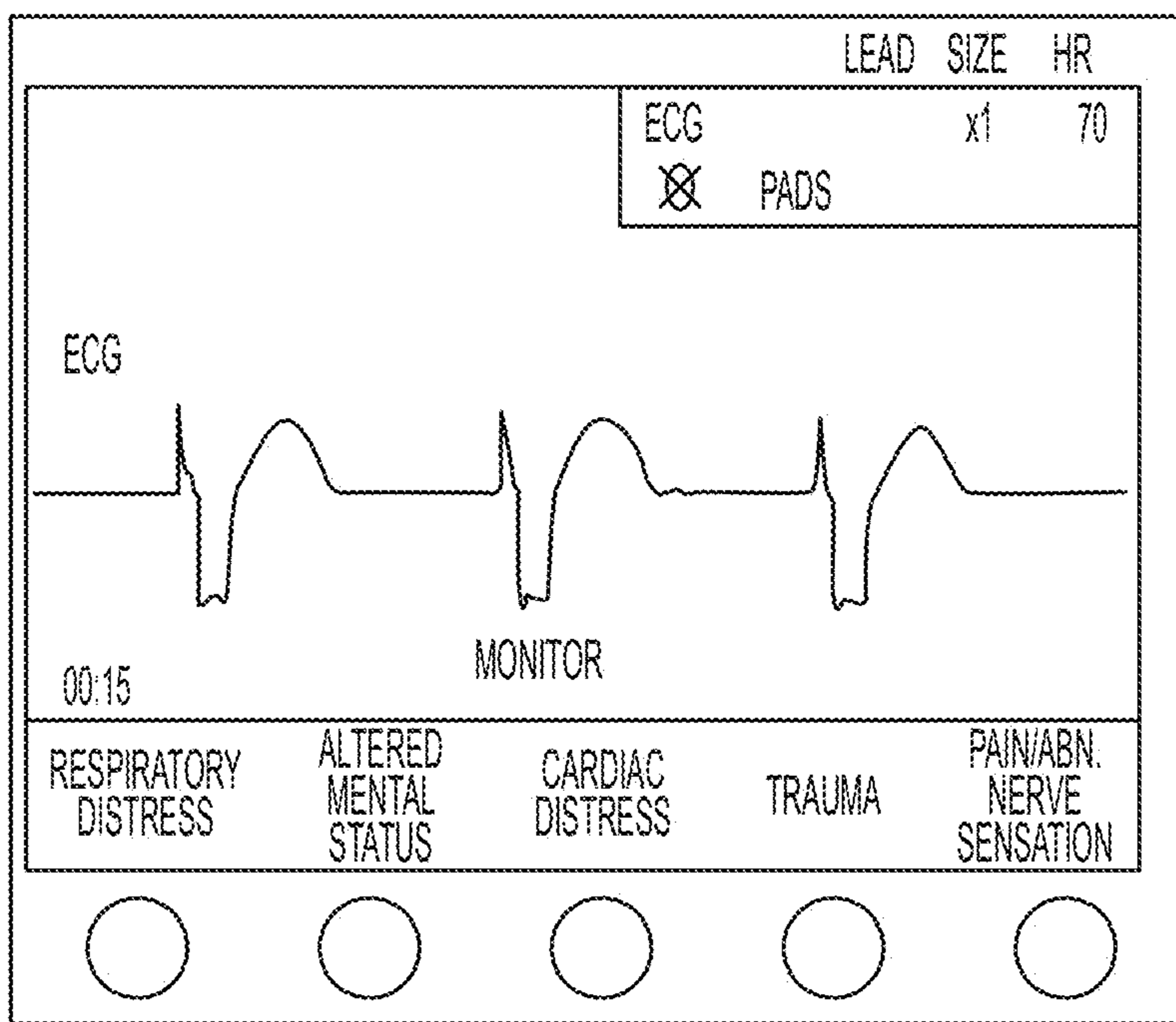

FIG. 3

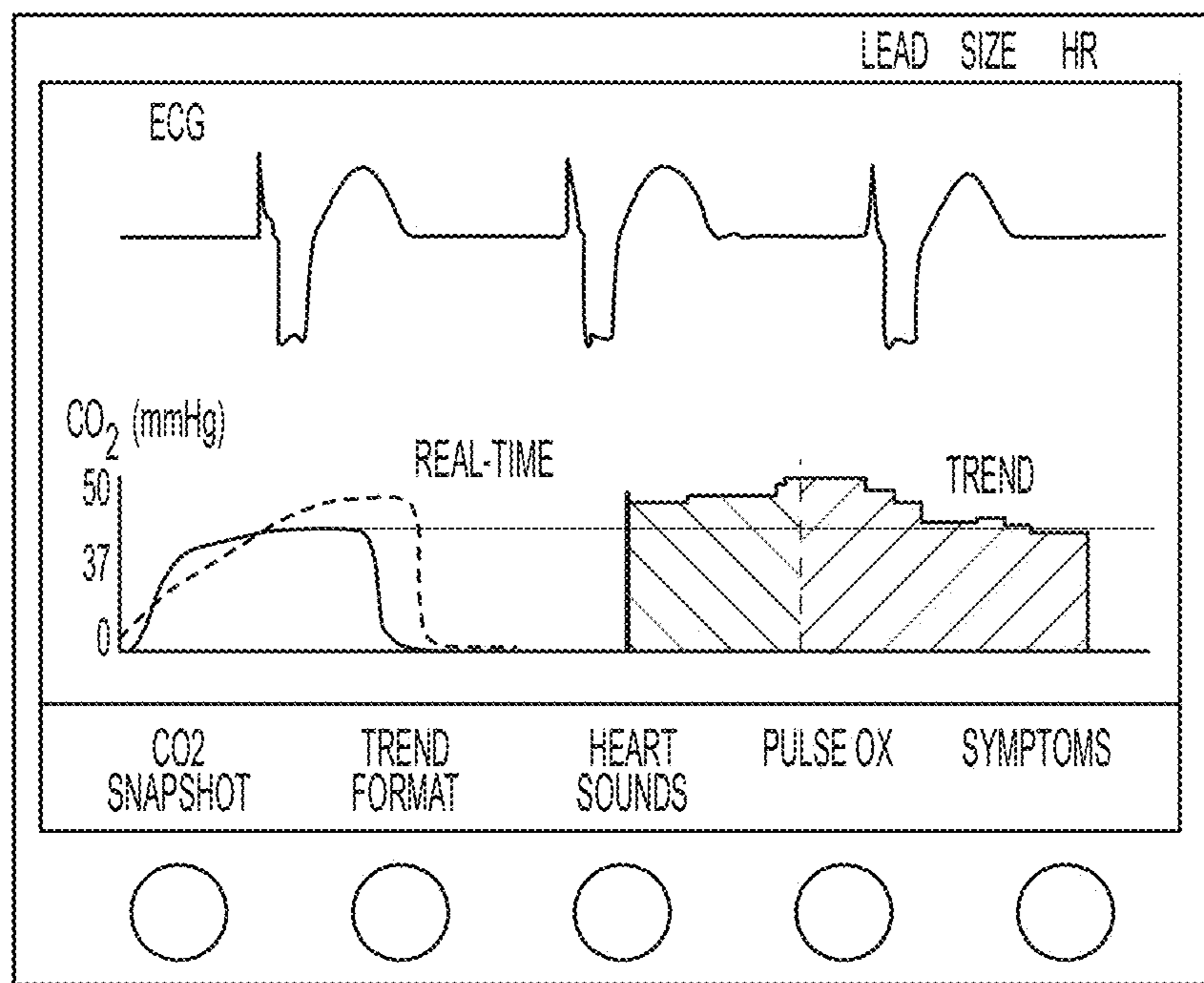

FIG. 4

DIFFERENTIAL DIAGNOSIS OF ACUTE DYSPNEA IN ADULTS

CARDIAC: CONGESTIVE HEART FAILURE, CORONARY ARTERY DISEASE, ARRHYTHMIA,
PERICARDITIS, ACUTE MYOCARDIAL INFARCTION, ANEMIA

PULMONARY: CHRONIC OBSTRUCTIVE PULMONARY DISEASE, ASTHMA, PNEUMONIA,
PNEUMOTHORAX, PULMONARY EMBOLISM, PLEURAL EFFUSION, METASTATIC DISEASE,
PULMONARY EDEMA, GASTROESOPHAGEAL REFLEX DISEASE WITH ASPIRATION, RESTRICTIVE
LUNG DISEASE

PSYCHOGENIC: PANIC ATTACKS, HYPERVENTILATION, PAIN, ANXIETY

UPPER AIRWAY OBSTRUCTION: EPIGLOTTITIS, FOREIGN BODY, CROUP, EPSTEIN-BARR VIRUS

ENDOCRINE: METABOLIC ACIDOSIS, MEDICATIONS

CENTRAL: NEUROMUSCULAR DISORDERS, PAIN, ASPIRIN OVERDOSE

PEDIATRIC: BRONCHIOLITIS, CROUP, EPIGLOTTITIS, FOREIGN BODY ASPIRATION, MYOCARDITIS

FIG. 5

PHYSICAL EXAMINATION FINDINGS IN THE DIAGNOSIS OF ACUTE DYSPNEA

FINDINGS	POSSIBLE DIAGNOSIS
WHEEZING, PULSUS PARADOXUS, ACCESSORY MUSCLE USE	ACUTE ASTHMA, COPD EXACERBATION
WHEEZING, CLUBBING, BARREL CHEST, DECREASED BREATH SOUNDS	COPD EXACERBATION
FEVER, CRACKLES, INCREASED FREMITUS	PNEUMONIA
EDEMA, NECK VEIN DISTENSION, S ₃ OR S ₄ HEPATOJUGULAR REFLEX, MURMERS, RALES, HYPERTENSION, WHEEZING	CONGESTIVE HEART FAILURE, PULMONARY EDEMA
WHEEZING, FRICTION RUB, LOWER EXTREMITY SWELLING	PULMONARY EMBOLISM
ABSENT BREATH SOUNDS, HYPERRESONANCE	PNEUMOTHORAX
INSPIRATORY STRIDOR, RHONCHI, RETRACTIONS	CROUP
STRIDOR, DROOLING, FEVER	EPIGLOTTITIS
STRIDOR, WHEEZING, PERSISTENT PNEUMONIA	FOREIGN BODY ASPIRATION
WHEEZING, FLARING, INTERCOSTAL RETRACTIONS, APNEA	BRONCHIOLITIS
SIGHING	HYPERVENTILATION

COPD = CHRONIC OBSTRUCTIVE PULMONARY DISEASE

FIG. 7

CLUES TO THE DIAGNOSIS OF DYSPNEA

SYMPTOMS OR FEATURES IN THE HISTORY	POSSIBLE DIAGNOSIS
COUGH	ASTHMA, PNEUMONIA
SEVERE SORE THROAT	EPIGLOTTITIS
PLEURITIC CHEST PAIN	PERICARDITIS, PULMONARY EMBOLISM, PNEUMOTHORAX, PNEUMONIA
ORTHOPNEA, NOCTURNAL PAROXYSMAL DYSPNEA, EDEMA	CONGESTIVE HEART FAILURE
TOBACCO USE	CHRONIC OBSTRUCTIVE PULMONARY DISEASE, CONGESTIVE HEART FAILURE, PULMONARY EMBOLISM
INDIGESTION, DYSPHAGIA	GASTROESOPHAGEAL REFLEX DISEASE, ASPIRATION
BARKING COUGH	CROUP

FIG. 6

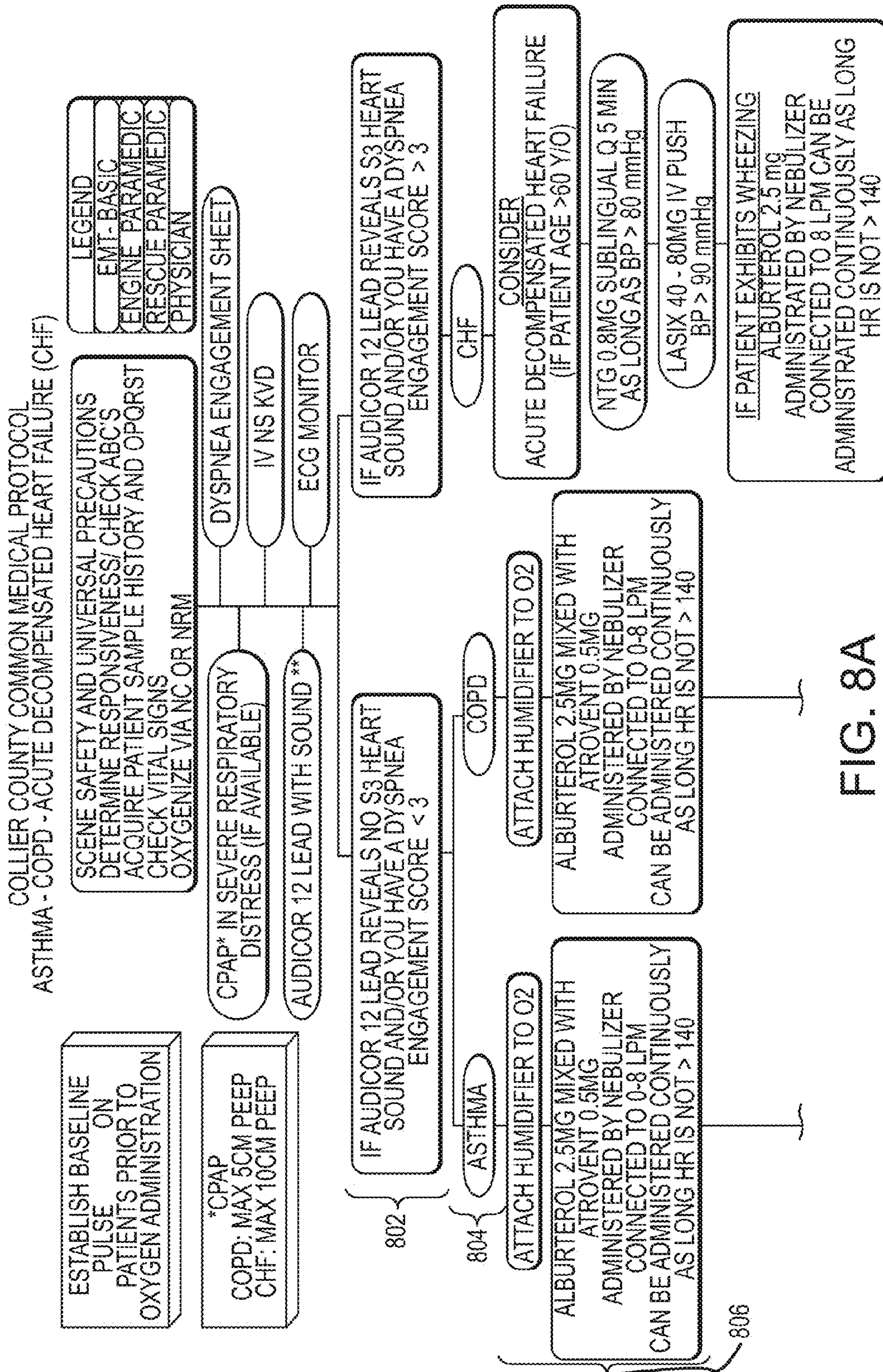

FIG. 8A

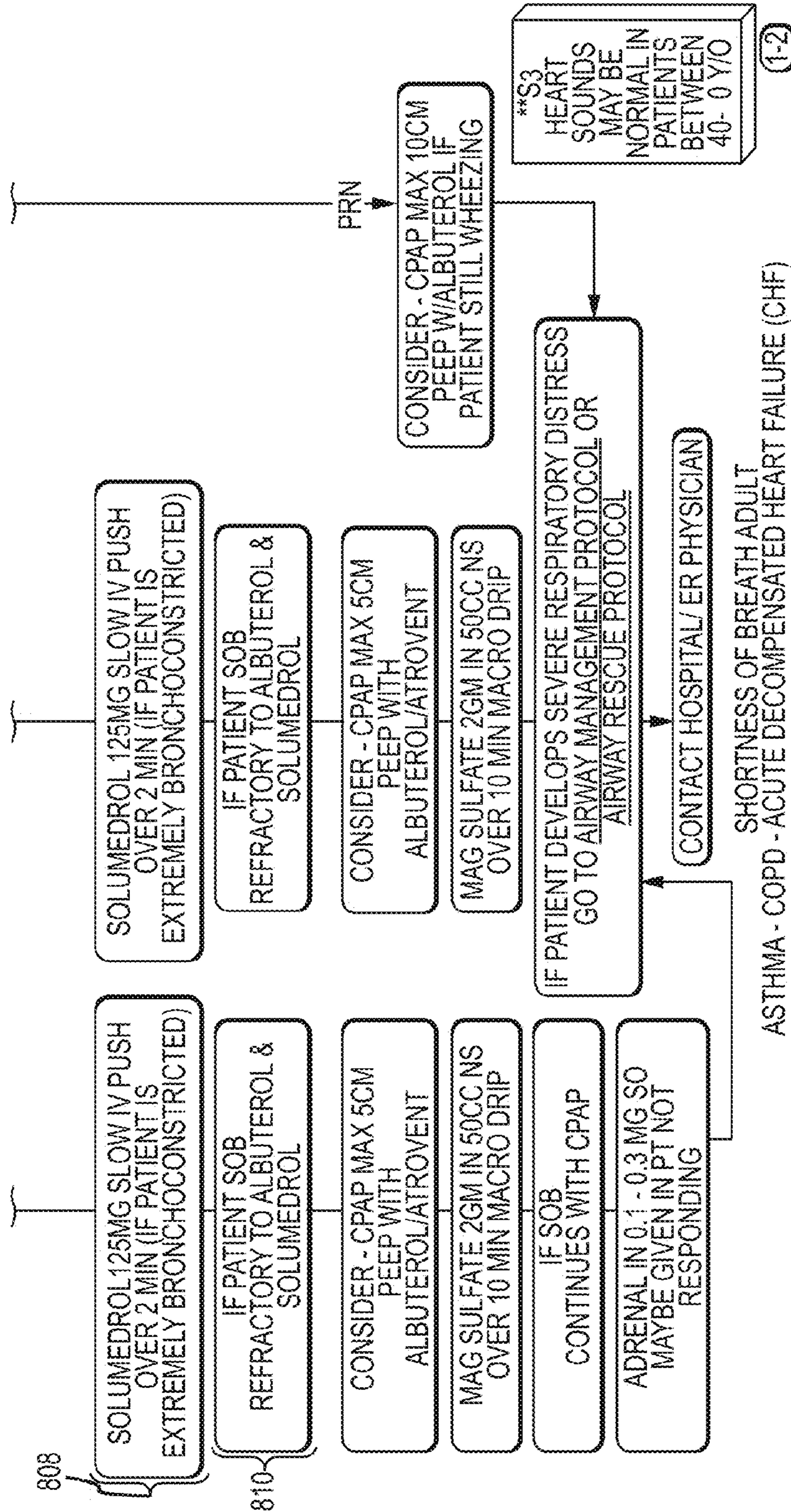

FIG. 8B

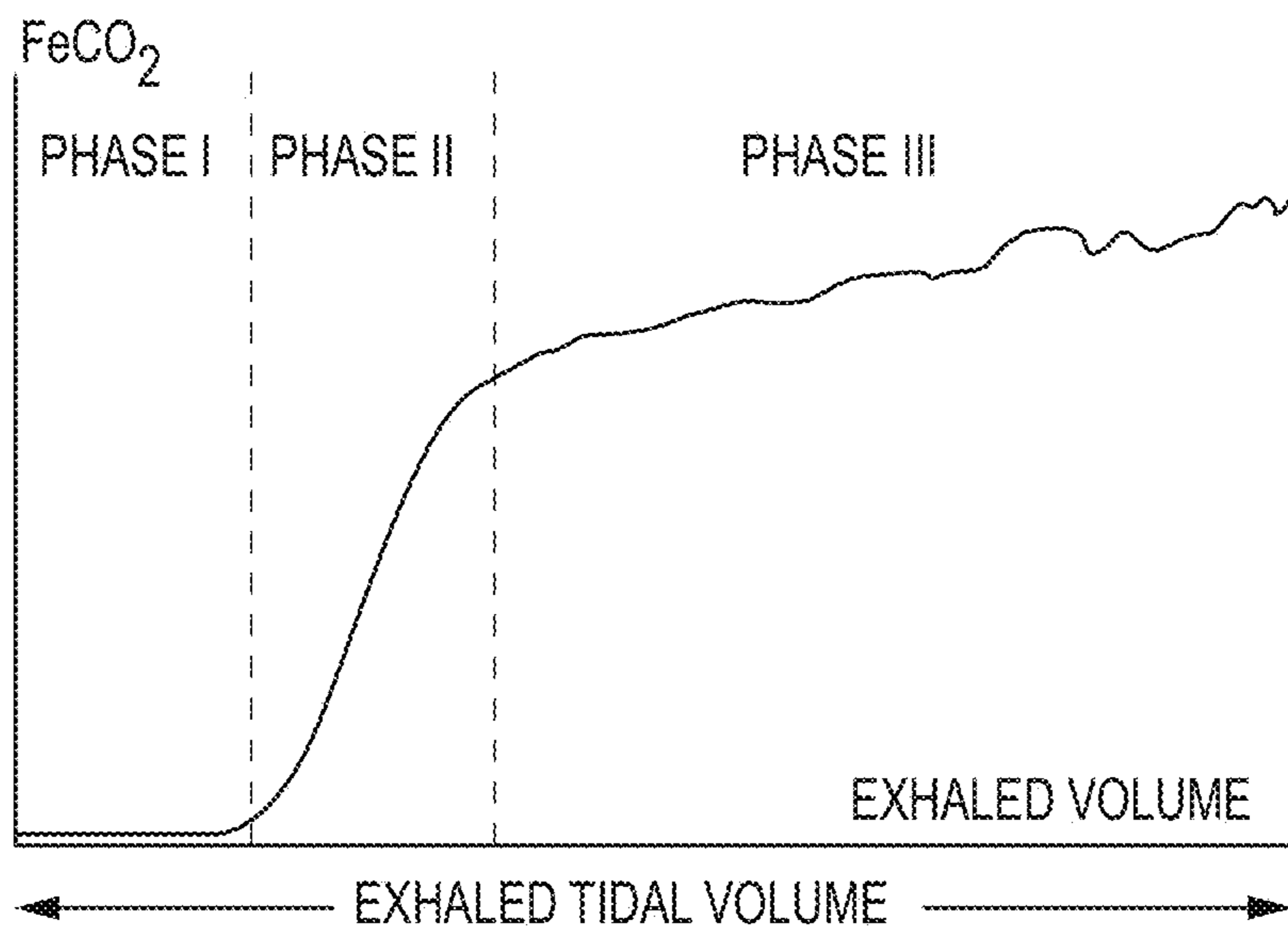

FIG. 9

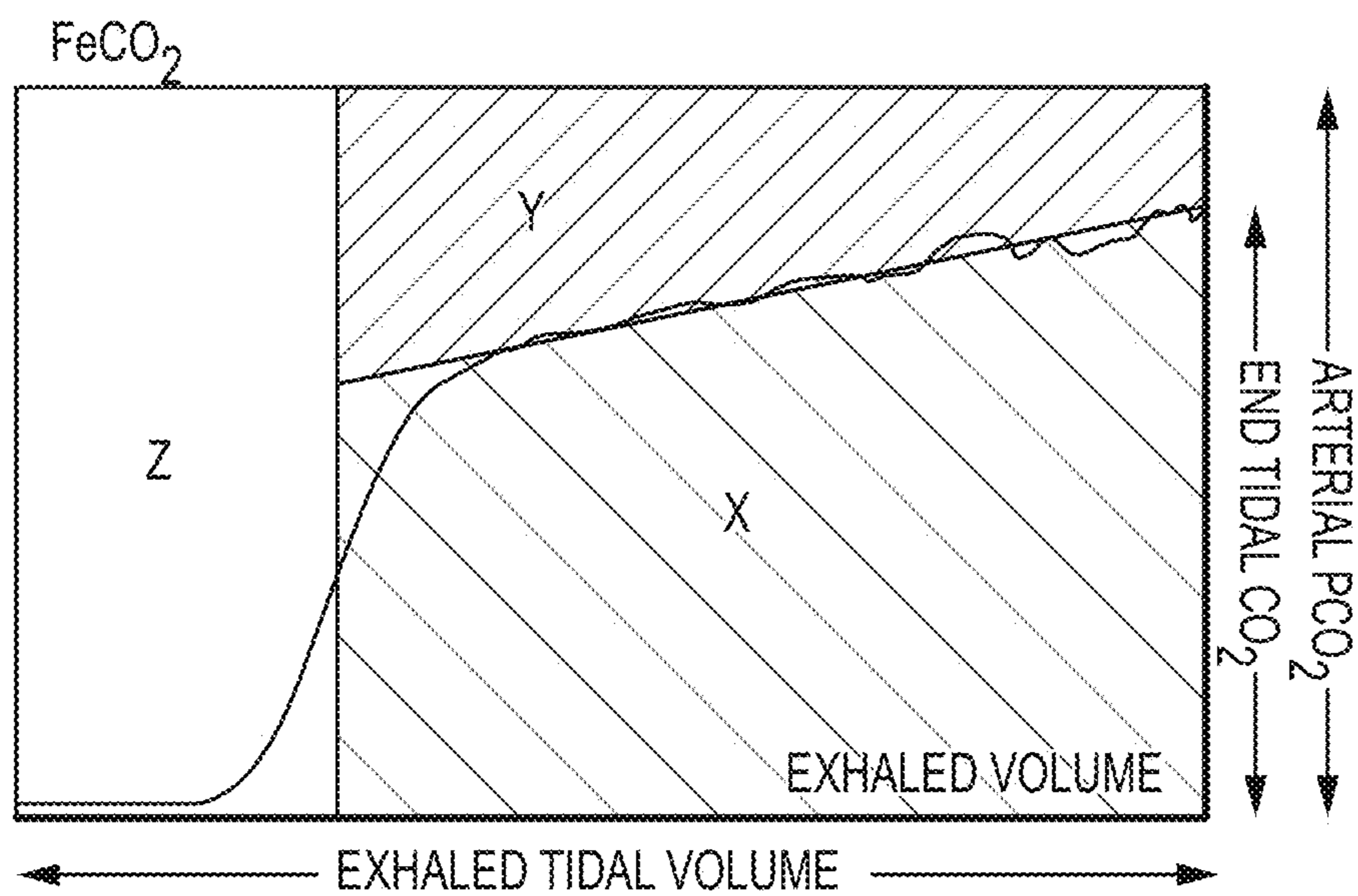

FIG. 10

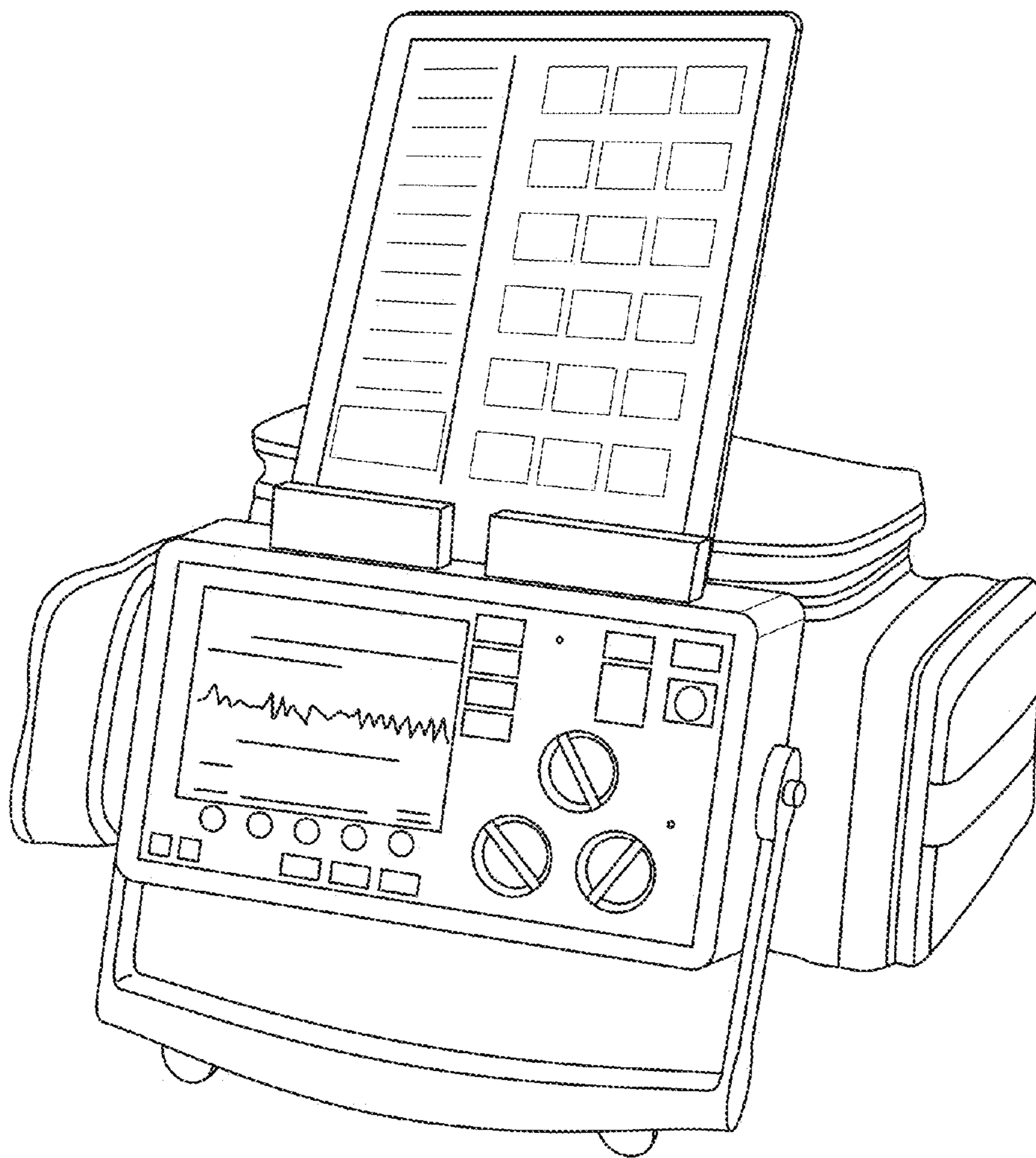

FIG. 11

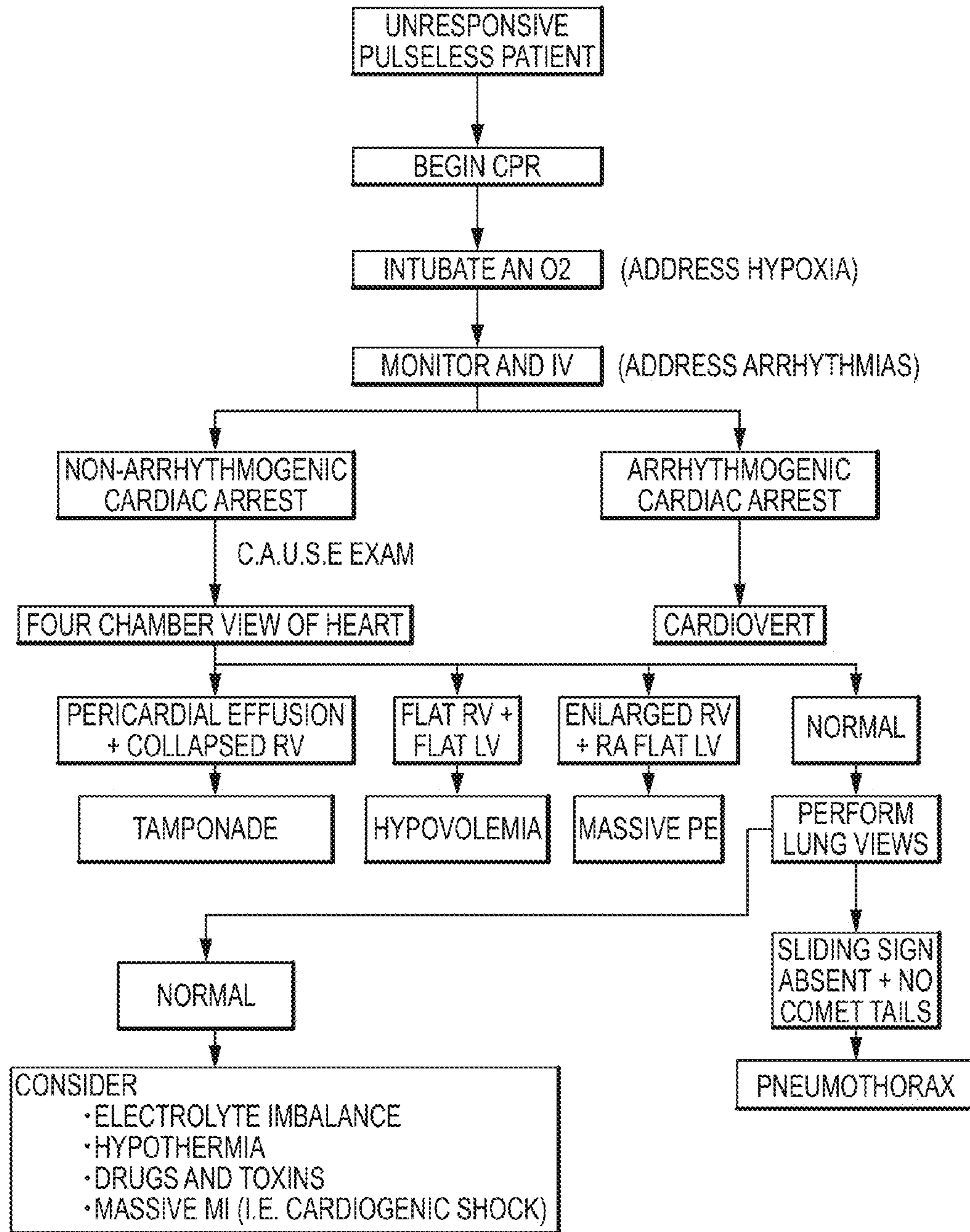

FIG. 12

1. Complete a scene size-up and determine if the scene is safe to approach. If the scene becomes unsafe at any time, withdraw.
2. Determine and evaluate the mechanism of injury.
3. Determine the number of patients and initiate MCI plan as appropriate.
4. Complete initial assessment according to initial assessment protocol, with attention to airway, breathing and circulation
5. Consider the need for spinal stabilization.
6. Determine the patient's level of consciousness by use of the AVPU scale
 - a. A – Alert
 - b. V – Responsive to verbal stimuli
 - c. P – Responsive to painful stimuli
 - d. U – Unresponsive
7. Assess vital signs.
8. Identify patient priority and need for ALS care. Dispatch ALS, if necessary.
9. Complete an appropriate secondary physical exam (see below):
 - a. Rapid Trauma Exam: for patients with multi-system trauma or single-system trauma with a high index of suspicion for serious mechanism of injury (MOI).
 - b. Focused physical exam: for patients with isolated injuries resulting from low index of suspicion for serious MOI who have no critical criteria according to dispatching ALS protocols.
10. Treat all life threatening injuries as found.
11. Complete history of event and past medical history using SAMPLE & OPQRST.
12. Treat all non-life threatening injuries as time allows.
13. Transport immediately.

FIG. 13

RAPID TRAUMA ASSESSMENT
DETERMINE MOI
ABC'S
CONSIDER C-SPINE STABILIZATION
HEAD DCAP – BTLS EARS: BLEEDING, DISCHARGE, BRUISING BEHIND EARS PUPILS: EQUALITY & REACTIVITY, RACCOON EYES, IMPALED OBJECTS MOUTH: RE-CHECK AIRWAY, DENTURES, LOOSE OR BROKEN TEETH OCCLUSIONS, BLEEDING, VOMITUS, GAG REFLEX, ASSESS BREATHING
NECK DCAP – BTLS JVD, TRACHEAL DEVIATION C-SPINE: DEFORMITY OR TENDERNESS ACCESSORY MUSCLE USE IN RESPIRATION BLUNT TRAUMA BURNS
CHEST DCAP – BTLS EQUAL CHEST RISE AND FALL OPEN WOUNDS, AIR LEAKS BREATH SOUNDS
ABDOMEN DCAP – BTLS PULSATING MASS PALPATE FOUR QUADRANTS TENDERNESS & GUARDING DISTENTION SIGNS OF PREGNANCY
PELVIS DCAP – BTLS ASSESS FOR INSTABILITY PRIAPISM BLEEDING OR DISCHARGE
EXTREMITIES DCAP – BTLS PULSE, MOVEMENT AND SENSATION
POSTERIOR DCAP – BTLS LUNG SOUNDS SKIN WOUNDS OR LESIONS

FIG. 14

FOCUSED PHYSICAL EXAM
DETERMINE MOI
ABC'S
CONSIDER C-SPINE STABILIZATION
ASSESS THE AFFECTED AREA
ASSESS THE AREAS "ABOVE" AND "BELOW" THE AFFECTED AREA

FIG. 15

1. Follow initial assessment and trauma assessment protocols for general guidelines on patient care.
2. Control all major bleeding according to standard BLS techniques.
3. Administer oxygen according to oxygen administration protocol.
4. Make every effort to locate and transport the amputated appendage with the patient.
5. Wrap the appendage in moist sterile dressing and place it in a plastic bag. Use ice packs or ice to keep the appendage cool.
6. If possible, contact Medical Control prior to transport to ensure appropriateness of transport destination.

FIG. 16

1. Assess the patient according to initial assessment and trauma assessment protocols.
2. Monitor and maintain a patent airway. Ensure adequate respirations; assist respirations via BVM if indicated.
3. Evaluate for and attempt control of any major bleeding immediately. Use the following steps to control major bleeding:
 - a. Apply direct pressure
 - b. Elevate wound above the level of the heart, if feasible
 - c. Apply pressure at the pulse point proximal to the wound
 - d. Apply ice or cold pack
 - e. Apply tourniquet 2 inches above the wound and tighten until bleeding stops. Mark the time of application around or on the tourniquet.
4. If a puncture wound is found in the chest, stomach or on the back, take the following steps:
 - a. Immediately cover wound with a gloved hand
 - b. Apply direct pressure
 - c. Place occlusive dressing over wound
 - d. Tape on three sides
 - e. Evaluate for lung sounds around the site of the wound in the case of chest, upper back or upper abdominal wounds
5. Provide oxygen via NRB mask.
6. Evaluate all minor wounds after ensuring ABC's, completing assessment and treating all life threatening emergencies.
7. Bandage all wounds using proper BLS technique.

FIG. 17

1. Follow initial assessment and trauma assessment protocols for general patient care guidelines.
2. Pay close attention to airway and breathing considerations. Always be aware of possible compromise to airway and breathing caused by burns to the airway.
3. Provide oxygen via NRB at 15 lpm. Assist respirations with BVM as necessary.
4. Remove all clothing or restricting items on or around the burned area(s) if possible.
5. Determine the degree and extent of burns using the "rule of nines" when appropriate. Document findings in PCR.
6. Cover burns with sterile dressings.
7. Keep the patient warm and guard against hypothermia.
8. For significant burn injuries, contact Medical Control for decision regarding transport to trauma center or designated burn center.

FIG. 18

1. Follow Scene Safety protocol. Ensure that electrical source has been turned off by appropriately trained professionals and there is no danger to the rescuers while providing care. Stage away from the patient until such time as adequate scene safety can be assured.
2. Follow initial assessment and trauma assessment protocols for general patient care guidelines.
3. Ensure adequacy of airway, breathing and circulation.
4. Provide oxygen via NRB at 15 lpm or assist via BVM attached to supplemental oxygen at 15 lpm.
5. If pulse is absent:
 - a. Begin CPR and attach AED.
 - b. Defibrillate with AED as indicated.
 - c. Ensure patent airway.
6. Consider transport options and need for assessment at trauma center or designated burn center.

FIG. 19

The following algorithm outlines requirements and indications for spinal immobilization. It is based on the algorithm published in the Pre-hospital Trauma Life Support curriculum.

Use this algorithm to evaluate and treat patients with known or suspected head trauma, spinal injuries, or mechanism of injury (MOI) which might indicate a need for immobilization.

Use clinical judgment in all cases. Where concerns exist, contact online medical control or immobilize and initiate transport. Whenever in doubt, err on the side of caution and maintain cervical spine immobilization.

FIG. 20

1. Assess patient according to initial assessment and trauma assessment protocols. Perform a rapid trauma exam.
2. Ensure airway and adequate respiratory effort. Provide oxygen via NRB at 15 lpm or assist respirations via BVM.
3. Assess circulatory status for adequate pulse and signs of hypoperfusion. Control hemorrhaging with pressure.
4. Establish C-spine precautions and prepare to immobilize patient.
5. Determine level of consciousness using AVPU scale and assess for altered mental status.
6. Treat all life-threatening injuries as soon as possible.
7. Obtain a complete set of vitals. Monitor and reassess vital signs continuously.
8. Initiate transport to the closest appropriate facility immediately. Notify receiving facility en route. For assistance with transport decisions, contact Medical Control.

FIG. 22

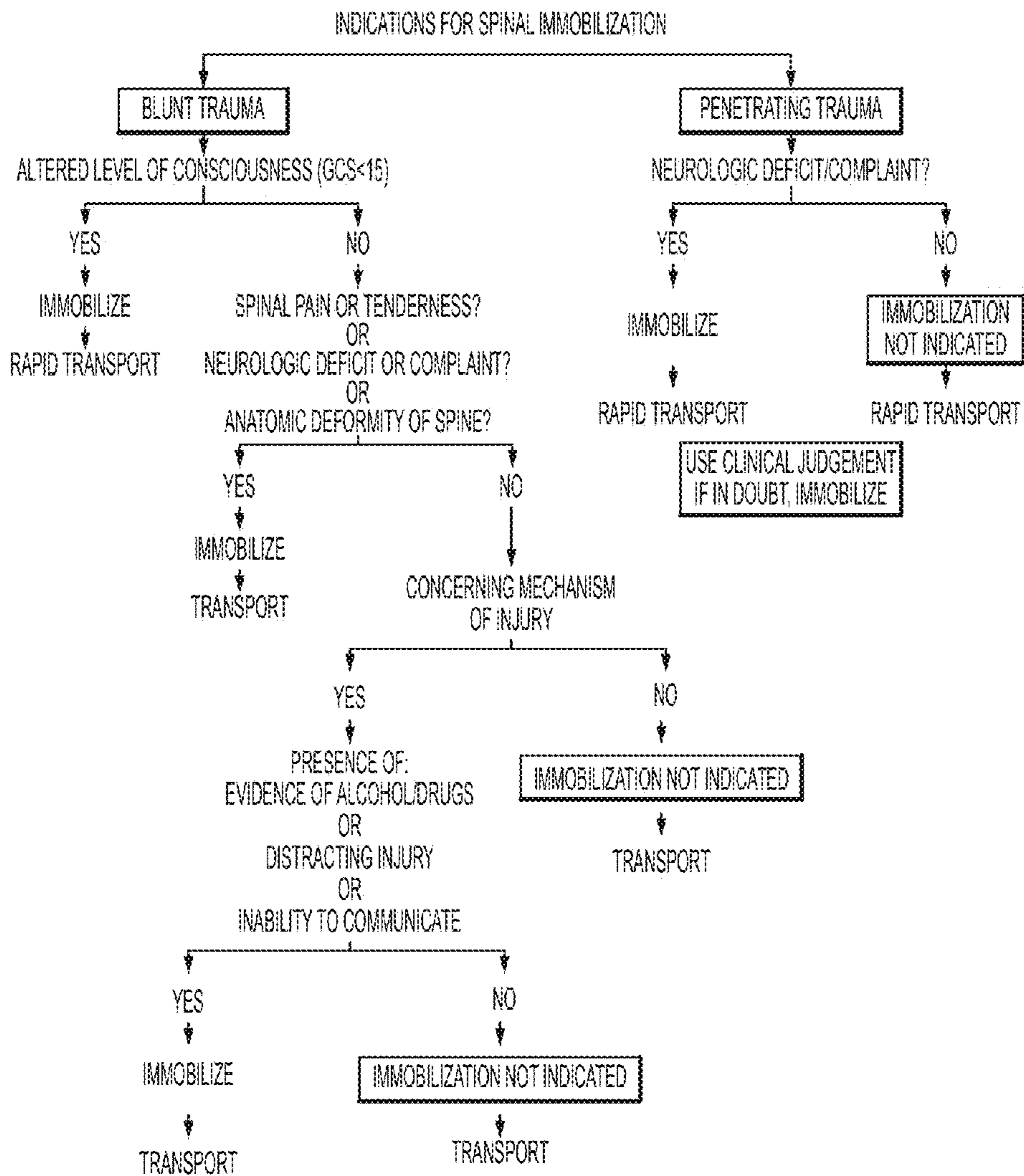

FIG. 21

1. Assess patient according to initial assessment and trauma assessment protocols. Make a special effort to determine the amount of time that the patient was in the water or submerged under water.
2. Open and maintain patent airway. Be ready to suction water from airway as necessary.
3. Check for spontaneous respirations and for pulse
4. If spontaneous respirations are present, provide high concentrations of oxygen by NRB mask according to oxygen administration protocol. Assist via BVM if respiratory effort is inadequate.
5. If spontaneous pulse and respirations are absent, refer to cardiac arrest protocols. Initiate advanced airway procedures and defibrillate as necessary.
6. Transport immediately. Contact Medical Control for assistance in determining appropriate receiving facility.

FIG. 23

1. Assess patient according to initial assessment and trauma assessment protocols. Perform a rapid trauma exam.
2. Ensure patent airway and adequate respiratory effort. Provide oxygen via NRB at 15 lpm or assist via BVM if needed.
3. Assess circulatory status for adequate pulse and signs of hypoperfusion.
4. Establish C-spine precautions and prepare to immobilize patient.
5. Determine level of consciousness (by use of the AVPU scale) and assess for altered mental status.
6. Treat all life-threatening injuries as soon as possible.
7. Obtain a complete set of vitals. Monitor and reassess vital signs continuously.
8. Initiate transport to the closest appropriate facility immediately. Contact Medical Control for assistance in selecting most appropriate receiving facility.
9. Transport patient on the patient's left side, left lateral recumbent position, or raise the left side of the backboard at an angle greater than 15 degrees using towels, blankets, head-blocks, etc. (unless the patient is in cardiac arrest).

FIG. 24

1. Assess and treat patient according to initial assessment and trauma assessment protocols.
2. Immediately begin CPR and ventilate patient via BVM at 15 lpm.
3. Initiate basic airway management, per applicable protocols.
4. Transport immediately to the closest open trauma center. Notify receiving facility en route.

FIG. 25

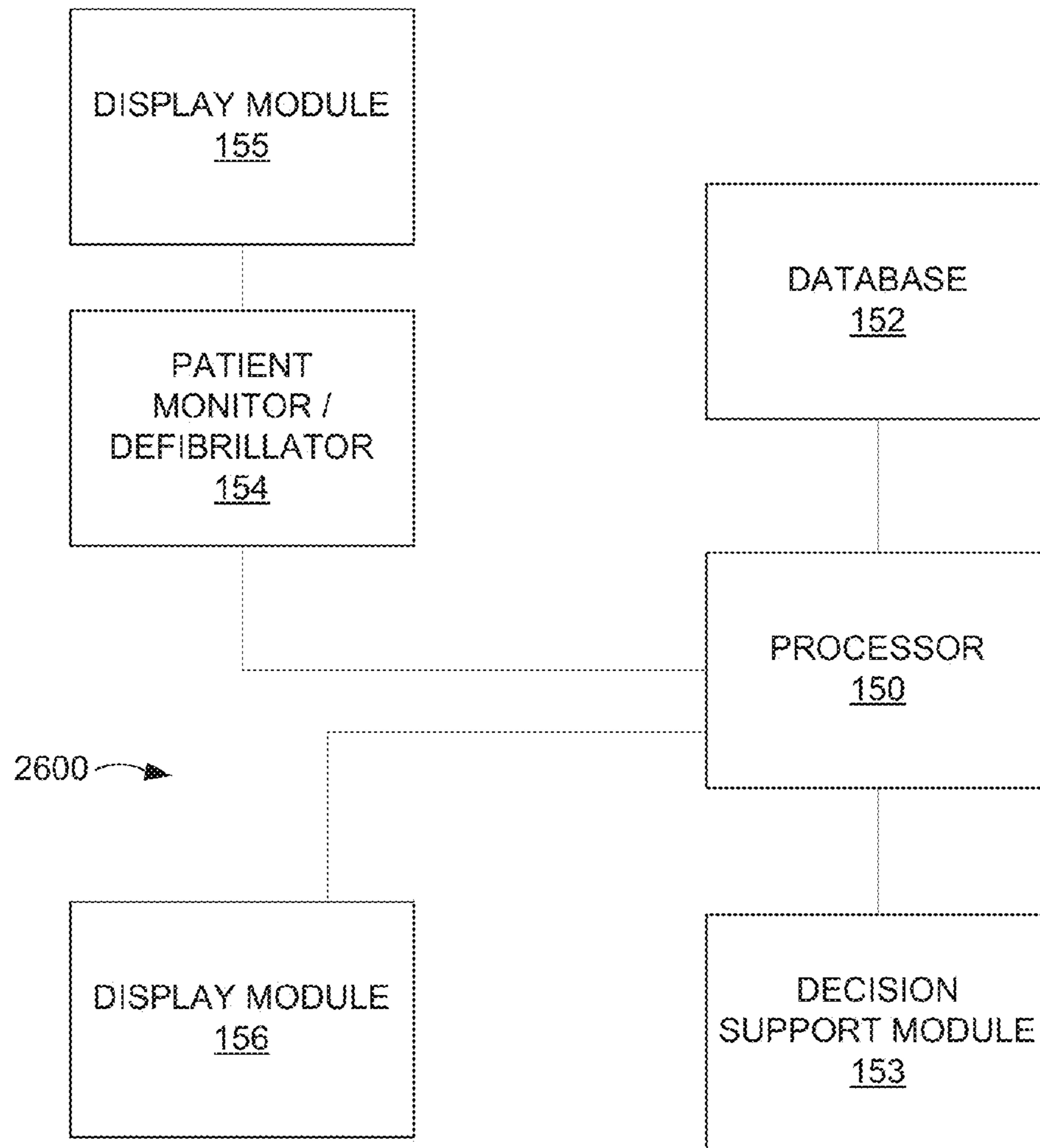

FIG. 26

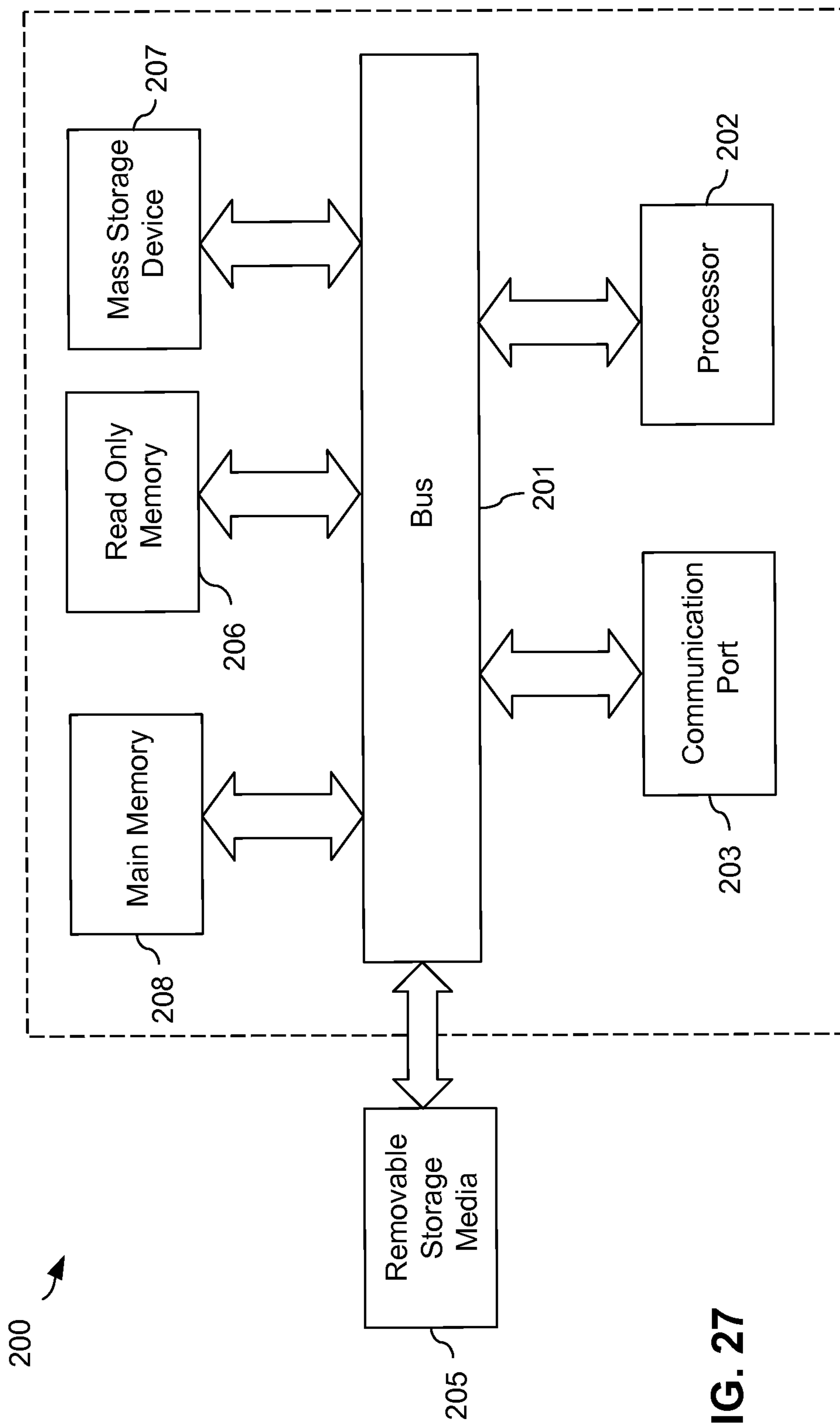

FIG. 27

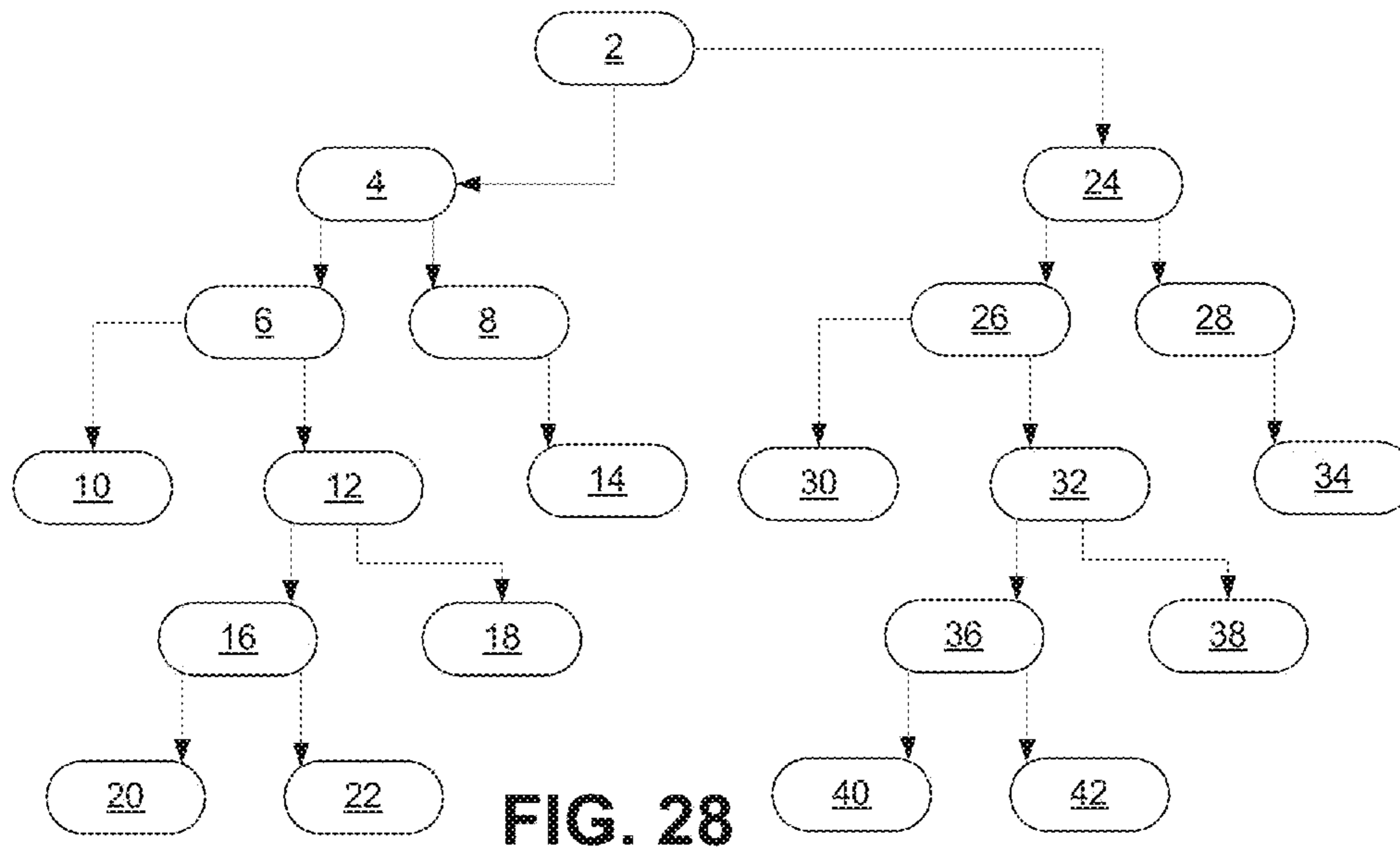

FIG. 28

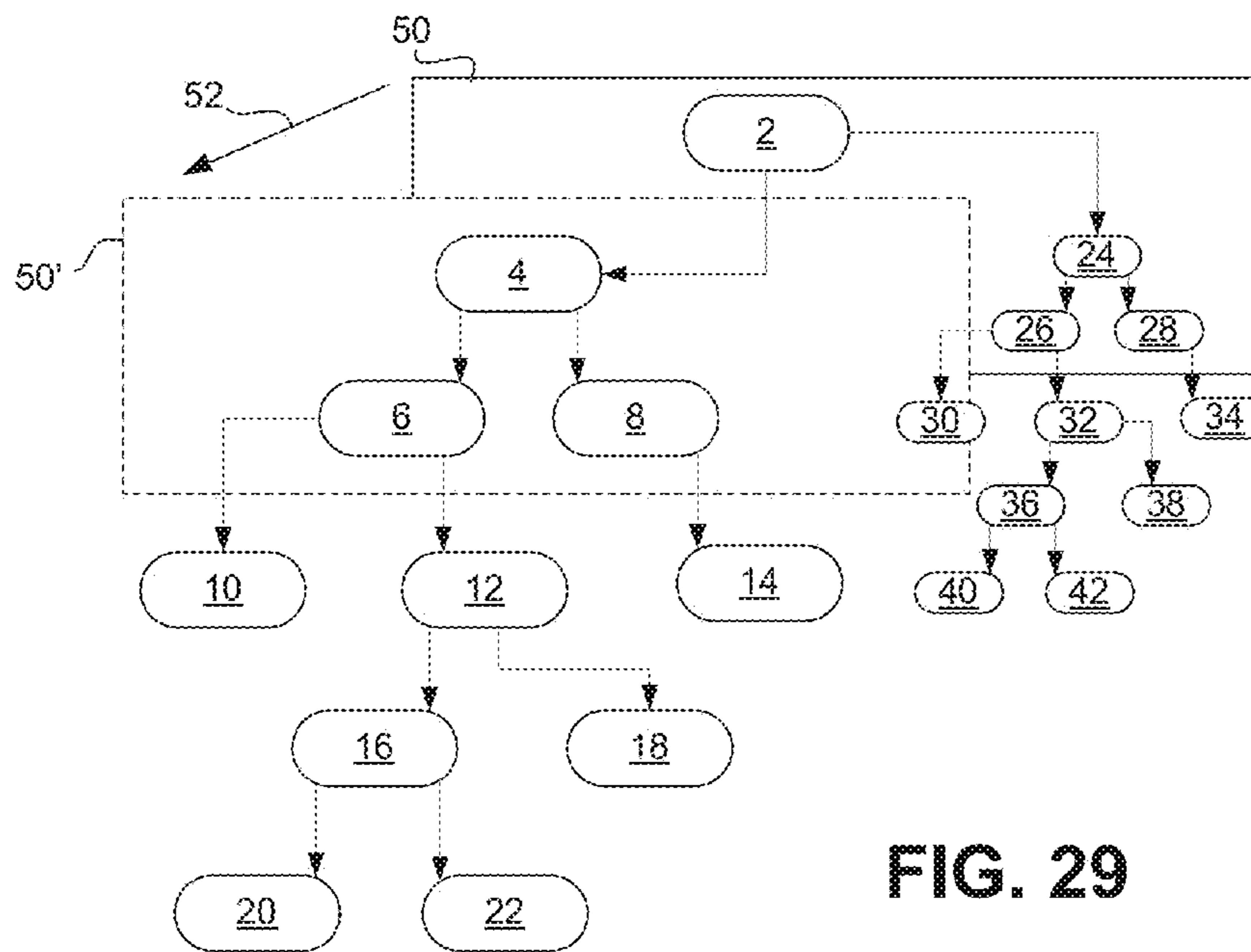

FIG. 29

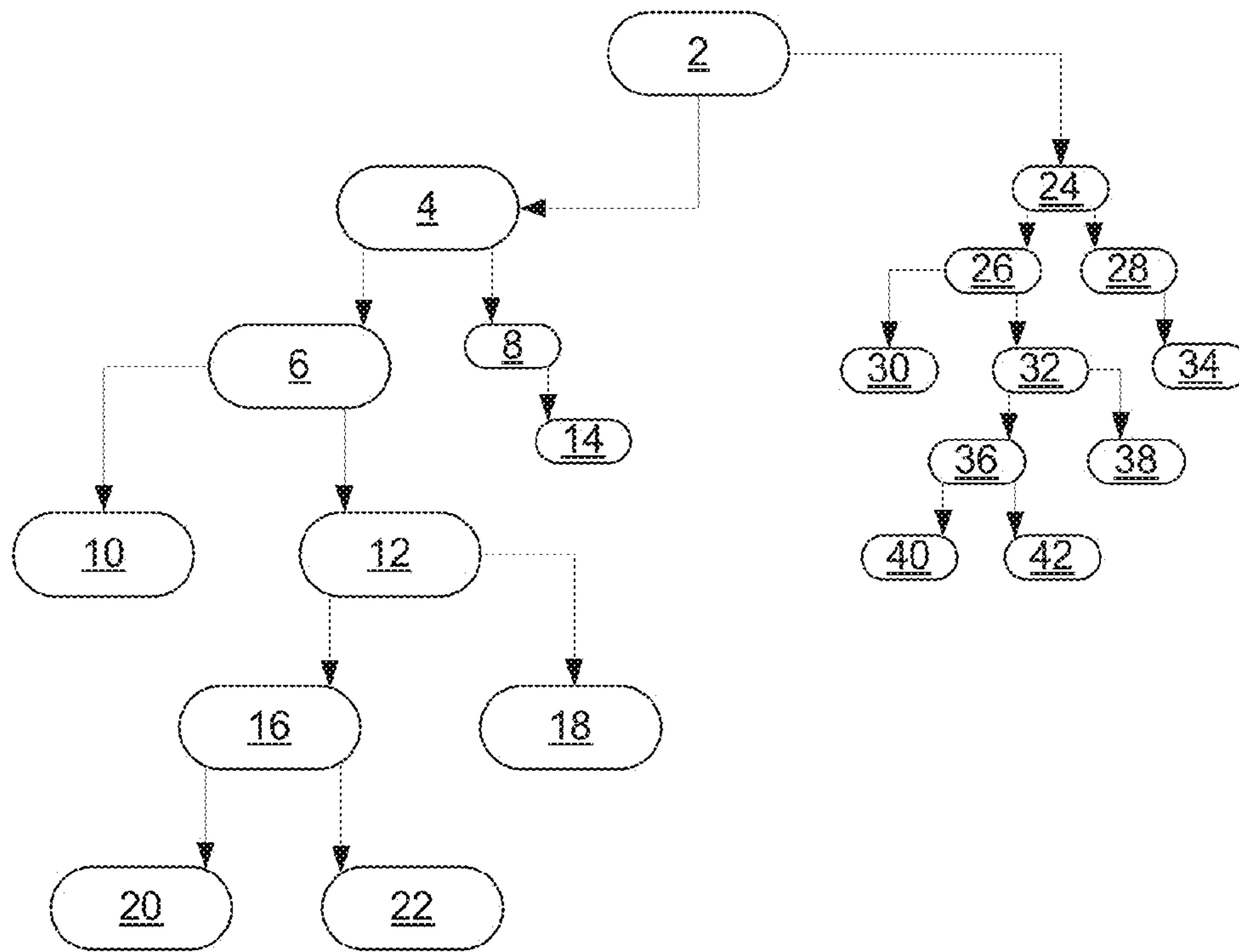

FIG. 30

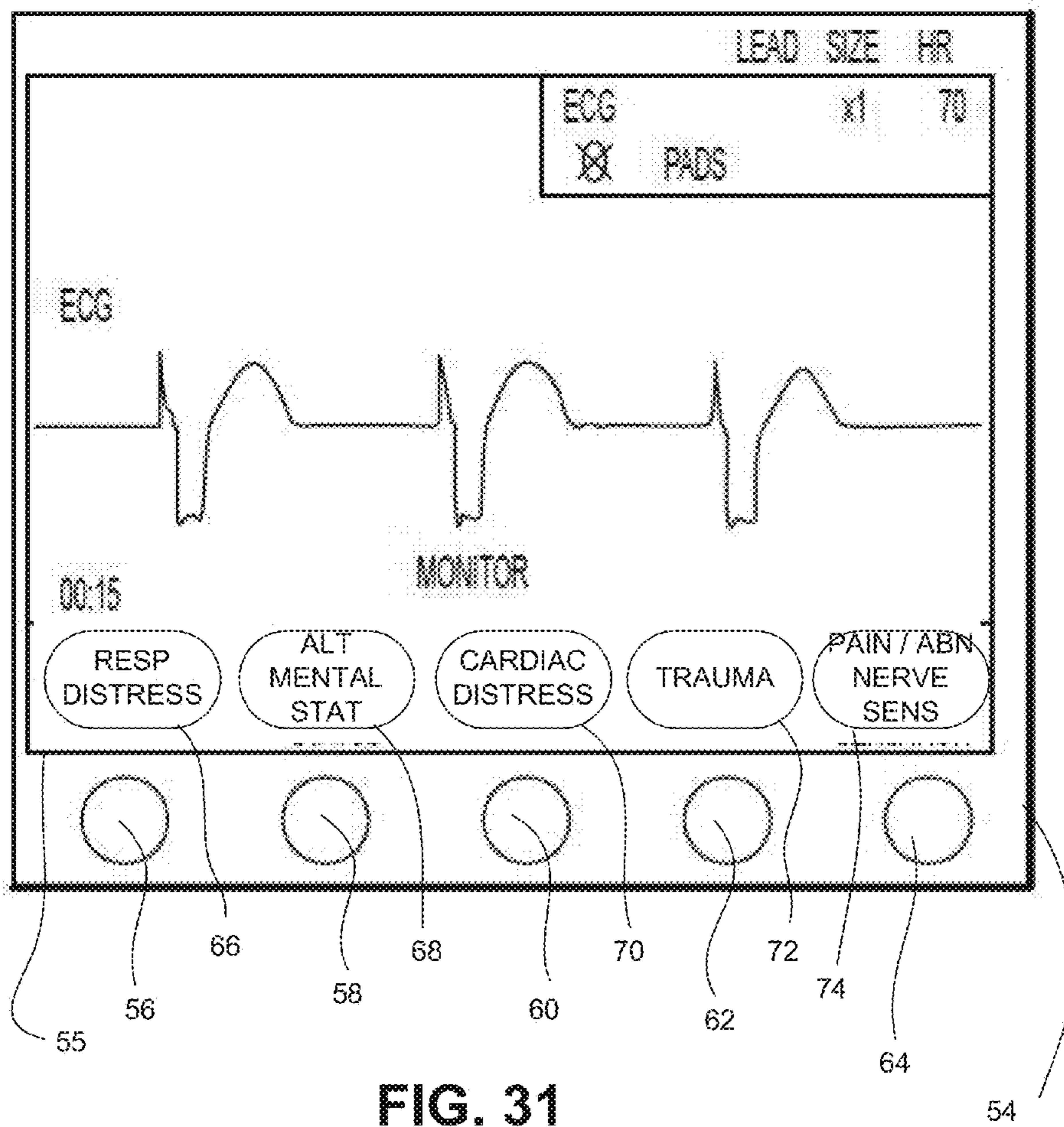

FIG. 31

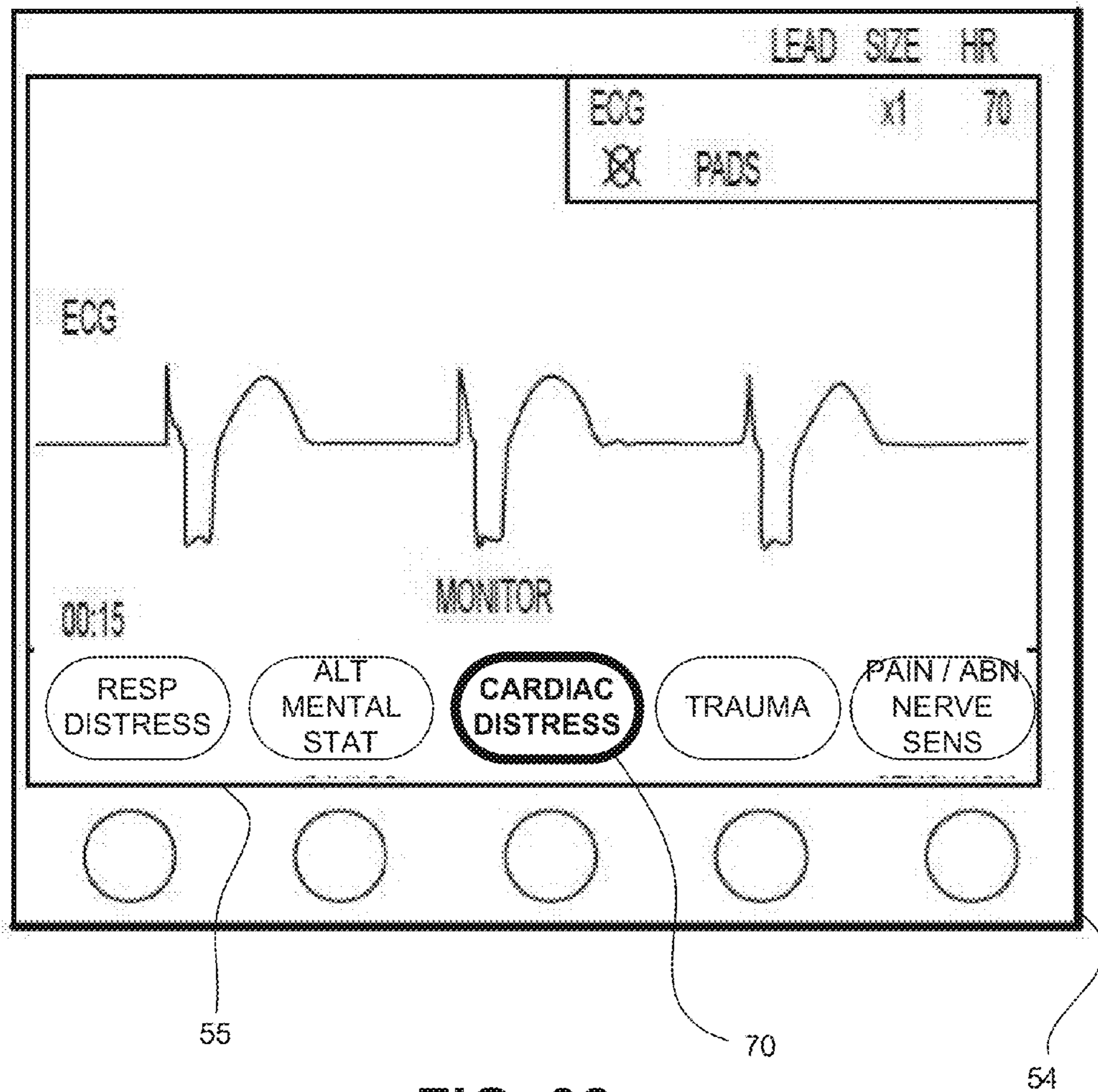

FIG. 32

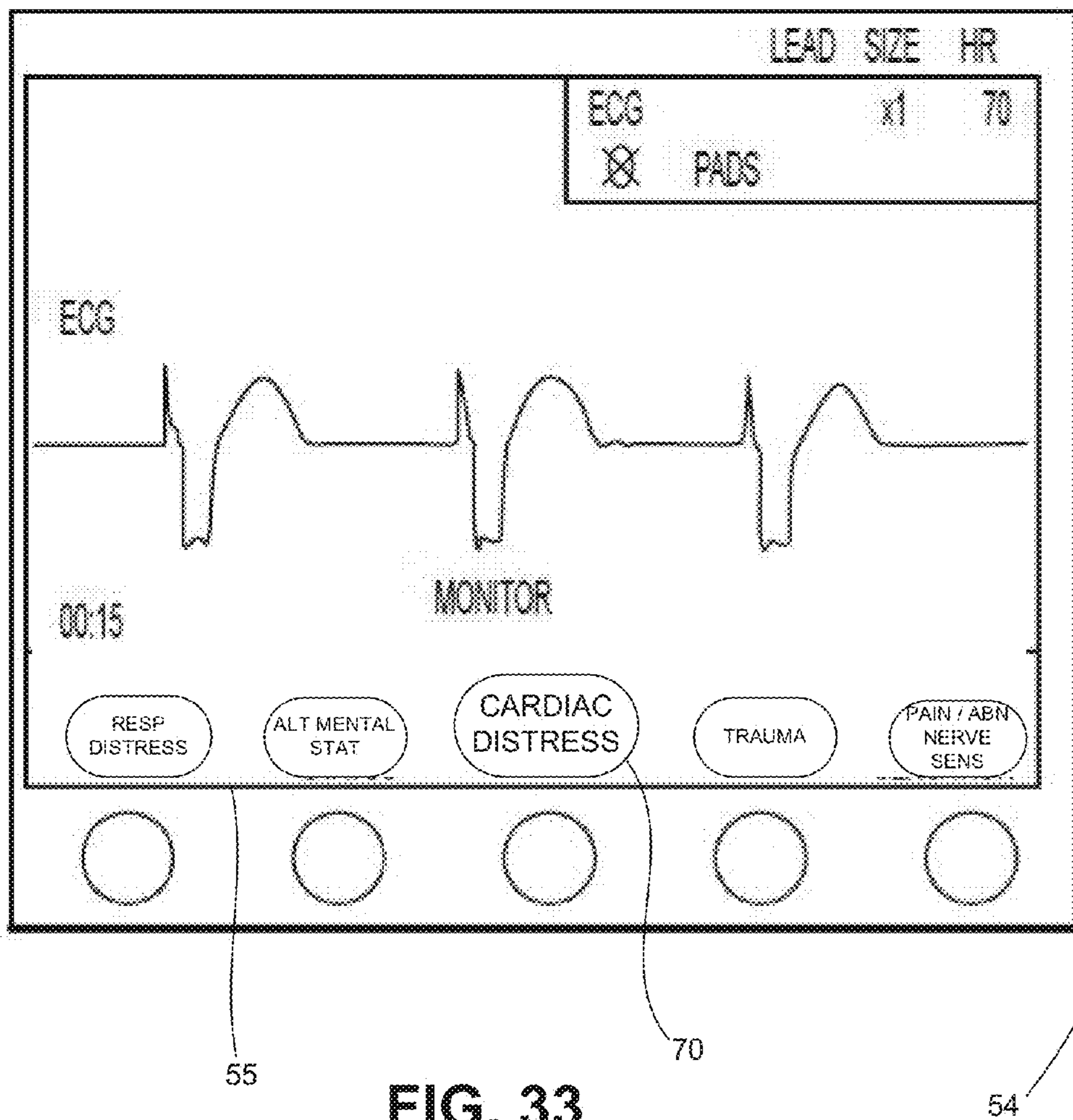

FIG. 33

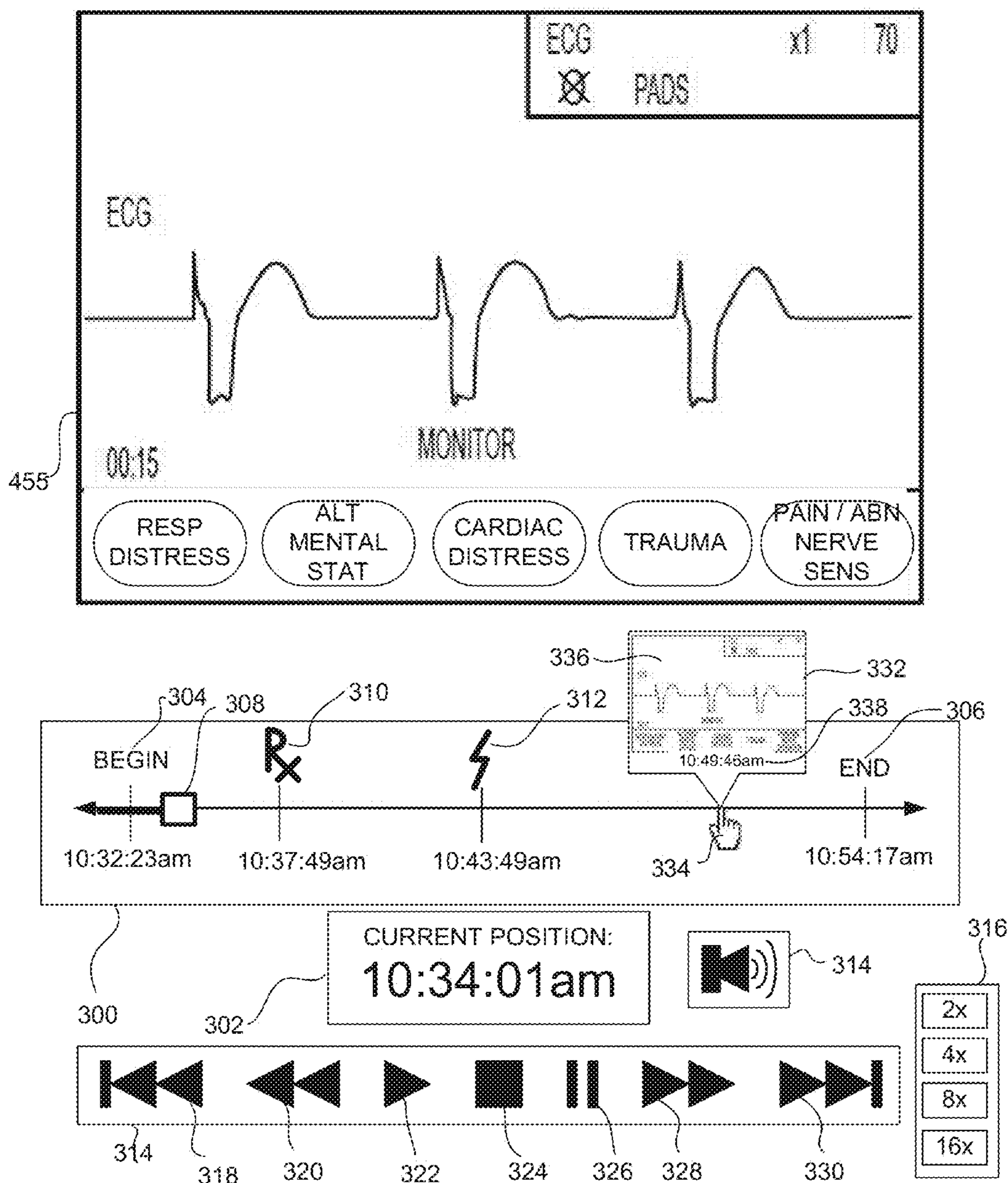

FIG. 34

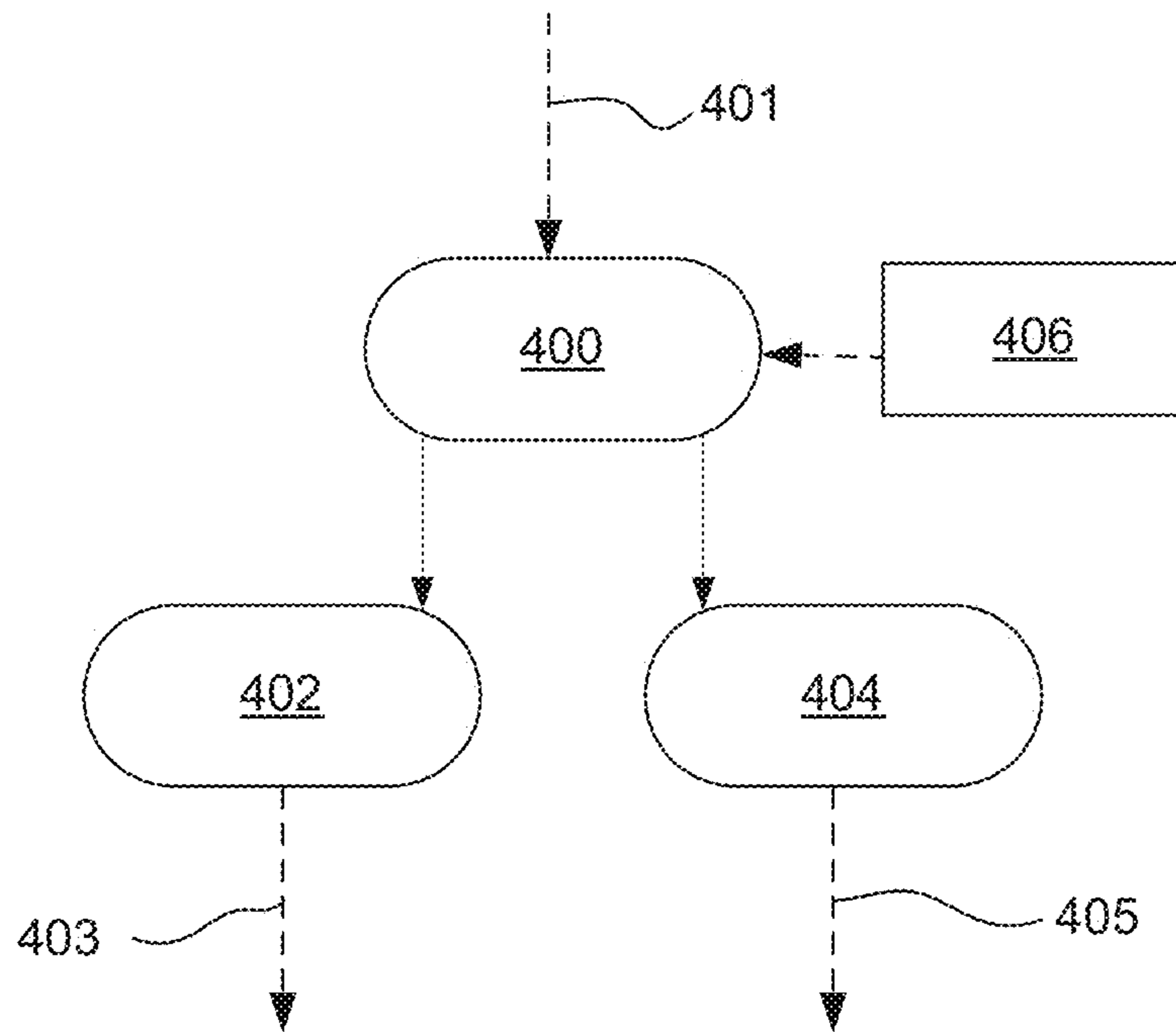

FIG. 35

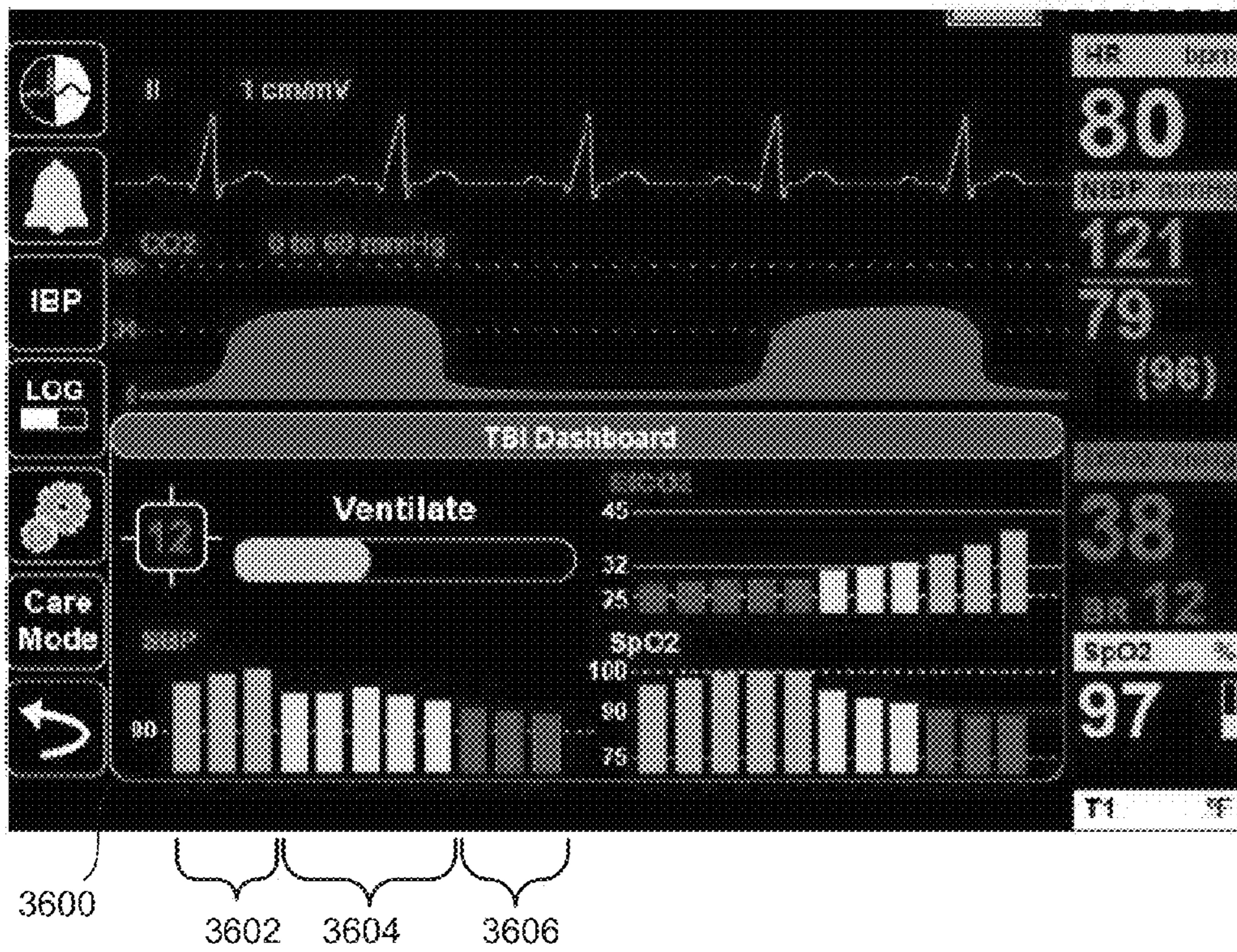

FIG. 36

EMS DECISION SUPPORT INTERFACE, EVENT HISTORY, AND RELATED TOOLS

CROSS-REFERENCE TO RELATED APPLICATIONS

This application claims the benefit of U.S. Provisional Patent Application Ser. No. 61/751,743, filed on Jan. 11, 2013, and of U.S. Provisional Patent Application Ser. No. 61/818,334, filed on May 1, 2013, both of which are incorporated herein by reference in their entireties for all purposes.

TECHNICAL FIELD

Embodiments of the present invention relate generally to tools for facilitating acute care treatment, and more specifically to systems and methods for clinical decision support and differential diagnosis.

BACKGROUND

In the pre-hospital and acute care treatment setting, medical responders often have difficulties in accurately determining the proper diagnosis of a particular patient. Even well-trained physicians often have difficulty under emergency conditions in which split second decisions are required with limited information. Computer-automated diagnosis was developed to improve the accuracy, effectiveness, and reliability of both field and hospital patient treatment.

Automated differential diagnosis utilizes computer inference algorithms such as Bayesian algorithms, neural networks, or genetic algorithms. According to a Wikipedia posting:

The Bayesian network is a knowledge-based graphical representation that shows a set of variables and their probabilistic relationships between diseases and symptoms. They are based on conditional probabilities, the probability of an event given the occurrence of another event, such as the interpretation of diagnostic tests. Bayes' rule helps us compute the probability of an event with the help of some more readily information and it consistently processes options as new evidence is presented. In the context of CDSS [(clinical decision support system)], the Bayesian network can be used to compute the probabilities of the presence of the possible diseases given their symptoms. Some of the advantages of Bayesian Network include the knowledge and conclusions of experts in the form of probabilities, assistance in decision making as new information is available and are based on unbiased probabilities that are applicable to many models. Some of the disadvantages of Bayesian Network include the difficulty to get the probability knowledge for possible diagnosis and not being practical for large complex systems given multiple symptoms. The Bayesian calculations on multiple simultaneous symptoms could be overwhelming for users. Example of a Bayesian network in the CDSS context is the Iliad system which makes use of Bayesian reasoning to calculate posterior probabilities of possible diagnoses depending on the symptoms provided. The system now covers about 1500 diagnoses based on thousands of findings. Another example is the DXplain system that uses a modified form of the Bayesian logic. This CDSS produces a list of ranked diagnoses associated with the symptoms.

Artificial Neural Networks (ANN) is a nonknowledge-based adaptive CDSS that uses a form of artificial intelligence, also known as machine learning, that allows the systems to learn from past experiences/examples and recognizes patterns in clinical information. It consists of nodes called neurodes and weighted connections that transmit signals between the neurodes in a unidirectional fashion. An ANN consists of 3 main layers: Input (data receiver or findings), Output (communicates results or possible diseases) and Hidden (processes data). The system becomes more efficient with known results for large amounts of data. The advantages of ANN include the elimination of needing to program the systems and providing input from experts. The ANN CDSS can process incomplete data by making educated guesses about missing data and improves with every use due to its adaptive system learning. Additionally, ANN systems do not require large databases to store outcome data with its associated probabilities. Some of the disadvantages are that the training process may be time consuming leading users to not make use of the systems effectively. The ANN systems derive their own formulas for weighting and combining data based on the statistical recognition patterns over time which may be difficult to interpret and doubt the system's reliability. Examples include the diagnosis of appendicitis, back pain, myocardial infarction, psychiatric emergencies and skin disorders. The ANN's diagnostic predictions of pulmonary embolisms were in some cases even better than physician's predictions. Additionally, ANN based applications have been useful in the analysis of ECG (a.k.a. EKG) waveforms.

A Genetic Algorithm (GA) is a nonknowledge-based method developed in the 1940s at the Massachusetts Institute of Technology based on Darwin's evolutionary theories that dealt with the survival of the fittest. These algorithms rearrange to form different re-combinations that are better than the previous solutions. Similar to neural networks, the genetic algorithms derive their information from patient data. An advantage of genetic algorithms is these systems go through an iterative process to produce an optimal solution. The fitness function determines the good solutions and the solutions that can be eliminated. A disadvantage is the lack of transparency in the reasoning involved for the decision support systems making it undesirable for physicians. The main challenge in using genetic algorithms is in defining the fitness criteria. In order to use a genetic algorithm, there must be many components such as multiple drugs, symptoms, treatment therapy and so on available in order to solve a problem. Genetic algorithms have proved to be useful in the diagnosis of female urinary incontinence.

Despite the fact that automated differential diagnosis systems have been developed and attempted to be implemented for more than 35 years now, they have not achieved any acceptance in the emergency medical setting for acute care treatment (ACT). In large part, this failure is due to the conditions under which emergency care of acute conditions are practiced. In those situations, such as the treatment of trauma, cardiac arrest or respiratory arrest, speed of decision-making is critical and caregivers already must split their time and attention between the patient and the physiological monitors and defibrillators. In such situations, automated differential diagnosis (ADD) tools are often viewed as interfering with the caregiving process and as a delay to

treatment of the patient. Given that every minute can result in a 10% drop in survival rate, such as is the case for cardiac arrest, it is not surprising that ADD tools are ignored by the very people that they were designed to assist.

It has also been found that much of the patient's medical history is inaccessible by the caregiver at the time of the acute medical condition because patients are often treated in the prehospital setting where family members are often not present at the time of the injury.

SUMMARY

Embodiments of the present invention include a system that provides a tool for the caregiver to more efficiently and accurately perform a differential diagnosis that is integrated into the caregivers existing workflow during emergency situations. Embodiments of the present invention may also provide an integrated view of physiological data from the patient, along with therapeutic treatment and patient history and examination findings, in an automated way to caregivers.

In Example 1, a method for code review of a medical event according to embodiments of the present invention includes displaying, on a first device screen, a user interface during the medical event; recording images of the user interface, each of the images representing an entirety of the user interface associated with a time during the medical event, wherein the images are recorded at least once every second; displaying, on a second device screen, a visual timeline indicator and a user interface replicator, the user interface replicator displaying the images of the user interface and the visual timeline indicator representing a time associated with each of the images, wherein the visual timeline indicator and the user interface replicator permit sequential playback and review of the user interface images from the medical event, and wherein the visual timeline indicator accepts user input to move the sequential playback to a different time associated with the medical event.

In Example 2, the method of Example 1, wherein the visual timeline indicator includes a timeline including a beginning time of the medical event and an end time of the medical event, the method further comprising indicating on the timeline the time associated with the image of the user interface shown in the user interface replicator.

In Example 3, the method of any of Examples 1-2, wherein the indicating on the timeline comprises using an indicator on the timeline to indicate the time associated with the image of the user interface shown in the user interface replicator.

In Example 4, the method of any of Examples 1-3, further comprising advancing the indicator along the timeline in a direction from the beginning time toward the end time during sequential playback of the user interface images.

In Example 5, the method of any of Examples 1-4, wherein the visual timeline indicator accepts user input by permitting scrolling of the indicator to a different position along the timeline.

In Example 6, the method of any of Examples 1-5, wherein the visual timeline indicator displays the time associated with each of the images in an hour-minute-second format.

In Example 7, the method of any of Examples 1-6, wherein the visual timeline indicator includes one or more event markers marking occurrence of clinically-relevant sub-events during the medical event.

In Example 8, the method of any of Examples 1-7, wherein the one or more event markers include a drug event

marker indicating a time at which a drug was administered to a patient during the medical event.

In Example 9, the method of any of Examples 1-8, wherein the one or more event markers include a defibrillation event marker indicating a time at which a defibrillation shock was applied to a patient during the medical event.

In Example 10, the method of any of Examples 1-9, wherein the one or more event markers include an ROSC event marker indicating a time at which a patient returned to spontaneous circulation.

In Example 11, the method of any of Examples 1-10, wherein the one or more event markers include a rearrest event marker indicating a time at which a patient returned to cardiac arrest.

In Example 12, the method of any of Examples 1-11, wherein the one or more event markers include an alarm event marker indicating a time at which an alarm was activated.

In Example 13, the method of any of Examples 1-12, further comprising displaying a cursor on the second device screen and, when the cursor is hovered over or near a time represented by the visual timeline indicator, displaying on the second screen at or near the cursor the image of the user interface associated with the time.

In Example 14, the method of any of Examples 1-13, further comprising, when the cursor is hovered over or near the time, displaying at or near the cursor a textual representation of the time.

In Example 15, a method for decision support during a medical event according to embodiments of the present invention includes displaying, on a screen on a device, a user interface during the medical event, wherein the user interface comprises two or more softkeys each representing a possible user selection; collecting physiological data from a patient with the device; determining, based on the physiological data, which one of the two or more softkeys represents the possible user selection that most closely conforms to a treatment or diagnosis protocol; and based on the determination, visually distinguishing the one of the two or more softkeys from the others of the two or more softkeys on the user interface.

In Example 16, the method of Example 15, wherein visually distinguishing the one of the two or more softkeys comprises making the one of the two or more softkeys larger than the others of the two or more softkeys.

In Example 17, the method of any of Examples 15-16, wherein visually distinguishing the one of the two or more softkeys comprises changing a position of the one of the two or more softkeys on the user interface.

In Example 18, the method of any of Examples 15-17, wherein visually distinguishing the one of the two or more softkeys comprises changing a color of the one of the two or more softkeys on the user interface.

In Example 19, the method of any of Examples 15-18, wherein visually distinguishing the one of the two or more softkeys comprises changing a border of the one of the two or more softkeys on the user interface.

In Example 20, the method of Examples 15-19, wherein visually distinguishing the one of the two or more softkeys comprises making the one of the two or more softkeys dynamically flash on the user interface.

In Example 21, the method of Examples 15-20 wherein visually distinguishing the one of the two or more softkeys comprises displaying on the screen a legend describing why the one of the two or more softkeys has been visually distinguished.

5

In Example 22, the method of Examples 15-21, wherein the one of the two or more softkeys is a cardiac distress softkey, and wherein the legend textually indicates a possible cardiac arrhythmia.

In Example 23, a method for decision support during a medical event according to embodiments of the present invention includes displaying, on a first screen on a first device, a user interface during the medical event, wherein the user interface comprises two or more softkeys each representing a possible user selection; collecting physiological data from a patient with the first device; displaying, on a second screen on a second device, a visual representation of a clinical decision support tree and an indication of a current node on the clinical decision support tree, wherein the two or more softkeys each represent the possible user selection from the current node on the clinical decision support tree.

In Example 24, the method of Example 23, wherein the visual representation of the clinical decision support tree includes, in addition to the current node, at least one prior node and at least one subsequent node.

In Example 25, the method of any of Examples 23-24, wherein selection of one of the two or more softkeys advances the indication of the current node on the second screen to a subsequent node as selected by the one of the two or more softkeys.

In Example 26, the method of any of Examples 23-25, wherein the second screen permits scrolling and resizing of the visual representation of the clinical decision support tree.

In Example 27, the method of any of Examples 23-26, wherein the visual representation of the clinical decision support tree is centered at the current node on the second screen.

In Example 28, the method of any of Examples 23-27, wherein the visual representation of the clinical decision support tree is positioned on the second screen based on the current node.

In Example 29, the method of any of Examples 23-28, wherein the visual representation of the clinical decision support tree on the second screen is positioned based on the current node, and wherein the selection of the one of the two or more softkeys repositions the visual representation of the clinical decision support tree on the second screen based on the subsequent node.

In Example 30, the method of any of Examples 23-29, wherein the visual representation of the clinical decision support tree on the second screen is centered at the current node, and wherein the selection of the one of the two or more softkeys recenters the visual representation of the clinical decision support tree on the second screen at the subsequent node.

In Example 31, a method for decision support during a medical event according to embodiments of the present invention includes: during the medical event, collecting physiological data from a patient at a first frequency with a patient monitoring device; guiding a user through a clinical decision support process with a display screen during the medical event; determining, with the clinical decision support process, a status of a patient; and based on the status of the patient, selecting a second frequency at which to collect the physiological data from the patient.

In Example 32, the method of Example 31, further comprising collecting the physiological data from the patient at the second frequency.

In Example 33, the method of any of Examples 31-32, wherein the status of the patient indicates traumatic brain

6

injury, and wherein the second frequency is selected to be greater than the first frequency.

In Example 34, the method of any of Examples 31-33, wherein the second frequency is at least once every five minutes.

In Example 35, a system for code review of a medical event according to embodiments of the present invention includes a first screen configured to visually display a clinical decision support tree used in the medical event; a second screen configured to visually display a replication of a user interface of a patient monitoring device as the user interface appeared at times during the medical event, wherein selecting a location within the clinical decision support tree on the first screen causes the second screen to display the replication of the user interface corresponding to a time during the medical event represented by the location within the clinical decision support tree.

In Example 36, the system of Example 35, wherein the second screen is part of the patient monitoring device.

In Example 37, the system of any of Examples 35-36, wherein the first screen is further configured to visually indicate on the clinical decision support tree a user's advancement through the clinical decision support tree in synchronization with advancement of the replication of the user interface on the second screen.

In Example 38, a method for decision support according to an embodiment of the present invention includes displaying, on a screen, a user interface during the medical event, wherein the user interface comprises trending information for a patient condition; collecting physiological data from a patient with a device; providing clinical decision support using at least some of the physiological data and at least some user input data; establishing a range for the patient condition based on the clinical decision support; and visually indicating on the user interface whether all or portions of the trending information is within the range.

In Example 39, the method of Example 38, wherein the screen is on the device.

In Example 40, the method of any of Examples 38-39, wherein visually indicating on the user interface whether all or portions of the trending information is within the range further comprises displaying portions of the trending information that falls outside of the range in a first color, and displaying portions of the trending information that falls within the range in a second color different from the first color.

In Example 41, the method of any of Examples 38-40, wherein the range is a first range, the method further comprising establishing a second range for the patient condition based on the clinical decision support, and visually indicating on the user interface whether all or portions of the trending information is within in the second range.

In Example 42, the method of any of Examples 38-41, further comprising establishing a third range for the patient condition based on the clinical decision support, wherein the first, second, and third ranges do not overlap each other, and visually indicating on the user interface whether all or portions of the trending information is within the third range.

In Example 43, the method of any of Examples 38-42, further comprising coloring portions of the trending information within the first range a first color, coloring portions of the trending information within the second range a second color, and coloring portions of the trending information within the third range a third color.

In Example 44, the method of any of Examples 38-43, wherein the first color is green, wherein the second color is yellow, and wherein the third color is red.

In Example 45, the method of any of Examples 38-44, wherein establishing the range for the patient condition based on the clinical decision support comprises establishing the range for the patient condition based on the patient's age, wherein the patient's age is acquired via the clinical decision support.

In Example 46, a method for decision support according to an embodiment of the present invention includes displaying, on a screen, a user interface during the medical event, wherein the user interface comprises dosing information display for a drug; collecting physiological data from a patient with a device; providing clinical decision support using at least some of the physiological data and at least some user input data; establishing a dosage recommendation for the drug based on the clinical decision support; and visually indicating the dosage recommendation on the dosing information display of the user interface.

In Example 47, the method Example 46, wherein the screen is on the device.

In Example 48, the method of any of Examples 46-47, wherein establishing the dosage recommendation based on the clinical decision support comprises establishing the dosage recommendation based on the patient's age, wherein the patient's age is acquired via the clinical decision support.

In Example 49, the method of any of Examples 46-48, wherein establishing the dosage recommendation based on the clinical decision support comprises establishing the dosage recommendation based on the patient's weight, wherein the patient's weight is acquired via the clinical decision support.

In Example 50, the method of any of Examples 46-49, wherein establishing the dosage recommendation based on the clinical decision support comprises establishing the dosage recommendation based on the patient's allergies, wherein the patient's allergies are acquired via the clinical decision support.

While multiple embodiments are disclosed, still other embodiments of the present invention will become apparent to those skilled in the art from the following detailed description, which shows and describes illustrative embodiments of the invention. Accordingly, the drawings and detailed description are to be regarded as illustrative in nature and not restrictive.

BRIEF DESCRIPTION OF THE DRAWINGS

FIG. 1 illustrates a clinical decision support system, according to embodiments of the present invention.

FIG. 2 illustrates a user interface for a medical device, according to embodiments of the present invention.

FIG. 3 illustrates the user interface of FIG. 2 upon selection of an acute care diagnosis mode, according to embodiments of the present invention.

FIG. 4 illustrates the user interface of FIGS. 2 and 3 upon selection of a respiratory distress mode, according to embodiments of the present invention.

FIG. 5 is a table describing a differential diagnosis outline for acute dyspnea in adults.

FIG. 6 is a table describing clues to the diagnosis of dyspnea.

FIG. 7 is a table listing physical examination findings in the diagnosis of acute dyspnea.

FIG. 8A is a top portion of a common medical protocol and differential diagnosis flow chart for adult shortness of breath.

FIG. 8B is a continuation of the common medical protocol and differential diagnosis flow chart of FIG. 8A.

FIG. 9 illustrates a carbon dioxide snapshot waveform which may be displayed on the user interface when selected by the user, according to embodiments of the present invention.

FIG. 10 illustrates the carbon dioxide snapshot waveform of FIG. 9 with displayed measurements, according to embodiments of the present invention.

FIG. 11 illustrates a tablet computing device docked on a defibrillator device, according to embodiments of the present invention.

FIG. 12 illustrates a protocol for use in patients with cardiac arrest.

FIG. 13 illustrates an example trauma assessment protocol.

FIG. 14 illustrates an example rapid trauma assessment protocol.

FIG. 15 illustrates an example focused physical exam protocol.

FIG. 16 illustrates an example amputation injuries protocol.

FIG. 17 illustrates an example bleeding control protocol.

FIG. 18 illustrates an example burns protocol.

FIG. 19 illustrates an example electrocution protocol.

FIG. 20 illustrates an example spinal immobilization protocol.

FIG. 21 illustrates additional steps in the spinal immobilization protocol of FIG. 20.

FIG. 22 illustrates an example multi-system trauma protocol.

FIG. 23 illustrates an example near drowning protocol.

FIG. 24 illustrates an example trauma in pregnancy protocol.

FIG. 25 illustrates an example traumatic cardiac arrest protocol.

FIG. 26 illustrates a clinical decision support system, according to embodiments of the present invention.

FIG. 27 illustrates a computer system, according to embodiments of the present invention.

FIG. 28 illustrates a user interface display of a clinical decision support tree, according to embodiments of the present invention.

FIG. 29 illustrates the user interface display of FIG. 28 with a portion of the clinical decision support tree resized, according to embodiments of the present invention.

FIG. 30 illustrates the user interface display of FIGS. 28 and 29 with an additional portion of the clinical decision support tree resized, according to embodiments of the present invention.

FIG. 31 illustrates a user interface display with dynamic softkeys, according to embodiments of the present invention.

FIG. 32 illustrates the user interface display of FIG. 31 with one softkey emphasized based on clinical decision support, according to embodiments of the present invention.

FIG. 33 illustrates the user interface display of FIG. 31 with one softkey emphasized in a different way, based on clinical decision support, according to embodiments of the present invention.

FIG. 34 illustrates a code review interface for reviewing user interface display data corresponding to a medical event, according to embodiments of the present invention.

FIG. 35 illustrates a portion of a clinical decision support tree, according to embodiments of the present invention.

FIG. 36 illustrates a user interface display, according to embodiments of the present invention.

While the invention is amenable to various modifications and alternative forms, specific embodiments have been

shown by way of example in the drawings and are described in detail below. The intention, however, is not to limit the invention to the particular embodiments described. On the contrary, the invention is intended to cover all modifications, equivalents, and alternatives falling within the scope of the invention as defined by the appended claims.

DETAILED DESCRIPTION

FIG. 1 shows a block diagram of the system, according to embodiments of the present invention. In one embodiment, a combined defibrillator/monitor device such as the E-Series manufactured by ZOLL Medical of Chelmsford Mass. has keys whose labeling is provided by on-screen text. The text is thus configurable in real time either due to input by the user or as a result of analysis and decision making by the defibrillator or other devices with which the defibrillator is in communication at the time of the defibrillator's use, such as the computer tablet device 214 or remote base station staffed by medical dispatch or medical supervisory personnel in communication with the computer tablet. The computer tablet may take the form of an iPad (Apple Corp., Cupertino Calif.). Such screen-labeled keys may be referred to as "soft-keys". A specific soft-key is initially labeled "Acute Care diagnose" at device turn-on as shown in FIG. 2, according to embodiments of the present invention. Upon detecting a key press of the Acute Care Diagnose key, the defibrillator changes the functionality and labeling of the keys to those shown in FIG. 3. These five labels—"Respiratory Distress" or alternatively "Dyspnea", "Altered Mental Status", "Cardiac Distress", "Trauma" and "Pain/Abnormal Nerve Sensation"—differ from the traditional symptoms associated with differential diagnosis in that they identify classes of patients and potential workflows and diagnosis and treatment pathways (DTP), and are listed in relative frequency with which paramedics and other emergency personnel encounter patients meeting these criteria in actual practice.

By pressing the soft-key for each DTP, the defibrillator is then configured to potentially activate certain physiological sensors and display the sensor data in such a way as to provide the caregiver the optimal information, presented in the optimal fashion so as to diagnose and treat the patient most accurately and efficiently. Each DTP may include a template according to which sensor data, or the physiological and/or measurement data derived therefrom, is displayed in a way most useful and/or efficient for that particular DTP. For instance, if the "Respiratory Distress" soft-key is pressed, then the waveforms and numeric physiologic data on the screen change to that shown in FIG. 4. Stored snapshots of individual CO₂ breath waveforms may be initiated via the CO₂ Snapshot soft-key. These snapshots remain on the display for reference to the clinician both for automating measurements for diagnosis as well as for assessing the effectiveness of a particular therapy.

Heart sound measurement and detection may be incorporated into the monitoring device for the detection of S3 and S4 heart sounds and automatically narrow the differential, or suggest for the rescuer to confirm agreement with the software diagnosis, of heart failure or pulmonary edema. A flowchart for evaluating heart sounds is shown in FIGS. 8A and 8B. Pulse oximetry and capnography are also very helpful measures and may be automatically incorporated into the algorithm for more accurate diagnosis. The same sensors used to detect heart sounds may also be employed to detect breath sounds and to analyze their quality. Specific

algorithms may be employed to detect wheezing, crackles, rale or stridor, each of which may be indicative of a particular disease.

Sensors such as flow sensors and O₂ gas sensors are included in some embodiments, so that the additional physiological measurements such as volumetric Co₂, volumetric O₂ and spirometry, which are relevant for diagnosis and treatment of dyspnea, may be included and displayed on the Respiratory Distress DTP screen. An oxygen sensor may be located in the patient's airway, which may assist in calculating the metabolic needs of the patient.

The display on the defibrillator 212 is a touchscreen, according to some embodiments of the present invention. The caregiver can easily initiate measurements such as on the CO₂ snapshot waveform or the spirometry snapshot waveform via touchscreen gesture such as a double tap. A zoom icon may exist in the upper corner of each waveform box, such as the CO₂ snapshot, such that when the zoom button is touched, that particular waveform fills the display of the defibrillator. Another measurement button is present which, when touched, displays all the relevant measurements for a particular waveform, according to embodiments of the present invention. A gestural interface is provided as part of the touchscreen. Using two fingers or finger and thumb to touch to two points in the waveform (which may also be referred to as a "caliper" measurement or gesture) will cause measurements to be displayed and/or overlaid onto the physiological data, as illustrated in FIG. 10. For instance, dead space volume, phase II and III slopes which are indicative of COPD, and estimates of arterial pCO₂ may be listed on the screen after initiation of CO₂ waveform measurement.

According to embodiments of the present invention, the processor communicably coupled with the touchscreen portion of a decision support system may be configured to recognize the wave shape of a wave signal being displayed, and/or recognize the edge of an image being displayed, in order to improve the accuracy of a caliper touch gesture. For example, if a user were to use a caliper gesture to measure or "zoom in" on an ST elevation in an ECG wave display, the decision support system may be configured to recognize that if one of the user's fingers taps just below the top of the ECG wave, that the user likely intended to include the top of the ECG wave in the enlarged or selected view. In addition, the decision support system may be configured to permit an ability to enlarge (zoom) and adjust measurement points individually using the touchscreen. A tap/click and drag method may be used to set the caliper gesture; for example, to hone in on a particular portion of displayed waveform, the user may press on one point and drag to another point to indicate the endpoints of the caliper gesture.

Specific out-of-range readings can be displayed in red or highlighted by other mechanisms, such as bold-face font and/or flashing. Touching the highlighted values will cause the display to show the possible diagnoses which are consistent with the measurements, according to embodiments of the present invention. A specific graphical zone of the screen can be designated with a graphical image of the computer tablet. By dragging waveforms, measurements, or any other data object shown on the display over onto the computer tablet icon, it can automatically be presented on the computer tablet that is linked to the defibrillator.

Capnography is helpful in the assessment of asthma, where an increased slope in the expiratory plateau provides a measure of bronchospasm. The slope of the plateau phase (phase III) provides a measure of airway obstruction. The

adequacy of b-agonist bronchodilatory therapy for an asthma exacerbation may be monitored through observation of slope change of phase III.

As referenced in U.S. Patent Application Publication No. 2011/0172550, published on Jul. 14, 2011, which is incorporated by reference herein in its entirety for all purposes, the data for the patient's history may be entered via the computer tablet with patient physiological measures via the monitor. As the differential diagnosis often implicates both patient history, patient examination findings along with measures of the patient's physiological state via such monitoring as ECG, capnography and pulse oximetry, these data elements are integrated into a user interface that automatically or semi-automatically integrates the various data elements on a single differential diagnosis screen within the application on the computer tablet. The interface may begin by asking the rescuer to choose from a list of common presenting symptoms or complaints by the patient, for example dyspnea or respiratory distress. The information such as on the screens of FIGS. 5, 6, and 7 (taken from Am Fam Physician 2003; 68:1803-10) provides one possible structured approach for rescuers to obtain information. As patient history and physical examination findings are entered on the computer tablet, the differential diagnosis page will gradually narrow down the possible diagnoses.

In another embodiment, the defibrillator contains a docking feature for propping up a computer tablet such as an Apple® iPad® on top of the defibrillator in a stable position via mounting features integrated onto the defibrillator, as illustrated in FIG. 11. Other mobile computing devices, including tablet computers, an iPhone®, an iTouch®, and other touchscreen monitors may be used. Alternatively, a low power, battery powered, touchscreen monitor may be used, such as, for example, those that transfer information to and from a computing device via a wired or wireless USB connection. Communication may be provided wirelessly between the two devices (the medical device and the mobile computing device, for example). Other communicable coupling may be achieved between the two devices; for example, wired. The iPad may include a protective housing and/or waterproof housing to protect it from the typical physical abuse it would likely encounter in the prehospital environment. Mounting features integral to such an iPad housing allow it to be easily attached on top of the defibrillator on scene. The mounting feature on the defibrillator may be able to hinge to allow the iPad® to hinge down when not in use into a protective pocket on the defibrillator. The iPad® may also be undocked and used nearby to the defibrillator, without need for physical connection. A physical slot may also be provided, preferably at the side, top or back of the unit that allows for the iPad® to have its battery charged by the defibrillator. Internal to the frame of the iPad® protective housing is the standard iPad® connector, while on the exterior of the frame of the iPad® protective housing are much more robust mechanical and electrical connections that can withstand the extensive abuse experienced by medical devices in the prehospital emergency setting, according to embodiments of the present invention.

The results of this integrated analysis of physiological data, patient history and examination findings may then be displayed on the defibrillator, potentially in the form of asking to make an additional physiological measurement. The results of this integrated analysis of physiological data, patient history and examination findings may alternatively, or additionally, be displayed on the tablet computer. According to some embodiments of the present invention, the tablet computer, or other mobile computing device, may be com-

municably coupled with the defibrillator or other physiological assessment device, for example through a wireless connection. As used herein, the phrase "communicably coupled" is used in its broadest sense to refer to any coupling whereby information may be passed. Thus, for example, communicably coupled includes electrically coupled by, for example, a wire; optically coupled by, for example, an optical cable; and/or wirelessly coupled by, for example, a radio frequency or other transmission media. "Communicably coupled" also includes, for example, indirect coupling, such as through a network, or direct coupling.

According to embodiments of the present invention, a user interface device is communicably coupled to a processor, and the processor is configured to receive data entered via the user interface device, as well as data received from one or more sensors, in order to perform clinical decision support based on both data sources. The user interface device may include one or more devices such as a touch screen computer, a tablet computer, a mobile computing device, a smart phone, an audio receiver, an audio transmitter, a video receiver, a video transmitter, a camera, and a "heads up" display projected onto a user's glasses or face shield. A small monitor may be mounted onto eyeglasses, a face shield, and/or integrated with other wearable communications devices, such as, for example, an ear bud or a Bluetooth® hands free phone adaptor. The user interface device may include a combination of devices for conveying options and receiving input; for example, an audio speaker may be used to convey possible DTPs, and an audio receiver may be used to receive a verbal command indicating a selection of one of the DTPs. Instead of an audio receiver, a video camera may be used to receive a gestural command that will be interpreted by the processor as a selection of one of the possible DTPs, or input elements. Using hands-free devices for user interface devices may free the hands of a caregiver to perform clinical tasks, while still permitting non-intrusive decision support and/or differential diagnosis for the caregiver.

FIGS. 8A and 8B illustrate a differential diagnosis and/or clinical support process through which a computer processor may take a caregiver, using the user interface device, according to embodiments of the present invention. For example, if the caregiver selected "Respiratory Distress" from among the five DTPs presented on the screen of FIG. 3, then the user interface device would prompt the caregiver to input information about step 802 in the flowchart of FIG. 8, which flows from top to bottom. At step 802, if the 12-lead reveals an S3 heart sound, or if the Dyspnea Engagement Score is greater than 3, then the decision support system will take the user through the Acute Decompensated Heart Failure (CHF) decision/diagnosis process.

The decision support system may take into account both physiological data received from sensors, and information data received from the caregiver (e.g. via mobile computing device such as an iPad®), in helping the caregiver move from one decision point in the flow chart to the next, while updating any display or information provided along the way. For example, the decision support system may indicate to the user that, based on processing of the ECG data, there does not appear to be an S3 heart sound present, and ask the caregiver to confirm this assessment. The decision support system may also, or alternatively, request the caregiver to enter a Dyspnea Engagement Score, or suggest one for confirmation by the caregiver. At step 802, if the 12-lead reveals no S3 heart sound, or if the Dyspnea Engagement Score is less than 3, then the decision support system will recognize that the caregiver is not dealing with a CHF

situation, but then moves to step **804** in which the decision support system changes its display and/or input prompts in order to help the caregiver determine whether to enter the Asthma treatment path or the COPD treatment path.

Again, the decision support system may factor in various physiological data from sensors, as well as various informational data received about the particular patient, in helping to support the caregiver's decision. For example, as illustrated in FIG. 6, if the patient information (either entered by the caregiver or obtained from another source) indicates that the patient is involved in heavy tobacco use, the decision support system will recognize at step **804** that a COPD diagnosis is more likely, whereas if the caregiver indicates to the decision support system that the patient is experiencing a cough, or has a history of asthma, the decision support system may recognize at step **804** that an Asthma diagnosis is more likely. In addition to, or alternatively to, the informational diagnosis support reflected in FIG. 6, the decision support system may gather findings using physiological data to help the caregiver determine the appropriate treatment path. For example, if a breathing or breath sound sensor generates data that, when processed, indicates clubbing, barrel chest, or decreased breath sounds, the decision support system may recognize at step **804** that a COPD treatment path is more appropriate, whereas if the breath sound sensor generates data indicative of pulsus paradoxus, or if a muscle activity sensor indicates accessory muscle use, the decision support system may recognize at step **804** that an Asthma treatment path is more appropriate.

According to embodiments of the present invention, the decision support system may suggest or propose a diagnosis or treatment path, for example by indicating statistical probabilities (based on charts and data such as those of FIGS. 6 and 7) or relative likelihoods, and ask for confirmation or final selection by the caregiver. For example if at step **804** the decision support system receives confirmation of an Asthma diagnosis, then the user interface device may change the information presented to the caregiver, for example by launching into a treatment protocol specific to the Asthma diagnosis. At step **806**, the decision support system may suggest that the caregiver attach a humidifier to the patient's oxygen supply, and administer 2.5 milligrams of albuterol mixed with 0.5 milligrams of Atrovent administered by nebulizer connected to a 6-9 liter per minute source, and may indicate that the dosage may be administered continuously as long as the heart rate is not greater than 140. The decision support system may monitor the heart rate, and give a visual and/or audio indication when and if the heart rate reaches or approaches 140, in this example.

At step **808**, the decision support system may help the caregiver decide whether the patient is extremely bronchoconstricted, for example by showing data or measurements related to blood oxygen content, respiration rate, or respiration volume. Upon a confirmation by the caregiver that the patient is extremely bronchoconstricted at step **808**, the decision support system may then suggest to the caregiver that a 125 milligram dose of Solumedrol be administered over a slow (e.g. 2 minute) intravenous push. At step **810**, the decision support system may help the caregiver to decide whether the patient's symptoms have improved (e.g. whether the patient's shortness of breath has improved with the treatment thus far). For example, the decision support system may display and/or analyze the patient's end-tidal waveform, and suggest that the patient does not appear to be responding to the treatment, and ask for the caregiver's confirmation. If the caregiver confirms the decision, then the decision support system may continue to guide the caregiver

through additional treatment options, for example those indicated in FIG. 8. In this way, the decision support system guides the caregiver through complex decision making processes, during the clinical encounter, using both physiological data and informational data gathered from the patient or input by the caregiver, in a way which would be too inconvenient or time-consuming for the caregiver to perform absent the decision support system.

The decision support according to embodiments of the present invention may or may not be fully automated. Inference engines utilizing Bayesian networks, neural networks, genetic algorithms, or simpler rule-based systems may be employed.

In another embodiment, the tissue CO₂ or pH are measured by methods such as those described in U.S. Pat. No. 6,055,447, which describes a sublingual tissue CO₂ sensor, or U.S. Pat. Nos. 5,813,403, 6,564,088, and 6,766,188, which describe a method and device for measuring tissue pH via near infrared spectroscopy (NIRS), and which are all incorporated herein by reference in their entirety for all purposes. NIRS technology allows the simultaneous measurement of tissue PO₂, PCO₂, and pH. One drawback of previous methods for the measurement of tissue pH is that the measurements provided excellent relative accuracy for a given baseline measurement performed in a series of measurements over the course of a resuscitation, but absolute accuracy was not as good, as a result of patient-specific offsets such as skin pigment. One of the benefits achieved by some embodiments of the present invention is the elimination of the need for absolute accuracy of these measurements, and the reliance on only the offset and gain being stable over the course of the resuscitation. Tissue CO₂ and pH are particularly helpful in monitoring in the trauma DTP. Physiological parameters on display for the trauma DTP may be one or more of: invasive and non-invasive blood pressure, tissue CO₂ and pH, ECG, SpO₂ trending, and heart rate variability risk index. The ECG may be analyzed to determine the interval between adjacent R-waves of the QRS complexes and using this interval to calculate heart rate variability as a running difference between adjacent R-R intervals. It is known to those skilled in the art that an abrupt reduction in variability will often precede by many minutes a precipitous decline in a patient's blood pressure (traumatic arrest). By monitoring the trend in heart rate variability, the traumatic arrest can be anticipated and prevented.

Another sensor of use for the trauma DTP is ultrasound, according to embodiments of the present invention. According to C. Hernandez et al., *C.A.U.S.E.: Cardiac arrest ultra-sound exam—A better approach to managing patients in primary non-arrhythmogenic cardiac arrest*, Resuscitation (2007), doi:10.1016/j.resuscitation.2007.06.033, which is incorporated by reference herein in its entirety for all purposes:

C.A.U.S.E. is a new approach developed by the authors.

The C.A.U.S.E. protocol addresses four leading causes of cardiac arrest and achieves this by using two sonographic perspectives of the thorax; a four-chamber view of the heart and pericardium and anteromedial views of the lung and pleura at the level of the second intercostal space at the midclavicular line bilaterally. The four-chamber view of the heart and pericardium is attained using either the subcostal, parasternal or apical thoracic windows. This allows the individual performing the examination to select the most adequate view depending on the patients' anatomy. The authors recommend beginning with the subcostal view first as this view makes it possible for the practitioner to evaluate

the heart without interrupting chest compression. If this view is not possible then the apical or parasternal approaches may be used during coordinated pulse checks lead by the resuscitation team leader. A four-chamber view is used in this protocol as it allows for ease of comparison between the different chambers in the heart, facilitating the diagnosis of hypovolemia, massive PE, and cardiac tamponade (FIG. 6). Pneumothorax is diagnosed by identifying the lack of sliding sign and comet-tail artifact while looking in the sagittal plane at the second intercostal space of the midclavicular line (FIG. 7). For both the cardiac and lung views it is recommended to use a 2.5-5.0 phased array transducer probe. This allows the examiner to use the same probe for both lung, heart and if needed abdominal exam. This type of probe was used by Knudtson in his study involving ultrasound for the use of identifying pneumothorax as an addition to the FAST exam, and it yielded very a high accuracy in detecting pneumothorax, yet still remained useful in identifying the heart and abdominal organs. The protocol is best described in diagram form. [see FIG. 12]

The caregiver selecting elements of the flowchart results in the ultrasound sensor being activated and images presented on the computer tablet. Additional instructions can be requested from the interface on either the computer tablet and/or the defibrillator. Based on the selections and instructions, the settings of the ultrasound can be adjusted to deliver the optimal images, according to embodiments of the present invention.

Although five diagnosis and treatment pathways are discussed with respect to FIG. 3, the differential diagnosis/decision support system may be configured to support decision making and diagnosis with respect to other DTPs, and may be configured to display and support various combinations of one or more DTPs, from among the five shown in FIG. 3 and others. According to other embodiments of the present invention, each user may configure the decision support system to use customized DTP for each DTP option; for example, the user may change the default series of questions/steps/readings for the Trauma DTP with a new series of questions/steps/readings based on caregiver-specific, patient-specific, geography-specific, and/or regulation-specific treatment protocols. In this way, the decision support system according to embodiments of the present invention operates to guide decision making and diagnosis for a caregiver in a way that accommodates various kinds of DTPs.

For example, if a user selected the Trauma DTP option from the screen of FIG. 3, the decision support system may be configured to guide a user through a decision and treatment pathway similar to that shown in FIGS. 13-25. The user would then be presented with a series of further options, such as "amputation injury," "bleeding control," "burns," and the like. Selecting one of these further options would then cause the decision support system to enter and display the particular pathway or pathways relevant to the selected option. According to embodiments of the present invention, the decision support system is comprised by a user interface device, independent of a medical device or one or more sensors, in a way which simply guides the caregiver through a series of decisions according to a pre-established flow chart. At a basic level, a medical device, such as a defibrillator, may include one or more decision support flow charts and/or treatment protocols, which guide the caregiver through various decisions, either with or without sensor data

or other data input. A graphical DTP may be included in a defibrillator device as a reference document, electronically navigable.

According to other embodiments, the decision support system is informed by a combination of caregiver observations, patient information, and/or sensor data. Assessment and/or scoring may be performed, either by receiving data from the caregiver, or receiving data from sensors, or both. For example, for a trauma DTP, the decision support system may take into account pulse rate, breathing data, qualitative breathing data, pulse rate, blood loss, blood pressure, presence of broken limbs, and/or compound fractures. Or, in a cardiac distress DTP, the decision support system may be configured to display a cardiac arrest probability at a moment in time, which may be calculated and/or predicated by the decision support system based on selected criteria. The decision support system may also be configured to track certain criteria in order to suggest treatment outcome probabilities, for example suggesting the treatment pathway with the highest or a high perceived probability of success.

According to some embodiments of the present invention, a monitor, or a defibrillator/monitor combination, or other similar device, may be configured to provide a graphical tool to configure the monitor to follow recognized rescue protocols, for example one or more of the protocols described and/or shown herein. Such a tool may be included on the monitor or defibrillator device, on a tablet or handheld or other computing device, and/or on both, according to embodiments of the present invention. Such a tool may be provided in a graphical interface, for example a flowchart. The tool allows the user to configure the patient monitor to follow a particular rescue protocol, for example by visually presenting a flow chart for the protocol and allowing the user to customize the protocol. For example, the length of the CPR period may be configured by the user to customize the treatment protocol. Such a tool may also permit the downloading and uploading of customized treatment protocols to and/or from a monitoring device, which may also permit the same customized protocol settings to be carried on a mobile device and/or transferred or uploaded to multiple other devices in different locations and/or at different times, according to embodiments of the present invention.

FIG. 26 illustrates a clinical decision support system 2600, according to embodiments of the present invention. System 2600 includes a processor 150 which is communicably coupled to a database 152, a decision support module 153, a display 156, and a patient monitor and/or defibrillator 154, which may itself be communicably coupled to another display module 155, according to embodiments of the present invention. Some or all of the elements shown in FIG. 26 may be part of, or implemented by, one or more computer systems as illustrated in FIG. 27.

FIG. 27 is an example of a computer or computing device system 200 with which embodiments of the present invention may be utilized. For example, defibrillator 154 and/or the tablet shown in FIG. 11 may be or incorporate a computer system 200, according to embodiments of the present invention. According to the present example, the computer system includes a bus 201, at least one processor 202, at least one communication port 203, a main memory 208, a removable storage media 205, a read only memory 206, and a mass storage 207.

Processor(s) 202 can be any known processor, such as, but not limited to, an Intel® Itanium® or Itanium 2® processor (s), or AMD® Opteron® or Athlon MP® processor(s), or Motorola® lines of processors, or any known microprocessor or processor for a mobile device, such as, but not limited

to, ARM, Intel Pentium Mobile, Intel Core i5 Mobile, AMD A6 Series, AMD Phenom II Quad Core Mobile, or like devices. Communication port(s) **203** can be any of an RS-232 port for use with a modem based dialup connection, a copper or fiber 10/100/1000 Ethernet port, or a Bluetooth® or WiFi interface, for example. Communication port(s) **203** may be chosen depending on a network such a Local Area Network (LAN), Wide Area Network (WAN), or any network to which the computer system **200** connects. Main memory **208** can be Random Access Memory (RAM), or any other dynamic storage device(s) commonly known to one of ordinary skill in the art. Read only memory **206** can be any static storage device(s) such as Programmable Read Only Memory (PROM) chips for storing static information such as instructions for processor **202**, for example.

Mass storage **207** can be used to store information and instructions. For example, flash memory or other storage media may be used, including removable or dedicated memory in a mobile or portable device, according to embodiments of the present invention. As another example, hard disks such as the Adaptec® family of SCSI drives, an optical disc, an array of disks such as RAID (e.g. the Adaptec family of RAID drives), or any other mass storage devices may be used. Bus **201** communicably couples processor(s) **202** with the other memory, storage and communication blocks. Bus **201** can be a PCI/PCI-X or SCSI based system bus depending on the storage devices used, for example. Removable storage media **205** can be any kind of external hard-drives, floppy drives, flash drives, zip drives, compact disc-read only memory (CD-ROM), compact disc-re-writable (CD-RW), or digital video disk-read only memory (DVD-ROM), for example. The components described above are meant to exemplify some types of possibilities. In no way should the aforementioned examples limit the scope of the invention, as they are only exemplary embodiments of computer system **400** and related components.

As shown in FIG. **26**, the decision support module **153** may be a clinical support and/or differential diagnosis and/or treatment protocol as described herein. Based on information about the patient received from monitor **154**, the decision support module **153** determines and/or shows to the user a set or array of next available options in the decision tree. Alternatively, the decision support module **153** may be configured to calculate probabilities or other statistics based on decision support trees, algorithms, and/or historical data.

Because the display module **155** of the monitor **154** is used for patient-critical monitoring or treatment functions, and because the monitor **154** must often be small or portable, there may be limited size availability on the display device which display module **155** operates. As such, embodiments of the present invention include a separate display **156** which is available to the user or to someone other than the user in order to view information about a particular decision support process being implemented by the processor **150** and, optionally, by the patient monitor **154**. When a user decides to implement a decision support process, a selection may be made on the user interface screen operated by the display module **155**, and/or may be made on the user interface operated by display module **156**. This then prompts the processor **150** to access a clinical decision support process via decision support module **153**. Decision support module **153** may include logic to guide the user through the various nodes and/or branches of a clinical decision support process, for example those shown in FIGS. **5-8B** and **12-25**. According to some embodiments of the present invention, the display module **155** operates the display screen of a

monitor/defibrillator as shown in FIG. **11**, and the display module **156** operates a tablet computer screen. Such a tablet computing device may be communicably coupled to the processor **150** (whether such processor is located in the monitor/defibrillator or the tablet computing device) by docking it into a communications dock on the monitor/defibrillator as shown in FIG. **11**, and/or may be communicably coupled to the processor **150** wirelessly. Based on the disclosure provided herein, one of ordinary skill in the art will recognize that patient monitor **154** may include its own processor, and tasks described as performed by processor **150** may be distributed across one or multiple processors and/or physical devices.

FIG. **28** illustrates one example of a decision support tree that may be shown to a user on an auxiliary screen (operated by module **156**) during a medical event, to guide the user through a treatment protocol or pre-diagnosis of the patient. The decision support module **153** may be navigated through the various decision points (e.g. “nodes”) either by manual selection of the next available option or branch, or by complete or partial automatic selection of the next available option or branch based upon patient data collected during the medical event, for example physiological data collected by the patient monitor/defibrillator **154** that is connected to the patient, or by a combination of these two processes. A process that is wholly or partially automatic may also be configured to prompt a user for confirmation before moving to a subsequent or previous node, according to embodiments of the present invention.

Due to the time critical nature of a medical first responder’s tasks, such a medical first responder has limited attention resources. In order to further simplify such a user’s interface with a decision support module **153**, the processor **150** may be configured to dynamically adjust the display screen **156** during the medical event. As one example, FIG. **28** illustrates a user interface display of a clinical decision support tree, according to embodiments of the present invention. This decision support tree begins at block **2**, and the first decision is between blocks **4** or **24**. If block **4** is selected, the decision is next between blocks **6** and **8**. If block **6** is selected, the next decision is between blocks **10** and **12**. Although one or two possible branches or decisions are shown, one of ordinary skill in the art will appreciate, based on the disclosure provided herein, that any number of branches or decision options may be provided to extend from a particular node, and that such branches could overlap and/or loop back to a previous node, according to embodiments of the present invention. The remaining blocks **14**, **16**, **18**, **20**, **22**, **24**, **26**, **28**, **30**, **32**, **34**, **36**, **38**, **40**, and **42** may function in a similar manner.

FIG. **29** illustrates one example of the user interface display of FIG. **28** with a portion of the clinical decision support tree resized, according to embodiments of the present invention. Once block **4** is selected over block **24** (manually by the user and/or automatically based on patient data), the display module **156** resizes the entire “branch” including block **24** and its subsequent nodes, and/or resizes each block **24**, as shown in FIG. **29**, in this case by making them smaller. Alternatively, in another embodiment, even before the user manually selects block **4**, the processor **150** instructs the display module **156** to resize the block **24** branch as shown in FIG. **29** based on an indication from the decision support module **153**, which factors in patient data received (either manually or automatically from the monitor **154**) to indicate that choosing block **4** over block **24** would be more consistent with the particular clinical decision support process being implemented. By indicating a size

different between block **4** and block **24**, the user is provided a visual indication which, if it coincides with the user's perceptions and experience, facilitates the navigation through the decision support process. This also makes such a process easier to use for those who may not have extensive experience with a particular decision support protocol.

The resizing may occur by making block **24** smaller, or by making block **4** larger, or both. In some cases, only the subsequent sets of blocks or nodes are resized, rather than the rest of the branches or nodes depending from the immediately subsequent nodes. Each node may be represented by a shape, and the entire border of the shape may be resized in order to indicate a non-chosen or less-probable node. As another alternative, the size of the node may remain the same but the text inside the node may be resized. As yet another alternative, the size of the node may remain the same, but the color or transparency of the non-chosen or less-probable nodes may be changed, for example "grayed out" for the less important nodes and turned to a bolder color or flashing color for the more important nodes. A combination of these and other visual indication features may be employed to assist the user in visually navigating through the decision support process in real time, during the medical event.

In some cases, the entire decision support tree may be shown on a device screen; in other cases, the tree may be too large to show all at once. FIG. **29** also illustrates how a screen border can be recentered or moved dynamically to correspond with movement through the tree. For example, screen border **50** is initially centered (either vertically or horizontally or both) on block **2**, and as soon as block **4** is selected, or becomes a more likely or recommended selection, the screen border **50** shifts along the direction indicated by arrow **52** to new screen border position **50'**, which is now centered on block **4**. FIG. **30** illustrates a similar resizing feature as it might be displayed after block **6** is selected over block **8**.

The decision support module **153** may also be configured to transition between differential diagnosis and treatment protocols; for example, as a likely diagnosis is approached by a clinical support module, the user may be prompted to select or begin a treatment protocol consistent with one or more likely diagnoses or pre-diagnoses. As another example, one or more treatment protocol trees may be presented at the end of a differential diagnosis or clinical decision support tree, in order to guide the user through the recommended treatment protocol once the decision support module **153** has helped the user identify the condition that requires treatment.

The patient monitor/defibrillator device **154** may also be configured for several different care modes, and may be configured to enter the most likely or most relevant care mode based on the user's navigation of the clinical decision support process, for example on auxiliary display **156**, and to change between two or more care modes as appropriate as the user navigates the clinical decision support tree, according to embodiments of the present invention.

FIG. **31** illustrates a user interface display with dynamic softkeys, according to embodiments of the present invention. Just as the nodes on a decision support tree display may be dynamically visually adjusted to help the user in navigating the process, so too the selection options on a patient monitoring or treatment device **154** may be dynamically adjusted to guide the user through a particular clinical decision support process. FIG. **31** shows a housing of a patient monitor/defibrillator **54**, which may include a screen **55** (for example operated by display module **155** of FIG. **26**),

and which may include a number of physical user input devices **56**, **58**, **60**, **62**, **64**, which may be for example buttons. The screen **55** may be configured to display a user interface as shown, which may include one or more softkeys **66**, **68**, **70**, **72**, **74**, with one or more of the softkeys **66-74** corresponding to one or more of the buttons **56-64**. Based on the disclosure provided herein, more or fewer buttons and/or softkeys maybe used, and the positioning of the buttons and/or softkeys may vary across different units, models, or designs. For example, the buttons may alternatively or additionally extend vertically across one side of the screen **55**.

The softkeys **66** are part of the display screen that may be dynamically modified by the processor **150** and/or the patient monitor **154**, such that the buttons **56-64** may be used by the user to select different options at different times. This allows the user to navigate through various menus with a single row of buttons. According to some embodiments of the present invention, the device **55** does not include any physical buttons, and instead uses only softkeys on the display screen **55** that are themselves selectable (e.g. via a touchscreen arrangement). As such, the term "softkey" is used herein in its broadest sense to refer to any combination of physical and virtual buttons that may be used by a user to select from one or more options.

Similar to the process described with respect to FIGS. **28-30**, the softkeys **66** may be dynamically adjusted to assist the user in navigating a decision support process. Based on the disclosure provided herein, one of ordinary skill in the art will recognize numerous different menus or clinical decision support processes that may benefit from such dynamically adjusting softkeys. Just a few particular examples are shown in FIGS. **32** and **33**. For example, if a user selected the "acute care diagnose" button or softkey from the user interface display of FIG. **3**, the user could be taken to the screen of FIG. **31** with dynamic softkeys **66-74**. Such softkeys may initially look very similar to those of FIGS. **3** and **31**; however, according to one embodiment of the present invention, after the user has entered the acute care diagnosis function, and before the user has selected the next branch of the process, the patient monitor/defibrillator observes a cardiac arrhythmia based on the patient's simultaneously observed ECG waveform. Based on this physiological data, the display module **155** emphasizes the Cardiac Distress softkey **70** by visually emphasizing it or visually distinguishing it over the other simultaneously displayed softkeys, as shown in FIG. **32**. For example, the Cardiac Distress softkey **70** may be changed in color or boldness. The softkey **70** may include a displayed geometric shape, and such shape may be changed, or its perimeter may be made bolder or more visually distinct. As another option, the text within the softkey **70** may be enlarged or emboldened or italicized in order to visually distinguish softkey **70** based on the physiological data.

According to some embodiments of the present invention, the user interface displayed on the screen **55**, and/or the screen display of an accompanying tablet device, includes one or more legends for visually indicating to the user why one or more softkeys have been emphasized or highlighted. For example, such a legend may include text such as "possible cardiac arrhythmia" to explain why the Cardiac Distress softkey **70** is emphasized, or "low SpO2" to explain why the Respiratory Distress softkey **66** is emphasized, or "dispatch: chief complaint=trauma" to explain why the Trauma softkey **72** is emphasized, according to embodiments of the present invention.

As an alternative, or in combination with the color, font, font size, shape, and similar visual distinguishing features, based on this physiological data, the display module **155** resizes the Cardiac Distress softkey **70** by making it larger, or by making the other softkeys smaller, as shown in FIG. **33**. Although FIGS. **32** and **33** illustrate only one softkey **70** being emphasized and/or resized based on available patient data, the display module **155** may further be configured to dynamically emphasize and/or resize more than one softkey, in more than one way, according to embodiments of the present invention. For example, if the patient's blood oxygen content is observed by the monitor **154** as being below a certain threshold, and the patient's ECG waveform is observed by the monitor **154** as being irregular, both the Cardiac Distress softkey **70** and the Respiratory Distress softkey **66** may be visually emphasized or resized with respect to the other softkeys, and may also be visually emphasized or resized with respect to each other depending upon the relative significance of each possible diagnosis or treatment protocol. For example, if the decision support module **153** or processor **150** is able to determine that the cause of the respiratory distress is likely cardiac distress, then the cardiac distress softkey **70** may be the largest or most emphasized softkey, while the respiratory distress softkey **66** may be the next largest or next most emphasized softkey, followed by the remaining softkeys. Once a definitive selection is made, the softkeys **66-74** may be configured to dynamically update to reflect the next decision/step or set of decisions/steps. The dynamic resizing and/or emphasizing of various softkeys conveys a greater level of helpful decision support to the user, without sacrificing the user's ability to select even one of the softkeys that is not enlarged or emphasized, according to embodiments of the present invention.

Although the dynamic adjustment of visual characteristics of softkeys has been described with respect to observed physiological data about the patient, such dynamic adjustment may alternatively or additionally be accomplished using patient charting data or other patient data entered manually or automatically. For example, if the patient's chart at the beginning of the medical event indicates that the patient was involved in an automobile accident, the Trauma softkey **72** may be configured for initial enlargement and/or emphasis as soon as the user selects the "acute care diagnose" function from the interface of FIG. **2**, according to embodiments of the present invention.

FIG. **34** illustrates a code review interface for reviewing user interface display data corresponding to a medical event, according to embodiments of the present invention. The code review interface includes a user interface replicator **455** as well as a visual timeline indicator **300**. Throughout a medical event, the user of the patient monitor/defibrillator **154** takes the display screen **55** of the monitor **154** through various steps and user interface modes. It is often helpful, after the medical event has occurred, for the user, as well as someone who is reviewing or critiquing the performance of the user, to be able to know what happened during the medical event and when during the medical event such events occurred. Such information is particularly helpful in the time leading up to or following a significant patient event, in order to determine the appropriateness or effectiveness of the particular treatment applied. To this end, the processor **150** may be configured to capture visual representations (e.g. "snapshots" in time) of some or all of the user interface screen **55** and store them for later review, for example in database **152**, according to embodiments of the present invention. Such review may be accomplished in the

form of a playback interface as shown in FIG. **34**. Such snapshots of the user interface **55** may be recorded at least once each second, twice each second, or more times each second, at regular or irregular intervals, according to embodiments of the present invention. In some embodiments, the snapshots may be made frequently enough (e.g. at the data sample rate of 500 snapshots per second) to provide full fidelity playback of the event.

The interface replicator **455** and visual timeline indicator **300** may be configured to play back the screen user interface appearance at the same rate at which the images were taken or captured, and dynamically move the position of the timeline indicator **308** along the timeline **300** from the beginning time indicator **304** to the ending time indicator **306**, according to embodiments of the present invention. A current position indicator **302** indicates the time, for example in hour:minute:second format, at which the particular user interface screen shot shown in the user interface replicator **455** was taken (or at which such a user interface displayed during the medical event). As such, a person reviewing the progression of the screen interface **55** sees the screen interface **55** in the user interface replicator **455** just as it would have been seen by the user of the device at the time of the medical event, according to embodiments of the present invention.

The visual timeline indicator **300** may also include visual event indicators, such as drug administration visual event indicator **310** and patient defibrillation visual event indicator **312**. Other visual event indicators may include, for example, the occurrence of an alarm, the time at which a blood pressure measurement or signal was acquired (which may be helpful for documenting at the end of a medical event), event markers, clinical decision tree points, the time at which spontaneous circulation returned ("ROSC"), and/or the time at which a "rearrest" softkey was pressed or at which a renewed or subsequent cardiac arrest condition was observed.

Visual event indicator **310** indicates the time during the medical event (e.g. on the timeline) at which a drug was administered to the patient. Visual event indicator **312** indicates the time during the medical event (e.g. on the timeline) at which a defibrillation treatment was applied to the patient, according to embodiments of the present invention. Fewer or more of the same or additional visual event indicators may be used in the visual timeline indicator **300**, in order to signal to the reviewer the times at which significant events of interest occurred during the medical event. This then permits the reviewer to skip directly to the user interface time intervals of interest, rather than reviewing all user interface screen shots sequentially, according to embodiments of the present invention. As one example of how a user may skip directly to a desired time for playback of the user interface screen, the user may select timeline indicator **308** with a cursor or other selection process, and drag it left or right on the timeline before releasing it to resume playback at the time corresponding to the new location of the indicator **308**, according to embodiments of the present invention. According to some embodiments of the present invention, the user may move the indicator **308** and thus the playback to the time of visual event indicator **310** (or to a time that is a predetermined interval before the time of visual event indicator **310**) by simply clicking on visual event indicator **310**.

The interface of FIG. **34** may further include a current position indicator **302**, which displays a time corresponding to the position of the indicator **308** along the timeline **300** and corresponding to the image displayed in the user inter-

face replicator **455**, according to embodiments of the present invention. While FIG. **34** illustrates a substantially linear timeline, other non-linear timeline indicators may be used. The code review interface of FIG. **34** may also be particular helpful in reviewing the recorded screen images for dynamic softkey adjustments, as described with respect to FIGS. **32** and **33**. For example, if a user failed to select a particular softkey that was later determined to have been the preferred course of action, the code reviewer could set the indicator **308** to the time that such softkey was displayed to see whether the particular softkey was resized or emphasized in order to indicate that it was the preferred course of action. Reviewers using the interface of FIG. **34** are also able to see what exactly was on the user's screen when certain actions were undertaken, for example what the user looked at just prior to the drug administration event **310**, according to embodiments of the present invention. According to some embodiments of the present invention, the interface of FIG. **34** operates in a manner similar to that of digital video recorder playback.

Screen controls consistent with user interfaces that play back movies may be included in the interface of FIG. **34**. For example, the interface may include a media navigation interface including media navigation bar **314**, volume selection bar **314**, and/or playback speed selection bar **316**. The media navigation bar **314** may include screen controls similar to those used with playback of movies, to control the content of the user interface replicator. For example, the media navigation bar **314** may include a play button **322**, a stop button **324**, a pause button **326**, a rewind button **320**, and a fast forward button **328**. A skip back button **314** and skip forward button **330** may also be included, for example to skip between medical events, chapters, and/or visual event indicators, according to embodiments of the present invention. As used herein, "button" is used to refer to either or both of a physical button or a virtual/screen selection interface option. By clicking on or otherwise selecting one of the 2x, 4x, 8x, or 16x portions of the playback speed selection bar **316**, the speed at which the medical vent is played on the user interface replicator **455** may be adjusted. The playback speed selection bar **316** may also be configured to visually indicate which of the playback speed selections is currently active. Other or additional speed selections may be provided. Clicking on or otherwise selecting volume selection bar **314** permits adjustment of any audio playback volume (e.g. when audio data from the medical event is also played back simultaneously or instead of the visual data).

According to some embodiments of the present invention, the on-screen cursor **334** (or other selection mechanism) may take the form of a hand with a pointed finger. When the finger is placed over, on, or near the timeline, a display preview pop-up window **332** opens, for example attached or in the vicinity of the finger or cursor **334**. The display preview window **332** may show, for example, a physiologic waveform along with static measurements and time and events in sufficient detail for the user to determine whether to select that particular timeline location for current playback, according to embodiments of the present invention. The display preview window **332** includes the physiologic waveform and measurements/events portion **336**, as well as a time indicator portion **338** indicating where, along the visual timeline indicator **300**, the cursor **334** has been placed, according to embodiments of the present invention. According to some embodiments of the present invention, selecting and "holding" the selection on the timeline indicator **308** and scrolling forward and backward along the

timeline **300** causes a similar display preview window **332** to pop up at or near the slider **308**.

According to some embodiments of the present invention, the user can play back the clinical decision support tree for reviewing the medical event. For example, a tablet screen, or a screen controlled by display module **156**, or alternatively an interface similar to that of FIG. **34**, could be configured to indicate a timeline and display the user's progression through a clinical decision support tree by highlighting each node through which the process was taken, and the time at which such node selection was made. According to some embodiments of the present invention, a representation of the clinical decision support tree is itself used as a visual timeline indicator, permitting a user to select a node in order to see, in the user interface replicator **455**, what the defibrillator/monitor **154** screen **55** looked like at the time or times when the user was at the selected step in the decision support process. According to some embodiments, the display module **156** and processor **150** may communicably coupled bi-directionally with the defibrillator/monitor **154**, and the defibrillator/monitor **154** screen **55** itself may be used as (for example instead of) the user interface replicator **455**. In addition to being able to select a particular node in the decision support tree to view the monitor display at that selected step, the tablet computer screen or other display device operated by display module **156** may be configured to show a user-selectable list of event markers which, when selected by the user, replicates the monitor's **154** display at the time of the marked event, either using display module **155** or user interface replicator **455**, according to embodiments of the present invention. For example, the following list of event markers could be displayed on a tablet computing device communicably coupled to the defibrillator/monitor **154**:

03:05:00 SBP 110/80, HR 99, SpO₂ 95%
 03:08:00 alarm: SpO₂ 88%
 03:08:30 event: O₂ delivery
 03:10:00 SBP 105/82, HR 110, SpO₂ 92%
 03:11:01 event: ACLS arrive

Although FIG. **34** depicts a user interface replicator **455**, other replicators may be used to display or play back other observed parameters that occurred over the course of a medical event; for example, graphs, trends, and/or charts representing patient information or physiological status. Such an ability to quickly and efficiently review patient data for a medical event or portions thereof may be helpful not only for a subsequent reviewer, but may also be helpful for the user during the medical event, and/or for a subsequent user during the medical event, for example when a patient is transferred from a Basic Life Support crew to an Advanced Life Support crew. The interface of FIG. **34**, or a similar interface, may permit review of the patient's care report, ECG or 12-lead waveforms, cardiopulmonary resuscitation quality, and other patient care information or data. Event markers may be used as described above. As another example, an event marker may be used to indicate that the patient was administered a bronchodilator medication, and the code review interface may be used to look at the patient's respiratory status before and after the application of the bronchodilator. This permits the same user, or a subsequent user for the same patient, or a subsequent reviewer, to observe how effective the bronchodilator dosage was, and perhaps to factor such information into a decision to again administer the same or another treatment. As another example, the interface of FIG. **34** or a similar interface may be used to review how the patient's carbon dioxide waveform changes upon patient treatment. "Snapshots" may be

recorded and played back through a similar interface for other patient data, for example the data from a ventilation monitoring device (e.g. minute ventilation).

According to some embodiments of the present invention, alarm thresholds may be dynamically adjusted based on patient physiological data and/or charting data. In addition, frequency-automated measurements, for example blood pressure, may be adjusted based on patient physiological data and/or charting data, for example by changing the frequency of such measurements. For example, when a traumatic brain injury is suspected or diagnosed based on the patient physiological data, charting data, and/or via following a clinical decision support process, the monitor **154** may be configured to automatically obtain vital signs (e.g. blood pressure, SpO₂, heart rate, and respiratory rate) every five minutes. For other, less critical conditions, these vital signs may only need to be taken twice during the entire patient event. As another example, automatic blood pressure measurements may be disabled when treating a cardiac patient, and then re-enabled once the patient achieves return of spontaneous circulation.

As another example illustrating how alarm thresholds may be dynamically adjusted based in a traumatic brain injury medical event, a systolic blood pressure (“SBP”) alarm may be configured on the monitor **154** to alert the user with an alarm if an adult’s SBP is less than 90 mmHg, with a ventilation rate target of 10 breaths per minute, and/or the end tidal carbon dioxide is less than 35 mmHg. These targets may need to be adjusted based on a patient’s age; for example, for a three-year old, a systolic blood pressure alarm may be set to activate with an SBP of less than 76 mmHg and/or a ventilation rate target of twenty breaths per minute. For a one-year old, a systolic blood pressure alarm may be set to activate with an SBP of less than 72 mmHg, and/or a ventilation rate target of twenty-five breaths per minute. According to embodiments of the present invention, the processor **150** is configured to automatically adjust the thresholds based on the patient’s age, in a traumatic brain injury situation, based on user input, rather than requiring the user to manually reconfigure the alarm thresholds based on age. For example, the processor **150** may obtain the patient’s age from database **152**, and/or from a patient charting system to which it is communicably coupled, and use the patient’s age to automatically reconfigure the alarm thresholds upon an indication, either via a softkey selection or from the decision support module **153**, that a traumatic brain injury situation applies. Alternatively, the clinical decision support tree for traumatic brain injury may, at the appropriate node in the process, request the user to select from various age groupings, and use the user’s selection from the decision support tree to automatically adjust the alarm thresholds. The processor **150** may also be configured to silence all alarms upon a determination that the patient has entered cardiac arrest, and then re-enable all alarms upon a determination that the patient has achieved a return of spontaneous circulation. According to some embodiments of the present invention, the processor **150** may be configured to, after a cardiac arrest event for an adult, reset the alarm thresholds to end tidal carbon dioxide <30 mmHg (possibly lower for a traumatic brain injury situation) or heart rate <40 beats per minute. While alarm and other thresholds are discussed as being adjustable in traumatic brain injury medical events, alarms and other thresholds may also be dynamically adjusted for other patient events or conditions, according to embodiments of the present invention.

According to embodiments of the present invention, system **2600** is used to assist clinicians with delivering medi-

cations of the appropriate dose. Medication errors can cause significant problems, particularly for the treatment of pediatric patients and when drugs are substituted. According to some embodiments of the present invention, the decision support module **153** displays assistance for physicians to comply with a protocol, for example a protocol related to drug delivery. For example, a medical director may provide drug options for treatment of a particular condition. The dosing of the drug would be determined based on patient age, body weight, Broselow measurement, and/or medical complaint. At any time, the medical director may change the drug options and dosing based on factors such as the availability of the drug. A physician might even change the recommendations in real-time or in clinical time if remotely monitoring the treatment. The system may include protections and/or safeguards to ensure that the information is correctly entered into the database **152** about the drug and/or the patient, in order to permit the decision support module **153** to accurately guide the caregiver in dosing according to the current drug delivery protocol, according to embodiments of the present invention.

As shown in FIG. **35**, part of a process, for example a clinical decision support tree, has a decision process that flows through arrow **401** and into decision point **400**, system **2600** may assist the decision support module **153** in determining whether to select, suggest, and/or recommend node **402** or node **404**, according to embodiments of the present invention. After node **402** is selected, the process may continue to the next node via arrow **403**. After node **404** is selected, the process may continue to the next node via arrow **405**, according to embodiments of the present invention. As shown in FIG. **35**, a drug delivery portion of a clinical decision support tree may, at node **400**, have the decision support module **153** determine a correct dosing for the particular patient based on upon observed and/or input patient characteristics (block **406**), and/or may determine or suggest or recommend one of two or more doses, for example dose A (block **402**) or dose B (block **404**), according to embodiments of the present invention. The observed and/or input patient characteristics (block **406**) that might suggest different dosing include age, weight, allergies, and/or other conditions, according to embodiments of the present invention.

FIG. **36** illustrates a user interface, for example a user interface for a patient monitor/defibrillator **154** or other device. The user interface of FIG. **36** includes display portions which indicate trending information for various values. For example, the interface illustrates trending data for systolic blood pressure (referenced as **3600**), end tidal carbon dioxide (EtCO₂), and blood oxygen saturation (SpO₂). Trending data may be displayed as a running record of previous readings. The oldest readings may appear on the left, and the newest readings may appear on the right, and the newest reading may be inserted on the right side while displacing the oldest reading on the left side, according to embodiments of the present invention. Alternatively, the oldest readings may appear on the right, and the newest readings may appear on the left, and the newest reading may be inserted on the left side while displacing the oldest reading on the right side. Other options for visually indicating the trend data for a given signal may be employed.

Conventional trending data displays for medical devices, for example a patient monitor/defibrillator **154**, help a clinician assess patient history and condition, but they often fail to convey information about how the trending values compare with acceptable values or ranges of values, or user-defined values or ranges of values. According to some

embodiments of the present invention, the scaling of the trending readouts, and/or the frequency of the values displayed for the trending values, and/or a color in which the trending values are displayed, is customized according to the particular patient and/or the patient's condition. This may be done by the decision support module **153**. For example, if as part of a decision support process the decision support module **153** receives information indicating a patient's age, then the processor may be configured to configure the color in which each bar of the blood pressure trending graph **3600** is displayed.

The three bars on the left **3602** may be displayed as green to indicate that the patient's blood pressure at the times corresponding to those particular blood pressure measurements was within acceptable limits for the patient's age. The middle five bars **3604** may be yellow to indicate that the patient's blood pressure at the times corresponding to those particular blood pressure measurements was below acceptable limits, but not yet at a critical level. The right three bars **3606** may be red to indicate that the patient's blood pressure at the times corresponding to those particular blood pressure measurements was far below acceptable ranges, and was therefore at a critical level. In embodiments in which the newest trending values appear on the right side, the trend graph **3600** for patient systolic blood pressure indicates that the patient's blood pressure is worsening over time by becoming lower. Of course, other colors may be used, and additional colors and/or ranges may be employed. These ranges may be automatically adjusted by the decision support module **154** based on various factors, for example the patient's age, or other conditions. For example, all of the bars **3602**, **3604**, and **3606** can be displayed as green for a normal adult patient, while the same absolute readings may be colored as shown in FIG. **35** for a younger or adolescent patient. The coloring, target ranges, or other visual indication of the trending data may also be adjusted by the decision support module **153** during the patient monitoring event, based on data observed by the patient monitoring device **154**.

According to some embodiments of the present invention, the clinician manually adjusts the target values of signals, which may be beneficial if the patient is "crashing," for example. Instead of a screen full of red target values, the clinician could select ranges which correspond to conditions with a more realistic chance of being achieved, according to embodiments of the present invention.

According to some embodiments of the present invention, if a patient has cerebral herniation or impending cerebral herniation, the ETCO₂ and/or ventilation rate targets may be changed in order to hyperventilate such patients so as to reduce intracranial pressure. These ranges or targets may be adjusted automatically if, in the course of a decision support process, the decision support module **153** detects, either automatically, or via manual or clinical or other inputs, that the patient has or is about to experience cerebral herniation.

According to some embodiments of the present invention, if the decision support module **153** detects that the ETCO₂ is below a certain threshold, the target ventilation rate will be adjusted to lower the ventilation rate. If the decision support module **153** detects that the ETCO₂ is above a certain threshold, the target ventilation rate will be adjusted to increase the ventilation rate, according to embodiments of the present invention. Such adjusted ventilation rates may include an upper and/or lower limit to prevent other undesired results, because high or low ETCO₂ readings may be caused by factors other than ventilation rate (e.g. a super low ETCO₂ may be caused by perfusion).

Various modifications and additions can be made to the exemplary embodiments discussed without departing from the scope of the present invention. For example, while the embodiments described above refer to particular features, the scope of this invention also includes embodiments having different combinations of features and embodiments that do not include all of the described features. Accordingly, the scope of the present invention is intended to embrace all such alternatives, modifications, and variations as fall within the scope of the claims, together with all equivalents thereof.

What is claimed is:

1. A method for code review of a medical event, the method comprising: displaying, on a first device screen, a user interface during the medical event;

recording images of the user interface, each of the images representing an entirety of the user interface associated with a time during the medical event, wherein the images are recorded at least once every second;

displaying, on a second device screen, a visual timeline indicator and a user interface replicator, the user interface replicator displaying the images of the user interface and the visual timeline indicator representing a time associated with each of the images, wherein the visual timeline indicator and the user interface replicator permit sequential playback and review of the user interface images from the medical event, and wherein the visual timeline indicator accepts user input to move the sequential playback to a different time associated with the medical event.

2. The method of claim **1**, wherein the visual timeline indicator includes a timeline including a beginning time of the medical event and an end time of the medical event, the method further comprising indicating on the timeline the time associated with the image of the user interface shown in the user interface replicator.

3. The method of claim **2**, wherein the indicating on the timeline comprises using an indicator on the timeline to indicate the time associated with the image of the user interface shown in the user interface replicator.

4. The method of claim **3**, further comprising advancing the indicator along the timeline in a direction from the beginning time toward the end time during sequential playback of the user interface images.

5. The method of claim **4**, wherein the visual timeline indicator accepts user input by permitting scrolling of the indicator to a different position along the timeline.

6. The method of claim **2**, wherein the visual timeline indicator displays the time associated with each of the images in an hour-minute-second format.

7. The method of claim **2**, wherein the visual timeline indicator includes one or more event markers marking occurrence of clinically-relevant sub-events during the medical event.

8. The method of claim **7**, wherein the one or more event markers include a drug event marker indicating a time at which a drug was administered to a patient during the medical event.

9. The method of claim **7**, wherein the one or more event markers include a defibrillation event marker indicating a time at which a defibrillation shock was applied to a patient during the medical event.

10. The method of claim **7**, wherein the one or more event markers include an ROSC event marker indicating a time at which a patient returned to spontaneous circulation.

11. The method of claim **7**, wherein the one or more event markers include a rearrest event marker indicating a time at which a patient returned to cardiac arrest.

29

12. The method of claim 7, wherein the one or more event markers include an alarm event marker indicating a time at which an alarm was activated.

13. The method of claim 1, further comprising displaying a cursor on the second device screen and, when the cursor is hovered over or near a time represented by the visual timeline indicator, displaying on the second screen at or near the cursor the image of the user interface associated with the time.

14. The method of claim 13, further comprising, when the cursor is hovered over or near the time, displaying at or near the cursor a textual representation of the time.

15. The method of claim 1, wherein the second device screen is integrated with a heads up display.

16. The method of claim 1, wherein the second device screen is integrated with a wearable device.

17. The method of claim 1, wherein the second device screen is integrated with a hands-free device.

18. The method of claim 1 wherein the second device screen is projected onto a user's glasses or face shield.

19. A method for decision support during a medical event, the method comprising:

displaying, on a screen on a device, a user interface during the medical event, wherein the user interface comprises two or more softkeys each representing a possible user selection;

collecting physiological data from a patient with the device;

identifying, based on the physiological data, a type of the medical event;

determining, in response to the type of the of the medical event, which one of the two or more softkeys represents

30

the possible user selection that most closely conforms to a treatment or diagnosis protocol; and based on the determination, visually distinguishing the one of the two or more softkeys from the others of the two or more softkeys on the user interface.

20. The method of claim 19, wherein visually distinguishing the one of the two or more softkeys comprises making the one of the two or more softkeys larger than the others of the two or more softkeys.

21. The method of claim 19, wherein visually distinguishing the one of the two or more softkeys comprises changing a position of the one of the two or more softkeys on the user interface.

22. The method of claim 19, wherein visually distinguishing the one of the two or more softkeys comprises changing a color of the one of the two or more softkeys on the user interface.

23. The method of claim 19, wherein visually distinguishing the one of the two or more softkeys comprises changing a border of the one of the two or more softkeys on the user interface.

24. The method of claim 19, wherein visually distinguishing the one of the two or more softkeys comprises making the one of the two or more softkeys dynamically flash on the user interface.

25. The method of claim 19, wherein visually distinguishing the one of the two or more softkeys comprises displaying on the screen a legend describing why the one of the two or more softkeys has been visually distinguished.

26. The method of claim 25, wherein the one of the two or more softkeys is a cardiac distress softkey, and wherein the legend textually indicates a possible cardiac arrhythmia.

* * * * *