



US009647743B2

(12) **United States Patent**
Grandhi

(10) **Patent No.:** **US 9,647,743 B2**
(45) **Date of Patent:** ***May 9, 2017**

(54) **METHOD AND APPARATUS FOR SUPPORTING MANAGEMENT ACTIONS FOR VERY HIGH THROUGHPUT IN WIRELESS COMMUNICATIONS**

(71) Applicant: **InterDigital Patent Holdings, Inc.**,
Wilmington, DE (US)

(72) Inventor: **Sudheer A. Grandhi**, Pleasanton, CA
(US)

(73) Assignee: **InterDigital Patent Holdings, Inc.**,
Wilmington, DE (US)

(*) Notice: Subject to any disclaimer, the term of this
patent is extended or adjusted under 35
U.S.C. 154(b) by 0 days.

This patent is subject to a terminal disclaimer.

(21) Appl. No.: **15/186,604**

(22) Filed: **Jun. 20, 2016**

(65) **Prior Publication Data**

US 2016/0301459 A1 Oct. 13, 2016

Related U.S. Application Data

(63) Continuation of application No. 14/718,709, filed on
May 21, 2015, now Pat. No. 9,374,146, which is a
(Continued)

(51) **Int. Cl.**
H04B 7/06 (2006.01)
H04W 28/18 (2009.01)
(Continued)

(52) **U.S. Cl.**
CPC **H04B 7/0617** (2013.01); **H04B 7/0417**
(2013.01); **H04B 7/0623** (2013.01);
(Continued)

(58) **Field of Classification Search**
CPC .. **H04B 7/0417**; **H04B 7/0617**; **H04B 7/0634**;
H04B 7/0658; **H04B 7/0623**;
(Continued)

(56) **References Cited**

U.S. PATENT DOCUMENTS

7,848,250 B2 12/2010 Sekiya et al.
8,284,686 B2 10/2012 Gu et al.

(Continued)

FOREIGN PATENT DOCUMENTS

WO 2007/040564 4/2007
WO 2007/105044 9/2007

(Continued)

OTHER PUBLICATIONS

IEEE P802.11aa/D1.0, Draft Standard for Information Technol-
ogy—Telecommunications and information exchange between sys-
tems—Local and metropolitan area networks—Specific require-
ments—Part 11: Wireless LAN Medium Access Control (MAC) and
Physical Layer (PHY) specifications, Amendment 1: MAC
Enhancements for Robust Audio Video Streaming, IEEE P802.11aa/
D1.0 (Jun. 2010).

(Continued)

Primary Examiner — Paul H Masur

(74) *Attorney, Agent, or Firm* — Volpe and Koenig, P.C.

(57) **ABSTRACT**

A method and apparatus may be used in Very High Through-
put (VHT) Wireless Local Area Network (WLAN) manage-
ment actions. Management action frames such as VHT
Action frames may be used to implement VHT features in
WLANs. Extensions to 802.11 Action frames may be used
to support VHT features and provide backward compatibil-
ity. VHT Management Actions may be supported with VHT
Action frames and VHT extensions to 802.11 Action frames
in various categories such as Direct Link Setup (DLS),
Public, Spectrum Management and high throughput (HT).
An access point (AP) or a wireless transmit/receive unit
(WTRU) may indicate VHT capability by way of signaling.

20 Claims, 7 Drawing Sheets

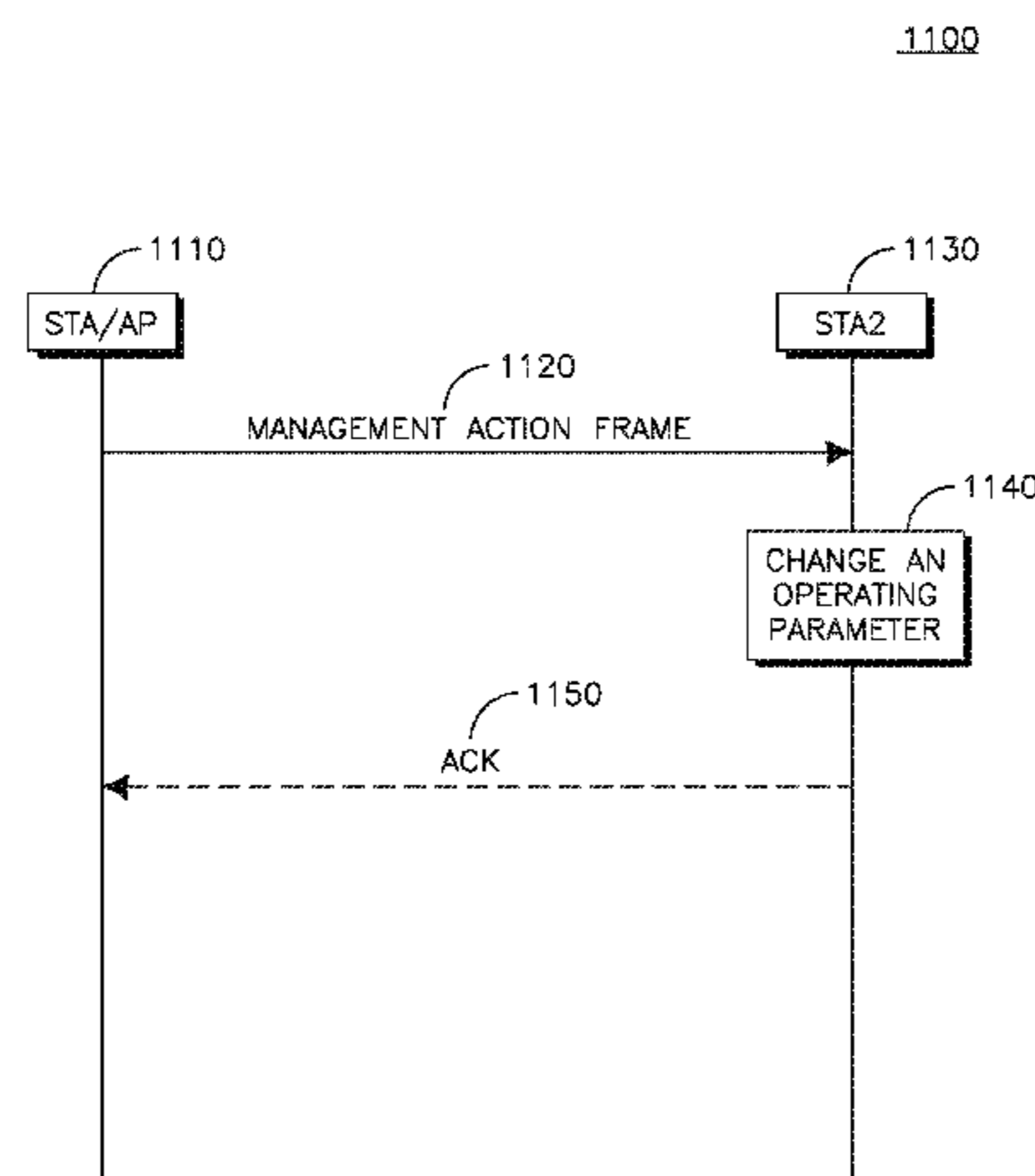

Related U.S. Application Data

- continuation of application No. 14/260,439, filed on Apr. 24, 2014, now Pat. No. 9,042,362, which is a continuation of application No. 12/945,365, filed on Nov. 12, 2010, now Pat. No. 8,711,821.
- (60) Provisional application No. 61/261,197, filed on Nov. 13, 2009.
- (51) **Int. Cl.**
H04W 84/12 (2009.01)
H04B 7/0417 (2017.01)
H04B 7/08 (2006.01)
H04L 27/26 (2006.01)
H04W 24/10 (2009.01)
H04W 48/16 (2009.01)
H04L 12/28 (2006.01)
H04W 72/04 (2009.01)
H04W 88/08 (2009.01)
- (52) **U.S. Cl.**
 CPC *H04B 7/0626* (2013.01); *H04B 7/0634* (2013.01); *H04B 7/0658* (2013.01); *H04B 7/0897* (2013.01); *H04L 27/2627* (2013.01); *H04W 24/10* (2013.01); *H04W 28/18* (2013.01); *H04W 84/12* (2013.01); *H04L 12/28* (2013.01); *H04W 48/16* (2013.01); *H04W 72/04* (2013.01); *H04W 88/08* (2013.01)
- (58) **Field of Classification Search**
 CPC *H04B 7/0897*; *H04W 28/18*; *H04W 48/16*; *H04W 72/04*; *H04L 12/28*; *H04L 27/2627*
 See application file for complete search history.

(56) **References Cited**

U.S. PATENT DOCUMENTS

8,374,096	B2	2/2013	Gu et al.	
8,451,808	B2	5/2013	Solomon et al.	
9,148,256	B2	9/2015	Sampath et al.	
2007/0213012	A1	9/2007	Marin et al.	
2007/0230373	A1	10/2007	Li et al.	
2007/0266157	A1	11/2007	Khafa et al.	
2008/0192644	A1	8/2008	Utsunomiya et al.	
2009/0124235	A1	5/2009	Bosch et al.	
2010/0248635	A1	9/2010	Zhang et al.	
2010/0260138	A1	10/2010	Liu et al.	
2010/0260159	A1	10/2010	Zhang et al.	
2011/0051636	A1	3/2011	Van Nee et al.	
2011/0051711	A1	3/2011	Kishiyama et al.	
2011/0096747	A1	4/2011	Seok	
2011/0128900	A1*	6/2011	Seok	H04W 74/04 370/311
2011/0199968	A1	8/2011	Kim et al.	
2012/0063406	A1	3/2012	Seok	
2012/0076091	A1	3/2012	Seok	
2012/0087300	A1*	4/2012	Seok	H04W 76/02 370/315
2012/0106531	A1	5/2012	Seok et al.	

FOREIGN PATENT DOCUMENTS

WO	2007143472	A2	12/2007
WO	2010/013897		2/2010
WO	2010/118383		10/2010
WO	2010/120119		10/2010

OTHER PUBLICATIONS

IEEE P802.11ad™/D1.0 Draft Standard for Information Technology—Telecommunications and Information Exchange Between

Systems—Local and Metropolitan Area Networks—Specific Requirements—Part 11: Wireless LAN Medium Access Control (MAC) and Physical Layer (PHY) Specifications—Amendment 5: Enhancements for Very High Throughput in the 60GHz Band, IEEE P802.11ad/D1.0 (Sep. 2010).

IEEE Standard for Information Technology—Telecommunications and information exchange between systems—Local and metropolitan area networks—Specific requirements; Part 11: Wireless LAN Medium Access Control (MAC) and Physical Layer (PHY) Specifications, IEEE Std. 802.11-2007 (Jun. 12, 2007).

IEEE Standard for Information technology—Telecommunications and information exchange between systems—Local and metropolitan area networks—Specific requirements; Part 11: Wireless LAN Medium Access Control (MAC) and Physical Layer (PHY) Specifications; Amendment 8: Medium Access Control (MAC) Quality of Service Enhancements, IEEE Std. 802.11e-2005 (Nov. 11, 2005).

IEEE Standard for Information technology—Telecommunications and information exchange between systems—Local and metropolitan area networks—Specific requirements; Part 11: Wireless LAN Medium Access Control (MAC) and Physical Layer (PHY) Specifications, Amendment 7: Extensions to Direct-Link Setup (DLS), IEEE 802.11z-2010 (Oct. 14, 2010).

IEEE Standard for Information technology—Telecommunications and information exchange between systems—Local and metropolitan area networks—Specific requirements, Part 11: Wireless LAN Medium Access Control (MAC) and Physical Layer (PHY) Specifications, Amendment 5: Enhancements for Higher Throughput, IEEE Std. 802.11n-2009 (Sep. 11, 2009).

IEEE Standard for Information technology—Telecommunications and information exchange between systems—Local and metropolitan area networks—Specific requirements Part 11: Wireless LAN Medium Access Control (MAC) and Physical Layer (PHY) specifications Amendment 4: Further Higher Data Rate Extension in the 2.4 GHz Band, IEEE Std 802.11g-2003 (Jun. 27, 2003).

Imashioya et al., “RTL Design of 1.2Gbps MIMO WLAN System and its Business Aspect,” 9th International Symposium on Communications and Information Technology, pp. 296-301 (Sep. 30, 2009).

Kim et al., 11ac Explicit Feedback Format, IEEE 802.11-10/1227r0, Nov. 11, 2010.

Stacey et al., “Specification Framework for TGac,” IEEE 802.11-09/0992r14, Sep. 15, 2010.

Stephens et al., “IEEE P802.11 Wireless LANs, Joint Proposal: High Throughput Extension to the 802.11 Standard: MAC”, IEEE 802.11-05/1095r5, (Jan. 13, 2006).

Sun et al., “Adaptive Frequency-Domain Channel Estimator in 4x4 MIMO-OFDM Modems,” IEEE Transactions on Very Large Scale Integration (VLSI) Systems, vol. 17, No. 11, pp. 1616-1625 (Nov. 2009).

Supplement to IEEE Standard for Information technology—Telecommunications and information exchange between systems—Local and metropolitan area networks—Specific requirements—Part 11: Wireless LAN Medium Access Control (MAC) and Physical Layer (PHY) Specifications: Higher-Speed Physical Layer Extension in the 2.4 GHz Band, IEEE Std 802.11b-1999 (R2003) (Supplement to ANSI/IEEE Std 802.11, 1999 Edition)(Jun. 12, 2003).

Supplement to IEEE Standard for Information technology—Telecommunications and information exchange between systems—Local and metropolitan area networks—Specific requirements, Part 11: Wireless LAN Medium Access Control (MAC) and Physical Layer (PHY), Specifications High-speed Physical Layer in the 5 GHz Band, IEEE Std 802.11a-1999(R2003) (Jun. 12, 2003).

Zhang et al., “11ac Explicit Sounding and Feedback,” IEEE 802.11-10/1105r1, Sep. 14, 2010.

Zhao et al., “Notification on Change of BW and Rx Nss,” IEEE 802.11-10/xxxxr0, Nov. 8, 2010.

Stacey et al., “Specification Framework for TGac,” IEEE 802.11-09/0992r2, Sep. 24, 2009.

Stacey et al., “Specification Framework for TGac,” IEEE 802.11-09/099208, Sep. 16, 2010.

Trainin et al., “Explicit Feedback Submission,” IEEE 802.11-0610886r4, Sep. 14, 2004.

* cited by examiner

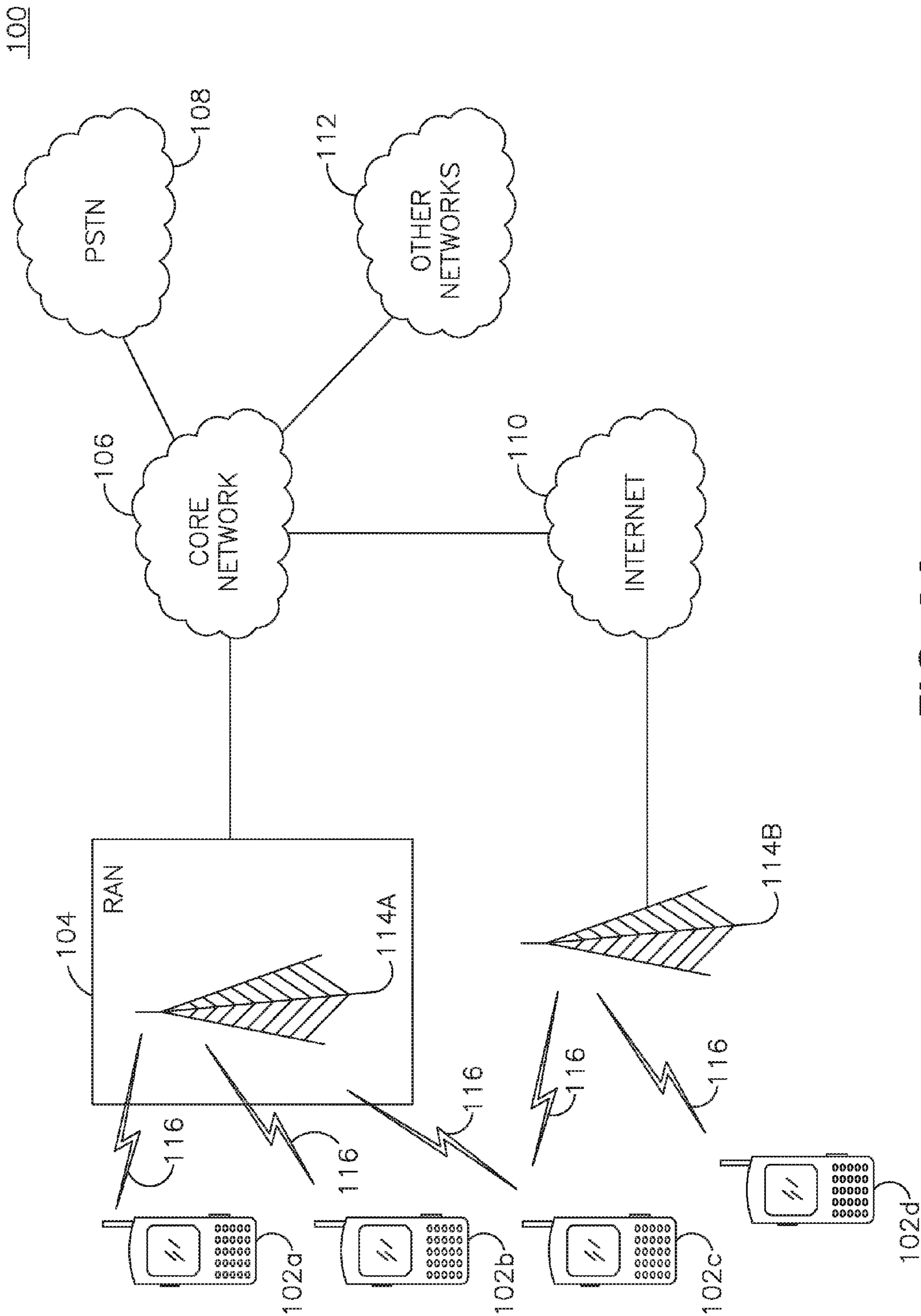

FIG. 1A

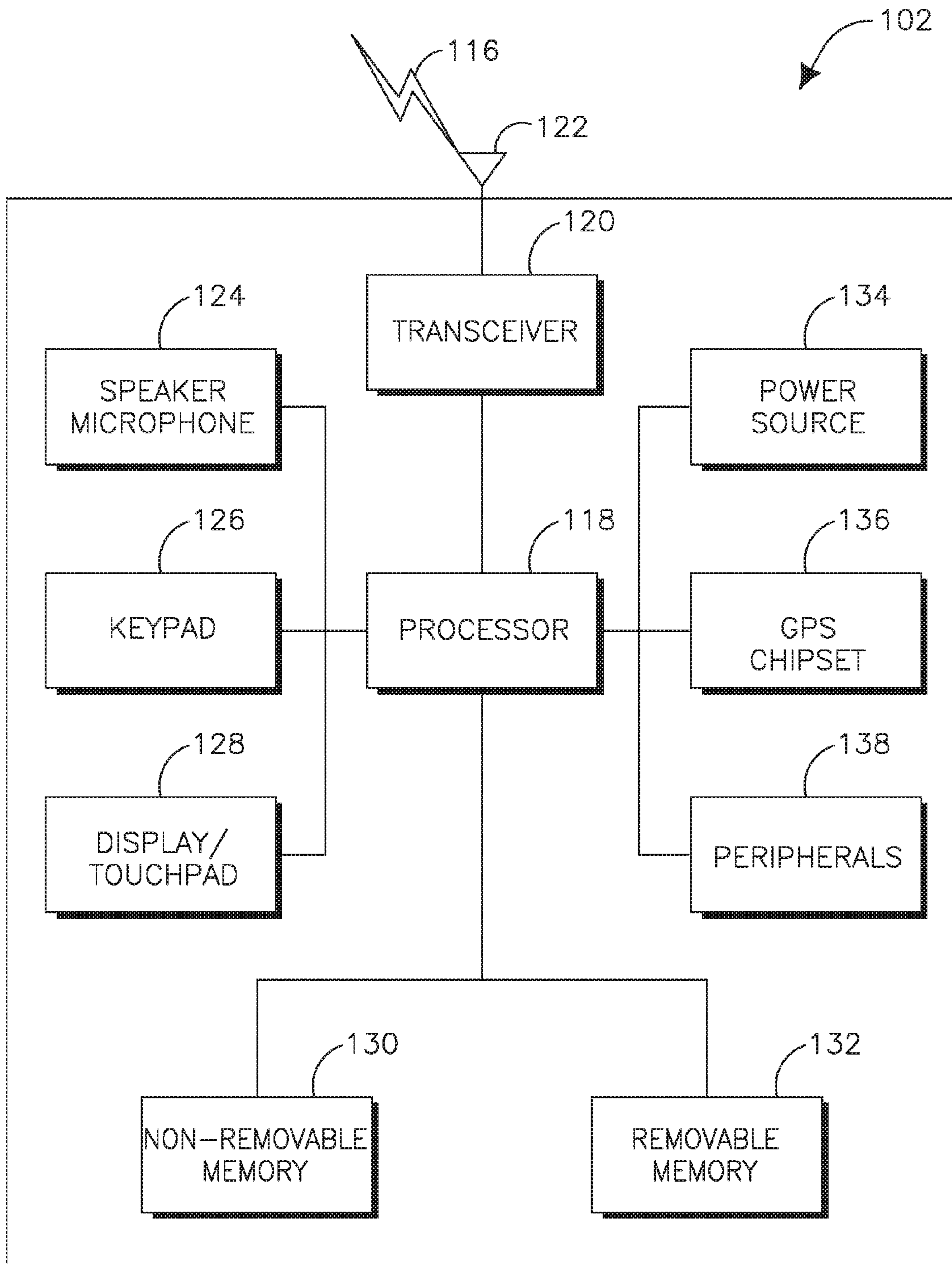

FIG. 1B

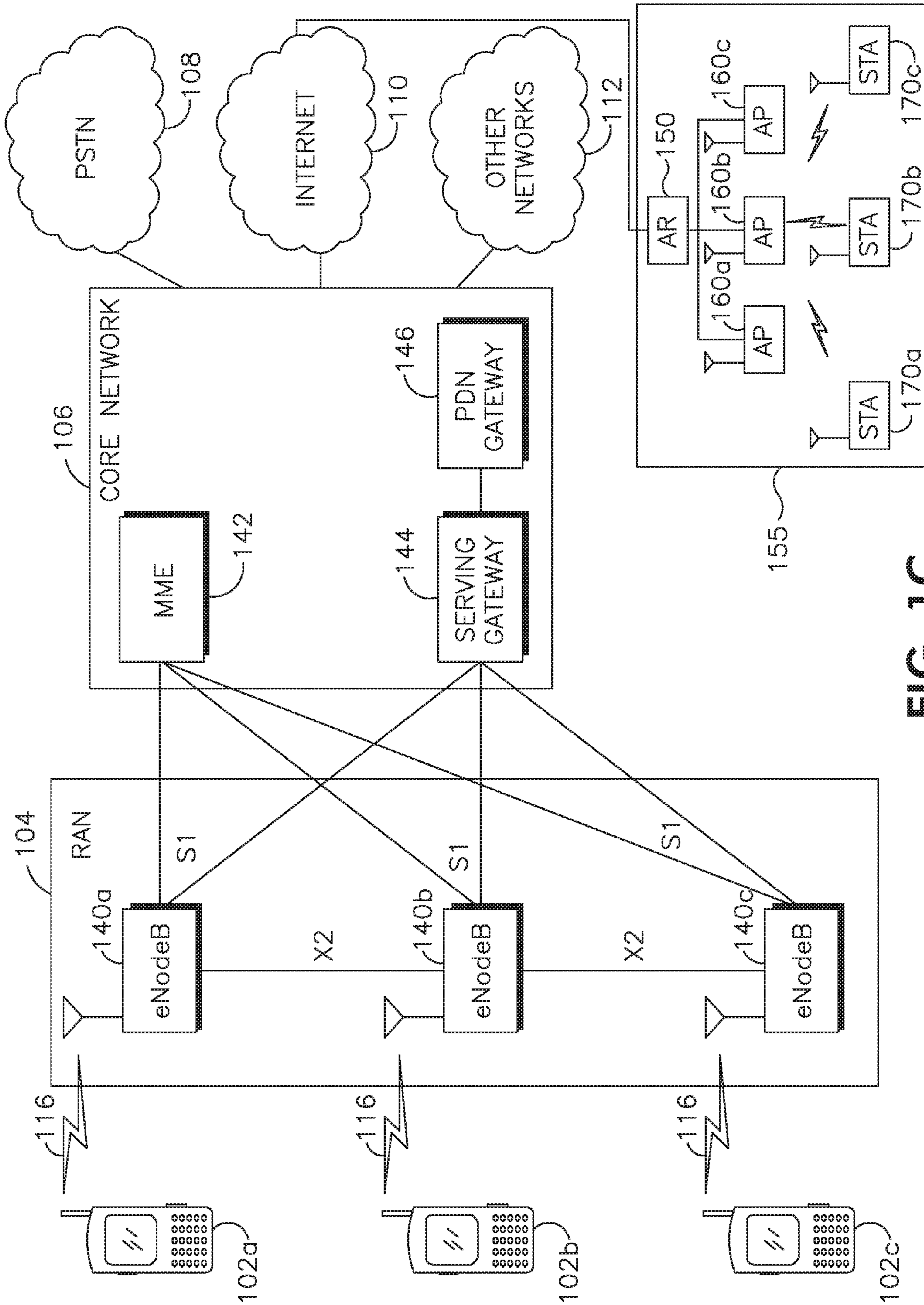

FIG. 1C

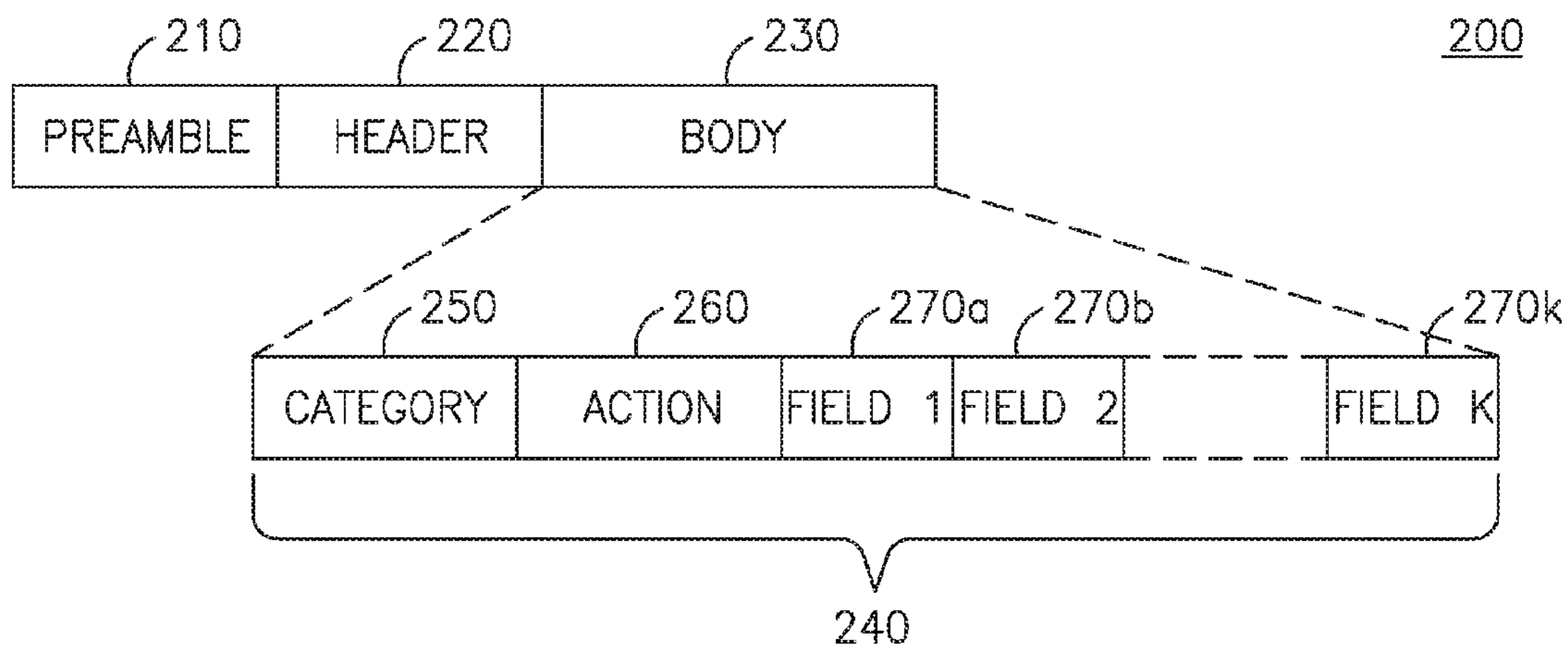

FIG. 2

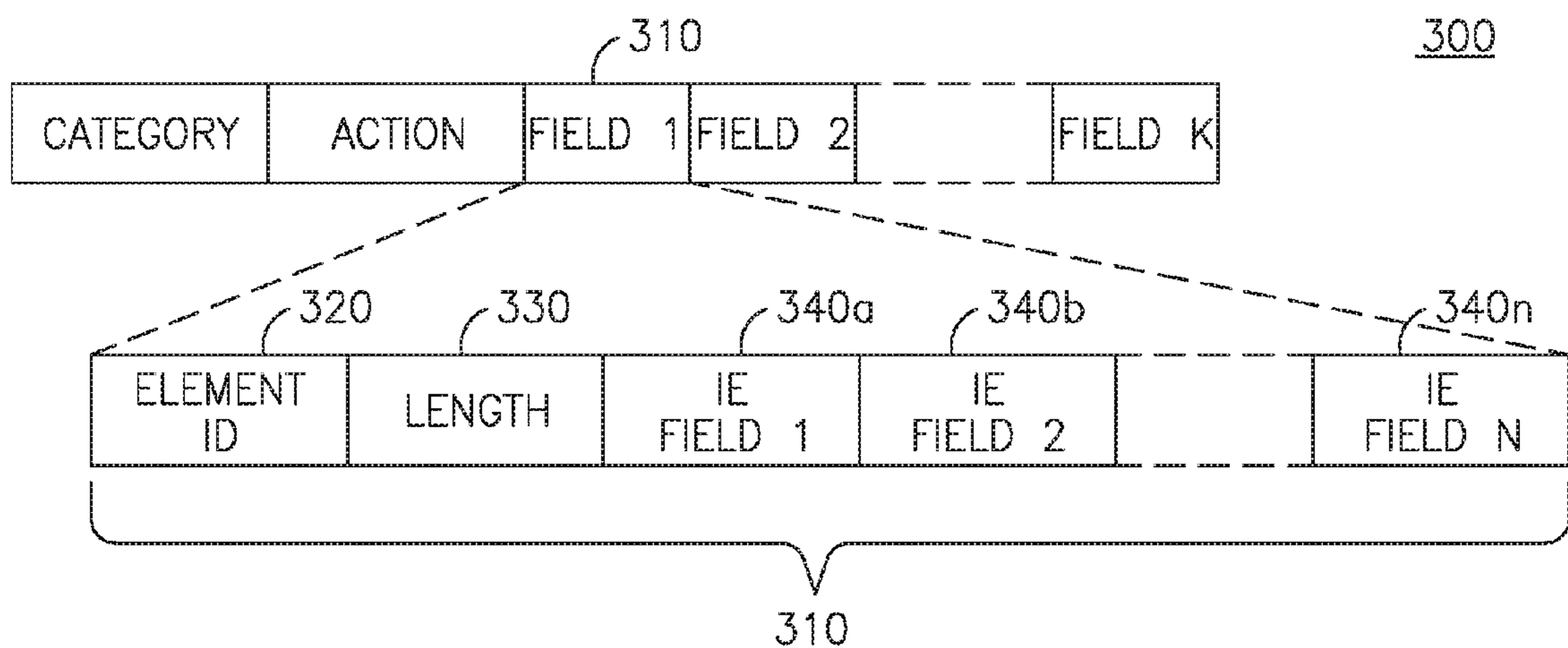

FIG. 3

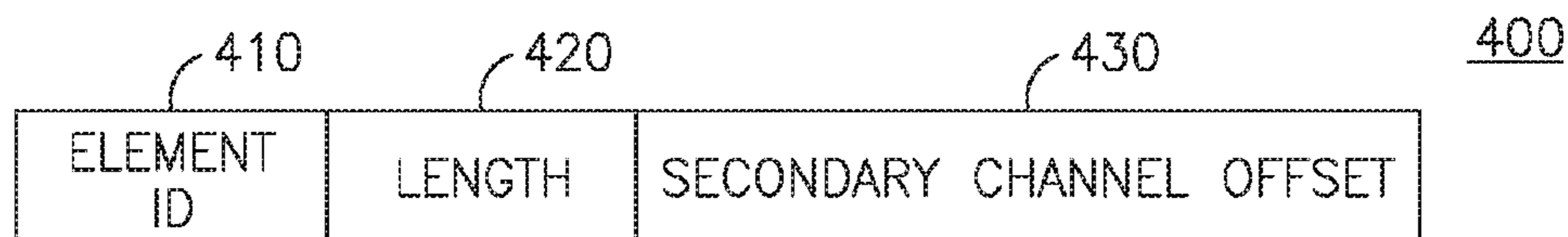

FIG. 4

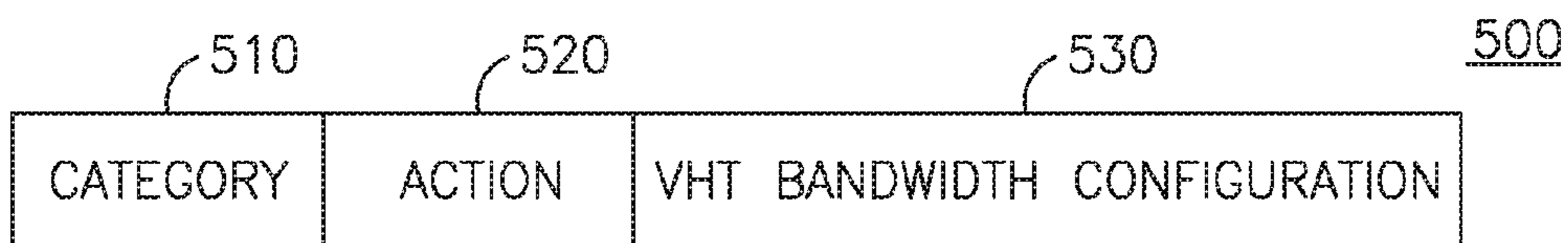

FIG. 5

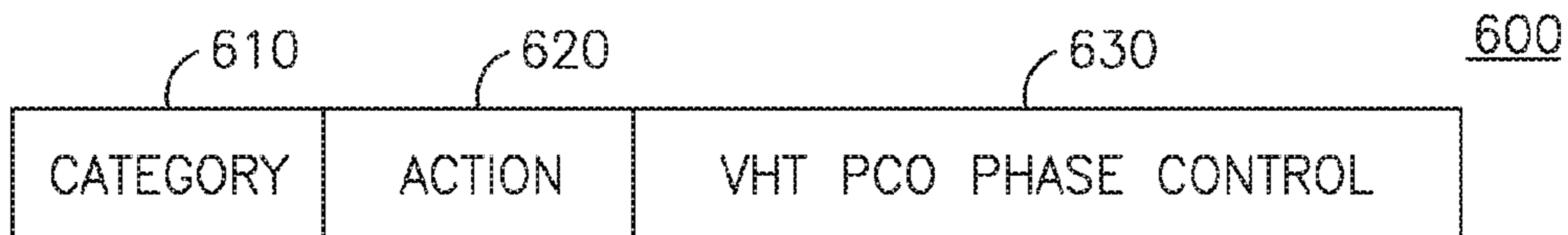

FIG. 6

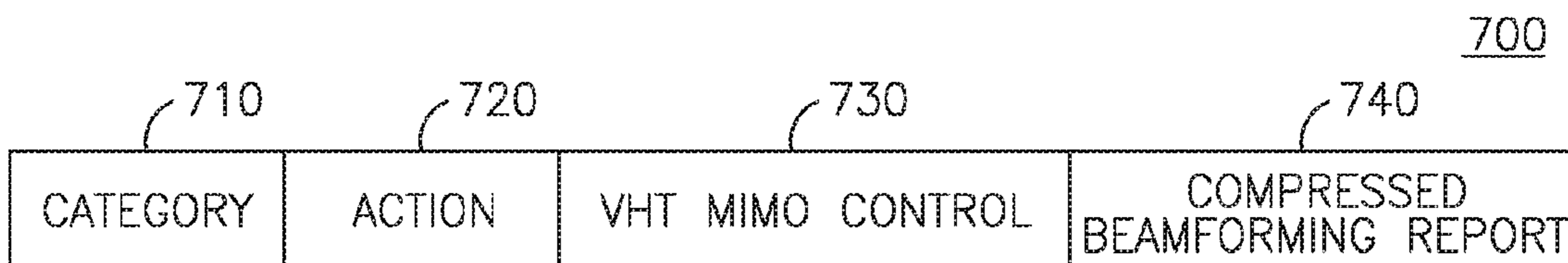

FIG. 7

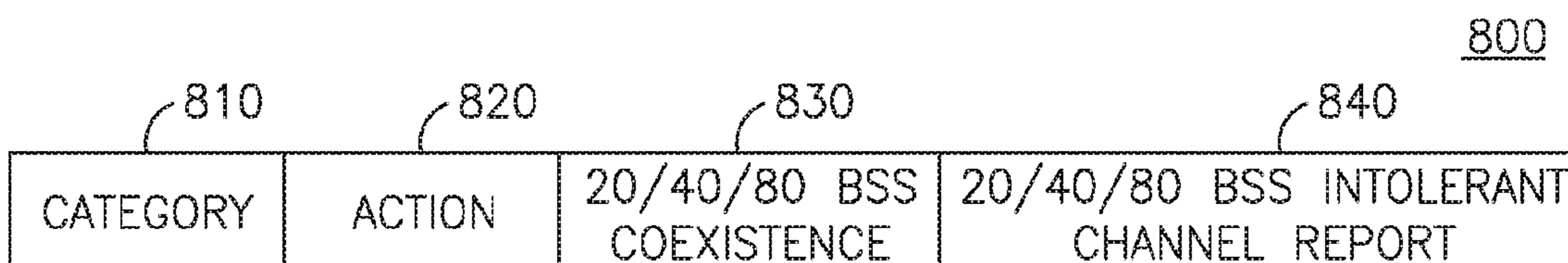

FIG. 8

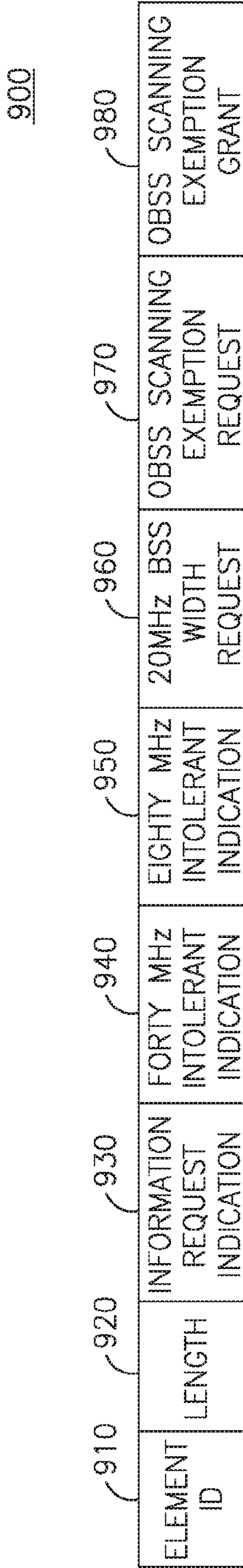

FIG. 9

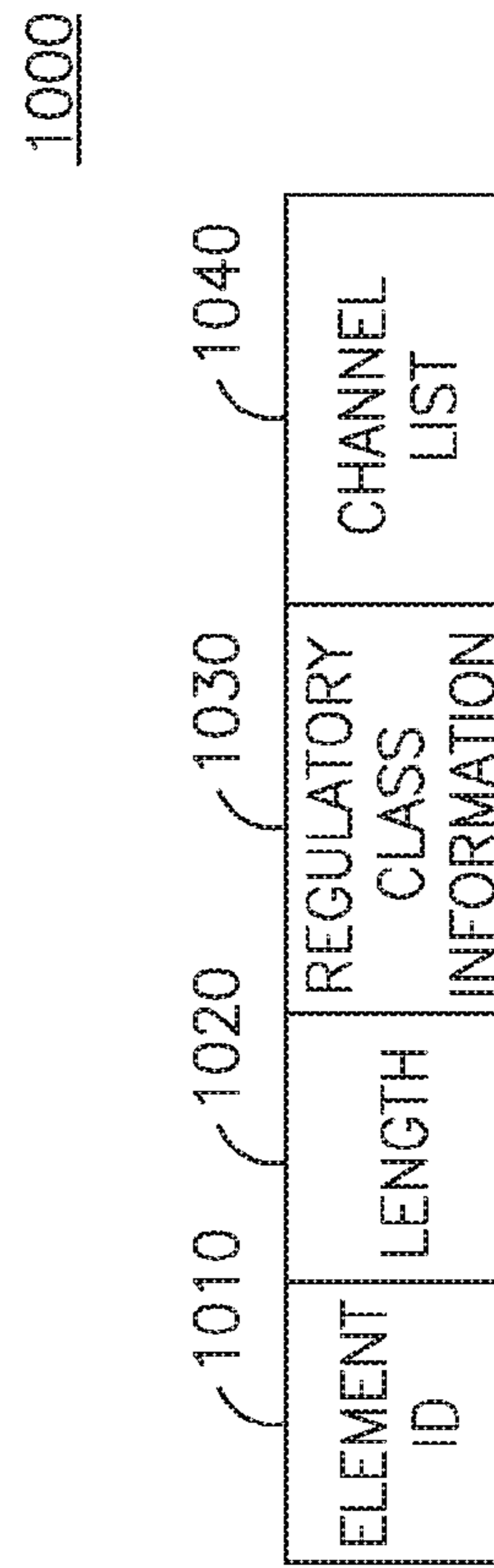

FIG. 10

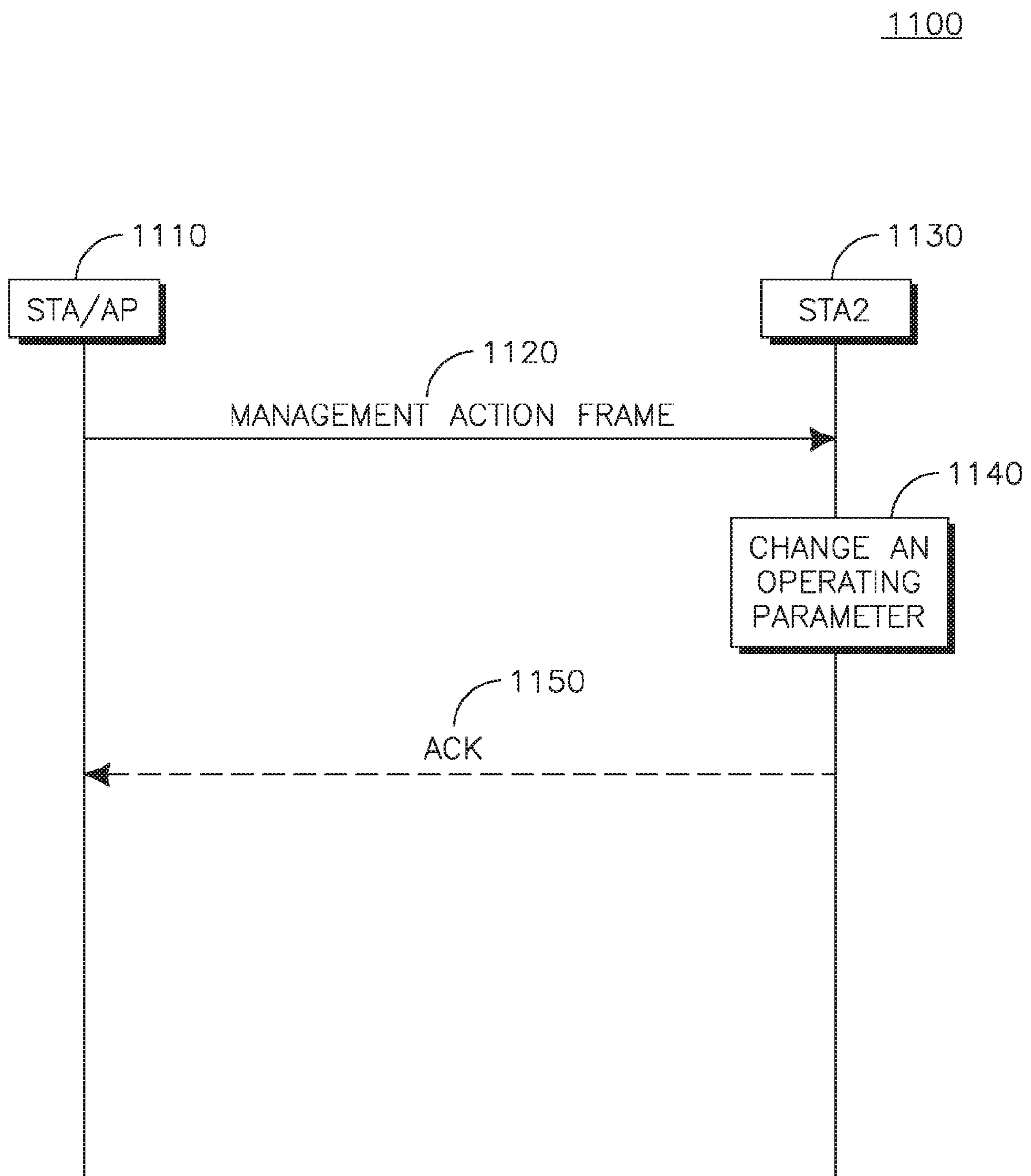

FIG. 11

**METHOD AND APPARATUS FOR
SUPPORTING MANAGEMENT ACTIONS
FOR VERY HIGH THROUGHPUT IN
WIRELESS COMMUNICATIONS**

CROSS REFERENCE TO RELATED
APPLICATIONS

This application is a continuation of U.S. patent application Ser. No. 14/718,709, filed on May 21, 2015 and issued as U.S. Pat. No. 9,374,146 on Jun. 21, 2016, which is a continuation of U.S. patent application Ser. No. 14/260,439 filed on Apr. 24, 2014 and issued as U.S. Pat. No. 9,042,362 on May 26, 2015, which is a continuation of U.S. patent application Ser. No. 12/945,365 filed on Nov. 12, 2010 and issued as U.S. Pat. No. 8,711,821 on Apr. 29, 2014, which claims the benefit of U.S. Provisional Application Ser. No. 61/261,197 filed on Nov. 13, 2009, the contents of which are hereby incorporated by reference.

BACKGROUND

Supporting higher data rates has long been a goal in wireless communication technologies, including, for example, wireless local area networks (WLANs). A WLAN infrastructure basic service set (BSS) mode may have an Access Point (AP) for the BSS and one or more stations (STAs) associated with the AP. The AP typically may have access to, or interface with, a distribution system (DS) or another type of wired/wireless network that may carry traffic in and out of the BSS. Traffic to STAs that originates from outside the BSS may arrive through the AP and may be delivered to the STAs. Traffic originating from STAs to destinations outside the BSS may be sent to the AP to be delivered to the respective destinations.

Traffic between STAs within the BSS may also be sent to through the AP where the source STA sends traffic to the AP and the AP delivers the traffic to the destination STA. Such traffic between STAs within a BSS may be referred to as peer-to-peer traffic. Such peer-to-peer traffic may also be sent directly between the source and destination STAs with a direct link setup (DLS) using an 802.11e direct link setup (DLS) or an 802.11z tunneled DLS. A WLAN in Independent BSS mode may not have an AP and STAs communicating directly with each other.

The earliest version of the 802.11 standard provided a data rate of 1 Mbps. A subsequent amendment, namely 802.11b, provided a physical layer data rate of 11 Mbps. With the introduction of orthogonal frequency division multiplexing (OFDM) in the 802.11g and 802.11a amendments for 2.4 GHz and 5 GHz bands respectively, the data rates supported were increased to 54 Mbps at the PHY layer. The 802.11n amendment increased the data rates supported to 100 Mbps on top of the MAC layer. It would be desirable to have a method and apparatus configured to support data rates greater than 100 Mbps.

SUMMARY

A method and apparatus may be used to support management actions for Very High Throughput (VHT) in wireless communications. An STA or an AP may transmit a management action frame. The management action frame may include a field for supporting one or more VHT management functions. The one or more VHT management functions may be related to a multi-channel non-contiguous spectrum operation. In response to receiving the management action

frame, a STA or an AP may perform an action based on the received management action frame. The receiving STA or AP may transmit an acknowledgement (ACK) based on a category or a subtype indicated in the management action frame.

The management action frame may be a Very High Throughput (VHT) Compressed Beamforming frame. The VHT Compressed Beamforming frame may be an Action No Acknowledgement (ACK) frame, and may include a VHT multiple input multiple output (MIMO) Control field. The VHT MIMO Control field may indicate a channel width related to a multi-channel non-contiguous spectrum transmission associated with a sounding packet.

BRIEF DESCRIPTION OF THE DRAWINGS

A more detailed understanding may be had from the following description, given by way of example in conjunction with the accompanying drawings wherein:

FIG. 1A is a system diagram of an example communications system in which one or more disclosed embodiments may be implemented;

FIG. 1B is a system diagram of an example wireless transmit/receive unit (WTRU) that may be used within the communications system illustrated in FIG. 1A;

FIG. 1C is a system diagram of an example radio access network and an example core network that may be used within the communications system illustrated in FIG. 1A;

FIG. 2 is a diagram of an example medium access control (MAC) frame;

FIG. 3 is a diagram of an example Very High Throughput (VHT) management action frame;

FIG. 4 is a diagram of an example Secondary Channel Offset Information Element (IE);

FIG. 5 is a diagram of an example VHT Notify bandwidth configuration frame;

FIG. 6 is a diagram of an example VHT Set Phased Coexistence Operation (PCO) Phase frame;

FIG. 7 is a diagram of an example VHT Multiple Input Multiple Output (MIMO) Control Action frame;

FIG. 8 is a diagram of an example 20/40/80 BSS Coexistence Management frame;

FIG. 9 is a diagram of an example 20/40/80 BSS Coexistence IE;

FIG. 10 is a diagram of an example 20/40/80 BSS Intolerant Channel Report IE; and

FIG. 11 is a flow diagram of an example method for supporting management actions in VHT communications.

DETAILED DESCRIPTION

FIG. 1A is a diagram of an example communications system **100** in which one or more disclosed embodiments may be implemented. The communications system **100** may be a multiple access system that provides content, such as voice, data, video, messaging, broadcast, etc., to multiple wireless users. The communications system **100** may enable multiple wireless users to access such content through the sharing of system resources, including wireless bandwidth. For example, the communications systems **100** may employ one or more channel access methods, such as code division multiple access (CDMA), time division multiple access (TDMA), frequency division multiple access (FDMA), orthogonal FDMA (OFDMA), single-carrier FDMA (SC-FDMA), and the like.

As shown in FIG. 1A, the communications system **100** may include wireless transmit/receive units (WTRUs) **102a**,

102b, 102c, 102d, a radio access network (RAN) **104**, a core network **106**, a public switched telephone network (PSTN) **108**, the Internet **110**, and other networks **112**, though it will be appreciated that the disclosed embodiments contemplate any number of WTRUs, base stations, networks, and/or network elements. Each of the WTRUs **102a, 102b, 102c, 102d** may be any type of device configured to operate and/or communicate in a wireless environment. By way of example, the WTRUs **102a, 102b, 102c, 102d** may be configured to transmit and/or receive wireless signals and may include user equipment (UE), a mobile station, a fixed or mobile subscriber unit, a pager, a cellular telephone, a personal digital assistant (PDA), a smartphone, a laptop, a netbook, a personal computer, a wireless sensor, consumer electronics, and the like.

The communications systems **100** may also include a base station **114a** and a base station **114b**. Each of the base stations **114a, 114b** may be any type of device configured to wirelessly interface with at least one of the WTRUs **102a, 102b, 102c, 102d** to facilitate access to one or more communication networks, such as the core network **106**, the Internet **110**, and/or the networks **112**. By way of example, the base stations **114a, 114b** may be a base transceiver station (BTS), a Node-B, an eNode B, a Home Node B, a Home eNode B, a site controller, an access point (AP), a wireless router, and the like. While the base stations **114a, 114b** are each depicted as a single element, it will be appreciated that the base stations **114a, 114b** may include any number of interconnected base stations and/or network elements.

The base station **114a** may be part of the RAN **104**, which may also include other base stations and/or network elements (not shown), such as a base station controller (BSC), a radio network controller (RNC), relay nodes, etc. The base station **114a** and/or the base station **114b** may be configured to transmit and/or receive wireless signals within a particular geographic region, which may be referred to as a cell (not shown). The cell may further be divided into cell sectors. For example, the cell associated with the base station **114a** may be divided into three sectors. Thus, in one embodiment, the base station **114a** may include three transceivers, i.e., one for each sector of the cell. In another embodiment, the base station **114a** may employ multiple-input multiple output (MIMO) technology and, therefore, may utilize multiple transceivers for each sector of the cell.

The base stations **114a, 114b** may communicate with one or more of the WTRUs **102a, 102b, 102c, 102d** over an air interface **116**, which may be any suitable wireless communication link (e.g., radio frequency (RF), microwave, infrared (IR), ultraviolet (UV), visible light, etc.). The air interface **116** may be established using any suitable radio access technology (RAT).

More specifically, as noted above, the communications system **100** may be a multiple access system and may employ one or more channel access schemes, such as CDMA, TDMA, FDMA, OFDMA, SC-FDMA, and the like. For example, the base station **114a** in the RAN **104** and the WTRUs **102a, 102b, 102c** may implement a radio technology such as Universal Mobile Telecommunications System (UMTS) Terrestrial Radio Access (UTRA), which may establish the air interface **116** using wideband CDMA (WCDMA). WCDMA may include communication protocols such as High-Speed Packet Access (HSPA) and/or Evolved HSPA (HSPA+). HSPA may include High-Speed Downlink Packet Access (HSDPA) and/or High-Speed Uplink Packet Access (HSUPA).

In another embodiment, the base station **114a** and the WTRUs **102a, 102b, 102c** may implement a radio technology such as Evolved UMTS Terrestrial Radio Access (E-UTRA), which may establish the air interface **116** using Long Term Evolution (LTE) and/or LTE-Advanced (LTE-A).

In other embodiments, the base station **114a** and the WTRUs **102a, 102b, 102c** may implement radio technologies such as Institute of Electrical and Electronics Engineers (IEEE) 802.16 (i.e., Worldwide Interoperability for Microwave Access (WiMAX)), CDMA2000, CDMA2000 1X, CDMA2000 EV-DO, Interim Standard 2000 (IS-2000), Interim Standard 95 (IS-95), Interim Standard 856 (IS-856), Global System for Mobile communications (GSM), Enhanced Data rates for GSM Evolution (EDGE), GSM EDGE (GERAN), and the like.

The base station **114b** in FIG. 1A may be a wireless router, Home Node B, Home eNode B, or access point, for example, and may utilize any suitable RAT for facilitating wireless connectivity in a localized area, such as a place of business, a home, a vehicle, a campus, and the like. In one embodiment, the base station **114b** and the WTRUs **102c, 102d** may implement a radio technology such as IEEE 802.11 to establish a wireless local area network (WLAN). In another embodiment, the base station **114b** and the WTRUs **102c, 102d** may implement a radio technology such as IEEE 802.15 to establish a wireless personal area network (WPAN). In yet another embodiment, the base station **114b** and the WTRUs **102c, 102d** may utilize a cellular-based RAT (e.g., WCDMA, CDMA2000, GSM, LTE, LTE-A, etc.) to establish a picocell or femtocell. As shown in FIG. 1A, the base station **114b** may have a direct connection to the Internet **110**. Thus, the base station **114b** may not be required to access the Internet **110** via the core network **106**.

The RAN **104** may be in communication with the core network **106**, which may be any type of network configured to provide voice, data, applications, and/or voice over internet protocol (VoIP) services to one or more of the WTRUs **102a, 102b, 102c, 102d**. For example, the core network **106** may provide call control, billing services, mobile location-based services, pre-paid calling, Internet connectivity, video distribution, etc., and/or perform high-level security functions, such as user authentication. Although not shown in FIG. 1A, it will be appreciated that the RAN **104** and/or the core network **106** may be in direct or indirect communication with other RANs that employ the same RAT as the RAN **104** or a different RAT. For example, in addition to being connected to the RAN **104**, which may be utilizing an E-UTRA radio technology, the core network **106** may also be in communication with another RAN (not shown) employing a GSM radio technology.

The core network **106** may also serve as a gateway for the WTRUs **102a, 102b, 102c, 102d** to access the PSTN **108**, the Internet **110**, and/or other networks **112**. The PSTN **108** may include circuit-switched telephone networks that provide plain old telephone service (POTS). The Internet **110** may include a global system of interconnected computer networks and devices that use common communication protocols, such as the transmission control protocol (TCP), user datagram protocol (UDP) and the internet protocol (IP) in the TCP/IP internet protocol suite. The networks **112** may include wired or wireless communications networks owned and/or operated by other service providers. For example, the networks **112** may include another core network connected to one or more RANs, which may employ the same RAT as the RAN **104** or a different RAT.

5

Some or all of the WTRUs **102a**, **102b**, **102c**, **102d** in the communications system **100** may include multi-mode capabilities, i.e., the WTRUs **102a**, **102b**, **102c**, **102d** may include multiple transceivers for communicating with different wireless networks over different wireless links. For example, the WTRU **102c** shown in FIG. 1A may be configured to communicate with the base station **114a**, which may employ a cellular-based radio technology, and with the base station **114b**, which may employ an IEEE 802 radio technology.

FIG. 1B is a system diagram of an example WTRU **102**. As shown in FIG. 1B, the WTRU **102** may include a processor **118**, a transceiver **120**, a transmit/receive element **122**, a speaker/microphone **124**, a keypad **126**, a display/touchpad **128**, non-removable memory **130**, removable memory **132**, a power source **134**, a global positioning system (GPS) chipset **136**, and other peripherals **138**. It will be appreciated that the WTRU **102** may include any sub-combination of the foregoing elements while remaining consistent with an embodiment.

The processor **118** may be a general purpose processor, a special purpose processor, a conventional processor, a digital signal processor (DSP), a plurality of microprocessors, one or more microprocessors in association with a DSP core, a controller, a microcontroller, Application Specific Integrated Circuits (ASICs), Field Programmable Gate Array (FPGAs) circuits, any other type of integrated circuit (IC), a state machine, and the like. The processor **118** may perform signal coding, data processing, power control, input/output processing, and/or any other functionality that enables the WTRU **102** to operate in a wireless environment. The processor **118** may be coupled to the transceiver **120**, which may be coupled to the transmit/receive element **122**. While FIG. 1B depicts the processor **118** and the transceiver **120** as separate components, it will be appreciated that the processor **118** and the transceiver **120** may be integrated together in an electronic package or chip.

The transmit/receive element **122** may be configured to transmit signals to, or receive signals from, a base station (e.g., the base station **114a**) over the air interface **116**. For example, in one embodiment, the transmit/receive element **122** may be an antenna configured to transmit and/or receive RF signals. In another embodiment, the transmit/receive element **122** may be an emitter/detector configured to transmit and/or receive IR, UV, or visible light signals, for example. In yet another embodiment, the transmit/receive element **122** may be configured to transmit and receive both RF and light signals. It will be appreciated that the transmit/receive element **122** may be configured to transmit and/or receive any combination of wireless signals.

In addition, although the transmit/receive element **122** is depicted in FIG. 1B as a single element, the WTRU **102** may include any number of transmit/receive elements **122**. More specifically, the WTRU **102** may employ MIMO technology. Thus, in one embodiment, the WTRU **102** may include two or more transmit/receive elements **122** (e.g., multiple antennas) for transmitting and receiving wireless signals over the air interface **116**.

The transceiver **120** may be configured to modulate the signals that are to be transmitted by the transmit/receive element **122** and to demodulate the signals that are received by the transmit/receive element **122**. As noted above, the WTRU **102** may have multi-mode capabilities. Thus, the transceiver **120** may include multiple transceivers for enabling the WTRU **102** to communicate via multiple RATs, such as UTRA and IEEE 802.11, for example.

6

The processor **118** of the WTRU **102** may be coupled to, and may receive user input data from, the speaker/microphone **124**, the keypad **126**, and/or the display/touchpad **128** (e.g., a liquid crystal display (LCD) display unit or organic light-emitting diode (OLED) display unit). The processor **118** may also output user data to the speaker/microphone **124**, the keypad **126**, and/or the display/touchpad **128**. In addition, the processor **118** may access information from, and store data in, any type of suitable memory, such as the non-removable memory **106** and/or the removable memory **132**. The non-removable memory **106** may include random-access memory (RAM), read-only memory (ROM), a hard disk, or any other type of memory storage device. The removable memory **132** may include a subscriber identity module (SIM) card, a memory stick, a secure digital (SD) memory card, and the like. In other embodiments, the processor **118** may access information from, and store data in, memory that is not physically located on the WTRU **102**, such as on a server or a home computer (not shown).

The processor **118** may receive power from the power source **134**, and may be configured to distribute and/or control the power to the other components in the WTRU **102**. The power source **134** may be any suitable device for powering the WTRU **102**. For example, the power source **134** may include one or more dry cell batteries (e.g., nickel-cadmium (NiCd), nickel-zinc (NiZn), nickel metal hydride (NiMH), lithium-ion (Li-ion), etc.), solar cells, fuel cells, and the like.

The processor **118** may also be coupled to the GPS chipset **136**, which may be configured to provide location information (e.g., longitude and latitude) regarding the current location of the WTRU **102**. In addition to, or in lieu of, the information from the GPS chipset **136**, the WTRU **102** may receive location information over the air interface **116** from a base station (e.g., base stations **114a**, **114b**) and/or determine its location based on the timing of the signals being received from two or more nearby base stations. It will be appreciated that the WTRU **102** may acquire location information by way of any suitable location-determination method while remaining consistent with an embodiment.

The processor **118** may further be coupled to other peripherals **138**, which may include one or more software and/or hardware modules that provide additional features, functionality and/or wired or wireless connectivity. For example, the peripherals **138** may include an accelerometer, an e-compass, a satellite transceiver, a digital camera (for photographs or video), a universal serial bus (USB) port, a vibration device, a television transceiver, a hands free headset, a Bluetooth® module, a frequency modulated (FM) radio unit, a digital music player, a media player, a video game player module, an Internet browser, and the like.

FIG. 1C is a system diagram of the RAN **104** and the core network **106** according to an embodiment. As noted above, the RAN **104** may employ an E-UTRA radio technology to communicate with the WTRUs **102a**, **102b**, **102c** over the air interface **116**. The RAN **104** may also be in communication with the core network **106**.

The RAN **104** may include eNode-Bs **140a**, **140b**, **140c**, though it will be appreciated that the RAN **104** may include any number of eNode-Bs while remaining consistent with an embodiment. The eNode-Bs **140a**, **140b**, **140c** may each include one or more transceivers for communicating with the WTRUs **102a**, **102b**, **102c** over the air interface **116**. In one embodiment, the eNode-Bs **140a**, **140b**, **140c** may implement MIMO technology. Thus, the eNode-B **140a**, for

example, may use multiple antennas to transmit wireless signals to, and receive wireless signals from, the WTRU **102a**.

Each of the eNode-Bs **140a**, **140b**, **140c** may be associated with a particular cell (not shown) and may be configured to handle radio resource management decisions, handover decisions, scheduling of users in the uplink and/or downlink, and the like. As shown in FIG. 1C, the eNode-Bs **140a**, **140b**, **140c** may communicate with one another over an X2 interface.

The core network **106** shown in FIG. 1C may include a mobility management gateway (MME) **142**, a serving gateway **144**, and a packet data network (PDN) gateway **146**. While each of the foregoing elements are depicted as part of the core network **106**, it will be appreciated that any one of these elements may be owned and/or operated by an entity other than the core network operator.

The MME **142** may be connected to each of the eNode-Bs **142a**, **142b**, **142c** in the RAN **104** via an S1 interface and may serve as a control node. For example, the MME **142** may be responsible for authenticating users of the WTRUs **102a**, **102b**, **102c**, bearer activation/deactivation, selecting a particular serving gateway during an initial attach of the WTRUs **102a**, **102b**, **102c**, and the like. The MME **142** may also provide a control plane function for switching between the RAN **104** and other RANs (not shown) that employ other radio technologies, such as GSM or WCDMA.

The serving gateway **144** may be connected to each of the eNode Bs **140a**, **140b**, **140c** in the RAN **104** via the S1 interface. The serving gateway **144** may generally route and forward user data packets to/from the WTRUs **102a**, **102b**, **102c**. The serving gateway **144** may also perform other functions, such as anchoring user planes during inter-eNode B handovers, triggering paging when downlink data is available for the WTRUs **102a**, **102b**, **102c**, managing and storing contexts of the WTRUs **102a**, **102b**, **102c**, and the like.

The serving gateway **144** may also be connected to the PDN gateway **146**, which may provide the WTRUs **102a**, **102b**, **102c** with access to packet-switched networks, such as the Internet **110**, to facilitate communications between the WTRUs **102a**, **102b**, **102c** and IP-enabled devices. An access router (AR) **150** of a wireless local area network (WLAN) **155** may be in communication with the Internet **110**. The AR **150** may facilitate communications between APs **160a**, **160b**, and **160c**. The APs **160a**, **160b**, and **160c** may be in communication with STAs **170a**, **170b**, and **170c**.

The core network **106** may facilitate communications with other networks. For example, the core network **106** may provide the WTRUs **102a**, **102b**, **102c** with access to circuit-switched networks, such as the PSTN **108**, to facilitate communications between the WTRUs **102a**, **102b**, **102c** and traditional land-line communications devices. For example, the core network **106** may include, or may communicate with, an IP gateway, (e.g., an IP multimedia subsystem (IMS) server), that serves as an interface between the core network **106** and the PSTN **108**. In addition, the core network **106** may provide the WTRUs **102a**, **102b**, **102c** with access to the networks **112**, which may include other wired or wireless networks that are owned and/or operated by other service providers.

When referred to herein, the terminology “station” (STA) includes but is not limited to a wireless transmit/receive unit (WTRU), a user equipment (UE), a mobile station, a fixed or mobile subscriber unit, a pager, a cellular telephone, a personal digital assistant (PDA), a computer, a mobile internet device (MID), or any other type of device capable

of operating in a wireless environment. When referred to hereafter, the terminology “base station” includes but is not limited to a Node-B, a site controller, an access point (AP), or any other type of interfacing device capable of operating in a wireless environment.

For purposes of explanation, the various embodiments are described in an WLAN context, but the various embodiments may be implemented in any wireless communication technology. Some example types of wireless communication technologies include, but are not limited to, Worldwide Interoperability for Microwave Access (WiMAX), 802.xx, Global System for Mobile communications (GSM), Code Division Multiple Access (CDMA2000), Universal Mobile Telecommunications System (UMTS), Long Term Evolution (LTE), or any future technology.

WLANs with Very High Throughput (VHT) of greater than 100 Mbps on top of MAC layer may be designed to implement the embodiments described herein. A VHT WLAN that implements these embodiments may also include features such as multi-user multiple-input multiple-output (MU-MIMO) techniques, new coding features, new power save features, etc. MU-MIMO technology may enable simultaneous transmission to multiple STAs on the same frequency and also enable simultaneous reception from multiple STAs on the same frequency. New VHT protection features for VHT packet transmission and legacy packet transmission may be implemented. In a scenario with densely deployed VHT APs, overlapping BSS management may be necessary because of high interference from neighboring BSSs. In a Television White Space (TVWS) scenario, independently operated networks/devices (and even dissimilar networks/devices in radio technology) may coexist and operate in a common TVWS frequency spectrum.

The IEEE 802.11 High Throughput (HT) Action frames used to support the management actions for HT features may not be adequate in WLANs with VHT features. New management Action frames, referred to herein as “VHT Action frames,” may be needed for extending management actions for VHT features. In addition, extensions to IEEE 802.11 Action frames may be needed to support VHT features. Example methods and apparatuses used to support VHT Management Actions in the form of VHT Action frames and VHT extensions to IEEE 802.11 Action frames in WLANs are described herein. The VHT Action frames are in new categories or existing 802.11 categories such as DLS, Public, Spectrum Management, HT, etc. The VHT Action frames if not assigned to existing 802.11 categories will be grouped under a new category called “VHT” category.

VHT STAs in an Infrastructure BSS, Independent BSS/Ad hoc, or Direct Link Setup scenario may send or receive VHT management action frames. In an Infrastructure BSS scenario, VHT APs may send or receive VHT management action frames as well.

In 802.11 management frames of the subtypes “Action” and “Action No Acknowledgement (ACK)” are used for extended management actions related to various categories such as Spectrum Management, QoS, DLS, Public, HT etc. For example, an 802.11 Public Action frame may be a management Action frame with the Category field set to Public, that may, for example, allow an inter-BSS and AP to communicate with an unassociated-STA. In this example, the transmitting STA/AP and receiving STA/AP may be associated with different BSSs, or one or both of the transmitting and receiving STAs may not be associated to a BSS.

The management frame of subtype “Action No ACK” may not receive an ACK frame from the recipient STA/AP

on successful reception. Furthermore, these Action frames of the management frame subtype “Action No ACK” may be aggregated by an STA/AP with one or more of data frames, control frames, and management frames for transmission in an aggregated packet data unit (PDU). An aggregated PDU may contain the individual frames/packets with each individual packet preceded by a packet/frame delimiter that includes information pertaining to the packet and each individual packet followed by padding bits if necessary to round up to a required length; for example a multiple of 4 Octets as in 802.11n. Both management frames of the subtypes “Action” and “Action No ACK” may be referred to herein as either “Action frames” or “management Action frames.”

FIG. 2 is a diagram of an example medium access control (MAC) frame 200. The MAC frame 200 may include a preamble 210, a header 220, and a frame body 230. The frame body 230 may include a VHT management Action frame body 240. The VHT management Action frame body 240 may include an Action Category field 250, followed by an Action field 260. The Action field 260 may identify the type of Action frame, for example, a Setup Request, a Setup Response, or a Teardown. The Action field 260 may be followed by other fields 270a, 270b, . . . 270k. The other fields 270a, 270b, . . . 270k may be specified based on the Action Frame type where one or more of these fields may be Information Elements (IEs).

The AP and STAs may indicate VHT management actions, in any new or existing management/control/data frames, for example, in management frames such as Association, Reassociation, Probe or Beacon frames. An IE may be included in the MAC frames to transfer information.

FIG. 3 is a diagram of an example VHT management action frame 300 that includes an IE 310. The IE 310 may include an element ID field 320, a length field 330, and a number of IE fields 340a, 340b, . . . 340n. The element ID field 320 may contain an ID specific to the IE 310. The length field 330 may indicate the length of the IE 310 following the length field 330.

In a first example, an 802.11 Channel Switch Announcement frame may be modified to support the VHT increased channel bandwidth transmission mode of 80 MHz. The Channel Switch Announcement frame may be sent by an AP in a BSS or a STA in an Independent BSS to advertise when

it is switching to a new channel, the channel number and bandwidth configuration. The 802.11 Channel Switch Announcement frame may be an Action frame of Category Spectrum Management which contains a Secondary Channel Offset IE.

FIG. 4 is a diagram of an example Secondary Channel Offset IE 400 that may be modified to indicate secondary channel offset information values to support the VHT 80 MHz bandwidth transmission and VHT Multi-channel transmission. The Secondary Channel Offset IE 400 may comprise an element ID field 410, a length field 420, and a Secondary Channel Offset field 430.

The Secondary Channel Offset field 430 may indicate the position of the 20 MHz secondary channel relative to the 20 MHz primary channel for 40 MHz transmission bandwidth in the existing 802.11n standard. In a VHT 80 MHz bandwidth transmission scenario, there may be three 20 MHz secondary channels along with a primary 20 MHz channel providing the 80 MHz transmission bandwidth. Accordingly, for the 80 MHz bandwidth transmission, the positions of the three 20 MHz secondary channels with respect to the 20 MHz primary channel may be indicated with values in the Secondary Channel Offset field 430. The 20 MHz channels making up the 80 MHz bandwidth need not be contiguous. The VHT features may support the transmission and reception of such an 80 MHz bandwidth signal. The VHT features may also support multi-channel transmissions, including multiple parallel transmissions, using various combinations of 20 MHz channels.

In the multi-channel transmission scenario, the configuration of the channels may be indicated relative to the primary channel in the Secondary Channel Offset field 430. In addition, the VHT features may support a 40 MHz bandwidth signal transmission and reception where the secondary channel may not be adjacent to the primary channel, and may be indicated in the Secondary Channel Offset field 430. An example of the possible secondary channel configurations and corresponding values for the Secondary Channel Offset field 430 corresponding to the VHT 80 MHz bandwidth transmission, VHT 40 MHz bandwidth transmission, and VHT Multi-channel transmission is shown in Table 1. An exact numerical value may be chosen flexibly from any unused value within the range from 0 to 255.

TABLE 1

Secondary channel configurations.	
Value	Description
0	Indicates that no secondary channel is present (just 20 MHz)
1	Indicates that the secondary channel is above the primary channel (for 40 MHz)
2	Unused
3	Indicates that the secondary channel is below the primary channel (for 40 MHz)
Any unused value up to 256 (flexible)	Indicates 3 secondary channels immediately above the primary channel (80 MHz bandwidth formed by 4 contiguous 20 MHz channels)
Any unused value up to 256 (flexible)	Indicates 3 secondary channels immediately below the primary channel (80 MHz bandwidth formed by 4 contiguous 20 MHz channels)
Any unused value up to 256 (flexible)	Indicates 2 secondary channels immediately above the primary channel and 1 secondary channel immediately below the primary channel (80 MHz bandwidth formed by 4 contiguous 20 MHz channels)
Any unused value up to 256 (flexible)	Indicates 1 secondary channel immediately above the primary channel and 2 secondary channels immediately below the primary channel (80 MHz bandwidth formed by 4 contiguous 20 MHz channels)

TABLE 1-continued

Secondary channel configurations.	
Value	Description
Any unused value up to 256 (flexible)	Indicates configuration of positions of each of the 3 secondary channels relative to the primary channel where the 80 MHz bandwidth is not formed by 4 contiguous 20 MHz channels. Many such configurations are possible and each may have a value associated with it.
Any unused value up to 256 (flexible)	Indicates configuration of the position of the secondary channel relative to the primary channel where a 40 MHz bandwidth is not formed by 2 contiguous 20 MHz channels. Many such configurations are possible and each may have a value associated with it.
Any unused value up to 256 (flexible)	Indicates configuration of secondary channels for VHT Multi-channel transmission relative to the primary channel. Many such configurations are possible and each may have a value associated with it.
Remaining up to 255	Unused/Reserved

The Secondary Channel Offset field **430** may be modified to include one or more values to indicate secondary channel configurations supporting VHT 80 MHz bandwidth transmission, VHT 40 MHz bandwidth transmission and VHT Multi-channel transmission. The Secondary Channel Offset field **430** may be included in, for example: 1) the beacon, probe response, association response, and reassociation response frames sent by an AP or an STA in an Independent BSS; 2) a VHT Operation IE included in frames sent by an AP or an STA in an Independent BSS; 3) a Channel Switch Announcement (Action) frame sent by an AP or an STA in an Independent BSS; or 4) a VHT Capabilities IE included in frames sent by an AP or an STA.

In a second example, a VHT Notify bandwidth configuration frame may be an Action frame of category VHT, and may be used to support the various bandwidths 20/40/80 MHz in VHT WLANs. In this example, a VHT STA or AP may send the VHT Notify bandwidth configuration frame to change the bandwidth configuration of frames that are sent to it.

FIG. 5 is a diagram of an example VHT Notify bandwidth configuration frame **500**. The VHT Notify bandwidth configuration frame **500** may include a Category field **510**, an Action field **520**, and a VHT bandwidth configuration field **530**. The Category field **510** may be set to a value to indicate VHT. The Action field **520** may be set to a value that represents a VHT Notify bandwidth configuration. The VHT bandwidth configuration field **530** may contain a bandwidth configuration requested for frames to be sent to the STA or AP transmitting this action frame. The values for the VHT bandwidth configuration field **530** may correspond to the various bandwidth configurations that are possible with VHT 80 MHz bandwidth transmission, VHT 40 MHz bandwidth transmission, and VHT multi-channel transmission. The various bandwidth configurations may be provided, for example, in a modified Secondary Channel Offset IE and/or a Secondary Channel Offset field **430** described in the first example and shown in FIG. 4 and Table 1, respectively. Alternatively, an 802.11 Notify Channel Width frame of Category HT may be modified to support VHT by adding one or more of the VHT bandwidth configurations shown in Table 1 to the 802.11 Channel Width field.

In a third example, a VHT Set Phased Coexistence Operation (PCO) Phase frame may be an Action frame of category VHT, and used to support PCO in VHT WLANs. A VHT WLAN BSS may adopt a VHT PCO where the VHT AP may divide time between 20/40/80 MHz bandwidth operation. Note that all possible combinations may be considered, for example, 20/40/80 MHz, 40/80 MHz, 20/80

MHz, and 20/40 MHz. In addition, since there may be contiguous and non-contiguous channel compositions that constitute the 40 MHz and 80 MHz bandwidths, there may be several possible bandwidth configurations or PCO phases for 40 MHz and 80 MHz. For example, an AP may switch the BSS operation amongst a predetermined set of bandwidths for a VHT phased coexistence operation. Another feature may be added to the VHT PCO where multi-channel transmission configurations, including parallel channel transmission configurations, are supported as additional PCO phases. In this example, the VHT AP may indicate switching to these multi-channel transmission configurations/phases. A VHT Set PCO Phase frame may be sent by an AP to announce the phase change amongst the 20 MHz, 40 MHz and 80 MHz phases.

FIG. 6 is a diagram of an example VHT Set PCO Phase frame **600**. The VHT Set PCO Phase frame **600** may include a Category field **610**, an Action field **620**, and a VHT PCO Phase Control field **630**. The Category field **610** may be set to a value to indicate VHT. The Action field **620** may be set to a value defined for representing VHT Set PCO Phase. The VHT PCO Phase Control field **630** may indicate a current PCO phase. This information may be indicated in a modified 802.11 PCO Phase Control field, and it may include one or more of the values as shown in Table 2.

TABLE 2

A modified 802.11 PCO Phase Control field with values for VHT PCO phases.	
Value	Description
0	Indicates 20 MHz Phase
1	Indicates 40 MHz Phase
Any unused value up to 256 (flexible)	Indicates 40 MHz bandwidth configuration relative to the primary channel formed by: (a) 2 contiguous or (b) 2 non-contiguous 20 MHz channels- many such configurations are possible and each may have a value associated with it.
Any unused value up to 256 (flexible)	Indicates 80 MHz bandwidth configuration relative to the primary channel formed by 4 contiguous 20 MHz channels - many such configurations are possible and each may have a value associated with it.
Any unused value up to 256 (flexible)	Indicates 80 MHz bandwidth configuration relative to the primary channel not formed by 4 contiguous 20 MHz channels- many such configurations are possible and each may have a value associated with it.

TABLE 2-continued

A modified 802.11 PCO Phase Control field with values for VHT PCO phases.	
Value	Description
Any unused value up to 256 (flexible)	Indicates VHT Multi-channel transmission configuration relative to the primary channel - many such configurations are possible and each may have a value associated with it.
Remaining up to 255	Not used/Reserved

The VHT PCO phases may correspond to one or more of the various bandwidth configurations that may be supported in a VHT 80 MHz bandwidth transmission, a VHT 40 MHz bandwidth transmission, and a VHT multi-channel transmission, as shown in Table 2. In one alternative, an 802.11 Set PCO Phase frame of Category HT may be modified to support VHT PCO by replacing an 802.11 PCO Phase Control field with a modified PCO Phase Control field that includes values for VHT PCO Phases as indicated in Table 2. In another alternative, a current VHT PCO Phase of operation indication, or information related thereto, may be included in the beacon, probe response, association response, and reassociation response frames sent by the AP or an STA in an Independent BSS, or in a VHT Operation IE included in frames sent by an AP or an STA in an Independent BSS.

In a fourth example, an 802.11 MIMO Control field may be modified, or a VHT MIMO Control field may be created, to include one or more of the following: 1) a number of columns for a channel state information and/or a transmit beamforming feedback matrix ranging from 1 to 32; 2) a number of rows for a channel state information/transmit beamforming feedback matrix ranging from 1 to 32; 3) a MIMO Control Channel Width indication for VHT covering various bandwidth configuration cases for 20/40/80 MHz as shown in Table 1; 4) a number of OFDM sub-carriers grouped into one or more sets of sub-carriers ranging from 1 to 16; 5) a number of bits in the representation of the real and imaginary parts of each element in the channel state information/transmit beamforming feedback matrix ranging from 4 to 16; 6) a size of the code book information for a Compressed beamforming matrix; 7) a remaining segment number ranging from 0 to 31 for segments of an associated measurement report; and 8) a sounding timestamp corresponding to an end of the reception of a sounding packet, where the sounding packet may be used to generate feedback information to include in the frame that includes the MIMO Control field. The modified MIMO Control field and the VHT MIMO Control field may be included in an 802.11 HT Channel State Information (CSI) Action frame, a VHT CSI Action frame, an 802.11 HT Non-compressed Beamforming Action frame, a VHT Non-compressed Beamforming Action frame, an 802.11 HT Compressed Beamforming Action frame, or a VHT Compressed Beamforming Action frame.

FIG. 7 is a diagram of an example the frame body of a VHT Compressed Beamforming Report Action frame **700**. The VHT Compressed Beamforming Report Action frame **700** may include a Category field **710**, an Action field **720**, a VHT MIMO Control field **730**, and a Compressed Beamforming Report **740**.

In a fifth example, a modified 802.11 Compressed Beamforming Report field for 20/40/80 MHz, or the Compressed Beamforming Report field **740** configured to support VHT,

may include one or more of the following: 1) an Average Signal to Noise Ratio of the STA sending the report for each space-time stream with a resolution that may be in a range from 8 bits to 16 bits, where a number of streams may be specified in a corresponding MIMO Control field as a number of columns in a matrix; 2) a Beamforming Feedback Matrix for OFDM sub-carriers with indices in the range -128 to 128 for 80 MHz; 3) a Beamforming Feedback Matrix for OFDM sub-carriers with indices in the range -58 to 58 for 40 MHz; and 4) a Beamforming Feedback Matrix for OFDM sub-carriers with indices in the range -28 to 28 for 20 MHz. The modified 802.11 Compressed Beamforming Report field for 20/40/80 MHz and the Compressed Beamforming Report field configured to support VHT may be included in an 802.11 HT Compressed Beamforming Action frame or a VHT Compressed Beamforming Action frame. The 802.11 HT Compressed Beamforming Action frame and the VHT Compressed Beamforming Action frame may be sent by an STA/AP in response to a Compressed Beamforming feedback request indication included in an HT Control field or VHT Control field of a frame received from a requesting STA/AP.

In a sixth example, a modified 802.11 Non-compressed Beamforming Report field for 20/40/80 MHz, or a Non-compressed Beamforming Report field configured to support VHT, may include one or more of the following: 1) an Average Signal to Noise Ratio of the STA sending the report for each space-time stream with a resolution that may range from 8 bits to 16 bits, where the number of streams may be specified in a corresponding MIMO Control field as a number of columns in a matrix; 2) a Beamforming Feedback Matrix for OFDM sub-carriers with indices in the range -128 to 128 for 80 MHz; 3) a Beamforming Feedback Matrix for OFDM sub-carriers with indices in the range -58 to 58 for 40 MHz; and 4) a Beamforming Feedback Matrix for OFDM sub-carriers with indices in the range -28 to 28 for 20 MHz. The modified 802.11 Non-compressed Beamforming Report fields for 20/40/80 MHz and the Non-compressed Beamforming Report field configured to support VHT may be included in an 802.11 HT Non-compressed Beamforming Action frame or a VHT Non-compressed Beamforming Action frame. The 802.11 HT Non-compressed Beamforming Action frame and the VHT Non-compressed Beamforming Action frame may be sent by an STA/AP in response to a Non-compressed Beamforming feedback request indication included in an HT Control field or a VHT Control field of a frame received from a requesting STA/AP.

In a seventh example, a modified 802.11 CSI Report field for 20/40/80 MHz, or a CSI Report field configured to support VHT, may include one or more of the following: 1) a Signal to Noise Ratio (SNR) for each receive chain of the STA sending the report with a resolution that may range from 8 bits up to 16 bits, where the number of receive chains may be specified in a corresponding MIMO Control field as a number of rows in a matrix; 2) a CSI Matrix for OFDM sub-carriers with indices in the range -128 to 128 for 80 MHz; 3) a CSI Matrix for OFDM sub-carriers with indices in the range -58 to 58 for 40 MHz; and 4) a CSI Matrix for OFDM sub-carriers with indices in the range -28 to 28 for 20 MHz. The modified 802.11 CSI Report field for 20/40/80 MHz and the CSI Report field configured to support VHT, may be included in an 802.11 HT CSI Action frame or in a VHT CSI Action frame. The 802.11 HT CSI Action frame and the VHT CSI Action frame may be sent by an STA or an AP in response to a CSI feedback request indication

included in an HT Control field or VHT Control field of a frame received from a requesting STA or AP.

In an eighth example, 802.11 Action frames may be modified to include a VHT Capability IE. For example, a VHT Capability IE may be added to the frame body of an 802.11 DLS Request frame, an 802.11 DLS Response frame, an 802.11 tunneled direct link setup (TDLS) Setup Request frame, and an 802.11 TDLS Setup Response frame. The VHT Capabilities IE may be added by a VHT STA/AP in the 802.11 DLS Request and Response frames. The VHT Capabilities IE may be added by a VHT STA in the 802.11 TDLS Setup Request and TDLS Setup Response frames.

In a ninth example, a 20/40/80 BSS Coexistence Management frame may be an Action frame with a category of Public, and may be used to support the VHT increased channel bandwidth transmission mode of 80 MHz. The 20/40/80 BSS Coexistence frame may be used by STAs or APs to exchange information for 20/40/80 BSS Coexistence.

FIG. 8 is a diagram of an example 20/40/80 BSS Coexistence Management frame **800**. The 20/40/80 BSS Coexistence Management frame **800** may include a Category field **810**, an Action field **820**, a 20/40/80 BSS Coexistence field **830**, and a 20/40/80 BSS Intolerant Channel Report field **840**. The Category field **810** may be set to a value to indicate Public. The Action field **820** may be set to a value defined for 20/40/80 BSS Coexistence Management.

The 20/40/80 BSS Coexistence field **830** may contain information related to 20/40/80 BSS Coexistence. The 20/40/80 BSS Coexistence field **830** may contain a 20/40/80 BSS Coexistence IE **900** as shown in FIG. 9. The 20/40/80 BSS Coexistence IE **900** may be used by a STA or an AP to exchange information for 20/40/80 BSS Coexistence. In addition to the 20/40/80 BSS Coexistence Management frame **800**, the STA or the AP may include the 20/40/80 BSS Coexistence IE **900** in a Beacon, Probe Request, Probe Response, Association Request, Association Response, Reassociation Request, and Reassociation Response frames.

The 20/40/80 BSS Coexistence IE **900** may include an Element ID field **910**, a length field **920**, an Information Request indication field **930**, a 40 MHz intolerance indication field **940**, an 80 MHz intolerant indication field **950**, a 20 MHz BSS width request field **960**, an overlapping BSS (OBSS) scanning exemption request field **970**, and an OBSS scanning exemption grant field **980**. The Element ID field **910** may indicate a value specifically for the 20/40/80 BSS Coexistence IE **900**. The Length field **920** may contain the length of the 20/40/80 BSS Coexistence IE **900** following the Length field **920**. The Information Request indication field **930** may be used by a transmitting STA or AP to indicate to the recipient to send a 20/40/80 BSS Coexistence Management frame **800** in response.

The 40 MHz Intolerant indication field **940**, when set to a predetermined value, may indicate that the AP that receives or reports this information may be prohibited from operating a 20/40 MHz BSS. When this field is not set to that specific value, it may not prohibit a receiving AP from operating as a 20/40 MHz BSS. The 80 MHz Intolerant indication field **950**, when set to a predetermined value, may indicate that the AP that receives or reports this information may be prohibited from operating a 20/40/80 MHz BSS. When this field is not set to that specific value, it may not prohibit a receiving AP from operating as a 20/40/80 MHz BSS. The 20 MHz BSS Width Request field **960**, when set to a predetermined value, may indicate that the receiving AP may be prohibited from operating as a 20/40/80 MHz BSS or a 20/40 MHz BSS.

The OBSS Scanning Exemption Request field **970**, when set a predetermined value, may indicate that the transmitting STA requests to be exempted from OBSS scanning by the receiving AP. The OBSS Scanning Exemption Grant field **980**, when set a predetermined value, may indicate that the receiving STA may be exempted by the transmitting AP from performing OBSS Scanning. In an alternative embodiment, the 20/40/80 BSS Coexistence IE **900** may be created by modifying an 802.11 20/40 BSS Coexistence element by adding an 80 MHz Intolerant field **950**.

The 20/40/80 BSS Intolerant Channel Report **840** may contain information on channels that disallow a 20/40/80 MHz BSS operation. For example, the 20/40/80 BSS Intolerant Channel Report field **840** may contain a 20/40/80 BSS Intolerant Channel Report IE **1000** as shown in FIG. 10.

The 20/40/80 BSS Intolerant Channel Report IE **1000** may include an Element ID field **1010**, a Length field **1020**, a Regulatory Class Information field **1030**, and a Channel List field **1040**. The Element ID field **1010** may indicate a value specifically for the 20/40/80 BSS Intolerant Channel Report IE **1000**. The Length field **1020** may contain the length of the 20/40/80 BSS Intolerant Channel Report IE **1000** following the Length field **1020**. The Regulatory Class Information field **1030** may contain information that specifies the regulatory class in which the Channel List in the Channel List field **1040** may be valid. The Channel List field **1040** may contain a list of channels on which a 20/40/80 MHz BSS operation is disallowed.

In a tenth example, an 802.11 Antenna Selection Indices field may be modified, or a VHT Antenna Selection Indices field may be created, to support up to 16 Antennas. The 802.11 Antenna Selection Indices field may be 8 bits in length and may support only 8 antennas, where each bit in the field may be used to indicate the selection of a corresponding antenna. The modified 802.11 Antenna Selection Indices field and the VHT Antenna Selection Indices field may have 16 bits, where each bit may correspond to an antenna index and may be used to indicate a selection of a corresponding antenna. The modified 802.11 Antenna Selection Indices field and the VHT Antenna Selection Indices field may be included in an 802.11 HT Antenna Selection Indices Feedback Action frame or a VHT Antenna Selection Indices Feedback Action frame, and sent by an STA or an AP in response to an Antenna Selection Indices feedback request indication included in an HT Control field or a VHT Control field of a frame received from a requesting STA or AP.

FIG. 11 is a flow diagram of an example method **1100** for supporting management actions in VHT communications. A STA/AP **1110** may transmit a management action frame **1120** to another STA **1130**. The management action frame **1120** may be a VHT Action frame, and may be assigned a category and/or a subtype. STA **1130** may change an operating parameter **1140** based on a field in the management action frame **1120**.

The assignment of category for each of the VHT Action frames may be flexible such that they may be assigned a category that is new such as "VHT" or any 802.11 category. In addition, the VHT Action frames may have subtypes "Action" or "Action with ACK", and "Action No ACK." Moreover the "Action No ACK" subtype VHT Action frames may be aggregated by an STA/AP with one or more of data frames, control frames, and management frames for transmission in an aggregated packet data unit. For example, STA **1130**, or an AP, may transmit an ACK **1150** if it receives a VHT Action frame of a subtype "Action." STA

1130, or an AP, may not transmit an ACK if it receives a VHT Action frame of a subtype "Action No ACK."

Although features and elements are described above in particular combinations, one of ordinary skill in the art will appreciate that each feature or element can be used alone or in any combination with the other features and elements. In addition, the methods described herein may be implemented in a computer program, software, or firmware incorporated in a computer-readable medium for execution by a computer or processor. Examples of computer-readable media include electronic signals (transmitted over wired or wireless connections) and computer-readable storage media. Examples of computer-readable storage media include, but are not limited to, a read only memory (ROM), a random access memory (RAM), a register, cache memory, semiconductor memory devices, magnetic media such as internal hard disks and removable disks, magneto-optical media, and optical media such as CD-ROM disks, and digital versatile disks (DVDs). A processor in association with software may be used to implement a radio frequency transceiver for use in a WTRU, UE, terminal, base station, RNC, or any host computer.

What is claimed is:

1. A method for use in wireless communications, the method comprising:

transmitting a sounding packet to a station (STA); and receiving, from the STA, an Action No Acknowledgement (ACK) frame that includes a Very High Throughput (VHT) multiple input multiple output (MIMO) Control field and a VHT Compressed Beamforming Report field, wherein the VHT MIMO Control field indicates a channel width related to a multi-channel non-contiguous spectrum transmission associated with the sounding packet, and wherein the VHT Compressed Beamforming Report field includes information based on a value indicated in the VHT MIMO Control field.

2. The method of claim 1, wherein the VHT MIMO Control field indicates a number of columns in a matrix and a number of rows in the matrix.

3. The method of claim 1, wherein the VHT MIMO Control field indicates a bandwidth configuration that includes a plurality of secondary channels for a VHT multi-channel transmission relative to a primary channel.

4. The method of claim 1, wherein the VHT Compressed Beamforming Report field includes a plurality of orthogonal frequency division multiplex (OFDM) sub-carriers, wherein the OFDM sub-carriers are grouped in a set.

5. The method of claim 1, wherein a compressed beamforming matrix code book information size is included in the VHT MIMO Control field.

6. The method of claim 1, wherein the VHT MIMO Control field indicates a remaining segment number of an associated measurement report.

7. The method of claim 1, wherein the VHT Compressed Beamforming Report field includes an average signal to noise ratio (SNR) for each of a number of space-time streams.

8. The method of claim 1, wherein the VHT Compressed Beamforming Report field includes a Beamforming Feedback Matrix for each of a number of space-time streams.

9. An access point (AP) comprising:
a transmitter configured to transmit a sounding packet;
and

a receiver configured to receive an Action No Acknowledgement (ACK) frame that includes a Very High Throughput (VHT) multiple input multiple output (MIMO) Control field and a VHT Compressed Beamforming Report field, wherein the VHT MIMO Control field indicates a channel width related to a multi-channel non-contiguous spectrum transmission associated with the sounding packet, and wherein the VHT Compressed Beamforming Report field includes information based on a value indicated in the VHT MIMO Control field.

10. The AP of claim 9, wherein the VHT MIMO Control field indicates a number of columns in a matrix and a number of rows in the matrix.

11. The AP of claim 9, wherein the VHT MIMO Control field indicates a bandwidth configuration that includes a plurality of secondary channels for a VHT multi-channel transmission relative to a primary channel.

12. The AP of claim 9, wherein the VHT Compressed Beamforming Report field includes a plurality of orthogonal frequency division multiplex (OFDM) sub-carriers, wherein the OFDM sub-carriers are grouped in a set.

13. The AP of claim 9, wherein a compressed beamforming matrix code book information size is included in the VHT MIMO Control field.

14. The AP of claim 9, wherein the VHT MIMO Control field indicates a remaining segment number of an associated measurement report.

15. The AP of claim 9, wherein the VHT Compressed Beamforming Report field includes an average signal to noise ratio (SNR) for each of a number of space-time streams.

16. The AP of claim 9, wherein the VHT Compressed Beamforming Report field includes a Beamforming Feedback Matrix for each of a number of space-time streams.

17. An access point (AP) comprising:
a transmitter configured to transmit a sounding packet;
and

a receiver configured to receive an Action No Acknowledgement (ACK) frame that includes a Very High Throughput (VHT) multiple input multiple output (MIMO) Control field and a VHT Compressed Beamforming Report field, wherein the VHT MIMO Control field indicates a channel width related to a multi-channel non-contiguous spectrum transmission associated with the sounding packet;

wherein the VHT Compressed Beamforming Report field includes an average signal to noise ratio (SNR) for each of a number of space-time streams and a Compressed Beamforming Feedback Matrix for each of a number of space-time streams.

18. The AP of claim 17, wherein the VHT MIMO Control field indicates a number of columns in a matrix and a number of rows in the matrix.

19. The AP of claim 17, wherein a compressed beamforming matrix code book information size is included in the VHT MIMO Control field.

20. The AP of claim 17, wherein the VHT MIMO Control field indicates a remaining segment number of an associated measurement report.

UNITED STATES PATENT AND TRADEMARK OFFICE
CERTIFICATE OF CORRECTION

PATENT NO. : 9,647,743 B2
APPLICATION NO. : 15/186604
DATED : May 9, 2017
INVENTOR(S) : Sudheer A. Grandhi

Page 1 of 1

It is certified that error appears in the above-identified patent and that said Letters Patent is hereby corrected as shown below:

On the Title Page

At Item (56) OTHER PUBLICATIONS, page 2 right column, Line 70 delete "09/099208," and insert therefor --09/0992r18,--.

At Item (56) OTHER PUBLICATIONS, page 2 right column, Line 72 delete "0610886r4," and insert therefor --06/0886r4,--.

In the Specification

In Column 6, Line 10 after "memory" delete "106" and insert --130--.

In Column 6, Line 11 after "memory" delete "106" and insert --130--.

In Column 8, Line 7 after "described in" delete "an" and insert --a--.

In Column 10, Line 15 after "40" delete "MHZ" and insert --MHz--.

In Column 12, Line 43 after "Phase Control field," delete "an" and insert --and--.

In Column 13, Line 59 after "example" delete "the".

In Column 16, Line 10 after "Intolerant" insert --indication--.

In Column 16, Line 50 after "communications." delete "A an" and insert --An--.

Signed and Sealed this
Twenty-second Day of August, 2017



Joseph Matal
*Performing the Functions and Duties of the
Under Secretary of Commerce for Intellectual Property and
Director of the United States Patent and Trademark Office*