



US009451530B2

(12) **United States Patent**  
**Gunnarsson et al.**

(10) **Patent No.:** **US 9,451,530 B2**  
(45) **Date of Patent:** **Sep. 20, 2016**

(54) **METHODS FOR  
BASE-STATION-TO-BASE-STATION  
CONNECTION MANAGEMENT**

(71) Applicant: **Telefonaktiebolaget L M Ericsson**  
(publ), Stockholm (SE)

(72) Inventors: **Fredrik Gunnarsson**, Linköping (SE);  
**Stefan Engström**, Linköping (SE);  
**Gino Luca Masini**, Stockholm (SE);  
**Karl Norrman**, Stockholm (SE)

(73) Assignee: **Telefonaktiebolaget L M Ericsson**  
(publ), Stockholm (SE)

(\*) Notice: Subject to any disclaimer, the term of this  
patent is extended or adjusted under 35  
U.S.C. 154(b) by 0 days.

(21) Appl. No.: **14/068,755**

(22) Filed: **Oct. 31, 2013**

(65) **Prior Publication Data**

US 2014/0128086 A1 May 8, 2014

**Related U.S. Application Data**

(60) Provisional application No. 61/721,745, filed on Nov.  
2, 2012.

(51) **Int. Cl.**  
**H04W 40/24** (2009.01)  
**H04W 92/20** (2009.01)  
(Continued)

(52) **U.S. Cl.**  
CPC ..... **H04W 40/248** (2013.01); **H04L 61/15**  
(2013.01); **H04L 61/2076** (2013.01); **H04L**  
**61/304** (2013.01); **H04W 92/20** (2013.01);  
(Continued)

(58) **Field of Classification Search**  
None  
See application file for complete search history.

(56) **References Cited**

U.S. PATENT DOCUMENTS

8,713,658 B1 4/2014 Tidd  
9,131,424 B2 \* 9/2015 Xu ..... H04W 36/0033

(Continued)

FOREIGN PATENT DOCUMENTS

EP 1385316 A1 1/2004  
EP 2230864 A1 \* 9/2010

(Continued)

OTHER PUBLICATIONS

Author Unknown, "Technical Specification Group Core Network  
and Terminals; Characteristics of the Universal Subscriber Identity  
Module (USIM) application (Release 11)," Technical Specification  
31.102, Version 11.3.0, 3GPP Organizational Partners, Sep. 2012,  
228 pages.

(Continued)

*Primary Examiner* — King Poon

*Assistant Examiner* — Vincent Peren

(74) *Attorney, Agent, or Firm* — Withrow & Terranova,  
PLLC

(57) **ABSTRACT**

The present disclosure relates to a base station in a cellular  
communication network and methods of operation thereof.  
In one embodiment, a base station determines that the base  
station is transitioning to an unavailable state. The base  
station then notifies one or more radio network nodes with  
which the base station conducts base-station-to-node com-  
munication that the base station is unavailable. Thereafter, in  
one embodiment, the one or more radio network nodes cease  
communication attempts with the base station. In this man-  
ner, the radio network nodes can avoid spending additional  
resources on attempts to re-establish communication con-  
nections to base stations that tend to be offline more often  
(e.g., low-power base stations (LP-BSs)).

**31 Claims, 18 Drawing Sheets**

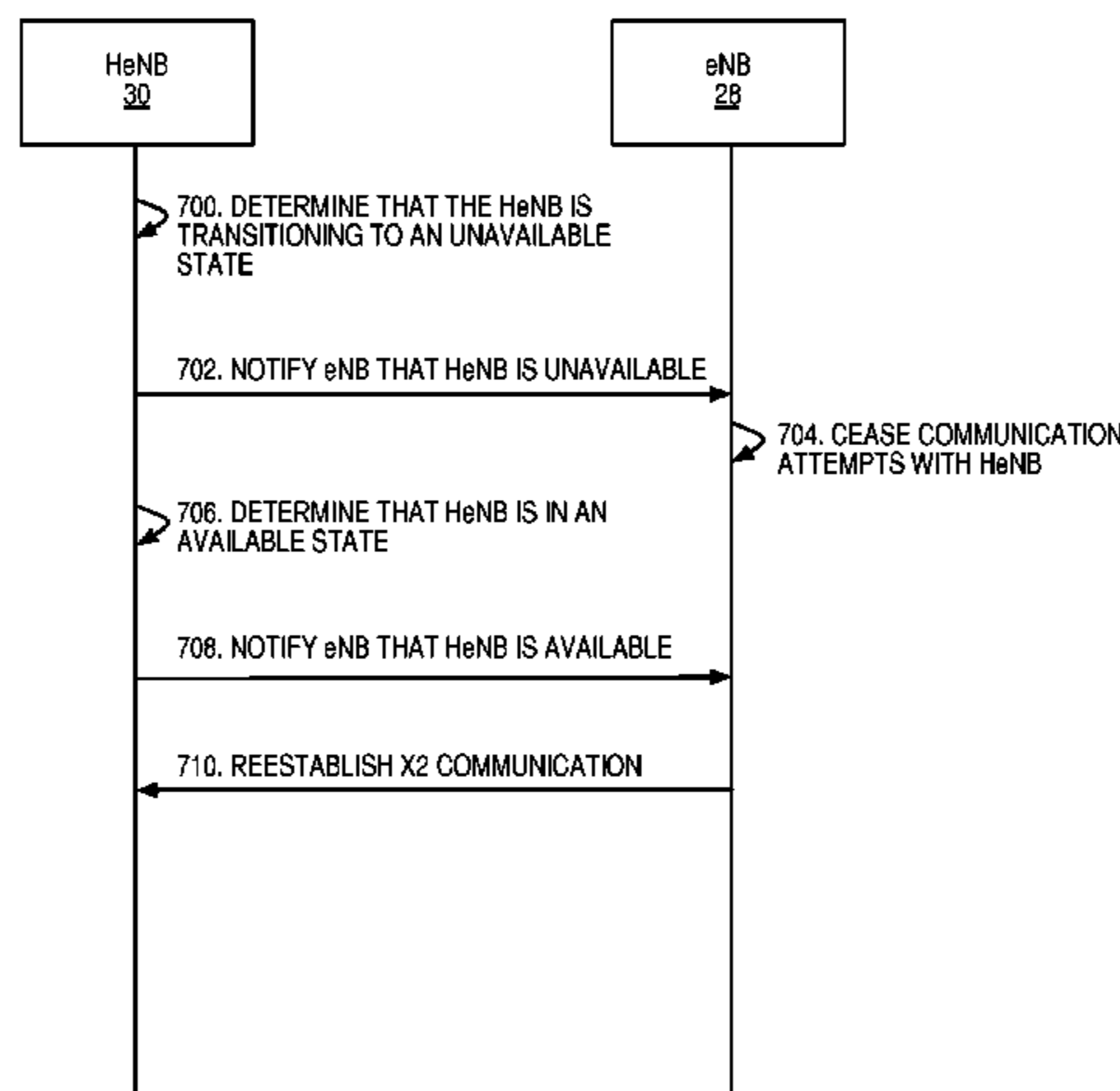

- (51) **Int. Cl.**  
*H04L 29/12* (2006.01)  
*H04W 84/04* (2009.01)  
*H04W 88/18* (2009.01)
- (52) **U.S. Cl.**  
 CPC ..... *H04W84/045* (2013.01); *H04W 88/182*  
 (2013.01); *Y02B 60/50* (2013.01)

(56) **References Cited**

U.S. PATENT DOCUMENTS

2005/0157726	A1*	7/2005	Vesterinen	370/395.5
2008/0101357	A1	5/2008	Iovanna et al.	
2009/0207855	A1*	8/2009	Watanabe	H04L 69/326 370/466
2010/0039987	A1	2/2010	Hegde et al.	
2010/0248723	A1*	9/2010	Yasuoka	455/436
2011/0044284	A1*	2/2011	Voltolina	H04W 24/02 370/331
2011/0287772	A1*	11/2011	Park et al.	455/450
2011/0310791	A1	12/2011	Prakash et al.	
2012/0188984	A1	7/2012	Takahashi et al.	
2012/0258724	A1*	10/2012	Kim et al.	455/452.2
2013/0051316	A1	2/2013	Bhatt et al.	
2013/0064092	A1*	3/2013	Xi et al.	370/235
2013/0281097	A1	10/2013	Jung	
2013/0322390	A1	12/2013	Xu et al.	
2015/0215774	A1	7/2015	Huang et al.	
2015/0289302	A1	10/2015	Xu et al.	

FOREIGN PATENT DOCUMENTS

JP	2009152691	A	7/2009
JP	2011166432	A	8/2011
WO	2010047647	A1	4/2010
WO	2011157072	A1	12/2011
WO	2012093893	A2	7/2012
WO	2014019777	A1	2/2014

OTHER PUBLICATIONS

Author Unknown, "Technical Specification Group Core Network and Terminals; Domain Name System Procedures; Stage 3 (Release 11)," Technical Specification 29.303, Version 11.2.0, 3GPP Organizational Partners, Sep. 2012, 57 pages.

Author Unknown, "Technical Specification Group Core Network and Terminals; Numbering, addressing and identification (Release 11)," Technical Specification 23.003, Version 11.3.0, 3GPP Organizational Partners, Sep. 2012, 83 pages.

Author Unknown, "Technical Specification Group Radio Access Network; Evolved Universal Terrestrial Radio Access Network

(E-UTRAN); S1 signalling transport (Release 11)," Technical Specification 36.412, Version 11.0.0, 3GPP Organizational Partners, Sep. 2012, 8 pages.

Author Unknown, "Technical Specification Group Radio Access Network; Evolved Universal Terrestrial Radio Access Network (E-UTRAN); X2 signalling transport (Release 11)," Technical Specification 36.422, Version 11.0.0, 3GPP Organizational Partners, Sep. 2012, 8 pages.

Author Unknown, "Technical Specification Group Radio Access Network; Universal Mobile Telecommunications System (UMTS) and LTE; Mobility enhancements for Home Node B (HNB) and Home enhanced Node B (HeNB) (Release 11)," Technical Report 37.803, Version 11.0.0, 3GPP Organizational Partners, Jun. 2012, 120 pages.

Author Unknown, "Technical Specification Group Radio Access Network; Universal Mobile Telecommunications System (UMTS) and LTE; Mobility enhancements for Home Node B (HNB) and Home enhanced Node B (HeNB) (Release 11)," Technical Report 37.803, Version 11.2.0, 3GPP Organizational Partners, Jun. 2013, 116 pages.

Deering, S. et al., "Internet Protocol, Version 6 (IPv6)," Request for Comments: 2460, Standards Track, Dec. 1998, The Internet Society, 39 pages.

NSN, "R3-131690: How to handle the HeNB switch off," 3rd Generation Partnership Project (3GPP), TSG-RAN WG3 Meeting #81bis, Oct. 7-11, 2013, 4 pages, Venice, Italy.

Stewart, R., "Stream Control Transmission Protocol," Request for Comments: 4960, Standards Track, Sep. 2007, The IETF Trust, 153 pages.

International Search Report and Written Opinion for PCT/IB2013/059854 mailed Feb. 7, 2014, 12 pages.

Ericsson, "R3-131780: On the HeNB Registration Procedure with the X2-GW," 3rd Generation Partnership Project (3GPP), TSG-RAN WG3 #81bis, Oct. 7-11, 2013, Venice, Italy, 3 pages.

Huawei et al., "R3-121536: Introduction of connectivity between HNBs and RNCs via the HNB-GW for RNSAP signalling," 3rd Generation Partnership Project (3GPP), TSG-RAN3 Meeting #77; Aug. 13-17, 2012, Qingdao, China, 10 pages.

International Search Report and Written Opinion for PCT/IB2013/059857, mailed Mar. 25, 2014, 16 pages.

Non-Final Office Action for U.S. Appl. No. 14/068,744, mailed Jul. 6, 2015, 24 pages.

Notice of Allowance and Examiner-Initiated Interview Summary for U.S. Appl. No. 14/068,744, mailed Dec. 21, 2015, 15 pages.

Nokia Siemens Networks, "R3-122183: X2-Gateway—Further details on the way forward," 3rd Generation Partnership Project (3GPP), TSG-RAN WG3 Meeting #77bis, Oct. 8-12, 2012, 4 pages, Lecce, Italy.

Notice of Reasons for Rejection for Japanese Patent Application No. 2015-540259, issued May 17, 2016, 7 pages.

\* cited by examiner

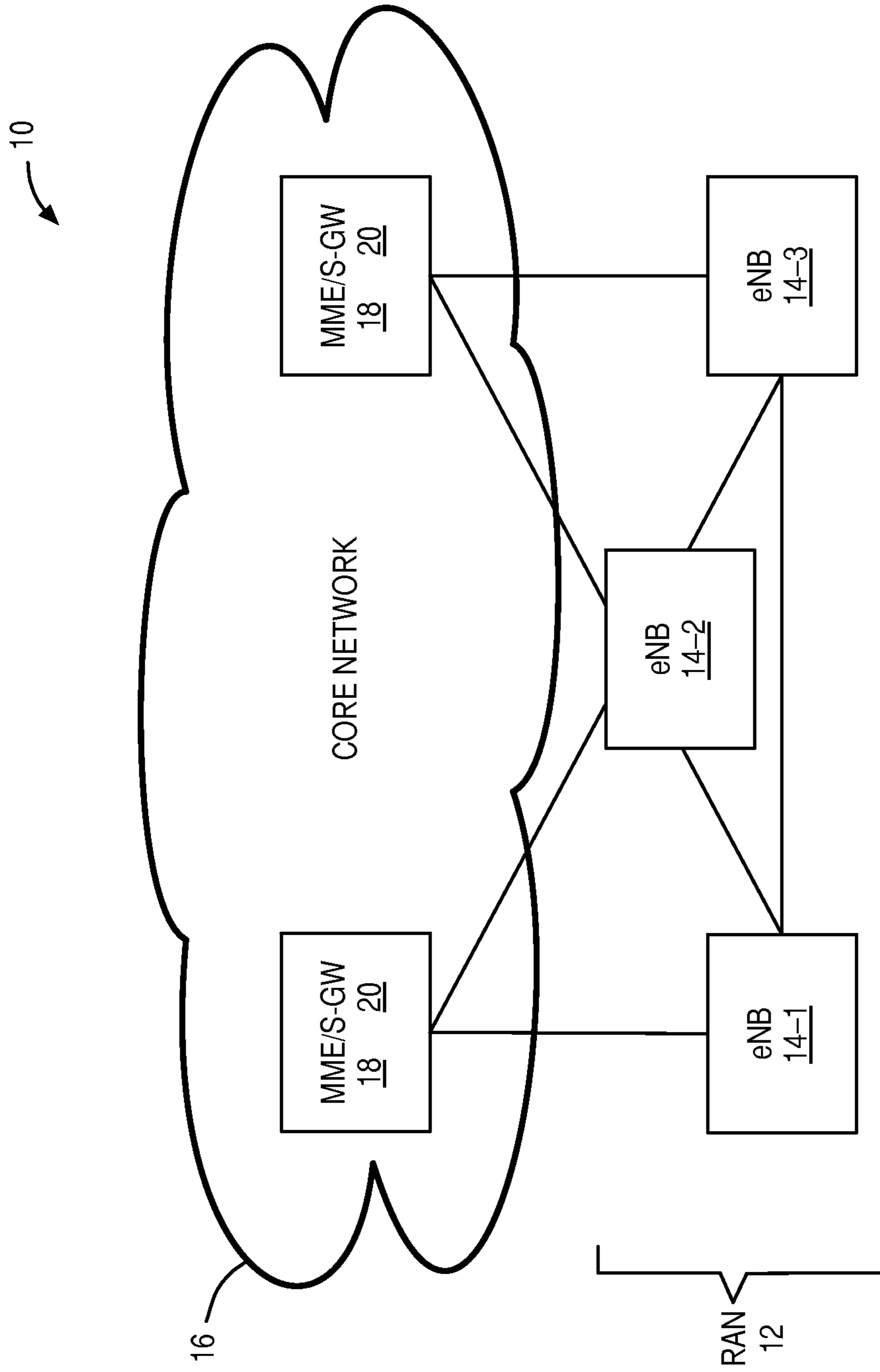

FIG. 1

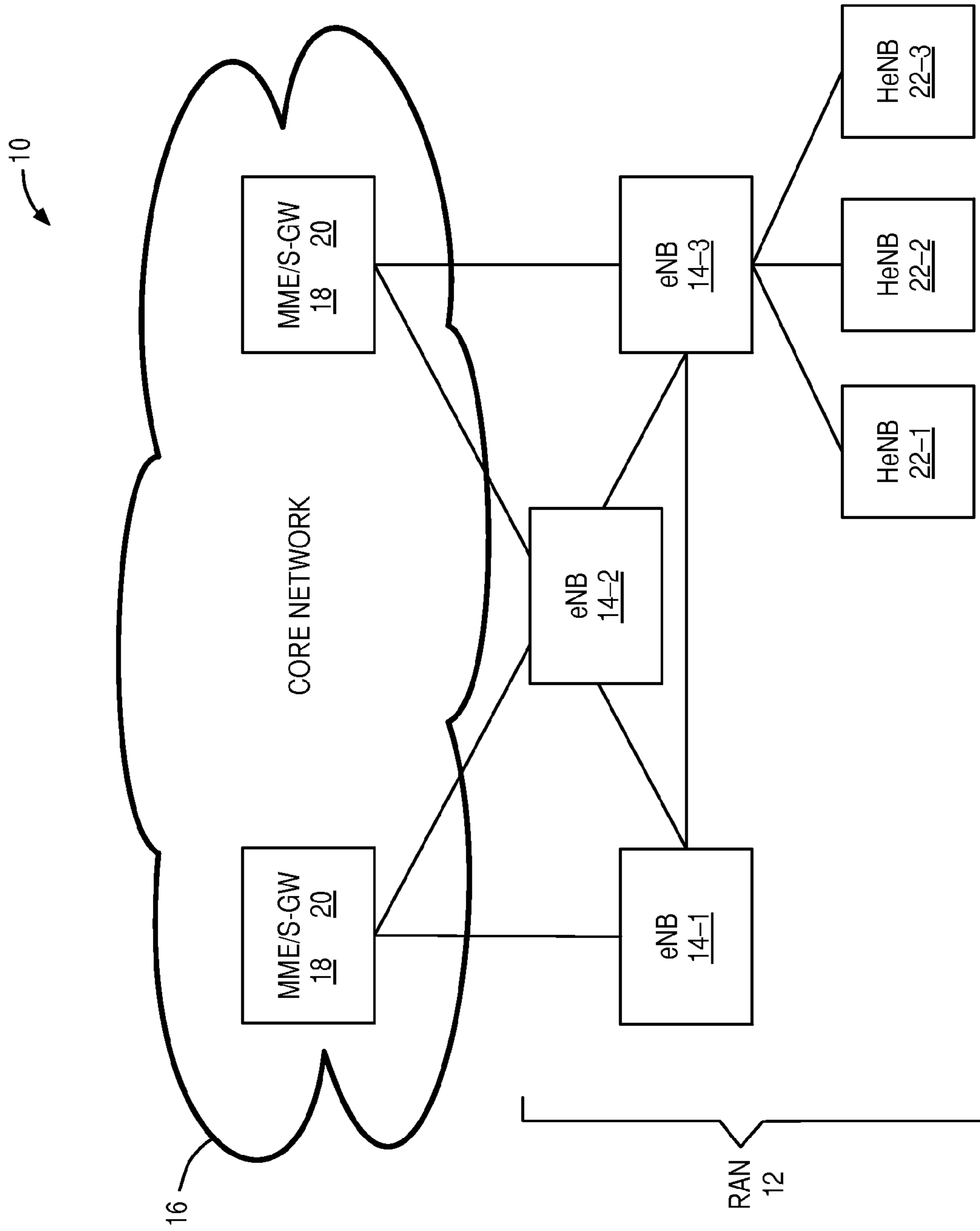

FIG. 2

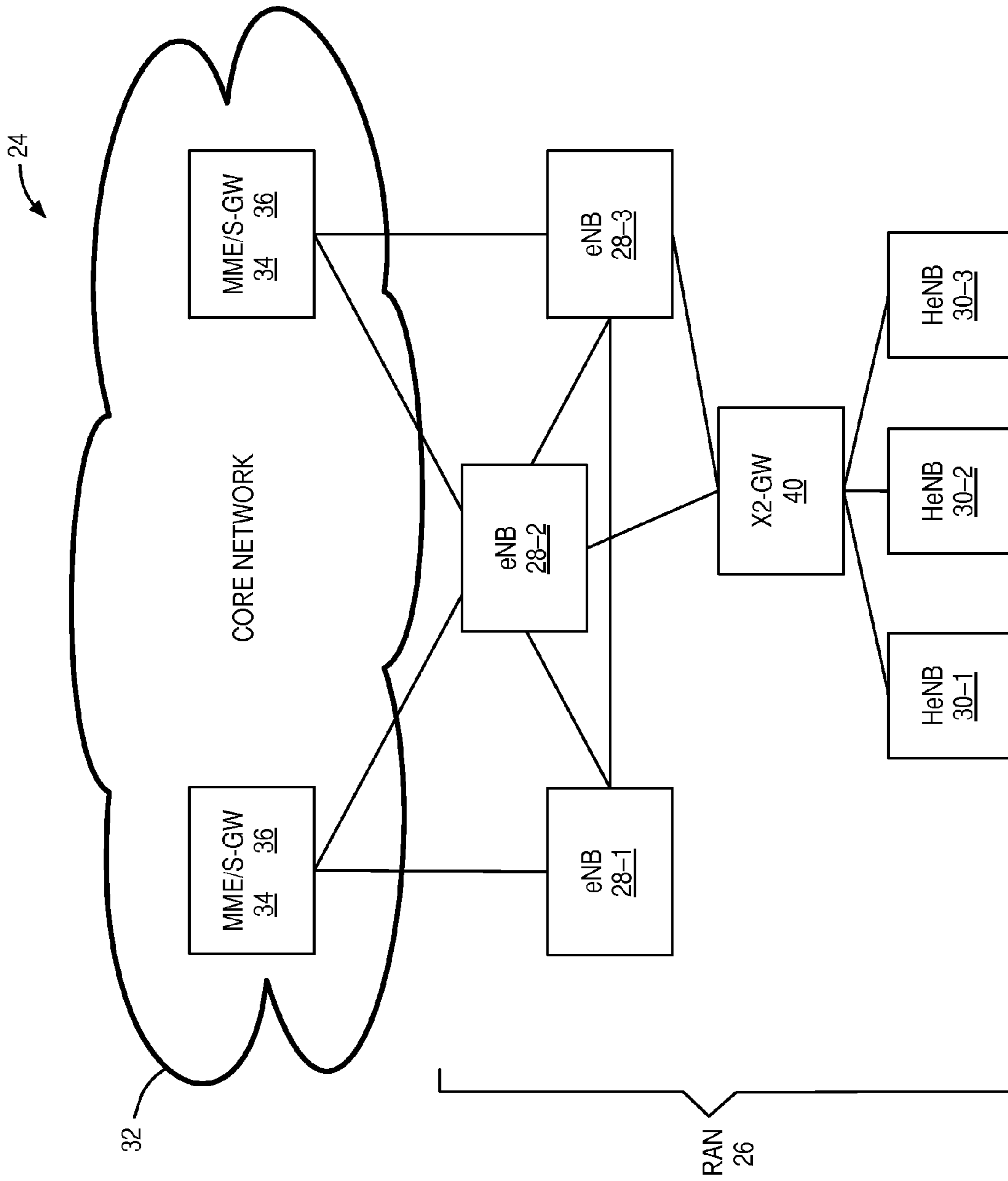

FIG. 3

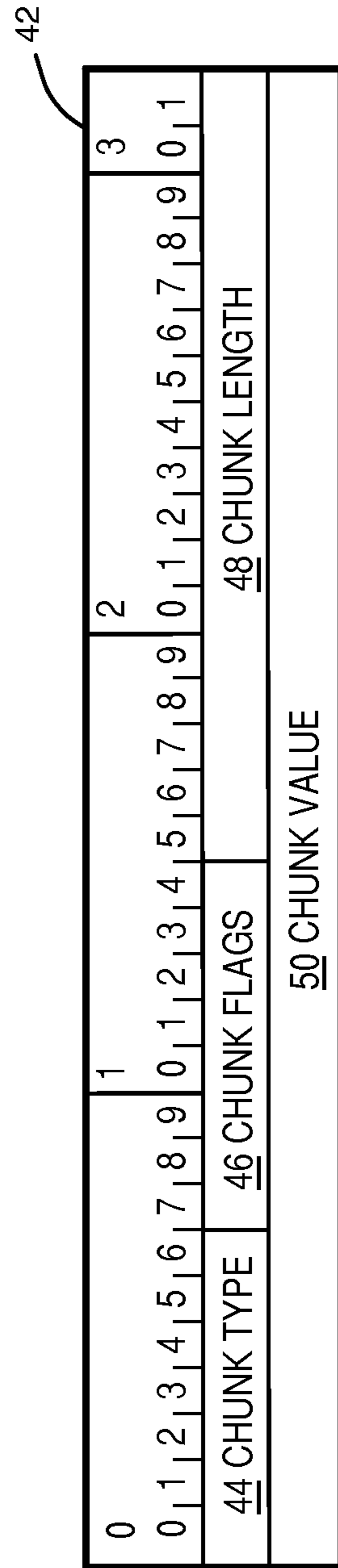

FIG. 4

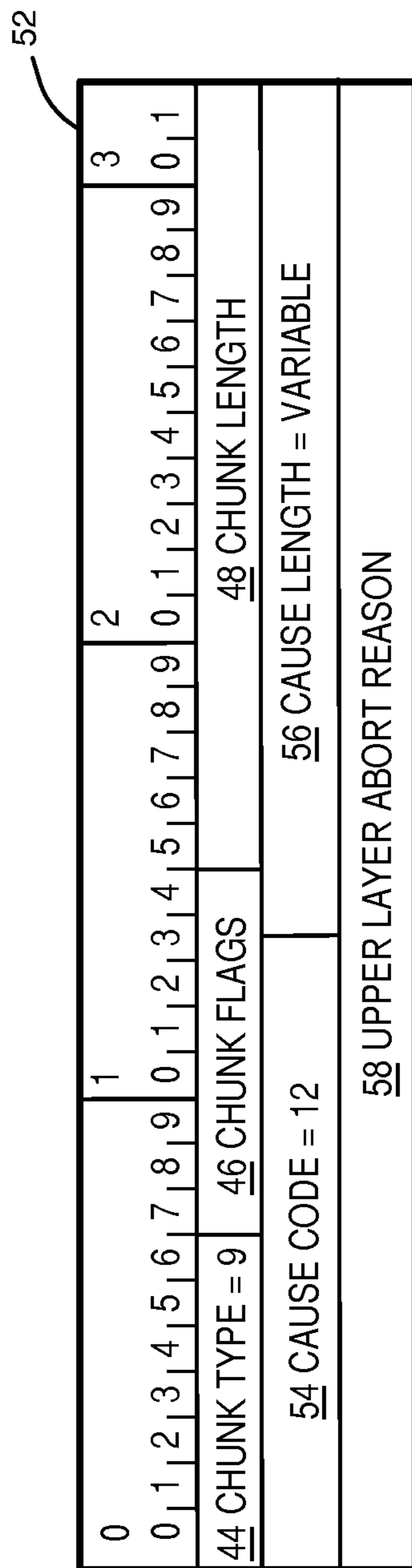

FIG. 5

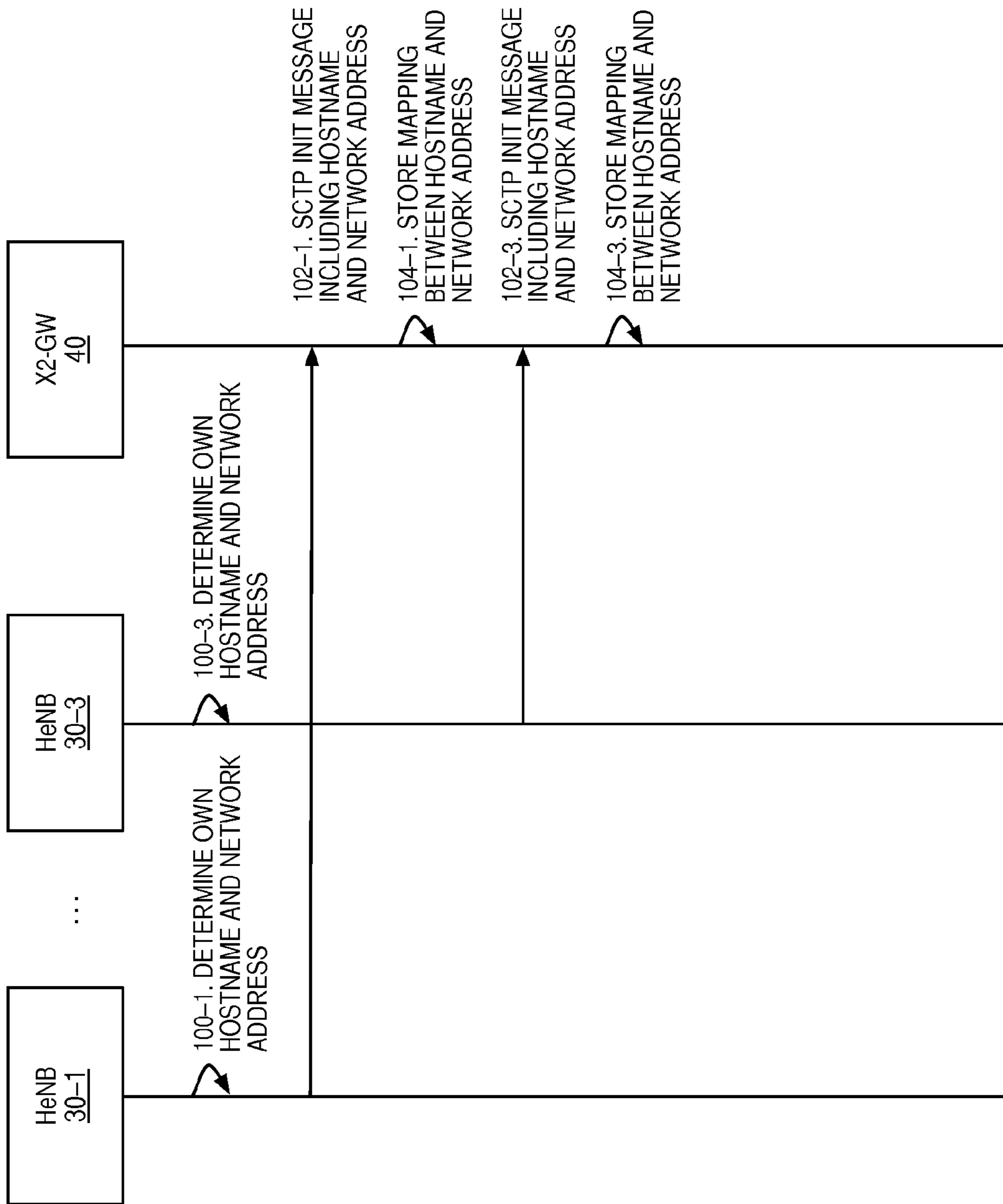
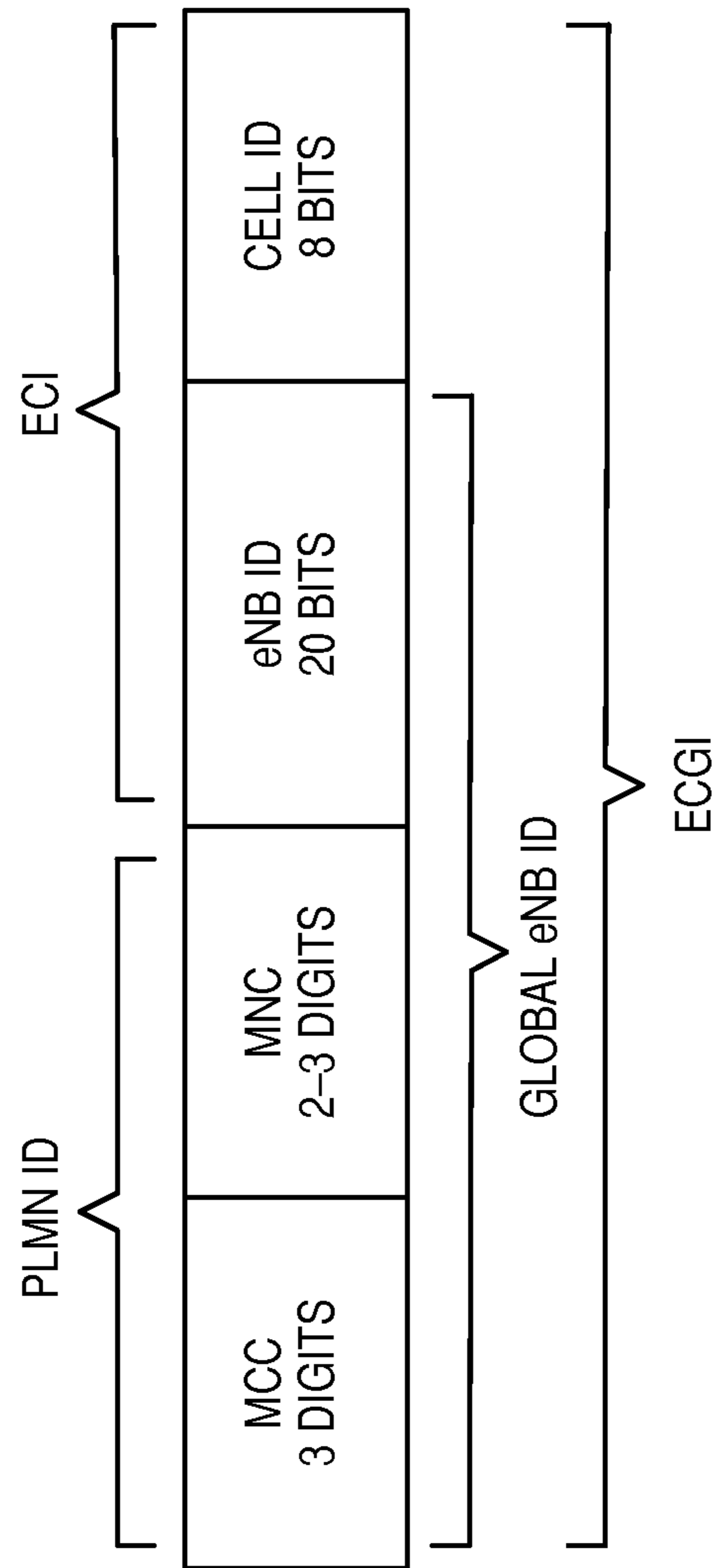

FIG. 6





**FIG. 7A**

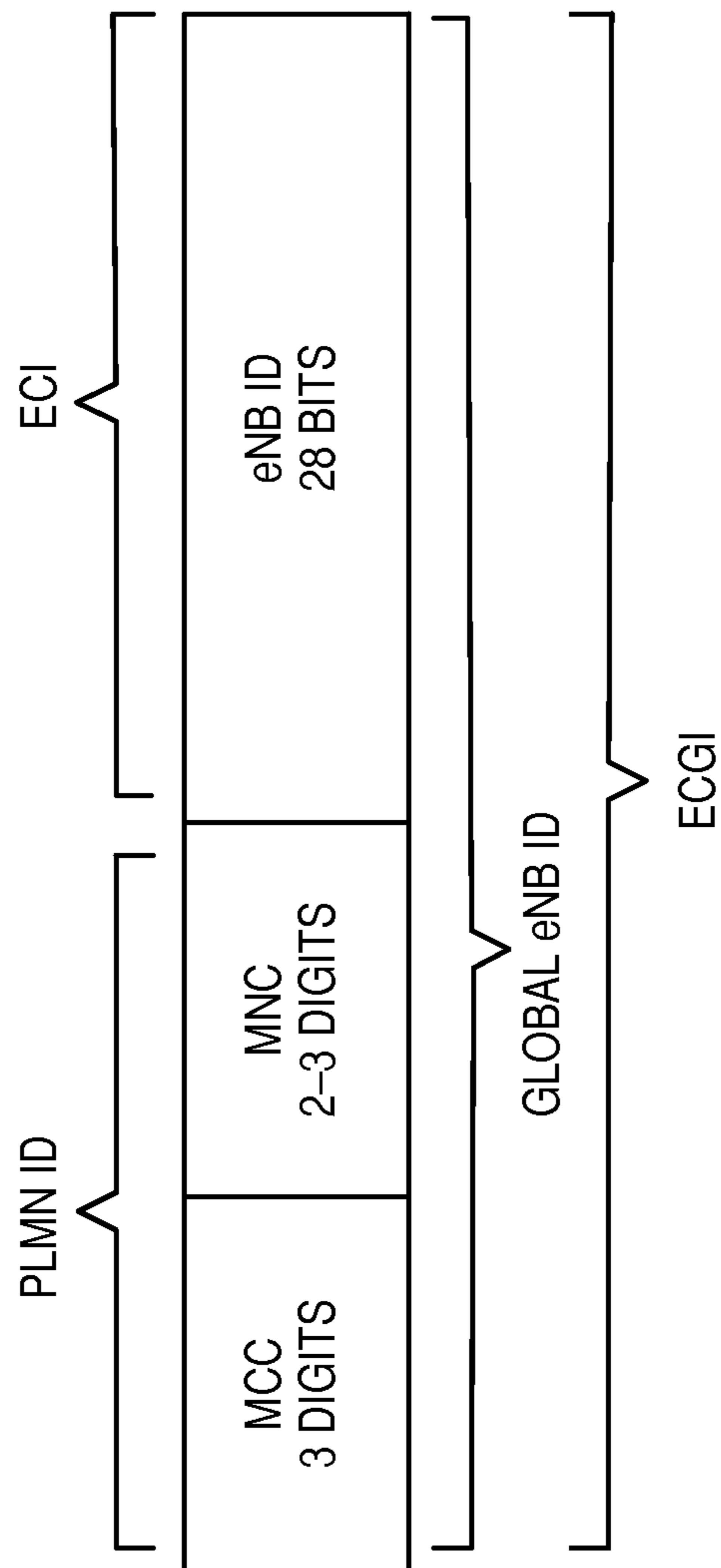

FIG. 7B

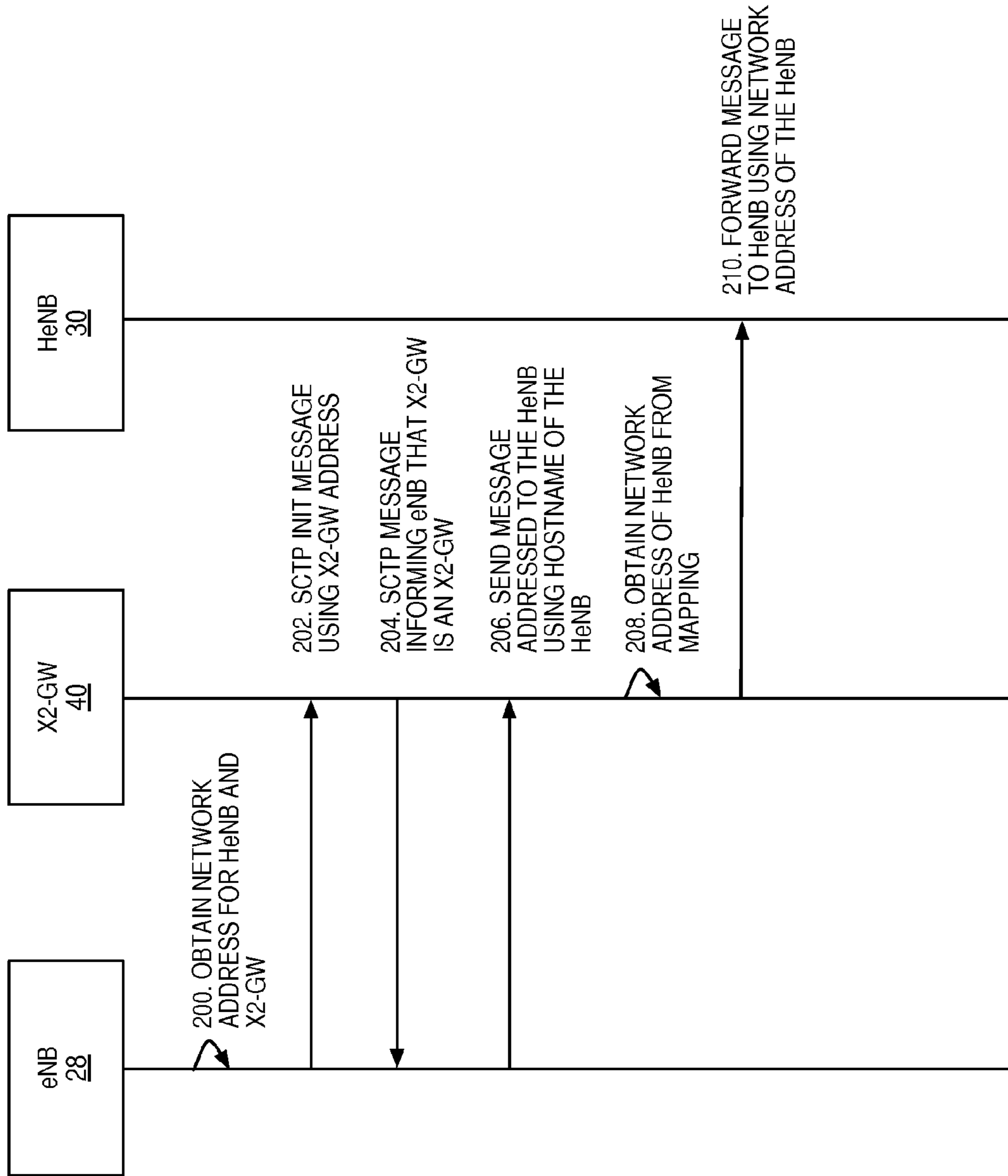

FIG. 8

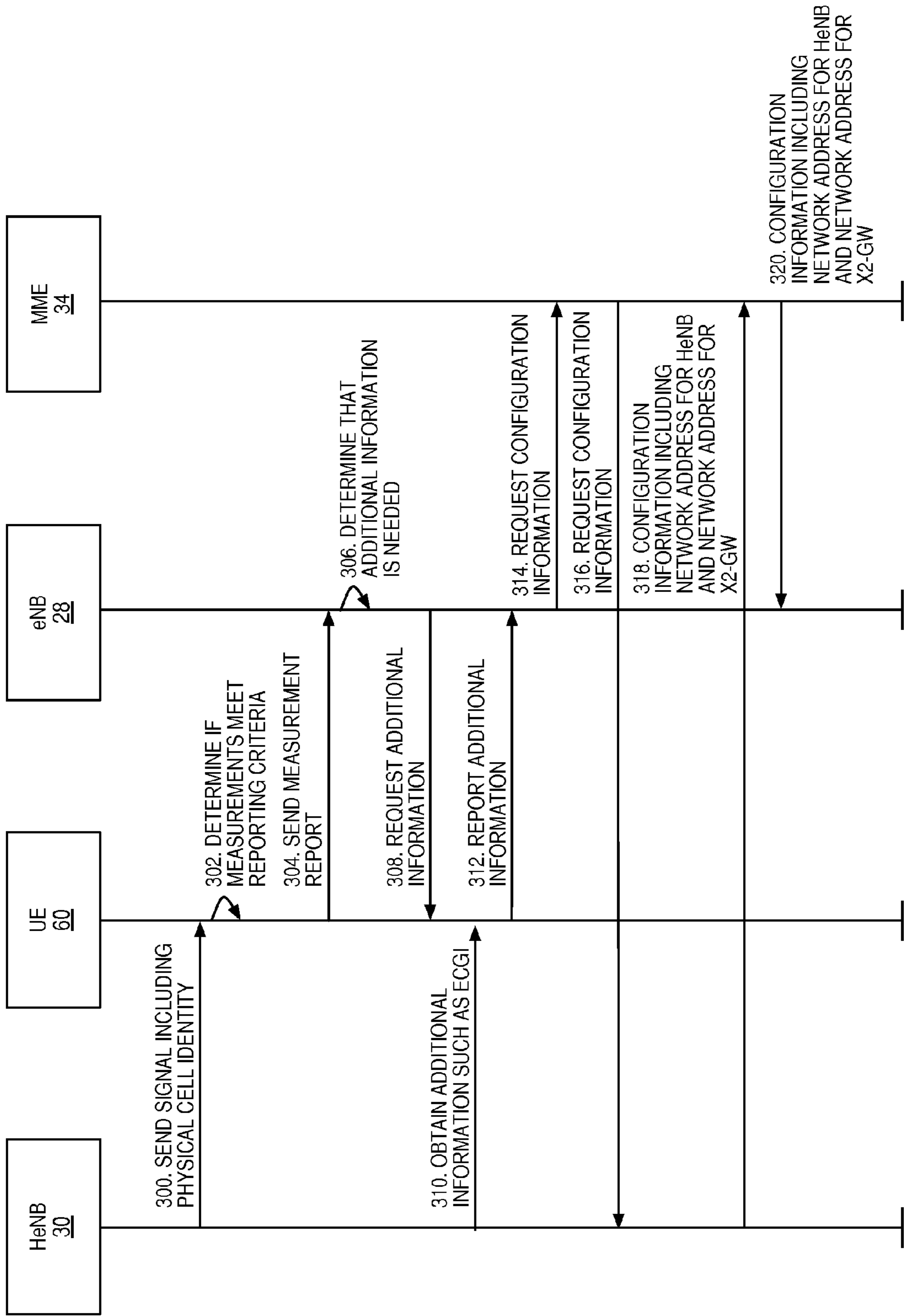

FIG. 9

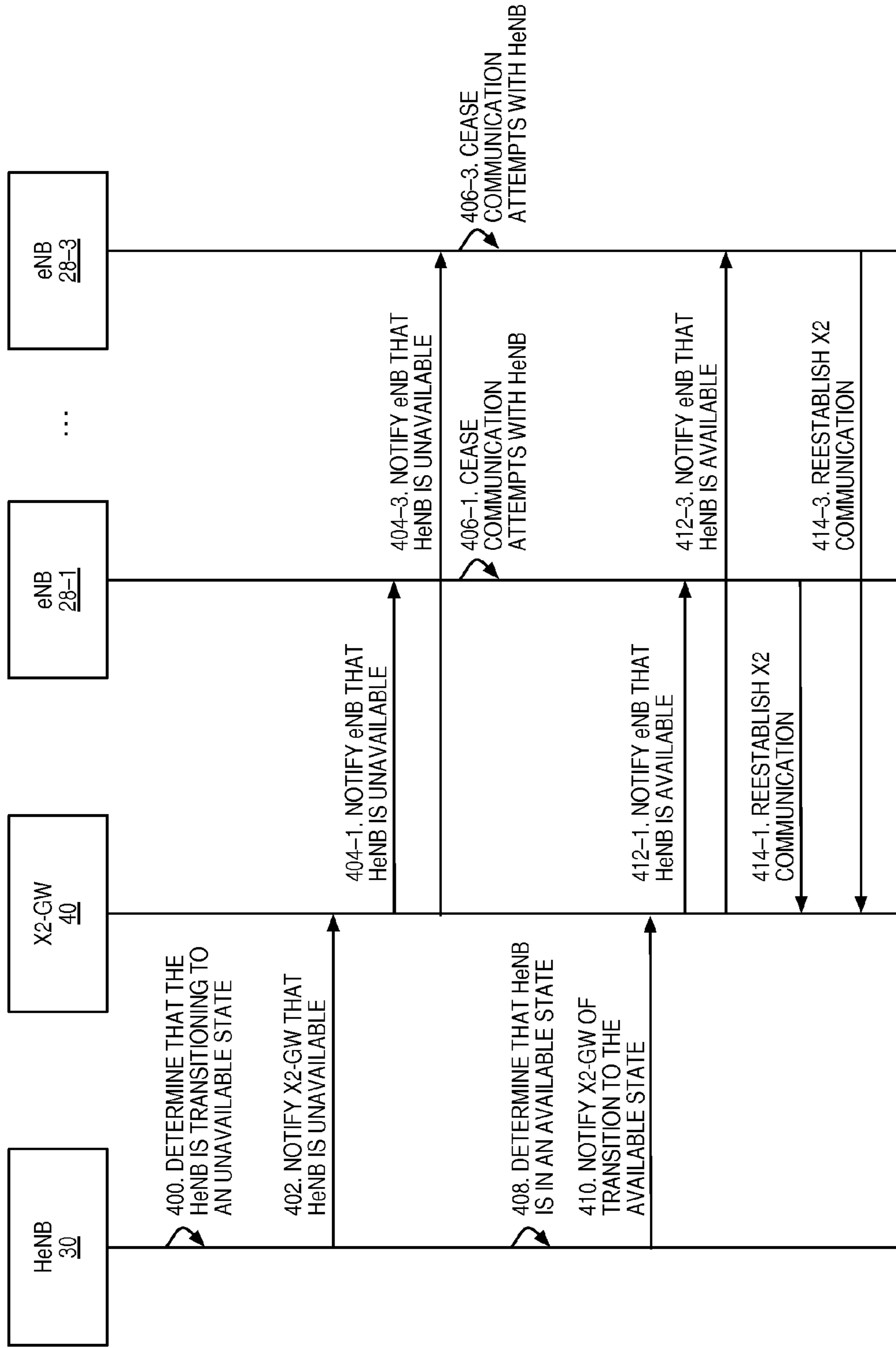

FIG. 10A

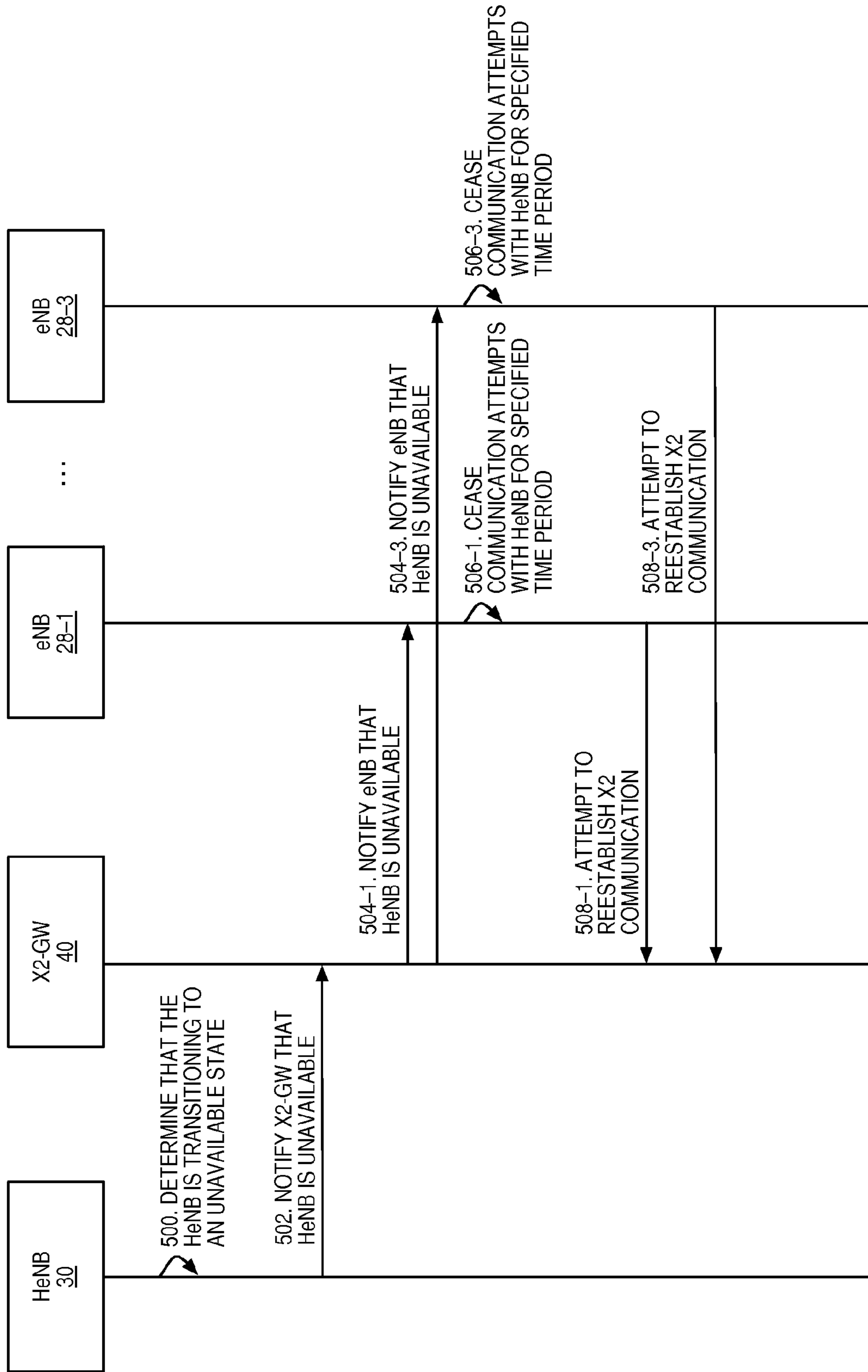

FIG. 10B

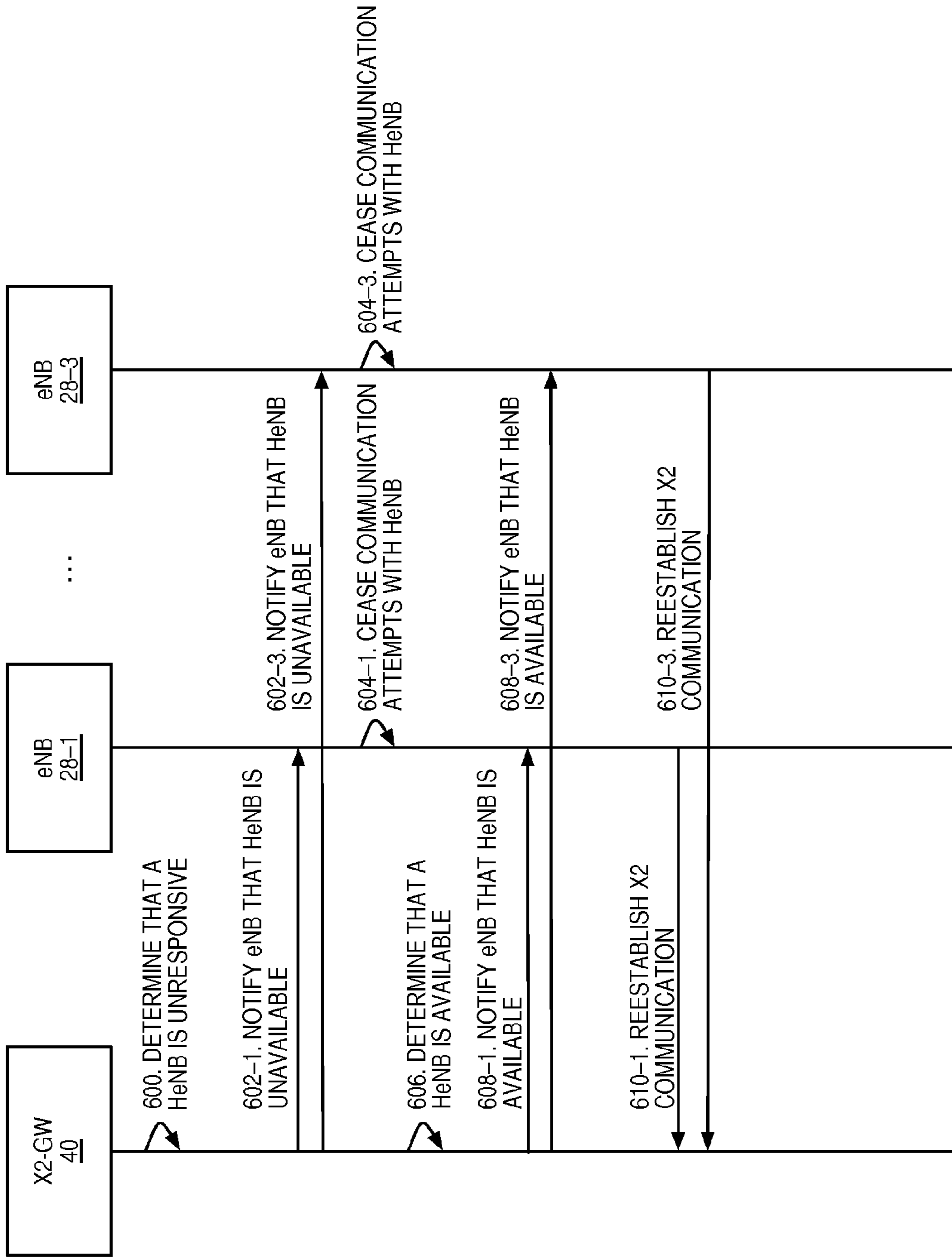

FIG. 11

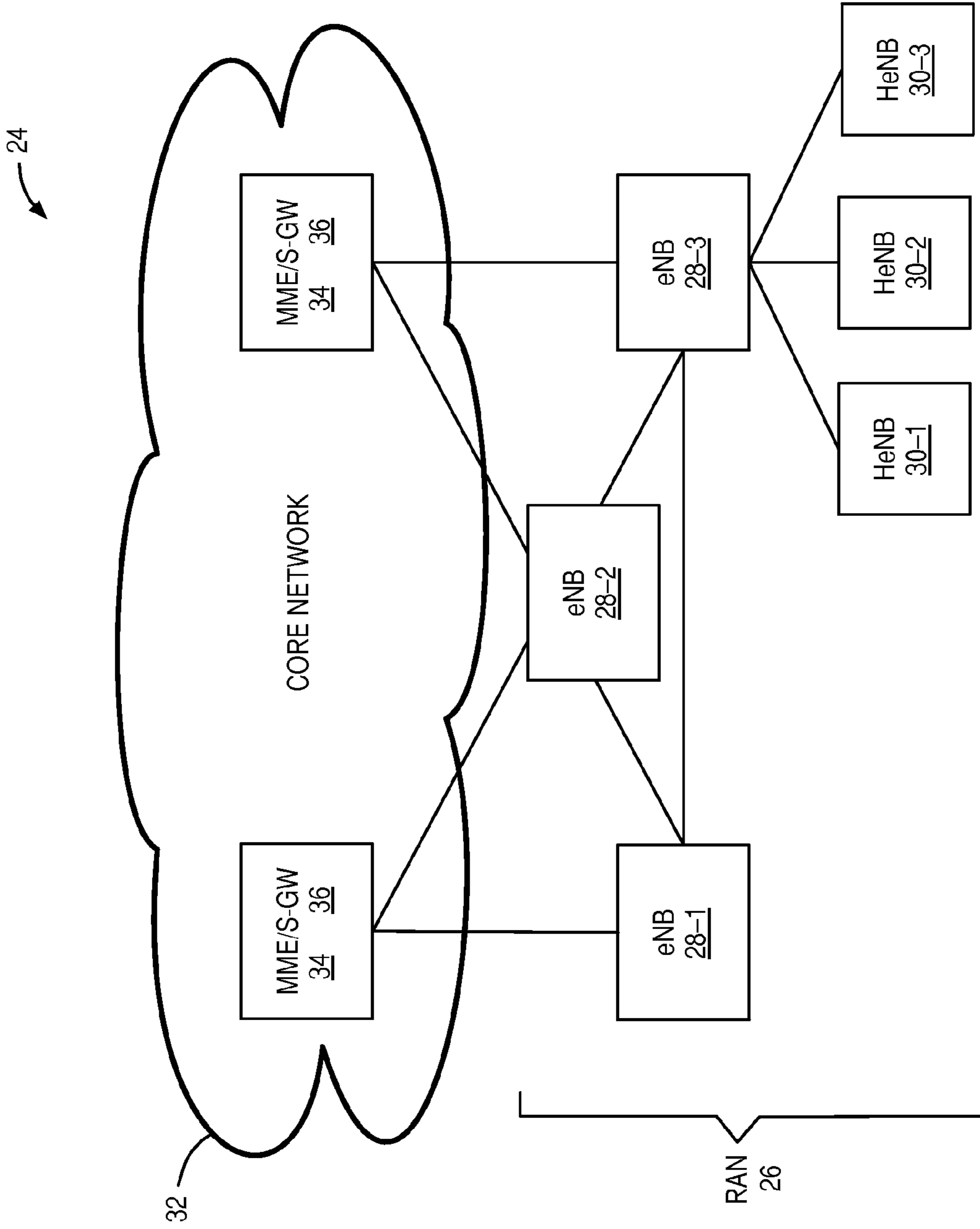

FIG. 12



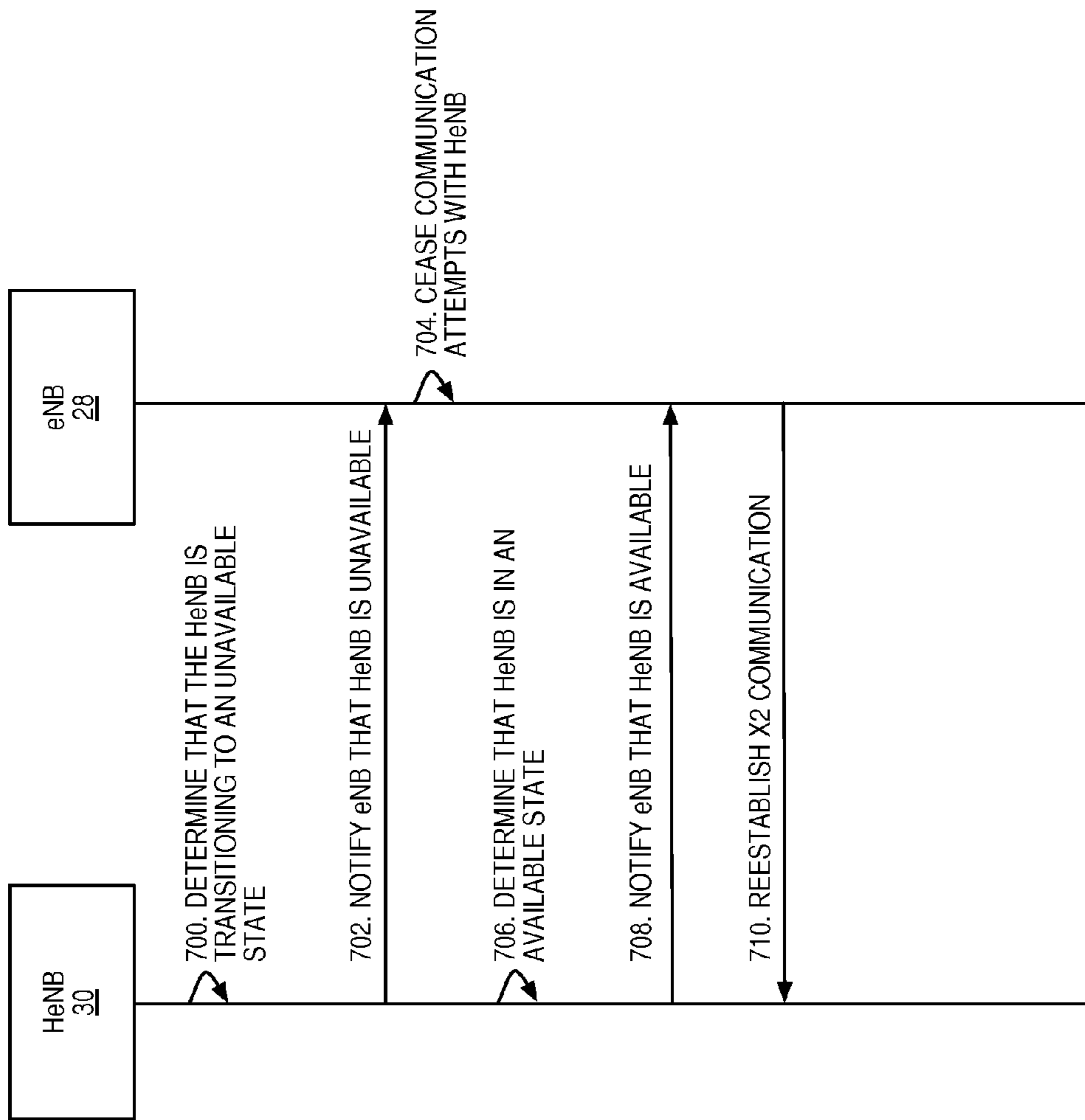

FIG. 13A

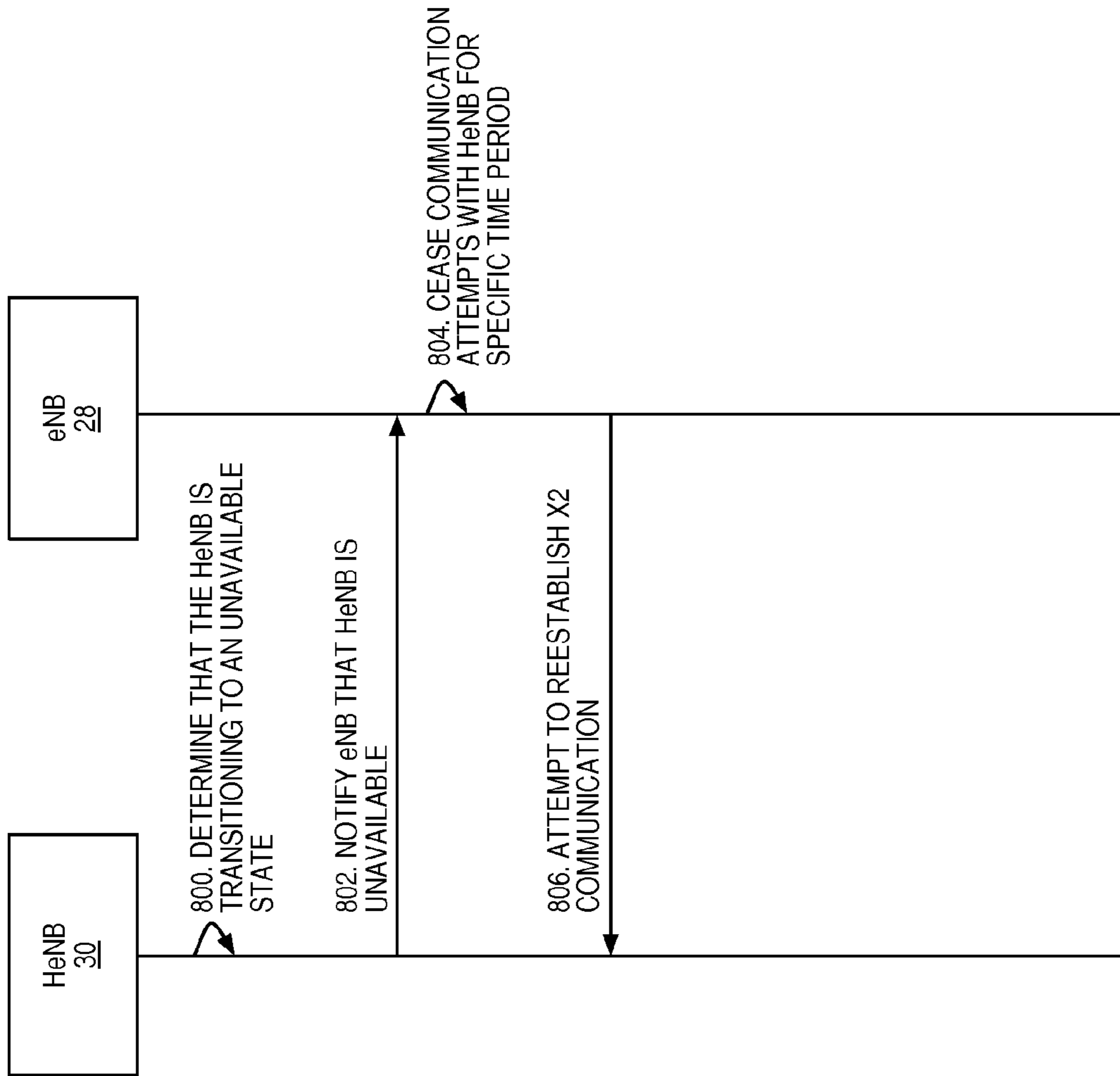

FIG. 13B

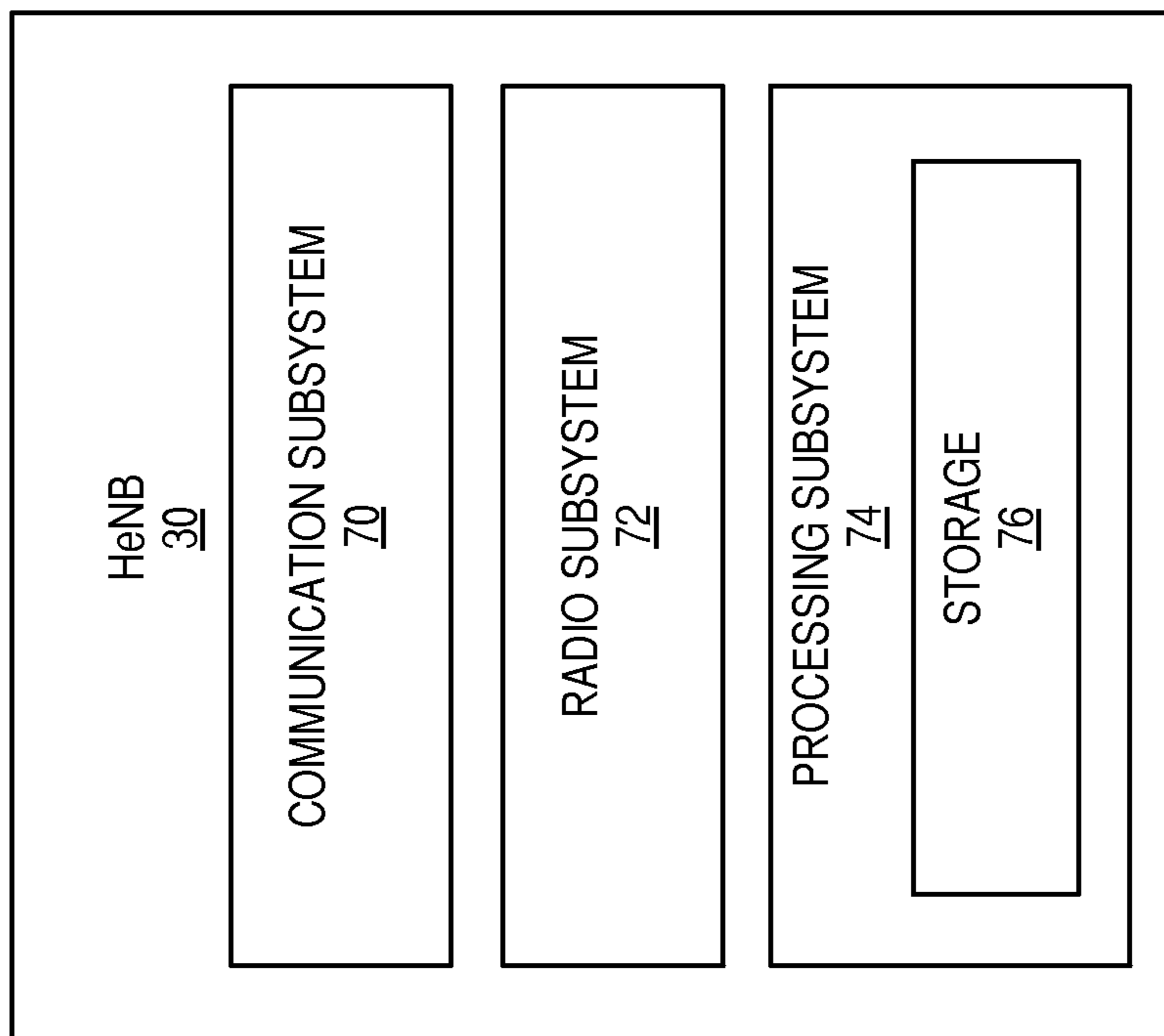

FIG. 15

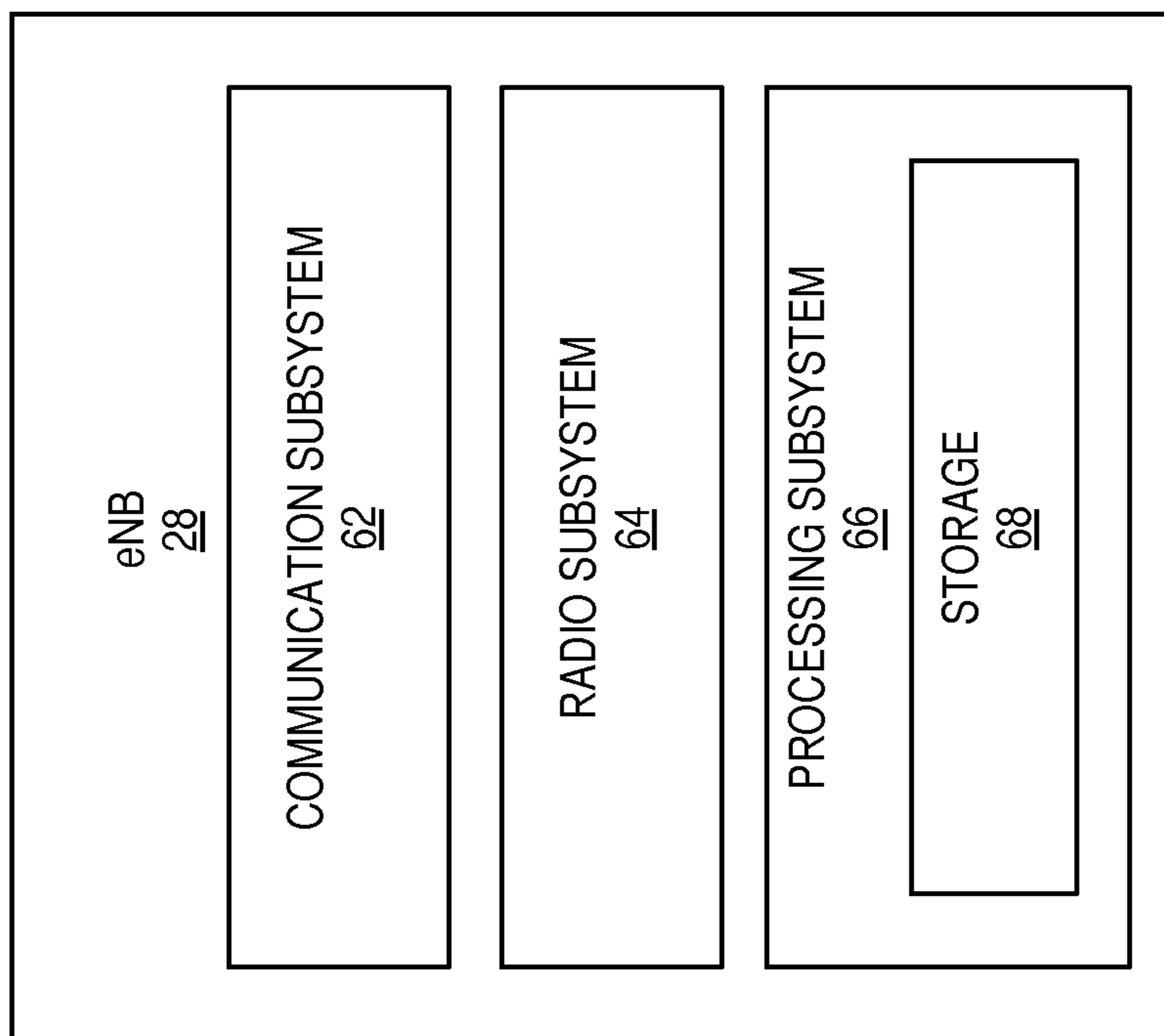

FIG. 14

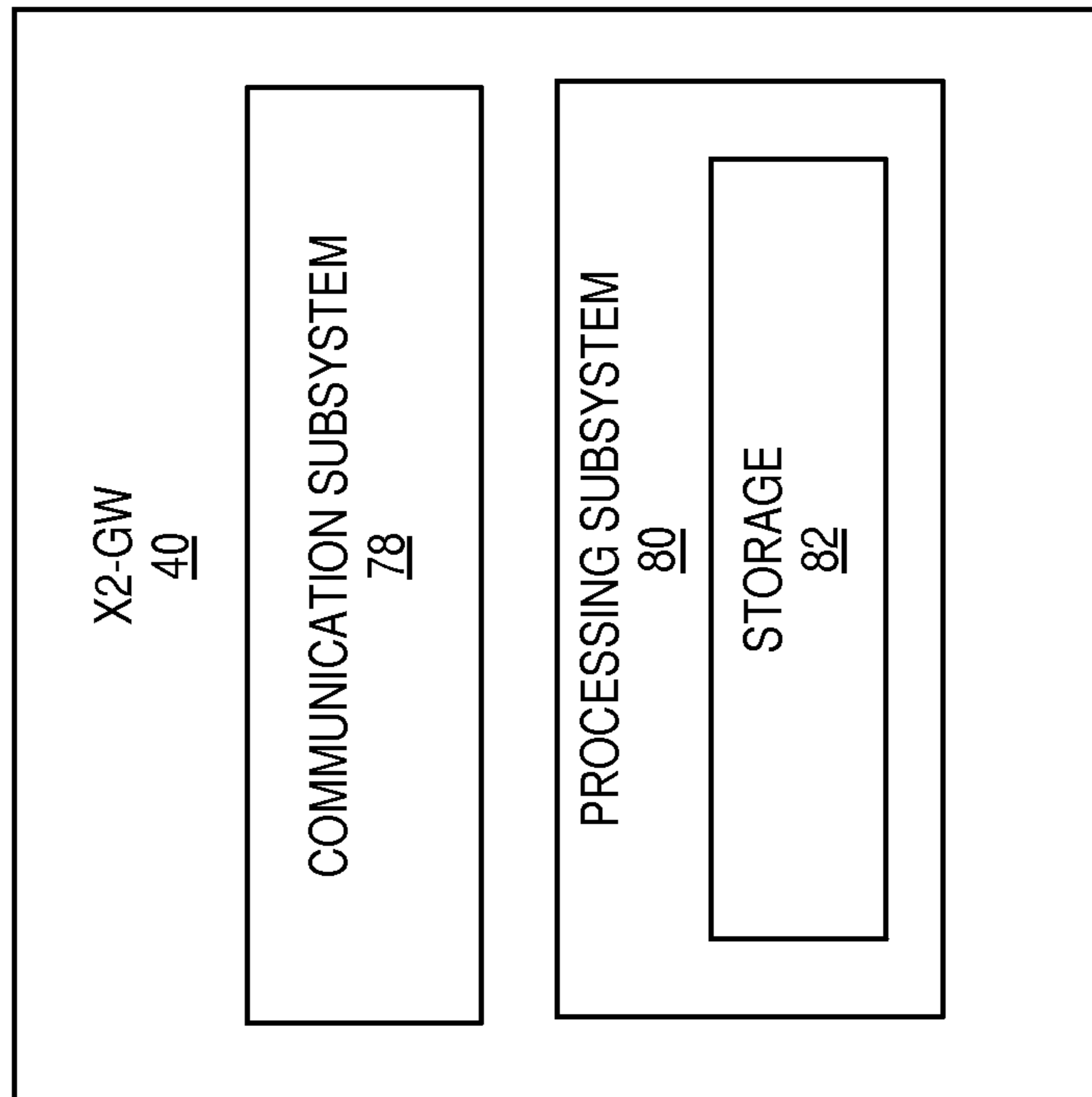

FIG. 16

**1**  
**METHODS FOR**  
**BASE-STATION-TO-BASE-STATION**  
**CONNECTION MANAGEMENT**

RELATED APPLICATIONS

This application claims the benefit of provisional patent application Ser. No. 61/721,745, filed Nov. 2, 2012, the disclosure of which is hereby incorporated herein by reference in its entirety.

This application is also related to U.S. patent application Ser. No. 14/068,744, entitled BASE-STATION-TO-BASE-STATION GATEWAY AND RELATED DEVICES, METHODS, AND SYSTEMS, which was filed Oct. 31, 2013, now U.S. Pat. No. 9,326,218, issued Apr. 26, 2016, which is commonly owned and assigned and is hereby incorporated herein by reference in its entirety.

FIELD OF THE DISCLOSURE

The present disclosure relates to a base-station-to-base-station gateway in a cellular communication network.

BACKGROUND

A conventional Long Term Evolution (LTE) cellular communication network **10**, as shown in FIG. **1**, includes a Radio Access Network (RAN) **12** including a number of Evolved/E-UTRAN Node Bs (eNBs) **14-1** through **14-3** (generally referred to herein collectively as eNBs **14** and individually as eNB **14**) that provide wireless radio access to wireless devices, otherwise known as user equipment devices (UEs) (not shown). The eNBs **14** communicate with one another via X2 connections and communicate with a core network **16** via S1 connections. The core network **16** includes one or more Mobility Management Entities (MMEs) **18**, which are control nodes that are responsible for, among other things, tracking UEs as they move through the LTE cellular communication network **10**. The MMEs **18** are also responsible for assigning the UEs to Serving-Gateways (S-GWs) **20**. The S-GWs **20** route and forward user data packets, while also acting as mobility anchors for the user plane during inter-eNB handovers and as anchors for mobility between LTE and other 3<sup>rd</sup> Generation Partnership Project (3GPP) technologies.

FIG. **2** illustrates a heterogeneous deployment of both eNBs **14** and Home Evolved/E-UTRAN Node Bs (HeNBs) **22-1** through **22-3** (generally referred to herein collectively as HeNBs **22** and individually as HeNB **22**) that has been proposed to improve coverage and increase capacity of the LTE cellular communication network **10**. The addition of low-power base stations (LP-BSs), such as the HeNBs **22**, to the LTE cellular communication network **10** poses new problems not present in a conventional homogeneous cellular communication network. Like the eNBs **14**, the HeNBs **22** use S1 connections to communicate with the core network **16** (not shown) and X2 connections to communicate with other HeNBs **22** and eNBs **14**. In particular, there is a need for systems and methods that improve management of X2 communication between base stations and, in particular, between the eNB **14** and the HeNBs **22**.

SUMMARY

The present disclosure relates to a base station in a cellular communication network and methods of operation thereof. In one embodiment, a first base station determines that the

**2**

first base station is transitioning to an unavailable state. The first base station then notifies one or more radio network nodes that the first base station is unavailable. In one embodiment, the one or more radio network nodes comprise one or more second base stations with which the base station conducts base-station-to-base-station (BS-BS) communication. In another embodiment, the one or more radio network nodes include a BS-BS gateway. Thereafter, in one embodiment, as a result of the notification, one or more second base stations with which the base station conducts BS-BS communication cease communication attempts with the first base station. In this manner, the one or more second base stations can avoid spending additional resources on attempts to re-establish the communication connections to base stations that tend to be offline more often (e.g., low-power base stations (LP-BSs)).

In one embodiment, the one or more radio network nodes comprise a BS-BS gateway. The first base station notifies the BS-BS gateway that the first base station is unavailable. In one embodiment, the BS-BS gateway then notifies one or more second base stations with which the first base station conducts BS-BS communication that the first base station is unavailable.

In one embodiment, the cellular communication network is a Long Term Evolution (LTE) cellular communication network. Further, in one embodiment, the notification that the first base station is unavailable is a Stream Control Transmission Protocol (SCTP) message with Chunk Type of "Error" or "Shutdown." Still further, in one embodiment, the first base station is a Home Enhanced Node B (HeNB), the BS-BS gateway is an X2-GW, and the one or more second base stations are one or more Enhanced Node Bs (eNBs) and/or HeNBs.

In one embodiment, a BS-BS gateway in a cellular communication network determines that a first base station is unavailable. The BS-BS gateway then notifies one or more second base stations with which the first base station conducts BS-BS communication that the first base station is unavailable. Further, in one embodiment, the cellular communication network is an LTE cellular communication network, the first base station is an HeNB, the BS-BS gateway is an X2-GW, and the one or more second base stations are one or more eNBs and/or HeNBs.

In one embodiment, a base station in a cellular communication network receives notification that a second base station is unavailable. The second base station is a second base station with which the base station conducts BS-BS communication. In response to receiving the notification that the second base station is unavailable, the base station ceases communication attempts with the second base station. In one embodiment, the base station waits for the second base station to re-establish a BS-BS communication connection. In another embodiment, the base station waits a specified amount of time before attempting to re-establish the BS-BS communication connection. Further, in one embodiment, the cellular communication network is an LTE cellular communication network, the base station is an HeNB, the BS-BS communication connection is an X2 communication connection, and the second base station is an eNB or an HeNB.

Those skilled in the art will appreciate the scope of the present disclosure and realize additional aspects thereof after reading the following detailed description of the preferred embodiments in association with the accompanying drawing figures.

BRIEF DESCRIPTION OF THE DRAWING  
 FIGURES

The accompanying drawing figures incorporated in and forming a part of this specification illustrate several aspects

of the disclosure, and together with the description serve to explain the principles of the disclosure.

FIG. 1 illustrates a conventional Long Term Evolution (LTE) cellular communication network;

FIG. 2 illustrates a conventional heterogeneous LTE cellular communication network;

FIG. 3 illustrates a heterogeneous LTE cellular communication network including an X2 gateway (X2-GW) for X2 connections between Evolved/E-UTRAN Node Bs (eNBs) and Home Evolved/E-UTRAN Node Bs (HeNBs) according to one embodiment of the present disclosure;

FIG. 4 illustrates a field format for chunks transmitted in a Stream Control Transmission Protocol (SCTP) packet;

FIG. 5 illustrates a chunk transmitted in an SCTP packet wherein the Chunk Type is set to ERROR and the Cause Code is set to User Initiated Abort;

FIG. 6 illustrates the operation of the heterogeneous LTE cellular communication network of FIG. 3 where the X2-GW obtains mappings of hostnames to network addresses of the HeNBs according to one embodiment of the present disclosure;

FIG. 7A illustrates the composition of an Evolved Universal Terrestrial Radio Access Network (E-UTRAN) Cell Global Identifier (ECGI), an E-UTRAN Cell Identifier (ECI), and a Public Land Mobile Network (PLMN) ID, which are utilized to create hostnames according to one embodiment of the present disclosure;

FIG. 7B illustrates the composition of an ECGI, an ECI (where the ECI is the eNB ID), and a PLMN ID, which are utilized to create hostnames according to one embodiment of the present disclosure;

FIG. 8 illustrates the operation of the X2-GW of FIG. 3 to enable addressing of X2 messages between the eNBs and the HeNBs using the hostnames of the HeNBs according to one embodiment of the present disclosure;

FIG. 9 illustrates a process by which an eNB of FIG. 3 receives configuration information about an HeNB via an Automated Neighbor Relation (ANR) and Transport Network Layer (TNL) address discovery process that enables the eNB to establish an X2 connection to the HeNB via the X2-GW according to one embodiment of the present disclosure;

FIGS. 10A and 10B illustrate the operation of the heterogeneous LTE cellular communication network of FIG. 3, where an HeNB indirectly notifies one or more eNBs that the HeNB is unavailable via the X2-GW according to one embodiment of the present disclosure;

FIG. 11 illustrates the operation of the heterogeneous LTE cellular communication network of FIG. 3, where the X2-GW directly notifies one or more eNBs that an HeNB is unavailable as determined by the X2-GW according to one embodiment of the present disclosure;

FIG. 12 illustrates a heterogeneous LTE cellular communication network in which one base station notifies other base stations of its unavailability according to another embodiment of the present disclosure;

FIGS. 13A and 13B illustrate the operation of the heterogeneous LTE cellular communication network of FIG. 12 where an HeNB directly notifies one or more eNBs that the HeNB is unavailable according to one embodiment of the present disclosure;

FIG. 14 is a block diagram of one of the eNBs of FIG. 3 according to one embodiment of the present disclosure;

FIG. 15 is a block diagram of one of the HeNBs of FIG. 3 according to one embodiment of the present disclosure; and

FIG. 16 is a block diagram of the X2-GW of FIG. 3 according to one embodiment of the present disclosure.

#### DETAILED DESCRIPTION

The embodiments set forth below represent the necessary information to enable those skilled in the art to practice the embodiments and illustrate the best mode of practicing the embodiments. Upon reading the following description in light of the accompanying drawing figures, those skilled in the art will understand the concepts of the disclosure and will recognize applications of these concepts not particularly addressed herein. It should be understood that these concepts and applications fall within the scope of the disclosure and the accompanying claims.

The present disclosure relates to managing base-station-to-base-station (BS-BS) communication connections in a cellular communication network. While the embodiments described below are for a Long Term Evolution (LTE) cellular communication network, the present disclosure is not limited thereto. The concepts disclosed herein are applicable to any suitable type of cellular communication network. As such, while LTE terminology is sometimes used herein, such terminology should not be construed as limiting the scope of this disclosure. Additionally, as used herein, the term LTE encompasses both LTE and LTE Advanced.

Before describing various embodiments of the present disclosure, a discussion of some particular issues related to X2 connection management in the heterogeneous deployment of a conventional LTE cellular communication network 10 illustrated in FIG. 2 is beneficial. As illustrated in FIG. 2, the heterogeneous deployment of the conventional LTE cellular communication network 10 includes Evolved/E-UTRAN Node Bs (eNBs) 14 as well as Home Evolved/E-UTRAN Node Bs (HeNBs) 22, which are used to extend the coverage area and increase the capacity of the conventional LTE cellular communication network 10. The addition of the HeNBs 22 to the conventional LTE cellular communication network 10 poses new problems not present in a conventional homogeneous cellular communication network.

One such problem results from additional X2 connections required for the HeNBs 22. As a result of the additional X2 connections, there is a significant increase in resources at the eNB 14 needed to manage the X2 connections. More specifically, for effective administration of a Radio Access Network (RAN) 12, it is desirable for each eNB 14 to have X2 connections with all of its neighbors, which in this case include both neighboring eNBs 14 and neighboring HeNBs 22. The increase in the number of X2 connections increases the amount of resources necessary for creating and maintaining these communication connections.

Another problem is that while most eNBs 14 are designed to be reliable and have high uptime, the HeNBs 22 may be powered down frequently. Power-down of the HeNBs 22 breaks the corresponding X2 connections to the neighboring eNBs 14 and the neighboring HeNBs 22. This can lead to additional resources being spent as the neighboring eNBs 14 and the neighboring HeNBs 22 attempt to reestablish the X2 connections, which can in turn impair the efficiency of the RAN 12. Furthermore, especially for the HeNBs 22, which may use a backhaul network that is not otherwise part of the LTE cellular communication network 10 (e.g., a home broadband connection), the network addresses, which are sometimes referred to as Transport Network Layer (TNL) addresses, may be different upon coming back online after power-down. This makes it more difficult for the neighbor-

ing eNBs **14** and the neighboring HeNBs **22** to reestablish the X2 connections after the HeNB **22** comes back online, which again impairs the efficiency of the RAN **12**.

Systems and methods that address the aforementioned issues in the conventional LTE cellular communication network **10** are disclosed herein. In this regard, FIG. **3** illustrates a heterogeneous LTE cellular communication network **24** according to one embodiment of the present disclosure. The heterogeneous LTE cellular communication network **24** includes a RAN **26**, which includes eNBs **28-1** through **28-3** (generally referred to herein collectively as eNBs **28** and individually as eNB **28**) that provide wireless radio access for one or more wireless devices, which for LTE are referred to as user equipment devices (UEs) (not shown). The RAN **26** also includes HeNBs **30-1** through **30-3** (generally referred to herein collectively as HeNBs **30** and individually as HeNB **30**) that also provide wireless radio access to one or more UEs. It is important to remember that the HeNBs **30** are used only as an example of the concepts disclosed herein, but the concepts disclosed herein are equally applicable to any type(s) of low-power base stations (LP-BSs) (e.g., LP-BSs for femtocells, picocells, microcells, or the like). These LP-BSs generally serve a smaller area than high-power base stations (HP-BSs) such as the eNBs **28**. For example, some LP-BSs, such as HeNBs **30**, are deployed in individual residences or small businesses. Notably, as used herein “low-power base station” and “high-power base station” may be used to distinguish between base stations based on their permanent capabilities, current configuration, and/or their operation at a specific instant. Thus, in particular embodiments that include both low-power base stations and high-power base stations, a low-power base station may represent a device with comparable or identical components and capabilities to those of the high-power base stations but that is merely configured differently from, or operating in a different manner from, the high-power base stations at a given point in time.

The eNBs **28** and the HeNBs **30** communicate with each other via X2 connections. Note that while many of the embodiments disclosed herein focus on BS-BS communication (e.g., X2 communication) between HP-BSs and LP-BSs, the concepts disclosed herein are also applicable to BS-BS communication between base stations of the same type (e.g., between two HP-BSs or between two LP-BSs). BS-BS communication over X2 connections is used to, for example, coordinate connection handovers and perform load management between the eNBs **28** and the HeNBs **30**. In LTE, these BS-BS communications (which for LTE are also referred to herein as X2 communications) are sent over an Internet Protocol (IP) network using Stream Control Transmission Protocol (SCTP) as the transport layer for control messages.

The eNBs **28** communicate with a core network **32** of the heterogeneous LTE cellular communication network **24** via corresponding connections. Likewise, while not illustrated, the HeNBs **30** also communicate with the core network **32** via corresponding connections. In LTE, control messages are also sent over an IP network using SCTP as the transport layer. The core network **32** includes one or more Mobility Management Entities (MMEs) **34** and one or more Serving Gateways (S-GWs) **36**. The MMEs **34** are control nodes for the heterogeneous LTE cellular communication network **24** that are responsible for, among other things, tracking UEs as the UEs move through the heterogeneous LTE cellular communication network **24**. The MMEs **34** are also responsible for assigning the UEs to the S-GWs **36**. The S-GWs **36** operate to, among other things,

route and forward user data packets, while also acting as mobility anchors for the user plane during inter-base-state handovers and as anchors for mobility between LTE and other 3<sup>rd</sup> Generation Partnership Project (3GPP) technologies.

The heterogeneous LTE cellular communication network **24** also includes an X2 Gateway (X2-GW) **40** for X2 connections between the eNBs **28** and the HeNBs **30**. In this particular example, the X2 connections between the eNB **28-2** and the HeNBs **30** are provided via the X2-GW **40**. Likewise, the X2 connections between the eNB **28-3** and the HeNBs **30** are provided via the X2-GW **40**. For security reasons, traffic over the X2 connections will preferably be encrypted using IP Security (IPsec) tunnels which authenticate and encrypt every IP packet. If the X2-GW **40** is considered to be located at a trusted site, it may have one IPsec tunnel between the eNB **28-2** and X2-GW **40**, for instance, and one IPsec tunnel between the X2-GW **40** and each HeNB **30-1** through **30-3**. This means that the X2-GW **40** can interact with the IP packets in order to decrypt and re-encrypt the packets as needed, according to one embodiment. The X2-GW **40** is beneficial for the eNBs **28-2** and **28-3** because each of the eNBs **28-2** and **28-3** maintains only one SCTP transport layer connection to the X2-GW **40** instead of separate SCTP transport layer connections for each X2 connection for each of the HeNBs **30**.

As discussed below in detail, in one embodiment, the X2-GW **40** creates mappings between hostnames and network addresses for the HeNBs **30**. However, it should be noted that the X2-GW **40** may additionally or alternatively be used to create mappings between hostnames and network addresses for the eNBs **28**. Using the mappings, the X2-GW **40** is enabled to route X2 messages addressed with the hostnames of the HeNBs **30** from the eNBs **28-2** and **28-3** to the appropriate HeNBs **30**. Among other things, this may allow for faster X2 connection reestablishment between eNBs **28** and HeNBs **30** when the network address of any of the eNBs **28** or HeNBs **30** changes for any reason, including if an eNB **28** or an HeNB **30** is assigned a different network address upon coming back online after power-down. This is only a benefit of one preferred embodiment and does not limit the present disclosure thereto.

In addition to routing messages addressed with hostnames, the X2-GW **40** enables the eNBs **28** and/or the HeNBs **30** to query the X2-GW **40** for the network address of a desired HeNB **30** based on the hostname of the desired HeNB **30**. Specifically, an eNB **28** or HeNB **30** can query the X2-GW **40** with a hostname. The X2-GW **40** then looks up the corresponding network address and returns the network address to the eNB **28** or the HeNB **30** that issued the query.

Notably, the X2-GW **40** is not limited to the functions described above. For instance, as discussed below in detail, in one embodiment, the X2-GW **40** can also notify the eNBs **28** and/or HeNBs **30** that an eNB **28** or HeNB **30** to which they are connected through X2 connections is unavailable. This reduces the resources being spent attempting to reestablish the X2 connections with the eNB **28** or HeNB **30** that is unavailable.

Before further discussing embodiments of the present disclosure, a brief review of the SCTP protocol used for the X2 connections is beneficial. SCTP is defined in Request for Comments (RFC) 4960. SCTP is designed for signaling transport over IP networks. SCTP is connection-oriented and provides signaling means between endpoints. An SCTP packet is made of two parts: (1) a common header containing source and destination information and (2) one or more chunks. A chunk includes either control information or user

data. While not essential for understanding the concepts disclosed and claimed herein, for more information regarding SCTP, the interested reader is directed to RFC 4960, "Stream Control Transmission Protocol," published in September 2007.

FIG. 4 illustrates the field format for an SCTP chunk 42 within an SCTP packet. The SCTP chunk 42 comprises a Chunk Type field 44, a Chunk Flags field 46, a Chunk Length field 48, and a Chunk Value field 50. The Chunk Type field 44 includes a chunk type of the SCTP chunk 42, where the chunk type identifies the type of information contained in the Chunk Value field 50 and takes a value of between 0 and 254. The value of 255 is reserved for future use as an extension field. RFC 4960 defines the chunk types illustrated in Table 1 below.

TABLE 1

ID Value	Chunk Type
0	Payload Data (DATA)
1	Initiation (INIT)
2	Initiation Acknowledgement (INIT ACK)
3	Selective Acknowledgement (SACK)
4	Heartbeat Request (HEARTBEAT)
5	Heartbeat Acknowledgement (HEARTBEAT ACK)
6	Abort (ABORT)
7	Shutdown (SHUTDOWN)
8	Shutdown Acknowledgement (SHUTDOWN ACK)
9	Operation Error (ERROR)
10	State Cookie (COOKIE ECHO)
11	Cookie Acknowledgement (COOKIE ACK)
12	Reserved for Explicit Congestion Notification Echo (ECNE)
13	Reserved for Congestion Window Reduced (CWR)
14	Shutdown Complete (SHUTDOWN COMPLETE)

An SCTP packet including a chunk of INIT chunk type is used to establish a connection between two endpoints. The INIT chunk contains some mandatory fields as well as some variable fields. The variable fields are given below in Table 2.

TABLE 2

Variable Parameter	Status	Type Value
IPv4 Address	Optional	5
IPv6 Address	Optional	6
Cookie Preservative	Optional	9
Reserved for ECN Capable	Optional	32768 (0x8000)
Host Name Address	Optional	11
Supported Address Types	Optional	12

In more detail, the IPv4 Address field is 32 bits (unsigned integer) and contains an IPv4 address of the sending endpoint. It is binary encoded. An IPv4 Address parameter indicates a network address the sending endpoint of the INIT chunk will support for the connection being initiated. The IPv6 Address field is 128 bits (unsigned integer) and contains an IPv6 (RFC2460) address of the sending endpoint. It is binary encoded. An IPv6 Address parameter indicates a network address the sending endpoint of the INIT chunk will support for the connection being initiated. The Host Name Address field can be used by the sending endpoint of INIT chunk to pass its hostname (in place of its IP addresses) to the recipient endpoint. The recipient endpoint is responsible for resolving the hostname.

The INIT ACK chunk type is used to acknowledge the initiation of an SCTP connection (i.e., an SCTP association). The ABORT chunk type is used to immediately close, or

terminate, the connection. The ABORT chunk may contain Cause Parameters to inform the recipient endpoint about the reason for the abort. A description of the causes is given below with respect to the ERROR chunk type. The SHUTDOWN chunk type is sent to initiate a graceful close of the connection with the recipient endpoint. In contrast to the ABORT chunk type, the SHUTDOWN chunk type allows any buffers to be emptied and other control messages to be processed while the connection is terminated.

The ERROR chunk type is used to notify the sending endpoint's peer (i.e., the recipient endpoint) of certain error conditions. An ERROR chunk contains one or more causes. An ERROR chunk is not considered fatal to the connection in and of itself, but may be used with an ABORT chunk to report a fatal condition. The Cause Code of an ERROR chunk defines the type of error condition being reported. Defined Cause Codes are given in Table 3 below.

TABLE 3

Cause Code Value	Cause Code
1	Invalid Stream Identifier
2	Missing Mandatory Parameter
3	Stale Cookie Error
4	Out of Resource
5	Unresolvable Address
6	Unrecognized Chunk Type
7	Invalid Mandatory Parameter
8	Unrecognized Parameters
9	No User Data
10	Cookie Received While Shutting Down
11	Restart of an Association with New Addresses
12	User Initiated Abort
13	Protocol Violation

FIG. 5 illustrates one instance of the SCTP chunk 42, where the SCTP chunk 42 is more specifically an ERROR chunk 52. As illustrated, the Chunk Value field 50 includes a Cause Code field 54, a Cause Length field 56, and an Upper Layer Abort Reason field 58. In this particular example, the Cause Code field 54 is set to "12," which is a User Initiated Abort. The User Initiated Abort Cause Code indicates that the ERROR chunk 52 was sent because of an upper-layer request. The upper layer can specify an Upper Layer Abort Reason that is transported transparently by SCTP in the Upper Layer Abort Reason field 58. The Upper Layer Abort Reason may be delivered to the upper layer at the recipient endpoint.

FIG. 6 illustrates the operation of the heterogeneous LTE cellular communication network 24 of FIG. 3 where the X2-GW 40 obtains mappings of hostnames to network addresses of the HeNBs 30 according to one embodiment of the present disclosure. The HeNBs 30-1 through 30-3 first determine their own hostnames and network addresses (steps 100-1 through 100-3). The network address of the HeNB 30 is, in one embodiment, an IP address of the HeNB 30, which can be obtained or otherwise determined by the HeNB 30 using any suitable technique. In one embodiment, the hostname of the HeNB 30 is a Fully Qualified Domain Name (FQDN) of the HeNB 30, which, in one embodiment, can be determined by the HeNB 30 using an Evolved Universal Terrestrial Radio Access Network (E-UTRAN) Cell Global Identifier (ECGI) of the HeNB 30. More specifically, FIGS. 7A and 7B illustrate components of an ECGI. The ECGI is a concatenation of a Public Land Mobile Network (PLMN) ID and an E-UTRAN Cell Identifier (ECI). Furthermore, the PLMN is a concatenation of a Mobile Country Code (MCC) that identifies the country



where the mobile network is located and a Mobile Network Code (MNC) that identifies the network operator. Additionally, the ECI, as shown in FIG. 7A, is a concatenation of an eNB ID (20 bits) which uniquely identifies a base station in a mobile network and a Cell ID (8 bits) which identifies a specific cell served by the base station. In the case of an HeNB 30 and some other LP-BSSs, the base station has only one cell, such that all the digits of the ECI (28 bits) are devoted to unique base station identification, as shown in FIG. 7B.

Returning to FIG. 6, according to one embodiment, the HeNB 30 determines the FQDN of the HeNB 30 based on the following string:

henbID<ENBID>.mnc<MNC>.mcc<MCC>.3gppnetwork.org where <ENBID>, <MNC>, and <MCC> are replaced with the values of the ENBID, MNC, and MCC of the HeNB 30. The FQDN is then used as the hostname of the HeNB 30. In other embodiments, combinations of values such as Tracking Area Code (TAC), Tracking Area Identity (TAI), and Closed Subscriber Group (CSG) ID are used to create a hostname. Note that this is just one embodiment. The FQDN may be determined using any suitable formula or means. Further, the hostname is not limited to an FQDN of the HeNB 30. Any type of suitable hostname may be used.

The HeNBs 30-1 through 30-3 then send SCTP INIT messages, including both the hostnames and the network addresses of the HeNBs 30-1 through 30-3, to the X2-GW 40 (steps 102-1 through 102-3). In one embodiment, in order to determine the network address of the X2-GW 40, the HeNBs 30 determine the FQDN of the X2-GW 40 based on the following string: x2gw.tac-lb<TAC-low-byte>.tac-hb<TAC-high-

byte>.mnc<MNC>.mcc<MCC>.3gppnetwork.org. The HeNBs 30 then query a Domain Name System (DNS) server using the FQDN to obtain the network address of the X2-GW 40. More specifically, using the HeNB 30-1 as an example, the HeNB 30-1 sends an SCTP message including an INIT chunk (this SCTP message is referred to herein as an SCTP INIT message) to the X2-GW 40, where the INIT chunk includes the hostname of the HeNB 30-1 in the corresponding parameter field of the INIT chunk. The network address of the HeNB 30-1 can also be included in the corresponding parameter field of the INIT chunk or, alternatively, may be determined by, for example, the sender address in the IP packet header. In this manner, the HeNBs 30 sends information to the X2-GW 40 including the hostnames and the network addresses of the HeNBs 30 via SCTP INIT messages according to one embodiment of the present disclosure. Note that the SCTP INIT messages are just one preferred embodiment. The HeNBs 30 may send the information including the hostnames and network addresses to the X2-GW 40 using any suitable message or message type.

Upon receiving the SCTP INIT messages from the HeNBs 30-1 through 30-3, the X2-GW 40 stores corresponding mappings between the hostnames and the network addresses of the HeNBs 30 (steps 104-1 through 104-3). In this way, the X2-GW 40 creates mappings between hostnames and network addresses for the HeNBs 30. According to one embodiment of the present disclosure, new mappings are established as new HeNBs 30 are brought online or initiate X2 connections with the X2-GW 40. Further, in one embodiment, the mappings may also be updated as the HeNBs 30 change their network addresses and/or hostnames.

FIG. 8 illustrates the operation of the X2-GW 40 of FIG. 3 where the X2-GW 40 enables addressing of X2 messages between the eNBs 28 and the HeNBs 30 using the hostnames of the HeNBs 30, according to one embodiment of the

present disclosure. An eNB 28 first obtains a network address for an HeNB 30 and a network address for the X2-GW 40 associated with the HeNB 30 (step 200). According to one embodiment of the present disclosure, step 200 is the Automatic Neighbor Relation (ANR) and TNL address discovery process of FIG. 9 (described below), but the present disclosure is not limited thereto. Next, the eNB 28 initiates an X2 connection by sending an SCTP INIT message to the X2-GW 40 (step 202). Notably, at the time of initiating the X2 connection, in this embodiment, the eNB 28 does not know that the X2-GW 40 is in fact an X2-GW. Rather, the eNB 28 may only be aware that the network address obtained for the X2-GW 40 is a network address of a gateway such as a Security Gateway (SeGW). In some embodiments, the functionality of the X2-GW 40 and the SeGW can be combined into a single gateway. In other embodiments, the X2-GW 40 and the SeGW can be implemented separately. This transparency enables the procedures of the eNB 28 to be unaffected by the presence of the X2-GW 40. If the eNB 28 does not know how to take advantage of the features of the X2-GW 40, the legacy procedures will still be operational. This is only a benefit of one preferred embodiment, and does not limit the present disclosure thereto.

The X2-GW 40 then sends an SCTP message back to the eNB 28 informing the eNB 28 that the X2-GW 40 is an X2-GW 40 (step 204). In one embodiment, this SCTP message is an SCTP ERROR message (i.e., an SCTP message including an ERROR chunk) that includes the User Initiated Abort Cause Code along with an Upper Layer Abort Reason that indicates that the X2-GW 40 is an X2-GW. By informing the eNB 28 that the X2-GW 40 is an X2-GW, the eNB 28 is enabled to take advantage of the functionality of the X2-GW 40 (e.g., send X2 messages through the X2-GW 40 addressed via appropriate hostnames).

In this embodiment, the eNB 28 then sends a message addressed to the HeNB 30 using the hostname of the HeNB 30 (step 206). The X2-GW 40 obtains the network address of the HeNB 30 from the mapping between the hostname and the network address of the HeNB 30 (step 208). In this manner, the X2-GW 40 translates, or resolves, the hostname of the HeNB 30 to the network address of the HeNB 30. The X2-GW 40 then forwards the message to the HeNB 30 using the network address of the HeNB 30 (step 210). Enabling the eNB 28 to address messages to the HeNB 30 using the hostname of the HeNB 30 in this manner provides many advantages. While not being limited to or by any particular advantage, as one example, changes in the network address of the HeNB 30 will not affect the ability of the eNB 28 to address messages to the HeNB 30. This is useful, for example, because HeNBs 30 are more likely to use a backhaul network that is not otherwise part of the LTE cellular communication network 10 (e.g., a home broadband connection) and the network address of the HeNB 30 may change. Enabling the eNB 28 to address messages to the HeNB 30 using the hostname of the HeNB 30 reduces the time and resources required to reestablish a connection between the eNB 28 and the HeNB 30, since the eNB 28 will not be required to query via the MME 34 or some other core network 32 element to determine the new network address of the HeNB 30.

FIG. 9 illustrates a process by which an eNB 28 of FIG. 3 receives configuration information about an HeNB 30 via an ANR and TNL address discovery process, where the configuration information enables the eNB 28 to establish an X2 connection to the HeNB 30 via the X2-GW 40 according

to one embodiment of the present disclosure. A UE 60 first detects a Physical Cell ID (PCI) of the HeNB 30 (step 300). The UE 60 then determines if signal measurements for the HeNB 30 meet one or more predefined reporting criteria (step 302). The reporting criteria can include signal strength according to one embodiment of the present disclosure. If the reporting criteria have been met, the UE 60 sends a measurement report to the eNB 28 with which the UE 60 is already associated (step 304).

The eNB 28 analyzes the measurement report to determine if the measurement report is associated with a source that is unknown to the eNB 28 and is a candidate to become a neighbor. This process is one of many adopted by 3GPP and implemented in the standards of LTE that work toward a planned Self Organizing Network (SON). If the eNB 28 determines that additional information about the HeNB 30 is needed (step 306), the eNB 28 requests additional information about the HeNB 30 from the UE 60 (step 308). The additional information requested by the eNB 28 may include one or more desired or relevant parts of system information broadcast by the HeNB 30. As an example, the eNB 28 may request the ECGI of the HeNB 30. The UE then obtains the additional information from the HeNB 30 (step 310) and reports the additional information to the eNB 28 (step 312).

The eNB 28 then uses this information, such as the ECGI of the HeNB 30, to query via an MME 34, or other element of the core network 32, requesting configuration information for the HeNB 30 (step 314). The MME 34 then queries the HeNB 30 requesting configuration information for the HeNB 30 (step 316). The HeNB 30 then sends the configuration information for the HeNB 30 to the MME 34 that includes the network address for the HeNB 30 and the network address for the X2-GW 40 associated with the HeNB 30 (step 318). The MME 34 sends the configuration information for the HeNB 30 to the eNB 28 that includes the network address for the HeNB 30 and the network address for the X2-GW 40 associated with the HeNB 30 (step 320). In one embodiment, the X2-GW 40 is not identified as such in the configuration information. Also, in one embodiment, the network addresses are IP addresses; however, the present disclosure is not limited thereto.

While the eNBs 28 are designed to be reliable and have high uptime, there may still be times when the eNBs 28 are not available. This could be due to unforeseen circumstances or scheduled maintenance, for example. Due to the possible modularity and more personal aspect of HeNBs, in some embodiments, the HeNBs 30 may be powered down more frequently than the eNBs 28, or may otherwise become unavailable. This unavailability of an eNB 28 or an HeNB 30 can have a negative impact on the efficiency of the RAN 26, among other things. According to one embodiment, when the eNB 28 or the HeNB 30 determines that the eNB 28 or the HeNB 30 is transitioning to an unavailable state, the eNB 28 or the HeNB 30 notifies one or more radio network nodes of the unavailability of the eNB 28 or the HeNB 30. As used herein, radio network nodes may refer to base stations (such as eNBs 28 and HeNBs 30), BS-BS gateways (such as an X2-GW 40), or any other node in the radio access network. This notification will, among other things, reduce the attempts to reestablish an X2 connection between the eNBs 28 or the HeNBs 30 (or the X2-GW 40) and the now unavailable eNB 28 or HeNB 30. This is only a benefit of one preferred embodiment, and does not limit the present disclosure thereto.

In this regard, FIGS. 10A and 10B illustrate the operation of the heterogeneous LTE cellular communication network 24 of FIG. 3 where an HeNB 30 indirectly notifies one or

more eNBs 28 that the HeNB 30 is unavailable via the X2-GW 40, according to one embodiment of the present disclosure. FIG. 10A illustrates a scenario where the eNB 28 ceases communication attempts with the HeNB 30 until the eNB 28 is notified that the HeNB 30 is available. Conversely, FIG. 10B illustrates a scenario where the eNB 28 ceases communication attempts with the HeNB 30 for a specific period of time. In another embodiment, the eNB 28 ceases communication attempts with the HeNB 30 until the eNB 28 receives information from a UE indicating that the HeNB 30 is available. This might occur, for instance, as part of an ANR process as described with regard to FIG. 9.

In FIG. 10A, first the HeNB 30 determines that it is transitioning to an unavailable state (step 400). This determination can be in response to the HeNB 30 being powered down or otherwise transitioning to unavailability. Next, the HeNB 30 notifies the X2-GW 40 that the HeNB 30 is unavailable (step 402). In one embodiment, this notification is accomplished by sending an SCTP message over an X2 connection. More specifically, the message could be an SCTP message with a SHUTDOWN chunk or an ERROR chunk with a predefined reason in the Upper Layer Abort Reason field 58 that indicates that the HeNB 30 is unavailable. This message could, for example, encode that the HeNB 30 is powering down, or even that the HeNB 30 is an HeNB and that it is powering down. Note that the SCTP message is just one preferred embodiment and that the notification can be accomplished using any suitable means. This notification is similar to the deactivation message that the eNBs 28 are enabled to send when disabling cells for energy savings. Currently, it is possible to include a Deactivation Indication IE with a value "deactivated" in an "eNB Configuration Update" message sent from an eNB 28 or an HeNB 30 to another eNB 28 or HeNB 30. One possibility is to extend this with a dedicated value for "power down," "HeNB power down," or some similar dedicated value.

Upon being notified that the HeNB 30 is unavailable, the X2-GW 40 then notifies one or more eNBs 28-1 through 28-3 with which the HeNB 30 has an X2 connection that the HeNB 30 is unavailable (steps 404-1 through 404-3). In order to accomplish this, in one embodiment, the X2-GW 40 uses a table indicating, for each associated eNB 28 and HeNB 30, a list of other eNBs 28 and HeNBs 30 to which the eNB 28/HeNB 30 has X2 connections to each other eNB 28 and HeNB 30. This table can be produced by any suitable means. As one example, the X2-GW 40 could compile such a table during the process described in step 202 of FIG. 8 where an eNB 28 initiates a connection to an HeNB 30 using the X2-GW 40 as a gateway.

The eNBs 28-1 through 28-3 then cease communication attempts with the HeNB 30 until the eNBs 28-1 through 28-3 are notified that the HeNB 30 is again available (steps 406-1 through 406-3). In this embodiment, sometime thereafter, the HeNB 30 determines that the HeNB 30 is in an available state (step 408) and, in response, notifies the X2-GW 40 that the HeNB 30 is available (step 410). The X2-GW 40 then notifies the one or more eNBs 28-1 through 28-3 that the HeNB 30 is available (steps 412-1 through 412-3). After the one or more eNBs 28-1 through 28-3 are notified that the HeNB 30 is available, the one or more eNBs 28-1 through 28-3 reestablish the X2 communication connections with the HeNB 30 (steps 414-1 through 414-3). While they are not shown, there can be several other messages between the eNBs 28, the HeNB 30, and the X2-GW 40 in order to reestablish X2 communication.

In FIG. 10B, first the HeNB 30 determines that it is transitioning to an unavailable state (step 500). This deter-

mination can be in response to the HeNB 30 being powered down or otherwise transitioning to unavailability. Next, the HeNB 30 notifies the X2-GW 40 that the HeNB 30 is unavailable (step 502). In one embodiment, this notification is accomplished by sending an SCTP message over an X2 connection. More specifically, the message could be an SCTP message with a SHUTDOWN chunk or an ERROR chunk with a predefined reason in the Upper Layer Abort Reason field 58 that indicates that the HeNB 30 is unavailable. Note that the SCTP message is just one preferred embodiment and that the notification can be accomplished using any suitable means. The X2-GW 40 then notifies one or more eNBs 28-1 through 28-3 with which the HeNB 30 has an X2 connection that the HeNB 30 is unavailable (steps 504-1 through 504-3). The eNBs 28-1 through 28-3 then cease communication attempts with the HeNB 30 for a predetermined time period (steps 506-1 through 506-3). In one embodiment, after the predetermined time period has expired, the one or more eNBs 28-1 through 28-3 attempt to reestablish the X2 communication connections with the HeNB 30 (steps 508-1 through 508-3).

In some embodiments, it is not necessary for an HeNB 30 to notify other elements in the heterogeneous LTE cellular communication network 24 about the unavailability of the HeNB 30. In this regard, FIG. 11 illustrates the operation of the heterogeneous LTE cellular communication network 24 of FIG. 3 according to one embodiment of the present disclosure where the X2-GW 40 directly notifies one or more eNBs 28 that an HeNB 30 is unavailable as determined by the X2-GW 40. First, the X2-GW 40 determines that an HeNB 30 is unresponsive (step 600). This determination can be in response to, for example, repeated failed attempts to contact the HeNB 30 by the X2-GW 40. The X2-GW 40 then notifies one or more eNBs 28-1 through 28-3 with which the HeNB 30 has an X2 connection that the HeNB 30 is unavailable (steps 602-1 through 602-3). In order to accomplish this, in one embodiment, the X2-GW 40 uses a table indicating, for each associated eNB 28 and HeNB 30, a list of other eNBs 28 and HeNBs 30 to which the eNB 28/HeNB 30 has X2 connections to each other eNB 28 and HeNB 30. This table can be produced by any suitable means. As one example, the X2-GW 40 could compile such a table during the process described in step 202 of FIG. 8 where an eNB 28 initiates a connection to an HeNB 30 using the X2-GW 40 as a gateway. The one or more eNBs 28-1 through 28-3 then cease communication attempts with the HeNB 30 (steps 604-1 through 604-3).

In this embodiment, the X2-GW 40 subsequently determines that the HeNB 30 is again in an available state (step 606). The X2-GW 40 then notifies the one or more eNBs 28-1 through 28-3 that the HeNB 30 is available (steps 608-1 through 608-3). After the one or more eNBs 28-1 through 28-3 are notified that the HeNB 30 is available, the one or more eNBs 28-1 through 28-3 reestablish the X2 communication connections with the HeNB 30 (steps 610-1 through 610-3). As discussed above, while they are not shown, there can be several other messages between the eNBs 28, the HeNB 30, and the X2-GW 40 in order to reestablish X2 communication.

FIGS. 10A, 10B, and 11 illustrate embodiments in which an eNB 28 is notified of the unavailability of an HeNB 30 via the X2-GW 40. However, the present disclosure is not limited thereto. More generally, the concepts disclosed herein can be used by any base station to directly notify another base station of its unavailability. In this regard, FIG. 12 illustrates one embodiment of the heterogeneous LTE cellular communication network 24 in which the HeNBs 30

directly notify other HeNBs 30 and/or eNB(s) 28 with which they have X2 connections when the HeNBs 30 become unavailable. The same process can be used by the eNB(s) 28 to notify other eNBs 28 and/or HeNB(s) 30 with which they have X2 connections when the eNB(s) 28 become unavailable.

FIGS. 13A and 13B illustrate the operation of the heterogeneous LTE cellular communication network 24 of FIG. 12 where an HeNB 30 directly notifies one or more eNBs 28 that the HeNB 30 is unavailable according to one embodiment of the present disclosure. FIG. 13A illustrates the scenario where the eNB 28 ceases communication attempts with the HeNB 30 until the eNB 28 is notified that the HeNB 30 is available. Conversely, FIG. 13B illustrates the scenario where the eNB 28 ceases communication attempts with the HeNB 30 for a specific period of time.

In FIG. 13A, first the HeNB 30 determines that it is transitioning to an unavailable state (step 700). This determination can be in response to the HeNB 30 being powered down or otherwise transitioning to unavailability. Next, in response to determining that the HeNB 30 is transitioning to the unavailable state, the HeNB 30 notifies the eNB 28 that the HeNB 30 is unavailable (step 702). In one embodiment, this notification is accomplished by sending an SCTP message over an X2 connection. More specifically, the message could be an SCTP message with a SHUTDOWN chunk or an ERROR chunk with a predefined reason in the Upper Layer Abort Reason field 58 that indicates that the HeNB 30 is unavailable. Note that the SCTP message is just one preferred embodiment and that the notification can be accomplished using any suitable means. The eNB 28 then ceases communication attempts with the HeNB 30 until the eNB 28 is notified that the HeNB 30 is available again (step 704). In this embodiment, sometime thereafter, the HeNB 30 determines that the HeNB 30 is in an available state (step 706) and, in response, notifies the eNB 28 that the HeNB 30 is available (step 708). Lastly, after the eNB 28 is notified that the HeNB 30 is available, the eNB 28 reestablishes the X2 communication connection with the HeNB 30 (step 710).

In FIG. 13B, first the HeNB 30 determines that it is transitioning to an unavailable state (step 800). This determination can be in response to the HeNB being powered down or otherwise transitioning to unavailability. Next, the HeNB 30 notifies the eNB 28 that the HeNB 30 is unavailable (step 802). In one embodiment, this notification is accomplished by sending an SCTP message over an X2 connection. As described above with regard to FIG. 13A, the message could be an SCTP message with a SHUTDOWN chunk or an ERROR chunk with a predefined reason in the Upper Layer Abort Reason field 58 that indicates that the HeNB 30 is unavailable. Note that the SCTP message is just one preferred embodiment and that the notification can be accomplished using any suitable means. The eNB 28 then ceases communication attempts with the HeNB 30 for a predetermined time period (step 804). In one embodiment, after the predetermined time period has expired, the eNB 28 attempts to reestablish the X2 communication connection with the HeNB 30 (step 806).

FIG. 14 is a block diagram of one of the eNBs 28 of FIG. 3 according to one embodiment of the present disclosure. As illustrated, the eNB 28 includes a communication subsystem 62, a radio subsystem 64 that includes one or more radio units (not shown), and a processing subsystem 66 that includes storage 68. The communication subsystem 62 generally includes analog and, in some embodiments, digital components for sending and receiving communications to

## 15

and from the X2-GW 40 and in some embodiments, the HeNBs 30 and/or other eNBs 28. The radio subsystem 64 generally includes analog and, in some embodiments, digital components for wirelessly sending and receiving messages to and from the UE 60 in the heterogeneous LTE cellular communication network 24.

The processing subsystem 66 is implemented in hardware or in a combination of hardware and software. In particular embodiments, the processing subsystem 66 may comprise, for example, one or several general-purpose or special-purpose microprocessors or other microcontrollers programmed with suitable software and/or firmware to carry out some or all of the functionality of the eNB 28 described herein. In addition or alternatively, the processing subsystem 66 may comprise various digital hardware blocks (e.g., one or more Application Specific Integrated Circuits (ASICs), one or more off-the-shelf digital and analog hardware components, or a combination thereof) configured to carry out some or all of the functionality of the eNB 28 described herein. Additionally, in particular embodiments, the above-described functionality of the eNB 28 may be implemented, in whole or in part, by the processing subsystem 66 executing software or other instructions stored on a non-transitory computer-readable medium, such as Random Access Memory (RAM), Read Only Memory (ROM), a magnetic storage device, an optical storage device, or any other suitable type of data storage component.

FIG. 15 is a block diagram of one of the HeNBs 30 of FIG. 3 according to one embodiment of the present disclosure. As illustrated, the HeNB 30 includes a communication subsystem 70, a radio subsystem 72 that includes one or more radio units (not shown), and a processing subsystem 74 that includes storage 76. The communication subsystem 70 generally includes analog and, in some embodiments, digital components for sending and receiving communications to and from the X2-GW 40, and in some embodiments, the eNBs 28 and other HeNBs 30. The radio subsystem 72 generally includes analog and, in some embodiments, digital components for wirelessly sending and receiving messages to and from the UE 60 in the heterogeneous LTE cellular communication network 24.

The processing subsystem 74 is implemented in hardware or in a combination of hardware and software. In particular embodiments, the processing subsystem 74 may comprise, for example, one or several general-purpose or special-purpose microprocessors or other microcontrollers programmed with suitable software and/or firmware to carry out some or all of the functionality of the HeNB 30 described herein. In addition or alternatively, the processing subsystem 74 may comprise various digital hardware blocks (e.g., one or more ASICs, one or more off-the-shelf digital and analog hardware components, or a combination thereof) configured to carry out some or all of the functionality of the HeNB 30 described herein. Additionally, in particular embodiments, the above-described functionality of the HeNB 30 may be implemented, in whole or in part, by the processing subsystem 74 executing software or other instructions stored on a non-transitory computer-readable medium, such as RAM, ROM, a magnetic storage device, an optical storage device, or any other suitable type of data storage component.

FIG. 16 is a block diagram of the X2-GW 40 of FIG. 3 according to one embodiment of the present disclosure. As illustrated, the X2-GW 40 includes a communication subsystem 78 and a processing subsystem 80 that includes storage 82. The communication subsystem 78 generally includes analog and, in some embodiments, digital components for sending and receiving communications to and from

## 16

the HeNBs 30 and eNBs 28. The storage 82 can be on a non-transitory computer-readable medium, such as RAM, ROM, a magnetic storage device, an optical storage device, or any other suitable type of data storage component.

The processing subsystem 80 is implemented in hardware or in a combination of hardware and software. In particular embodiments, the processing subsystem 80 may comprise, for example, one or several general-purpose or special-purpose microprocessors or other microcontrollers programmed with suitable software and/or firmware to carry out some or all of the functionality of the X2-GW 40 described herein. In addition or alternatively, the processing subsystem 80 may comprise various digital hardware blocks (e.g., one or more ASICs, one or more off-the-shelf digital and analog hardware components, or a combination thereof) configured to carry out some or all of the functionality of the X2-GW 40 described herein. Additionally, in particular embodiments, the above-described functionality of the X2-GW 40 may be implemented, in whole or in part, by the processing subsystem 80 executing software or other instructions stored on a non-transitory computer-readable medium, such as RAM, ROM, a magnetic storage device, an optical storage device, or any other suitable type of data storage component.

The following acronyms are used throughout this disclosure.

3GPP 3<sup>rd</sup> Generation Partnership Project  
 ANR Automatic Neighbor Relation  
 ASIC Application Specific Integrated Circuit  
 BS Base Station  
 BS-BS GW Base Station to Base Station Gateway  
 CSG Closed Subscriber Group  
 DNS Domain Name System  
 E-UTRAN Evolved Universal Terrestrial Radio Access Network  
 ECGI E-UTRAN Cell Global Identifier  
 ECI E-UTRAN Cell Identifier  
 eNB Evolved/E-UTRAN Node B  
 FQDN Fully Qualified Domain Name  
 HeNB Home Evolved/E-UTRAN Node B  
 HP-BS High-Power Base Station  
 IMSI International Mobile Subscriber Identity  
 IP Internet Protocol  
 IPsec IP Security  
 LP-BS Low-Power Base Station  
 LTE Long Term Evolution  
 MCC Mobile Country Code  
 MME Mobility Management Entity  
 MNC Mobile Network Code  
 PCI Physical Cell ID  
 PLMN Public Land Mobile Network  
 RAM Random Access Memory  
 RAN Radio Access Network  
 ROM Read Only Memory  
 SCTP Stream Control Transmission Protocol  
 S-GW Serving Gateway  
 SeGW Security Gateway  
 SON Self Organizing Network  
 TAC Tracking Area Code  
 TAI Tracking Area Identity  
 TNL Transport Network Layer  
 UE User Equipment Device  
 X2-GW X2 Gateway

Those skilled in the art will recognize improvements and modifications to the preferred embodiments of the present disclosure. All such improvements and modifications are considered within the scope of the concepts disclosed herein and the claims that follow.

What is claimed is:

1. A method of operation of a base station in a cellular communication network, the method comprising:

determining that the base station is transitioning to an unavailable state; and

notifying one or more radio network nodes that the base station is unavailable by sending a Stream Control Transmission Protocol message containing information indicating that the base station is unavailable;

wherein the Stream Control Transmission Protocol message is a Stream Control Transmission Protocol message with a Chunk Type set to "Error," a Cause Type set to "User-Initiated Abort," and an Upper Layer Abort Reason that indicates that the base station is unavailable.

2. The method of claim 1 wherein the cellular communication network is a Long Term Evolution cellular communication network and the one or more radio network nodes comprises one or more base stations with an established X2 connection to the base station.

3. The method of claim 2 wherein the base station is selected from the group consisting of a microcell eNB, a picocell eNB, a femtocell eNB, and a Home eNB.

4. The method of claim 1 wherein the base station is a low-power base station.

5. The method of claim 1 wherein:

notifying the one or more radio network nodes comprises notifying one or more second base stations with which the base station conducts base-station-to-base station communication that the base station is unavailable.

6. The method of claim 5 wherein the cellular communication network is a Long Term Evolution cellular communication network and notifying the one or more second base stations comprises sending an X2 message containing the information indicating that the base station is unavailable to the one or more second base stations.

7. The method of claim 5 wherein the base station is a low-power base station.

8. The method of claim 7 wherein the low-power base station is selected from the group consisting of a microcell eNB, a picocell eNB, a femtocell eNB, and a Home eNB.

9. The method of claim 1 wherein:

notifying the one or more radio network nodes comprises notifying a base-station-to-base-station gateway that the base station is unavailable.

10. The method of claim 9 wherein the cellular communication network is an LTE cellular communication network and the base-station-to-base-station gateway is an X2-GW.

11. The method of claim 10 wherein notifying the base-station-to-base-station gateway comprises sending an X2 message to the X2-GW containing the information indicating that the base station is unavailable.

12. The method of claim 10 wherein the base station is a low-power base station.

13. The method of claim 12 wherein the low-power base station is selected from the group consisting of a microcell eNB, a picocell eNB, a femtocell eNB, and a Home eNB.

14. A method of operation of a base-station-to-base-station gateway in a cellular communication network, the method comprising:

determining that a first base station is unavailable; and notifying one or more second base stations with which the base station conducts base-station-to-base-station communication that the base station is unavailable by sending a Stream Control Transmission Protocol message containing information indicating that the base station is unavailable;

wherein the Stream Control Transmission Protocol message is a Stream Control Transmission Protocol message with a Chunk Type set to "Error," a Cause Type set to "User-Initiated Abort," and an Upper Layer Abort Reason that indicates that the base station is unavailable.

15. The method of claim 14 wherein determining that the first base station is unavailable comprises receiving a notification from the first base station that the first base station is unavailable.

16. The method of claim 14 wherein determining that the first base station is unavailable comprises determining that the first base station is unresponsive.

17. The method of claim 14 wherein the cellular communication network is a Long Term Evolution cellular communication network, the base-station-to-base-station gateway is an X2-GW, and the one or more second base stations comprise base stations with an established X2 connection to the first base station through the X2-GW.

18. The method of claim 17 wherein notifying the one or more second base stations comprises sending an X2 message containing the information indicating that the first base station is unavailable to the one or more second base stations.

19. The method of claim 14 wherein the first base station is a low-power base station.

20. The method of claim 19 wherein the low-power base station is selected from the group consisting of a microcell eNB, a picocell eNB, a femtocell eNB, and a Home eNB.

21. A method of operation of a base station in a cellular communication network, the method comprising:

receiving notification that a second base station is unavailable, the second base station being a second base station with which the base station conducts base-station-to-base-station communication by receiving a Stream Control Transmission Protocol message containing information indicating that the second base station is unavailable;

wherein the Stream Control Transmission Protocol message is a Stream Control Transmission Protocol message with a Chunk Type set to "Error," a Cause Type set to "User-Initiated Abort," and an Upper Layer Abort Reason that indicates that the second base station is unavailable; and

in response to receiving the notification, ceasing communication attempts with the second base station.

22. The method of claim 21 wherein receiving the notification that the second base station is unavailable comprises receiving the notification directly from the second base station.

23. The method of claim 21 wherein receiving the notification that the second base station is unavailable comprises receiving the notification from a base-station-to-base-station gateway.

24. The method of claim 21 wherein the cellular communication network is a Long Term Evolution cellular communication network and receiving the notification that the second base station is unavailable comprises receiving an X2 message comprising the information that indicates that the second base station is unavailable.

25. The method of claim 21 further comprising: receiving notification that the second base station is available; and reestablishing the base-station-to-base-station communication with the second base station.

26. The method of claim 21 further comprising: waiting a specified time period; and

19

attempting to reestablish the base-station-to-base-station communication with the second base station.

**27.** A base station for use in a cellular communication network, the base station comprising:

a radio subsystem configured to provide wireless communication with one or more wireless devices served by the base station;

a communication subsystem; and

a processing subsystem associated with the communication subsystem and the radio subsystem configured to: determine that the base station is transitioning to an unavailable state; and

notify one or more radio network nodes that the base station is unavailable by sending a Stream Control Transmission Protocol message containing information indicating that the base station is unavailable;

wherein the Stream Control Transmission Protocol message is a Stream Control Transmission Protocol message with a Chunk Type set to "Error," a Cause Type set to "User-Initiated Abort," and an Upper Layer Abort Reason that indicates that the base station is unavailable.

**28.** The base station of claim **27** wherein:

the one or more radio network nodes comprise one or more second base stations with which the base station conducts base-station-to-base-station communication.

**29.** The base station of claim **27** wherein:

the one or more radio network nodes comprise a base-station-to-base-station gateway.

**30.** A base-station-to-base-station gateway for use in a cellular communication network, the base-station-to-base-station comprising:

a communication subsystem; and

a processing subsystem associated with the communication subsystem configured to:

determine that a first base station is unavailable; and

20

notify one or more second base stations with which the first base station conducts base-station-to-base-station communication that the base station is unavailable via the communication subsystem by sending a Stream Control Transmission Protocol message containing information indicating that the base station is unavailable;

wherein the Stream Control Transmission Protocol message is a Stream Control Transmission Protocol message with a Chunk Type set to "Error," a Cause Type set to "User-Initiated Abort," and an Upper Layer Abort Reason that indicates that the base station is unavailable.

**31.** A base station for use in a cellular communication network, the base station comprising:

a radio subsystem configured to provide wireless communication with one or more wireless devices served by the base station;

a communication subsystem; and

a processing subsystem associated with the communication subsystem and the radio subsystem configured to:

receive notification that a second base station is unavailable by receiving a Stream Control Transmission Protocol message containing information indicating that the base station is unavailable, the second base station being a second base station with which the base station conducts base-station-to-base-station communication;

wherein the Stream Control Transmission Protocol message is a Stream Control Transmission Protocol message with a Chunk Type set to "Error," a Cause Type set to "User-Initiated Abort," and an Upper Layer Abort Reason that indicates that the base station is unavailable; and

in response to receiving the notification, cease communication attempts with the second base station.

\* \* \* \* \*

UNITED STATES PATENT AND TRADEMARK OFFICE  
**CERTIFICATE OF CORRECTION**

PATENT NO. : 9,451,530 B2  
APPLICATION NO. : 14/068755  
DATED : September 20, 2016  
INVENTOR(S) : Gunnarsson et al.

Page 1 of 1

It is certified that error appears in the above-identified patent and that said Letters Patent is hereby corrected as shown below:

In the Specification

Column 5, Line 55, delete "51" and insert -- S1 --, therefor.

Column 5, Line 57, delete "51 connections. In LTE, 51" and insert -- S1 connections. In LTE, S1 --, therefor.

Column 6, Line 48, delete "X2-GW 30" and insert -- X2-GW 40 --, therefor.

Signed and Sealed this  
Twenty-sixth Day of September, 2017



Joseph Matal  
*Performing the Functions and Duties of the  
Under Secretary of Commerce for Intellectual Property and  
Director of the United States Patent and Trademark Office*