



US009270942B2

(12) **United States Patent**
Asai

(10) **Patent No.:** **US 9,270,942 B2**
(45) **Date of Patent:** ***Feb. 23, 2016**

(54) **COMMUNICATION MANAGEMENT SYSTEM, COMMUNICATION SYSTEM, COMPUTER-READABLE RECORDING MEDIUM, AND MAINTENANCE SYSTEM**

(71) Applicant: **RICOH COMPANY, LTD.**, Tokyo (JP)

(72) Inventor: **Takahiro Asai**, Kanagawa (JP)

(73) Assignee: **RICOH COMPANY, LIMITED**, Tokyo (JP)

(*) Notice: Subject to any disclaimer, the term of this patent is extended or adjusted under 35 U.S.C. 154(b) by 0 days.

This patent is subject to a terminal disclaimer.

(21) Appl. No.: **14/657,717**

(22) Filed: **Mar. 13, 2015**

(65) **Prior Publication Data**

US 2015/0189237 A1 Jul. 2, 2015

Related U.S. Application Data

(63) Continuation of application No. 14/368,986, filed as application No. PCT/JP2012/084288 on Dec. 26, 2012.

(30) **Foreign Application Priority Data**

Dec. 27, 2011 (JP) 2011-285768
Nov. 30, 2012 (JP) 2012-262456

(51) **Int. Cl.**
H04N 7/14 (2006.01)
H04N 7/15 (2006.01)
(Continued)

(52) **U.S. Cl.**
CPC **H04N 7/152** (2013.01); **H04L 12/1813** (2013.01); **H04L 12/1818** (2013.01); **H04L 65/605** (2013.01); **H04M 3/00** (2013.01); **H04M 3/56** (2013.01); **H04N 7/15** (2013.01)

(58) **Field of Classification Search**
None
See application file for complete search history.

(56) **References Cited**

U.S. PATENT DOCUMENTS

7,079,495 B1 * 7/2006 Pearce H04L 12/1818
340/3.52
7,383,341 B1 * 6/2008 Saito H04L 12/2834
709/228

(Continued)

FOREIGN PATENT DOCUMENTS

CN 101507267 A 8/2009
JP 2003-143323 5/2003

(Continued)

OTHER PUBLICATIONS

International Search Report issued on Feb. 12, 2013 in PCT/JP2012/084288 filed on Dec. 26, 2012.

(Continued)

Primary Examiner — Maria El-Zoobi

(74) *Attorney, Agent, or Firm* — Oblon, McClelland, Maier & Neustadt, L.L.P.

(57) **ABSTRACT**

A communication management system includes a storage unit configured to store therein destination information of a first communication terminal that establishes a first session with a relay device that relays communication data, destination information of a conversion system that performs mutual conversion between communication schemes of communication data transmitted from the first communication terminal and a second communication terminal and establishes a second session with the relay device, and destination information of the second communication terminal that establishes a third session with the conversion system; a receiving unit configured to receive start request information to start communication between the communication terminals from the first communication terminal; an extracting unit configured to extract destination information of each communication terminal and the conversion system stored in the storage unit, based on the received start request information; and a transmitting unit configured to transmit the extracted destination information to the relay device.

29 Claims, 18 Drawing Sheets

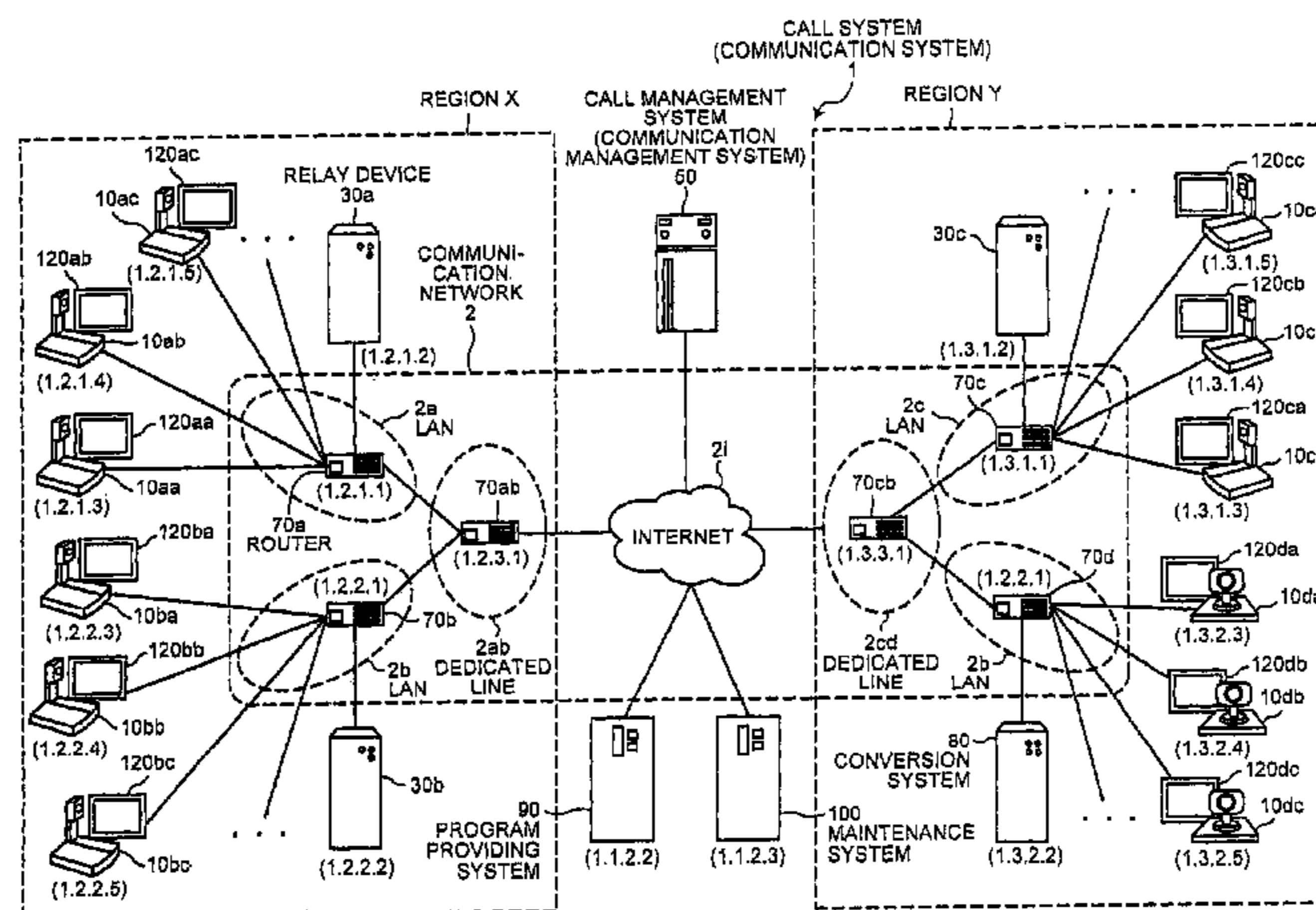

(51) **Int. Cl.**

H04M 3/00 (2006.01)
H04M 3/56 (2006.01)
H04L 12/18 (2006.01)
H04L 29/06 (2006.01)

FOREIGN PATENT DOCUMENTS

JP	2004-304241	10/2004
JP	2008-035476	2/2008
JP	2008-227577	9/2008
JP	2009-194661	8/2009
JP	2009-544176	12/2009
JP	2011-523330	8/2011
JP	2013-153418	8/2013
WO	2008/060262 A1	5/2008
WO	WO 2008/084424 A1	7/2008
WO	WO 2011/105621 A1	9/2011

(56)

References Cited

U.S. PATENT DOCUMENTS

2008/0112337	A1	5/2008	Shaffer et al.
2008/0165864	A1	7/2008	Eleftheriadis et al.
2008/0175325	A1	7/2008	Hannuksela et al.
2010/0002069	A1	1/2010	Eleftheriadis et al.
2010/0328459	A1*	12/2010	Jang H04N 7/181 348/143
2011/0202757	A1	8/2011	Nakagawa et al.
2011/0216699	A1	9/2011	Umehara et al.
2012/0002003	A1	1/2012	Okita et al.
2012/0140021	A1	6/2012	Tanaka et al.
2012/0221702	A1	8/2012	Umehara et al.
2012/0293692	A1	11/2012	Namie et al.
2012/0314019	A1	12/2012	Asai
2013/0060926	A1	3/2013	Kato et al.
2013/0166718	A1	6/2013	Okuyama et al.

OTHER PUBLICATIONS

U.S. Office Action mailed Jul. 28, 2015, in co-pending U.S. Appl. No. 14/368,986.
 Extended Search Report mailed May 19, 2015, in European Patent Application No. 12862181.0.
 Office Action mailed on Nov. 3, 2015 in Chinese Patent Application No. 201280070792.9 (with English Translation).

* cited by examiner

FIG. 1

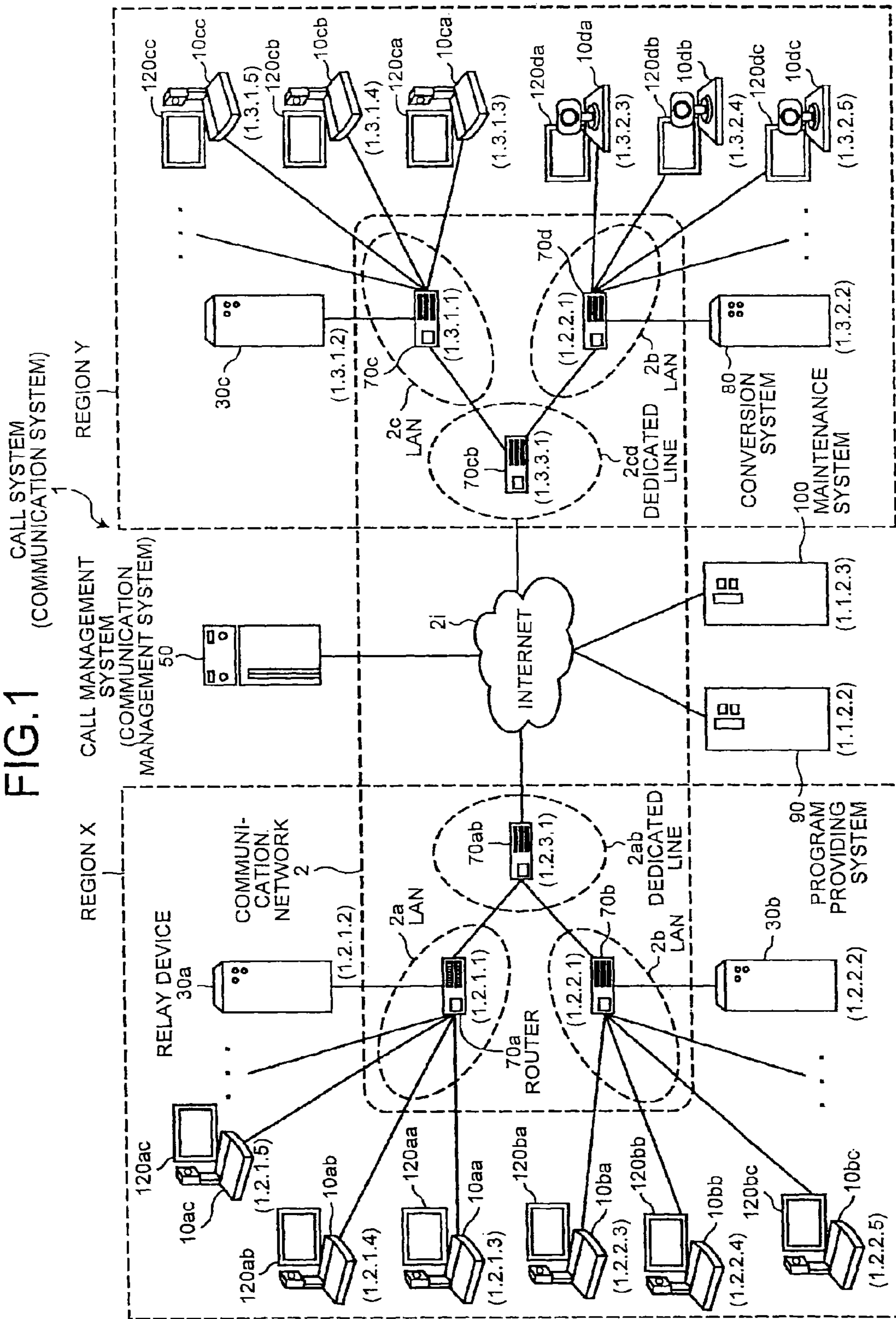

FIG.2

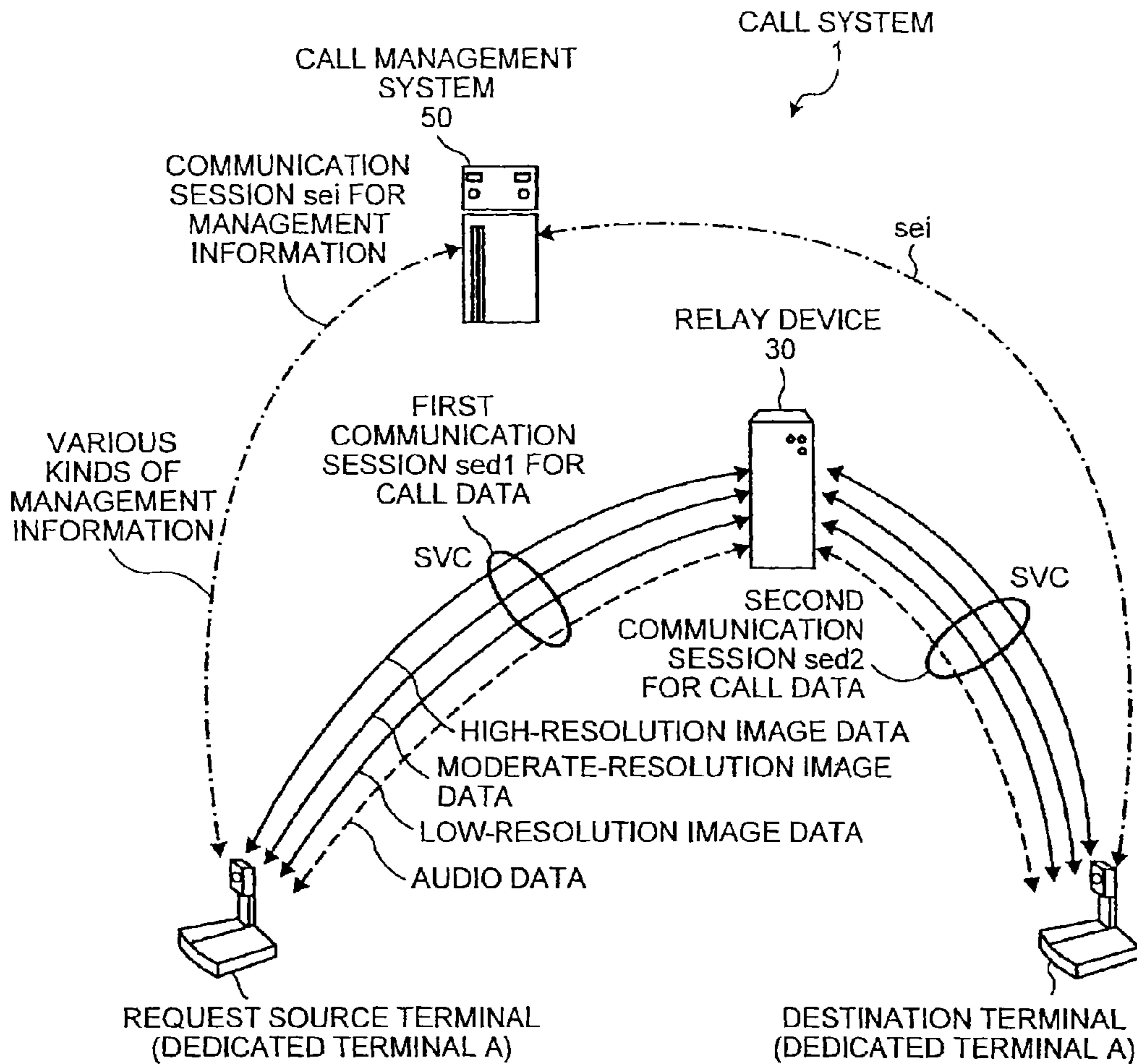

FIG.3

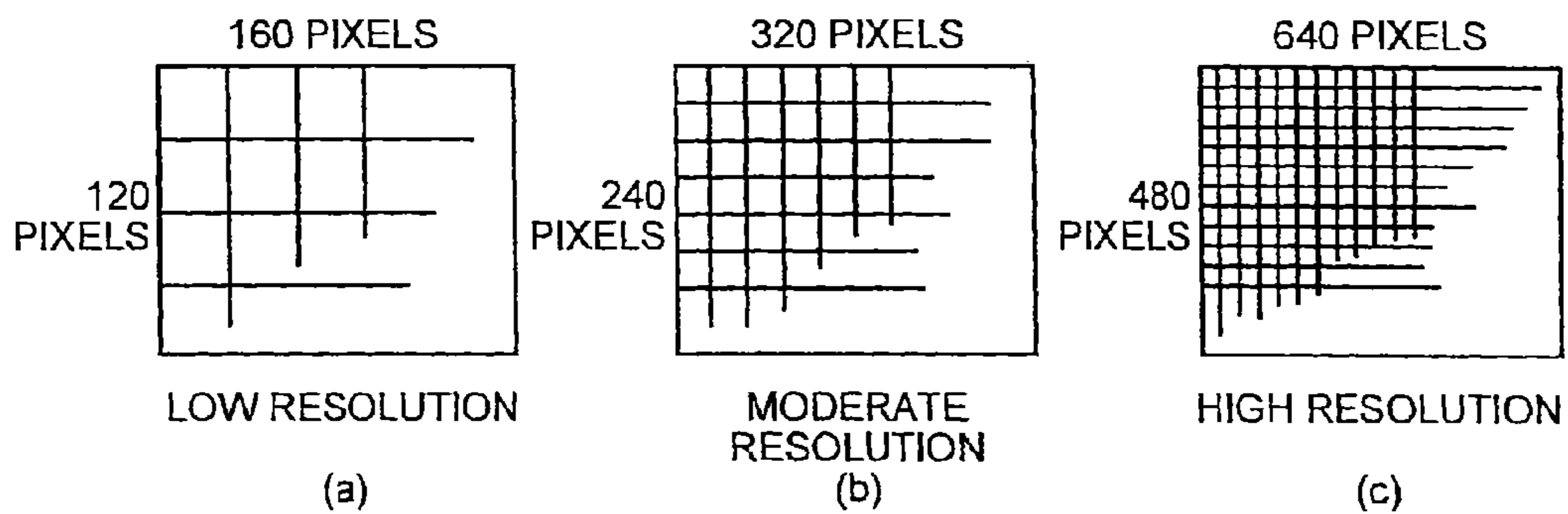

FIG.4

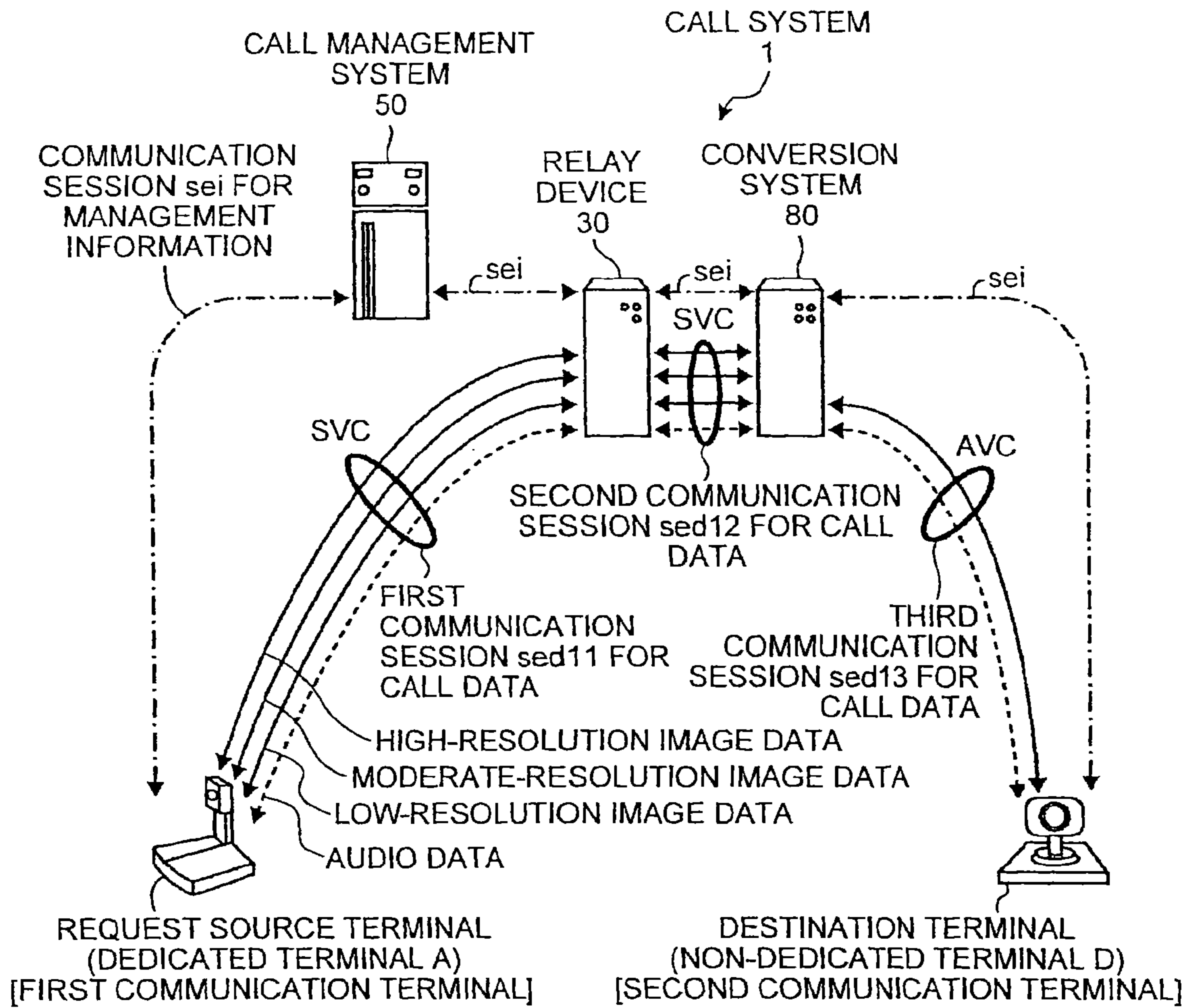

FIG.5

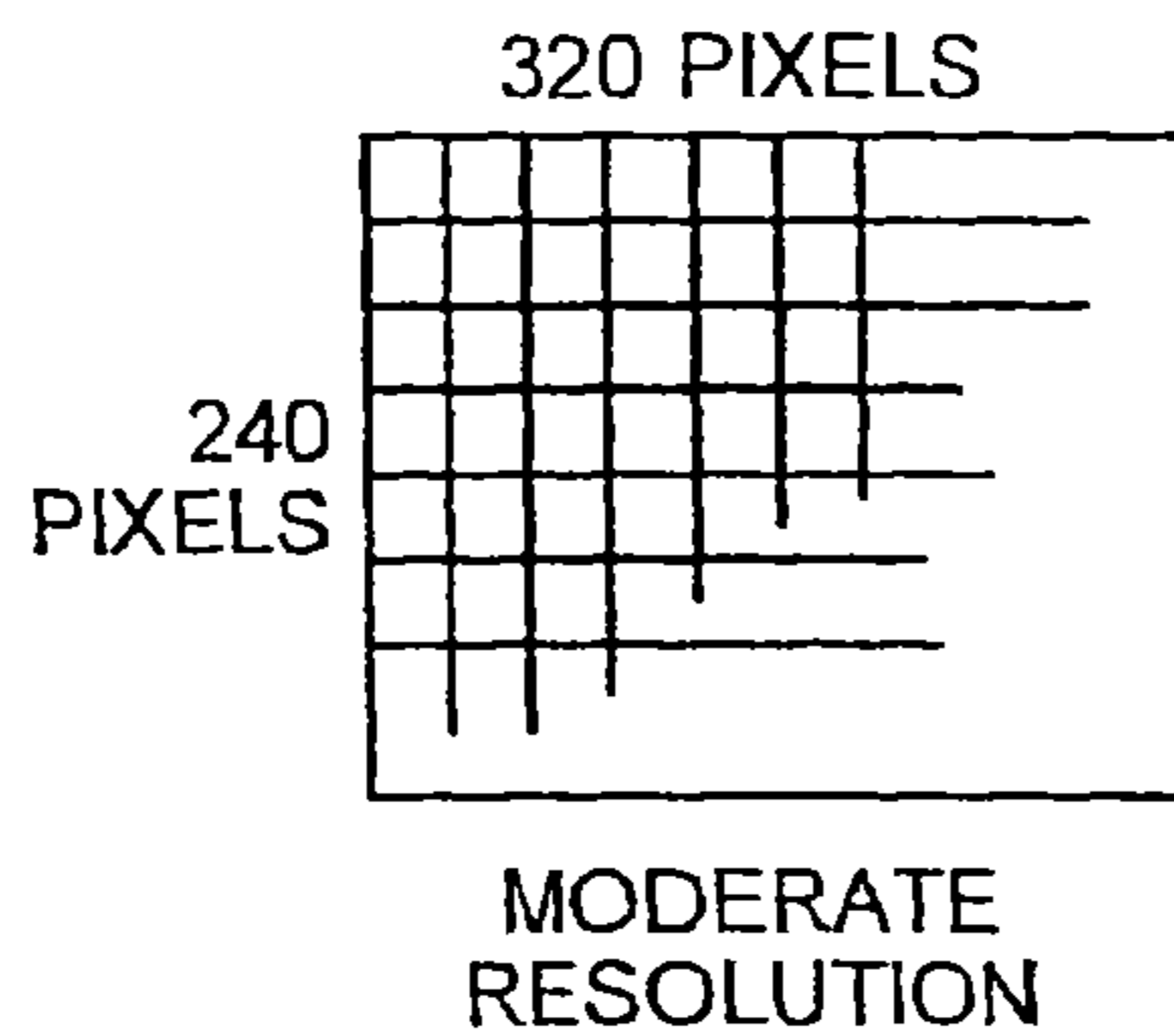

FIG.7

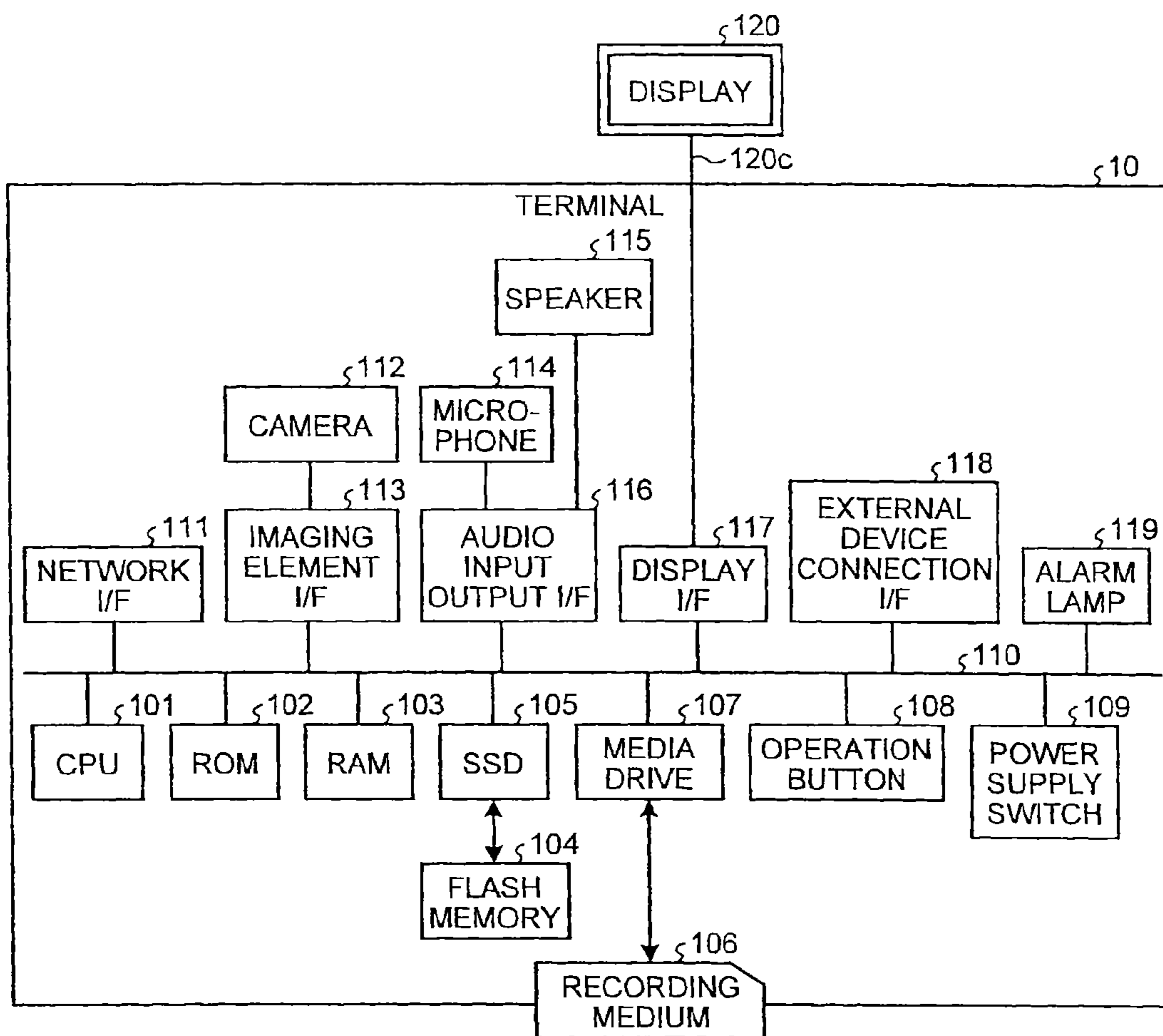

FIG. 8

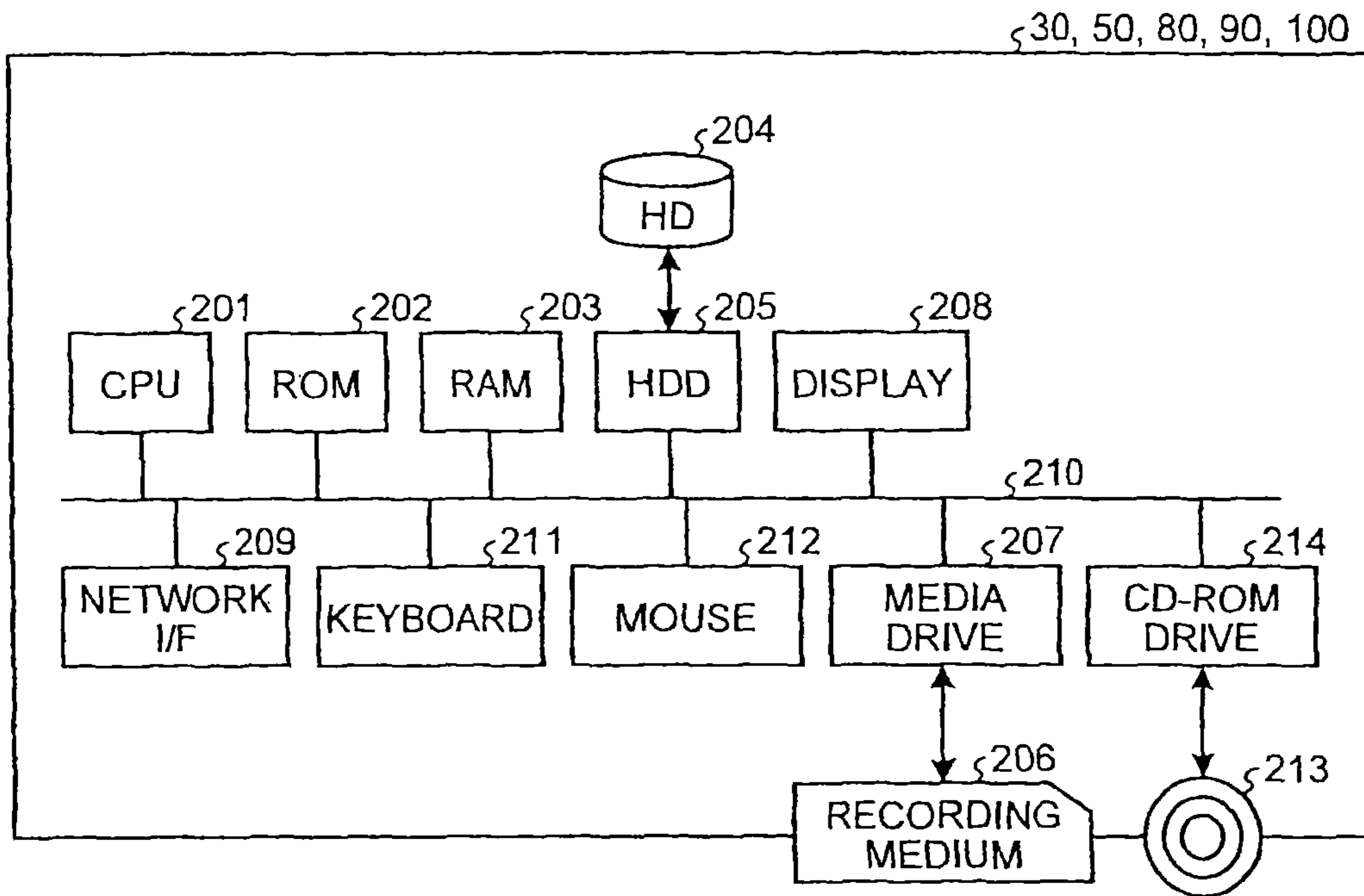

FIG. 9

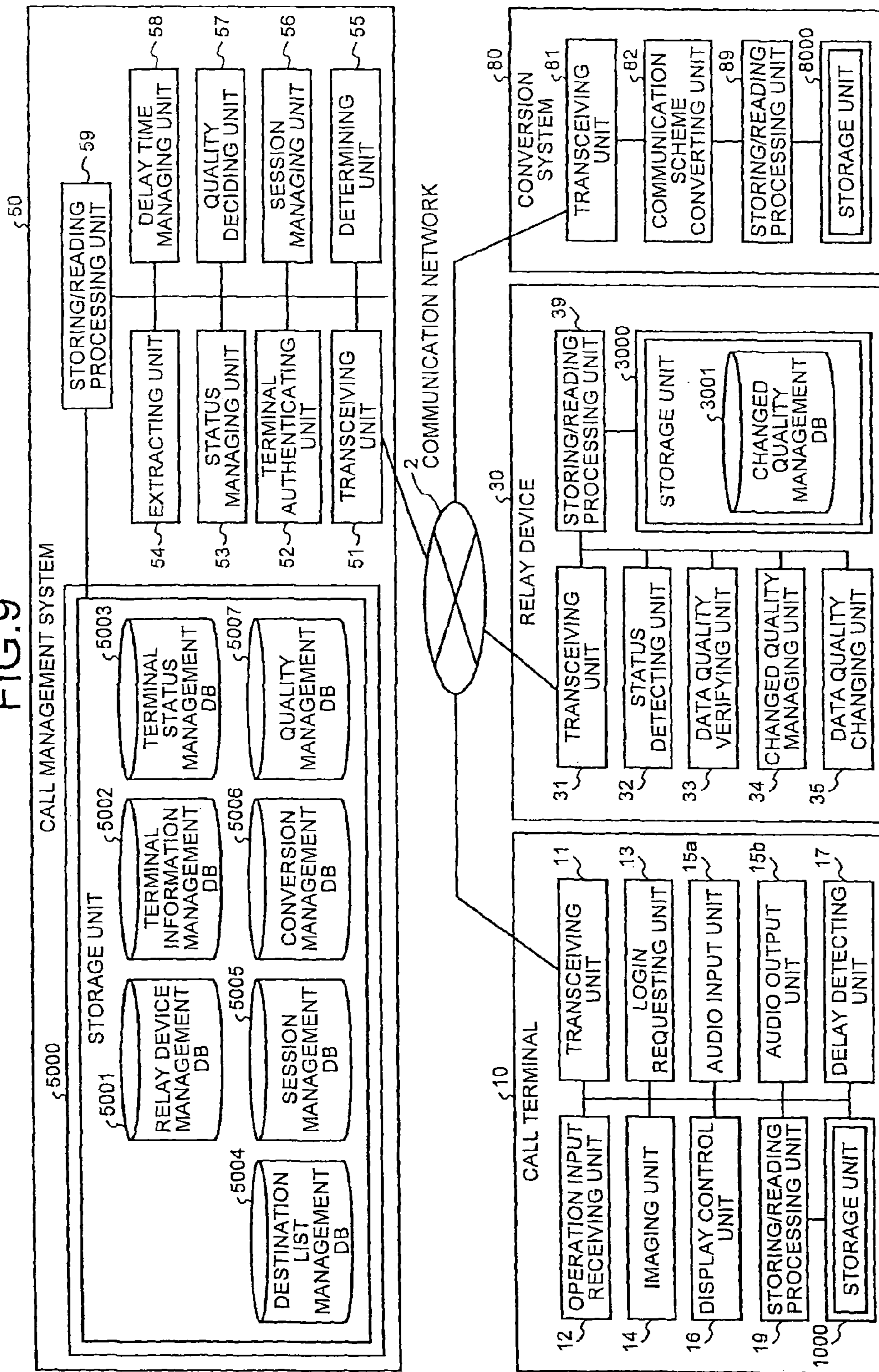

FIG.10

CHANGED QUALITY MANAGEMENT TABLE

IP ADDRESS OF RELAY DESTINATION TERMINAL	IMAGE QUALITY OF IMAGE DATA TO BE RELAYED (QUALITY OF IMAGE)
1.3.1.4	HIGH IMAGE QUALITY
1.3.1.3	HIGH IMAGE QUALITY
1.2.2.3	MODERATE IMAGE QUALITY
...	...

FIG.11

RELAY DEVICE MANAGEMENT TABLE

RELAY DEVICE ID	OPERATION STATUS	RECEPTION DATE AND TIME	IP ADDRESS OF RELAY DEVICE	MAXIMUM DATA CALL RATE (Mbps)
111a	ONLINE	2011.11.10.13:00	1.2.1.2	100
111b	ONLINE	2011.11.10.13:10	1.2.2.2	1000
111c	ONLINE	2011.11.10.13:20	1.3.1.2	10

FIG.12

TERMINAL INFORMATION MANAGEMENT TABLE

TERMINAL ID	PASSWORD	MODEL NO.	SERIAL NO.	COMMUNICATION SCHEME
01aa	aaaa	9001	2001	DEDICATED
01ab	abab	9001	2002	DEDICATED
01ac	acac	9001	2003	DEDICATED
...
01da	dada	8001	1001	NON-DEDICATED 1
01db	dbdb	8001	1002	NON-DEDICATED 2
01dc	dcdc	8001	1003	NON-DEDICATED 1
...

FIG.13

TERMINAL STATUS MANAGEMENT TABLE

TERMINAL ID	TERMINAL NAME	OPERATION STATUS	RECEPTION DATE AND TIME	IP ADDRESS OF TERMINAL
01aa	AA TERMINAL OF TOKYO BUSINESS OFFICE IN JAPAN	ONLINE (CALL POSSIBLE)	2011.11.10. 13:40	1.2.1.3
01ab	AA TERMINAL OF TOKYO BUSINESS OFFICE IN JAPAN	OFFLINE	2011.11.9. 12:00	1.2.1.4
...
01ba	BA TERMINAL OF OSAKA BUSINESS OFFICE IN JAPAN	ONLINE (TEMPORARY STOP)	2011.11.10. 13:45	1.2.2.3
01bb	BB TERMINAL OF OSAKA BUSINESS OFFICE IN JAPAN	ONLINE (CALL POSSIBLE)	2011.11.10. 13:50	1.2.2.4
...
01ca	CA TERMINAL OF NEW YORK BUSINESS OFFICE IN AMERICA	ONLINE (CALL POSSIBLE)	2011.11.10. 12:45	1.3.1.3
01cb	CB TERMINAL OF NEW YORK BUSINESS OFFICE IN AMERICA	ONLINE (BUSY)	2011.11.10. 13:55	1.3.1.4
...
01da	DA TERMINAL OF WASHINGTON BUSINESS OFFICE IN AMERICA			
01db	DB TERMINAL OF WASHINGTON BUSINESS OFFICE IN AMERICA			
...	...			

FIG.14

DESTINATION LIST MANAGEMENT TABLE

REQUEST SOURCE TERMINAL ID	DESTINATION TERMINAL ID
01aa	01ab, ..., 01ba, 01bb, ..., 01ca, 01cb, 01da, 01db
...	...
01ba	01aa, 01ab, 01ca, 01cb, 01da, 01db
...	...
01ca	01aa, 01ab, 01ba, ..., 01da,
...	...
01da	01aa, ...
...	...

FIG.15

SESSION MANAGEMENT TABLE

RELAY DEVICE ID	REQUEST SOURCE TERMINAL ID	DESTINATION TERMINAL ID	DELAY TIME (ms)	RECEPTION DATE AND TIME OF DELAY INFORMATION
111a	01aa	01ca	200	2011.11.10.14:00
111b	01ba	01cb	50	2011.11.10.14:10
111c	01bb	01cc	400	2011.11.10.14:20
...

FIG. 16

CONVERSION MANAGEMENT TABLE

TERMINAL ID OF NON-DEDICATED TERMINAL	IP ADDRESS OF CONVERSION SYSTEM	IP ADDRESS OF NO-DEDICATED TERMINAL
01da	1.3.2.2	1.3.2.3
01db	1.3.2.2	1.3.2.4
01dc	1.3.2.2	1.3.2.5
...

FIG. 17

QUALITY MANAGEMENT TABLE

DELAY TIME (ms)	IMAGE QUALITY OF IMAGE DATA (QUALITY OF IMAGE)
0 TO 100	HIGH IMAGE QUALITY
100 TO 300	MODERATE IMAGE QUALITY
300 TO 500	LOW IMAGE QUALITY
500 TO	(INTERRUPTION)

FIG. 18

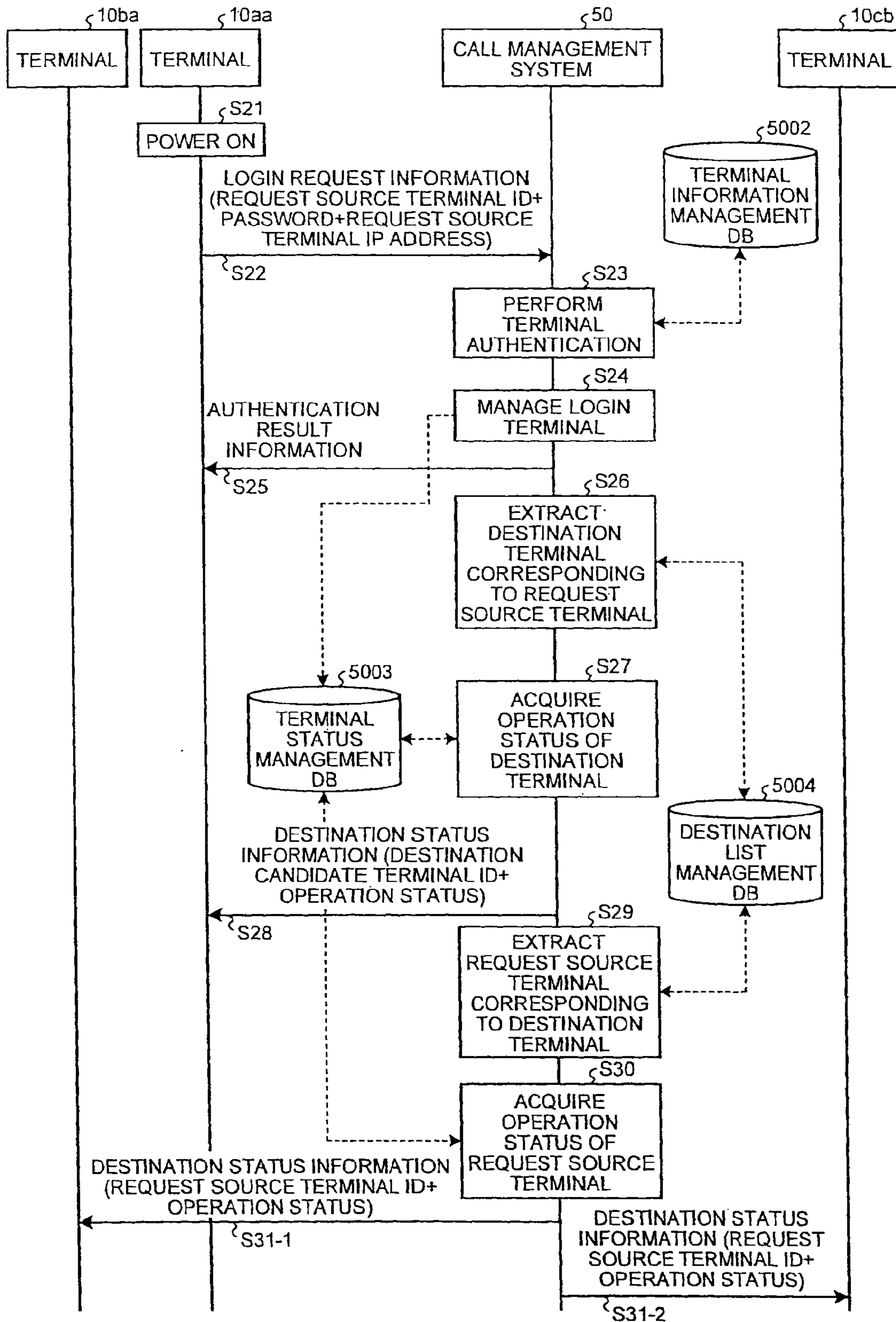

FIG.19

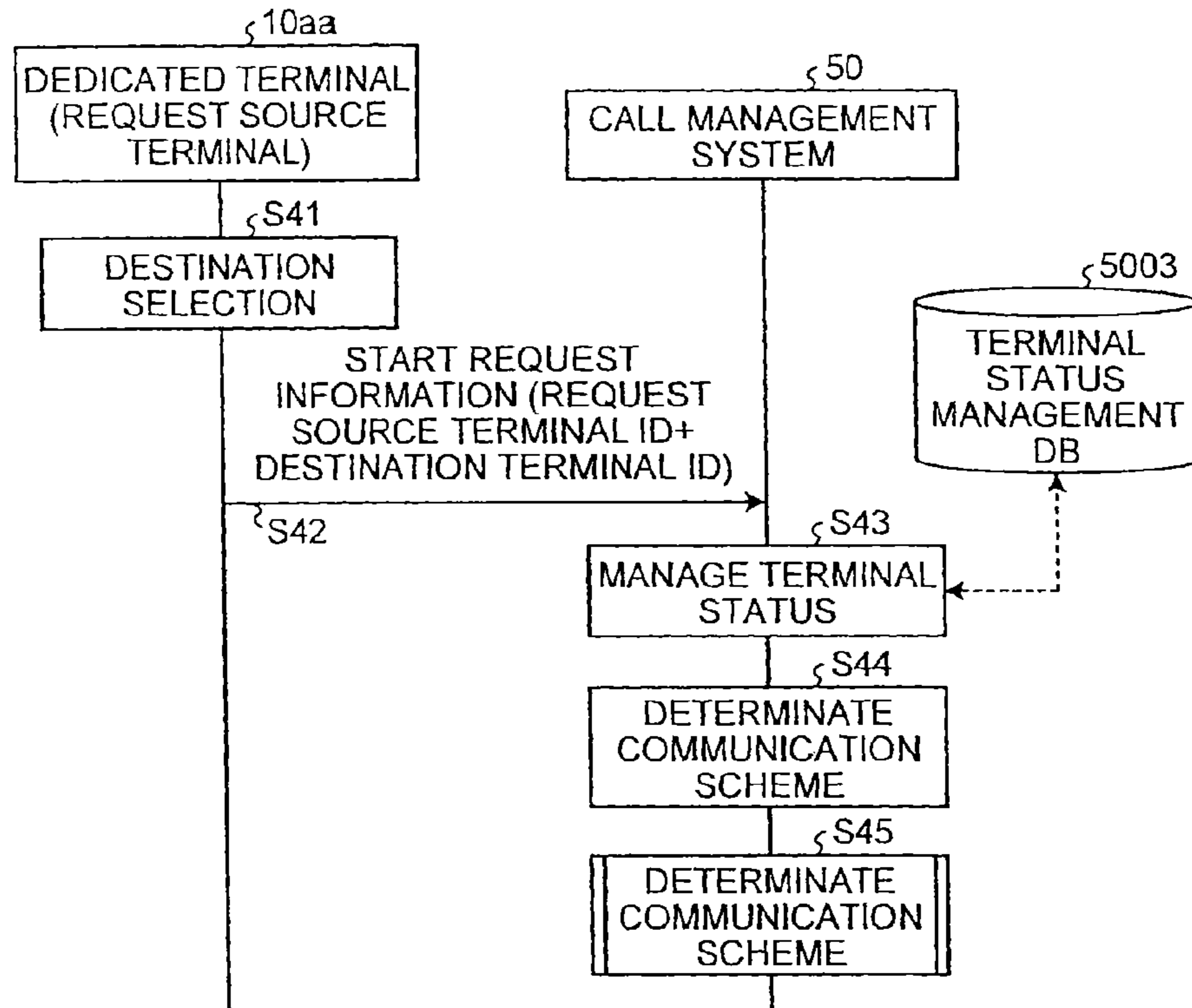

FIG.20

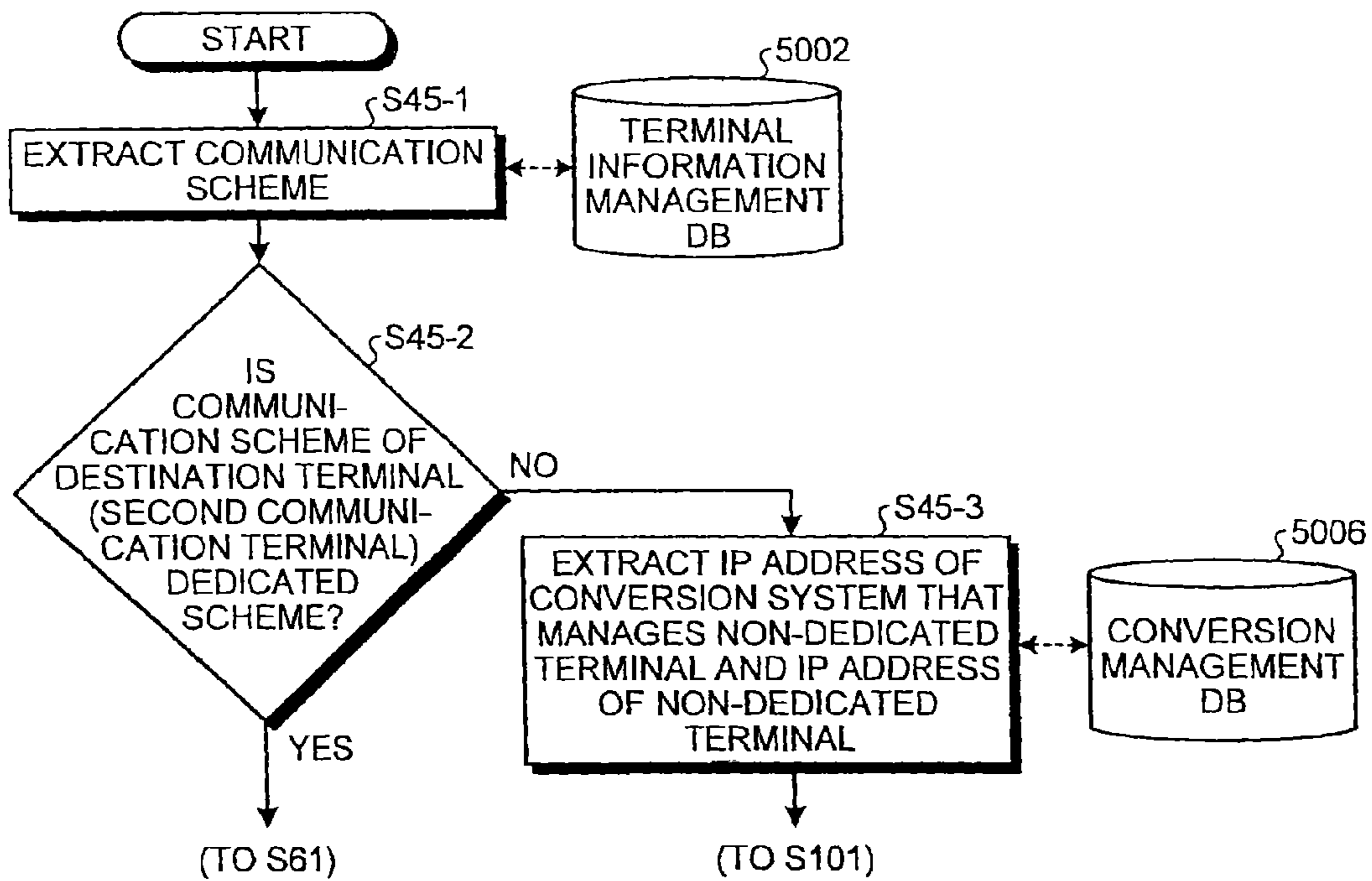

FIG.21

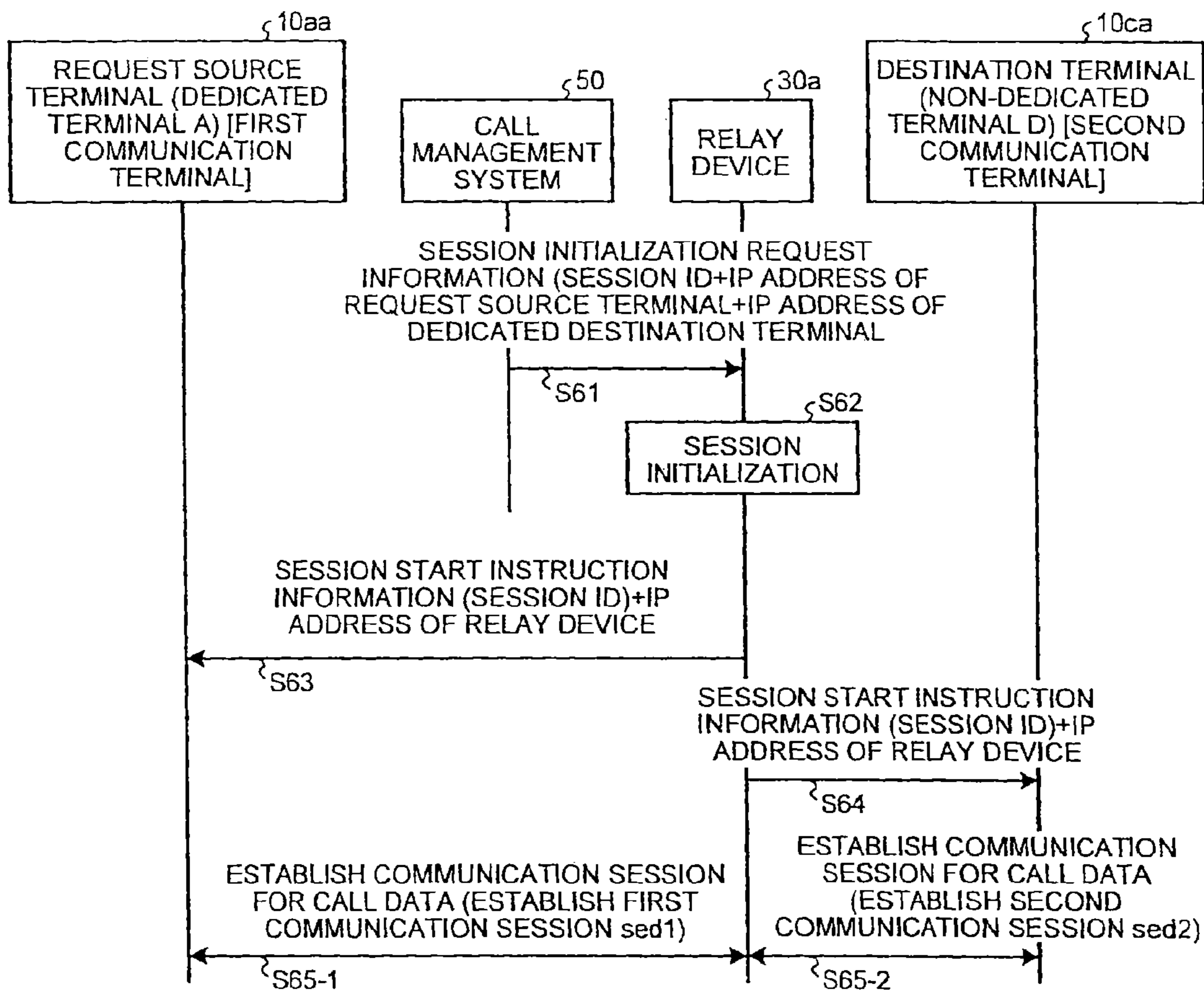

FIG.22

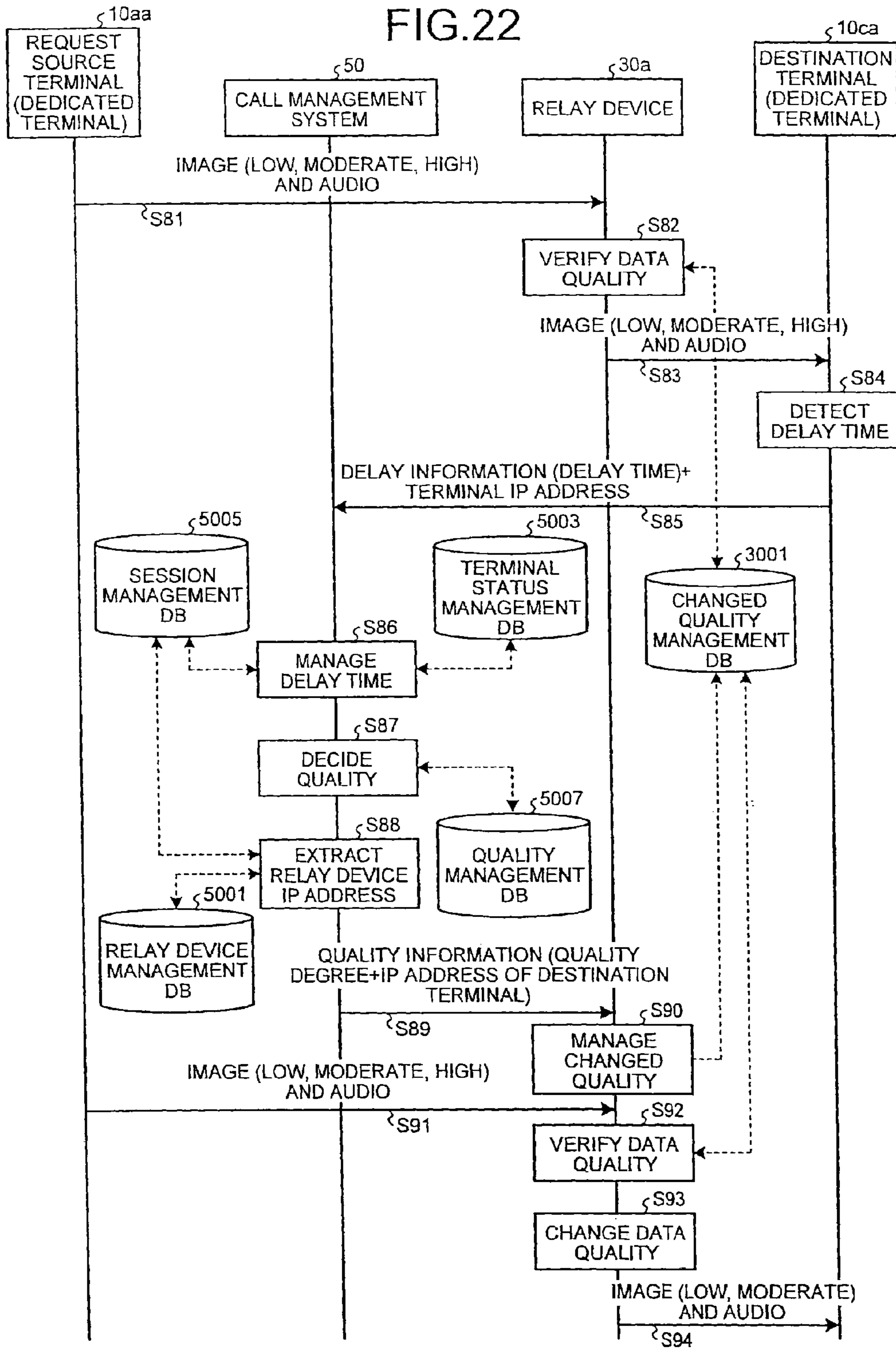

FIG. 23

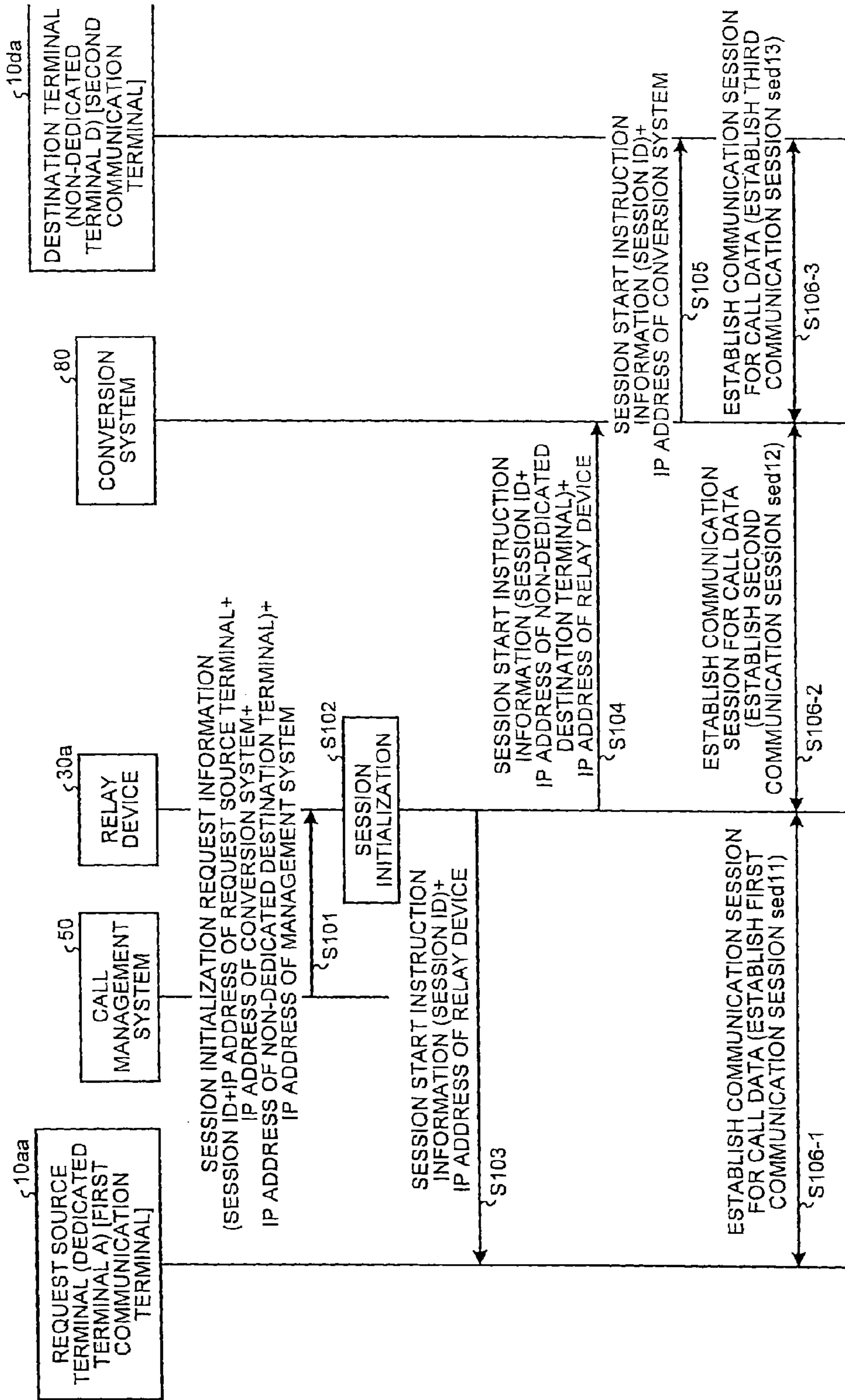

FIG.24

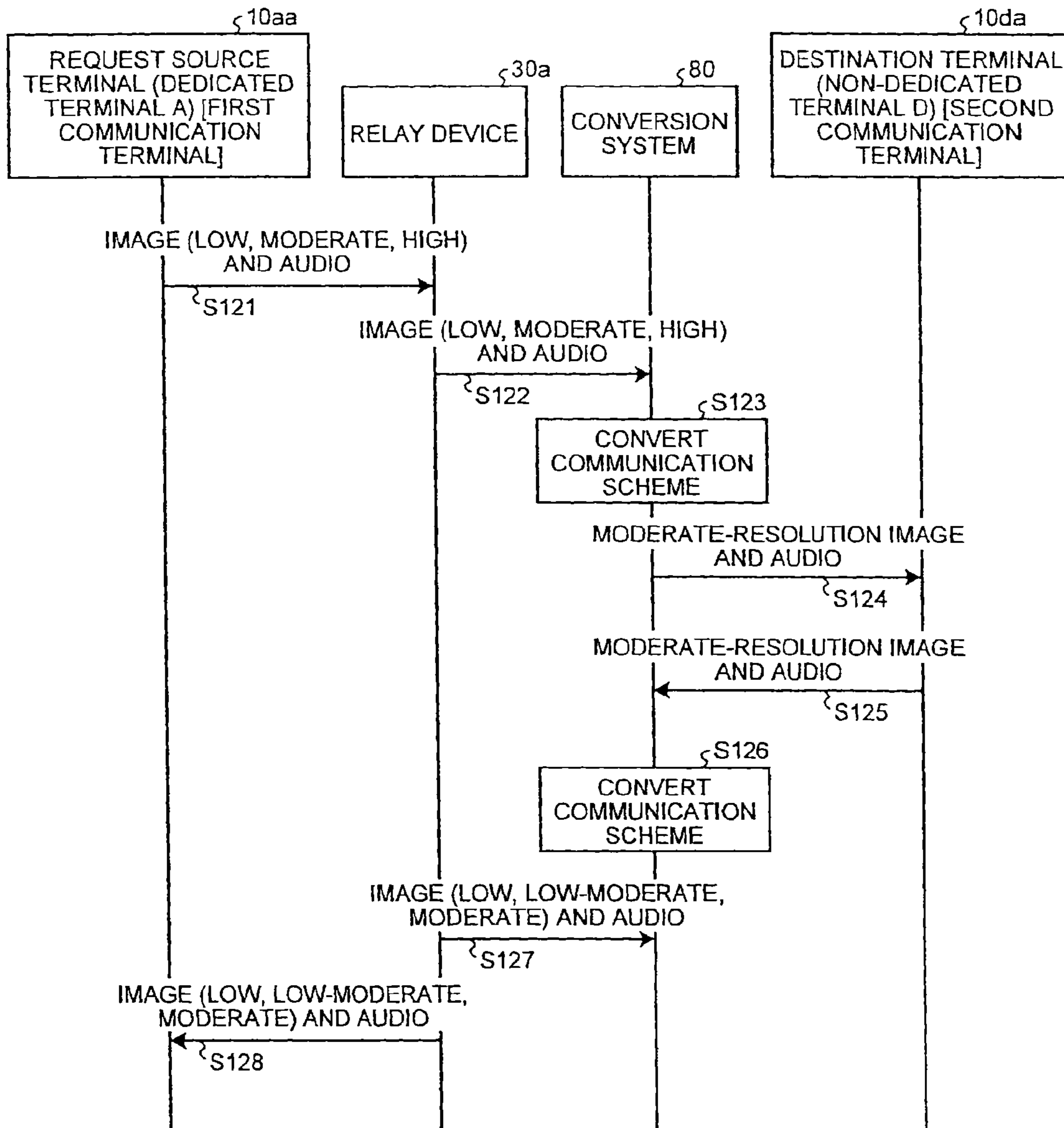
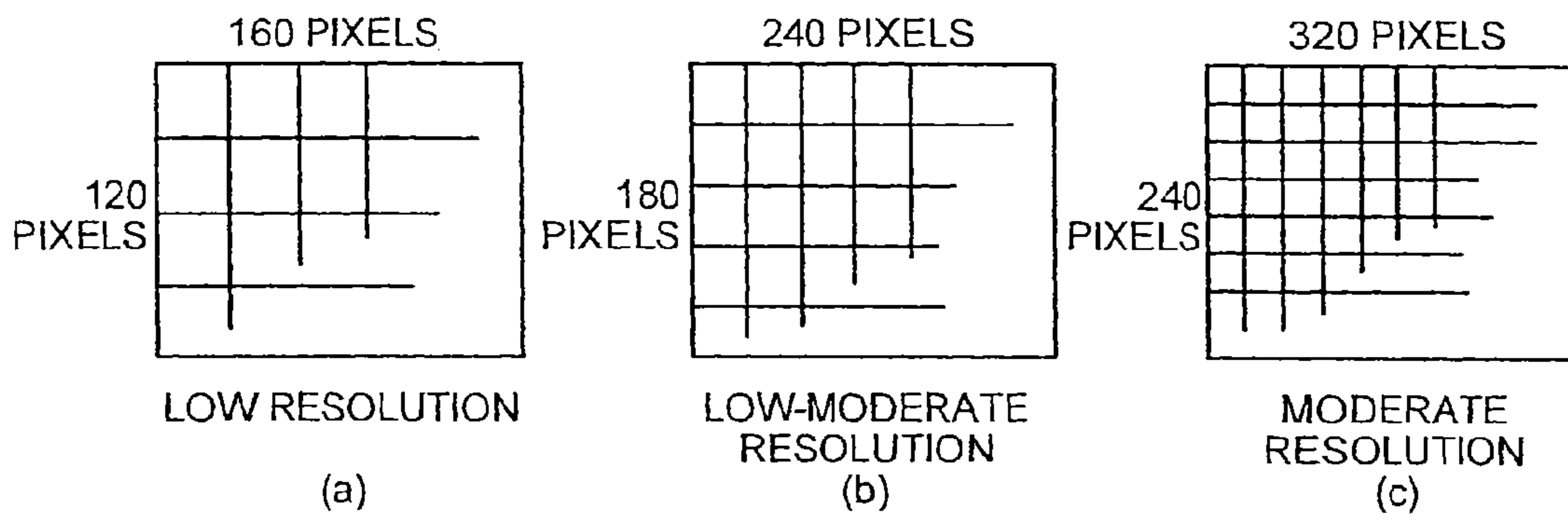

FIG.25



1

**COMMUNICATION MANAGEMENT
SYSTEM, COMMUNICATION SYSTEM,
COMPUTER-READABLE RECORDING
MEDIUM, AND MAINTENANCE SYSTEM**

CROSS-REFERENCE TO RELATED
APPLICATIONS

This application is a continuation of U.S. Ser. No. 14/368, 986, filed Jun. 26, 2014, the entire content of which is incorporated herein by reference, and claims the benefit of priority under 35 U.S.C. 119 to National Stage Application No. PCT/JP12/084288, filed Dec. 26, 2012, Japanese Application No. 2011-285768, filed Dec. 27, 2011 and Japanese Application No. 2012-262456, filed Nov. 30, 2012.

TECHNICAL FIELD

The present invention relates to management of first and second communication terminals that transmit and receive predetermined call data.

BACKGROUND ART

In recent years, with the request for reduction of business trip expenses and a business trip time, call systems in which video conferences are performed through a communication network such as the Internet are in widespread use. In this call system, a video conference can be conducted such that image data and audio data are transmitted and received between a plurality of call terminals.

Besides a call system of a type in which image data and audio data are transmitted and received directly between call terminals, video conference systems of a type in which a plurality of relay devices are used to relay image data and audio data between a plurality of call terminals have been emerged (see Japanese Patent Application Laid-open No. 2008-227577).

However, in the video conference call system according to the related art, it is difficult to implement a call between call terminals using different call schemes. In other words, when call terminals differ in call scheme from each other, for example, when call terminals differ in at least one of a call control scheme (a call control protocol) for establishing or disconnecting a connection with a destination of a call and a coding scheme for converting image data and audio data into IP packets, there occurs a problem in that it is difficult to implement a call between the call terminals.

DISCLOSURE OF INVENTION

It is an object of the present invention to at least partially solve the problems in the conventional technology.

According to an embodiment, a communication management system for managing first and second communication terminals that transmit and receive predetermined communication data. The communication management system includes a storage unit configured to store therein destination information representing a destination of the first communication terminal that establishes a first communication session with a relay device that relays the communication data, destination information representing a destination of a conversion system that performs mutual conversion between a communication scheme of communication data transmitted from the first communication terminal and a communication scheme of communication data transmitted from the second communication terminal and establishes a second communi-

2

cation session with the relay device, and destination information representing a destination of the second communication terminal that establishes a third communication session with the conversion system; a receiving unit configured to receive start request information to start communication between the first communication terminal and the second communication terminal from the first communication terminal; an extracting unit configured to extract destination information of each of the first and the second communication terminals and the conversion system stored in the storage unit, on the basis of the received start request information; and a transmitting unit configured to transmit the extracted destination information to the relay device.

The above and other objects, features, advantages and technical and industrial significance of this invention will be better understood by reading the following detailed description of presently preferred embodiments of the invention, when considered in connection with the accompanying drawings.

BRIEF DESCRIPTION OF DRAWINGS

FIG. 1 is a schematic diagram of a call system according to an embodiment;

FIG. 2 is a conceptual diagram illustrating a communication status when a call is implemented between call terminals having the same communication scheme;

FIG. 3 is a conceptual diagram illustrating image quality of image data transmitted and received according to an SVC standard in FIGS. 2 and 4;

FIG. 4 is a conceptual diagram illustrating a communication status when a call is implemented between call terminals having different communication schemes;

FIG. 5 is a conceptual diagram illustrating image quality of image data transmitted and received according to an AVC standard in FIG. 4;

FIG. 6 is an external appearance diagram of a call terminal according to the present embodiment;

FIG. 7 is a hardware configuration diagram of a call terminal according to the present embodiment;

FIG. 8 is a hardware configuration diagram of a call management system, a relay device, a conversion system, a program providing system, or a maintenance system according to the present embodiment;

FIG. 9 is a functional block diagram of a call terminal, a relay device, a call management system, and a conversion system that configure a part of a call system according to an embodiment;

FIG. 10 is a conceptual diagram illustrating a changed quality management table;

FIG. 11 is a conceptual diagram illustrating a relay device management table;

FIG. 12 is a conceptual diagram illustrating a terminal information management table;

FIG. 13 is a conceptual diagram illustrating a terminal status management table;

FIG. 14 is a conceptual diagram illustrating a destination list management table;

FIG. 15 is a conceptual diagram illustrating a session management table;

FIG. 16 is a conceptual diagram illustrating a conversion management table;

FIG. 17 is a conceptual diagram illustrating a quality management table;

FIG. 18 is a sequence diagram illustrating a process of a preliminary step to start a call between terminals;

3

FIG. 19 is a sequence diagram illustrating a call start request;

FIG. 20 is a flowchart illustrating a determination of a communication scheme;

FIG. 21 is a sequence diagram illustrating a process of establishing a communication session before a call is performed between two dedicated terminals;

FIG. 22 is a sequence diagram illustrating a process of transmitting and receiving call data between two dedicated terminals;

FIG. 23 is a sequence diagram illustrating a process of establishing a communication session before a call is performed between a dedicated terminal and a non-dedicated terminal;

FIG. 24 is a sequence diagram illustrating a process of transmitting and receiving call data between a dedicated terminal and a non-dedicated terminal; and

FIG. 25 is a conceptual diagram illustrating an image quality of image data converted by a conversion system.

BEST MODE(S) FOR CARRYING OUT THE INVENTION

Hereinafter, embodiments of the present invention will be described with reference to FIGS. 1 to 25.

Overall Configuration of Embodiment

FIG. 1 is a schematic diagram of a call system according to an embodiment of the present invention. Referring to FIG. 1, a call system 1 is constructed by a plurality of call terminals (10aa, 10ab, . . .), displays (120aa, 120ab, . . .) of the respective call terminals (10aa, 10ab, . . .), a plurality of relay devices (30a, 30b, and 30c), a call management system 50, a conversion system 80, a program providing system 90, and a maintenance system 100. Through the call system 1, communication of image data and audio data as an example of call data is performed, and thus, for example, a video conference between remote sites can be implemented. A plurality of routers (70a, 70b, 70c, 70d, 70ab, and 70cd) select an optimal path of call data.

The call terminals (10aa, 10ab, 10ac, . . .), the relay device 30a, and the router 70a are connected to perform communication with one another via a local area network (LAN) 2a. The call terminals (10ba, 10bb, 10bc, . . .), the relay device 30b, and the router 70b are connected to perform communication with one another via a LAN 2b. The LAN 2a and the LAN 2b are connected to perform communication with each other via a dedicated line 2ab including the router 70ab. Further, the LAN 2a, the LAN 2b, and the dedicated line 2ab are constructed in a predetermined region X. For example, the region X is Japan, the LAN 2a is constructed in a business office in Tokyo, and the LAN 2b is constructed in a business office in Osaka.

Meanwhile, the call terminals (10ca, 10cb, 10cc, . . .), the relay device 30c, and the router 70c are connected to perform communication with one another via a LAN 2c. The call terminals (10da, 10db, 10dc, . . .), the conversion system 80, and the router 70d are connected to perform communication with one another via a LAN 2d. Further, the LAN 2c and the LAN 2d are connected to perform communication with each other via a dedicated line 2cd including the router 70cd. Further, the LAN 2c, the LAN 2d, and the dedicated line 2cd are constructed in a predetermined region Y. For example, the region Y is the USA, the LAN 2c is constructed in a business office in New York, and the LAN 2d is constructed in a business office in Washington D.C. The region X and the region Y are connected to perform communication with each other via the Internet 2i from the routers (70ab, 70cd).

4

In the following, a “call terminal” is referred to simply as a “terminal”, and a “call management system” is referred to simply as a “management system”. An arbitrary one of a plurality of terminals (10aa, 10ab, . . .) is referred to as a “terminal 10”, an arbitrary one of a plurality of displays (120aa, 120ab, . . .) is referred to as a “display 120”, and an arbitrary one of a plurality of relay devices (30a, 30b, 30c) is referred to as a “relay device 30”. Further, a terminal serving as a request source that requests a start of a video conference is referred to as a “request source terminal”, and a terminal serving as a destination (a relay destination) that is a request destination is referred to as a “destination terminal”. Further, an arbitrary one of the routers (70a, 70b, 70c, 70d, 70ab, 70cd) is referred to as a “router 70”.

The call management system 50, the program providing system 90, and the maintenance system 100 are connected to the Internet 2i. In the present embodiment, the conversion system 80 is connected to the router 70d in the LAN 2d in the region Y. The call management system 50, the program providing system 90, and the maintenance system 100 may be installed in the region X or the region Y or may be installed in any other region.

In the present embodiment, a communication network 2 of the present embodiment is constructed by the LAN 2a, the LAN 2b, the dedicated line 2ab, the Internet 2i, the dedicated line 2cd, the LAN 2c, and the LAN 2d. In the communication network 2, there may be a place in which communication is performed in a wireless manner such as WiFi (Wireless Fidelity) or Bluetooth (registered trademark) as well as a wired manner.

In FIG. 1, 4-set digits illustrated below each terminal 10, each relay device 30, the call management system 50, each router 70, the conversion system 80, the program providing system 90, and the maintenance system 100 simply represent an IP address in typical IPv4. For example, the IP address of the terminal 10aa is “1.2.1.3”. IPv6 may be used rather than IPv4, but the description will proceed with IPv4 for the sake of simplification of description.

Each terminal 10 may be used not only for a call between a plurality of business offices or a call between different rooms in the same business office but also for a call within the same room, a call between an indoor place and an outdoor place, or a call between outdoor places. When each terminal 10 is used outdoor, communication is performed by a wireless manner such as a cellular telecommunication network.

Each terminal 10 illustrated in FIG. 1 is a terminal that implements a user’s call by transmitting and receiving call data, and is a terminal for a video conference, for example. Further, the terminal 10 performs transmission and reception of call data using a predetermined communication scheme (a call control scheme for establishing or disconnecting a connection with a destination of a call and a coding scheme for converting call data into IP packets).

Here, the examples of the call control scheme includes (1) a session initiation protocol (SIP), (2) a H.323, (3) a protocol extended from the SIP, (4) a protocol of an instant messenger, (5) a protocol using a MESSAGE method of the SIP, (6) a protocol of Internet Relay Chat (IRC), and (7) a protocol extended from a protocol of an instant messenger. Of these, for example, (4) the protocol of the instant messenger is a protocol used for (4-1) an extensible messaging and presence protocol (XMPP) or (4-2) a protocol used in ICQ (registered trademark), AIM (registered trademark), Skype (registered trademark), or the like. Further, for example, (7) the protocol extended from the protocol of the instant messenger is jingle.

Among a plurality of terminals 10, a terminal 10 that uses a communication scheme in which a call control scheme is a

5

protocol of an instant messenger (or a protocol extended from a protocol of an instant messenger), and a coding scheme is a scalable video coding (SVC) is referred to as a “dedicated terminal A”. Further, among a plurality of terminals **10**, a terminal **10** that has an IP address that is not managed by the call management system **50** and uses a communication scheme in which at least one of the call control scheme and the coding scheme is different from one of the dedicated terminal A is referred to as a “non-dedicated terminal D”. Further, in the present embodiment, “dedicated terminal A” is described as a terminal which is manufactured, sold, or managed by a specific company, and the “non-dedicated terminal D” is described as a terminal which is manufactured, sold, or managed by a company other than the specific company. In the present embodiment, since terminals which are manufactured, sold, or managed by different companies are likely to differ in communication scheme from each other, the description will proceed with this example. In addition, as examples of two terminals having different communication schemes, among terminals manufactured or sold by the same company, a terminal which is new in a manufacturing or selling time is referred to as a “dedicated terminal A”, and an old terminal is referred to as a “non-dedicated terminal D”.

Each relay device **30** is a computer system that relays call data between the plurality of terminals **10**. The call management system **50** is a computer system that performs login authentication from the terminal **10**, management of a call status of the terminal **10**, management of a destination list, and management of a communication status of the relay device **30** in an integrated fashion. An image of image data may be either or both of a moving image and a still image.

The conversion system **80** undertakes a signaling gateway that performs conversion of a call control signal and a video/audio gateway that performs encoding of call data. In other words, the conversion system **80** is a gateway that performs mutual conversion of a communication scheme of call data transmitted from a request source terminal and a communication scheme (a call control scheme and a coding scheme) of call data transmitted from a destination terminal, and converts at least one of a call control scheme and a coding scheme.

The program providing system **90** is a computer system that provides programs to be used to the terminal **10**, the relay device **30**, the call management system **50**, the conversion system **80**, and the maintenance system **100** via the communication network **2**, respectively.

The maintenance system **100** is a computer system that performs maintenance, management, or repair of at least one of the terminal **10**, the relay device **30**, the call management system **50**, the conversion system **80**, and the program providing system **90**. For example, when the maintenance system **100** is installed inside the country, and the terminal **10**, the relay device **30**, the call management system **50**, the conversion system **80**, or the program providing system **90** is installed outside the country, the maintenance system **100** remotely performs maintenance, that is, maintenance, management, or repair of at least one of the terminal **10**, the relay device **30**, the call management system **50**, the conversion system **80**, and the program providing system **90** via the communication network **2**. Further, the maintenance system **100** performs maintenance such as management of a model number, a manufacturing number, a sales destination, a repair check, or a failure history of at least one of the terminal **10**, the relay device **30**, the call management system **50**, the conversion system **80**, and the program providing system **90** without the communication network **2**.

Next, a first communication pattern for implementing a call between two dedicated terminals A will be described with

6

reference to FIGS. **2** and **3**. FIG. **2** is a conceptual diagram illustrating a communication status when a call is implemented between call terminals having the same communication scheme.

Referring to FIG. **2**, in the first communication pattern, the call system **1** performs communication of call data using a video coding standard of H.264/SVC. Specifically, in the call system **1**, a management communication session sei to transmit and receive various kinds of management information is established between a request source terminal of a dedicated terminal A and a destination terminal of a dedicated terminal A through the call management system **50** as illustrated in FIG. **2**. Further, four communication sessions to transmit and receive four pieces of data, that is, high-resolution image data, moderate-resolution image data, low-resolution image data, and audio data through the relay device **30** are established between the request source terminal and the destination terminal.

In FIG. **2**, four communication sessions established between the request source terminal and the relay device **30** are represented as a first communication session sed1 for call data. Further, four communication sessions established between the relay device **30** and the destination terminal are represented as a second communication session sed2 for call data.

Here, the resolution of an image of image data handled by the first communication pattern illustrated in FIG. **2** will be described with reference to FIG. **3**. FIG. **3** is a conceptual diagram illustrating an image quality of image data transmitted and received according to the SVC standard in FIG. **2**.

There are a low-resolution image including 160×120 pixels as illustrated in (a) of FIG. **3** as a base image, a moderate-resolution image including 320×240 pixels as illustrated in (b) of FIG. **3**, and a high-resolution image including 640×480 pixels as illustrated in (c) of FIG. **3**. Of these, in a narrow band route, low-quality image data including low-resolution image data as a base image is relayed by the relay device **30**. However, when a band is relatively broad, moderate-quality image data including low-resolution image data serving as a base image and moderate-resolution image data is relayed by the relay device **30**. Further, when a band is extremely broad, high-quality image data including low-resolution image data serving as a base image, moderate-resolution image data, and high-resolution image data is relayed by the relay device **30**.

Next, a second communication pattern for implementing a call between a dedicated terminal A and a non-dedicated terminal D will be described with reference to FIGS. **4** and **5**. FIG. **4** is a conceptual diagram illustrating a communication status when a call is implemented between call terminals having different communication schemes.

Referring to FIG. **4**, in the second communication pattern, the call system **1** performs communication of call data using a video coding standard of H.264/SVC and a video coding standard of H.264/AVC (Advanced Video Coding). Specifically, in the call system **1**, a management communication session sei to transmit and receive various kinds of management information is established between a request source terminal of a dedicated terminal A and a destination terminal of a non-dedicated terminal D through the call management system **50** as illustrated in FIG. **4**.

Further, four communication sessions to transmit and receive four pieces of data, that is, high-resolution image data, moderate-resolution image data, low-resolution image data, and audio data based on H.264/SVC through the relay device **30** are established between the request source terminal (an example of a first communication terminal) and the conversion system **80**. In FIG. **4**, four communication sessions

established between the request source terminal and the relay device **30** are represented as a first communication session **sed11** for call data. Further, four communication sessions established between the relay device **30** and the conversion system **80** are represented as a second communication session **sed12** for call data.

Further, two communication sessions to transmit and receive two pieces of data, that is, moderate-resolution image data and audio data based on H.264/AVC are established between the conversion system **80** and the destination terminal (an example of a second communication terminal). In FIG. 4, two communication sessions established between the conversion system **80** and the destination terminal are represented as a third communication session **sed13** for call data.

Here, the resolution of an image of image data handled by the second communication pattern illustrated in FIG. 4 will be described with reference to FIGS. 3 and 5. FIG. 5 is a conceptual diagram illustrating an image quality of image data transmitted and received according to the AVC standard in FIG. 4.

In the first communication session **sed11** and the second communication session **sed12** illustrated in FIG. 4, image data of three resolutions illustrated in (a) to (c) of FIG. 3 are transmitted and received as in the first communication session **sed1** and the second communication session **sed2** illustrated in FIG. 2. Meanwhile, in the third communication session **sed13** illustrated in FIG. 4, moderate-resolution image data illustrated in FIG. 5 is transmitted and received.

Hardware Configuration of Embodiment

Next, a hardware configuration of the present embodiment will be described. FIG. 6 is an external appearance diagram of a call terminal according to the present embodiment. Referring to FIG. 6, the terminal **10** includes a housing **1100**, an arm **1200**, and a camera housing **1300**. Of these, a front sidewall surface **1110** of the housing **1100** is provided with an air intake surface (not illustrated) formed by a plurality of air intake holes, and a rear sidewall surface **1120** of the housing **1100** is provided with an exhaust surface **1121** formed by a plurality of exhaust holes. Thus, as a cooling fan built in the housing **1100** is driven, external air in the rear of the terminal **10** is introduced through the air intake surface (not illustrated), and air is exhausted from the rear of the terminal **10** through the exhaust surface **1121**. A sound pick-up hole **1131** is formed on a right sidewall surface **1130** of the housing **1100**, and a voice, a sound, a noise, or the like are picked up by a built-in microphone **114** which will be described later.

An operation panel **1150** is formed on the right sidewall surface **1130** of the housing **1100**, and the operation panel **1150** is provided with a plurality of operation buttons **108a** to **108e**, a power supply switch **109**, and an alarm lamp **119**, which will be described later, and also provided with an output surface **1151** formed by a plurality of audio output holes through which a sound from a built-in speaker **115**, which will be described later, is output. An accommodating unit **1160** serving as a concave portion that accommodate the arm **1200** and the camera housing **1300** is formed on a left sidewall surface **1140** side of the housing **1100**. The right sidewall surface **1130** of the housing **1100** is provided with a plurality of connection ports **1132a** to **1132c** used to electrically connect a cable with a display I/F **117** which will be described later. Meanwhile, the left sidewall surface **1140** of the housing **1100** is provided with a connection port (not illustrated) used to electrically connect a cable **120c** for the display **120** to an external device connection I/F **118** which will be described later.

In the following, an arbitrary one of the operation buttons **108a** to **108e** is referred to as an "operation button **108**", and

an arbitrary one of the connection ports **1132a** to **1132c** is referred to as a "connection port **1132**".

Next, the arm **1200** is attached to the housing **1100** through a torque hinge **1210**, and the arm **1200** is configured to be vertically rotatable with a range of a tilt angle θ_1 of 135° with respect to the housing **1100**. FIG. 6 illustrates a state in which the tilt angle θ_1 is 90° . A built-in camera **112** is disposed in the camera housing **1300**, and can image the user, a document, a room, or the like. The camera housing **1300** is provided with a torque hinge **1310**. The camera housing **1300** is attached to the arm **1200** through the torque hinge **1310**. Further, the camera housing **1300** is configured to be horizontally rotatable in a range of a pan angle of θ_2 of $\pm 180^\circ$ with respect to the arm **1200** and vertically rotatable in a range of a tilt angle θ_3 of $\pm 45^\circ$ with respect to the arm **1200** when the state illustrated in FIG. 6 is 0° .

Each of the relay device **30**, the call management system **50**, the conversion system **80**, the program providing system **90**, and the maintenance system **100** has the same external appearance as a general server computer, and thus a description thereof will not be made.

FIG. 7 is a hardware configuration diagram of a terminal according to the present embodiment. As illustrated in FIG. 7, the terminal **10** according to the present embodiment includes a central processing unit (CPU) **101** that controls an operation of the terminal **10** in general, a read only memory (ROM) **102** that stores a program used to drive the CPU **101** such as an initial program loader (IPL), a random access memory (RAM) **103** used as a work area of the CPU **101**, a flash memory **104** that stores various kinds of data such as a program for the terminal **10**, image data, and audio data, a solid state drive (SSD) **105** that controls reading or writing of various kinds of data on the flash memory **104** according to control of the CPU **101**, a media drive **107** that controls reading or writing (storing) of data on a recording medium **106** such as a flash memory, the operation button **108** operated to select a destination of the terminal **10**, the power supply switch **109** used to power on or off the terminal **10**, and a network I/F **111** used to transmit data using the communication network **2**.

Further, the terminal **10** includes the built-in camera **112** that images a subject according to control of the CPU **101** and obtains image data, an imaging element I/F **113** that controls driving of the camera **112**, the built-in microphone **114** that receives a sound, the built-in speaker **115** that outputs a sound, an audio input output I/F **116** that processes an input and an output of an audio signal between the microphone **114** and the speaker **115** according to control of the CPU **101**, the display I/F **117** that transmits image data to the external display **120** according to control of the CPU **101**, the external device connection I/F **118** used to connect various kinds of external devices, the alarm lamp **119** that notifies of abnormality of various kinds of functions of the terminal **10**, and a bus line **110** such as an address bus or a data bus used to electrically connect the above-mentioned components as illustrated in FIG. 5.

The display **120** is a display unit configured with a liquid crystal display (LCD) device or an organic EL device that displays a subject image, an operation icon, or the like. The display **120** is connected to the display I/F **117** through the cable **120c**. The cable **120c** may be a cable for an analog RGB (VGA) signal, a cable for a component video, or a cable for high-definition multimedia interface (HDMI) or digital video interface (DVI).

The camera **112** includes a lens and a solid-state imaging element that converts light into electric charges and digitizes a subject image (video), and a complementary metal oxide

semiconductor (CMOS), a charge coupled device (CCD), or the like is used as the solid-state imaging element.

An external device such as an external camera, an external microphone, and an external speaker may be electrically connected to the external device connection I/F **118** through a universal serial bus (USB) cable inserted into the connection port **1132** of the housing **1100** illustrated in FIG. **6**. When the external camera is connected, the external camera takes priority over the built-in camera **112** and is driven according to control of the CPU **101**. Similarly, when the external microphone is connected or when the external speaker is connected, the external microphone or the external speaker takes priority over the built-in microphone **114** or the built-in speaker **115** and is driven according to control of the CPU **101**.

The recording medium **106** is configured to be removably attached to the terminal **10**. As long as non-volatile memory that performs reading or writing of data according to control of the CPU **101**, the recording medium **106** is not limited to the flash memory **104** and may include electrically erasable and programmable ROM (EEPROM) or the like.

FIG. **8** is a hardware configuration diagram of a management system according to the present embodiment of the present invention. The call management system **50** includes a CPU **201** that controls an operation of the call management system **50** in general, a ROM **202** that stores a program used for driving of the CPU **201** such as an IPL, a RAM **203** used as a work area of the CPU **201**, and a hard disk (HD) **204** that stores various kinds of data such as a program for the call management system **50**, a hard disk drive (HDD) **205** that controls reading or writing of various kinds of data on the HD **204** according to control of the CPU **201**, a media drive **207** that controls reading or writing (storing) of data on a recording medium **206** such as a flash memory, a display **208** that displays various kinds of information such as a cursor, a menu, a window, a text, or an image, a network I/F **209** that performs data communication via the communication network **2**, a keyboard **211** including a plurality of keys used to input a text, a digit, various kinds of instructions, or the like, a mouse **212** used to select or execute various kinds of instructions, select a processing target, or move a cursor, a CD-ROM drive **214** that controls reading or writing of various kinds of data on a compact disc read only memory (CD-ROM) **213** as an example of a removable recording medium, and a bus line **210** such as an address bus or a data bus used to electrically connect the above-mentioned components as illustrated in FIG. **8**.

Meanwhile, the relay device **30**, the conversion system **80**, the program providing system **90**, and the maintenance system **100** have the same hardware configuration as the call management system **50**, and thus a description thereof will not be made. However, each HD **204** stores various kinds of data such as a program that controls each of the relay device **30**, the conversion system **80**, the program providing system **90**, and the maintenance system **100**.

The programs for the terminal **10**, the relay device **30**, the conversion system **80**, the program providing system **90**, and the maintenance system **100** may be recorded in a computer readable recording medium (the recording medium **106** or the like) as a file of an installable format or an executable form, and distributed. As another example of the recording medium, there are a compact disc recordable (CD-R), a digital versatile disk (DVD), a Blu-ray disc, and the like.

Functional Configuration of Embodiment

Next, a functional configuration of the present embodiment will be described. FIG. **9** is a functional block diagram of the terminal **10**, the relay device **30**, the call management system **50**, and the conversion system **80** that configure a part of the

call system **1** according to the present embodiment. Referring to FIG. **9**, the terminal **10**, the relay device **30**, the call management system **50**, and the conversion system **80** are connected to perform data communication with one another via the communication network **2**.

Functional Configuration of Terminal

The terminal **10** includes a transceiving unit **11**, an operation input receiving unit **12**, a login requesting unit **13**, an imaging unit **14**, an audio input unit **15a**, an audio output unit **15b**, a display control unit **16**, a delay detecting unit **17**, and a storing/reading processing unit **19**. Each unit is any one of the components illustrated in FIG. **7** and is a function or a device that is operated and implemented according to an instruction from the CPU **101** that follows a program for the terminal **10** developed from the flash memory **104** onto the RAM **103**. Further, the terminal **10** includes a storage unit **1000** that is constructed by the RAM **103** illustrated in FIG. **7** and the flash memory **104** illustrated in FIG. **7**.

Each Functional Configuration of Terminal

Next, each functional configuration of the terminal **10** will be described in detail with reference to FIGS. **7** and **9**. In the following, when each functional configuration of the terminal **10** is described, a relation with a main component for implementing each functional configuration of the terminal **10** among the components illustrated in FIG. **7** will be also described.

The transceiving unit **11** of the terminal **10** illustrated in FIG. **9** is implemented by the network I/F **111** illustrated in FIG. **7** according to an instruction from the CPU **101** illustrated in FIG. **7**, and transmits or receives various kinds of data (or information) to or from another terminal, device, or system via the communication network **2**. The transceiving unit **11** starts to receive each piece of status information representing a status of each terminal serving a destination candidate through the call management system **50** before starting a call with a desired destination terminal. The status information represents not only an operation status (an online status or an offline status) of each terminal **10** but also a detailed status representing whether each terminal **10** is available or busy, or whether or not the user has left his/her seat even though each terminal **10** is online. Further, the status information represents not only the operation status of each terminal **10** but also various statuses such as a status representing that the cable **120c** is removed from the terminal **10**, a status in which a sound is output but an image is not output, and a status (MUTE) in which a sound is not output. The following description will proceed with an example in which the status information represents the operation status.

The operation input receiving unit **12** is implemented by the operation button **108** and the power supply switch **109** illustrated in FIG. **7** according to an instruction from the CPU **101** illustrated in FIG. **7**, and receives various kinds of inputs made by the user. For example, when the user turned on the power supply switch **109** illustrated in FIG. **7**, the operation input receiving unit **12** illustrated in FIG. **9** receives a power-on input and turns on power.

The login requesting unit **13** is implemented according to an instruction from the CPU **101** illustrated in FIG. **7**, and automatically transmits login request information to request a login and a current IP address of the request source terminal from the transceiving unit **11** to the call management system **50** via the communication network **2** when the power-on input is received. Further, when the user turned off the power supply switch **109** that is in an on state, the transceiving unit **11** transmits status information representing power off to the call management system **50**, and then the operation input receiving unit **12** completely turned off the power. Thus, the

11

call management system **50** side can detect that the terminal **10** has transitioned from the power-on state to the power-off state.

The imaging unit **14** is implemented by the camera **112** and the imaging element I/F **113** illustrated in FIG. 7 according to an instruction from the CPU **101** illustrated in FIG. 7, and images a subject and outputs obtained image data.

The audio input unit **15a** is implemented by the audio input output I/F **116** illustrated in FIG. 7 according to an instruction from the CPU **101** illustrated in FIG. 7, and converts the user's sound into an audio signal through the microphone **114** and receives audio data related to the audio signal. The audio output unit **15b** is implemented by the audio input output I/F **116** illustrated in FIG. 7 according to an instruction from the CPU **101** illustrated in FIG. 7, and outputs an audio signal related to audio data to the speaker **115** and outputs a sound from the speaker **115**.

The display control unit **16** is implemented by the display I/F **117** illustrated in FIG. 7 according to an instruction from the CPU **101** illustrated in FIG. 7, and performs control such that received image data having different resolutions are combined and combined image data will be transmitted to the display **120** as will be described later. The display control unit **16** can cause the destination list to be displayed on the display **120** by transmitting information of the list received from the call management system **50** to the display **120**.

The delay detecting unit **17** is implemented according to an instruction from the CPU **101** illustrated in FIG. 7, and detects a delay time (ms) of image data or audio data transmitted from another terminal **10** through the relay device **30**.

The storing/reading processing unit **19** is implemented by the SSD **105** illustrated in FIG. 7 according to an instruction from the CPU **101** illustrated in FIG. 7 or is implemented according to an instruction from the CPU **101**, and performs a process of storing various kinds of data in the storage unit **1000** or reading various kinds of data stored in the storage unit **1000**. The storage unit **1000** stores terminal identification (ID) used to identify the terminal **10**, a password, and the like. Further, image data and audio data received when a call with the destination terminal is performed are overwritten and stored in the storage unit **1000** each time image data and audio data are received. Of these, an image is displayed on the display **120** based on image data which is not overwritten, and a sound is output from the speaker **115** based on audio data that is not overwritten.

The terminal ID and a relay device ID (which will be described later) of the present embodiment represent identification information, such as a language, a text, a symbol, or a sign, which is used to uniquely identify the terminal **10** and the relay device **30**, respectively. The terminal ID and the relay device ID may be identification information in which at least two of a language, a text, a symbol, and a sign are combined.

<Functional Configuration of Relay Device>

The relay device **30** includes a transceiving unit **31**, a status detecting unit **32**, a data quality verifying unit **33**, a changed quality managing unit **34**, a data quality changing unit **35**, and a storing/reading processing unit **39**. Each unit is any one of the components illustrated in FIG. 8 and is a function or a device that is operated and implemented according to an instruction from the CPU **201** that follows a program for the relay device **30** developed from the HD **204** onto the RAM **203**. Further, the relay device **30** includes a storage unit **3000** that is constructed by the RAM **203** illustrated in FIG. 8 and the HD **204** illustrated in FIG. 8.

12

Changed Quality Management Table

FIG. 10 is a conceptual diagram illustrating a changed quality management table. In the storage unit **3000**, a changed quality management database (DB) **3001** configured with a changed quality management table illustrated in FIG. 10 is constructed. In the changed quality management table, an IP address of the terminal **10** serving as a relay destination (destination) of image data is managed in association with an image quality of image data which is relayed to this relay destination by the relay device **30**.

Each Functional Configuration of Relay Device

Next, each functional configuration of the relay device **30** will be described in detail. In the following, when each functional configuration of the relay device **30** is described, a relation with a main component for implementing each functional configuration of the relay device **30** among the components illustrated in FIG. 8 will be also described.

The transceiving unit **31** of the relay device **30** illustrated in FIG. 9 is implemented by the network I/F **209** illustrated in FIG. 8 according to an instruction from the CPU **201** illustrated in FIG. 8, and transmits or receives various kinds of data (or information) to or from another terminal, device, or system via the communication network **2**. The transceiving unit **31** performs initialization of a communication session in an own device.

Further, the transceiving unit **31** transmits session start instruction information to instruct a start of a communication session (a first communication session) to a destination represented by an IP address of the request source terminal among IP addresses received by the transceiving unit **31**. Further, the transceiving unit **31** transmits session start instruction information to instruct a start of a communication session (a second communication session) and an IP address of the destination terminal to a destination represented by an IP address of the conversion system **80** among IP addresses received by the transceiving unit **31**.

The status detecting unit **32** is implemented according to an instruction from the CPU **201** illustrated in FIG. 8, and detects the operation status of the relay device **30** having the status detecting unit **32**. As the operation status, there are an "online" state, an "offline" state, a "busy" state, and a "temporary stop" state.

The data quality verifying unit **33** is implemented according to an instruction from the CPU **201** illustrated in FIG. 8, and verifies an image quality of image data to be relayed by searching the changed quality management table (see FIG. 10) using the IP address of the destination terminal as a search key and extracting an image quality of corresponding image data to be relayed.

The changed quality managing unit **34** is implemented according to an instruction from the CPU **201** illustrated in FIG. 8, and changes content of the changed quality management table (see FIG. 10) based on quality information (which will be described later) transmitted from the call management system **50**. For example, while a video conference is being performed such that high-quality image data is transmitted and received between the request source terminal (the terminal **10aa**) having the terminal ID of "01aa" and the destination terminal (the terminal **10ba**) having the terminal ID of "01ba", when the request source terminal (the terminal **10bb**) and the destination terminal (the terminal **10ca**), which perform another video conference, start a video conference via the communication network **2** and thus image data is received with a delay by the destination terminal (the terminal **10ba**), the relay device **30** lowers an image quality of image data received until now from a high image quality to a moderate image quality. In this case, content of the changed quality

13

management table (see FIG. 10) is changed based on the quality information represented by the moderate image quality such that an image quality of image data to be relayed by the relay device 30 is lowered from the high image quality to the moderate image quality.

The data quality changing unit 35 is implemented according to an instruction from the CPU 201 illustrated in FIG. 8, an image quality of image data transmitted from a transmission source terminal is changed based on the changed content of the changed quality management table (see FIG. 10).

The storing/reading processing unit 39 is implemented by the HDD 205 illustrated in FIG. 8 according to an instruction from the CPU 201 illustrated in FIG. 8, and performs a process of storing various kinds of data in the storage unit 3000 or reading various kinds of data stored in the storage unit 3000.

Functional Configuration of Management System

The call management system 50 includes a transceiving unit 51, a terminal authenticating unit 52, a status managing unit 53, an extracting unit 54, a determining unit 55, a session managing unit 56, a quality deciding unit 57, a delay time managing unit 58, and a storing/reading processing unit 59. Each unit is any one of the components illustrated in FIG. 8 and is a function or a device that is operated and implemented according to an instruction from the CPU 201 that follows a program for the call management system 50 developed from the HD 204 onto the RAM 203. Further, the call management system 50 includes a storage unit 5000 that is constructed by the HD 204 illustrated in FIG. 8.

Relay Device Management Table

FIG. 11 is a conceptual diagram illustrating a relay device management table. In the storage unit 5000, a relay device management DB 5001 configured with a relay device management table illustrated in FIG. 11 is constructed. In the relay device management table, an operation status of each relay device 30, a reception date and time in which status information represented by the operation status is received by the call management system 50, an IP address of the relay device 30, and a maximum data call rate (Mbps) in the relay device 30 are managed in association with the relay device ID of each relay device 30. For example, the relay device management table illustrated in FIG. 11 represents that the operation status of a relay device 30a having the relay device ID of "111a" is "online", a date and time in which the status information is received by the call management system 50 is "13:00, Nov. 10, 2011", the IP address of the relay device 30a is "1.2.1.2", and the maximum data call rate in the relay device 30a is 100 Mbps.

Terminal Information Management Table

FIG. 12 is a conceptual diagram illustrating a terminal information management table. In the storage unit 5000, a terminal information management DB 5002 configured with a terminal information management table illustrated in FIG. 12 is constructed. In the terminal information management table, a password for authentication, a model number of the terminal 10, a serial number of the terminal 10, and a communication scheme of the terminal 10 are managed in association with each terminal ID of each of all terminals 10 managed by the call management system 50. For example, the terminal information management table illustrated in FIG. 12 represents that a terminal ID of a terminal 10aa is "01aa", a password is "aaaa", a model number is "9001", a serial number is "2001", and a communication scheme is "dedicated".

A communication scheme represented as "dedicated" is a communication scheme used by the dedicated terminal A illustrated in FIGS. 2 and 4. A communication scheme represented as "non-dedicated 1" is a communication scheme

14

used by the non-dedicated terminal D illustrated in FIG. 4. Further, a communication scheme represented as "non-dedicated 2" is a communication scheme other than communication schemes which are respectively used by the dedicated terminal A and the non-dedicated terminal D.

Terminal Status Management Table

FIG. 13 is a conceptual diagram illustrating a terminal status management table. In the storage unit 5000, a terminal status management DB 5003 configured with a terminal status management table illustrated in FIG. 13 is constructed. In the terminal status management table, a terminal name of each terminal 10 set as a destination, an operation status of each terminal 10, a reception date and time in which login request information (which will be described later) is received by the call management system 50, and an IP address of the terminal 10 are managed in association with the terminal ID of each terminal 10. For example, the terminal status management table illustrated in FIG. 13 represents that a terminal name of a terminal 10aa having the terminal ID of "01aa" is "AA terminal of Tokyo business office in Japan", the operation status is "online (call possible state)", a date and time in which login request information is received by the call management system 50 is "13:40, Nov. 10, 2011", and the IP address of the terminal 10aa is "1.2.1.3".

However, in the terminal status management table, the IP address of the terminal 10 other than the dedicated terminal A, that is, the IP address of the non-dedicated terminal D or the like is not a management target and thus not managed.

Destination List Management Table

FIG. 14 is a conceptual diagram illustrating a destination list management table. In the storage unit 5000, a destination list management DB 5004 configured with a destination list management table illustrated in FIG. 14 is constructed. In the destination list management table, terminals ID of destination terminals that are registered as a destination terminal candidate are managed in association with a terminal ID of a request source terminal that requests a start of a call. For example, the destination list management table illustrated in FIG. 14 represents that destination terminal candidates that can request a start of a call from a request source terminal (a terminal 10aa) having the terminal ID of "01aa" are a terminal 10ab having the terminal ID of "01ab", a terminal 10ba having the terminal ID of "01ba", and a terminal 10bb having the terminal ID of "01bb". As an arbitrary request source terminal requests the call management system 50 to add or delete, the destination terminal candidate is added or deleted and updated. In the terminal status management table (see FIG. 13), the IP address of the terminal 10 other than the dedicated terminal A is a management target, but in the destination list management table (see FIG. 14), the terminal ID of the terminal 10 other than the dedicated terminal A is a management target.

Session Management Table

FIG. 15 is a conceptual diagram illustrating a session management table. In the storage unit 5000, a session management DB 5005 configured with a session management table illustrated in FIG. 15, is constructed. In the session management table, the relay device ID of the relay device 30 used to relay image data and audio data, the terminal ID of the request source terminal, the terminal ID of the destination terminal, a reception delay time (ms) when image data is received in the destination terminal, and a reception date and time in which delay time information representing the delay time is transmitted from the destination terminal and received by the call management system 50 are managed in association with one another. For example, the session management table illustrated in FIG. 15 represents that the relay device 30a (the relay

device ID “111a”) relays image data and audio data between the request source terminal (a terminal **10aa**) having the terminal ID “01aa” and the destination terminal (a terminal **10ca**) having the terminal ID of “01ca”, and the delay time of image data at “14:00, Nov. 10, 2011” in the destination terminal (the terminal **10ca**) is 200 (ms). Further, when a call is performed between the two terminals **10**, the reception date and time of the delay time information may be managed based on the delay time information transmitted from the request source terminal other than the destination terminal. However, when a call is performed between three or more terminals **10**, the reception date and time of the delay time information is managed based on the delay time information transmitted from the terminal **10** at the reception side of image data and audio data.

Conversion Management Table

FIG. **16** is a conceptual diagram illustrating a conversion management table. In the storage unit **5000**, a conversion management DB **5006** configured with a conversion management table illustrated in FIG. **16** is constructed. In the conversion management table, the terminal ID of the non-dedicated terminal (including terminals of non-dedicated 1 and non-dedicated 2), the IP address of the conversion system **80**, and the IP address of the non-dedicated terminal are managed in association with one another.

Quality Management Table

FIG. **17** is a conceptual diagram illustrating a quality management table. In the storage unit **5000**, a quality management DB **5007** configured with a quality management table illustrated in FIG. **17** is constructed. In the quality management table, the delay time information representing the delay time of image data and image quality information representing an image quality of image data (a quality of an image) are managed in association with each other such that as the delay time (ms) of image data the request source terminal or the destination terminal increases, an image quality of image data to be relayed by the relay device **30** decreases.

Each Functional Configuration of Management System

Next, each functional configuration of the call management system **50** will be described in detail. In the following, when each functional configuration of the call management system **50** is described, a relation with a main component for implementing each functional configuration of the call management system **50** among the components illustrated in FIG. **8** will be also described.

The transceiving unit **51** is implemented by the network I/F **209** illustrated in FIG. **8** according to an instruction from the CPU **201** illustrated in FIG. **8**, and transmits or receives various kinds of data (or information) to or from another terminal, device, or system via the communication network **2**.

The terminal authenticating unit **52** is implemented according to an instruction from the CPU **201** illustrated in FIG. **8**, searches the terminal information management table (see FIG. **12**) using the terminal ID and the password included in the login request information received through the transceiving unit **51** as the search key, and performs terminal authentication by determining whether or not the same terminal ID and password are managed in the terminal information management table.

The status managing unit **53** is implemented according to an instruction from the CPU **201** illustrated in FIG. **8**, and manages the terminal ID of the request source terminal, the operation status of the request source terminal, the reception date and time in which login request information is received by the call management system **50**, and the IP address of the request source terminal to be stored in the terminal status management table (see FIG. **13**) in association with one

another in order to manage the operation status of the request source terminal that has made the login request. Further, when the user switches the power supply switch **109** of the terminal **10** from an on state to an off state, the status managing unit **53** changes the operation status of the terminal status management table (see FIG. **13**) representing the online state to the offline state based on the status information representing the power off transmitted from the terminal **10**.

The extracting unit **54** is implemented according to an instruction from the CPU **201** illustrated in FIG. **8**, and searches each management DB constructed in the storage unit **5000** using various kinds of search keys and extracts data (information) corresponding to the search keys as a search result.

For example, the extracting unit **54** searches the destination list management table (see FIG. **14**) using the terminal ID of the request source terminal that has made the login request as a key, and extracts the terminal ID of the destination terminal candidate that can perform a call with the request source terminal. Further, the extracting unit **54** searches the terminal status management table (see FIG. **13**) using the terminal ID of the destination terminal candidate as the search key and extracts the operation status for each terminal ID. Thus, the extracting unit **54** can acquire the operation status of the destination terminal candidate that can perform a call with the request source terminal that has made the login request.

Further, the extracting unit **54** searches the destination list management table (see FIG. **14**) using the terminal ID of the request source terminal that has made the login request as a key, and extracts the terminal ID of another request source terminal in which the terminal ID of the request source terminal is registered as the destination terminal candidate. Further, the extracting unit **54** searches the terminal status management table (see FIG. **13**) using the terminal ID as the search key, and acquires the operation status of the request source terminal that has made the login request.

Further, the extracting unit **54** searches the terminal status management table (see FIG. **13**) using the terminal ID of the terminal **10** received by the transceiving unit **51** as the search key, and extracts the IP address of the corresponding terminal **10**. Further, the extracting unit **54** searches the terminal information management table (see FIG. **12**) using the terminal ID of the terminal **10** received by the transceiving unit **51** as the search key, and extracts corresponding communication scheme information. Further, the extracting unit **54** searches the conversion management table (see FIG. **16**) using the terminal ID of the terminal **10** received by the transceiving unit **51** as the search key, and extracts the IP address of the corresponding conversion system **80** and the IP address of the terminal **10** related to the received terminal ID.

Further, the extracting unit **54** searches the quality management table (see FIG. **17**) using the delay time information received by the transceiving unit **51** as the search key, and extracts image quality information of corresponding image data.

Further, the extracting unit **54** searches the terminal status management table (see FIG. **13**) using the IP address of the destination terminal as the search key, and extracts the corresponding terminal ID.

Next, the determining unit **55** is implemented according to an instruction from the CPU **201** illustrated in FIG. **8**, and determines whether or not the communication scheme used by the terminal **10** is the communication scheme used by the dedicated terminal A.

The session managing unit **56** is implemented according to an instruction from the CPU **201** illustrated in FIG. **8**, and manages the relay device ID of the relay device **30** used to

relay call data, the terminal ID of the request source terminal, the terminal ID of the destination terminal, the reception delay time (ms) when image data is received by the destination terminal, and a reception date and time in which the delay time information representing the delay time is transmitted from the destination terminal and received by the call management system 50 to be stored in the session management table (see FIG. 15) of the storage unit 5000 in association with one another. Further, the session managing unit 56 generates a session ID used to establish a communication session.

The quality deciding unit 57 decides an image quality of image data to be relayed by the relay device 30 based on the image quality information of image data extracted by the extracting unit 54.

The delay time managing unit 58 is implemented according to an instruction from the CPU 201 illustrated in FIG. 8, and manages the delay time represented by the delay time information to be stored in a delay time field portion of a record including a terminal ID extracted by the extracting unit 54 in the session management table of the session management DB 5005 (see FIG. 15).

The storing/reading processing unit 59 is implemented by the HDD 205 illustrated in FIG. 8 according to an instruction from the CPU 201 illustrated in FIG. 8, and performs a process of storing various kinds of data in the storage unit 5000 or reading various kinds of data stored in the storage unit 5000.

Functional Configuration of Conversion System

The conversion system 80 includes a transceiving unit 81, a communication scheme converting unit 82, and a storing/reading processing unit 89. Each unit is any one of the components illustrated in FIG. 8 and is a function or a device that is operated and implemented according to an instruction from the CPU 201 that follows a program for the conversion system 80 developed from the HD 204 onto the RAM 203. Further, the conversion system 80 includes a storage unit 8000 that is constructed by the RAM 203 illustrated in FIG. 8 and/or the HD 204 illustrated in FIG. 8. The storage unit 8000 stores conversion rule data used to convert communication data.

Functional Configuration of Conversion System

Next, each functional configuration of the conversion system 80 will be described with reference to FIGS. 8 and 9. In the following, when each functional configuration of the conversion system 80 is described, a relation with a main component for implementing each functional configuration of the conversion system 80 among the components illustrated in FIG. 8 will be also described.

The transceiving unit 81 of the conversion system 80 illustrated in FIG. 9 is implemented by the network I/F 209 illustrated in FIG. 8 according to an instruction from the CPU 201 illustrated in FIG. 8, and transmits or receives various kinds of data (or information) to or from another terminal, device, or system via the communication network 2. Further, the transceiving unit 81 transmits session start instruction information to instruct a start of a communication session (a third communication session) to a destination represented by destination information transmitted by the relay device 30. In addition, an IP address, a uniform resource identifier (URI), or the like may be used as the destination information.

The communication scheme converting unit 82 mutually converts a communication scheme of call data transmitted from the request source terminal and communication scheme of call data transmitted from the destination terminal based on communication scheme conversion rule data stored in the storage unit 8000.

The storing/reading processing unit 89 is implemented by the HDD 205 illustrated in FIG. 8 according to an instruction

from the CPU 201 illustrated in FIG. 8, and performs a process of storing various kinds of data stored in the storage unit 8000 or reading various kinds of data stored in the storage unit 8000.

Process and Operation of Embodiment

Next, the first communication pattern in which a call is performed between the two dedicated terminals A will be described with reference to FIGS. 18 to 25. Specifically, the description will proceed with an example a call is performed between the terminal 10aa serving as the dedicated terminal A and the terminal 10ca serving as the dedicated terminal A. FIG. 18 is a sequence diagram illustrating a process of a preliminary step to start a call between terminals. In FIG. 18, various kinds of pieces of management information are transmitted and received according to the management communication session sei illustrated in FIG. 2.

First, when the user turns on the power supply switch 109 illustrated in FIGS. 6 and 7, the operation input receiving unit 12 illustrated in FIG. 9 receives the power-on input and turns on the power as illustrated in FIG. 18 (step S21). Then, when the power-on input is received, the login requesting unit 13 automatically transmits login request information representing a login request to the call management system 50 via the communication network 2 through the transceiving unit 11 (step S22). The login request information includes a terminal ID used to identify an own device serving as the request source terminal (the terminal 10aa) and a password. The terminal ID and the password are data which is read from the storage unit 1000 through the storing/reading processing unit 19 and transmitted to the transceiving unit 11. Further, when the login request information is transmitted from the request source terminal (the terminal 10aa) to the call management system 50, the call management system 50 at the reception side can detect the IP address of the request source terminal (the terminal 10aa) at the transmission side.

Next, the terminal authenticating unit 52 of the call management system 50 searches the terminal information management table (see FIG. 12) using the terminal ID and the password included in the login request information received through the transceiving unit 51 as the search key, and performs terminal authentication by determining whether or not the same terminal ID and password are managed in the terminal information management DB 5002 (step S23). Since the same terminal ID and password are managed by the terminal authenticating unit 52, when it is determined that there is a login request from the terminal 10 having an appropriate right of usage, the status managing unit 53 stores the terminal ID of the request source terminal (the terminal 10aa), the operation status, the reception date and time in which login request information is received, and the IP address of the request source terminal (the terminal 10aa) in the terminal status management table (see FIG. 13) in association with one another (step S24). Thus, in the terminal status management table (see FIG. 13), the operation status "online", the reception date and time "2011.11.10.13:40", and the IP address "1.2.1.3" of the request source terminal (the terminal 10aa) are managed in association with one another using the terminal ID "01aa".

Then, the transceiving unit 51 of the call management system 50 transmits authentication result information representing the authentication result obtained by the terminal authenticating unit 52 to the request source terminal (the terminal 10aa) that has made the login request via the communication network 2 (step S25). In the present embodiment, the description will proceed with an example in which the terminal authenticating unit 52 determines that the terminal 10 has an appropriate right of usage.

The extracting unit **54** of the call management system **50** searches the destination list management table (see FIG. **14**) using the terminal ID “01aa” of the request source terminal (the terminal **10aa**) that has made the login request as the search key, and extracts the terminal ID of the destination terminal candidate that can perform communication with the request source terminal (the terminal **10aa**) (step **S26**). Here, the terminal IDs (“01ab”, “01ba”, . . .) of the destination terminals (the terminals **10ab**, **10ba**, . . .) corresponding to the terminal ID “01aa” of the request source terminal (the terminal **10aa**) are assumed to be extracted.

Next, the extracting unit **54** searches the terminal status management table (see FIG. **13**) using the terminal IDs (“01ab”, “01ba”, . . .) of the destination terminal candidate extracted in step **S26** as the search key and acquires the operation statuses of the terminals (**10ab**, **10ba**, . . .) by reading the operation status (“offline”, “online”, . . .) of each terminal ID (step **S27**).

Next, the transceiving unit **51** transmits destination status information including the terminal IDs (“01ab”, “01ba”, . . .) used in step **S27** as the search key and the operation status (“offline”, “online”, . . .) of the corresponding destination terminals (the terminals **10ab**, **10ba**, . . .) to the request source terminal (the terminal **10aa**) via the communication network **2** (step **S28**). Thus, the request source terminal (the terminal **10aa**) can detect the current operation statuses (“offline”, “online”, . . .) of the terminals (**10ab**, **10ba**, . . .) serving as the destination terminal candidate that can perform communication with the request source terminal (the terminal **10aa**).

Further, the extracting unit **54** searches the destination list management table (see FIG. **14**) using the terminal ID “01aa” of the request source terminal (the terminal **10aa**) that has made the login request as the search key, and extracts the terminal IDs of other request source terminals in which the terminal ID “01aa” of the request source terminal (the terminal **10aa**) is registered as the destination terminal candidate (step **S29**). In the destination list management table illustrated in FIG. **14**, “01ba”, “01ca”, and “01da” are extracted as the terminal IDs of other request source terminal. In the following, for the sake of simplification of description, the description will proceed with the example in which “01ba”, “01ca”, and “01da” are extracted as the terminal IDs of other request source terminals.

Next, the extracting unit **54** searches the terminal status management table (see FIG. **13**) using the terminal ID “01aa” of the request source terminal (the terminal **10aa**) that has made the login request as the search key, and acquires the operation status of the request source terminal (the terminal **10aa**) that has made the login request (step **S30**). Then, the transceiving unit **51** transmits the destination status information including the terminal ID “01aa” of the request source terminal (the terminal **10aa**) acquired in step **S30** and the operation status “online” to the terminals (**10ba** and **10ca**) whose operation status is set to “online” in the terminal status management table (see FIG. **13**) among the terminals (**10ba**, **10ca**, and **10da**) related to the terminal IDs (“01ba”, “01ca”, and “01da”) extracted in step **S29** (step **S31-1**, **S31-2**). Further, when the transceiving unit **51** transmits the destination status information to the terminals (**10ba** and **10ca**), the IP address of the terminal managed in the terminal status management table (see FIG. **13**) is referred to on the basis of each of the terminal IDs (“01ba” and “01ca”). Thus, the terminal ID “01aa” of the request source terminal (the terminal **10aa**) that has made the login request and the operation status “online” can be transmitted to each of the other destination terminals (the terminals **10ba** and **10ca**) that can perform

communication with the request source terminal (the terminal **10aa**) that has made the login request as the destination.

The operation status of the terminal **10da** serving as the non-dedicated terminal D is not managed in the terminal status management table (see FIG. **13**), and thus the terminal ID “01aa” of the request source terminal (the terminal **10aa**) that has made the login request and the operation status “online” are hardly transmitted to the terminal **10da**. In other words, the non-dedicated terminal D side hardly use a service of acquiring the operation status of the dedicated terminal A.

Meanwhile, even in another terminal **10**, when the user turns on the power supply switch **109** illustrated in FIGS. **6** and **7** similarly to step **S21**, the operation input receiving unit **12** illustrated in FIG. **9** receives the power-on input, and the same process as the process of steps **S22** to **S31-1**, **S31-2** is performed, and thus a description thereof will not be made.

Next, the description will proceed with an example in which a call is performed between the two dedicated terminals A with reference to FIGS. **6** and **9** and FIGS. **19** to **22**. FIG. **19** is a sequence diagram illustrating a call start request.

Referring to FIG. **19**, first, when the user of the request source terminal (the terminal **10aa**) serving as the dedicated terminal A pushes down the operation button **108** illustrated in FIG. **6** and selects the destination terminal (the terminal **10ca**) serving as the dedicated terminal A that is the destination candidate, the operation input receiving unit **12** illustrated in FIG. **9** receives a request to start a call with the destination terminal (the terminal **10ca**) (step **S41**). Then, the transceiving unit **11** of the request source terminal (the terminal **10aa**) transmits start request information representing a call start desire to the call management system **50** (step **S42**). The start request information includes the terminal ID “01aa” of the request source terminal (the terminal **10aa**) and the terminal ID “01ca” of the destination terminal (the terminal **10ca**).

Then, the status managing unit **53** of the call management system **50** illustrated in FIG. **9** changes all the operation status field portions of the records respectively including the terminal ID “01aa” and the terminal ID “01ca” in the terminal status management table (see FIG. **13**) to “online (busy)” based on the terminal ID “01aa” of the request source terminal (the terminal **10aa**) and the terminal ID “01ca” of the destination terminal (the terminal **10ca**) included in the start request information (step **S43**). In this state, the request source terminal (the terminal **10aa**) and the destination terminal (the terminal **10ca**) do not start a call but becomes the busy state, and when another terminal **10** desires to make a call to the request source terminal (the terminal **10aa**) or the destination terminal (the terminal **10ca**), an alert tone or a display representing a so-called busy state is output.

Next, the session managing unit **56** of the call management system **50** generates a session ID used to establish a communication session (step **S44**). Then, the call management system **50** determines a communication scheme that can be used by the destination terminal (the terminal **10ca**) (step **S45**).

Here, step **S45** will be described in detail with reference to FIG. **20**. FIG. **20** is a flowchart illustrating a determination of a communication scheme.

Referring to FIG. **20**, the extracting unit **54** searches the terminal information management table (see FIG. **12**) based on the terminal ID “01ca” of the destination terminal (the terminal **10ca**) received by the transceiving unit **51**, and extracts a corresponding communication scheme information (step **S45-1**).

Next, the determining unit **55** determines whether or not a communication scheme represented by the extracted communication scheme information is a communication scheme that

can be used by the request source terminal (the terminal **10aa**) serving as the dedicated terminal A (step **S45-2**). Specifically, the determining unit **55** determines whether or not a communication scheme represented by the communication scheme information extracted by the extracting unit **54** is the same as a communication scheme that can be used by the request source terminal (the terminal **10aa**). The two communication schemes are determined to be the same as each other when the two communication schemes are the same in both of the call control scheme and the coding scheme, but the two communication schemes are determined to be not the same as each other when the two communication schemes are different in at least one of the call control scheme and the coding scheme.

Then, when the determining unit **55** determines that the two communication schemes are the same as each other (YES in step **S45-2**), the process proceeds to step **S61** illustrated in FIG. **21** which will be described later. Here, since the destination terminal (the terminal **10ca**) is the same dedicated terminal A as the request source terminal (the terminal **10aa**), the description will proceed starting from step **S61**. FIG. **21** is a sequence diagram illustrating a process of establishing a communication session before a call is performed between the two dedicated terminals A. In the present embodiment, the description will proceed with an example in which the relay device **30a** connected to the same LAN **2a** as in the request source terminal (the terminal **10aa**) is used among a plurality of relay devices **30**.

Referring to FIG. **21**, the call management system **50** transmits session initialization request information to initialize a communication session established by the relay device **30a** to the relay device **30a** through the transceiving unit **51** (step **S61**). The session initialization request information includes the session ID generated in step **S44** and the IP addresses of the request source terminal (the terminal **10aa**) and the destination terminal (the terminal **10ca**) managed by the terminal status management table (see FIG. **13**). The call management system **50** also transmits the IP address of the call management system **50** when transmitting the session initialization request information to the relay device **30a**. Thus, the transceiving unit **31** of the relay device **30a** receives the session initialization request information and the IP address of the call management system **50**.

Next, the transceiving unit **31** of the relay device **30a** initializes the communication session (step **S62**). Then, the transceiving unit **31** transmits the session start instruction information to instruct a start of the communication session to the request source terminal (the terminal **10aa**) (step **S63**). The session start instruction information includes the session ID transmitted from the call management system **50**. Further, the relay device **30a** also transmits the IP address of the relay device **30a** to the request source terminal (the terminal **10aa**) when transmitting the session start instruction information. Thus, the transceiving unit **11** of the request source terminal (the terminal **10aa**) receives the session start instruction information and the IP address of the relay device **30a**.

Similarly, the transceiving unit **31** transmits the session start instruction information to instruct a start of the communication session to the destination terminal (the terminal **10ca**) (step **S64**). The session start instruction information includes the session ID transmitted from the call management system **50**. Further, the relay device **30a** also transmits the IP address of the relay device **30a** to the destination terminal (the terminal **10ca**) when transmitting the session start instruction information. Thus, the transceiving unit **11** of the destination terminal (the terminal **10ca**) receives the session start instruction information and the IP address of the relay device **30a**.

As a result, the communication session (the first communication session **sed1** illustrated in FIG. **2**) to transmit and receive call data is established between the request source terminal (the terminal **10aa**) and the relay device **30a** based on step **S63** (step **S65-1**). Further, the communication session (the second communication session **sed2** illustrated in FIG. **2**) to transmit and receive call data is established between the relay device **30a** and the destination terminal (the terminal **10ca**) based on step **S64** (step **S65-2**).

Next, a process of transmitting and receiving call data in order to perform a call such as a video conference between the request source terminal and the destination terminal will be described with reference to FIG. **22**. FIG. **22** is a sequence diagram illustrating a process of transmitting and receiving call data between the two dedicated terminals A. In a process of transmitting a call data from the terminal **10aa** to the terminal **10ca** in one direction and a process of transmitting call data from the terminal **10ca** to the terminal **10aa** in a reverse direction, transmission and reception of call data, detection of the delay time which will be described later, or the like is performed by the same process, and thus the description will proceed with communication in one direction, and a description of communication in the reverse direction will not be made.

First, the request source terminal (the terminal **10aa**) transmits subject image data imaged by the imaging unit **14** and audio data of a sound input through the audio input unit **15a** to the relay device **30a** via the communication network **2** through the transceiving unit **11** using the communication session **sed1** (step **S81**). In the present embodiment, high-quality image data having the three resolutions, that is, the low resolution, the moderate resolution, and the high resolution illustrated in FIG. **3** and audio data are transmitted. Thus, the relay device **30a** receives the image data having the three resolutions and the audio data through the transceiving unit **31**. Then, the data quality verifying unit **33** verifies a quality of an image of image data to be relayed by searching the changed quality management table (see FIG. **10**) using the IP address “1.3.1.3” of the destination terminal (the terminal **10ca**) as the search key and extracting an image quality of corresponding image data to be relayed (step **S82**). In the present embodiment, since the verified image quality of image data is the “high image quality” and is the same as the image quality of the image data received by the transceiving unit **31**, the relay device **30a** transfers the image data with the same image quality and the audio data with the same audio quality to the destination terminal (the terminal **10ca**) using the communication session **sed2** (step **S83**). Thus, the destination terminal (the terminal **10ca**) receives the high-quality image data having the three resolutions, that is, the low resolution, the moderate resolution, the high resolution and the audio data through the transceiving unit **11**. Then, the display control unit **16** can cause an image to be displayed on the display **120** based on a combination of the image data having the three image qualities, and the audio output unit **15b** can output a sound based on the audio data.

Next, the delay detecting unit **17** of the destination terminal (the terminal **10ca**) detects the reception delay time of the image data received through the transceiving unit **11** at predetermined time intervals (for example, each second (step **S84**)). In the present embodiment, the following description will proceed with an example in which the delay time is 200 (ms).

The transceiving unit **11** of the destination terminal (the terminal **10ca**) transmits the delay time information representing the delay time “200 (ms)” to the call management system **50** via the communication network **2** through the

management communication session sei illustrated in FIG. 2 (step S85). Thus, the call management system 50 can detect the delay time and detect the IP address "1.3.1.3" of the terminal 10ca serving as the transmission source of the delay time information.

Next, the delay time managing unit 58 of the call management system 50 searches the terminal status management table (see FIG. 13) using the IP address "1.3.1.3" of the destination terminal (the terminal 10ca) as the search key and extracts the corresponding terminal ID "01ca", and manages the delay time "200 (ms)" represented by the delay time information to be stored in the delay time field portion in the record of the terminal ID "01ca" in the session management table (see FIG. 15) (step S86).

Next, the quality deciding unit 57 decides the image quality as the "moderate image quality" by searching the quality management table (see FIG. 17) using the delay time "200 (ms)" as the search key and extracting an image quality "moderate image quality" of corresponding image data (step S87).

Next, the transceiving unit 51 searches the relay device management table (see FIG. 11) using the relay device ID "111a" associated with the terminal ID "01ca" in the session management table (see FIG. 15) as the search key, and extracts the IP address "1.2.1.2" of the corresponding relay device 30a (step S88). Then, the transceiving unit 51 transmits the quality information representing the image quality "moderate image quality" of the image data decided in step S87 to the relay device 30a via the communication network 2 through the management communication session sei (step S89). The quality information includes the IP address "1.3.1.3" of the destination terminal (the terminal 10ca) used as the search key in step S86. Thus, in the relay device 30a, the changed quality managing unit 34 manages the IP address "1.3.1.3" of the transmission destination terminal 10 (here, the terminal 10ca) and the image quality "moderate image quality" of the image data to be relayed to be stored in the changed quality management table (see FIG. 10) in association with each other (step S90).

Next, similarly to step S81, the request source terminal (the terminal 10aa) transmits the high-quality image data having the three resolutions, that is, the low resolution, the moderate resolution, the high resolution and the audio data to the relay device 30a through the first communication session sed1 (step S91). Thus, in the relay device 30a, similarly to step S82, the data quality verifying unit 33 verifies a quality of an image of image data to be relayed by searching the changed quality management table (see FIG. 10) using the IP address "1.3.1.3" of the destination terminal (the terminal 10ca) as the search key and extracting an image quality "moderate image quality" of corresponding image data to be relayed (step S92). In the present embodiment, since the verified image quality of image data is the "moderate image quality" and is lower than the image quality "high image quality" of the image data received by the transceiving unit 31, the data quality changing unit 35 suppresses an image quality of image data from the "high image quality" to the "moderate image quality" and changes the quality of the image of the image data (step S93).

Then, the transceiving unit 31 transmits the image data in which an image quality of image data has been changed to the "moderate image quality" and the audio data in which a sound quality of a sound has not been changed to the destination terminal (the terminal 10ca) via the communication network 2 through the second communication session sed2 (step S94). Thus, the destination terminal (the terminal 10ca) receives image data of a moderate image quality having two resolutions, that is, the low resolution, the moderate resolution and the audio data through the transceiving unit 11. Then, the

display control unit 16 can cause an image to be displayed on a display 120ca based on a combination of the image data having the two resolutions, and the audio output unit 15b can output a sound based on the audio data.

As described above, when a reception delay occurs in the destination terminal (the terminal 10ca) that receives image data, the relay device 30a changes a quality of an image, and thus that the user who attends a call such as a video conference does not feel uncomfortable. In other words, a service to cope with a reception delay of image data can be provided between the two dedicated terminals A.

Next, the second communication pattern in which a call is performed between the dedicated terminal A (an example of a first communication terminal) and the non-dedicated terminal D (an example of a second communication terminal) will be described with reference to FIG. 20 and FIGS. 23 to 25. Specifically, a call is performed between the terminal 10aa serving as the dedicated terminal A and the terminal 10da serving as the non-dedicated terminal D. Further, the present embodiment will be described in connection with an example in which as a communication scheme used by the terminal 10aa, a call control scheme is a protocol of an instant messenger (or a protocol extended from a protocol of an instant messenger), and a coding scheme is the SVC, whereas as a communication scheme used by the terminal 10da, a call control scheme is the SIP, and a coding scheme is the AVC.

Further, in FIGS. 18 and 19, the second communication pattern is different from the first communication pattern in that the destination terminal (the terminal 10da) selects the destination in step S41 rather than the destination terminal (the terminal 10ca), and thus the terminal ID of the destination terminal used for transmission and reception or a search is also changed, and thus a description thereof will not be made. Then, the description will proceed from when the determining unit 55 determines that the two communication schemes are not the same in step S45-2 illustrated in FIG. 20 (NO).

In the case of the second communication pattern, the extracting unit 54 searches the conversion management table (see FIG. 16) based on the terminal ID "01da" of the destination terminal (the terminal 10da) received through the transceiving unit 51, and extracts the corresponding IP address "1.3.2.2" of the conversion system 80 and the IP address "1.3.2.3" of the destination terminal (the terminal 10da) (step S45-3). Then, the process proceeds to step S101 illustrated in FIG. 23 which will be described later.

FIG. 23 is a sequence diagram illustrating a process of establishing a communication session before a call is performed between the dedicated terminal A and the non-dedicated terminal D. Referring to FIG. 23, the call management system 50 transmits session initialization request information to initialize a communication session established by the relay device 30a to the relay device 30a through the transceiving unit 51 (step S101). The session initialization request information includes the session ID and the IP addresses of the request source terminal (the terminal 10aa), the conversion system 80, and the destination terminal (the terminal 10da). Of these, the session ID is the ID generated in step S44. The IP address of the request source terminal (the terminal 10aa) is managed in the terminal status management table (see FIG. 13). Further, the IP addresses of the conversion system 80 and the destination terminal (the terminal 10da) are the IP addresses extracted in step S45-3.

The call management system 50 also transmits the IP address of the call management system 50 when transmitting the session initialization request information to the relay device 30a. Thus, the transceiving unit 31 of the relay device

30a receives the session initialization request information and the IP address of the call management system 50.

Next, the transceiving unit 31 of the relay device 30a initializes the communication session (step S102). Then, the transceiving unit 31 transmits the session start instruction information to instruct a start of the communication session to the request source terminal (the terminal 10aa) (step S103). The session start instruction information includes the session ID transmitted from the call management system 50. Further, the relay device 30a also transmits the IP address of the relay device 30a to the request source terminal (the terminal 10aa) when transmitting the session start instruction information. Thus, the transceiving unit 11 of the request source terminal (the terminal 10aa) receives the session start instruction information and the IP address of the relay device 30a.

Similarly, the transceiving unit 31 transmits the session start instruction information to instruct a start of the communication session to the conversion system 80 (step S104). The session start instruction information includes the session ID transmitted from the call management system 50 and the IP address of the destination terminal (the terminal 10da). In other words, the transceiving unit 31 transmits the session start instruction information and transmits the IP address of the destination terminal (the terminal 10da). Further, the relay device 30a also transmits the IP address of the relay device 30a to the conversion system 80 when transmitting the session start instruction information. Thus, the transceiving unit 81 of the conversion system 80 receives the session start instruction information and the IP address of the relay device 30a.

Further, in the second communication pattern, the transceiving unit 81 of the conversion system 80 transmits the session start instruction information to instruct a start of the communication session to the destination terminal (the terminal 10da) (step S105). The session start instruction information includes the session ID transmitted from the call management system 50. Further, the conversion system 80 also transmits the IP address of the conversion system 80 to the destination terminal (the terminal 10da) when transmitting the session start instruction information. Thus, the transceiving unit 11 of the destination terminal (the terminal 10da) receives the session start instruction information and the IP address of the conversion system 80.

As a result, the communication session (the first communication session sed11 illustrated in FIG. 4) to transmit and receive call data is established between the request source terminal (the terminal 10aa) and the relay device 30a based on step S103 (step S106-1). Further, the communication session (the second communication session sed12 illustrated in FIG. 4) to transmit and receive call data is established between the relay device 30a and the conversion system 80 based on step S104 (step S106-2). Further, the communication session (the third communication session sed13 illustrated in FIG. 4) to transmit and receive call data is established between the conversion system 80 and the destination terminal (the terminal 10da) based on step S105 (step S106-3).

Next, a process of transmitting and receiving call data in order to perform a call such as a video conference between the request source terminal and the destination terminal will be described with reference to FIG. 24. FIG. 24 is a sequence diagram illustrating a process of transmitting and receiving call data between the dedicated terminal A and the non-dedicated terminal D.

First, the request source terminal (the terminal 10aa) transmits subject image data imaged by the imaging unit 14 and audio data of a sound input through the audio input unit 15a to the relay device 30a via the communication network 2

through the transceiving unit 11 using the communication session sed11 (step S121). In the second communication pattern, similarly to the first communication pattern, high-quality image data having the three resolutions, that is, the low resolution, the moderate resolution, and the high resolution illustrated in FIG. 3 and audio data are transmitted. Thus, the relay device 30a receives the image data having the three resolutions and the audio data through the transceiving unit 31.

Next, the relay device 30a transmits the high-quality image data having the three resolutions and the audio data to the conversion system 80 via the communication network 2 through the transceiving unit 31 using the communication session sed12 (step S122). Thus, the conversion system 80 receives the image data having the three resolutions and the audio data through the transceiving unit 81.

Next, the communication scheme converting unit 82 of the conversion system 80 converts the communication scheme of the image data having the three resolutions from the communication scheme used by the request source terminal (the terminal 10aa) to the communication scheme used by the destination terminal (the terminal 10da) based on the conversion rule data stored in the storage unit 8000 in advance (step S123). Here, as the conversion of the communication scheme is performed, the image data having the three resolutions (the high resolution, the moderate resolution, and the low resolution) illustrated FIG. 3 is converted into the image data having one resolution (the moderate resolution) illustrated in FIG. 5.

Next, the conversion system 80 transmits the audio data and the moderate-resolution image data to the terminal 10da via the communication network 2 through the transceiving unit 81 using the communication session sed13 (step S124). Thus, the destination terminal (the terminal 10da) receives the audio data and the moderate-resolution image data through the transceiving unit 11.

Meanwhile, when image data and audio data are transmitted from the destination terminal (the terminal 10da) to the request source terminal (the terminal 10aa), the destination terminal (the terminal 10da) transmits the audio data and the moderate-resolution image data to the conversion system 80 via the communication network 2 through the transceiving unit 11 using the communication session sed13 as illustrated in FIG. 24 (step S125). Thus, the conversion system 80 receives the audio data and the moderate-resolution image data through the transceiving unit 81.

Next, the communication scheme converting unit 82 of the conversion system 80 converts the communication scheme of the audio data and the moderate-resolution image data from the communication scheme used by the destination terminal (the terminal 10da) to the communication scheme used by the request source terminal (the terminal 10aa) based on the conversion rule data stored in the storage unit 8000 in advance (step S126).

FIG. 25 is a conceptual diagram illustrating an image quality of image data converted by the conversion system. As the communication scheme is converted in step S126, the image data having one resolution (the moderate resolution) illustrated in FIG. 5 is converted into low-resolution image data illustrated in (a) of FIG. 25, moderate-resolution image data illustrated in (c) of FIG. 25, and image data with a low moderate resolution which is a moderate resolution between the moderate resolution and the low resolution as illustrated in (b) of FIG. 25. In other words, even when moderate-resolution image data is transmitted from the destination terminal (the terminal 10da) serving as the non-dedicated terminal D, the conversion system 80 does not convert the moderate-resolution image data into the high-resolution

image data transmitted in step S122, and the moderate-resolution image data transmitted from the destination terminal (the terminal 10da) has the maximum resolution and is converted into image data having the three resolutions, that is, the moderate resolution, the moderate resolution between the moderate resolution and the low resolution, and the low resolution.

Next, the conversion system 80 transmits the audio data and the image data having the three resolutions to the relay device 30a via the communication network 2 through the transceiving unit 81 using the communication session sed12 (step S127). Thus, the relay device 30a receives the audio data and the image data having the three resolutions through the transceiving unit 31. Then, the relay device 30a transmits the audio data and the image data having the three resolutions to the request source terminal (the terminal 10aa) via the communication network 2 through the transceiving unit 31 using the communication session sed11 (step S128). Thus, the request source terminal (the terminal 10aa) receives the audio data and the image data having the three resolutions through the transceiving unit 11.

Main Effects of Present Embodiment

As described above, according to the present embodiment, the session initialization request information to be transmitted from the call management system 50 to the relay device 30a includes the IP addresses of the request source terminal, the conversion system 80, and the destination terminal. Thus, the relay device 30a can transmit the session start instruction information to the IP address of the request source terminal and transmit the session start instruction information including the IP address of the destination terminal to the IP address of the conversion system 80. As a result, the conversion system 80 can transmit the session start instruction information to the IP address of the destination terminal.

As the session initialization request information is transmitted by the call management system 50 as described above, the first communication session sed11 can be established between the relay device 30 and the request source terminal, the second communication session sed12 can be established between the relay device 30 and the conversion system 80, and the third communication session sed13 can be established between the conversion system 80 and the destination terminal. Thus, even when the request source terminal and the destination terminal use different call schemes from each other, the communication schemes of call data are mutually converted by the conversion system 80, and there is an effect by which a call can be implemented.

Supplement of Embodiment

The above description has been made in connection with the example in which the request source terminal or the dedicated terminal A is used as an example of the first communication terminal, and the destination terminal or the non-dedicated terminal D is used as an example of the second communication terminal. However, the present invention is not limited to this example, and the destination terminal or the non-dedicated terminal D may be used as an example of the first communication terminal, and the request source terminal or the dedicated terminal A may be used as an example of the second communication terminal.

The call data is an example of communication data. The communication data includes a text or image file data. The terminal 10 is an example of the communication terminal. For example, an information processing terminal that transmits and receives the file data as well as a terminal that performs a call may be used as the communication terminal. Further, the call management system 50 is an example of the communication management system. For example, a file management

system that manages processing of the file data as well as a system that manages a call may be used as the communication management system. In addition, the call system 1 is an example of the communication system. The communication system is constructed by the communication terminal and the communication management system.

In the above embodiment, the call management system 50 manages communication scheme information through the terminal information management table (see FIG. 12). However, the present invention is not limited to this example, and the request source terminal may manage communication scheme information of the destination terminal.

As a result, in step S42 illustrated in FIG. 19, the request source terminal (the terminal 10aa) can transmit the start request information including the terminal ID of the request source terminal and the terminal ID of the destination terminal and the communication scheme information to the call management system 50. In this case, in step S41 of FIG. 19, the display control unit 16 may cause a selection screen used to select the non-dedicated terminal as the destination of a call to be displayed on the display 120 and encourages the user to make a selection.

Then, when the destination is selected on the selection screen, in step S42 of FIG. 19, the request source terminal (the terminal 10aa) transmits the start request information including information (communication scheme information) representing that the destination terminal ID is the non-dedicated terminal to the call management system. In this case, the call management system 50 needs not execute step S45-1 of FIG. 20, determines that the communication scheme of the destination terminal is not "dedicated" based on the communication scheme information included in the start request information (NO in step S45-2 of FIG. 20), and causes the process to proceed to step S45-3 of FIG. 20.

In addition, the user needs not necessarily make a selection on the selection screen. For example, when the user already knows the destination information of the destination terminal, the operation input receiving unit 12 may receive an input of the destination information (the IP address or the like) of the destination terminal from the user. In this case, in step S42, the request source terminal transmits the start request information including the destination information of the destination terminal and the information (the communication scheme information) representing that the destination terminal is "non-dedicated" rather than the terminal ID of the destination terminal to the call management system 50. Then, at the call management system 50 side, in step S45-2, the determining unit 55 determines that the destination terminal represented by the destination information is not "dedicated", and then causes the process to proceed to step S45-3. Further, in step S45-3, the extracting unit 54 extracts the destination information of the conversion system 80 based on the destination information of the non-dedicated terminal, and causes the process to proceed to step S101.

Further, the terminal ID may be stored in the terminal 10 in advance at the time of factory shipment or may be input by the user.

In the above-described embodiment, the relay device 30, the call management system 50, the conversion system 80, the program providing system 90, and the maintenance system 100 may be constructed by a single computer or may be constructed by a plurality of computers in which respective portions (functions or devices) are divided and arbitrarily allocated. When the program providing system 90 is constructed by a single computer, a program transmitted by the program providing system 90 may be divided into a plurality of modules and then transmitted or may be transmitted with-

out any division. Further, when the program providing system **90** is constructed by a plurality of computers, transmission from each computer may be performed in a state in which the program is divided into a plurality of modules.

In the present embodiment, as an example in which call control schemes of terminals are different from each other, a protocol of an instant messenger (or a protocol extended from a protocol of an instant messenger) and the SIP have been described, but the present invention is not limited to this combination as long as call control schemes of terminals are different from each other. For example, a combination of a protocol of an instant messenger (or a protocol extended from a protocol of an instant messenger) and H.323 may be used. Further, a combination of a protocol of an instant messenger and a protocol extended from a protocol of an instant messenger may be used.

Further, all a recording medium such as a CD-ROM storing each program of the above-described embodiment, the HD **204** storing the program, and the program providing system **90** including the HD **204** may be provided inside or outside the country as a program product.

Further, in the above-described embodiment, a quality of an image is managed by the changed quality management table illustrated in FIG. **10** and the quality management table illustrated in FIG. **17**, focusing on the resolution of an image of image data as an example of a quality of an image of image data to be relayed by the relay device **30**, and the present invention is not limited to this example. As another example of a quality, a quality may be managed focusing on the depth of an image quality of image data, a sampling frequency in a sound of audio data, or a bit length in a sound of audio data. Further, the audio data may be divided into three kinds of resolutions (the high resolution, the moderate resolution, and the low resolution) and then transmitted and received.

In FIGS. **11**, **13**, and **15**, the reception date and time is managed, but the present invention is not limited to this example, and it is preferable that at least a reception time of the reception date and time be managed.

Further, in the above-described embodiment, the IP address of the relay device **30** is managed in FIG. **11**, and the IP address of the terminal **10** is managed in FIG. **13**, but the present invention is not limited to this example. When destination information specifies the relay device **30** on the communication network **2** or destination information specifies the terminal **10** on the communication network **2**, each fully qualified domain name (FQDN) may be managed. In this case, an IP address corresponding to the FQDN is acquired by a known domain name system (DNS) server.

Further, in the above-described embodiment, the video conference system has been described as an example of the call system **1**, but the present invention is not limited to this example, and the call system **1** may be a telephone system such as an internet protocol (IP) telephone or an Internet telephone. Further, the call system **1** may be a car navigation system. In this case, for example, one terminal **10** corresponds to a car navigation device mounted in a vehicle, and the other terminal **10** corresponds to a management terminal or a management server of a management center that manages a car navigation device, or a car navigation device mounted in another device. Further, the call system **1** may be a communication system of a mobile telephone. In this case, for example, the terminal **10** corresponds to a mobile phone.

In addition, in the above-described embodiment, image data and audio data have been described as an example of the call data, but the call data is not limited to this example, call data may be haptic (touch) data. In this case, sensory information generated by the user's touch at one terminal side is

transmitted to the other terminal side. Further, the call data may be smell data. In this case, smelling (bad smelling) at one terminal is transmitted to the other terminal side. Furthermore, the call data is preferably at least one of image data, audio data, haptic data, and smell data.

In addition, the above-described embodiment has been described in connection with the example in which a video conference is performed by the call system **1**, but the present invention is not limited to this example, and the call system **1** may be used for a meeting, an ordinary conversation between family members or friends, or provision of information in one direction.

Although the invention has been described with respect to specific embodiments for a complete and clear disclosure, the appended claims are not to be thus limited but are to be construed as embodying all modifications and alternative constructions that may occur to one skilled in the art that fairly fall within the basic teaching herein set forth.

The invention claimed is:

1. An apparatus comprising:

a memory that stores first address information of a first communication terminal and second address information of a second communication terminal;

a receiver that receives first start request information to start communication between the first communication terminal and the second communication terminal using a first communication method or second start request information to start communication between the first communication terminal and a third communication terminal, from the first communication terminal, the third communication terminal transmitting and receiving communication data using a second communication method different from the first communication method; and

a transmitter that:

transmits, to a relay device, first session request information including at least the first address information of the first communication terminal and the second address information of the second communication terminal to establish a session for transmitting and receiving communication data based on the first communication method between the first communication terminal and the second communication terminal through the relay device when the receiver receives the first start request information, and

transmits, to the relay device, second session request information including at least the first address information of the first communication terminal and third address information of the third communication terminal to transmit and receive communication data between the first communication terminal and the third communication terminal through a conversion system that performs mutual conversion between the first communication method and the second communication method as well as through the relay device to which the transmitter transmits the first session request information, when the receiver receives the second start request information,

wherein the second session request information is used in order to allow the relay device to instruct the conversion system to start the session.

2. The apparatus according to claim **1**, further comprising: processing circuitry that extracts address information to be transmitted to the relay device, based on the received first start request information or the received second start request information, wherein

31

the memory stores identification information for identifying the third communication terminal, another instance of address information of the conversion system, and the third address information of the third communication terminal in association with one another, 5

the receiver receives the identification information of the third communication terminal when receiving the second start request information from the first communication terminal, and

the processing circuitry searches the memory based on the received identification information of the third communication terminal and extracts the another instance of address information of the conversion system and the third address information of the third communication terminal. 10

3. The apparatus according to claim 2, wherein the processing circuitry determines whether a communication method used by each communication terminal is a predetermined communication method, 15

the memory stores communication method information representing the communication method used by each communication terminal in association with identification information of each communication terminal, 20

the processing circuitry searches the memory based on the received identification information of the third communication terminal, and extracts a corresponding communication method information, 25

the processing circuitry determines whether the communication method represented by the extracted corresponding communication method information is the communication method used by the first communication terminal, and 30

when the processing circuitry determines that the communication method represented by the extracted corresponding communication method information is not the communication method used by the first communication terminal, the processing circuitry searches the memory based on the identification information of the third communication terminal received by the receiver, and extracts the another instance of address information of the conversion system and the second address information of the second communication terminal. 40

4. The apparatus according to claim 3, wherein the communication method is represented by a call control method for establishing or disconnecting a connection with a destination of a communication and a coding method for converting the communication data into IP packets, and 45

when the communication method represented by the corresponding communication method information extracted by the processing circuitry is different from the communication method used by the first communication terminal in at least one of the call control method and the coding method, the processing circuitry determines that the communication method represented by the corresponding communication method information extracted by the processing circuitry is not the communication method used by the first communication terminal. 50

5. The apparatus according to claim 1, wherein the memory stores address information representing a destination of the first communication terminal in association with identification information for identifying the first communication terminal, 60

the receiver receives the identification information of the first communication terminal from the first communication terminal when receiving the first start request information, and 65

32

the processing circuitry searches the memory based on the received identification information of the first communication terminal, and extracts a corresponding destination information of the first communication terminal.

6. The apparatus according to claim 1, wherein the first communication method and the second communication method include at least a session control protocol and a video coding method, and 5

the first communication method and the second communication method differ in at least one of the session control protocol and the video coding method.

7. The apparatus according to claim 6, wherein the video coding method for the first communication method is H.264/Scalable Video Coding (SVC), and the video coding method for the second communication method is H.264/Advanced Video Coding (AVC). 10

8. The apparatus according to claim 1, wherein the first communication method and the second communication method differ in both of a session control protocol and a video coding method.

9. The apparatus according to claim 1, wherein the second session request information further includes another instance of address information of the conversion system. 15

10. The apparatus according to claim 1, wherein the second session request information further includes another instance of address information of the conversion system, and 20

the first session request information does not include the another instance of address information of the conversion system.

11. A method comprising: 25

storing, using a memory, first address information of a first communication terminal and second address information of a second communication terminal;

receiving, using a receiver, first start request information to start communication between the first communication terminal and the second communication terminal using a first communication method or second start request information to start communication between the first communication terminal and a third communication terminal, from the first communication terminal, the third communication terminal transmitting and receiving communication data using a second communication method different from the first communication method; 30

transmitting, using a transmitter to a relay device, first session request information including at least the first address information of the first communication terminal and the second address information of the second communication terminal to establish a session for transmitting and receiving communication data based on the first communication method between the first communication terminal and the second communication terminal through the relay device when the receiver receives the first start request information; and 35

transmitting, using the transmitter to the relay device, second session request information including at least the first address information of the first communication terminal and third address information of the third communication terminal to transmit and receive communication data between the first communication terminal and the third communication terminal through a conversion system that performs mutual conversion between the first communication method and the second communication method as well as through the relay device to which the transmitter transmits the first session request information, when the receiver receives the second start request information, 40

wherein the second session request information is used in order to allow the relay device to instruct the conversion system to start the session.

12. The method according to claim **11**, further comprising: extracting, using processing circuitry, address information 5 to be transmitted to the relay device, based on the received first start request information or the received second start request information;

storing identification information for identifying the third communication terminal, another instance of address 10 information of the conversion system, and the third address information of the third communication terminal in association with one another;

receiving, using the receiver, the identification information of the third communication terminal when receiving the 15 second start request information from the first communication terminal; and

searching, using the processing circuitry, the memory based on the received identification information of the 20 third communication terminal, and extracting the another instance of address information of the conversion system and the third address information of the third communication terminal.

13. The method according to claim **12**, further comprising: determining, using the processing circuitry, whether a 25 communication method used by each communication terminal is a predetermined communication method;

storing communication method information representing the communication method used by each communication 30 terminal in association with identification information of each communication terminal;

searching, using the processing circuitry, the memory based on the received identification information of the 35 third communication terminal, and extracting a corresponding communication method information;

determining, using the processing circuitry, whether the 40 communication method represented by the extracted corresponding communication method information is the communication method used by the first communication terminal; and

when the processing circuitry determines that the communication method represented by the extracted corresponding 45 communication method information is not the communication method used by the first communication terminal, searching, using the processing circuitry, the memory based on the identification information of the third communication terminal received by the receiver, and extracting the another instance of address information of the conversion system and the second address 50 information of the second communication terminal.

14. The method according to claim **13**, wherein the communication method is represented by a call control method for establishing or disconnecting a connection with a destination of a communication and a coding method for converting the communication data into IP packets, the method 55 further comprising:

when the communication method represented by the corresponding communication method information extracted by the processing circuitry is different from the 60 communication method used by the first communication terminal in at least one of the call control method and the coding method, determining, using the processing circuitry, that the communication method represented by the corresponding communication method information extracted by the processing circuitry is not the communication 65 method used by the first communication terminal.

15. The method according to claim **11**, further comprising: storing address information representing a destination of the first communication terminal in association with 5 identification information for identifying the first communication terminal;

receiving, using the receiver, the identification information of the first communication terminal from the first communication terminal when receiving the first start 10 request information; and

searching, using the processing circuitry, the memory based on the received identification information of the first communication terminal, and extracting a corresponding destination information of the first communication 15 terminal.

16. The method according to claim **11**, wherein the first communication method and the second communication method include at least a session control protocol and a video coding method, and

the first communication method and the second communication method differ in at least one of the session control 20 protocol and the video coding method.

17. The method according to claim **16**, wherein the video coding method for the first communication method is H.264/Scalable Video Coding (SVC), and the video coding method for the second communication 25 method is H.264/Advanced Video Coding (AVC).

18. The method according to claim **11**, wherein the first communication method and the second communication method differ in both of a session control protocol and a video coding method.

19. The method according to claim **11**, wherein the second session request information further includes another instance of address information of the conversion system.

20. A non-transitory computer-readable storage medium storing computer-readable instructions that, when executed by a computer, cause the computer to execute a method comprising:

storing first address information of a first communication terminal and second address information of a second 40 communication terminal;

receiving first start request information to start communication between the first communication terminal and the second communication terminal using a first communication method or second start request information to start communication between the first communication terminal and a third communication terminal, from the first communication terminal, the third communication terminal transmitting and receiving communication data using a second communication method different from the first communication method;

transmitting, to a relay device, first session request information including at least the first address information of the first communication terminal and the second address information of the second communication terminal to establish a session for transmitting and receiving communication data based on the first communication method between the first communication terminal and the second communication terminal through the relay device when a receiver receives the first start request information; and

transmitting, to the relay device, second session request information including at least the first address information of the first communication terminal and third address information of the third communication terminal to transmit and receive communication data between the first communication terminal and the third communication terminal through a conversion system that per-

35

forms mutual conversion between the first communication method and the second communication method as well as through the relay device to which the transmitter transmits the first session request information, when the receiver receives the second start request information, wherein the second session request information is used in order to allow the relay device to instruct the conversion system to start the session.

21. The non-transitory computer-readable storage medium according to claim **20**, further comprising:

extracting address information to be transmitted to the relay device, based on the received first start request information or the received second start request information;

storing identification information for identifying the third communication terminal, another instance of address information of the conversion system, and the third address information of the third communication terminal in association with one another;

receiving the identification information of the third communication terminal when receiving the second start request information from the first communication terminal; and

searching a memory based on the received identification information of the third communication terminal, and extracting the another instance of address information of the conversion system and the third address information of the third communication terminal.

22. The non-transitory computer-readable storage medium according to claim **21**, further comprising:

determining whether a communication method used by each communication terminal is a predetermined communication method;

storing communication method information representing the communication method used by each communication terminal in association with identification information of each communication terminal;

searching the memory based on the received identification information of the third communication terminal, and extracting a corresponding communication method information;

determining whether the communication method represented by the extracted corresponding communication method information is the communication method used by the first communication terminal; and

when the communication method represented by the extracted corresponding communication method information is determined not to be the communication method used by the first communication terminal, searching the memory based on the identification information of the third communication terminal received by the receiver, and extracting the another instance of address information of the conversion system and the second address information of the second communication terminal.

23. The non-transitory computer-readable storage medium according to claim **22**, wherein the communication method is represented by a call control method for establishing or disconnecting a connection with a destination of a communication and a coding method for converting the communication data into IP packets, further comprising:

when the communication method represented by the extracted corresponding communication method information is different from the communication method used by the first communication terminal in at least one of the call control method and the coding method, determining that the communication method represented by

36

the extracted corresponding communication method information is not the communication method used by the first communication terminal.

24. The non-transitory computer-readable storage medium according to claim **20**, further comprising:

storing address information representing a destination of the first communication terminal in association with identification information for identifying the first communication terminal;

receiving the identification information of the first communication terminal from the first communication terminal when receiving the first start request information; and searching the memory based on the received identification information of the first communication terminal, and extracting a corresponding destination information of the first communication terminal.

25. The non-transitory computer-readable storage medium according to claim **20**, wherein

the first communication method and the second communication method include at least a session control protocol and a video coding method, and

the first communication method and the second communication method differ in at least one of the session control protocol and the video coding method.

26. The non-transitory computer-readable storage medium according to claim **25**, wherein

the video coding method for the first communication method is H.264/Scalable Video Coding (SVC), and the video coding method for the second communication method is H.264/Advanced Video Coding (AVC).

27. The non-transitory computer-readable storage medium according to claim **20**, wherein

the first communication method and the second communication method differ in both of a session control protocol and a video coding method.

28. The non-transitory computer-readable storage medium according to claim **20**, wherein the second session request information further includes another instance of address information of the conversion system.

29. A system comprising:

a first communication terminal;

a second communication terminal that transmits and receives communication data with the first communication terminal using a first communication method;

a memory that stores first address information of the first communication terminal and second address information of the second communication terminal;

a receiver that receives first start request information to start communication between the first communication terminal and the second communication terminal using the first communication method or second start request information to start communication between the first communication terminal and a third communication terminal, from the first communication terminal, the third communication terminal transmitting and receiving communication data using a second communication method different from the first communication method; and

a transmitter that:

transmits, to a relay device, first session request information including at least the first address information of the first communication terminal and the second address information of the second communication terminal to establish a session for transmitting and receiving communication data based on the first communication method between the first communication terminal and the second communication terminal

through the relay device when the receiver receives
the first start request information, and
transmits, to the relay device, second session request infor-
mation including at least the first address information of
the first communication terminal and third address infor- 5
mation of the third communication terminal to transmit
and receive communication data between the first com-
munication terminal and the third communication ter-
minal through a conversion system that performs mutual
conversion between the first communication method 10
and the second communication method as well as
through the relay device to which the transmitter trans-
mits the first session request information, when the
receiver receives the second start request information,
wherein the second session request information is used in 15
order to allow the relay device to instruct the conversion
system to start the session.

* * * * *