



US009270808B2

(12) **United States Patent**
Chan et al.

(10) **Patent No.:** **US 9,270,808 B2**
(45) **Date of Patent:** **Feb. 23, 2016**

(54) **CUSTOMIZED HARDWARE SELECTION FOR A MOBILE PHONE**

(71) Applicant: **Elwha LLC**, Bellevue, WA (US)

(72) Inventors: **Alistair K. Chan**, Bainbridge Island, WA (US); **Philip A. Eckhoff**, Kirkland, WA (US); **Roderick A. Hyde**, Redmond, WA (US); **Jordin T. Kare**, San Jose, CA (US); **David B. Tuckerman**, Lafayette, CA (US); **Lowell L. Wood, Jr.**, Bellevue, WA (US)

(73) Assignee: **Elwha LLC**, Bellevue, WA (US)

(*) Notice: Subject to any disclaimer, the term of this patent is extended or adjusted under 35 U.S.C. 154(b) by 0 days.

(21) Appl. No.: **14/730,739**

(22) Filed: **Jun. 4, 2015**

(65) **Prior Publication Data**

US 2015/0319292 A1 Nov. 5, 2015

Related U.S. Application Data

(60) Continuation of application No. 14/631,975, filed on Feb. 26, 2015, now Pat. No. 9,083,819, which is a continuation of application No. 13/765,505, filed on Feb. 12, 2013, now Pat. No. 8,971,969, which is a division of application No. 13/340,463, filed on Dec. 29, 2011, now Pat. No. 8,391,934.

(51) **Int. Cl.**

H04M 1/725 (2006.01)

H04M 1/02 (2006.01)

(Continued)

(52) **U.S. Cl.**

CPC **H04M 1/72575** (2013.01); **G06F 1/1656** (2013.01); **H04M 1/0202** (2013.01); **H04M 1/026** (2013.01); **H04M 1/0254** (2013.01);

(Continued)

(58) **Field of Classification Search**

CPC . H04M 1/0202; H04M 1/0254; H04M 1/026; H04M 1/0266; H04M 1/04; H04M 1/72575

See application file for complete search history.

(56) **References Cited**

U.S. PATENT DOCUMENTS

5,832,371 A * 11/1998 Thornton H04B 1/38
361/814

5,848,152 A 12/1998 Slipy et al.

(Continued)

FOREIGN PATENT DOCUMENTS

WO WO 00/59247 A1 10/2000

OTHER PUBLICATIONS

Dawson, Tom; "ZTE Displays Modular Phone Concept Eco-Mobius off at CES 2014; To Compete with Motorola's Project Ara"; Androidheadlines.com; Bearing a date of Jan. 9, 2014, Printed on Aug. 28, 2014; pp. 1-7; locate at: androidheadlines.com/2014/01/zte-displays-modular-phone-concept-eco-mobius-off-at-ces-2014-to-compete-with-motorolas-project-ara.html.

(Continued)

Primary Examiner — Kashif Siddiqui

(57) **ABSTRACT**

A computerized method of customizing hardware for a mobile phone is provided. The method includes receiving shell selection information from a user input device, identifying a set of hardware components, the set of hardware components generated based on a compatibility between the hardware components and the shell selection information, and outputting the identified set of compatible hardware components.

35 Claims, 20 Drawing Sheets

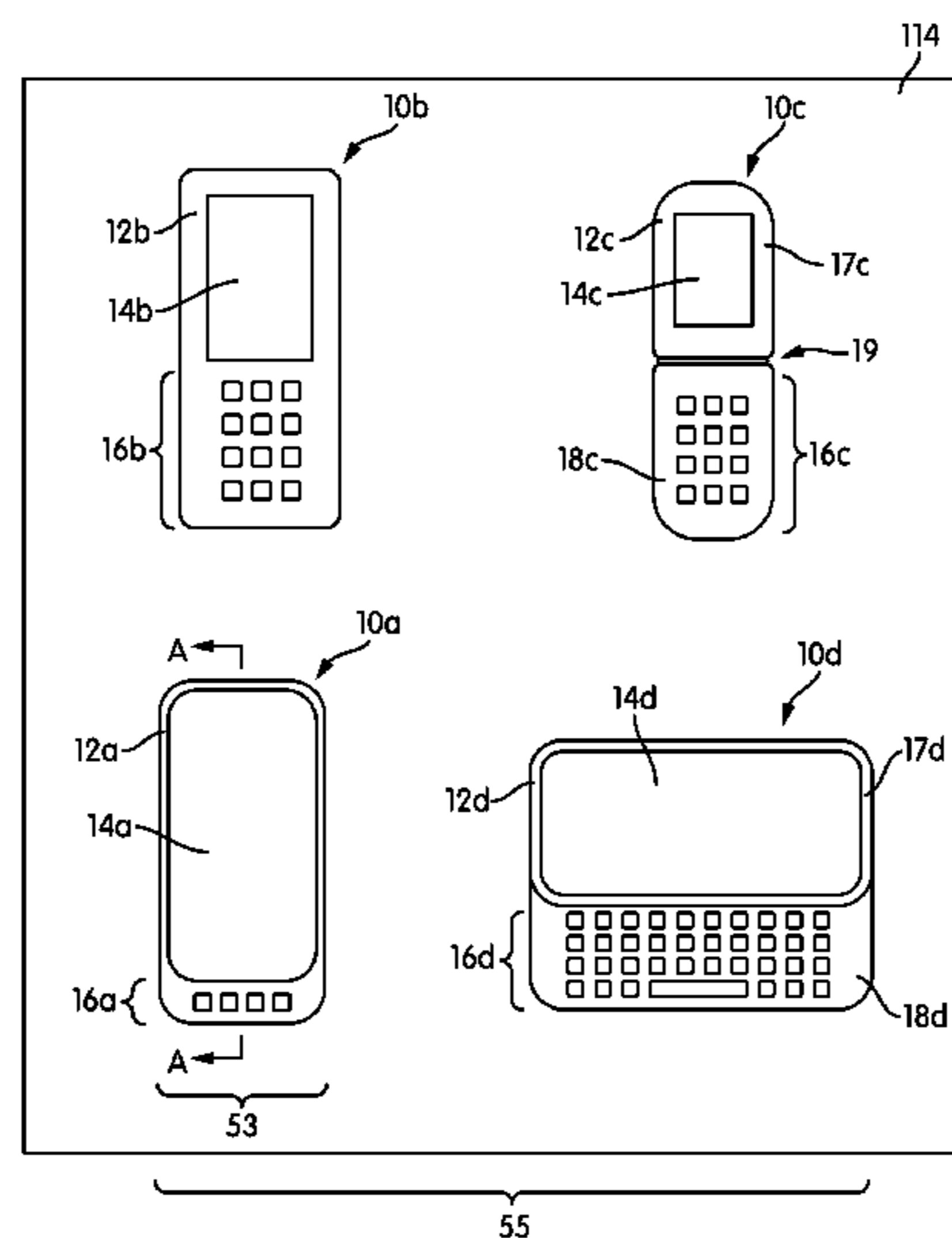

- | | | |
|------|-----------------------------------------------------------------------------------------------------------------------|----------------------------------------------------------------------------------------------------------------------------------------------------------------------------------|
| (51) | Int. Cl.
<i>H04M 1/04</i> (2006.01)
<i>H04W 88/02</i> (2009.01)
<i>G06F 1/16</i> (2006.01) | 2011/0165919 A1 7/2011 Weiss et al.
2011/0175747 A1 7/2011 Small et al.
2011/0177852 A1 7/2011 Jain et al.
2011/0256905 A1* 10/2011 Ryan G06F 1/1632
455/556.1 |
| (52) | U.S. Cl.
CPC <i>H04M 1/0266</i> (2013.01); <i>H04M 1/04</i>
(2013.01); <i>H04W 88/02</i> (2013.01) | 2011/0282476 A1 11/2011 Hegemier et al.
2013/0153658 A1* 6/2013 Hopper G06F 1/1684
235/440 |

(56) **References Cited**

U.S. PATENT DOCUMENTS

6,171,138 B1 *	1/2001	Lefebvre	H04M 1/0262 429/97
6,356,543 B2	3/2002	Hall et al.	
7,092,519 B1	8/2006	Lindholm	
7,194,285 B2	3/2007	Tom	
7,414,855 B1 *	8/2008	Arnold	H04M 1/0283 361/752
7,921,553 B2	4/2011	Wojack et al.	
7,937,751 B2	5/2011	Tom	
8,180,395 B2	5/2012	Moran et al.	
8,391,934 B1 *	3/2013	Chan	H04M 1/0254 455/550.1
8,909,307 B2	12/2014	Chan et al.	
2003/0119543 A1	6/2003	Kfoury et al.	
2004/0137664 A1	7/2004	Elazar et al.	
2004/0204131 A1	10/2004	Parker	
2004/0259587 A1 *	12/2004	Chadha	H04M 1/0254 455/550.1
2005/0170872 A1	8/2005	Vuori et al.	
2006/0168573 A1	7/2006	Clark et al.	
2008/0034075 A1	2/2008	Luinstra et al.	
2008/0198018 A1	8/2008	Hartley	
2009/0156252 A1 *	6/2009	Harris	H04M 1/72575 455/557
2009/0158446 A1 *	6/2009	Harris	G06F 1/1613 726/35
2010/0065630 A1	3/2010	Spencer, II	
2011/0082711 A1 *	4/2011	Poeze	A61B 5/14532 705/3

OTHER PUBLICATIONS

“Eco-Mobius”; Tactus.com; Created on Aug. 28, 2014, Printed on Aug. 28, 2014; p. 1; located at: blog.tactus.com/wp-content/uploads/2014/03/W0201311056079224542711.png.

Kharif; “Transforming the Cell Phone”; Bloomberg Businessweek; Bearing a date of Feb. 7, 2008; pp. 1-2.

“MDK-Project Ara”; Projectara.com; Created on Aug. 28, 2014, Printed on Aug. 28, 2014; pp. 1-2; located at: projectara.com/mdk/.

PCT International Search Report; Application No. PCT/US 12/71208; Mar. 5, 2013; pp. 1-2.

“Phonebloks: A Phone Worth Keeping”; Phonebloks.com; Created on Aug. 28, 2014, Printed on Aug. 28, 2014; pp. 1-5; located at: phonebloks.com/en.

“Phonebloks”; Phonebloks.com; Created on Aug. 28, 2014, Printed on Aug. 28, 2014; pp. 1-10; located at: phonebloks.com/en/about.

SlashGear; “Modular ‘Lobster’ Concept Has Snap-On GPS, Camera”; located at : slashgear.com/modular-lobster-concept-has-snap-on-gps-camera-057180; Bearing a date of Sep. 21, 2011; pp. 1-9.

“Springboard Expansion Slot”; Wikipedia; Bearing a date of Mar. 13, 2013, Printed on Sep. 3, 2014; pp. 1-6; located at: en.wikipedia.org/wiki/Springboard_Expansion_Slot.

textually.org; “Bug Labs Modular Cellphone”; located at: textually.org/textually/archives/2007/12/018177.htm; Bearing a date of Dec. 7, 2007; p. 1.

European Search Report; European App. No. EP 12 86 3105; bearing a date of Nov. 12, 2015 (received by our Agent on Nov. 16, 2015); pp. 1-2.

* cited by examiner

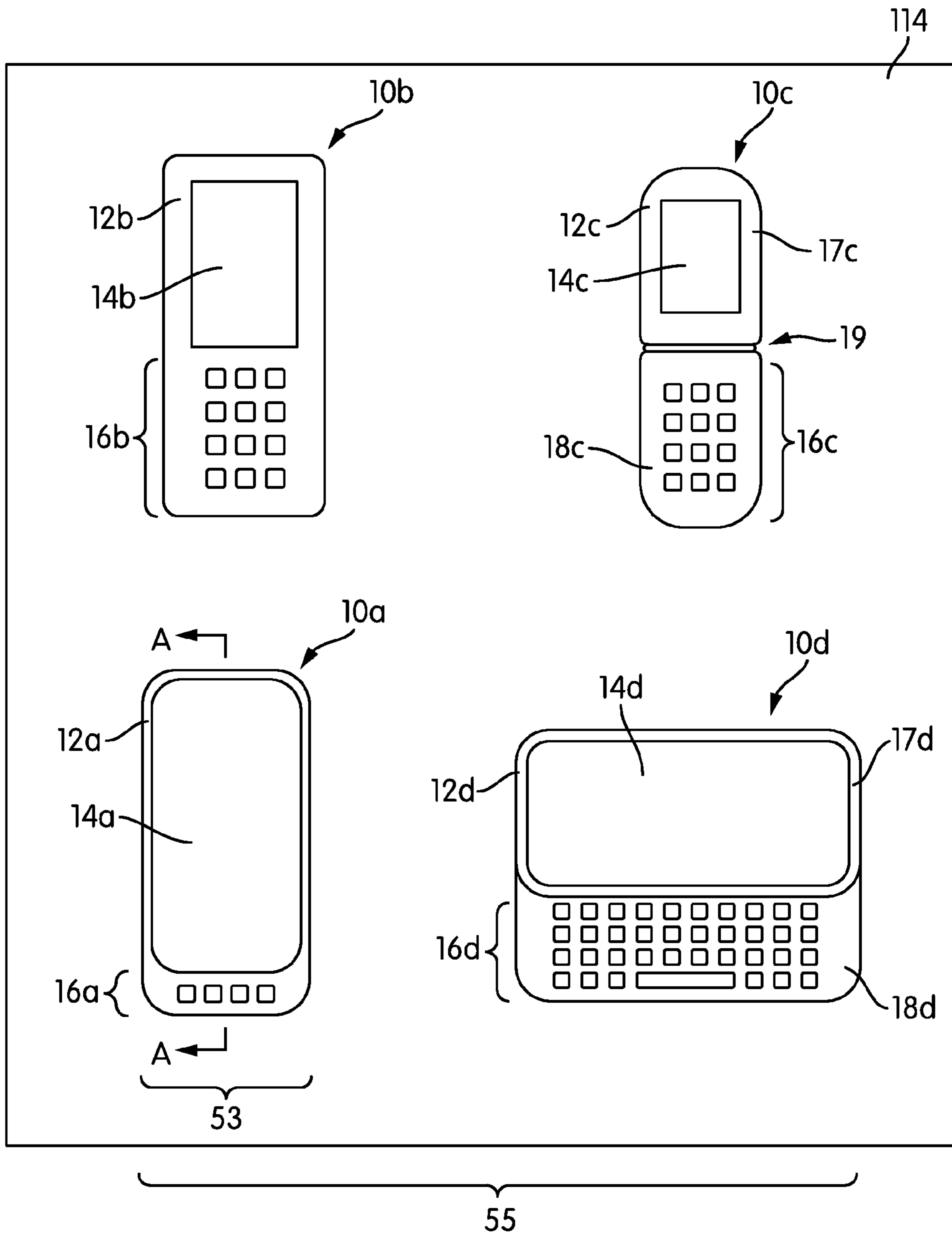

FIG. 1

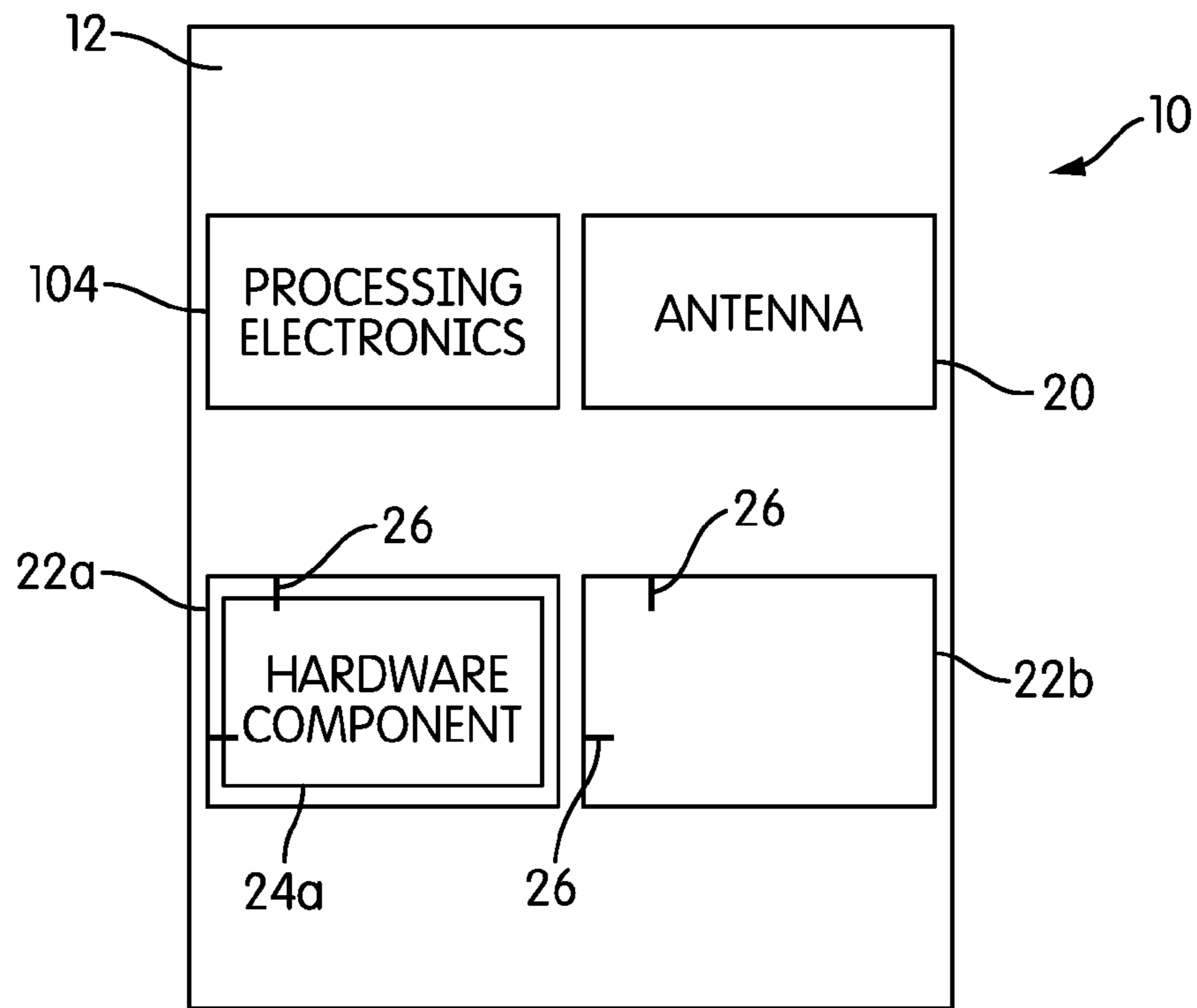

FIG. 2A

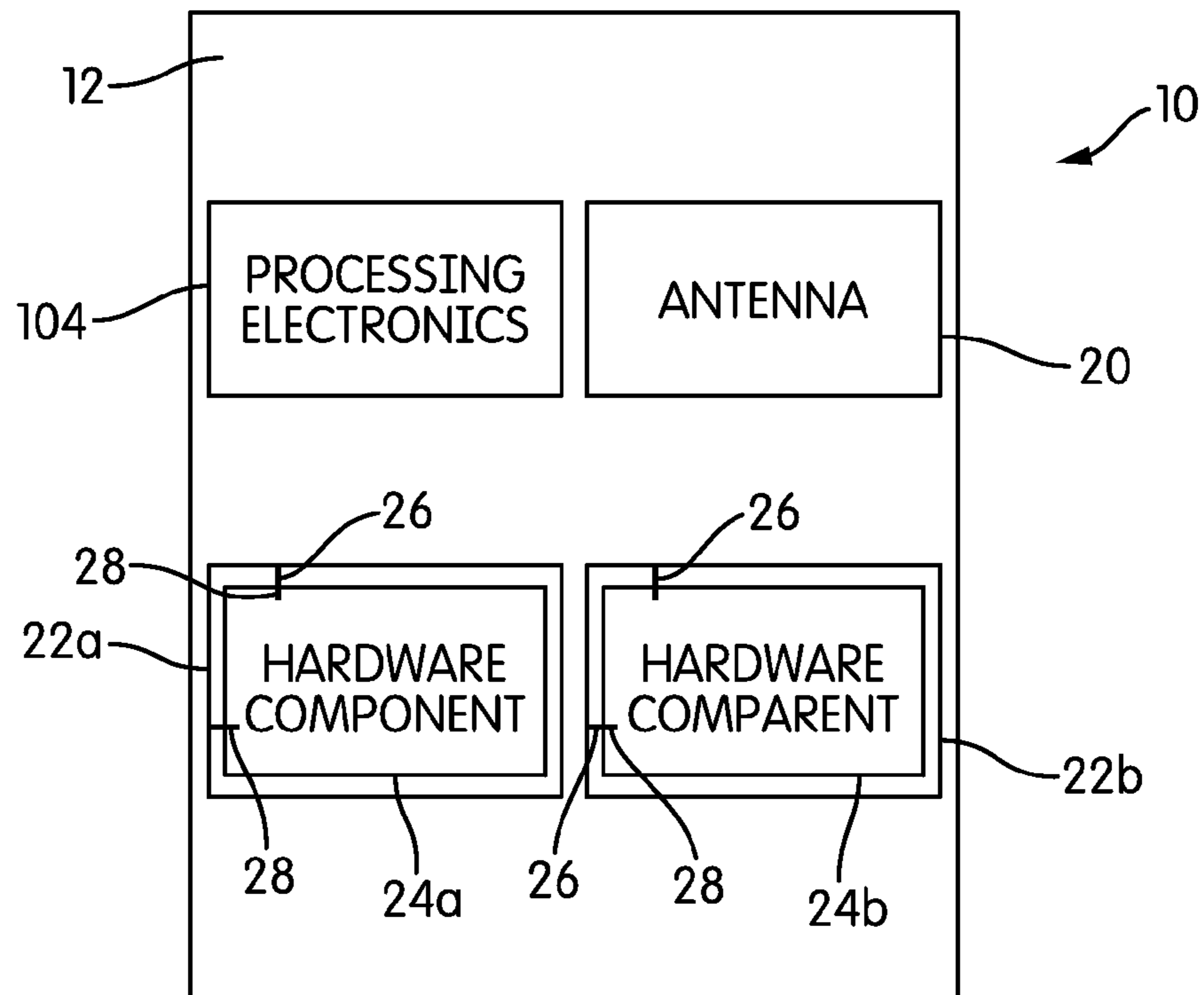

FIG. 2B

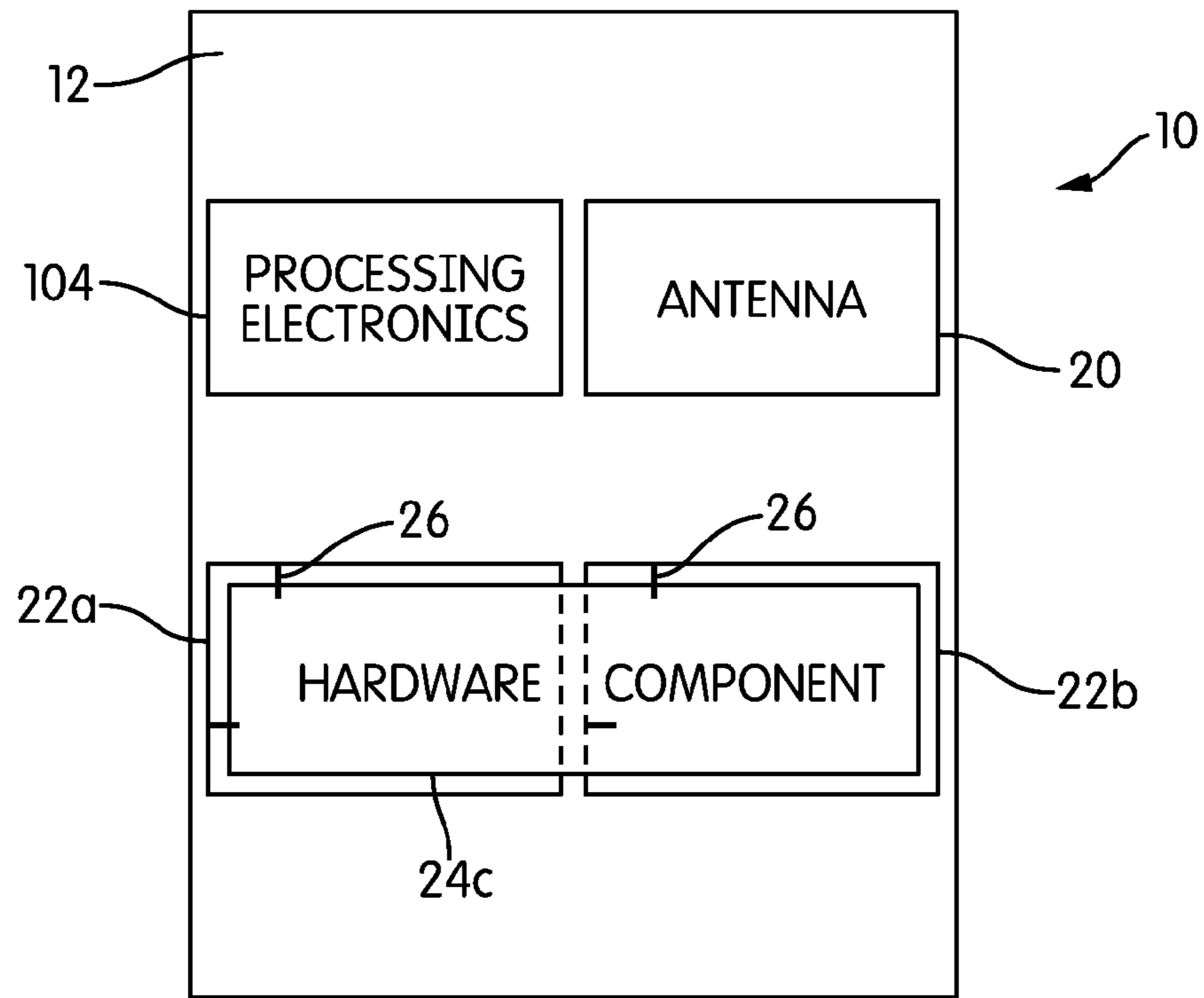

FIG. 2C

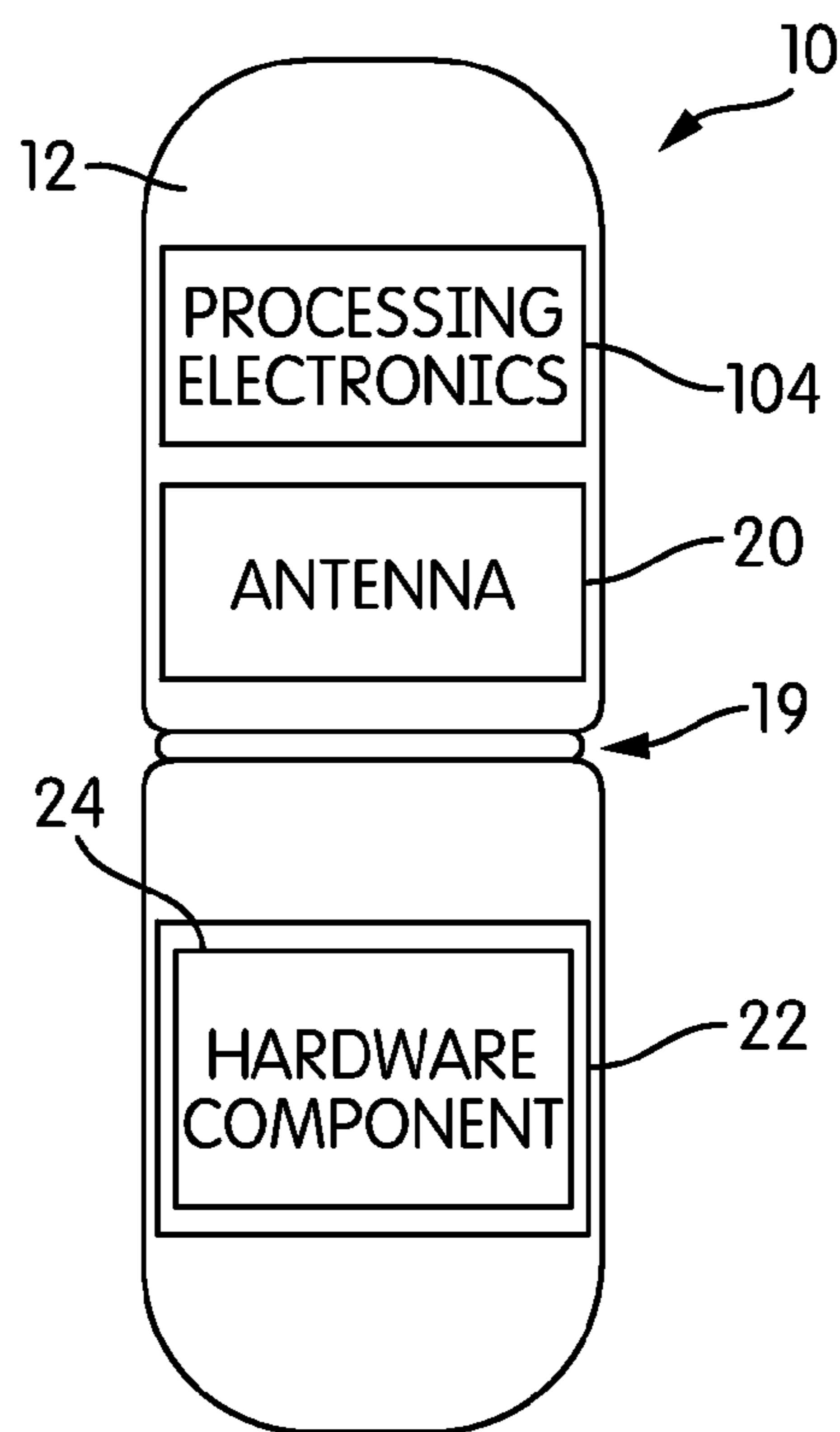

FIG. 3

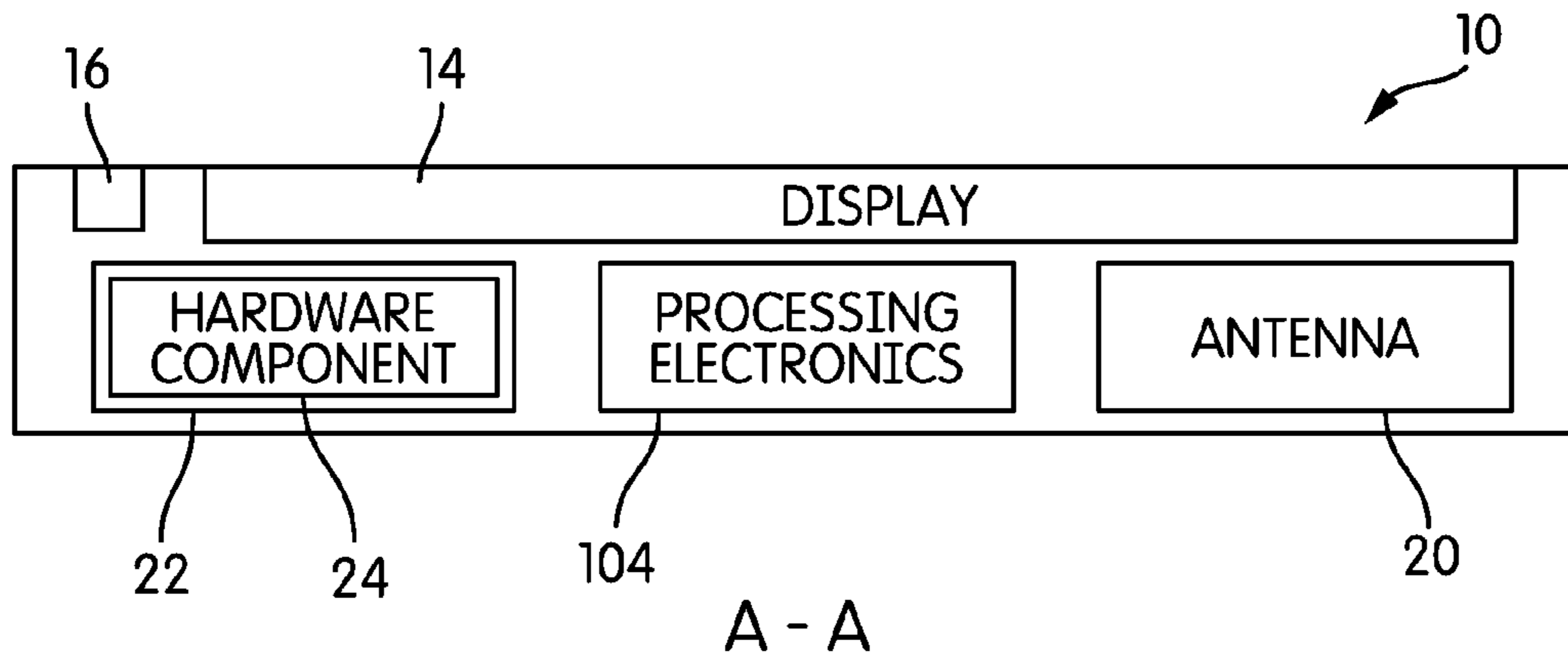

FIG. 4A

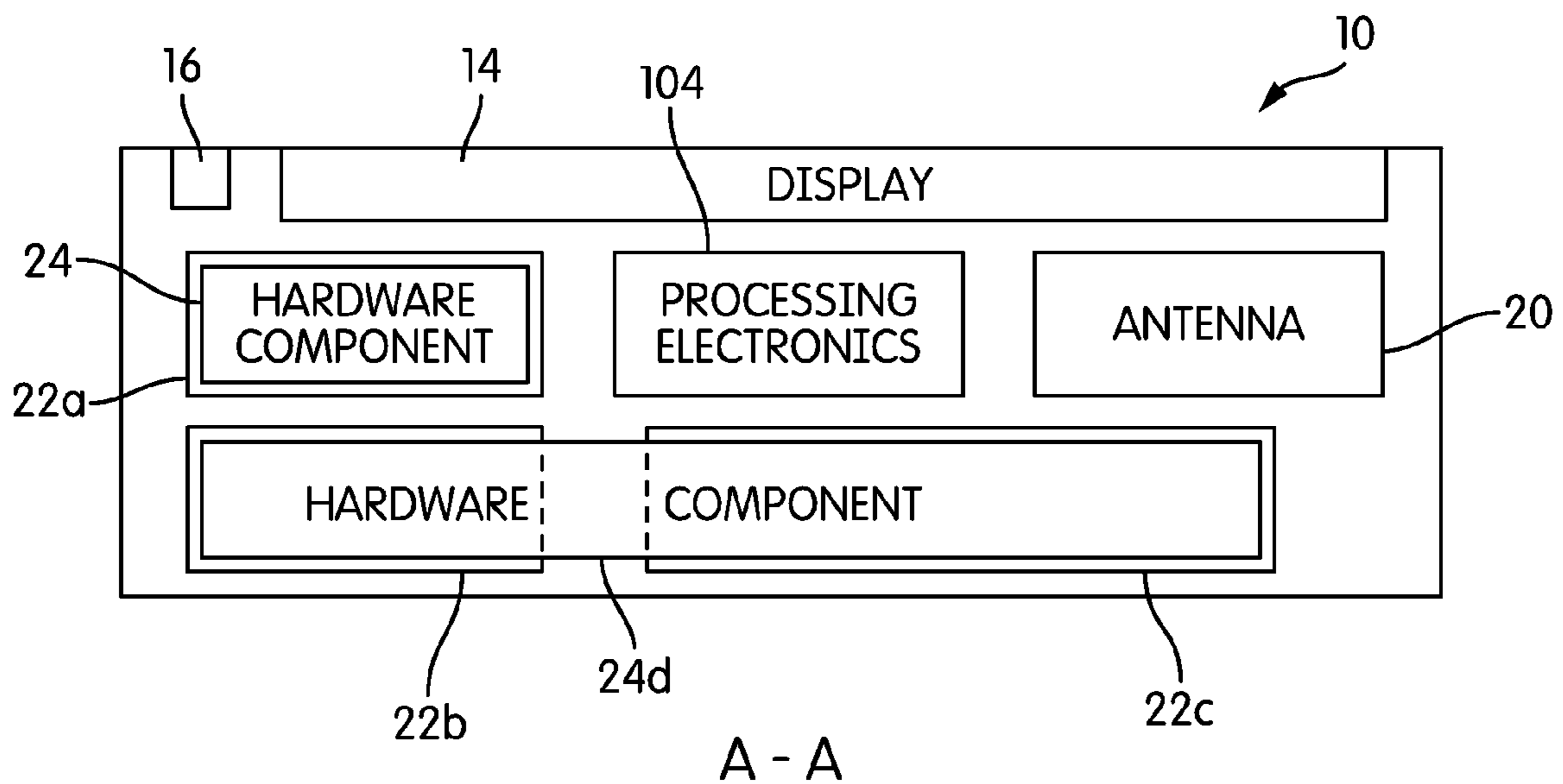

FIG. 4B

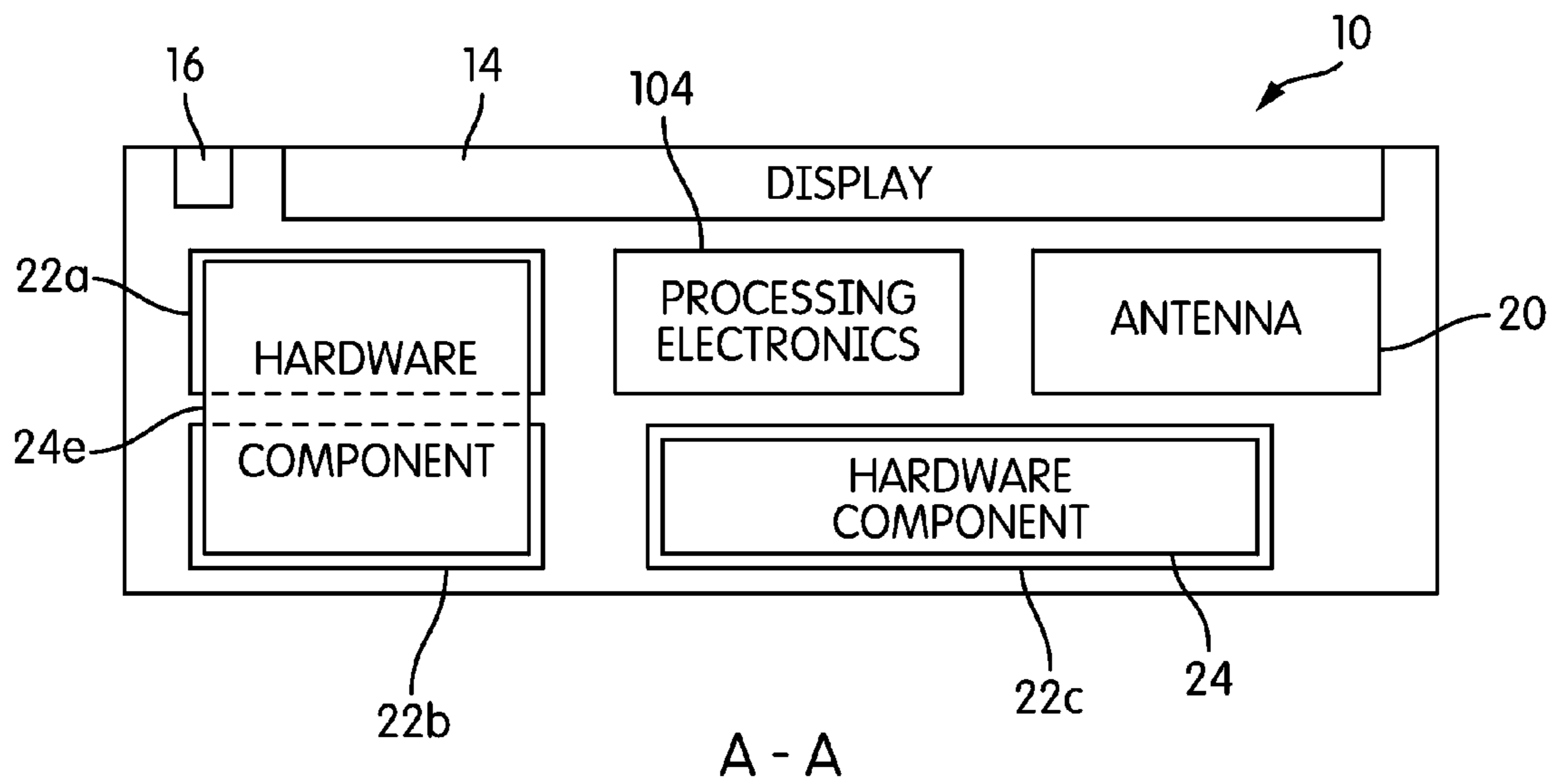

FIG. 4C

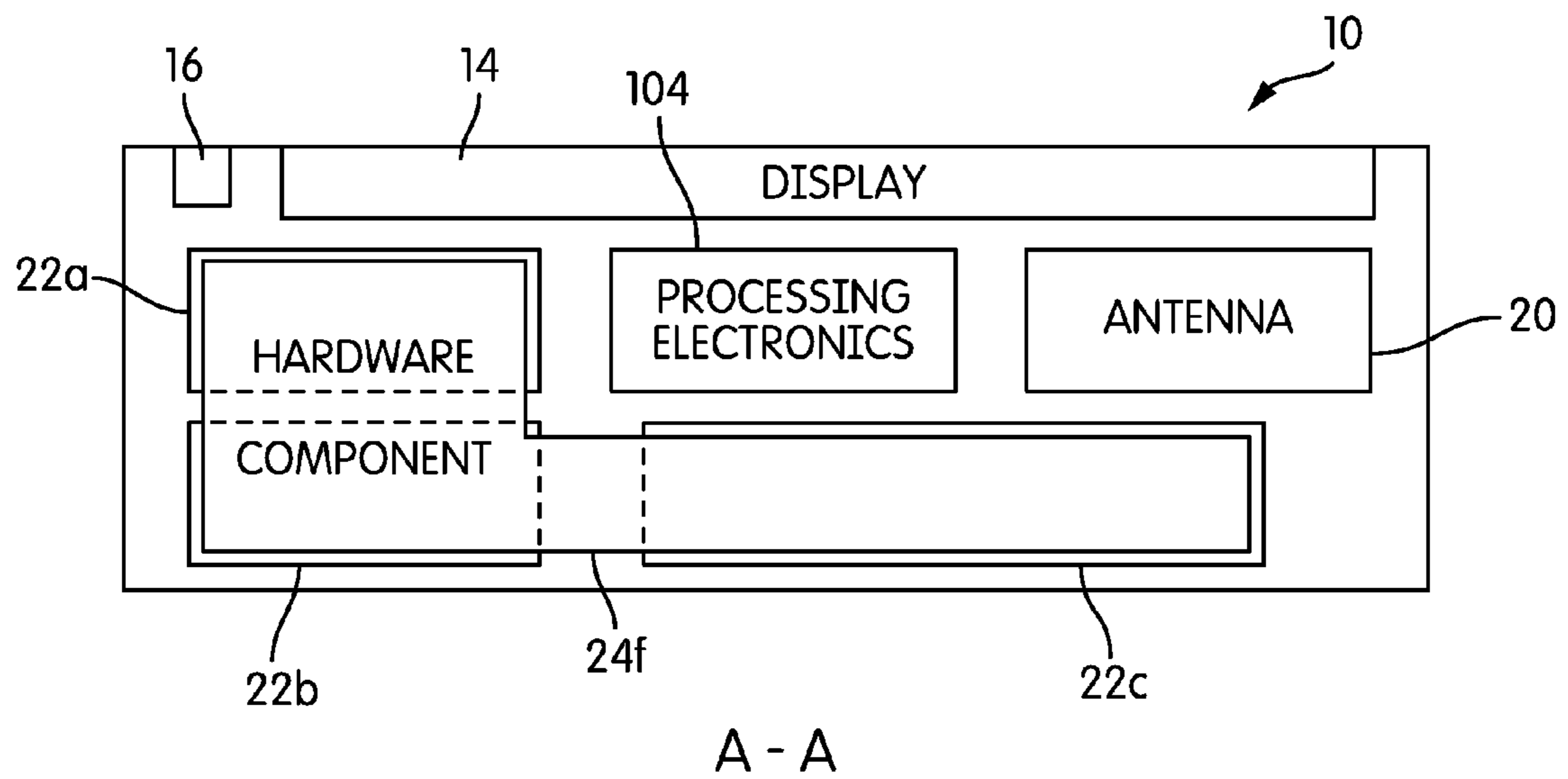

FIG. 4D

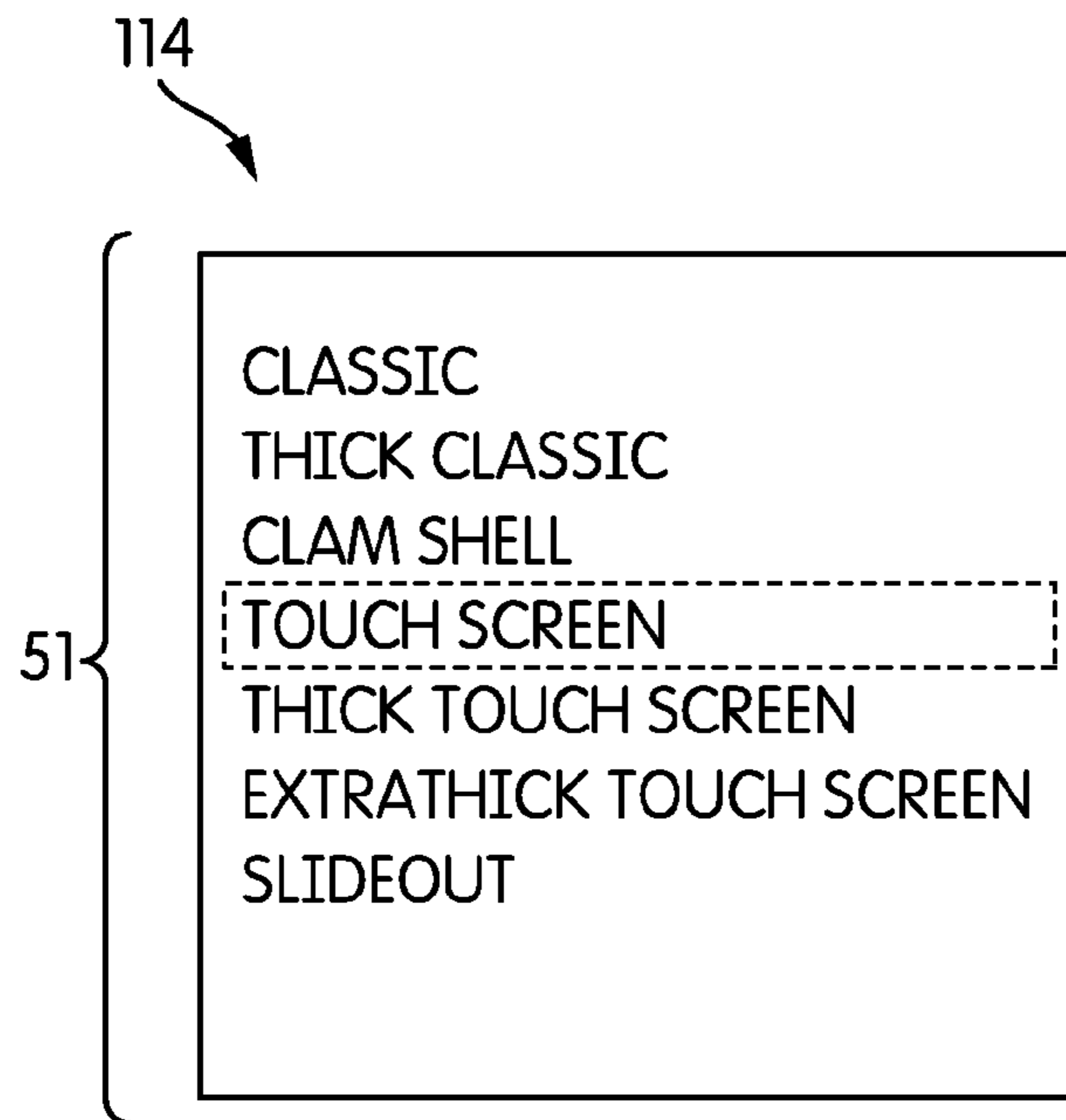

FIG. 5

ITEM	NO. OF RECEIVERS	THICKNESS	RATINGS
RAM	1	THIN	5
GPU	1	THIN	3
USB PORT	1	THIN	4.4
ULTRA SOUND	3	THICK	4
HEART MONITOR	2	THICK	4.3
MAG STRIPE READER	2	THICK	2
USB PORT	1	THICK	1
AUDIO COMBO	2	THIN	3
USB-HDMI COMBO	1-2	THIN	3.5

FIG. 6

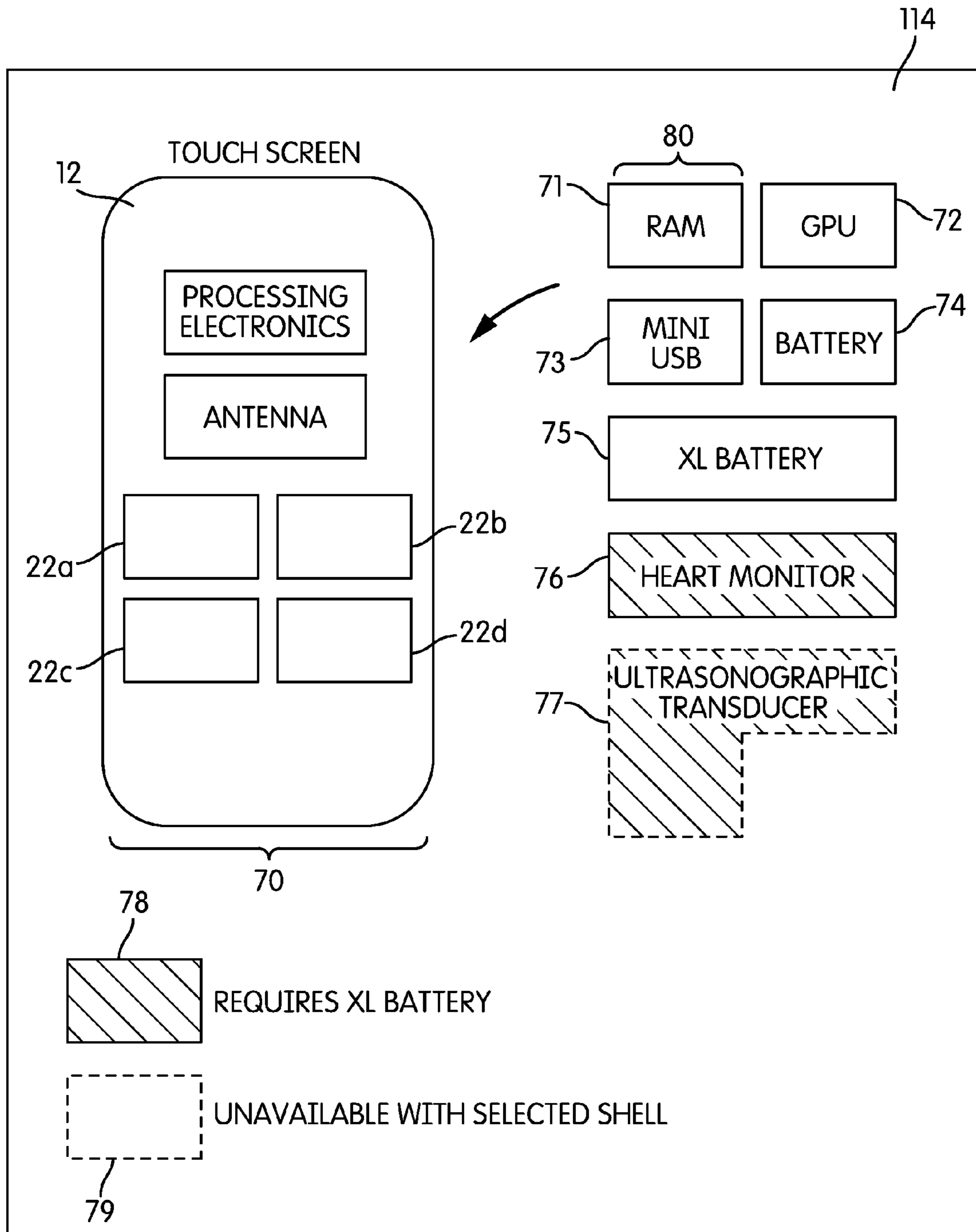

FIG. 7

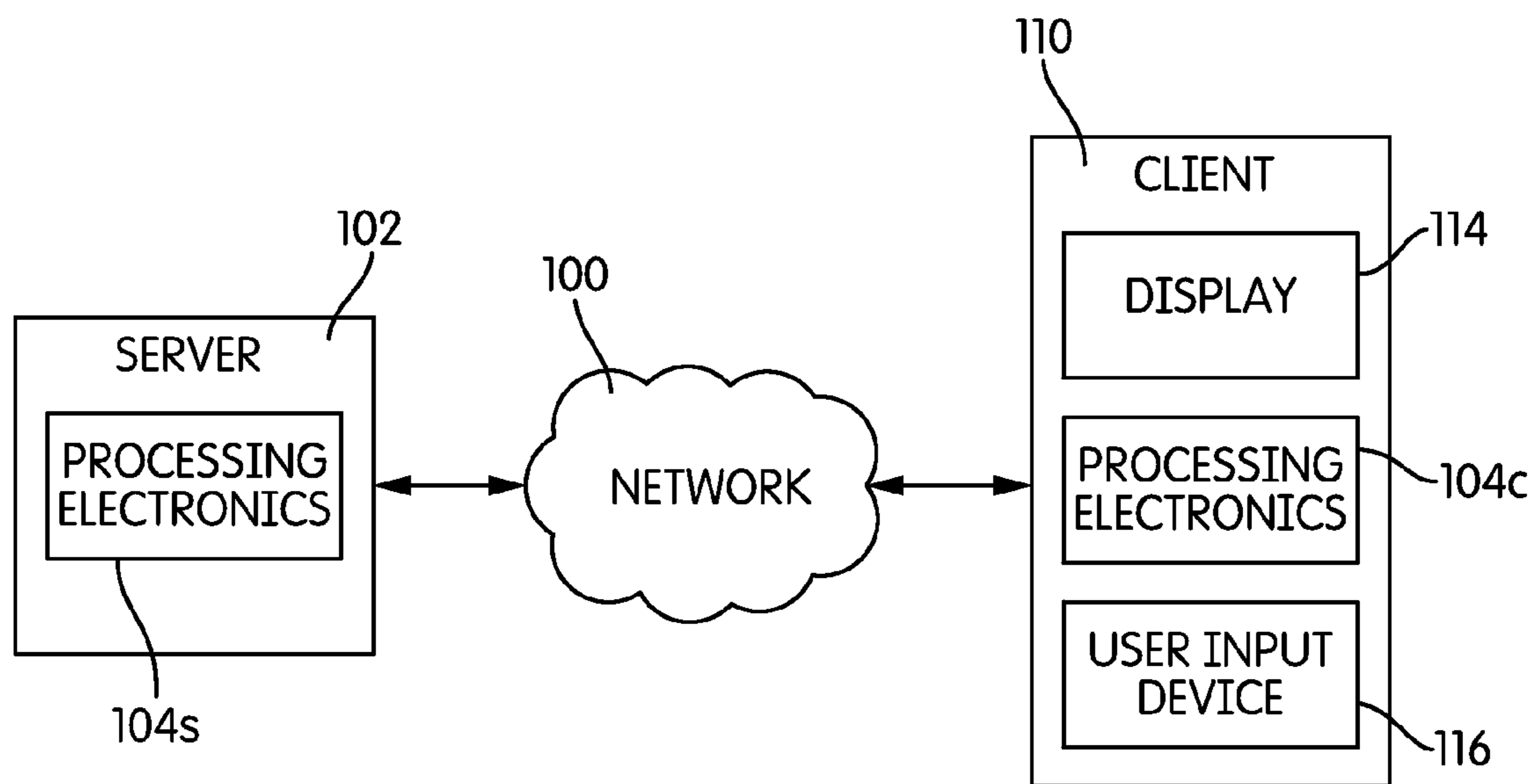

FIG. 8

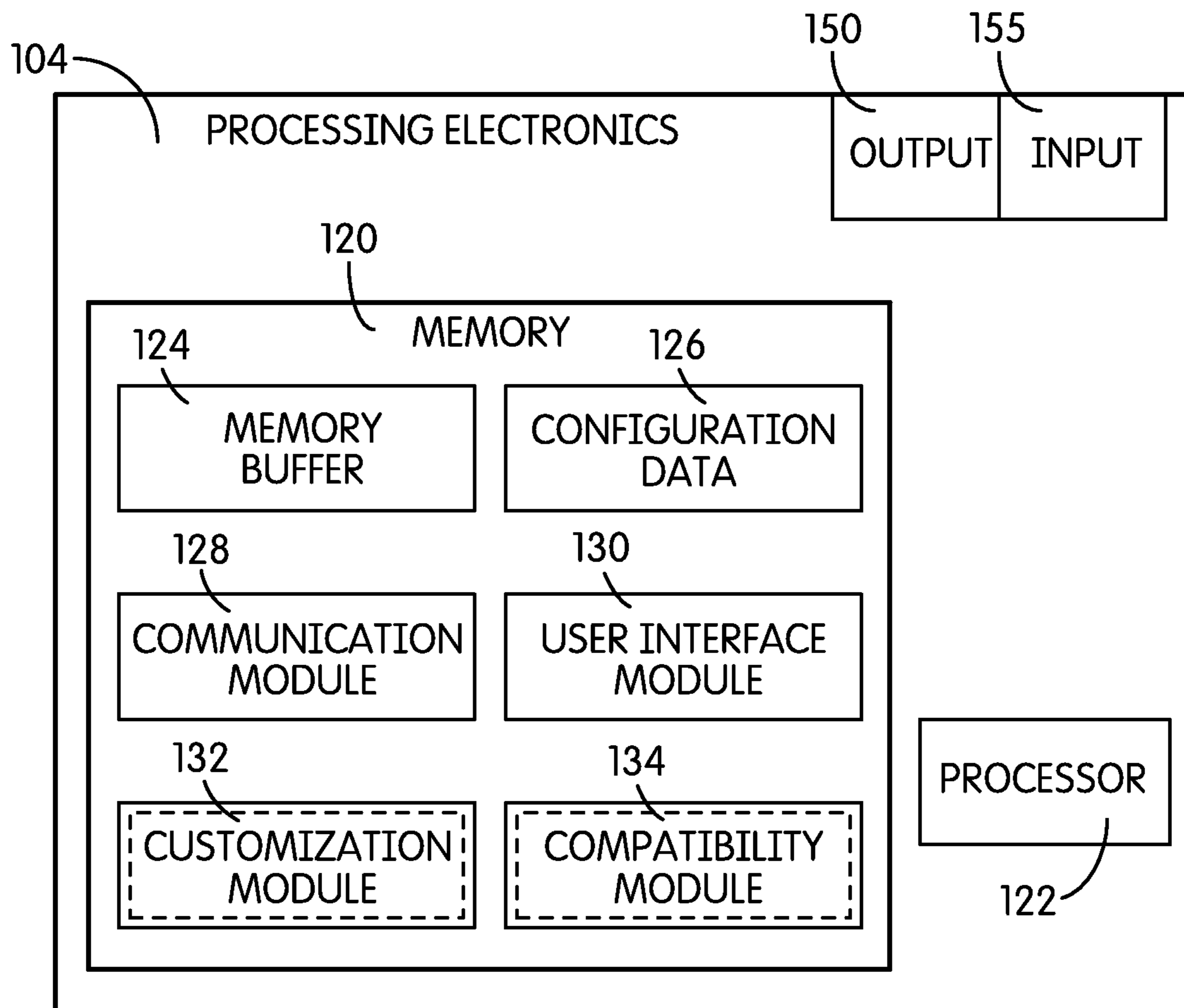

FIG. 9

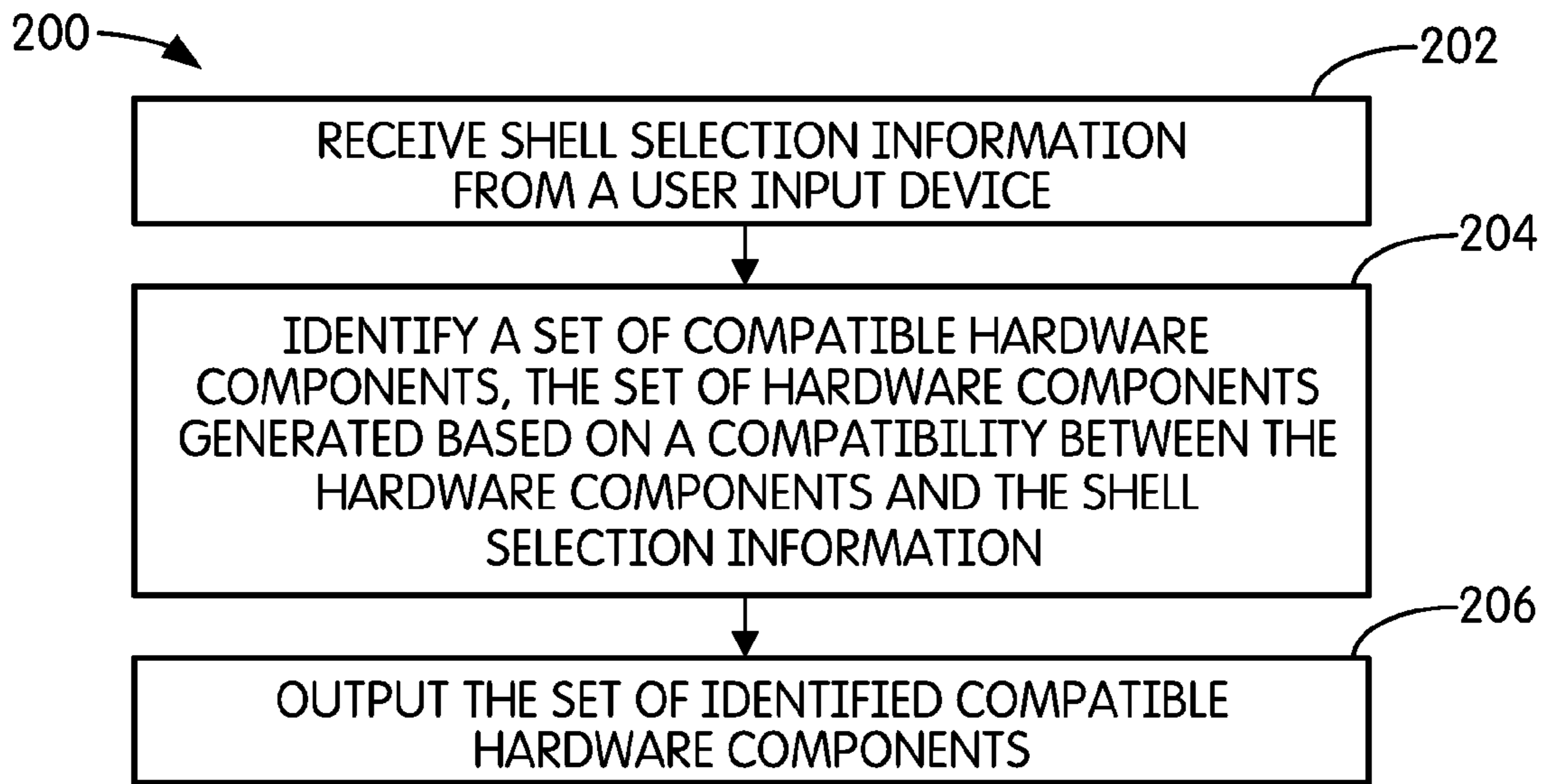

FIG. 10

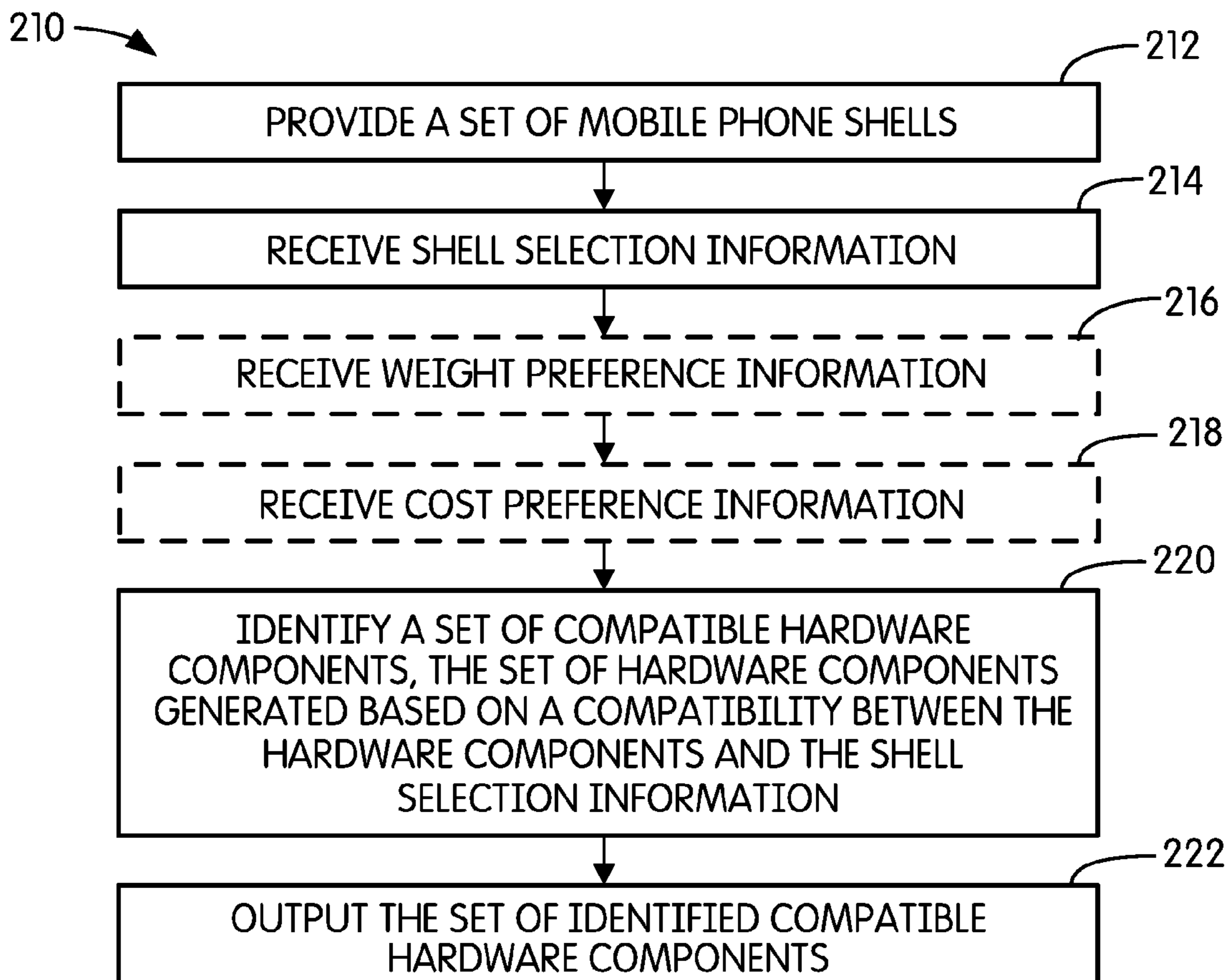

FIG. 11

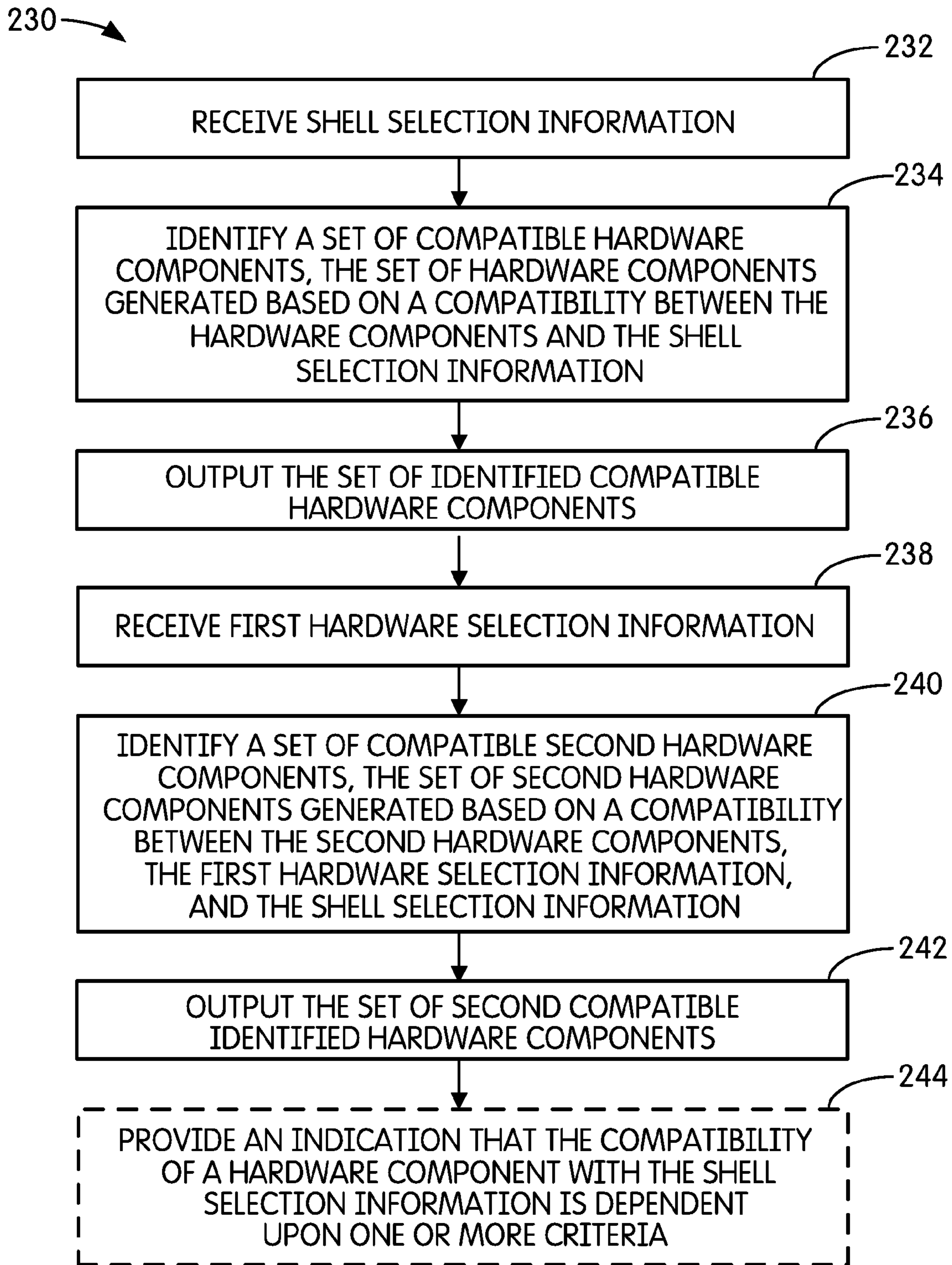

FIG. 12

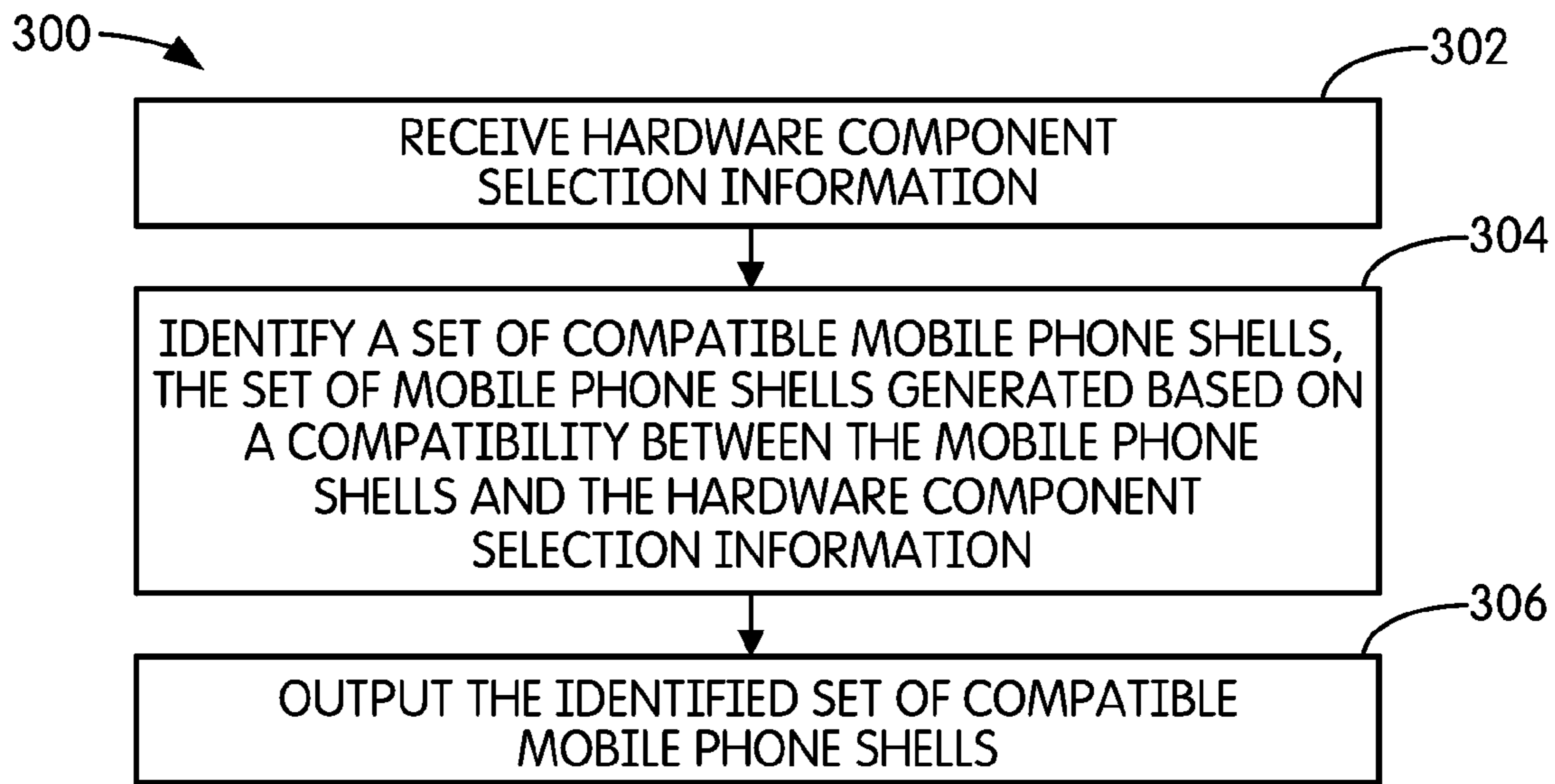

FIG. 13

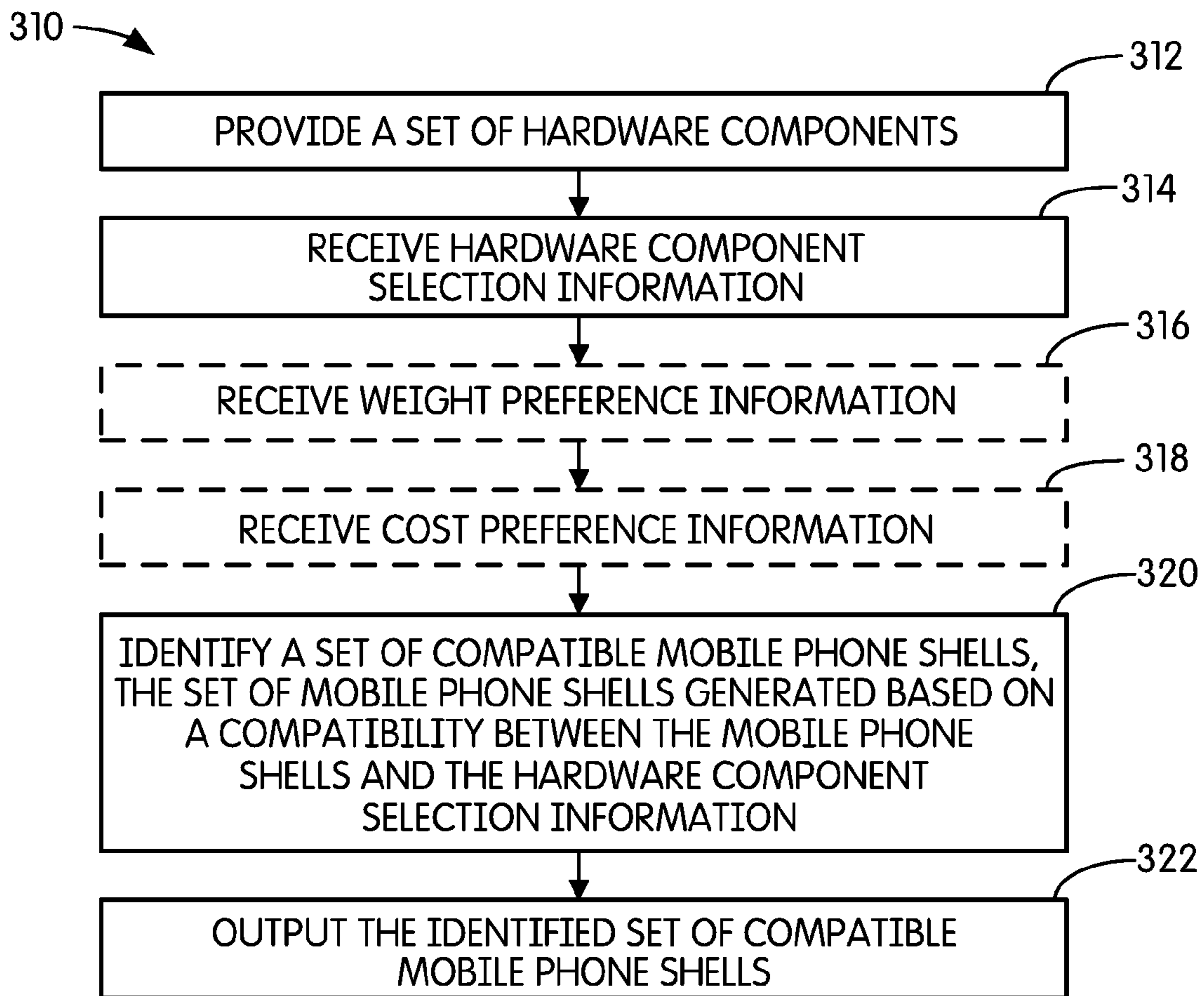

FIG. 14

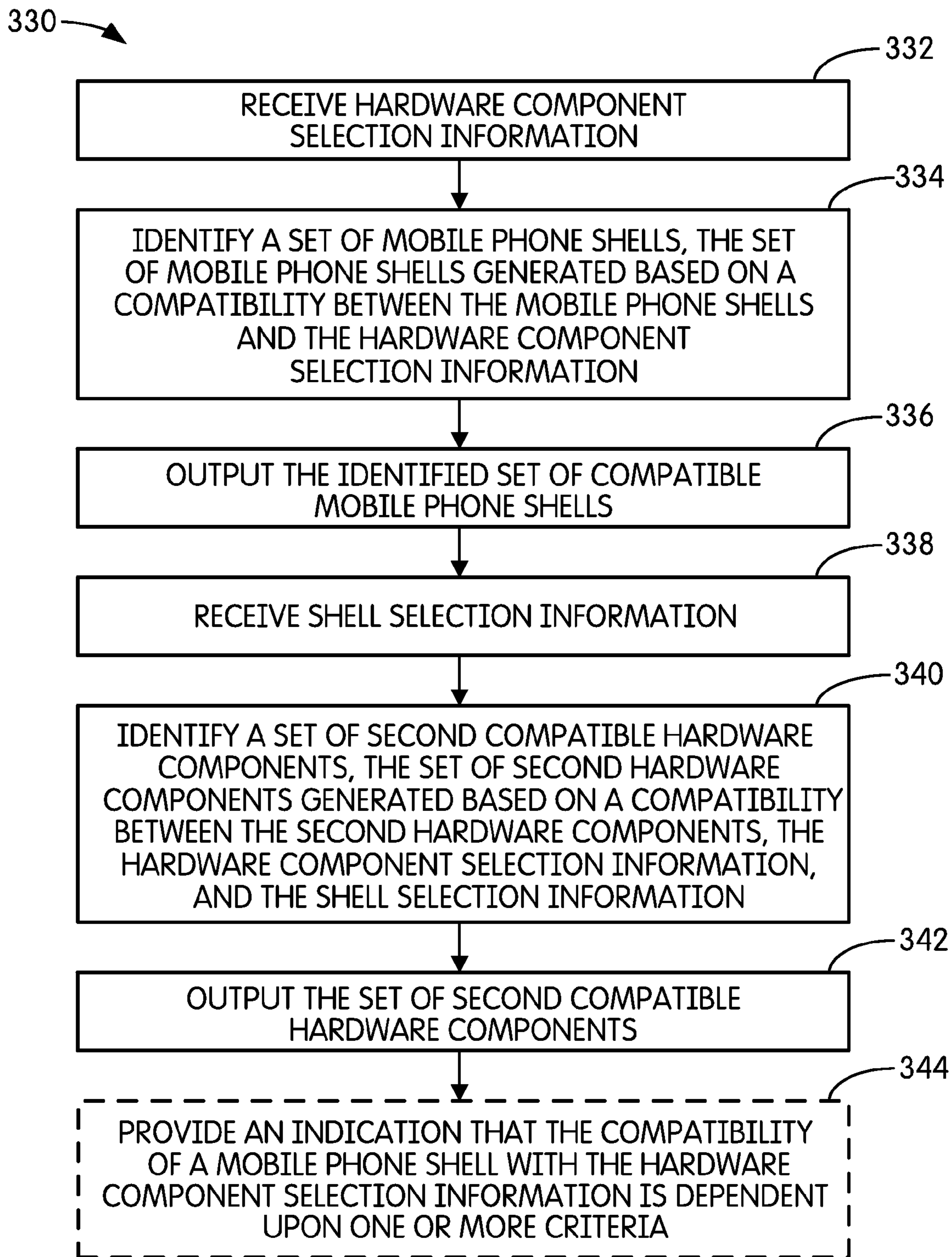

FIG. 15

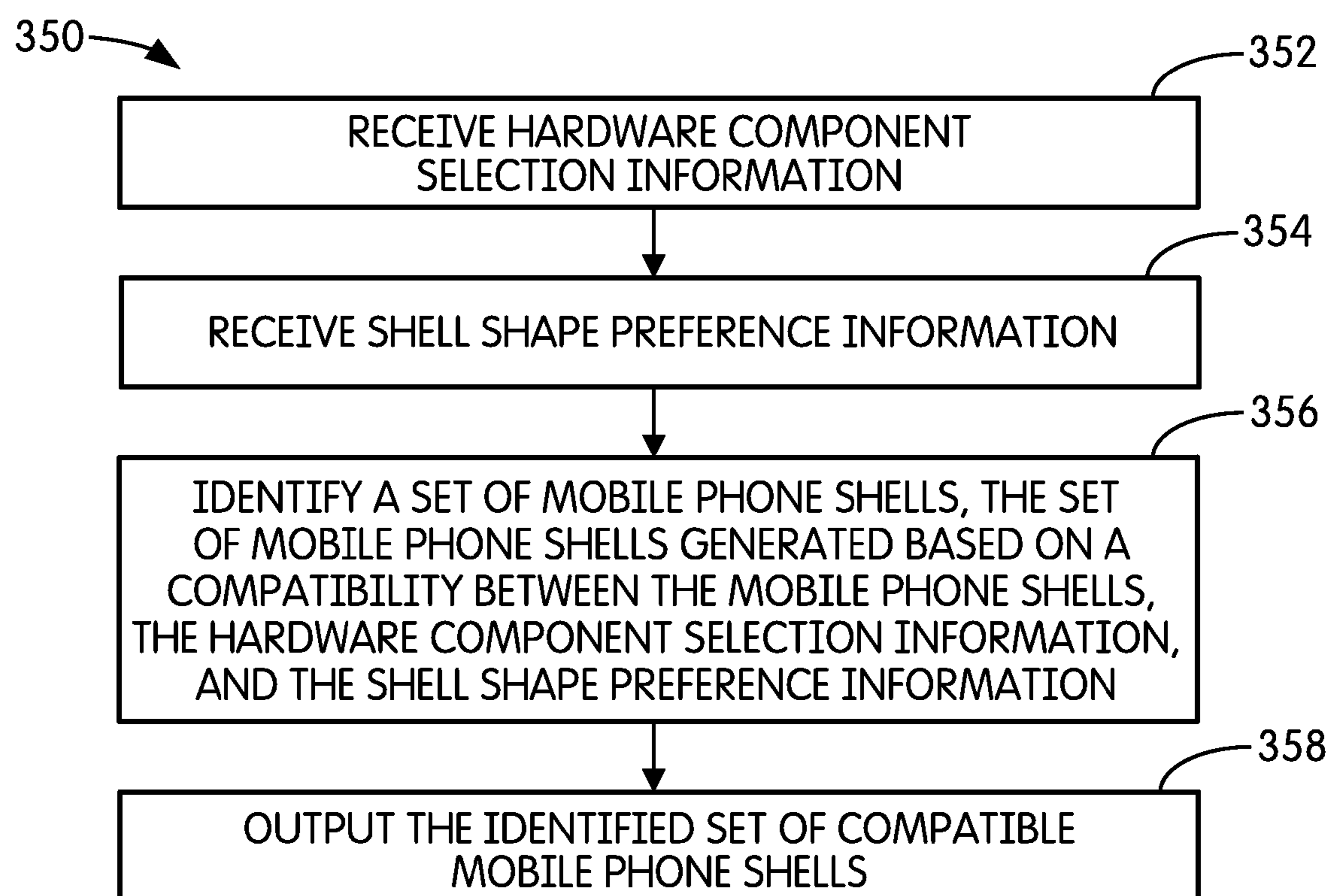

FIG. 16

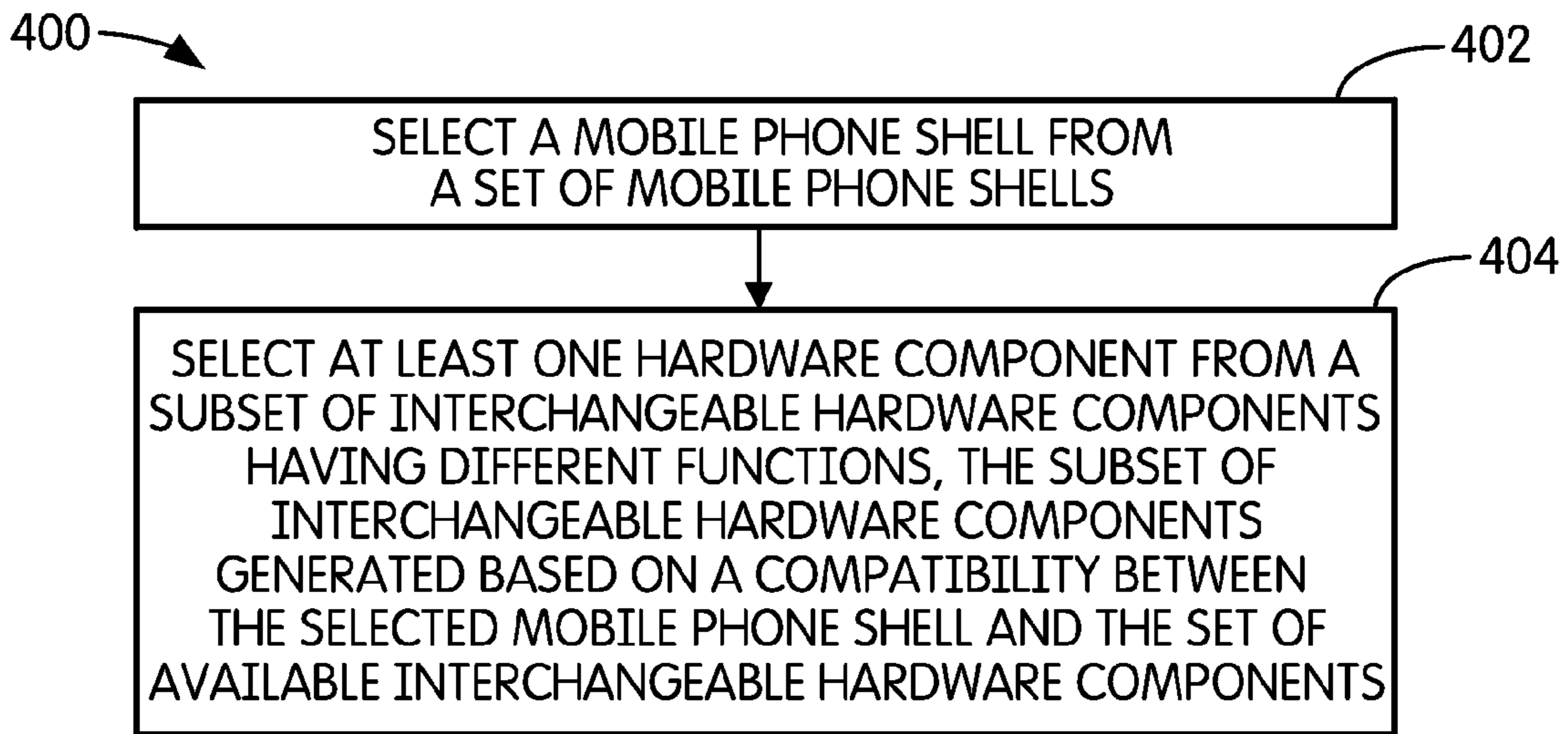

FIG. 17

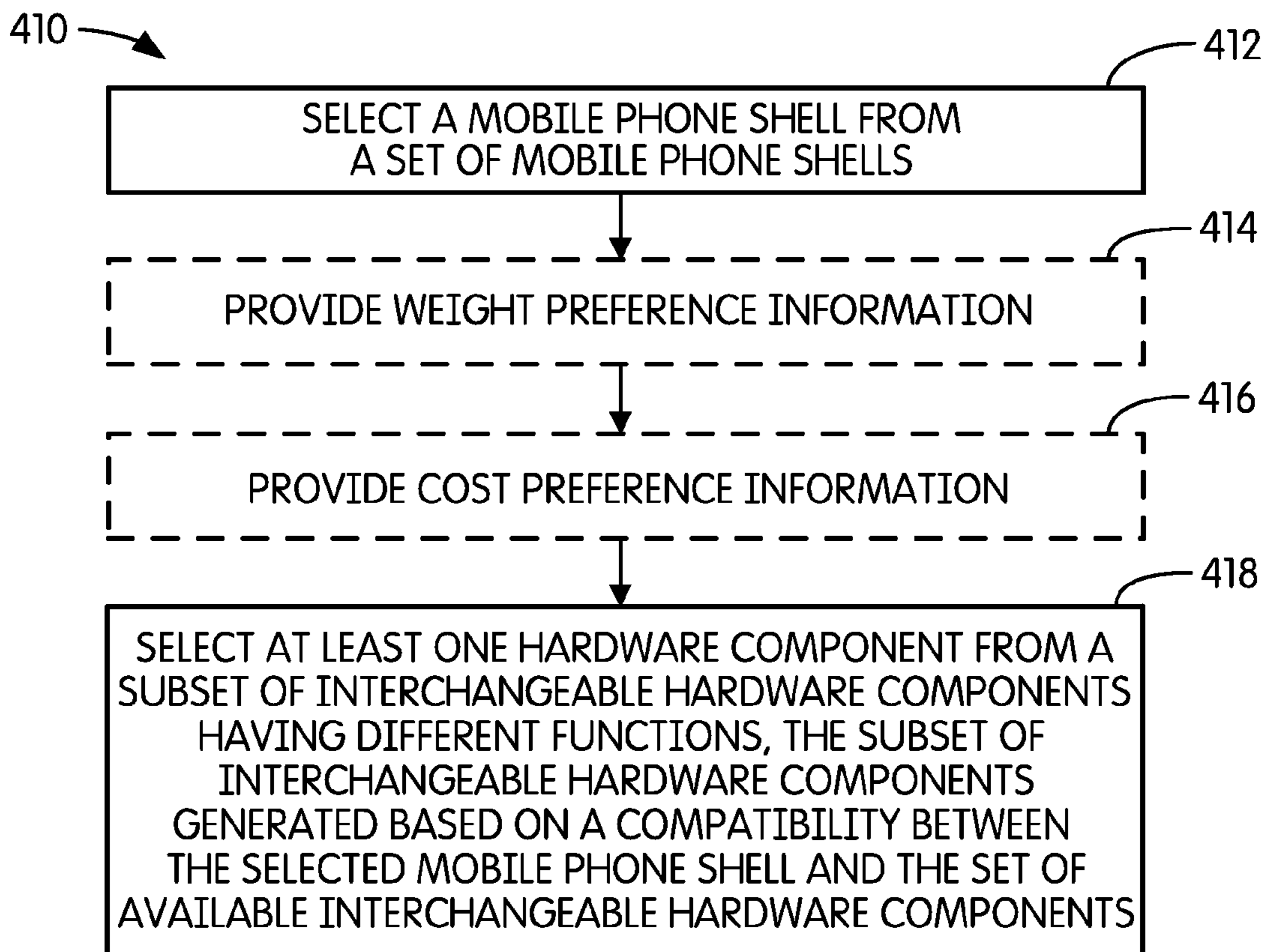

FIG. 18

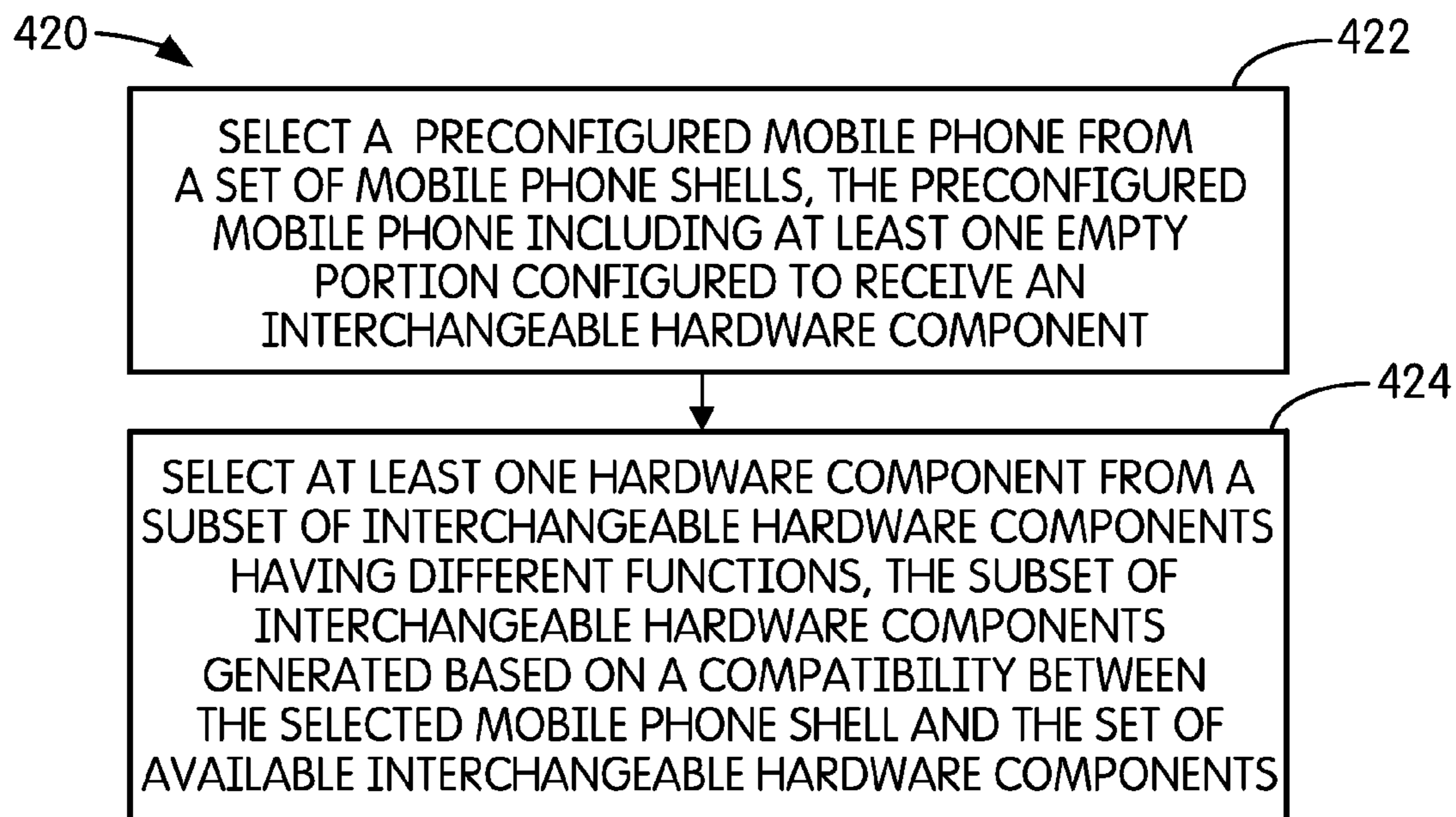

FIG. 19

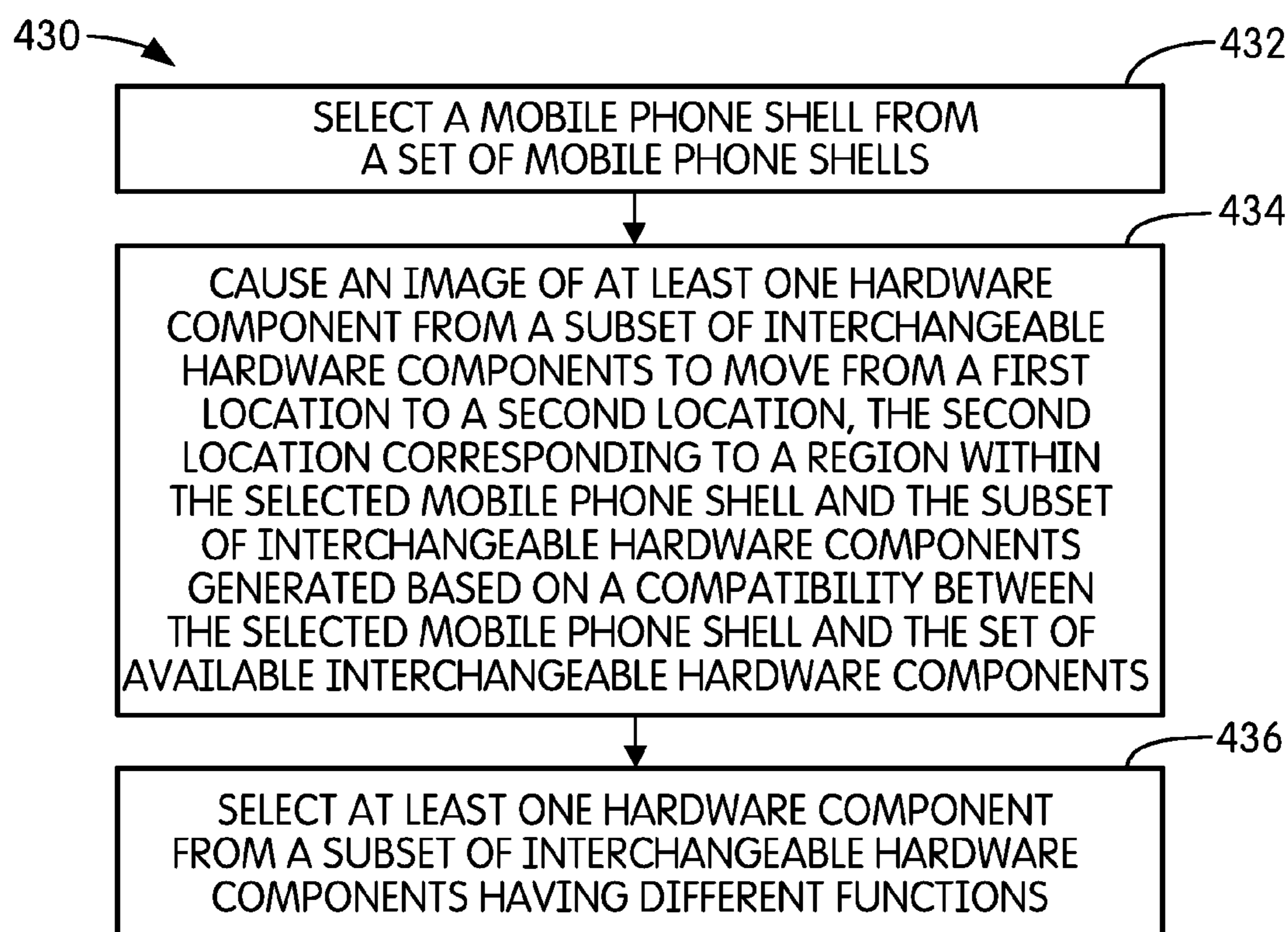

FIG. 20

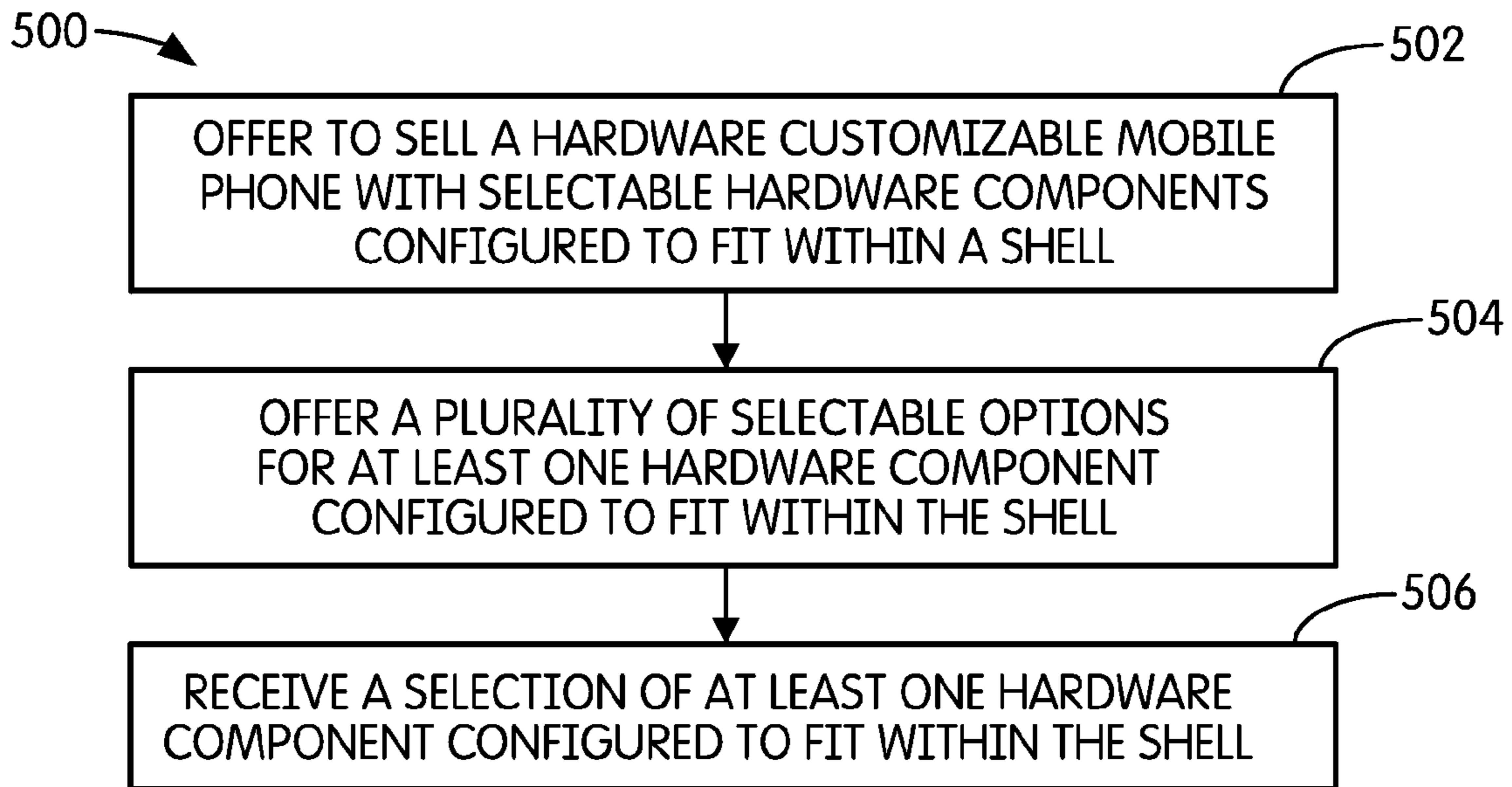

FIG. 21

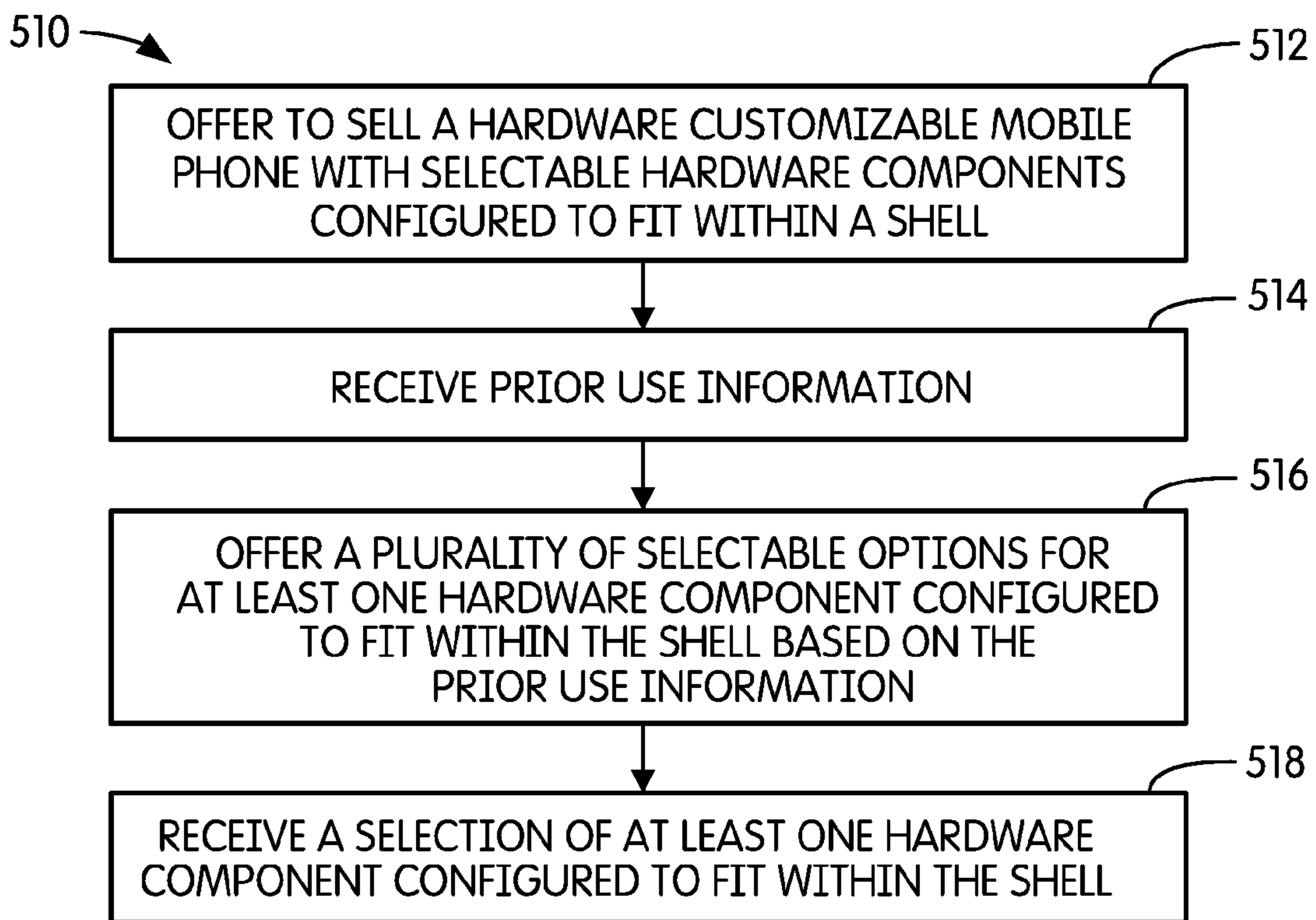

FIG. 22

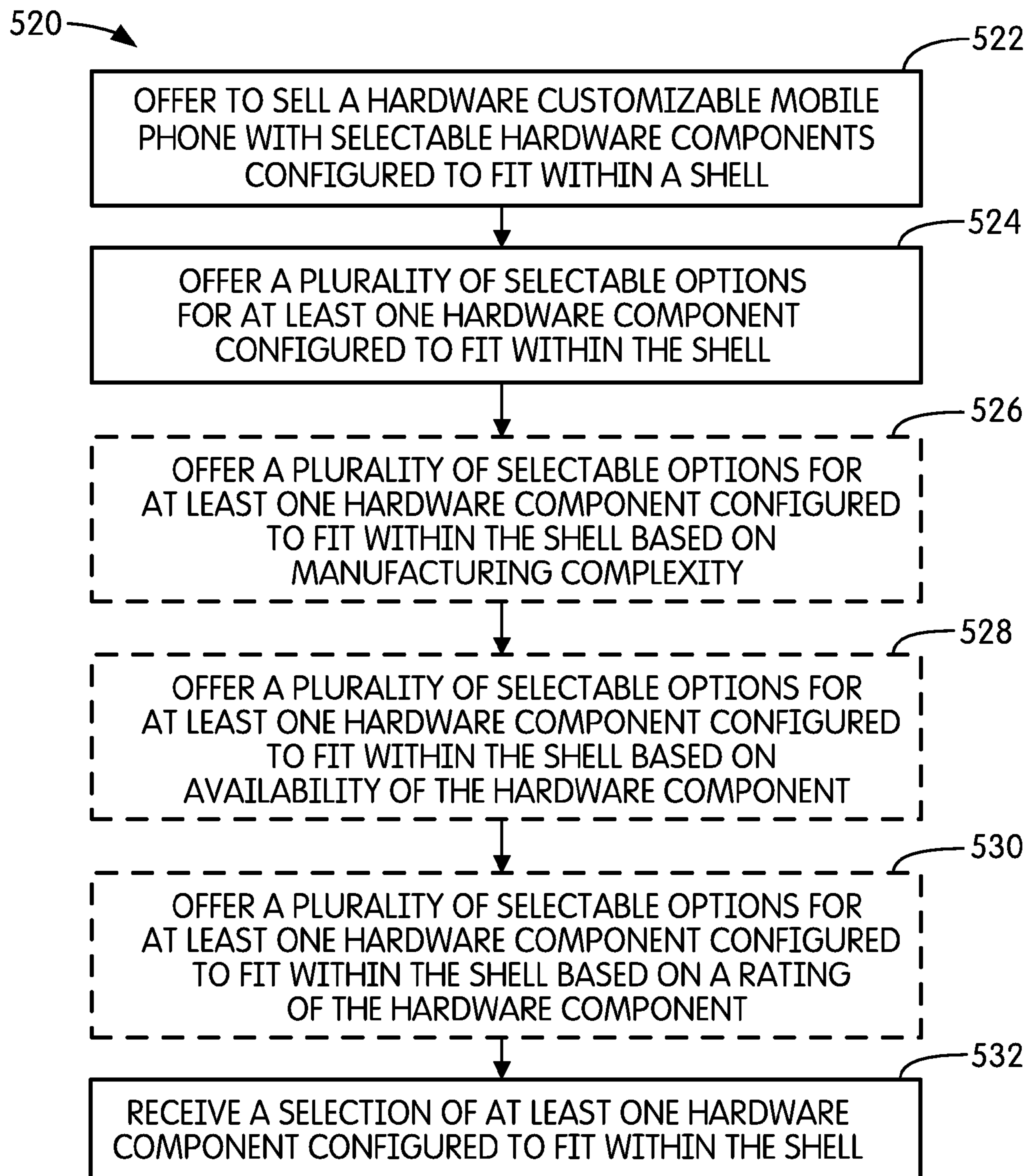

FIG. 23

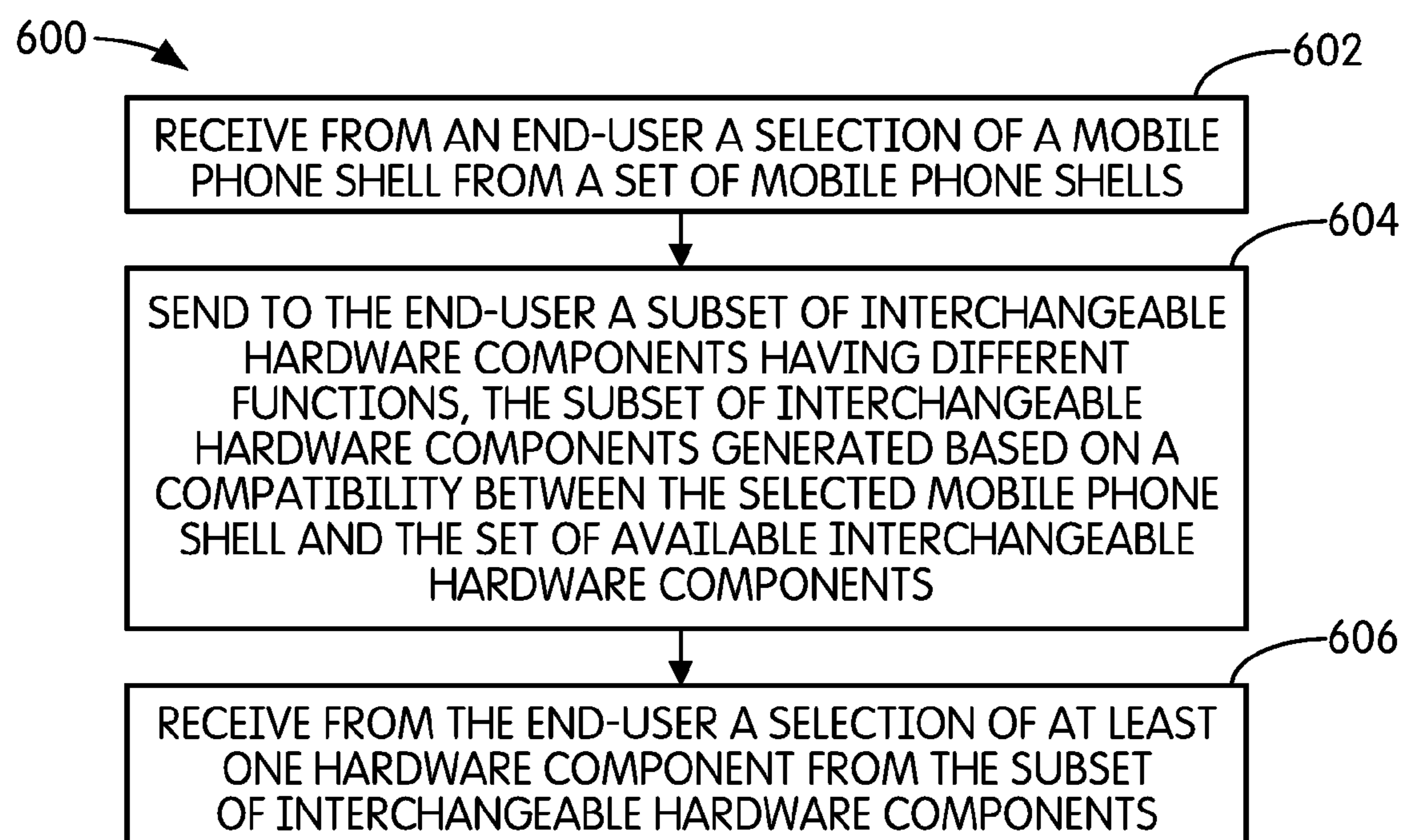

FIG. 24

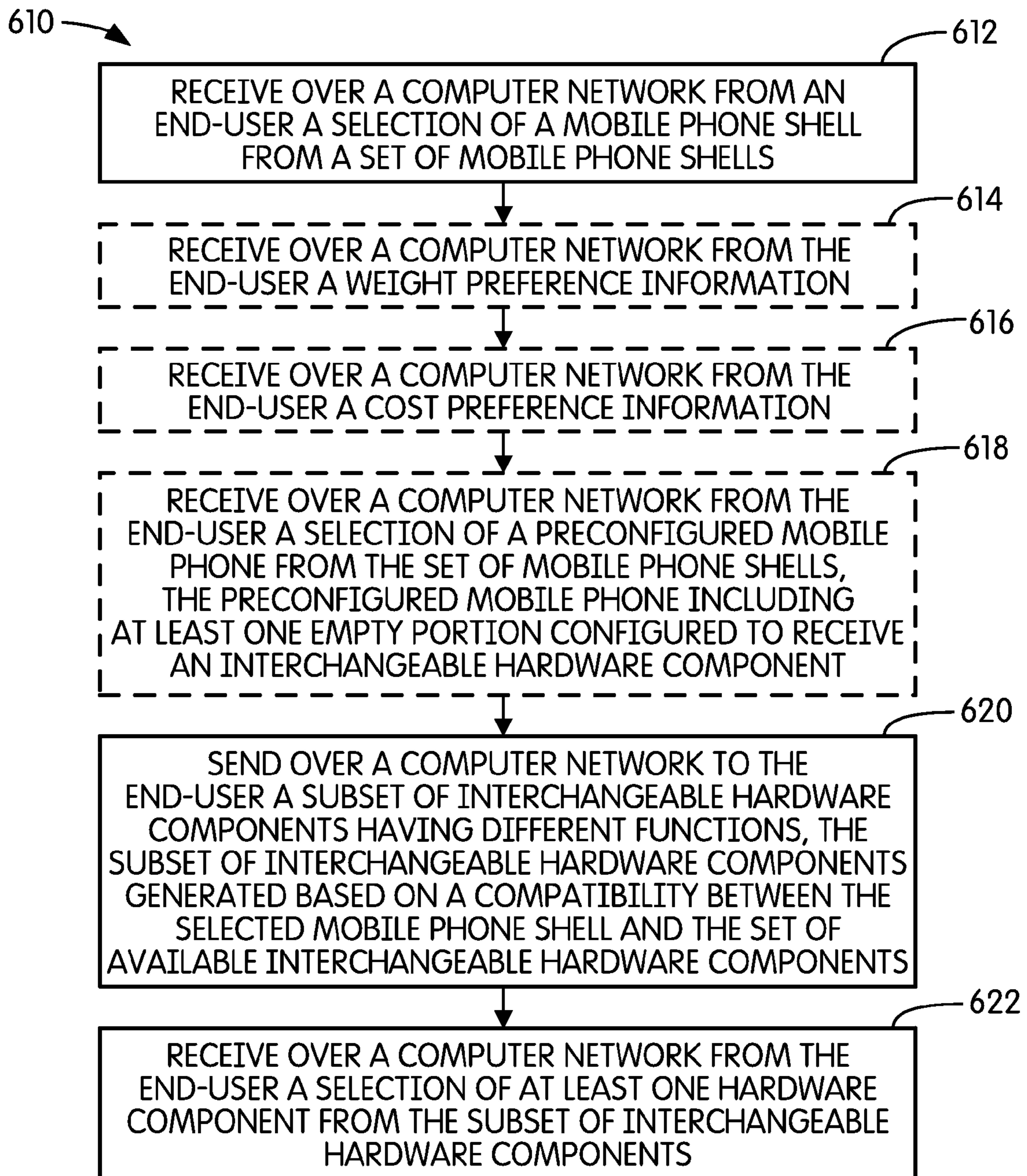

FIG. 25

1

CUSTOMIZED HARDWARE SELECTION FOR A MOBILE PHONE

CROSS-REFERENCE TO RELATED PATENT APPLICATIONS

This application is a divisional of U.S. application Ser. No. 13/340,463, titled "Customized Hardware Selection for a Mobile Phone," filed Dec. 29, 2011, which is incorporated herein by reference in its entirety.

PRIORITY APPLICATIONS

The present application constitutes a continuation of U.S. patent application Ser. No. 14/631,975, entitled CUSTOMIZED HARDWARE SELECTION FOR A MOBILE PHONE, naming Alistair K. Chan, Philip A. Eckhoff, Roderick A. Hyde, Jordin T. Kare, David B. Tuckerman, Lowell L. Wood, Jr. as inventors, filed Feb. 26, 2015, and which is a continuation of U.S. patent application Ser. No. 13/765,505, U.S. Pat. No. 8,971,969 entitled CUSTOMIZED HARDWARE SELECTION FOR A MOBILE PHONE, naming Alistair K. Chan, Philip A. Eckhoff, Roderick A. Hyde, Jordin T. Kare, David B. Tuckerman, Lowell L. Wood, Jr. as inventors, filed Feb. 12, 2013, and which is a division of U.S. patent application Ser. No. 13/340,463, U.S. Pat. No. 8,391,934 entitled CUSTOMIZED HARDWARE SELECTION FOR A MOBILE PHONE, naming Alistair K. Chan, Philip A. Eckhoff, Roderick A. Hyde, Jordin T. Kare, David B. Tuckerman, Lowell L. Wood, Jr. as inventors, filed Dec. 29, 2011.

BACKGROUND

The present disclosure relates generally to the field of mobile phones. More specifically, the present disclosure relates to the field of hardware customizable mobile phones.

Mobile phones are notoriously cramped for space, making it difficult to include new widgetry with limited, rather than universal, appeal. Traditionally, as the volume required for essential hardware has decreased, mobile phones have also gotten smaller. Some new widgets have been incorporated into at least some of the freed up space, but to maintain economies of scale, mobile phones and the accompanying widgets are generally not customizable. Users may select a desired phone with preselected widgets, but only from a limited selection offered by the mobile phone maker or its competitors. Thus, there is a need for a hardware customizable mobile phone with user selectable components.

SUMMARY

One embodiment relates to a mobile phone. The mobile phone includes a shell and a hardware component coupled to the shell, wherein the hardware component is selected from a set of interchangeable components having substantially the same size but different functions.

Another embodiment relates to a computerized method of customizing hardware for a mobile phone. The method includes receiving shell selection information from a user input device, identifying a set of hardware components, the set of hardware components generated based on a compatibility between the hardware components and the shell selection information, and outputting the identified set of compatible hardware components.

Another embodiment relates to a computerized method of customizing hardware for a mobile phone. The method includes receiving a hardware component selection informa-

2

tion from a user input device, identifying a set of compatible mobile phone shells, the set of mobile phone shells generated based on a compatibility between the mobile phone shells and the hardware component selection information, and outputting the identified set of compatible mobile phone shells.

Another embodiment relates to a method of customizing hardware by an end user for a mobile phone. The method includes receiving from an end-user a selection of a mobile phone shell from a set of mobile phone shells, sending to the end-user a subset of interchangeable hardware components having different functions, and receiving from the end-user a selection of at least one hardware component from the subset of interchangeable hardware components. The subset of interchangeable hardware components is generated based on a compatibility between the selected mobile phone shell and the set of available interchangeable hardware components.

Another embodiment relates to a method of selling a mobile phone. The method includes offering to sell a hardware customizable mobile phone with one or more selectable hardware components configured to fit within a shell, offering a plurality of selectable options for at least one hardware component configured to fit within the shell, and receiving a selection of at least one hardware component configured to fit within the shell.

Another embodiment relates to a method of customizing hardware for a mobile phone. The method includes selecting a mobile phone shell from a set of mobile phone shells, and selecting at least one hardware component from a subset of interchangeable hardware components having different functions, the subset of interchangeable hardware components generated based on a compatibility between the selected mobile phone shell and the set of available interchangeable hardware components.

The foregoing is a summary and thus by necessity contains simplifications, generalizations and omissions of detail. Consequently, those skilled in the art will appreciate that the summary is illustrative only and is not intended to be in any way limiting. Other aspects, inventive features, and advantages of the devices and processes described herein, as defined solely by the claims, will become apparent in the detailed description set forth herein and taken in conjunction with the accompanying drawings.

BRIEF DESCRIPTION OF THE DRAWINGS

FIG. 1 is an exemplary display showing a variety of mobile phones, shown according to various exemplary embodiments.

FIGS. 2A-2C are schematic block diagrams of mobile phones, shown according to exemplary embodiments.

FIG. 3 is a schematic block diagram of a mobile phone, shown according to another embodiment.

FIGS. 4A-4D are detailed schematic block diagrams of cross-sectional side-elevation views of mobile phones, shown according to an exemplary embodiment.

FIG. 5 is an exemplary display showing a list of mobile phone shells, shown according to an exemplary embodiment.

FIG. 6 is an exemplary display showing a list of hardware components, shown according to an exemplary embodiment.

FIG. 7 is an exemplary display showing images of a mobile phone shell and hardware components, shown according to an exemplary embodiment.

FIG. 8 is a schematic diagram of a server and a client, connected over a network and configured for using the systems and methods of this disclosure, shown according to an exemplary embodiment.

FIG. 9 is a detailed block diagram of processing electronics, shown according to an exemplary embodiment.

FIG. 10 is a flowchart of a process for customizing hardware for a mobile phone, shown according to an exemplary embodiment.

FIG. 11 is a flowchart of a process for customizing hardware for a mobile phone, shown according to another embodiment.

FIG. 12 is a flowchart of a process for customizing hardware for a mobile phone, shown according to another embodiment.

FIG. 13 is a flowchart of a process for customizing hardware for a mobile phone, shown according to another embodiment.

FIG. 14 is a flowchart of a process for customizing hardware for a mobile phone, shown according to another embodiment.

FIG. 15 is a flowchart of a process for customizing hardware for a mobile phone, shown according to another embodiment.

FIG. 16 is a flowchart of a process for customizing hardware for a mobile phone, shown according to another embodiment.

FIG. 17 is a flowchart of a process for customizing hardware for a mobile phone, shown according to another embodiment.

FIG. 18 is a flowchart of a process for customizing hardware for a mobile phone, shown according to another embodiment.

FIG. 19 is a flowchart of a process for customizing hardware for a mobile phone, shown according to another embodiment.

FIG. 20 is a flowchart of a process for customizing hardware for a mobile phone, shown according to another embodiment.

FIG. 21 is a flowchart of a process for selling a mobile phone, shown according to an exemplary embodiment.

FIG. 22 is a flowchart of a process for selling a mobile phone, shown according to another embodiment.

FIG. 23 is a flowchart of a process for selling a mobile phone, shown according to another embodiment.

FIG. 24 is a flowchart of a process for customizing hardware for a mobile phone, shown according to another embodiment.

FIG. 25 is a flowchart of a process for customizing hardware for a mobile phone, shown according to another embodiment.

DETAILED DESCRIPTION

Referring generally to the figures, systems and methods for a hardware customizable mobile phone and components thereof are shown according to various exemplary embodiments. A hardware customizable mobile phone generally includes a shell and one or more selectable hardware components coupled to the shell, either directly or indirectly (e.g., via a circuit board). For example, the selectable hardware component may plug into a receiver located in the phone. The selectable hardware components may come from a set of components having substantially the same size, but different functions. The selectable hardware components may be interchangeable with other hardware components from the same set or from a second set of components. The second set of components may have the same or different function and a different size, yet still be compatible with the receiver and the size of the shell. Methods of customizing a mobile phone are also described. According to one embodiment, a user may

select a shell from a set of available mobile phone shells or select a hardware component from a set of available hardware components. The user is then provided with a subset of mobile phone shells or a subset of hardware components that are compatible with the selected shell or component. Compatibility may be based on a size value (e.g., length, width, thickness, area, volume, etc.), shape of the hardware component, power consumption, or receiver availability of the shell or other components. The user may then continue to select a shell or additional hardware components to further customize the mobile phone.

It should further be noted that for purposes of this disclosure, the term coupled means the joining of two members directly or indirectly to one another. Such joining may be stationary in nature or moveable in nature and such joining may allow for the flow of fluids, electricity, electrical signals, or other types of signals or communication between the two members. Such joining may be achieved with the two members or the two members and any additional intermediate members being integrally formed as a single unitary body with one another or with the two members or the two members and any additional intermediate members being attached to one another. Such joining may be permanent in nature or alternatively may be removable or releasable in nature.

Referring to FIG. 1, a display 114 shows a variety of mobile phones 10, according to various exemplary embodiments. Mobile phones 10 come in varying shapes (e.g., style, external appearance, curvilinearity, etc.) and sizes (e.g., height, width, length, area, volume, etc.). Mobile phones 10 generally include a shell 12, a display 14, and a user input device 16 (keypad, keyboard, button, trackball, touchscreen, end-user input device, etc.). A shell 12 is a generally rigid structure or housing configured to be grasped by a user and to protect the internal components of the mobile phone 10 from liquids, debris, impact or other contaminants. The shell 12 may include a removable cover configured to provide access to internal components such as a battery, SIM card, etc. A touchscreen style of mobile phone, shown as mobile phone 10a, includes a shell 12a, a touch-sensitive display 14a, one or more bezel or soft buttons 16a. A classic (e.g., candybar) style of mobile phone, shown as mobile phone 10b, includes a shell 12b, a display 14b, and a keypad 16b. A clamshell (e.g., flip-phone) style of mobile phone, shown as mobile phone 10c, includes a shell 12c having an upper portion 17c and a lower portion 18c hingedly coupled by a joint 19. The clamshell mobile phone 10c includes a display 14c located on upper portion 17c, and a keypad 16c located on lower portion 18c. A slideout (e.g., slider) style of mobile phone, shown as mobile phone 10d, includes a shell 12d having an upper portion 17d and a lower portion 18d, which are slidably coupled. The slideout mobile phone 10d includes a display 14d, which may be touch-sensitive, located on upper portion 17d, and a keypad 16d (e.g., a numerical keypad, an alphanumeric keyboard, etc.) located on lower portion 18d.

Referring to FIGS. 2A-2C, schematic block diagrams of a mobile phone 10, shown as the touchscreen style mobile phone, are shown, according to exemplary embodiments. The mobile phone 10 is shown to include a shell 12, an antenna 20, and a processing electronics 104. The antenna 20 may be configured for communication with a cellular network, and the antenna 20 and the processing electronics 104 may be coupled to the shell 12, either directly or indirectly (e.g., via a circuit board, etc.). According to an exemplary embodiment, some hardware components are non-interchangeable. For example, the display 14, keyboard 18, processing electronics 104 (e.g., processor, etc.), antenna 20, and a camera may be permanently fixed to the shell or coupled to the

5

shell **12** in a manner that is not intended for interchangeability or in a manner that makes interchanging hardware components prohibitively difficult. For example, the display **14** may be coupled to the shell **12** with the use of an adhesive (e.g., a room temperature vulcanization adhesive).

Briefly referring to FIG. **9**, a detailed block diagram of the processing electronics **104** of FIG. **2A** is shown, according to an exemplary embodiment. Processing electronics **104** includes a memory **120** and processor **122**. Processor **122** may be or include one or more microprocessors, an application specific integrated circuit (ASIC), a circuit containing one or more processing components, a group of distributed processing components, circuitry for supporting a microprocessor, or other hardware configured for processing. According to an exemplary embodiment, processor **122** is configured to execute computer code stored in memory **120** to complete and facilitate the activities described herein. Memory **120** can be any volatile or non-volatile memory device capable of storing data or computer code relating to the activities described herein. For example, memory **120** is shown to include modules **128-130** which are computer code modules (e.g., executable code, object code, source code, script code, machine code, etc.) configured for execution by processor **122**. When executed by processor **122**, processing electronics **104** is configured to complete the activities described herein. Processing electronics includes hardware circuitry for supporting the execution of the computer code of modules **128-130**. For example, processing electronics **104** includes hardware interfaces (e.g., output **150**) for communicating control signals (e.g., analog, digital) from processing electronics **104** to one or more circuits coupled to processing electronics **104**. Processing electronics **104** may also include an input **155** for receiving data or signals from other systems or devices.

Memory **120** is shown to include a memory buffer for receiving and storing data, for example user input, downloaded data, etc., until it is accessed by another module or process. Memory **120** is further shown to include a communication module **128**, which may include logic for communicating between systems and devices. For example, the communication module **128** may be configured to use an antenna or data port for communication over a network. The communication module **128** may further be configured to communicate with other components within the mobile phone over a parallel bus, serial bus, or network. Memory **120** is further shown to include a user interface module **130**, which includes logic for using user input data in memory buffer **124** or signals from input **155** to determine desired user responses. For example, the user interface module **130** may be configured to convert, transform, or process signals or data from a keyboard, mouse, or touchscreen into signals or data useable by processor **122**.

The shell **12** is further shown to include one or more receivers **22** (e.g., portion, region, socket, connector, etc.), shown as, a first receiver **22a** and a second receiver **22b**, which may be coupled directly or indirectly (e.g., via a circuit board, etc.) to the shell **12**. Each receiver **22** is configured to receive, support, or couple to a hardware component **24** (e.g., interchangeable hardware component, selectable hardware component, widget, element, etc.) of a certain size and configuration. As shown, the first receiver **22a** is configured to receive a first hardware component **24a** selected from a first set of components having substantially the same size but different functions. Hardware components **24** selected from the first set of hardware components may be interchangeable (e.g., swappable, substitutable, etc.) with other hardware components **24** in the first set of components. According to one embodiment,

6

the interchangeable hardware components **24** of the first set have substantially the same shape.

The mobile phone **10** may include a second receiver **22b**, which is configured to receive a second hardware component **24b** selected from a second set of components having substantially the same size but different functions. The first receiver **22a** and the second receiver **22b** may be the same or different sizes. According to an exemplary embodiment, the first receiver **22a** and the second receiver **22b** have similar dimensions (e.g., length, width, area, volume, etc.), in which case a hardware component **24** may be installed in either the first receiver **22a** or the second receiver **22b**. It is not necessary that every receiver **22** have a hardware component **24** directly coupled (e.g., plugged in, inserted, installed, snapped in, connected, etc.) to it. For example, referring to FIG. **2A**, a first hardware component **24a** is coupled to the first receiver **22a**, but no hardware component is coupled to the second receiver **22b**.

Referring to FIG. **2C**, it is further contemplated that a larger hardware component, shown as third hardware component **24c**, may be disposed in both the first receiver **22a** and the second receiver **22b**. The third hardware component may be selected from a third set of components having substantially the same size but different function.

Each receiver **22** may include one or more electrical contacts **26** which are configured to electrically couple to the hardware component **24**. According to an exemplary embodiment, each of a set of hardware components **24** is configured to electrically couple to a set of electrical contacts **26**. Referring to FIGS. **2A-2B**, a hardware component **24** may be configured to couple only to the contacts **26** in one receiver **22**. Referring to FIG. **2C**, a hardware component **24** may be configured to couple to contacts **26** in more than one receiver **22**.

Referring generally to FIGS. **2-4**, the hardware component **24** may have compatible shapes and sizes. For example, a set of hardware components **24** may be the same size and, therefore, be exchangeable between receivers **22**. A set of hardware components **24** may be mutually interchangeable. For example, a third hardware component **24c** may be the same size as the combination of a first hardware component **24a** and a second hardware component **24b**. As described above, a set of hardware components **24** may include pre-specified electrical connections **28** to the mobile phone **10**. As shown, in FIG. **2B**, the number and arrangement of the contacts **26** in first receiver **22a** and second receiver **22b** enables the first and second hardware component **24a**, **24b** to be placed in either receiver. As shown, in FIG. **2C**, the number and arrangement of contracts **26** in the first and second receivers **22a**, **22b** enables the third hardware component **24c** to be installed across both receivers **22**. Providing a standardized number and arrangement of contacts in the receivers **22** facilitates construction of hardware components that are compatible with the mobile phone **10**. It is further contemplated that a set of hardware components may include pre-specified optical connections to the mobile phone **10**, and that the hardware components **24** may include pre-specified electrical or optical connections to each other. For example, the third hardware component **24c** may be configured to allow the first hardware component **24a** to piggy-back thereon. Enabling piggy-backing facilitates the installation of larger or multi-receiver hardware components **24** without inherently requiring the removal of other hardware components. A set of hardware components **24** may have standard sizes or power consumptions to facilitate interchangeability. A set of hardware com-

ponents may be configured to have a standard component dimensions (e.g., area, volume, etc.) or to fit within a standard shell volume.

The hardware components **24** may have a variety of functions. According to one embodiment, a hardware component **24** may be a connector, e.g., a Universal Serial Bus (USB) connector, an IEEE 1394 connector, a DisplayPort connector, a Digital Visual Interface connector, a coaxial cable connector, a High Definition Multimedia Interface connector, a registered jack, a TRS connector, or miniaturized versions thereof. In this embodiment, a user may insert a TRS connector hardware component into a first receiver **22a** in order to output an analog signal, for example, to headphones. The user may then replace the TRS connector hardware components with a mini-USB connector hardware component in order to output a digital signal, for example, to a computer. According to an exemplary embodiment, the processing electronics **104** may include computer code (e.g., software, firmware, drivers, etc.) in the configuration data **126** of memory **120** to support communication between the processing electronics **104** and the hardware component. According to another embodiment, the hardware component **24** may include computer code (e.g., software, firmware, drivers, etc.) configured to support communication between the hardware component **24** and the processing electronics **104**.

According to various other embodiments, the hardware component **24** may include an ultrasonographic transducer, a heart monitor, a blood glucose tester, or an infrared camera. The hardware component **24** may include a micro impulse radar transducer, which may be configured to detect a heart-beat or the presence of an object or person on the other side of a wall or door. The hardware component **24** may include a food tester, for example, componentry configured to detect the presence of an allergen such as peanuts, fish, dairy, etc. The hardware component **24** may include a magnetic stripe reader, which may be used for the swiping or reading of data stored on a credit card. The hardware component **24** may include an RFID reader, which may be used for detecting and receiving information on a radio-frequency identification chip. The hardware component **24** may include an accident data recorder (e.g., flight recorder, black box, etc.), which may be configured for example to record location, velocity, acceleration information. The accident data recorder may include an accelerometer or gyroscope and may be configured to store peak information data or to stop overwriting data in response to a severe acceleration or deceleration. This may be useful, for example, for accident reconstruction purposes or for a parent monitoring the driving behavior of a teenage dependent. The hardware component **24** may include a power source (e.g., fuel cell, battery, solar cell, etc.). According to one embodiment, a small battery may couple a first receiver **22a**, and larger battery (e.g., more powerful, longer life, etc.) may couple to first and second receivers **22a**, **22b**. The hardware component may include processing electronics (e.g., a microprocessor, memory etc.). For example, a user may insert a graphics processing unit into the mobile phone **10** to improve a gaming experience, or to support a video projector (which may be another hardware component **24**). The hardware component **24** may include a display. For example, a user may install a hardware component **24** containing additional volatile memory (e.g., RAM) or non-volatile memory (e.g., flash memory, etc.). According to another embodiment, the user may install a card reader hardware component (e.g., SIM card, SD card, etc.) into the mobile phone **10**. The hardware component **24** may include a speaker or a microphone to facilitate the playing or recording of audio signals. The hardware component **24** may include a keyboard, key-

pad, trackball, touchpad, or other user input device. The hardware component **24** may include a biometric identification reader (e.g., fingerprint reader, retinal scanner, etc.), which may be used to enhance security of the mobile phone **10**. The hardware component **24** may include an antenna (e.g., short-wave radio, amplitude modulation (AM), frequency modulation (FM), global system for mobile communication (GSM), code division multiple access (CDMA), 3G, 4G, global positioning system (GPS), echolocation (e.g., sonar), etc.), which may allow a user to receive or transmit signals. For example, a user having a 3G antenna, may elect to replace the antenna with a 4G antenna when the technology becomes available in their location, or a user may elect to replace a CDMA antenna with a GSM antenna when travelling in a GSM dominant country. For another example, a user may install an AM or FM antenna in order to listen to a radio broadcast.

According to a preferred embodiment, the hardware component **24** is disposed at least partially within the shell **10**. For example, it is contemplated that a transducer, connector, or camera may extend partially out of the shell **10** in order to emit, connect, or receive as necessary. According to other embodiments, the hardware component **24** is disposed completely within the shell **10**. In these embodiments, it may be necessary to open the shell **10** (e.g., remove a cover) in order to remove or swap a hardware component **24**.

According to various embodiments, the first hardware component **24a**, the second hardware component **24b**, the third hardware component **24c**, or the interchangeable hardware components **24** generally may be selected by and end-user. An end-user may be a purchaser of the mobile phone **10** or an intended long-term possessor. According to other embodiments, the end-user may be an intermediary, for example, a person configuring the phone to resell (e.g., a retailer), lease, gift, (e.g., friend, family, etc.), or provide (e.g., coworker, employer, IT department, etc.) to another.

Referring to FIG. 3, a schematic block diagram of a mobile phone **10**, shown as a clamshell style mobile phone **10c**, is shown according to an exemplary embodiment. As shown, the size and shape of the mobile phone **10** may dictate that only one receiver **22** can fit within the shell **12**. Accordingly, the mobile phone **10** of FIG. 3 would not be able to accept the hardware component **24c** of FIG. 2C. Thus, a hardware component **24** for use in the mobile phone **10** may be selected from a subset of components that are compatible with the size and shape of the receiver of the mobile phone **10**.

Referring to FIGS. 4A-4D, cross-sectional schematic block diagrams of a mobile phone **10**, shown generally as the a touchscreen style of mobile phone **10a** of FIG. 1, are shown according to exemplary embodiments. The mobile phone **10** of FIG. 4A is shown to include a shell **12** having a relatively thin cross-section and to include a first receiver **22a**. In contrast, the mobile phones **10** of FIGS. 4B-4D are shown to include shells **12** having thicker cross-sections, which accommodate a second receiver **22b** and a third receiver **22c** below or behind the first hardware component **24a**, the processing electronics **104**, and the antenna **20**. The mobile phone **10** of FIG. 4B is shown to accommodate a longer hardware component **24d** across (e.g., in, among, between, etc.) the second receiver **22b** and third receiver **22c**. The mobile phone **10** of FIG. 4C is shown to accommodate a thicker hardware component **24e** across (e.g., in, among, between, etc.) the first receiver **22a** and the second receiver **22b**. As shown, the third receiver **22c** is configured to receive a different sized hardware component **24** than each of first and second receivers **22a**, **22b**. Accordingly the set of hardware components **24** configured to fit into the third receiver **22c** are interchangeable with each other, but are not interchangeable with the set

of hardware components **24** configured to fit into the first or second receivers **22a**, **22b**. The mobile phone **10** of FIG. 4D is shown to accommodate a larger, more complex hardware component **24f** across (e.g., in, among, between, etc.) the first receiver **22a**, the second receiver **22b**, and the third receiver **22c**. According to the embodiments shown, the thicker hardware components **24e**, **24f** of FIGS. 4C and 4D would not fit into the thin shell of FIG. 4A. According to various other embodiments, the number and arrangement of receivers **22** and the shape and size of hardware components **24** create a vast number of possible combinations of hardware components **24** within a shell **12**, and, in effect, create a three-dimensional puzzle.

In contrast, conventional wisdom has been to constantly drive mobile phones to be smaller and smaller, thinner and thinner. These ever-shrinking phones leave no room for extra components, let alone interchangeable hardware components. However, with the customizable mobile phones disclosed herein, a user may select a larger (e.g., wider, longer, thicker, etc.) mobile phone in order to accommodate additional receivers or to accommodate a particularly desired selectable hardware component. Alternatively, a user may select a smaller phone knowing that he or she may swap out the interchangeable hardware components.

It should be noted that a particular style of mobile phone **10** does not inherently dictate its size or the number of receivers **22** within its shell **12**. For example, the clamshell style mobile phone **10c** of FIG. 3 is shown to only include one receiver **22**; however, a user may select a longer, wider, or thicker clamshell phone **10c** in order to accommodate additional receivers **22** or additional or larger selectable hardware components **24**.

According to one embodiment, the portion of the volume of the interchangeable hardware components **24** occupy a greater portion of the volume of the shell **12** than the non-interchangeable hardware components (e.g., display **14**, user input device **16**, processing electronics **104**, and antenna **20**). According to another embodiment, the interchangeable hardware components **24** occupy at least 50 percent of the volume of the shell **12**. According to another embodiment, the interchangeable hardware components **24** occupy at least 90 percent of the volume of the shell **12**.

Referring to FIGS. 1 and 5-8, a system in which a user (e.g., an end-user) may customize a mobile phone is shown according to an exemplary embodiment. A client **110** is shown to communicate with a server **102** over a network **100** (e.g., local area network, wide area network, internet, etc.). The client **110** may include display **114**, processing electronics **104c**, and a user input device **116**. The user input device **116** may be a keyboard, a keypad, a mouse, a trackball, a touchscreen, etc. The client **110** may be any suitable computing device, for example, a home computer, a portable computing device, a mobile phone, an in-store kiosk, etc.

As described above with respect to processing electronics **104**, and referring generally to FIG. 9, processing electronics **104c** may include a memory **120** and processor **122**. Processor **122** may be or include one or more microprocessors, an application specific integrated circuit (ASIC), a circuit containing one or more processing components, a group of distributed processing components, circuitry for supporting a microprocessor, or other hardware configured for processing. According to an exemplary embodiment, processor **122** is configured to execute computer code stored in memory **120** to complete and facilitate the activities described herein. Memory **120** can be any volatile or non-volatile memory device capable of storing data or computer code relating to the activities described herein. For example, memory **120** is shown to include modules **128-132** which are computer code

modules (e.g., executable code, object code, source code, script code, machine code, etc.) configured for execution by processor **122**. When executed by processor **122**, processing electronics **104c** are configured to complete the activities described herein. Processing electronics include hardware circuitry for supporting the execution of the computer code of modules **128-132**. For example, processing electronics **104c** include hardware interfaces (e.g., output **150**) for communicating control signals (e.g., analog, digital) from processing electronics **104c** to one or more circuits coupled to processing electronics **104c**. Processing electronics **104c** may also include an input **155** for receiving data or signals from other systems or devices. Memory **120** is shown to include a customization module **132** which may include logic for transforming data or signals from a user input module **130** or memory buffer **124** into information (e.g., selection information, preference information, etc.) which may be sent to the server **102**.

The server **102** is shown to include processing electronics **104s**. As described above with respect to processing electronics **104** and **104c**, and referring generally to FIG. 9, the processing electronics **104s** may include a memory **120** and processor **122**. Processor **122** may be or include one or more microprocessors, an application specific integrated circuit (ASIC), a circuit containing one or more processing components, a group of distributed processing components, circuitry for supporting a microprocessor, or other hardware configured for processing. According to an exemplary embodiment, processor **122** is configured to execute computer code stored in memory **120** to complete and facilitate the activities described herein. Memory **120** can be any volatile or non-volatile memory device capable of storing data or computer code relating to the activities described herein. For example, memory **120** is shown to include modules **128** and **134** which are computer code modules (e.g., executable code, object code, source code, script code, machine code, etc.) configured for execution by processor **122**. When executed by processor **122**, processing electronics **104s** are configured to complete the activities described herein. Processing electronics include hardware circuitry for supporting the execution of the computer code of modules **128** and **134**. For example, processing electronics **104s** includes hardware interfaces (e.g., output **150**) for communicating control signals (e.g., analog, digital) from processing electronics **104s** to one or more circuits coupled to processing electronics **104s**. Processing electronics **104s** may also include an input **155** for receiving data or signals from other systems or devices. Memory **120** is shown to include a compatibility module **134** which may include logic for receiving selection or preference information from a client and providing a set of compatible shells or a set of compatible hardware components.

The user may first select a mobile phone shell **12** from a set of mobile phone shells **12**. Referring to FIG. 5, the user may select from a list **51** of shells, for example, shown on a display **114**. The user may select from the list **51** by selecting or clicking on the text, checking a box, selecting a radio button, or any other suitable method of selection. Referring to FIG. 1, the user may select from one or more images **53**, **55** of the mobile phone shells **12**, for example, shown on a display **114**. The list or images of the mobile phone shells **12** may be provided by and caused to be displayed by the server **102**. The set of shells **12** may include different styles, shapes, and sizes of mobile phone shells. The user may select a mobile phone shell **12** based on at least one of size, volume, and shape. The user may also provide or select a weight preference information (e.g., preferred weight of the mobile phone, a preferred weight range of the mobile phone, a priority of the weight of

11

the mobile phone relative to other factors, etc.). The user may also provide or select a cost preference information (e.g., preferred cost or price of the mobile phone, a preferred cost or price range of the mobile phone, a priority of the cost or price the mobile phone relative to other factors, etc.).

The user selection may be sent from the client 110 to the server 102 as shell selection information. If provided, the weight preference information and the cost preference information may also be sent from the client 110 to the server 102. The server 102, in turn, receives the shell selection information, weight preference information, and/or the cost preference information. The server 102 may generate or identify a subset of all available hardware components based on a compatibility between hardware components 24 and the shell corresponding to the shell selection information. According to another embodiment, the server 102 may receive the generated set of hardware components 24 from another computer.

The compatibility between the mobile phone shell 12 and the selectable or interchangeable hardware components 24 may be based on at least one size value (e.g., length, width, thickness, area, volume, shape, etc.). For example, the volume of the thicker hardware component 24e of FIG. 4C would not fit within the thinner shell 12 of FIG. 4A. Similarly, the complex hardware component 24f of FIG. 4D would not fit within the shells 12 of FIG. 3 or 4A. The compatibility may be based on at least one of the number and arrangement of receivers 22 and electrical contacts 26 available in the shell 12 that corresponds to the shell selection information. If received, compatibility may be based on the weight preference information and/or the cost preference information.

The server 102 may then provide a subset of hardware components 24 that are compatible with the selected mobile phone shell 12. Referring to FIGS. 6 and 7, the subset of compatible hardware components 24 may be provided as a list 61 or as an image 70. The server may also provide an auxiliary information relating to the hardware components 24. For example, the list 61 or image 70 may also include a size, a weight, a cost, a rating, and a backlog (i.e., time until delivery) of the hardware component. The subset of selectable hardware components 24 which are incompatible with the shell selection information (e.g., are not part of the subset of compatible hardware components 24 generated based on a compatibility between hardware components 24 and the selected shell 24) may either not be provided or may be provided along with an indicia of incompatibility (e.g., strikethrough, grayed out, dashed outline, etc.). According to another embodiment, the subset of hardware components 24 may be stored to a memory for use in a non-graphical process, e.g., an order fulfillment system. For example, the output may be provided to an assembly facility as described further below.

The system may also provide an indication that the compatibility of a hardware component 24 with the shell selection information is dependent upon one or more criteria. For example, the server 102 may provide an indication that a second hardware component 24b may not also fit in the selected mobile phone shell due to the size of a first hardware component 24a. Referring briefly to FIG. 7, the server 102 may provide an indication 78 that a power hungry hardware component (e.g., heart monitor hardware component 76) requires a larger battery (e.g., XL battery hardware component 74). The server 102 may provide an indication that two power hungry hardware components should not both be installed into the same mobile phone. The server 102 may provide an indication 79 that a hardware component 24 is incompatible with the selected shell 12 or may be compatible

12

with a different shell 12. For example, the server 102 may suggest that a popular hardware component 24 is compatible with a mobile phone shell 12 that is thicker or longer than the presently selected shell.

5 The provided subset of hardware components 24 may include individual hardware components 24 or combinations of hardware components compatible with the shell selection information. One combination may include related items, for example, a mini-USB connector, a mini-DisplayPort connector, and a mini-HDMI connector. Another combination may include a power hungry hardware component and a larger battery. Another combination may be profession specific; for example, a heart monitor hardware component and an ultrasonographic transducer hardware component. Another combination may include specifically packaged hardware components; for example, a larger battery being longer rather than thicker in order to fit in the selected shell with another hardware component. Yet another combination may include a speaker hardware component and a microphone hardware component.

The user may further customize the mobile phone 10 by selecting at least one compatible hardware component 24 from the set or subset of hardware components that are compatible with the selected shell 12. Referring to FIG. 7, a user may select the desired hardware component 24 by placing (e.g., moving, dragging, etc.) an image 80 of a hardware component 24 in an image 70 of the selected mobile phone shell 12. For example, the user may drag the "RAM" hardware component 71 from its location on the right side of the display 114 to one of the available receiver 22a-d locations. The user may reconfigure the interchangeable hardware components 24 as desired. For example, a right-handed user may put a mini-USB connector hardware component 73 on the right side of the shell 12 in order to facilitate connection and disconnection of a USB cable or device. The user selection may be sent from the client 110 to the server 102 as a first hardware selection information, and the server 102, in turn, may receive the first hardware selection information.

40 According to various other embodiments, the system may receive other types of information, for example, prior use information, rating information, manufacturing information, etc. Prior use information may include how often the battery was charged, the depth of the mean or median battery cycle, number of calls received, number of calls dropped, number of text messages sent, acceleration data, etc. The prior use information may be provided by a user, retrieved from the user's account information, or retrieved from the user's current phone. For example, the prior use information may be retrieved from a prior use recorder hardware component in the user's current mobile phone. The battery usage information may be used by the system to suggest an appropriately sized battery. The number of texts sent may be used to suggest a particular style of phone (e.g., a phone with a full keyboard) or texting plan. The acceleration (e.g., number of times the phone was dropped) may be used to suggest a more rugged shell, more rugged hardware components, a protective covering for the shell, or increased phone insurance. Rating information 63 may include ratings based on popularity, based on other users' opinions, or based on objective functionality testing. The manufacturing information may include manufacturing complexity (e.g., fitting two large hardware components tightly in a small shell) or availability of a hardware component (e.g., a backorder, or rarely purchased). The set of hardware components that are compatible with the selected shell and hardware may be updated in response to additional informations received.

13

The server 102 may then provide a set of second hardware components 24, the set of second hardware component generated based on a compatibility between the second hardware component, the first hardware selection information, and shell selection information. For example, if a user selects a small, lightweight battery as a first hardware component 24, the updated set of hardware components may not include power hungry hardware components. Similarly, if the first selected hardware component is a large component, other large components may be removed from the updated sets. The system may continue to update the sets of compatible hardware as the user selects and deselects hardware components and shell styles, shapes, and size.

According to one embodiment, a user may select a preconfigured mobile phone 10. The preconfigured mobile phone 10 includes one or more hardware components 24 already in place in a receiver 22 and may include one or more empty receivers 22. The set of preconfigured phones 10 may be provided to the user based on price, popularity, a desire to reduce inventory of particular components, cost, etc. According to one embodiment, a mobile phone 10 may be preconfigured by a designer to have a certain shell 12 (e.g., colors, logos, pattern, print, picture, texture, etc.) and hardware components 24. According to another embodiment, the phone 10 may be preconfigured with combinations of hardware components 24, as described above. A user may then select from a subset of interchangeable hardware components 24 which are compatible with the one or more empty receivers 22.

According to another embodiment, the user may first select one or more hardware components 24. The user may select from a list 61 of hardware components 24 or from one or more images 80 of hardware components 24. The user may select the hardware components 24 individually or select a predefined combination of hardware components 24. The user is then provided with a set of mobile phone shells 12 generated based on a compatibility between the mobile phone shells 12 and the selected hardware components 24. The set of mobile phone shells 12 may be provided as a list 51 or as one or more images 53, 55. The compatibility may be based on at least one size value (e.g., length, area, thickness, volume, etc.), the number or orientation of receivers 22 or electrical contacts 26 within the shell, etc. The user may also provide or select cost preference information, weight preference information, or shell preference information (e.g., a shell style, shell shape, shell size, shell color, etc.). These preferences may be factored into determining the set of mobile phone shells 12 to be provided to the user.

The set of mobile phone shells 12 provided may be standard or custom shells. For example, after selecting certain "must have" hardware components 24 which do not fit in one of the available shells 12, the user may be given the option of having a custom shell 12 made to fit the components.

As described above, the system may provide an indication of dependency between certain hardware components 24 and between certain hardware components 24 and shells 12. The server 102 may also provide an indication that a particular hardware component 24 is causing an incompatibility with a shell 12. For example, if the user picked one thick hardware component 24, the system may provide an indication that that thick hardware component is preventing the selection of a thin mobile phone shell 12. The server 102 may further provide a suggestion of alternative components which may have the same functionality, but solve the incompatibility. Further, suggestions may be based on optimizations of space, weight, cost, etc. Besides using an optimization approach, heuristic, rule-based, or other ad-hoc approaches may be used to generate suggestions. For example, a user may have selected an

14

inexpensive but larger hardware component 24, and the system may suggest the more expensive but smaller hardware component. The smaller hardware component 24 may then be compatible with thinner or otherwise smaller mobile phone shells 12.

The system may be configured to update the sets or subsets of selectable hardware components 24 and shells 12 in substantially real time. For example, upon selecting a first hardware component 24, the system may remove or indicate incompatibility of a subset of mobile phone shells 12. Or upon deselecting a hardware component 24, the system can cause other hardware components 24 and mobile phone shells 12 to be shown as compatible. According to one embodiment, selection of a hardware component 24 having a large volume may remove a mobile phone shell 12 having a small volume from possible selection. Thus a user may see how each hardware component 24 affects his or her options for mobile phone shells 12. After selecting a shell 12, the set of compatible hardware components 24 may be updated. For example, the system may provide a subset of hardware components 24 which are compatible with the previously selected hardware components 24 and the selected mobile phone shell 12. The user may continue to select additional hardware components 24 to fill out the remaining receivers 22a-d. Compatibility subsets, indications of dependency, and suggestions, may be updated with each additional selection.

According to another embodiment, the client 110 of FIG. 8 may download mobile phone shell set data, hardware component set data, compatibility data, dependency data, and other necessary information for mobile phone customization from one or more servers 102. For example, the compatibility module 134 on the server 102 may be configured to provide phone shell set data, hardware component set data, compatibility data, and dependency data to a client 110. The customization module 132 on the client 110 may then receive information (e.g., selection information, preference information, etc.) from the user input device 116 or user interface module 130. The customization module 132 may then generate sets of shells 12 and hardware components 24 based on compatibility and provide the sets to processor 122, display 114, output 150, or another module. For example, the user may select a mobile phone shell 12 from a set of mobile phone shells 12, and the customization module 132 generates a subset of interchangeable hardware components 24 having different functions, the subset of interchangeable hardware components 24 being generated based on the compatibility between the selected mobile phone shell 12 and the set of available interchangeable hardware components 24.

Using the systems and methods described herein, one may offer to sell a hardware customizable mobile phone 110 with selectable hardware components 24 to fit within a shell 12. The seller may offer one or more mobile phone shells 12, and the seller may receive a selection of a mobile phone shell. The seller may offer a one or more selectable options for at least one hardware component 24 configured to fit within the mobile phone shell 12, and the seller may receive a selection of at least one hardware component configured to fit within the shell.

According to one embodiment, a seller may provide a price discount on a mobile phone 10 in exchange for the buyer purchasing a mobile phone 10 with a certain hardware component 24. According to another embodiment, a lessor may provide a discounted mobile phone 10 to a lessee if the mobile phone 10 contains an accident data recorder hardware component or a prior use information recorder hardware component. The accident data recorder or prior use information recorder hardware components may have a particular con-

15

figuration (e.g., shape, electrical contacts, encryption key, lock, etc.) which corresponds to a particular receiver **22** in the mobile phone **10**; thus making removing or replacing the recorder hardware component prohibitively difficult.

Further using the systems and methods described herein, an aftermarket customizer may sell interchangeable hardware components **24**. For example, if a user already has a customizable mobile phone **10**, the user may use a system to determine if another interchangeable hardware component **24** will fit in their mobile phone **10**. It is contemplated that some original equipment manufacturers will use hardware or software locks on the interchangeable hardware components **24** or the receivers **22** in the mobile phone shells **12** in order to inhibit the use of uncertified or counterfeit hardware components **24**.

The selected shell and hardware components may be provided to an assembler (e.g., assembly facility, manufacturer, manufacturing facility, etc.). The assembler may receive one or more styles, shapes, or sizes of mobile phone shells **12**. The assembler may also receive a plurality of interchangeable hardware components **24** which are configured to fit with the mobile phone shells **12**. Then the assembler may assemble one or more interchangeable hardware components **24** into a mobile phone shell **12** in response to an order. The hardware customizable mobile phone **10** may be assembled in response to a specific customization (e.g., by an end-user) or in response to a general order. For example, a retailer may order several of a particular configuration due to its popularity. Another retailer may order a particular configuration because a certain celebrity has that configuration.

Referring to FIG. **10**, a flowchart of a process **200** for customizing hardware for a mobile phone is shown, according to an exemplary embodiment. Process **200** is shown to include the steps of receiving shell selection information from a user input device (step **202**), identifying a set of hardware components, the set of hardware components generated based on a compatibility between the hardware components and the shell selection information (step **204**), and outputting the set of identified compatible hardware components (step **206**). For example, according various embodiments, the step **202** of receiving the shell selection information includes receiving from a memory, a communication interface, or user input device; the step **204** of identifying the set of hardware components may be performed at processing electronics; and the step **206** of outputting the set of components includes outputting to a memory, display interface, or communication interface.

Referring to FIG. **11**, a flowchart of a process **210** for customizing hardware for a mobile phone is shown, according to an exemplary embodiment. Process **210** is shown to include the steps of providing a set of mobile phone shells (step **212**), receiving shell selection information (step **214**), identifying a set of hardware components, the set of hardware components generated based on a compatibility between the hardware components and the shell selection information (step **220**), and outputting the set of identified compatible hardware components (step **222**). Process **210** may also include one or more of the steps of receiving weight preference information (step **216**) and receiving cost preference information (step **218**).

Referring to FIG. **12**, a flowchart of a process **230** for customizing hardware for a mobile phone is shown, according to an exemplary embodiment. Process **230** is shown to include the steps of receiving shell selection information (step **232**), identifying a set of hardware components, the set of hardware components generated based on a compatibility between the hardware components and the shell selection

16

information (step **234**), outputting the set of identified compatible hardware components (step **236**), receiving first hardware selection information (step **238**), identifying a set of compatible second hardware components, the set of second hardware components generated based on a compatibility between the second hardware components, the first hardware selection information, and the shell selection information (step **240**), and outputting the set of identified second compatible hardware components (step **242**). Process **230** may further include the step of providing an indication that the compatibility of a hardware component with the shell selection information is dependent upon one or more criteria (step **244**).

Referring to FIG. **13**, a flowchart of a process **300** for customizing hardware for a mobile phone is shown, according to an exemplary embodiment. Process **300** is shown to include the steps of receiving hardware component selection information (step **302**), identifying a set of compatible mobile phone shells, the set of mobile phone shells generated based on a compatibility between the mobile phone shells and the hardware component selection information (step **304**), and outputting the identified set of compatible mobile phone shells (step **306**). For example, according various embodiments, the step **302** of receiving the hardware component selection information includes receiving from a memory, a communication interface, or user input device; the step **304** of identifying the set of mobile phone shells may be performed by processing electronics; and the step **306** of outputting the set of mobile phone shells includes outputting to a memory, display interface, or communication interface.

Referring to FIG. **14**, a flowchart of a process **310** for customizing hardware for a mobile phone is shown, according to an exemplary embodiment. Process **310** is shown to include the steps of providing a set of hardware components (step **312**), receiving hardware component selection information (step **314**), identifying a set of compatible mobile phone shells, the set of mobile phone shells generated based on a compatibility between the mobile phone shells and the hardware component selection information (step **320**), and outputting the identified set of compatible mobile phone shells (step **322**). Process **310** may also include one or more of the steps of receiving weight preference information (step **316**) and receiving cost preference information (step **318**).

Referring to FIG. **15**, a flowchart of a process **330** for customizing hardware for a mobile phone is shown, according to an exemplary embodiment. Process **330** is shown to include the steps of receiving hardware component selection information (step **332**), identifying a set of mobile phone shells, the set of mobile phone shells generated based on a compatibility between the mobile phone shells and the hardware component selection information (step **334**), outputting the identified set of compatible mobile phone shells (step **336**), receiving shell selection information (step **338**), identifying a set of second compatible hardware components, the set of second hardware components generated based on a compatibility between the second hardware components, the hardware component selection information, and the shell selection information (step **340**), and outputting the set of second compatible hardware components (step **342**). Process **330** may further include the step of providing an indication that the compatibility of a mobile phone shell with the hardware component selection information is dependent upon one or more criteria (step **340**).

Referring to FIG. **16**, a flowchart of a process **350** for customizing hardware for a mobile phone is shown, according to an exemplary embodiment. Process **350** is shown to include the steps of receiving hardware component selection

information (step 352), receiving shell preference information (step 354), identifying a set of mobile phone shells, the set of mobile phone shells generated based on a compatibility between the mobile phone shells, the hardware component selection information, and the shell preference information (step 356), and outputting the identified set of mobile phone shells (step 358). According to various embodiments, the shell preference information may include a shell shape, shell style, and shell size.

Referring to FIG. 17, a flowchart of a process 400 for customizing hardware for a mobile phone is shown, according to an exemplary embodiment. Process 400 is shown to include the steps of selecting a mobile phone shell from a set of mobile phone shells (step 402) and selecting at least one hardware component from a subset of interchangeable hardware components having different functions, the subset of interchangeable hardware components generated based on a compatibility between the selected mobile phone shell and the set of available interchangeable hardware components (step 404).

Referring to FIG. 18, a flowchart of a process 410 for customizing hardware for a mobile phone is shown, according to an exemplary embodiment. Process 410 is shown to include the steps of selecting a mobile phone shell from a set of mobile phone shells (step 412) and selecting at least one hardware component from a subset of interchangeable hardware components having different functions, the subset of interchangeable hardware components generated based on a compatibility between the selected mobile phone shell and the set of available interchangeable hardware components (step 418). Process 410 may also include one or more of the steps of providing weight preference information (step 414) and providing cost preference information (step 416).

Referring to FIG. 19, a flowchart of a process 420 for customizing hardware for a mobile phone is shown, according to an exemplary embodiment. Process 420 is shown to include the steps of selecting a preconfigured mobile phone from a set of mobile phone shells, the preconfigured mobile phone including at least one empty portion configured to receive an interchangeable hardware component (step 422) and selecting at least one hardware component from a subset of interchangeable hardware components having different functions, the subset of interchangeable hardware components generated based on a compatibility between the selected mobile phone shell and the set of available interchangeable hardware components (step 424).

Referring to FIG. 20, a flowchart of a process 430 for customizing hardware for a mobile phone is shown, according to an exemplary embodiment. Process 430 is shown to include the steps of selecting a mobile phone shell from a set of mobile phone shells (step 432), causing an image of at least one hardware component from a subset of interchangeable hardware components to move from a first location to a second location, the second location corresponding to a portion within the selected mobile phone shell and the subset of interchangeable hardware components generated based on a compatibility between the selected mobile phone shell and the set of available interchangeable hardware components (step 434), and selecting at least one hardware component from a subset of interchangeable hardware components having different functions (step 436).

Referring to FIG. 21, a flowchart of a process 500 for selling a mobile phone is shown, according to an exemplary embodiment. Process 500 is shown to include the steps of offering to sell a hardware customizable mobile phone with one or more selectable hardware components configured to fit within a shell (step 502), offering a plurality of selectable

options for at least one hardware component configured to fit within the shell (step 504), and receiving a selection of at least one hardware component configured to fit within the shell (step 506).

Referring to FIG. 22, a flowchart of a process 510 for selling a mobile phone is shown, according to an exemplary embodiment. Process 510 is shown to include the steps of offering to sell a hardware customizable mobile phone with one or more selectable hardware components configured to fit within a shell (step 512), receiving prior user information (step 514), offering a plurality of selectable options for at least one hardware component configured to fit within the shell (step 516), and receiving a selection of at least one hardware component configured to fit within the shell (step 518).

Referring to FIG. 23, a flowchart of a process 520 for selling a mobile phone is shown, according to an exemplary embodiment. Process 520 is shown to include the steps of offering to sell a hardware customizable mobile phone with one or more selectable hardware components configured to fit within a shell (step 522), offering a plurality of selectable options for at least one hardware component configured to fit within the shell (step 524), and receiving a selection of at least one hardware component configured to fit within the shell (step 532). Process 520 may also include one or more of the steps of offering a plurality of selectable options for at least one hardware component configured to fit within the shell based on manufacturing complexity (step 526), offering a plurality of selectable options for at least one hardware component configured to fit within the shell based on availability of the hardware component (step 528), and offering a plurality of selectable options for at least one hardware component configured to fit within the shell based on a rating of the hardware component (step 530).

Referring to FIG. 24, a flowchart of a process 600 for customizing hardware for a mobile phone is shown, according to an exemplary embodiment. Process 600 is shown to include the steps of receiving from an end-user a selection of a mobile phone shell from a set of mobile phone shells (step 602), sending to the end-user a subset of interchangeable hardware components having different functions, the subset of interchangeable hardware components generated based on a compatibility between the selected mobile phone shell and the set of available interchangeable hardware components (step 604), and receiving from the end-user a selection of at least one hardware component from the subset of interchangeable hardware components (step 606).

Referring to FIG. 25, a flowchart of a process 610 for customizing hardware for a mobile phone is shown, according to an exemplary embodiment. Process 610 is shown to include the steps of receiving over a computer network from an end-user a selection of a mobile phone shell from a set of mobile phone shells (step 612), sending over a computer network to the end-user a subset of interchangeable hardware components having different functions, the subset of interchangeable hardware components generated based on a compatibility between the selected mobile phone shell and the set of available interchangeable hardware components (step 620), and receiving over a computer network from the end-user a selection of at least one hardware component from the subset of interchangeable hardware components (step 622). The process 610 may also include the steps of receiving over a computer network from the end-user a weight preference information (step 614), receiving over a computer network from the end-user a cost preference information (step 616), and receiving over a computer network from the end-user a selection of a preconfigured mobile phone from the set of mobile phone shells, the preconfigured mobile phone includ-

ing at least one empty portion configured to receive an interchangeable hardware component (step 618).

It is also important to note that the construction and arrangement of the systems and methods as shown in the exemplary embodiments are illustrative only. Although only a few embodiments have been described in detail, those skilled in the art who review this disclosure will readily appreciate that many modifications are possible (e.g., variations in sizes, dimensions, structures, shapes and proportions of the various elements, values of parameters, mounting arrangements, use of materials, colors, orientations, etc.) without materially departing from the novel teachings and advantages of the subject matter recited. For example, elements shown as integrally formed may be constructed of multiple parts or elements. It should be noted that the elements and assemblies disclosed herein may be constructed from any of a wide variety of materials that provide sufficient strength or durability, in any of a wide variety of colors, textures, and combinations. Additionally, in the subject description, the word “exemplary” is used to mean serving as an example, instance or illustration. Any embodiment or design described herein as “exemplary” is not necessarily to be construed as preferred or advantageous over other embodiments or designs. Rather, use of the word exemplary is intended to present concepts in a concrete manner. Accordingly, all such modifications are intended to be included within the scope of the present inventions. The order or sequence of any process or method steps may be varied or re-sequenced according to alternative embodiments. Other substitutions, modifications, changes, and omissions may be made in the design, operating conditions, and arrangement of the preferred and other exemplary embodiments without departing from scope of the present disclosure or from the scope of the appended claims.

The present disclosure contemplates methods, systems and program products on any machine-readable media for accomplishing various operations. The embodiments of the present disclosure may be implemented using existing computer processors, or by a special purpose computer processor for an appropriate system, incorporated for this or another purpose, or by a hardwired system. Embodiments within the scope of the present disclosure include program products comprising machine-readable media for carrying or having machine-executable instructions or data structures stored thereon. Such machine-readable media can be any available media that can be accessed by a general purpose or special purpose computer or other machine with a processor. By way of example, such machine-readable media can comprise RAM, ROM, EPROM, EEPROM, CD-ROM or other optical disk storage, magnetic disk storage or other magnetic storage devices, or any other medium which can be used to carry or store desired program code in the form of machine-executable instructions or data structures and which can be accessed by a general purpose or special purpose computer or other machine with a processor. When information is transferred or provided over a network or another communications connection (either hardwired, wireless, or a combination of hardwired or wireless) to a machine, the machine properly views the connection as a machine-readable medium. Thus, any such connection is properly termed a machine-readable medium. Combinations of the above are also included within the scope of machine-readable media. Machine-executable instructions include, for example, instructions and data which cause a general purpose computer, special purpose computer, or special purpose processing machines to perform a certain function or group of functions.

Although the figures may show a specific order of method steps, the order of the steps may differ from what is depicted.

Also two or more steps may be performed concurrently or with partial concurrence. Such variation will depend on the software and hardware systems chosen and on designer choice. All such variations are within the scope of the disclosure. Likewise, software implementations could be accomplished with standard programming techniques with rule based logic and other logic to accomplish the various connection steps, processing steps, comparison steps and decision steps.

What is claimed is:

1. A handheld-device platform comprising:

a generally rigid structure or housing configured to be grasped by a human user and including a plurality of hardware module receivers;

the plurality of hardware module receivers each configured to removably receive and electrically couple with a respective interchangeable hardware module selected from at least two interchangeable hardware modules, at least two hardware module receivers of the plurality of hardware module receivers each have a different size value; and

processing electronics configured to communicate with each respective interchangeable hardware module removably received and electrically coupled with a hardware module receiver of the plurality of hardware module receivers,

wherein a first hardware module receiver of the plurality of hardware module receivers includes a first dimensional configuration allowing it to removably receive and electrically couple with one of a first group of the at least two interchangeable hardware modules but not with a second group of the at least two interchangeable hardware modules having a second dimensional configuration.

2. The handheld-device platform of claim 1, wherein the processing electronics are integrated with the generally rigid structure or housing.

3. The handheld-device platform of claim 1, wherein the first hardware module receiver is a member of a first group of at least two first hardware module receivers each having a substantially same dimensional configuration.

4. The handheld-device platform of claim 3, wherein the first hardware module receiver is a member of a first group of at least two hardware module receivers each having a substantially same first receiver footprint size dimensions.

5. The handheld-device platform of claim 1, wherein the removably receive includes physically inserted, installed, or snapped in.

6. The handheld-device platform of claim 1, wherein the removably receive includes physically supported.

7. The handheld-device platform of claim 1, wherein the plurality of hardware module receivers each include a socket configured to removably receive and electrically couple with a respective interchangeable hardware module.

8. The handheld-device platform of claim 1, wherein the plurality of hardware module receivers include a plurality of standardized hardware module receivers.

9. The handheld-device platform of claim 1, wherein the plurality of hardware module receivers each include at least two electrical contacts configured to communicate with corresponding electrical contacts of an interchangeable hardware module.

10. The handheld-device platform of claim 9, wherein the respective at least two electrical contacts of each of the plurality of hardware module receivers include a standardized number and arrangement of at least two electrical contacts.

11. The handheld-device platform of claim 1, wherein the processing electronics are configured to communicatively

21

couple each hardware module receiver of the plurality of hardware module receivers with the processing electronics using a standardized protocol.

12. The handheld-device platform of claim 1, wherein the processing electronics includes a communication bus or network.

13. The handheld-device platform of claim 1, wherein the handheld-device platform includes a mobile cellular telephone platform.

14. The handheld-device platform of claim 1, wherein the plurality of hardware module receivers and the processing electronics have a bus modular architecture allowing the number and locations of interchangeable hardware modules electronically coupled with the at least two hardware module receivers to vary.

15. An interchangeable hardware module for a mobile communication device, the hardware module comprising:

a housing configured to be grasped by a human user, and configured to removably engage and electrically couple with a hardware module receiver of a mobile device; an electrical circuit having a selected functionality; and electronics configured to communicatively couple with a processing electronics of the mobile communication device,

wherein the mobile device, the electrical circuit, and the electronics of the hardware module all comply with a hardware module interchangeability standard, and

wherein the hardware interchangeability standard governs

(i) a dimensional configuration providing the removable engagement with the hardware module receiver, (ii) a configuration of electrical contacts providing the electrical coupling with a hardware module receiver, and (iii) a protocol for communicating between the processing electronics of the hardware module and the processing electronics of the mobile communication device.

16. The hardware module of claim 15, wherein the interchangeability standard governing the dimensional configuration includes (a) a first dimensional configuration providing a first removable engagement with a first hardware module receiver of the mobile communication device and (b) a second dimensional configuration providing a second removable engagement with a second hardware module receiver of the mobile communication device, the second dimensional configuration different from the first dimensional configuration.

17. The hardware module of claim 15, wherein the interchangeability standard governing the configuration of electrical contacts providing the electrical coupling with a hardware module receiver includes a standardized number and arrangement of electrical contacts.

18. The hardware module of claim 15, wherein the interchangeable hardware module includes a computer code.

19. The hardware module of claim 18, wherein the electronics of the hardware module is configured to communicate with the processing electronics of the mobile communication device.

20. A mobile phone, comprising:

a shell having a generally rigid structure or housing configured to be grasped by a user, and including:

at least two first receiver portions each configured to removably couple with a respective first interchangeable hardware module having a first size value, each respective first interchangeable hardware module selectable from at least two first interchangeable hardware modules having the first size value and having different functions; and

at least two second receiver portions each configured to removably couple with a respective second inter-

22

changeable hardware module having a second size value, each respective second interchangeable hardware module selectable from at least two second interchangeable hardware modules having the second size value and having different functions; and

processing electronics including a processor and a memory configured to communicate with each first interchangeable hardware module respectively removably coupled with the at least two first receiver portions and with each second interchangeable hardware module respectively removably coupled with the at least two second receiver portions.

21. The mobile phone of claim 20, wherein the at least two first receiver portions are each configured to physically receive and removably couple with a respective first interchangeable hardware module.

22. The mobile phone of claim 20, wherein the first size includes a first receiver footprint size dimensions.

23. The mobile phone of claim 20, wherein the at least two first receiver portions are configured such that another first interchangeable hardware module selected from the at least two first interchangeable modules may be interchanged with a first interchangeable hardware module removable coupled with a first receiver portion.

24. The mobile phone of claim 20, wherein the second size value is different than the first size value.

25. The mobile phone of claim 24, wherein the second size value includes a second receiver footprint size dimension.

26. The mobile phone of claim 20, wherein the at least two second receiver portions are configured such that another second interchangeable hardware module selected from the at least two second interchangeable modules may be interchanged with a second interchangeable hardware module removable coupled with a second receiver portion.

27. The mobile phone of claim 20, wherein the at least two first receiver portions, the at least two second receiver portions, and the processing electronics have a bus modular architecture allowing the number and locations of the interchangeable hardware modules electronically coupled with the at least two first hardware module receivers and the at least two second hardware module receivers to vary.

28. The mobile handheld-device platform of claim 1, where in a size value includes at least one of length, width, area, thickness, or shape.

29. The hardware module of claim 15, wherein the housing has a dimensional configuration that includes at least one of length, width, area, thickness, or shape.

30. The mobile phone of claim 20, wherein a size value includes at least one of length, width, area, thickness, or shape.

31. A handheld-device platform comprising:

a generally rigid structure or housing configured to be grasped by a human user and including a plurality of hardware module receivers;

the plurality of hardware module receivers each configured to removably receive and electrically couple with a respective interchangeable hardware module selected from at least two interchangeable hardware modules, at least two hardware module receivers of the plurality of hardware module receivers each have a different size value; and

processing electronics configured to communicate with each respective interchangeable hardware module removably received and electrically coupled with a hardware module receiver of the plurality of hardware module receivers,

wherein the generally rigid structure or housing has a first side and a second side, the first side including a hardware module receiver of the plurality of hardware receivers configured to accept an interchangeable display module and the second side including another hardware module receiver of the plurality of hardware module receivers.

32. A handheld-device platform comprising:
a generally rigid structure or housing configured to be grasped by a human user and including a plurality of hardware module receivers;

the plurality of hardware module receivers each configured to removably receive and electrically couple with a respective interchangeable hardware module selected from at least two interchangeable hardware modules, at least two hardware module receivers of the plurality of hardware module receivers each have a different size value; and

processing electronics configured to communicate with each respective interchangeable hardware module removably received and electrically coupled with a hardware module receiver of the plurality of hardware module receivers,

wherein the generally rigid structure or housing, the plurality of hardware module receivers, and the processing electronics all comply with a hardware module interchangeability standard, and

wherein the hardware module interchangeability standard specifies (i) a dimensional configuration providing the removable receiving between a hardware module receiver and an interchangeable hardware module, (ii) a configuration of electrical contacts providing the electrical coupling between a hardware module receiver and an interchangeable hardware module, and (iii) a protocol for communication between the processing electronics and an interchangeable hardware module.

33. A handheld-device platform comprising:
a generally rigid structure or housing configured to be grasped by a human user and including a plurality of hardware module receivers;

the plurality of hardware module receivers each configured to removably receive and electrically couple with a respective interchangeable hardware module selected from at least two interchangeable hardware modules, at

least two hardware module receivers of the plurality of hardware module receivers each have a different size value; and

processing electronics configured to communicate with each respective interchangeable hardware module removably received and electrically coupled with a hardware module receiver of the plurality of hardware module receivers,

wherein a second hardware module receiver of the plurality of hardware module receivers includes a second dimensional configuration allowing it to removably receive and electrically couple with one of a second group of interchangeable hardware modules but not with a first group of interchangeable hardware modules.

34. The handheld-device platform of claim **33**, wherein the second group of the at least two interchangeable hardware modules have a substantially same dimensional configuration.

35. A handheld-device platform comprising:
a generally rigid structure or housing configured to be grasped by a human user and including a plurality of hardware module receivers;

the plurality of hardware module receivers each configured to removably receive and electrically couple with a respective interchangeable hardware module selected from at least two interchangeable hardware modules, at least two hardware module receivers of the plurality of hardware module receivers each have a different size value; and

processing electronics configured to communicate with each respective interchangeable hardware module removably received and electrically coupled with a hardware module receiver of the plurality of hardware module receivers,

wherein the generally rigid structure or housing forms a generally rectangular box with at least two hardware module receivers of the plurality of hardware module receivers located on an exterior surface of a major side of the rectangular box, and

wherein another at least two hardware module receivers of the plurality of hardware module receivers are located on an exterior surface of another major side of the rectangular box.

* * * * *

UNITED STATES PATENT AND TRADEMARK OFFICE
CERTIFICATE OF CORRECTION

PATENT NO. : 9,270,808 B2
APPLICATION NO. : 14/730739
DATED : February 23, 2016
INVENTOR(S) : Chan et al.

Page 1 of 1

It is certified that error appears in the above-identified patent and that said Letters Patent is hereby corrected as shown below:

In the claims

Column 22, Line 35, Claim 26:

“removable coupled” should read --removably coupled--

Column 22, Line 44, Claim 28:

“where in” should read --wherein--

Column 22, Line 61, Claim 31:

“receivers each have a different size” should read --receivers each having a different size--

Column 23, Line 17, Claim 32:

“receivers each have a different size” should read --receivers each having a different size--

Column 24, Line 2, Claim 33:

“receivers each have a different size” should read --receivers each having a different size--

Column 24, Line 27, Claim 35:

“receivers each have a different size” should read --receivers each having a different size--

Signed and Sealed this
Third Day of May, 2016



Michelle K. Lee
Director of the United States Patent and Trademark Office