



US008965955B2

(12) **United States Patent**
Agarwal et al.

(10) **Patent No.:** **US 8,965,955 B2**
(45) **Date of Patent:** ***Feb. 24, 2015**

(54) **SYSTEMS AND METHODS FOR POLICY BASED INTEGRATION TO HORIZONTALLY DEPLOYED WAN OPTIMIZATION APPLIANCES**

(75) Inventors: **Mugdha Agarwal**, Bareilly (IN);
Akshat Choudhary, Bangalore (IN);
Ajay Soni, San Jose, CA (US)

(73) Assignee: **Citrix Systems, Inc.**, Fort Lauderdale, FL (US)

(*) Notice: Subject to any disclaimer, the term of this patent is extended or adjusted under 35 U.S.C. 154(b) by 740 days.

This patent is subject to a terminal disclaimer.

(21) Appl. No.: **12/645,796**

(22) Filed: **Dec. 23, 2009**

(65) **Prior Publication Data**

US 2011/0153721 A1 Jun. 23, 2011

(51) **Int. Cl.**

G06F 15/16 (2006.01)
H04L 29/08 (2006.01)
H04L 29/06 (2006.01)

(52) **U.S. Cl.**

CPC **H04L 67/2814** (2013.01); **H04L 69/16** (2013.01); **H04L 67/2819** (2013.01); **H04L 67/2842** (2013.01); **H04L 69/22** (2013.01); **H04L 69/161** (2013.01)

USPC **709/203**; 709/218

(58) **Field of Classification Search**

USPC 709/203
See application file for complete search history.

(56) **References Cited**

U.S. PATENT DOCUMENTS

7,349,979	B1	3/2008	Cieslak et al.	
7,983,419	B2 *	7/2011	Fan et al.	380/255
8,077,622	B2 *	12/2011	Kondamuru et al.	370/237
8,560,695	B2 *	10/2013	Degaonkar et al.	709/226
2007/0239886	A1	10/2007	Montemayor et al.	
2008/0205445	A1 *	8/2008	Kumar et al.	370/469
2008/0225722	A1	9/2008	Khemani et al.	

(Continued)

OTHER PUBLICATIONS

International Search Report on PCT/US2010/061620 dated Aug. 30, 2011.

(Continued)

Primary Examiner — Brian P Whipple

Assistant Examiner — James Edwards

(74) *Attorney, Agent, or Firm* — Foley & Lardner LLP; Christopher J. McKenna; Shabbi S. Khan

(57) **ABSTRACT**

The present disclosure presents systems and methods for policy based redirection of network traffic, by an intermediary device, to a horizontally deployed WAN device. An intermediary receives a request from a client to access a server. The request was previously modified by a first WAN device to include information in a first option field of a transport layer. The intermediary may determine, responsive to a redirection policy, to send the request to a second WAN optimization device deployed horizontally from the intermediary, instead of the server. The intermediary transmits the request to the second WAN optimization device, while maintaining the information from the first option field. The intermediary device receives the request including the information in the first option field identifying the first WAN optimization device to the second WAN optimization device. The intermediary receives a modified request from the second WAN device, the modified request determined by the intermediary to be sent to the destination server.

20 Claims, 18 Drawing Sheets

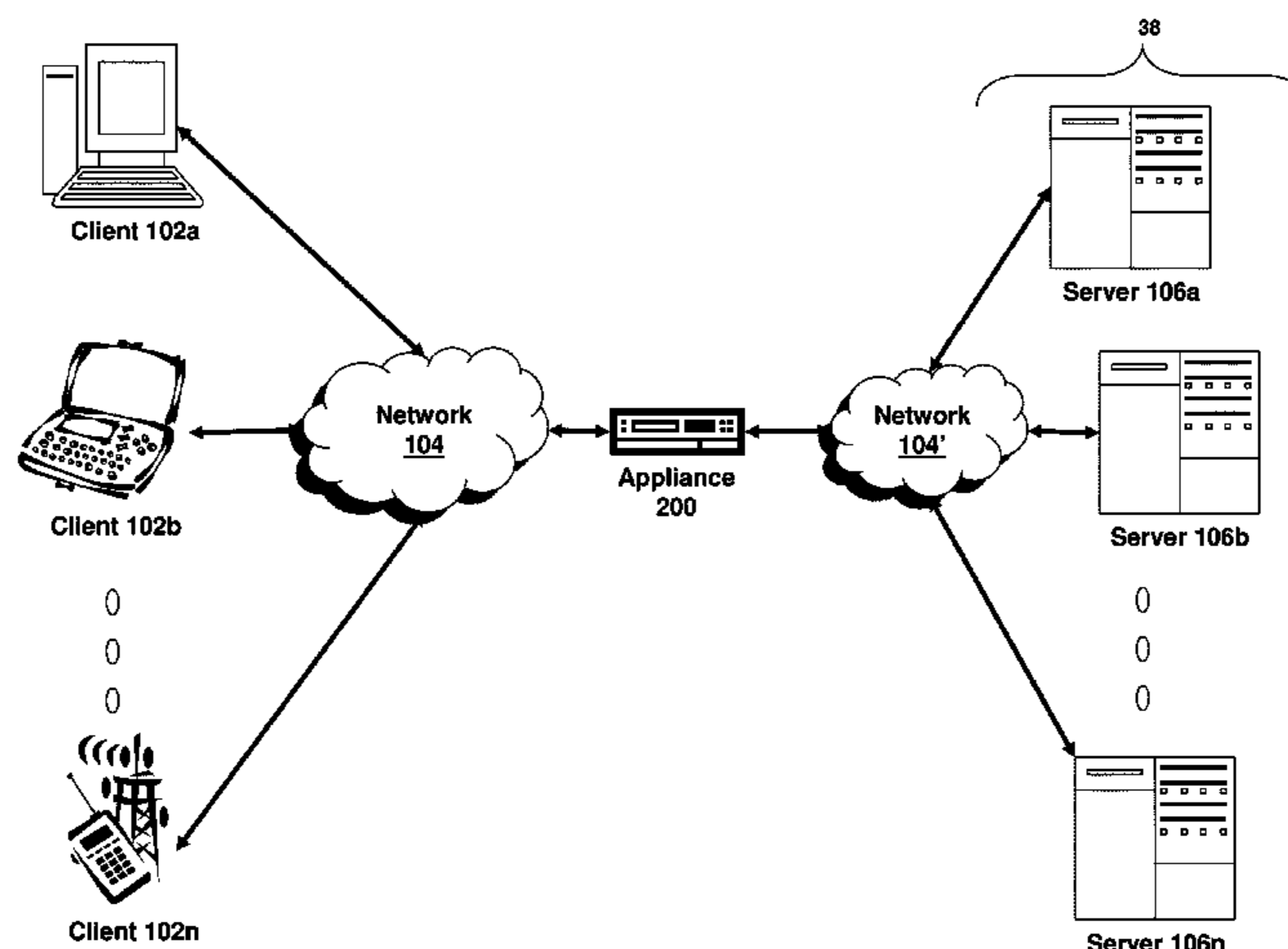

(56)

References Cited

U.S. PATENT DOCUMENTS

2008/0229021 A1* 9/2008 Plamondon 711/125
2008/0250099 A1* 10/2008 Shen et al. 709/203
2008/0281908 A1* 11/2008 McCanne et al. 709/203
2009/0067440 A1 3/2009 Chadda et al.
2010/0146074 A1* 6/2010 Srinivasan 709/218
2010/0281112 A1* 11/2010 Plamondon 709/203

2011/0125892 A1* 5/2011 Rajan et al. 709/224
2012/0036190 A1* 2/2012 Samuels et al. 709/204
2014/0032750 A1* 1/2014 Degaonkar et al. 709/224

OTHER PUBLICATIONS

Written Opinion on PCT/US2010/061620 dated Aug. 30, 2011.
Extended European Search Report issued Jul. 9, 2013 in European
Patent Application No. 10840081.3.

* cited by examiner

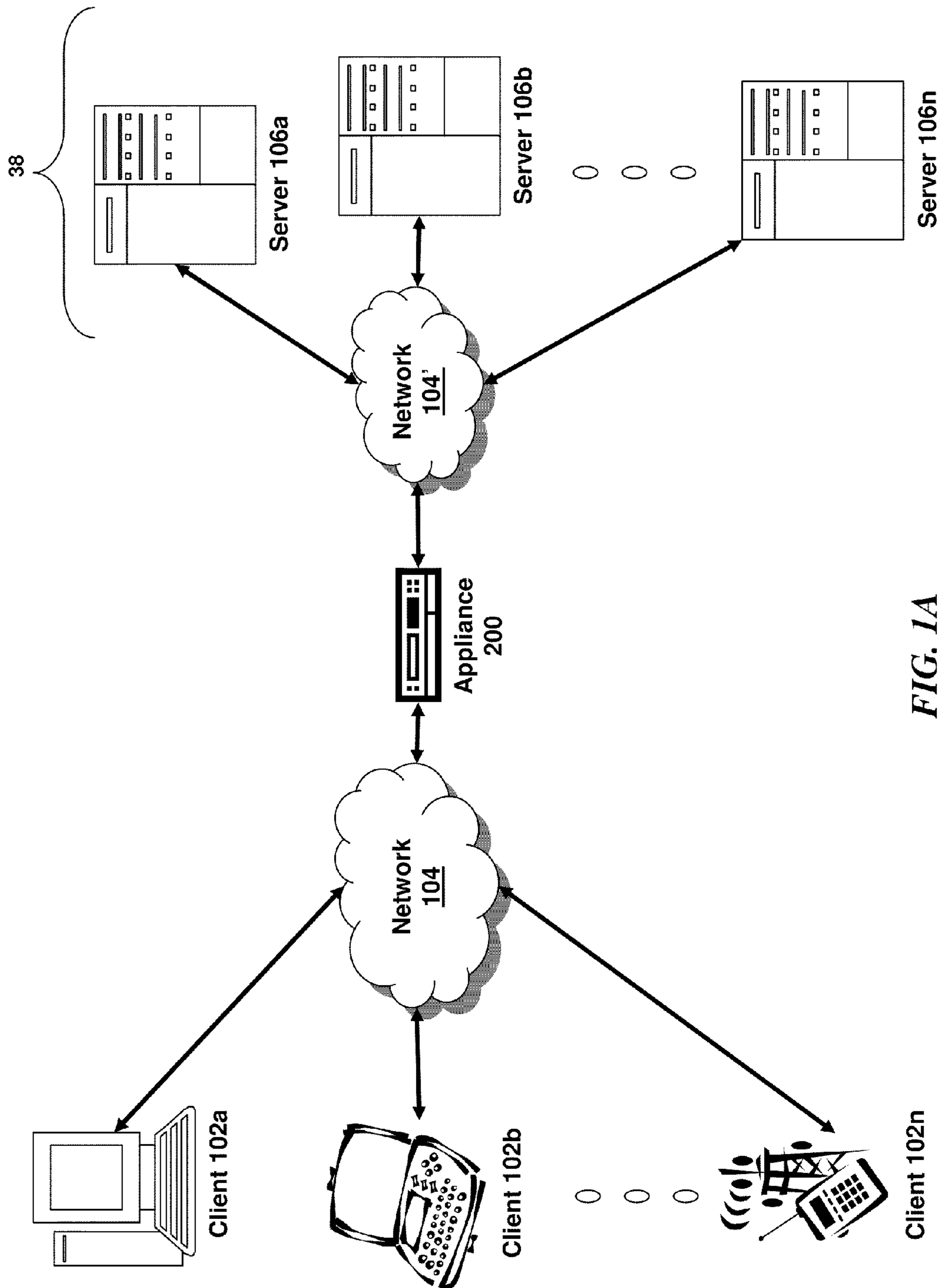

FIG. 1A

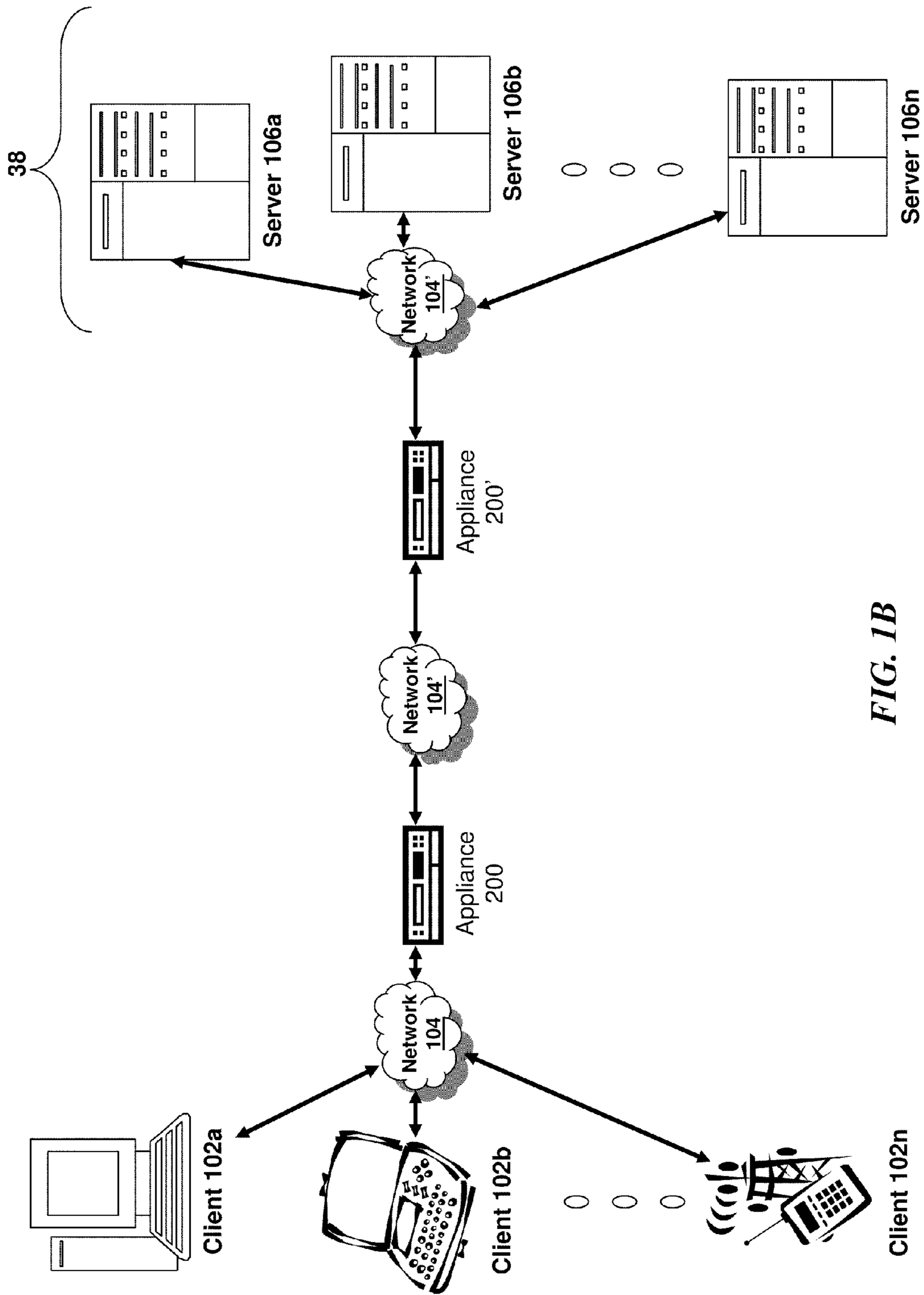

FIG. 1B

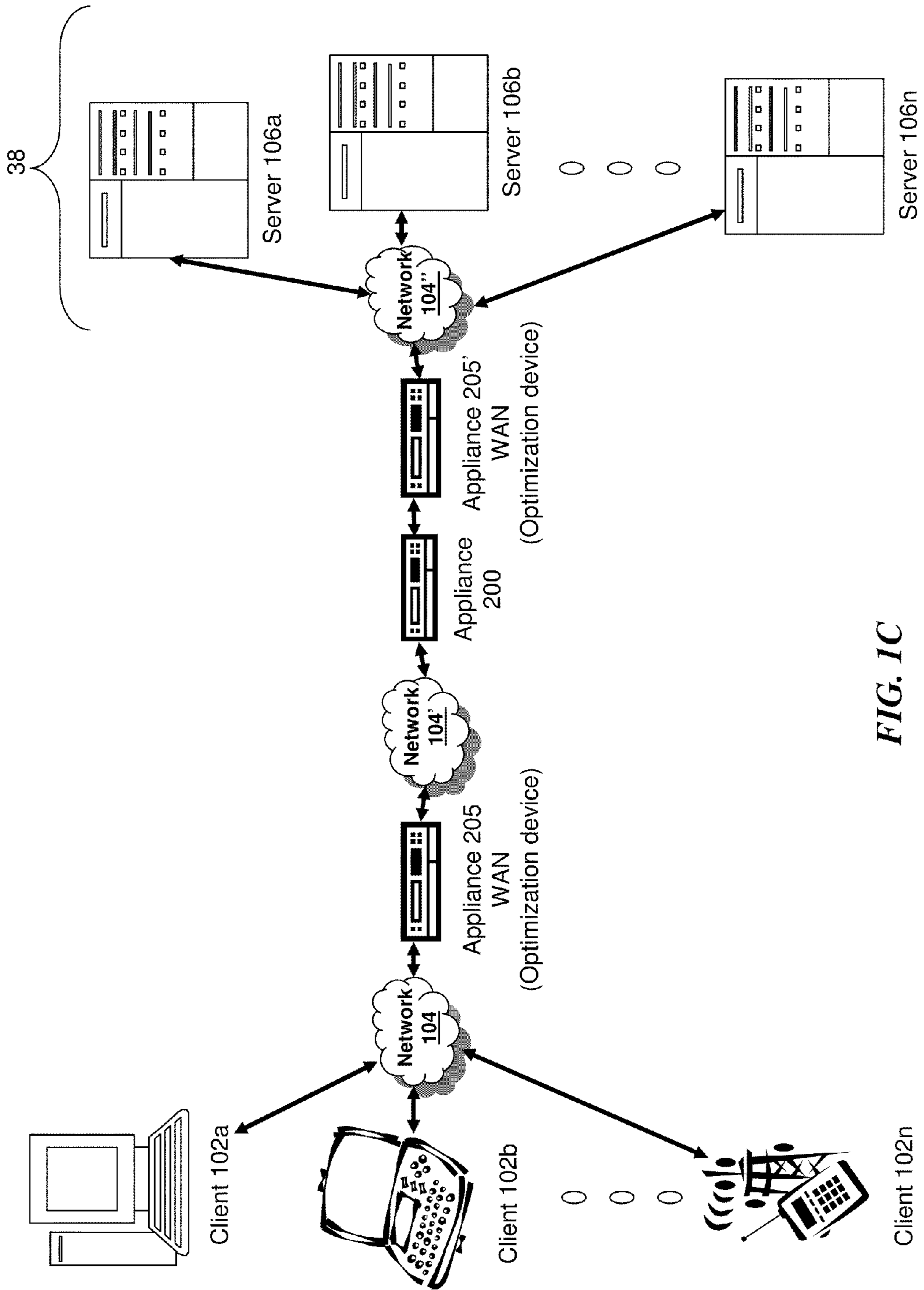

FIG. 1C

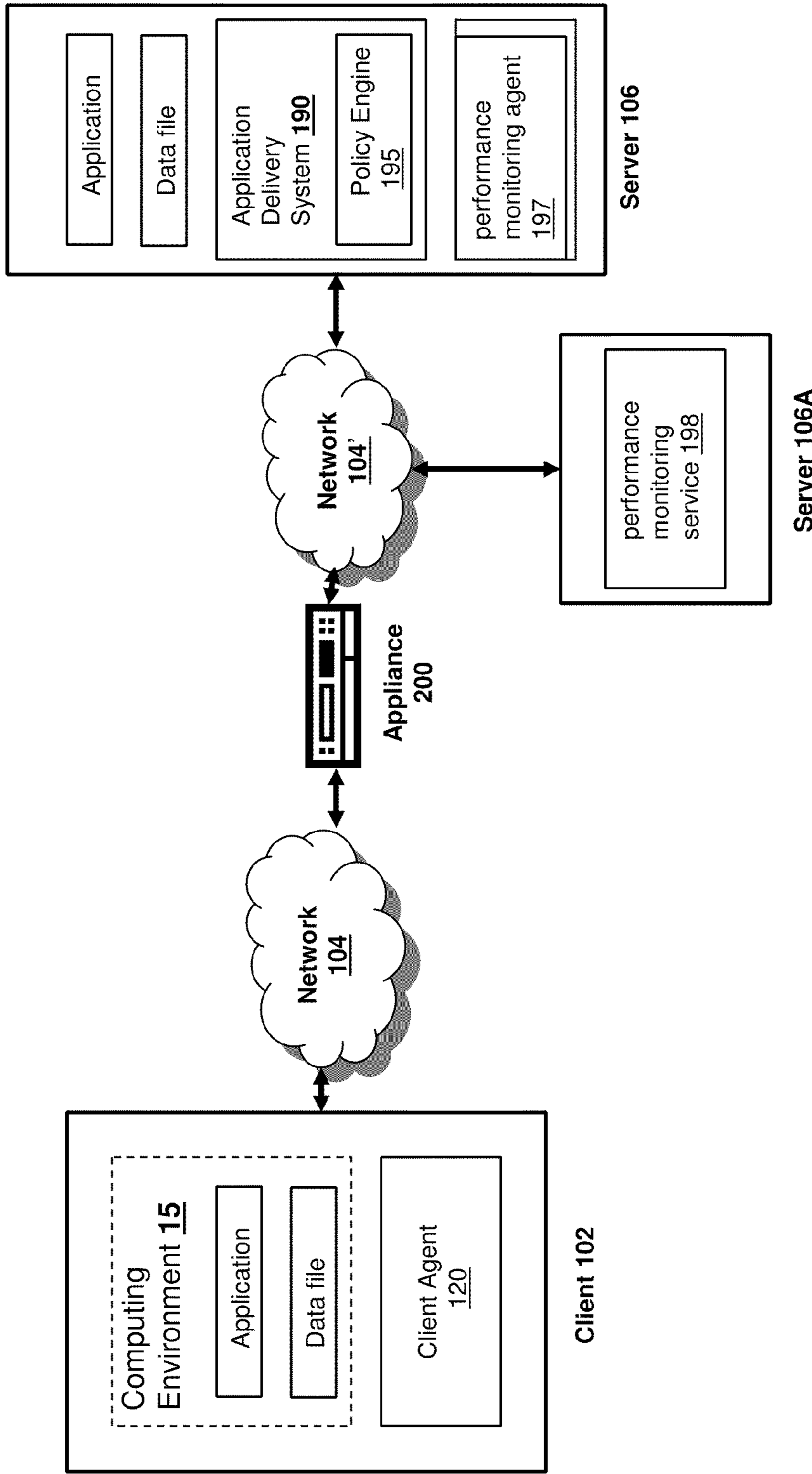

FIG. 1D

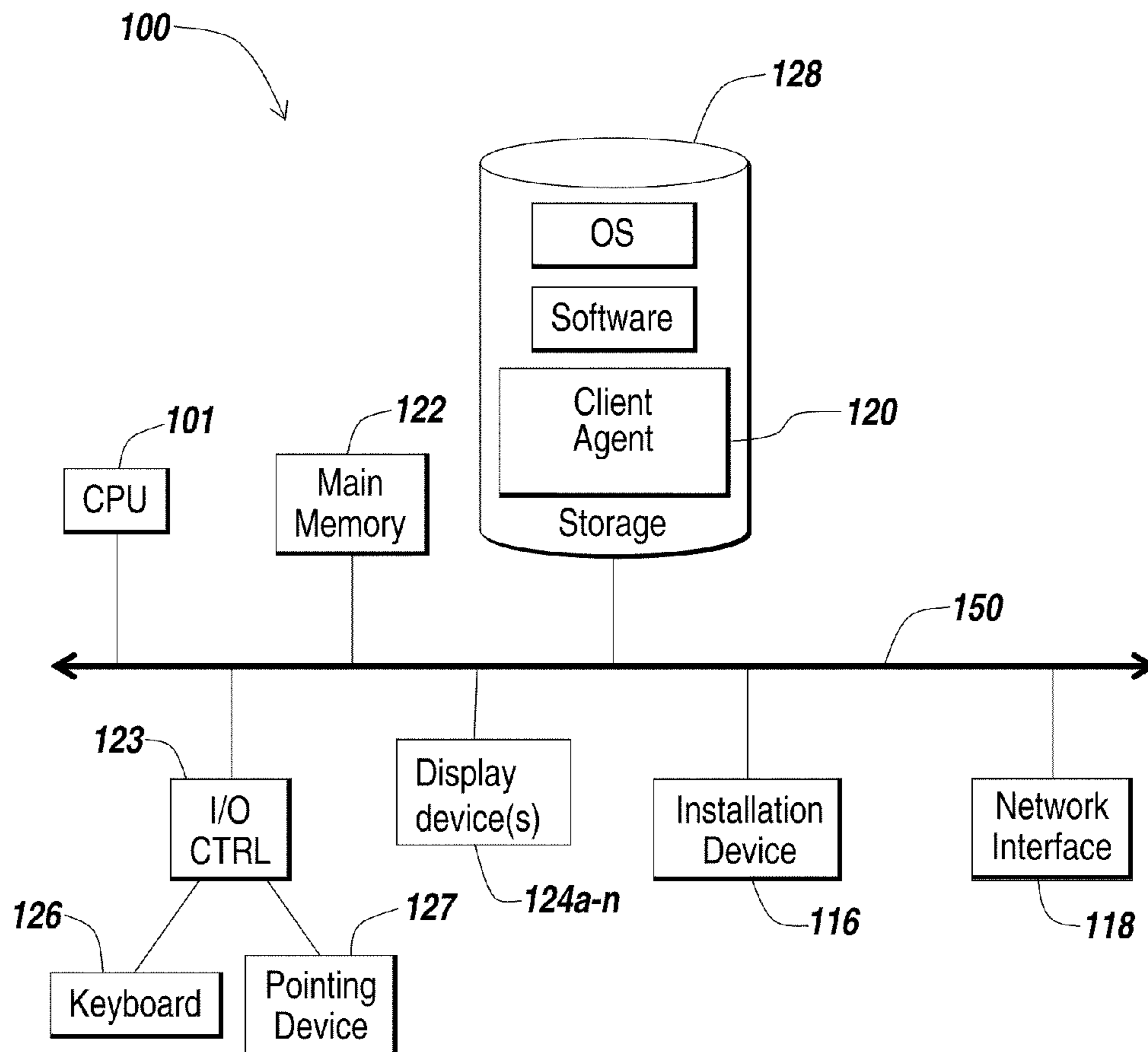

FIG. 1E

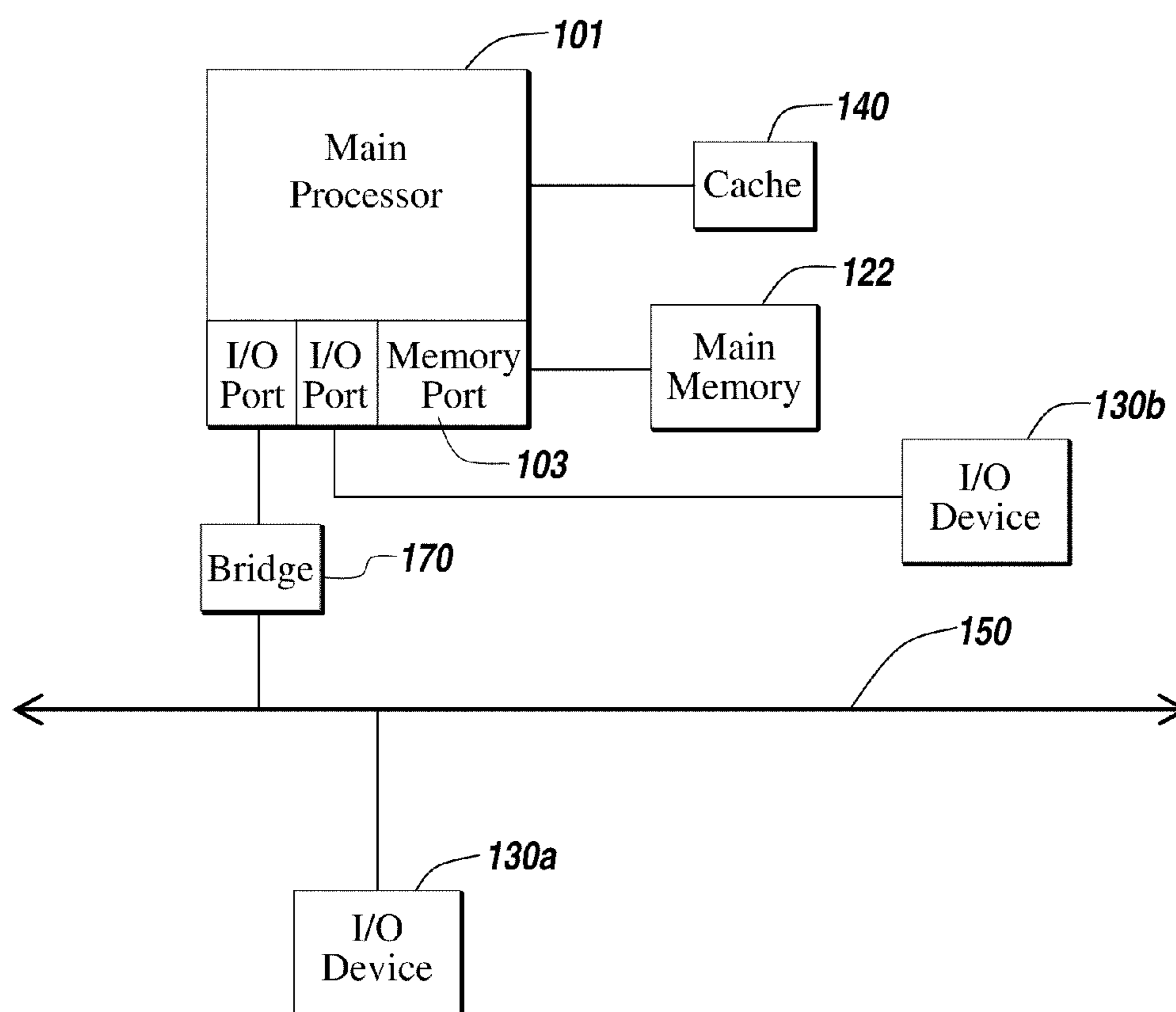

FIG. 1F

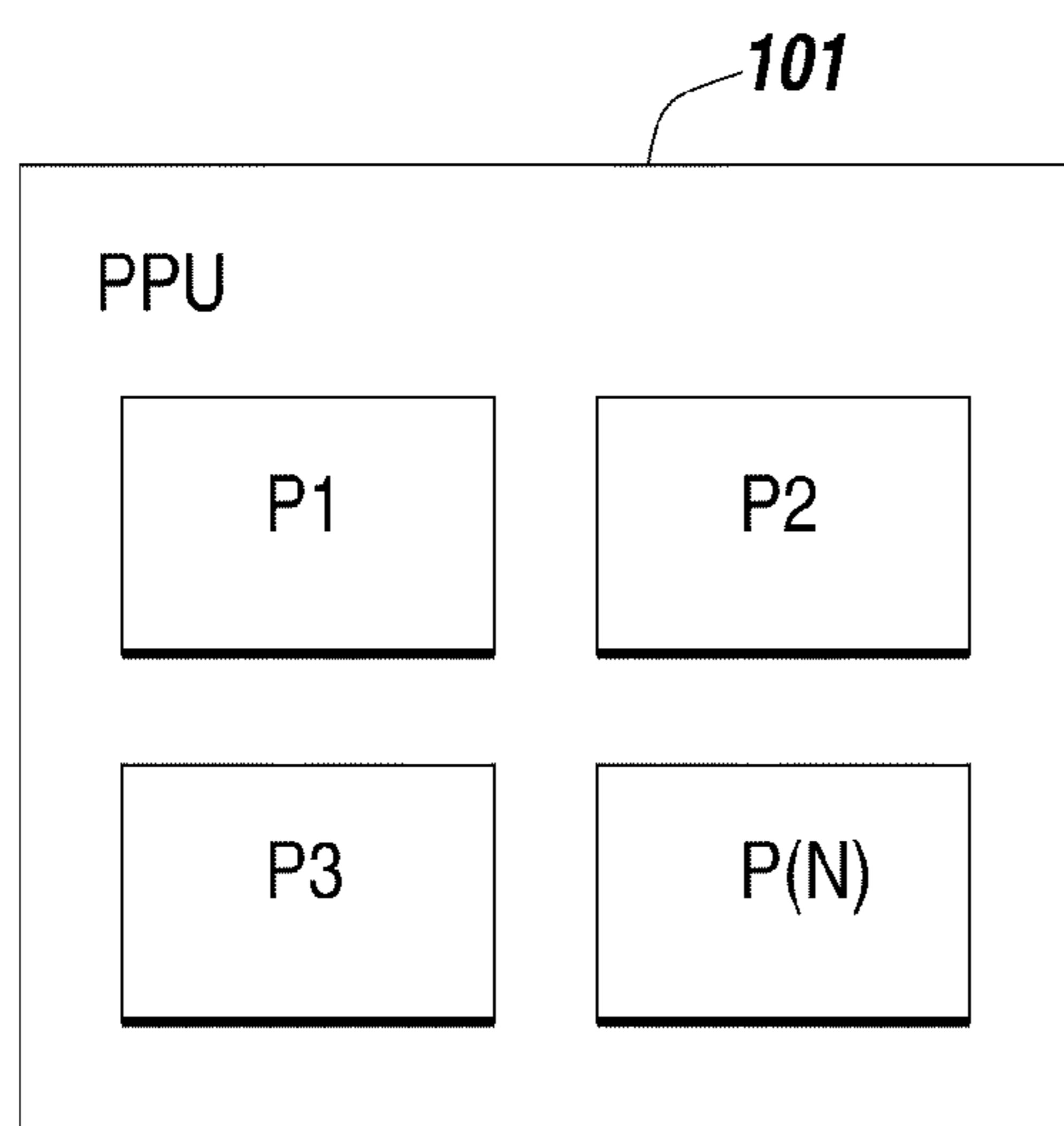

FIG. 1G

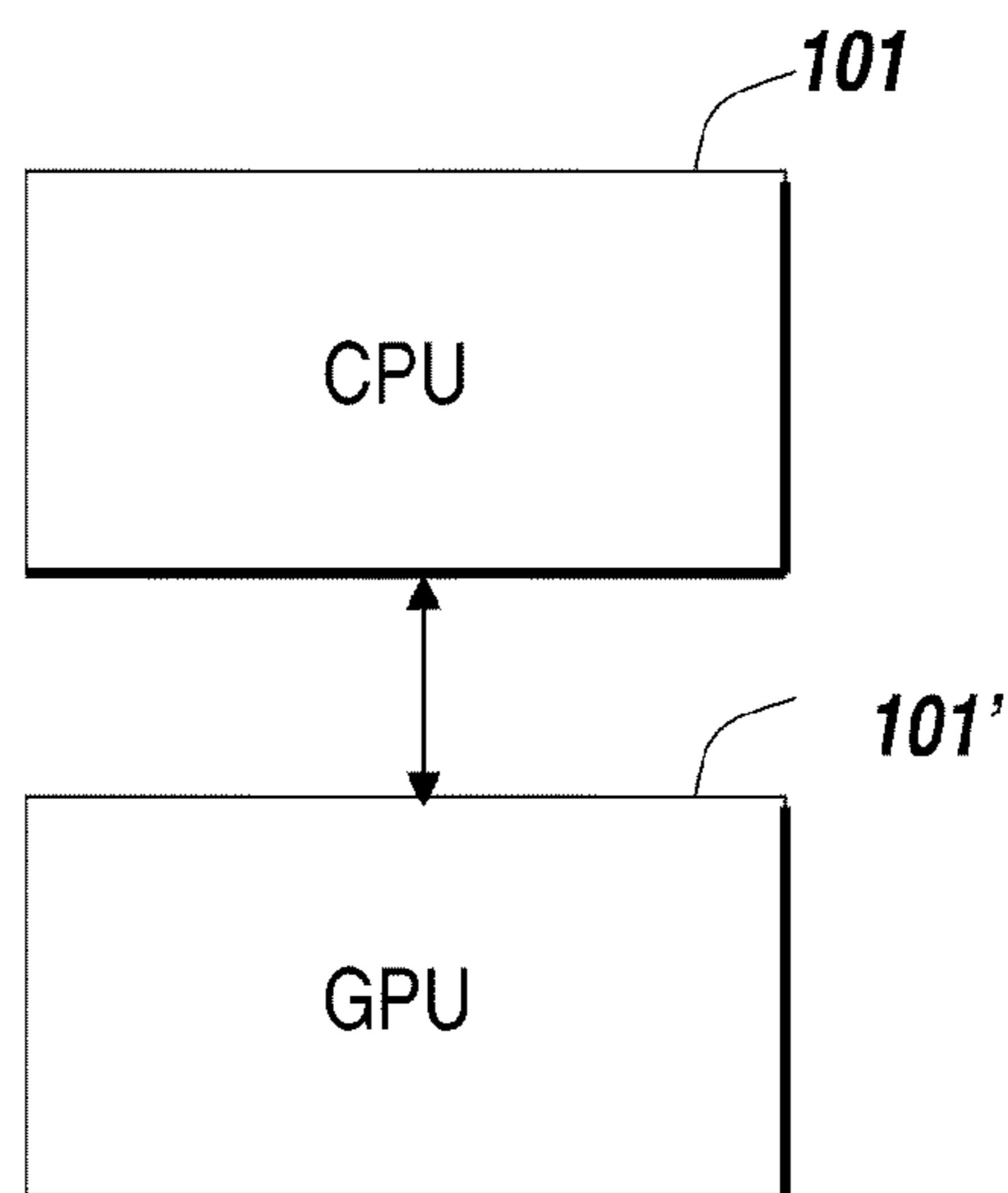

FIG. 1H

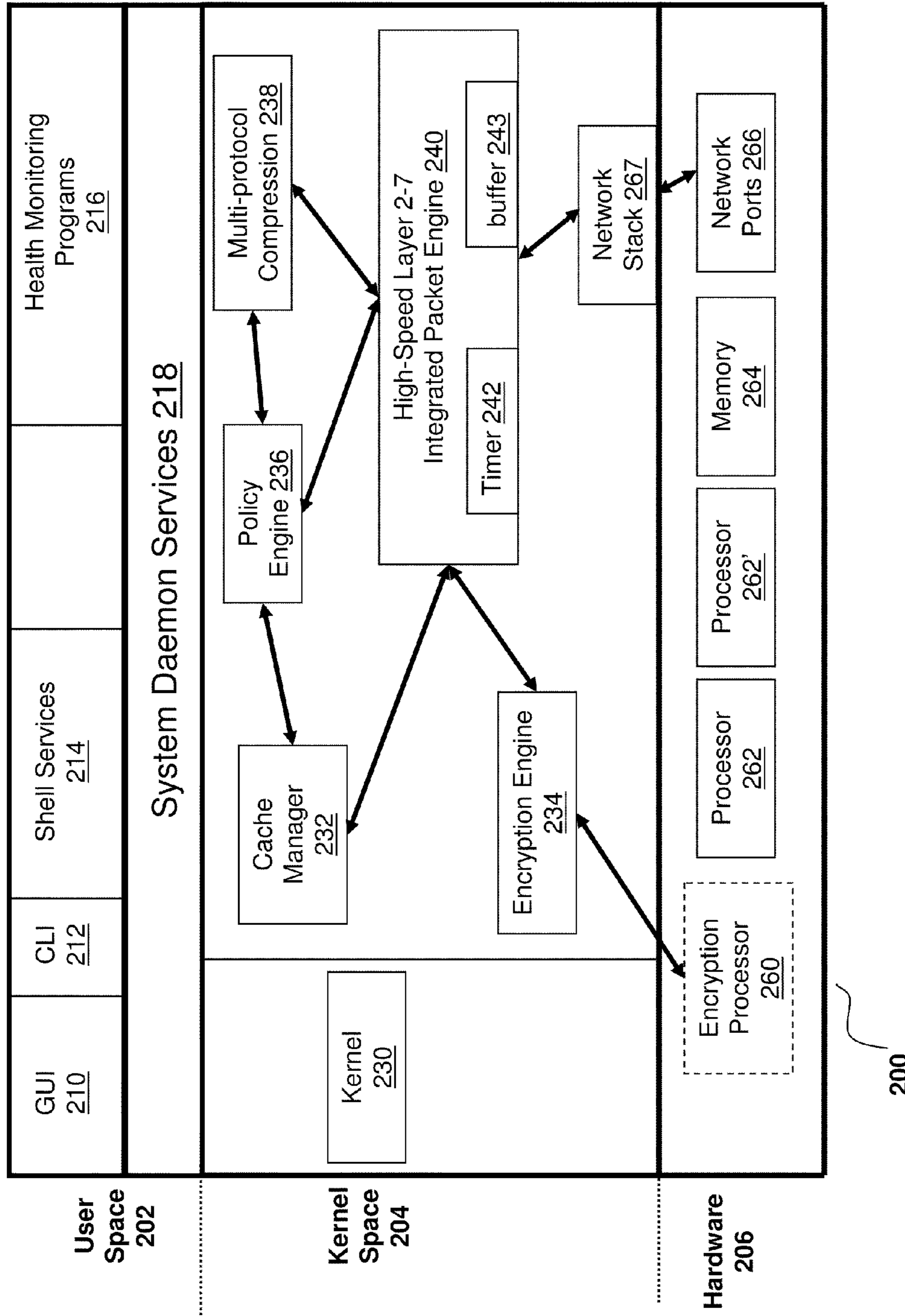

FIG. 2A

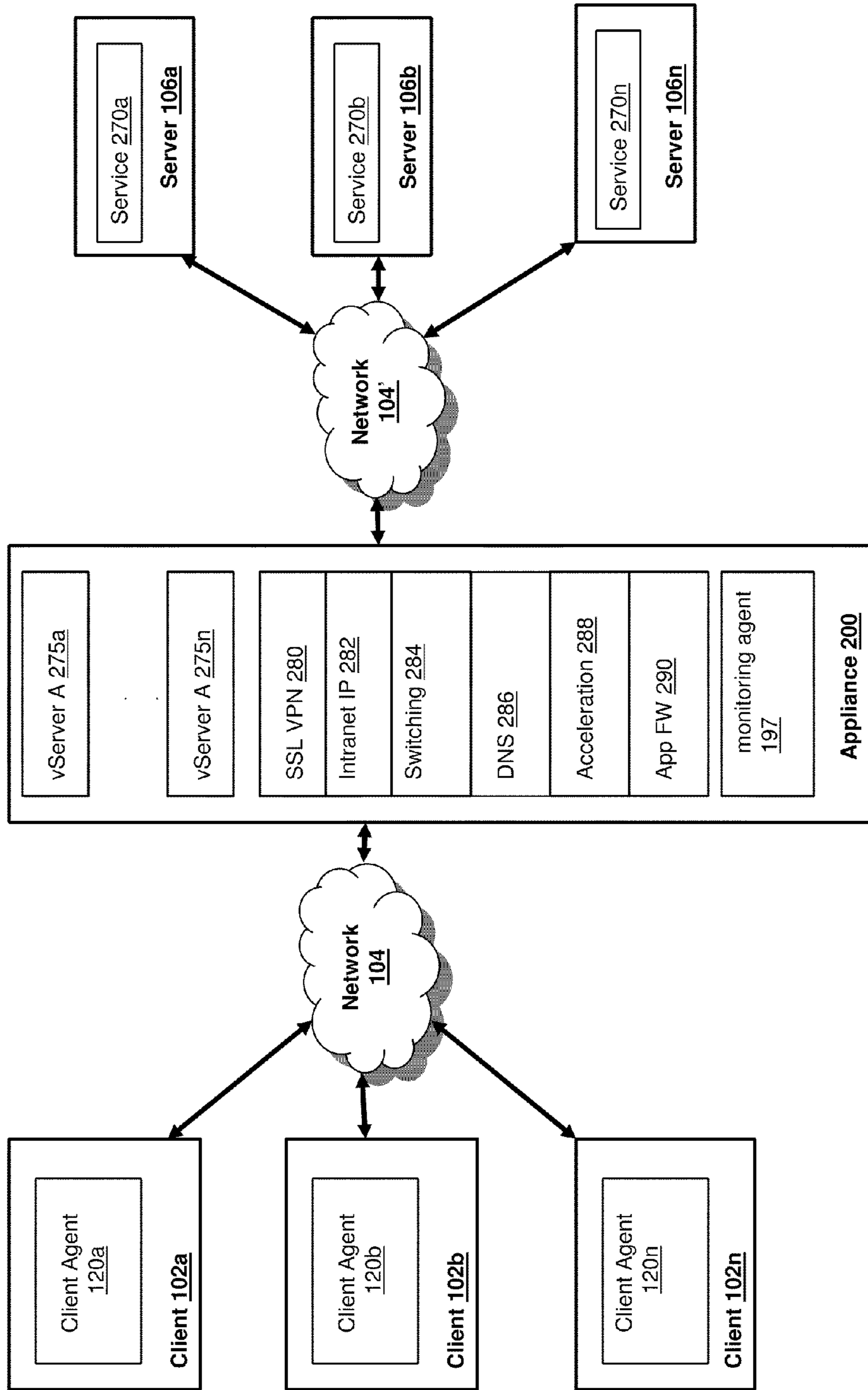
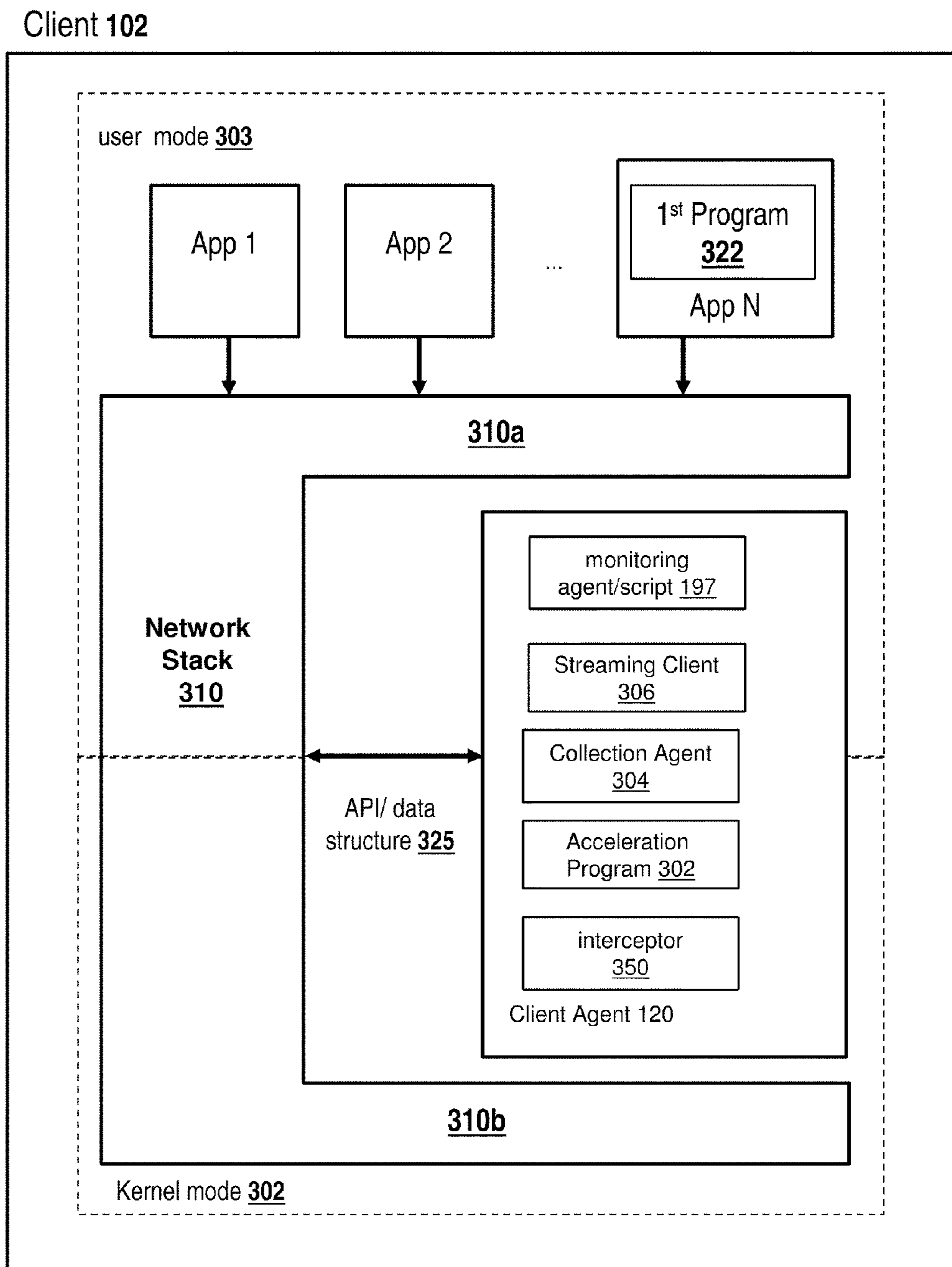

FIG. 2B



100

FIG. 3

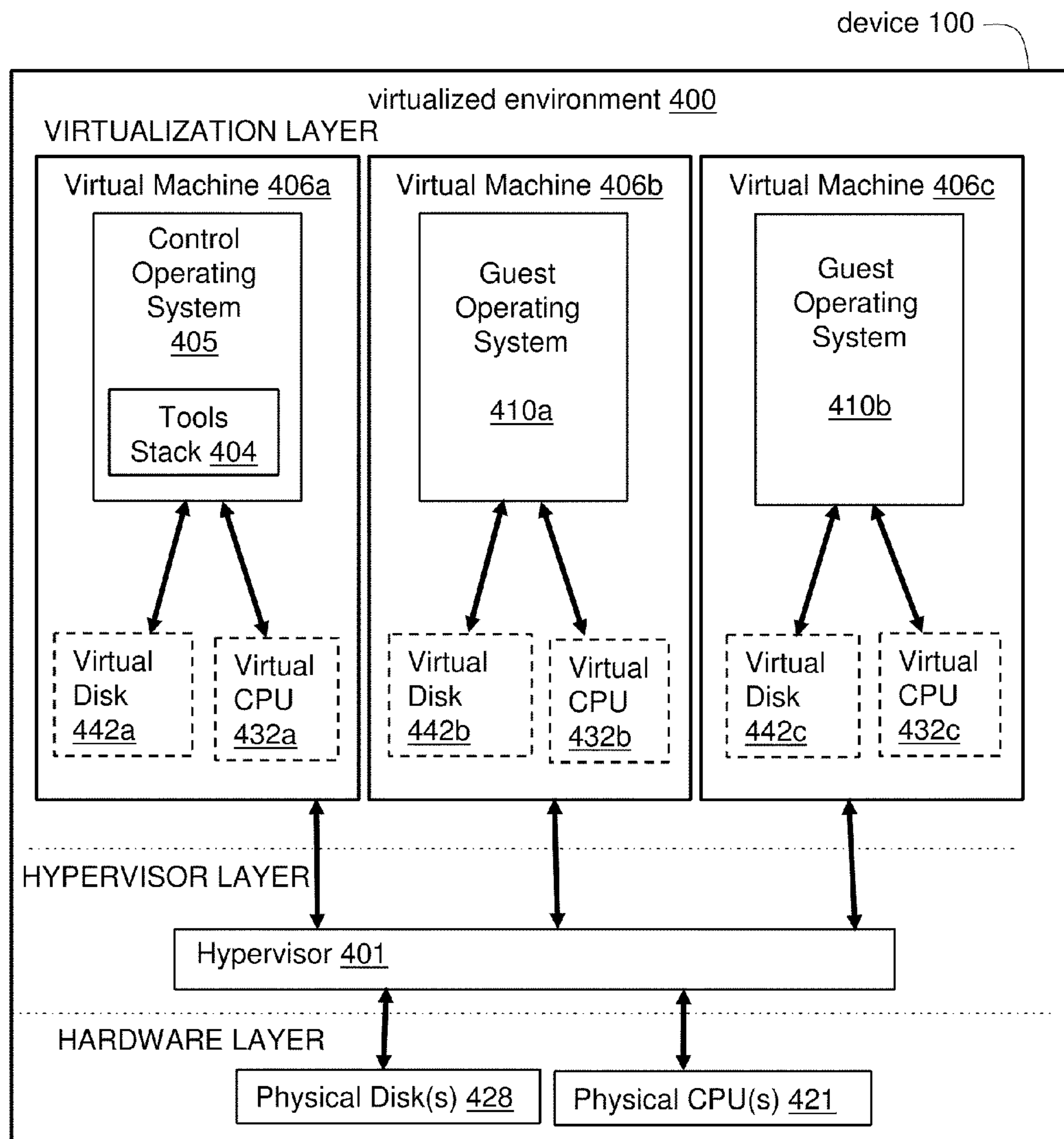

FIG. 4A

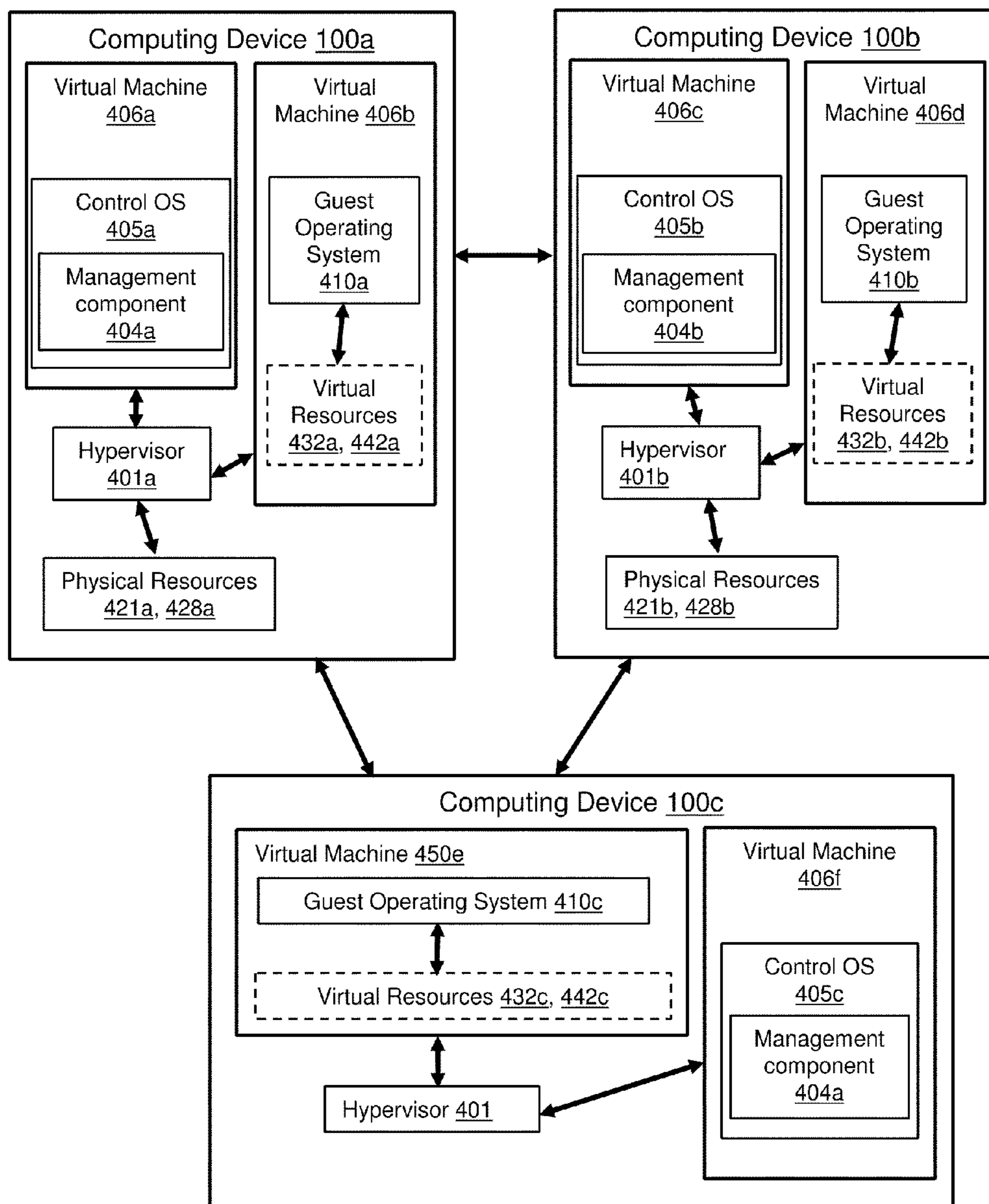

FIG. 4B

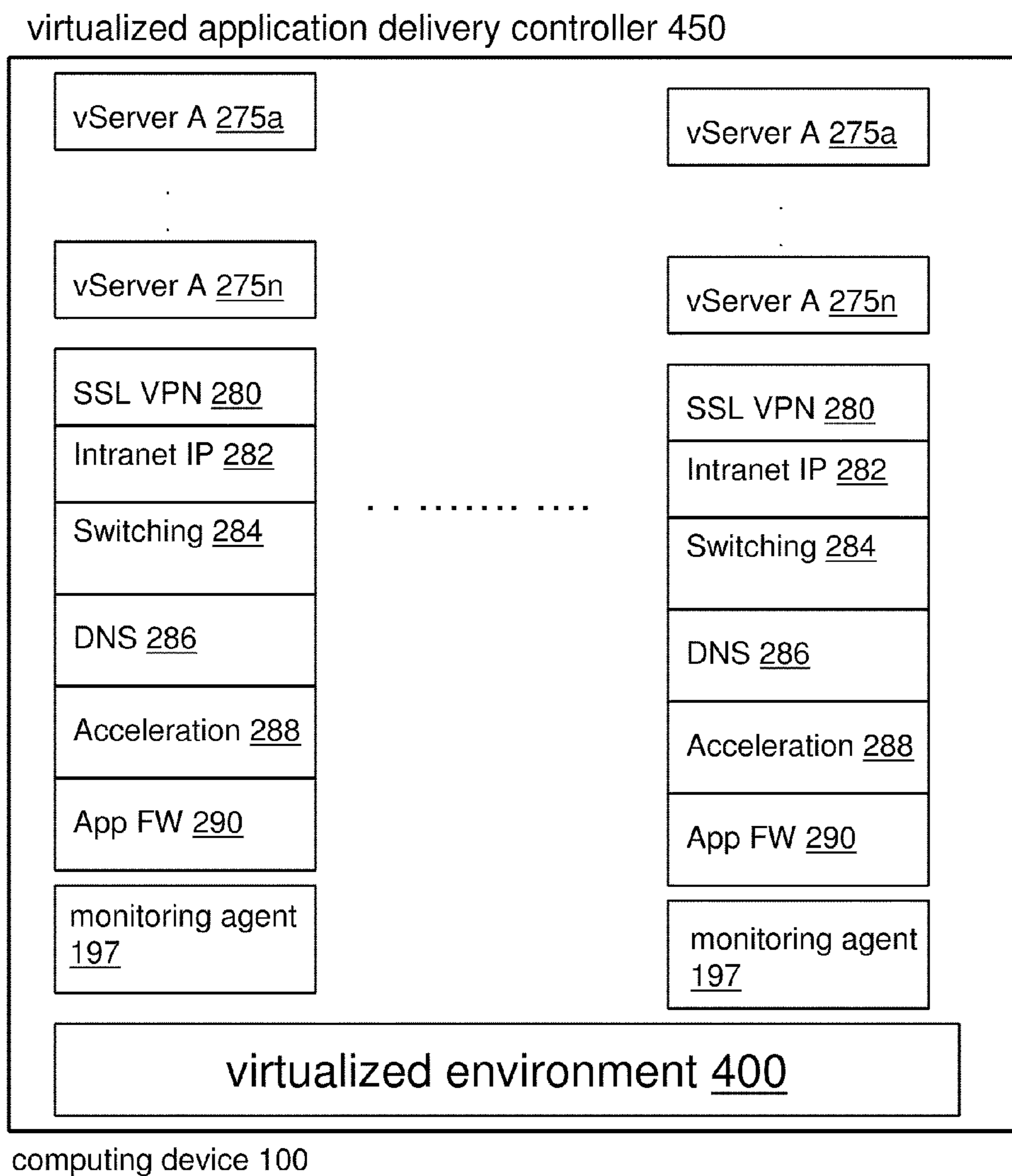

FIG. 4C

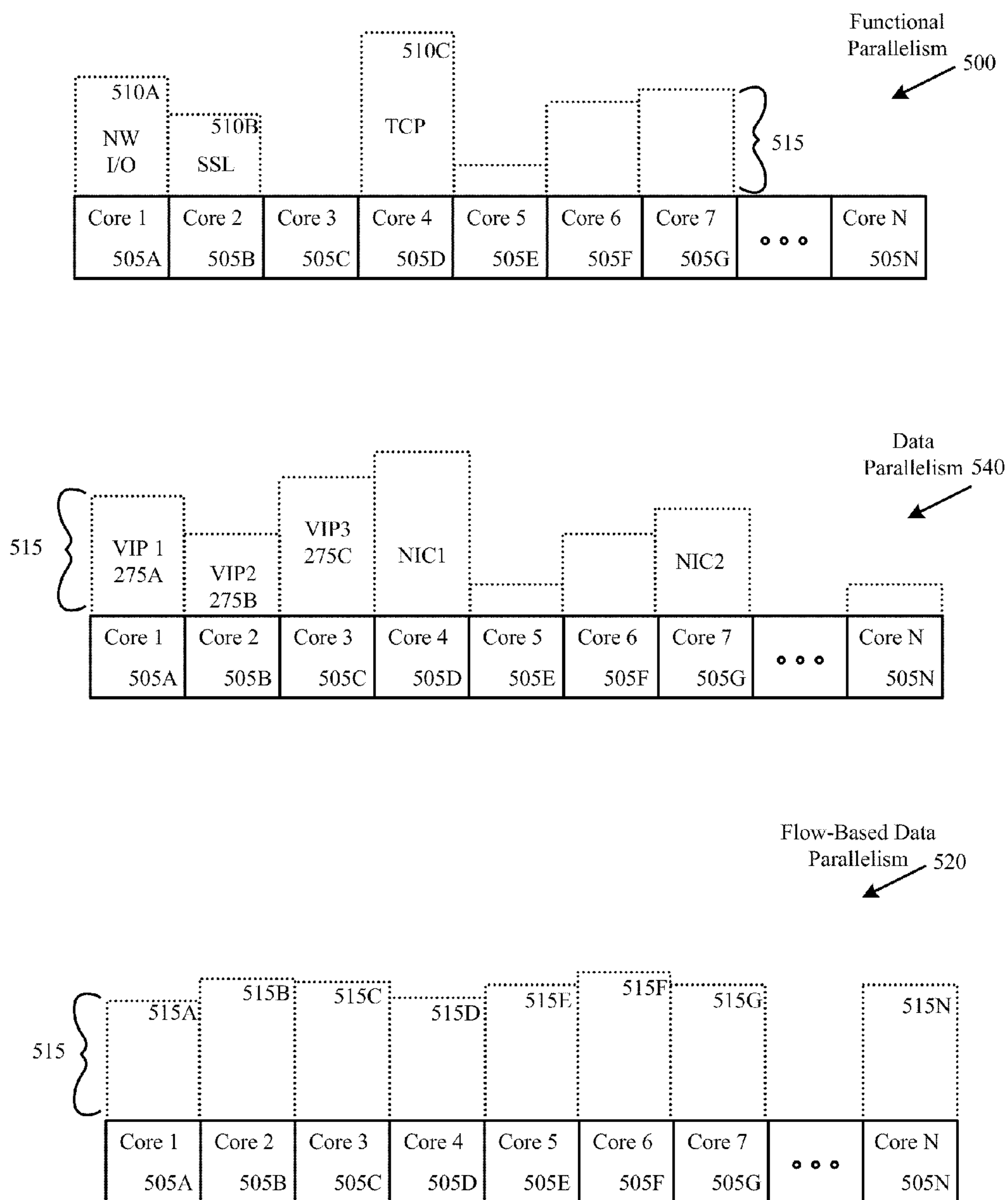

FIG. 5A

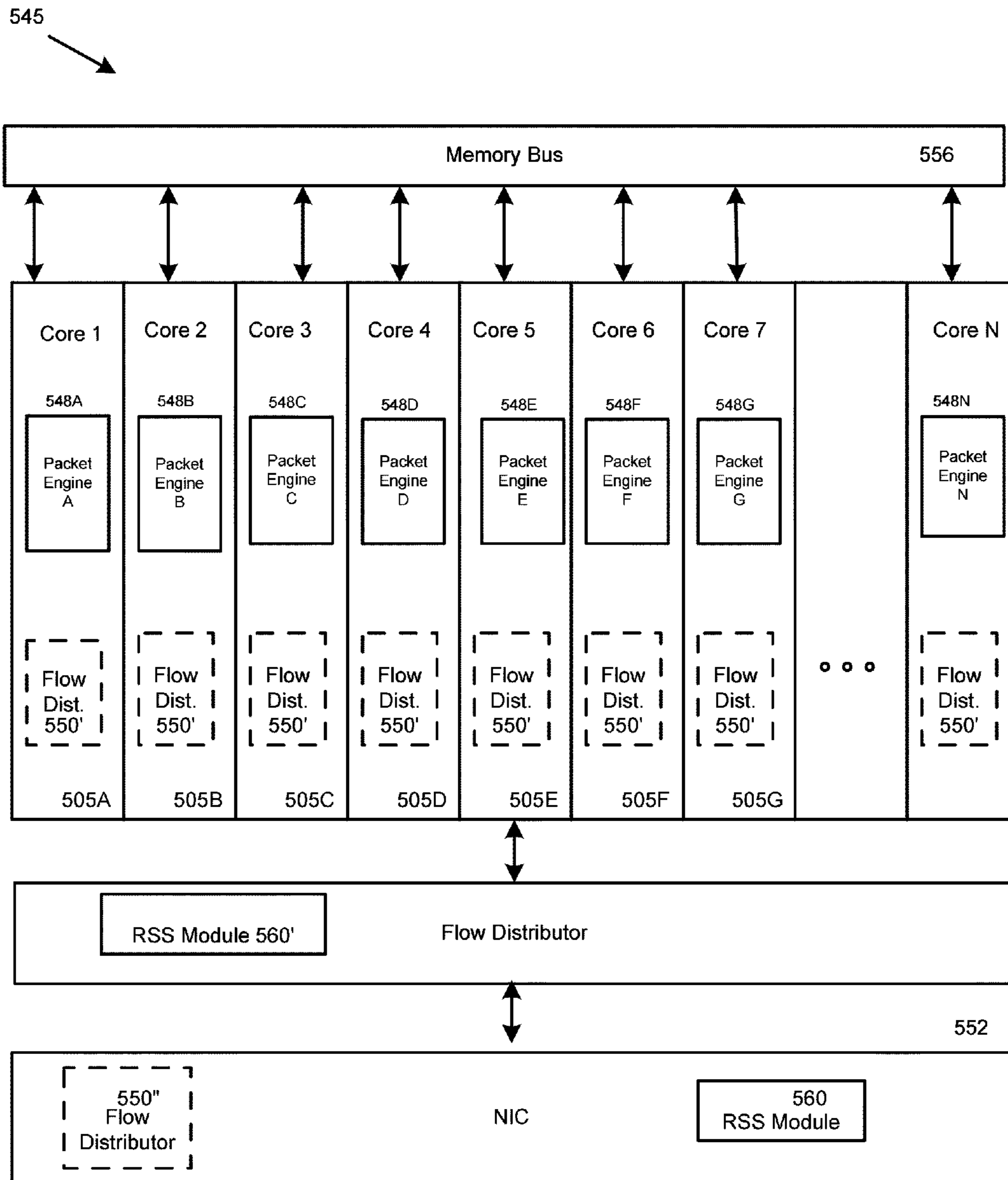

FIG. 5B

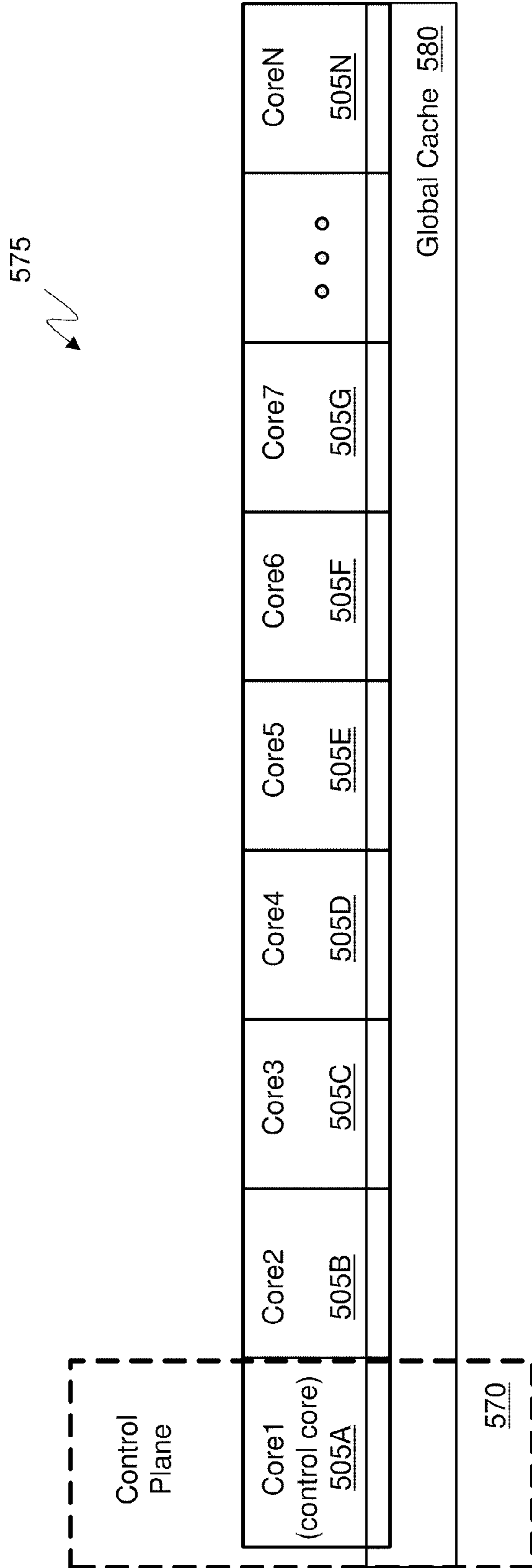

FIG. 5C

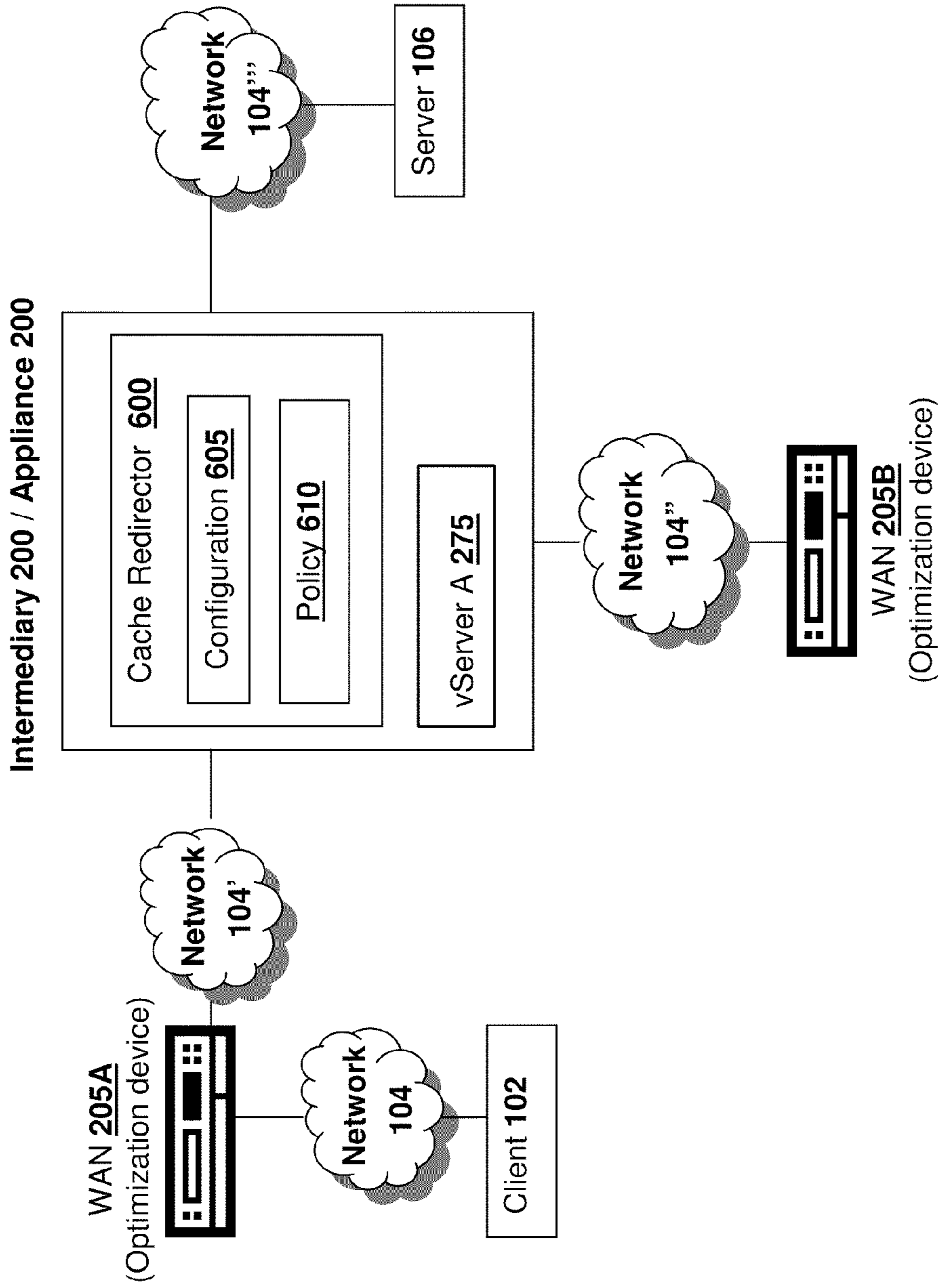

FIG. 6A

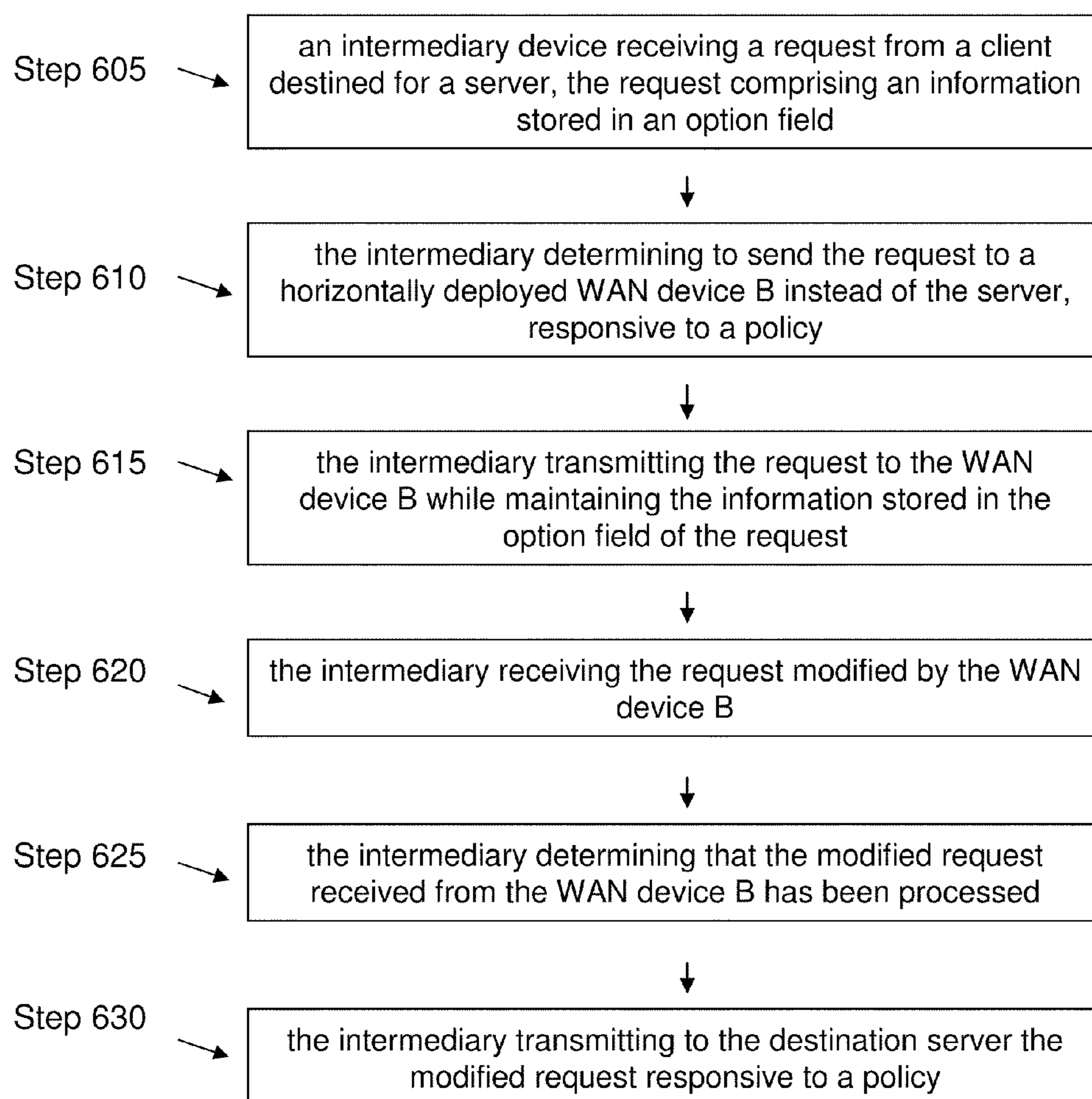

FIG. 6B

1

**SYSTEMS AND METHODS FOR POLICY
BASED INTEGRATION TO HORIZONTALLY
DEPLOYED WAN OPTIMIZATION
APPLIANCES**

FIELD OF THE INVENTION

The present application generally relates to data communication networks. In particular, the present application relates to systems and methods for redirection to wide area network optimization engines by an intermediary device.

BACKGROUND OF THE INVENTION

A corporate or enterprise may deploy a number of services across a network to enhance the quality of service provided by the enterprise to the clients accessing the services via servers of the enterprise. The servers of the enterprise may be optimized in a number of ways to meet the demand and load from the volume of clients' requests. In some configurations, the enterprise may further provide one or more intermediaries to manage the network traffic intercepted from the clients to the back end servers of the enterprise. In some instances, an intermediary of the enterprise may intercept from a client a client request destined for a back end server. The client request may have already been intercepted by another network device prior to being received by the intermediary of the enterprise. In order to satisfy the client's request the intermediary of the enterprise may need to ensure that the client request arrives to the appropriate back end server of the enterprise.

BRIEF SUMMARY OF THE INVENTION

The present disclosure relates to systems and methods for redirecting client requests, by an intermediary network device, to horizontally deployed Wide Area Network (WAN) optimization network devices providing service to the client request. The present disclosure may also relate to systems and methods for maintaining services provided to a client request by one or more WAN optimization devices on a network while servicing the network request by an intermediary network device. In some configurations, the present disclosure describes systems and methods for maintaining, by an intermediary device servicing a client request, protocol specific services, such as a transmission control protocol (TCP) services, provided by one or more WAN optimization devices to the client request by cache redirection of the client request. In some configurations, the present disclosure relates to a cache redirection mechanism of an intermediary device that may utilize a policy to identify if the client request has already been serviced by a WAN optimization device and if the client request needs to be serviced by another WAN optimization device again prior to forwarding the client request to the virtual server or the intended destination server.

In some instances, the present disclosure relates to systems and methods for redirecting requests by an intermediary to a horizontally deployed Wide Area Network optimization device. An intermediary device deployed between a plurality of clients and one or more servers may receive via a first transport layer connection, a first request from a client to access a server. The first request may be modified by a first Wide Area Network (WAN) optimization device deployed between the client and the intermediary device to include information in a first option field of a transport layer that may be processed, or that is processable, by a second WAN optimization device. The intermediary may determine, respon-

2

sive to a redirection policy, to send the first request to the second WAN optimization device instead of the server. The intermediary device may establish a second transport layer connection with the second WAN optimization device deployed horizontally to the intermediary device. The intermediary device may transmit the first request to the second WAN optimization device via the second transport layer connection. The intermediary device may maintain the information from the first option field of the first request in a second option field of a transport layer. The second option field may be of the first request. In some embodiments, the second option field is an option field of a second request. The intermediary device may receive the first request including the information in the first option field identifying the first WAN optimization device to the second WAN optimization device.

In some embodiments, the intermediary device receives the first request including the information in the first option field identifying to the second WAN optimization device instructions on processing a payload of the first request. In certain embodiments, the intermediary device determines to send the first request to the second WAN optimization device responsive to the redirection policy identifying a presence of the information in the first option field. In specific embodiments, the intermediary device determines to send the first request to the second WAN optimization device responsive to evaluating an expression of the redirection policy to the first option field. In some embodiments, the intermediary device establishes a second transport layer connection with the second WAN optimization device of a plurality of WAN optimization devices deployed horizontally to the intermediary device.

In some embodiments, the intermediary device receives the first request processed by the second WAN optimization device to uncompress a payload of the first request. In some embodiments, the intermediary device receives the first request processed by the second WAN optimization device to form a second request. In specific embodiments, the intermediary device determines that the second request is received after processing by the second WAN optimization device and transmits the second request to the server identified by the first request. In some embodiments, the intermediary device determines that the second request is received after processing by the second WAN optimization device and a cache redirection virtual server of the intermediary device transmits the second request to a virtual server of the intermediary device managing the server.

In some aspects, the present disclosure relates to a system of redirecting requests by an intermediary to a horizontally deployed Wide Area Network optimization device. A first Wide Area Network (WAN) optimization device deployed between a plurality of clients and a server may receive a first request from a client to access a server and modify the first request to include information in a first option field of a transport layer processable by a second WAN optimization device. An intermediary device deployed between a plurality of clients and one or more servers may receive, via a first transport layer connection, the first request from the first WAN optimization device. A cache redirection virtual server of the intermediary device may determine, responsive to a redirection policy, to send the first request to the second WAN optimization device instead of the server. The intermediary device may establish a second transport layer connection with the second WAN optimization device deployed horizontally to the intermediary device. The intermediary may transmit the first request to the second WAN optimization device via the second transport layer connection, the intermediary

3

device maintaining the information from the first option field of the first request in a second option field of a transport layer of the first request.

In some embodiments, the intermediary device receives the first request including the information in the first option field identifying the first WAN optimization device to the second WAN optimization device. In certain embodiments, the intermediary device receives the first request including the information in the first option field identifying to the second WAN optimization device instructions on processing a payload of the first request. In some embodiments, the cache redirection virtual server determines to send the first request to the second WAN optimization device responsive to the redirection policy identifying a presence of the information in the first option field. In further embodiments, the cache redirection virtual server determines to send the first request to the second WAN optimization device responsive to evaluating an expression of the redirection policy to the first option field. In certain embodiments, the intermediary device establishes the second transport layer connection with the second WAN optimization device of a plurality of WAN optimization devices deployed horizontally to the intermediary device. In some embodiments, the intermediary device receives the first request processed by the second WAN optimization device to decompress a payload of the first request. In some embodiments, the intermediary device receives the first request processed by the second WAN optimization device to form a second request. In certain embodiments, the intermediary device determines that the second request is received after processing by the second WAN optimization device and transmits the second request to the server identified by the first request. In specific embodiments, the intermediary device determines that the second request is received after processing by the second WAN optimization device and the cache redirection virtual server of the intermediary device communicates the second request to a second virtual server of the intermediary device managing the server.

BRIEF DESCRIPTION OF THE FIGURES

The foregoing and other objects, aspects, features, and advantages of the invention will become more apparent and better understood by referring to the following description taken in conjunction with the accompanying drawings, in which:

FIG. 1A is a block diagram of an embodiment of a network environment for a client to access a server via an appliance;

FIG. 1B is a block diagram of an embodiment of an environment for delivering a computing environment from a server to a client via an appliance;

FIG. 1C is a block diagram of another embodiment of an environment for delivering a computing environment from a server to a client via an appliance;

FIG. 1D is a block diagram of another embodiment of an environment for delivering a computing environment from a server to a client via an appliance;

FIGS. 1E-1H are block diagrams of embodiments of a computing device;

FIG. 2A is a block diagram of an embodiment of an appliance for processing communications between a client and a server;

FIG. 2B is a block diagram of another embodiment of an appliance for optimizing, accelerating, load-balancing and routing communications between a client and a server;

FIG. 3 is a block diagram of an embodiment of a client for communicating with a server via the appliance;

4

FIG. 4A is a block diagram of an embodiment of a virtualization environment;

FIG. 4B is a block diagram of another embodiment of a virtualization environment;

FIG. 4C is a block diagram of an embodiment of a virtualized appliance;

FIG. 5A are block diagrams of embodiments of approaches to implementing parallelism in a multi-core system;

FIG. 5B is a block diagram of an embodiment of a system utilizing a multi-core system;

FIG. 5C is a block diagram of another embodiment of an aspect of a multi-core system;

FIG. 6A is a block diagram of an embodiment of a system for performing redirection of network packets by an intermediary device to a horizontally deployed WAN optimization device; and

FIG. 6B is a flow diagram of an embodiment of steps of a method for performing redirection of network packets by an intermediary device to a horizontally deployed WAN optimization device;

In the drawings, like reference numbers generally indicate identical, functionally similar, and/or structurally similar elements.

DETAILED DESCRIPTION OF THE INVENTION

For purposes of reading the description of the various embodiments below, the following descriptions of the sections of the specification and their respective contents may be helpful:

Section A describes a network environment and computing environment which may be useful for practicing embodiments described herein;

Section B describes embodiments of systems and methods for delivering a computing environment to a remote user;

Section C describes embodiments of systems and methods for accelerating communications between a client and a server;

Section D describes embodiments of systems and methods for virtualizing an application delivery controller;

Section E describes embodiments of systems and methods for providing a multi-core architecture and environment; and

Section F describes embodiments of systems and methods for policy based cache redirection to WAN Optimization Devices.

A. Network and Computing Environment

Prior to discussing the specifics of embodiments of the systems and methods of an appliance and/or client, it may be helpful to discuss the network and computing environments in which such embodiments may be deployed. Referring now to FIG. 1A, an embodiment of a network environment is depicted. In brief overview, the network environment comprises one or more clients **102a-102n** (also generally referred to as local machine(s) **102**, or client(s) **102**) in communication with one or more servers **106a-106n** (also generally referred to as server(s) **106**, or remote machine(s) **106**) via one or more networks **104, 104'** (generally referred to as network **104**). In some embodiments, a client **102** communicates with a server **106** via an appliance **200**.

Although FIG. 1A shows a network **104** and a network **104'** between the clients **102** and the servers **106**, the clients **102** and the servers **106** may be on the same network **104**. The networks **104** and **104'** can be the same type of network or different types of networks. The network **104** and/or the network **104'** can be a local-area network (LAN), such as a

company Intranet, a metropolitan area network (MAN), or a wide area network (WAN), such as the Internet or the World Wide Web. In one embodiment, network **104'** may be a private network and network **104** may be a public network. In some embodiments, network **104** may be a private network and network **104'** a public network. In another embodiment, networks **104** and **104'** may both be private networks. In some embodiments, clients **102** may be located at a branch office of a corporate enterprise communicating via a WAN connection over the network **104** to the servers **106** located at a corporate data center.

The network **104** and/or **104'** be any type and/or form of network and may include any of the following: a point to point network, a broadcast network, a wide area network, a local area network, a telecommunications network, a data communication network, a computer network, an ATM (Asynchronous Transfer Mode) network, a SONET (Synchronous Optical Network) network, a SDH (Synchronous Digital Hierarchy) network, a wireless network and a wireline network. In some embodiments, the network **104** may comprise a wireless link, such as an infrared channel or satellite band. The topology of the network **104** and/or **104'** may be a bus, star, or ring network topology. The network **104** and/or **104'** and network topology may be of any such network or network topology as known to those ordinarily skilled in the art capable of supporting the operations described herein.

As shown in FIG. 1A, the appliance **200**, which also may be referred to as an interface unit **200** or gateway **200**, is shown between the networks **104** and **104'**. In some embodiments, the appliance **200** may be located on network **104**. For example, a branch office of a corporate enterprise may deploy an appliance **200** at the branch office. In other embodiments, the appliance **200** may be located on network **104'**. For example, an appliance **200** may be located at a corporate data center. In yet another embodiment, a plurality of appliances **200** may be deployed on network **104**. In some embodiments, a plurality of appliances **200** may be deployed on network **104'**. In one embodiment, a first appliance **200** communicates with a second appliance **200'**. In other embodiments, the appliance **200** could be a part of any client **102** or server **106** on the same or different network **104,104'** as the client **102**. One or more appliances **200** may be located at any point in the network or network communications path between a client **102** and a server **106**.

In some embodiments, the appliance **200** comprises any of the network devices manufactured by Citrix Systems, Inc. of Ft. Lauderdale Fla., referred to as Citrix NetScaler devices. In other embodiments, the appliance **200** includes any of the product embodiments referred to as WebAccelerator and BigIP manufactured by F5 Networks, Inc. of Seattle, Wash. In another embodiment, the appliance **205** includes any of the DX acceleration device platforms and/or the SSL VPN series of devices, such as SA 700, SA 2000, SA 4000, and SA 6000 devices manufactured by Juniper Networks, Inc. of Sunnyvale, Calif. In yet another embodiment, the appliance **200** includes any application acceleration and/or security related appliances and/or software manufactured by Cisco Systems, Inc. of San Jose, Calif., such as the Cisco ACE Application Control Engine Module service software and network modules, and Cisco AVS Series Application Velocity System.

In one embodiment, the system may include multiple, logically-grouped servers **106**. In these embodiments, the logical group of servers may be referred to as a server farm **38**. In some of these embodiments, the serves **106** may be geographically dispersed. In some cases, a farm **38** may be administered as a single entity. In other embodiments, the server farm **38** comprises a plurality of server farms **38**. In one

embodiment, the server farm executes one or more applications on behalf of one or more clients **102**.

The servers **106** within each farm **38** can be heterogeneous. One or more of the servers **106** can operate according to one type of operating system platform (e.g., WINDOWS NT, manufactured by Microsoft Corp. of Redmond, Wash.), while one or more of the other servers **106** can operate on according to another type of operating system platform (e.g., Unix or Linux). The servers **106** of each farm **38** do not need to be physically proximate to another server **106** in the same farm **38**. Thus, the group of servers **106** logically grouped as a farm **38** may be interconnected using a wide-area network (WAN) connection or medium-area network (MAN) connection. For example, a farm **38** may include servers **106** physically located in different continents or different regions of a continent, country, state, city, campus, or room. Data transmission speeds between servers **106** in the farm **38** can be increased if the servers **106** are connected using a local-area network (LAN) connection or some form of direct connection.

Servers **106** may be referred to as a file server, application server, web server, proxy server, or gateway server. In some embodiments, a server **106** may have the capacity to function as either an application server or as a master application server. In one embodiment, a server **106** may include an Active Directory. The clients **102** may also be referred to as client nodes or endpoints. In some embodiments, a client **102** has the capacity to function as both a client node seeking access to applications on a server and as an application server providing access to hosted applications for other clients **102a-102n**.

In some embodiments, a client **102** communicates with a server **106**. In one embodiment, the client **102** communicates directly with one of the servers **106** in a farm **38**. In another embodiment, the client **102** executes a program neighborhood application to communicate with a server **106** in a farm **38**. In still another embodiment, the server **106** provides the functionality of a master node. In some embodiments, the client **102** communicates with the server **106** in the farm **38** through a network **104**. Over the network **104**, the client **102** can, for example, request execution of various applications hosted by the servers **106a-106n** in the farm **38** and receive output of the results of the application execution for display. In some embodiments, only the master node provides the functionality required to identify and provide address information associated with a server **106'** hosting a requested application.

In one embodiment, the server **106** provides functionality of a web server. In another embodiment, the server **106a** receives requests from the client **102**, forwards the requests to a second server **106b** and responds to the request by the client **102** with a response to the request from the server **106b**. In still another embodiment, the server **106** acquires an enumeration of applications available to the client **102** and address information associated with a server **106** hosting an application identified by the enumeration of applications. In yet another embodiment, the server **106** presents the response to the request to the client **102** using a web interface. In one embodiment, the client **102** communicates directly with the server **106** to access the identified application. In another embodiment, the client **102** receives application output data, such as display data, generated by an execution of the identified application on the server **106**.

Referring now to FIG. 1B, an embodiment of a network environment deploying multiple appliances **200** is depicted. A first appliance **200** may be deployed on a first network **104** and a second appliance **200'** on a second network **104'**. For example a corporate enterprise may deploy a first appliance

200 at a branch office and a second appliance **200'** at a data center. In another embodiment, the first appliance **200** and second appliance **200'** are deployed on the same network **104** or network **104'**. For example, a first appliance **200** may be deployed for a first server farm **38**, and a second appliance **200** may be deployed for a second server farm **38'**. In another example, a first appliance **200** may be deployed at a first branch office while the second appliance **200'** is deployed at a second branch office'. In some embodiments, the first appliance **200** and second appliance **200'** work in cooperation or in conjunction with each other to accelerate network traffic or the delivery of application and data between a client and a server

Referring now to FIG. 1C, another embodiment of a network environment deploying the appliance **200** with one or more other types of appliances, such as between one or more WAN optimization appliance **205**, **205'** is depicted. For example a first WAN optimization appliance **205** is shown between networks **104** and **104'** and a second WAN optimization appliance **205'** may be deployed between the appliance **200** and one or more servers **106**. By way of example, a corporate enterprise may deploy a first WAN optimization appliance **205** at a branch office and a second WAN optimization appliance **205'** at a data center. In some embodiments, the appliance **205** may be located on network **104'**. In other embodiments, the appliance **205'** may be located on network **104**. In some embodiments, the appliance **205'** may be located on network **104'** or network **104''**. In one embodiment, the appliance **205** and **205'** are on the same network. In another embodiment, the appliance **205** and **205'** are on different networks. In another example, a first WAN optimization appliance **205** may be deployed for a first server farm **38** and a second WAN optimization appliance **205'** for a second server farm **38'**

In one embodiment, the appliance **205** is a device for accelerating, optimizing or otherwise improving the performance, operation, or quality of service of any type and form of network traffic, such as traffic to and/or from a WAN connection. In some embodiments, the appliance **205** is a performance enhancing proxy. In other embodiments, the appliance **205** is any type and form of WAN optimization or acceleration device, sometimes also referred to as a WAN optimization controller. In one embodiment, the appliance **205** is any of the product embodiments referred to as WANScaler manufactured by Citrix Systems, Inc. of Ft. Lauderdale, Fla. In other embodiments, the appliance **205** includes any of the product embodiments referred to as BIG-IP link controller and WAN-jet manufactured by F5 Networks, Inc. of Seattle, Wash. In another embodiment, the appliance **205** includes any of the WX and WXC WAN acceleration device platforms manufactured by Juniper Networks, Inc. of Sunnyvale, Calif. In some embodiments, the appliance **205** includes any of the steelhead line of WAN optimization appliances manufactured by Riverbed Technology of San Francisco, Calif. In other embodiments, the appliance **205** includes any of the WAN related devices manufactured by Expand Networks Inc. of Roseland, N.J. In one embodiment, the appliance **205** includes any of the WAN related appliances manufactured by Packeteer Inc. of Cupertino, Calif., such as the PacketShaper, iShared, and SkyX product embodiments provided by Packeteer. In yet another embodiment, the appliance **205** includes any WAN related appliances and/or software manufactured by Cisco Systems, Inc. of San Jose, Calif., such as the Cisco Wide Area Network Application Services software and network modules, and Wide Area Network engine appliances.

In one embodiment, the appliance **205** provides application and data acceleration services for branch-office or remote

offices. In one embodiment, the appliance **205** includes optimization of Wide Area File Services (WAFS). In another embodiment, the appliance **205** accelerates the delivery of files, such as via the Common Internet File System (CIFS) protocol. In other embodiments, the appliance **205** provides caching in memory and/or storage to accelerate delivery of applications and data. In one embodiment, the appliance **205** provides compression of network traffic at any level of the network stack or at any protocol or network layer. In another embodiment, the appliance **205** provides transport layer protocol optimizations, flow control, performance enhancements or modifications and/or management to accelerate delivery of applications and data over a WAN connection. For example, in one embodiment, the appliance **205** provides Transport Control Protocol (TCP) optimizations. In other embodiments, the appliance **205** provides optimizations, flow control, performance enhancements or modifications and/or management for any session or application layer protocol.

In another embodiment, the appliance **205** encoded any type and form of data or information into custom or standard TCP and/or IP header fields or option fields of network packet to announce presence, functionality or capability to another appliance **205'**. In another embodiment, an appliance **205'** may communicate with another appliance **205'** using data encoded in both TCP and/or IP header fields or options. For example, the appliance may use TCP option(s) or IP header fields or options to communicate one or more parameters to be used by the appliances **205**, **205'** in performing functionality, such as WAN acceleration, or for working in conjunction with each other.

In some embodiments, the appliance **200** preserves any of the information encoded in TCP and/or IP header and/or option fields communicated between appliances **205** and **205'**. For example, the appliance **200** may terminate a transport layer connection traversing the appliance **200**, such as a transport layer connection from between a client and a server traversing appliances **205** and **205'**. In one embodiment, the appliance **200** identifies and preserves any encoded information in a transport layer packet transmitted by a first appliance **205** via a first transport layer connection and communicates a transport layer packet with the encoded information to a second appliance **205'** via a second transport layer connection.

Referring now to FIG. 1D, a network environment for delivering and/or operating a computing environment on a client **102** is depicted. In some embodiments, a server **106** includes an application delivery system **190** for delivering a computing environment or an application and/or data file to one or more clients **102**. In brief overview, a client **10** is in communication with a server **106** via network **104**, **104'** and appliance **200**. For example, the client **102** may reside in a remote office of a company, e.g., a branch office, and the server **106** may reside at a corporate data center. The client **102** comprises a client agent **120**, and a computing environment **15**. The computing environment **15** may execute or operate an application that accesses, processes or uses a data file. The computing environment **15**, application and/or data file may be delivered via the appliance **200** and/or the server **106**.

In some embodiments, the appliance **200** accelerates delivery of a computing environment **15**, or any portion thereof, to a client **102**. In one embodiment, the appliance **200** accelerates the delivery of the computing environment **15** by the application delivery system **190**. For example, the embodiments described herein may be used to accelerate delivery of a streaming application and data file processable by the application from a central corporate data center to a remote user

location, such as a branch office of the company. In another embodiment, the appliance **200** accelerates transport layer traffic between a client **102** and a server **106**. The appliance **200** may provide acceleration techniques for accelerating any transport layer payload from a server **106** to a client **102**, such as: 1) transport layer connection pooling, 2) transport layer connection multiplexing, 3) transport control protocol buffering, 4) compression and 5) caching. In some embodiments, the appliance **200** provides load balancing of servers **106** in responding to requests from clients **102**. In other embodiments, the appliance **200** acts as a proxy or access server to provide access to the one or more servers **106**. In another embodiment, the appliance **200** provides a secure virtual private network connection from a first network **104** of the client **102** to the second network **104'** of the server **106**, such as an SSL VPN connection. In yet other embodiments, the appliance **200** provides application firewall security, control and management of the connection and communications between a client **102** and a server **106**.

In some embodiments, the application delivery management system **190** provides application delivery techniques to deliver a computing environment to a desktop of a user, remote or otherwise, based on a plurality of execution methods and based on any authentication and authorization policies applied via a policy engine **195**. With these techniques, a remote user may obtain a computing environment and access to server stored applications and data files from any network connected device **100**. In one embodiment, the application delivery system **190** may reside or execute on a server **106**. In another embodiment, the application delivery system **190** may reside or execute on a plurality of servers **106a-106n**. In some embodiments, the application delivery system **190** may execute in a server farm **38**. In one embodiment, the server **106** executing the application delivery system **190** may also store or provide the application and data file. In another embodiment, a first set of one or more servers **106** may execute the application delivery system **190**, and a different server **106n** may store or provide the application and data file. In some embodiments, each of the application delivery system **190**, the application, and data file may reside or be located on different servers. In yet another embodiment, any portion of the application delivery system **190** may reside, execute or be stored on or distributed to the appliance **200**, or a plurality of appliances.

The client **102** may include a computing environment **15** for executing an application that uses or processes a data file. The client **102** via networks **104**, **104'** and appliance **200** may request an application and data file from the server **106**. In one embodiment, the appliance **200** may forward a request from the client **102** to the server **106**. For example, the client **102** may not have the application and data file stored or accessible locally. In response to the request, the application delivery system **190** and/or server **106** may deliver the application and data file to the client **102**. For example, in one embodiment, the server **106** may transmit the application as an application stream to operate in computing environment **15** on client **102**.

In some embodiments, the application delivery system **190** comprises any portion of the Citrix Access Suite™ by Citrix Systems, Inc., such as the MetaFrame or Citrix Presentation Server™ and/or any of the Microsoft® Windows Terminal Services manufactured by the Microsoft Corporation. In one embodiment, the application delivery system **190** may deliver one or more applications to clients **102** or users via a remote-display protocol or otherwise via remote-based or server-based computing. In another embodiment, the application delivery system **190** may deliver one or more applications to clients or users via streaming of the application.

In one embodiment, the application delivery system **190** includes a policy engine **195** for controlling and managing the access to, selection of application execution methods and the delivery of applications. In some embodiments, the policy engine **195** determines the one or more applications a user or client **102** may access. In another embodiment, the policy engine **195** determines how the application should be delivered to the user or client **102**, e.g., the method of execution. In some embodiments, the application delivery system **190** provides a plurality of delivery techniques from which to select a method of application execution, such as a server-based computing, streaming or delivering the application locally to the client **120** for local execution.

In one embodiment, a client **102** requests execution of an application program and the application delivery system **190** comprising a server **106** selects a method of executing the application program. In some embodiments, the server **106** receives credentials from the client **102**. In another embodiment, the server **106** receives a request for an enumeration of available applications from the client **102**. In one embodiment, in response to the request or receipt of credentials, the application delivery system **190** enumerates a plurality of application programs available to the client **102**. The application delivery system **190** receives a request to execute an enumerated application. The application delivery system **190** selects one of a predetermined number of methods for executing the enumerated application, for example, responsive to a policy of a policy engine. The application delivery system **190** may select a method of execution of the application enabling the client **102** to receive application-output data generated by execution of the application program on a server **106**. The application delivery system **190** may select a method of execution of the application enabling the local machine **10** to execute the application program locally after retrieving a plurality of application files comprising the application. In yet another embodiment, the application delivery system **190** may select a method of execution of the application to stream the application via the network **104** to the client **102**.

A client **102** may execute, operate or otherwise provide an application, which can be any type and/or form of software, program, or executable instructions such as any type and/or form of web browser, web-based client, client-server application, a thin-client computing client, an ActiveX control, or a Java applet, or any other type and/or form of executable instructions capable of executing on client **102**. In some embodiments, the application may be a server-based or a remote-based application executed on behalf of the client **102** on a server **106**. In one embodiment the server **106** may display output to the client **102** using any thin-client or remote-display protocol, such as the Independent Computing Architecture (ICA) protocol manufactured by Citrix Systems, Inc. of Ft. Lauderdale, Fla. or the Remote Desktop Protocol (RDP) manufactured by the Microsoft Corporation of Redmond, Wash. The application can use any type of protocol and it can be, for example, an HTTP client, an FTP client, an Oscar client, or a Telnet client. In other embodiments, the application comprises any type of software related to VoIP communications, such as a soft IP telephone. In further embodiments, the application comprises any application related to real-time data communications, such as applications for streaming video and/or audio.

In some embodiments, the server **106** or a server farm **38** may be running one or more applications, such as an application providing a thin-client computing or remote display presentation application. In one embodiment, the server **106** or server farm **38** executes as an application, any portion of

the Citrix Access Suite™ by Citrix Systems, Inc., such as the MetaFrame or Citrix Presentation Server™, and/or any of the Microsoft® Windows Terminal Services manufactured by the Microsoft Corporation. In one embodiment, the application is an ICA client, developed by Citrix Systems, Inc. of Fort Lauderdale, Fla. In other embodiments, the application includes a Remote Desktop (RDP) client, developed by Microsoft Corporation of Redmond, Wash. Also, the server **106** may run an application, which for example, may be an application server providing email services such as Microsoft Exchange manufactured by the Microsoft Corporation of Redmond, Wash., a web or Internet server, or a desktop sharing server, or a collaboration server. In some embodiments, any of the applications may comprise any type of hosted service or products, such as GoToMeeting™ provided by Citrix Online Division, Inc. of Santa Barbara, Calif., WebEx™ provided by WebEx, Inc. of Santa Clara, Calif., or Microsoft Office Live Meeting provided by Microsoft Corporation of Redmond, Wash.

Still referring to FIG. 1D, an embodiment of the network environment may include a monitoring server **106A**. The monitoring server **106A** may include any type and form performance monitoring service **198**. The performance monitoring service **198** may include monitoring, measurement and/or management software and/or hardware, including data collection, aggregation, analysis, management and reporting. In one embodiment, the performance monitoring service **198** includes one or more monitoring agents **197**. The monitoring agent **197** includes any software, hardware or combination thereof for performing monitoring, measurement and data collection activities on a device, such as a client **102**, server **106** or an appliance **200**, **205**. In some embodiments, the monitoring agent **197** includes any type and form of script, such as Visual Basic script, or Javascript. In one embodiment, the monitoring agent **197** executes transparently to any application and/or user of the device. In some embodiments, the monitoring agent **197** is installed and operated unobtrusively to the application or client. In yet another embodiment, the monitoring agent **197** is installed and operated without any instrumentation for the application or device.

In some embodiments, the monitoring agent **197** monitors, measures and collects data on a predetermined frequency. In other embodiments, the monitoring agent **197** monitors, measures and collects data based upon detection of any type and form of event. For example, the monitoring agent **197** may collect data upon detection of a request for a web page or receipt of an HTTP response. In another example, the monitoring agent **197** may collect data upon detection of any user input events, such as a mouse click. The monitoring agent **197** may report or provide any monitored, measured or collected data to the monitoring service **198**. In one embodiment, the monitoring agent **197** transmits information to the monitoring service **198** according to a schedule or a predetermined frequency. In another embodiment, the monitoring agent **197** transmits information to the monitoring service **198** upon detection of an event.

In some embodiments, the monitoring service **198** and/or monitoring agent **197** performs monitoring and performance measurement of any network resource or network infrastructure element, such as a client, server, server farm, appliance **200**, appliance **205**, or network connection. In one embodiment, the monitoring service **198** and/or monitoring agent **197** performs monitoring and performance measurement of any transport layer connection, such as a TCP or UDP connection. In another embodiment, the monitoring service **198** and/or monitoring agent **197** monitors and measures network

latency. In yet one embodiment, the monitoring service **198** and/or monitoring agent **197** monitors and measures bandwidth utilization.

In other embodiments, the monitoring service **198** and/or monitoring agent **197** monitors and measures end-user response times. In some embodiments, the monitoring service **198** performs monitoring and performance measurement of an application. In another embodiment, the monitoring service **198** and/or monitoring agent **197** performs monitoring and performance measurement of any session or connection to the application. In one embodiment, the monitoring service **198** and/or monitoring agent **197** monitors and measures performance of a browser. In another embodiment, the monitoring service **198** and/or monitoring agent **197** monitors and measures performance of HTTP based transactions. In some embodiments, the monitoring service **198** and/or monitoring agent **197** monitors and measures performance of a Voice over IP (VoIP) application or session. In other embodiments, the monitoring service **198** and/or monitoring agent **197** monitors and measures performance of a remote display protocol application, such as an ICA client or RDP client. In yet another embodiment, the monitoring service **198** and/or monitoring agent **197** monitors and measures performance of any type and form of streaming media. In still a further embodiment, the monitoring service **198** and/or monitoring agent **197** monitors and measures performance of a hosted application or a Software-As-A-Service (SaaS) delivery model.

In some embodiments, the monitoring service **198** and/or monitoring agent **197** performs monitoring and performance measurement of one or more transactions, requests or responses related to application. In other embodiments, the monitoring service **198** and/or monitoring agent **197** monitors and measures any portion of an application layer stack, such as any .NET or J2EE calls. In one embodiment, the monitoring service **198** and/or monitoring agent **197** monitors and measures database or SQL transactions. In yet another embodiment, the monitoring service **198** and/or monitoring agent **197** monitors and measures any method, function or application programming interface (API) call.

In one embodiment, the monitoring service **198** and/or monitoring agent **197** performs monitoring and performance measurement of a delivery of application and/or data from a server to a client via one or more appliances, such as appliance **200** and/or appliance **205**. In some embodiments, the monitoring service **198** and/or monitoring agent **197** monitors and measures performance of delivery of a virtualized application. In other embodiments, the monitoring service **198** and/or monitoring agent **197** monitors and measures performance of delivery of a streaming application. In another embodiment, the monitoring service **198** and/or monitoring agent **197** monitors and measures performance of delivery of a desktop application to a client and/or the execution of the desktop application on the client. In another embodiment, the monitoring service **198** and/or monitoring agent **197** monitors and measures performance of a client/server application.

In one embodiment, the monitoring service **198** and/or monitoring agent **197** is designed and constructed to provide application performance management for the application delivery system **190**. For example, the monitoring service **198** and/or monitoring agent **197** may monitor, measure and manage the performance of the delivery of applications via the Citrix Presentation Server. In this example, the monitoring service **198** and/or monitoring agent **197** monitors individual ICA sessions. The monitoring service **198** and/or monitoring agent **197** may measure the total and per session system

13

resource usage, as well as application and networking performance. The monitoring service **198** and/or monitoring agent **197** may identify the active servers for a given user and/or user session. In some embodiments, the monitoring service **198** and/or monitoring agent **197** monitors back-end connections between the application delivery system **190** and an application and/or database server. The monitoring service **198** and/or monitoring agent **197** may measure network latency, delay and volume per user-session or ICA session.

In some embodiments, the monitoring service **198** and/or monitoring agent **197** measures and monitors memory usage for the application delivery system **190**, such as total memory usage, per user session and/or per process. In other embodiments, the monitoring service **198** and/or monitoring agent **197** measures and monitors CPU usage the application delivery system **190**, such as total CPU usage, per user session and/or per process. In another embodiment, the monitoring service **198** and/or monitoring agent **197** measures and monitors the time required to log-in to an application, a server, or the application delivery system, such as Citrix Presentation Server. In one embodiment, the monitoring service **198** and/or monitoring agent **197** measures and monitors the duration a user is logged into an application, a server, or the application delivery system **190**. In some embodiments, the monitoring service **198** and/or monitoring agent **197** measures and monitors active and inactive session counts for an application, server or application delivery system session. In yet another embodiment, the monitoring service **198** and/or monitoring agent **197** measures and monitors user session latency.

In yet further embodiments, the monitoring service **198** and/or monitoring agent **197** measures and monitors measures and monitors any type and form of server metrics. In one embodiment, the monitoring service **198** and/or monitoring agent **197** measures and monitors metrics related to system memory, CPU usage, and disk storage. In another embodiment, the monitoring service **198** and/or monitoring agent **197** measures and monitors metrics related to page faults, such as page faults per second. In other embodiments, the monitoring service **198** and/or monitoring agent **197** measures and monitors round-trip time metrics. In yet another embodiment, the monitoring service **198** and/or monitoring agent **197** measures and monitors metrics related to application crashes, errors and/or hangs.

In some embodiments, the monitoring service **198** and monitoring agent **198** includes any of the product embodiments referred to as EdgeSight manufactured by Citrix Systems, Inc. of Ft. Lauderdale, Fla. In another embodiment, the performance monitoring service **198** and/or monitoring agent **198** includes any portion of the product embodiments referred to as the TrueView product suite manufactured by the Symphoniq Corporation of Palo Alto, Calif. In one embodiment, the performance monitoring service **198** and/or monitoring agent **198** includes any portion of the product embodiments referred to as the TeaLeaf CX product suite manufactured by the TeaLeaf Technology Inc. of San Francisco, Calif. In other embodiments, the performance monitoring service **198** and/or monitoring agent **198** includes any portion of the business service management products, such as the BMC Performance Manager and Patrol products, manufactured by BMC Software, Inc. of Houston, Tex.

The client **102**, server **106**, and appliance **200** may be deployed as and/or executed on any type and form of computing device, such as a computer, network device or appliance capable of communicating on any type and form of network and performing the operations described herein. FIGS. 1E and 1F depict block diagrams of a computing device **100** useful for practicing an embodiment of the client **102**,

14

server **106** or appliance **200**. As shown in FIGS. 1E and 1F, each computing device **100** includes a central processing unit **101**, and a main memory unit **122**. As shown in FIG. 1E, a computing device **100** may include a visual display device **124**, a keyboard **126** and/or a pointing device **127**, such as a mouse. Each computing device **100** may also include additional optional elements, such as one or more input/output devices **130a-130b** (generally referred to using reference numeral **130**), and a cache memory **140** in communication with the central processing unit **101**.

The central processing unit **101** is any logic circuitry that responds to and processes instructions fetched from the main memory unit **122**. In many embodiments, the central processing unit is provided by a microprocessor unit, such as: those manufactured by Intel Corporation of Mountain View, Calif.; those manufactured by Motorola Corporation of Schaumburg, Ill.; those manufactured by Transmeta Corporation of Santa Clara, Calif.; the RS/6000 processor, those manufactured by International Business Machines of White Plains, N.Y.; or those manufactured by Advanced Micro Devices of Sunnyvale, Calif. The computing device **100** may be based on any of these processors, or any other processor capable of operating as described herein.

Main memory unit **122** may be one or more memory chips capable of storing data and allowing any storage location to be directly accessed by the microprocessor **101**, such as Static random access memory (SRAM), Burst SRAM or Synchronous Burst SRAM (BSRAM), Dynamic random access memory (DRAM), Fast Page Mode DRAM (FPM DRAM), Enhanced DRAM (EDRAM), Extended Data Output RAM (EDO RAM), Extended Data Output DRAM (EDO DRAM), Burst Extended Data Output DRAM (BEDO DRAM), Enhanced DRAM (EDRAM), synchronous DRAM (SDRAM), JEDEC SRAM, PC100 SDRAM, Double Data Rate SDRAM (DDR SDRAM), Enhanced SDRAM (ESDRAM), SyncLink DRAM (SLDRAM), Direct Rambus DRAM (DRDRAM), or Ferroelectric RAM (FRAM). The main memory **122** may be based on any of the above described memory chips, or any other available memory chips capable of operating as described herein. In the embodiment shown in FIG. 1E, the processor **101** communicates with main memory **122** via a system bus **150** (described in more detail below). FIG. 1F depicts an embodiment of a computing device **100** in which the processor communicates directly with main memory **122** via a memory port **103**. For example, in FIG. 1F the main memory **122** may be DRDRAM.

FIG. 1F depicts an embodiment in which the main processor **101** communicates directly with cache memory **140** via a secondary bus, sometimes referred to as a backside bus. In other embodiments, the main processor **101** communicates with cache memory **140** using the system bus **150**. Cache memory **140** typically has a faster response time than main memory **122** and is typically provided by SRAM, BSRAM, or EDRAM. In the embodiment shown in FIG. 1F, the processor **101** communicates with various I/O devices **130** via a local system bus **150**. Various busses may be used to connect the central processing unit **101** to any of the I/O devices **130**, including a VESA VL bus, an ISA bus, an EISA bus, a MicroChannel Architecture (MCA) bus, a PCI bus, a PCI-X bus, a PCI-Express bus, or a NuBus. For embodiments in which the I/O device is a video display **124**, the processor **101** may use an Advanced Graphics Port (AGP) to communicate with the display **124**. FIG. 1F depicts an embodiment of a computer **100** in which the main processor **101** communicates directly with I/O device **130b** via HyperTransport, Rapid I/O, or InfiniBand. FIG. 1F also depicts an embodiment in which local busses and direct communication are mixed:

the processor **101** communicates with I/O device **130b** using a local interconnect bus while communicating with I/O device **130a** directly.

The computing device **100** may support any suitable installation device **116**, such as a floppy disk drive for receiving floppy disks such as 3.5-inch, 5.25-inch disks or ZIP disks, a CD-ROM drive, a CD-R/RW drive, a DVD-ROM drive, tape drives of various formats, USB device, hard-drive or any other device suitable for installing software and programs such as any client agent **120**, or portion thereof. The computing device **100** may further comprise a storage device **128**, such as one or more hard disk drives or redundant arrays of independent disks, for storing an operating system and other related software, and for storing application software programs such as any program related to the client agent **120**. Optionally, any of the installation devices **116** could also be used as the storage device **128**. Additionally, the operating system and the software can be run from a bootable medium, for example, a bootable CD, such as KNOPPIX®, a bootable CD for GNU/Linux that is available as a GNU/Linux distribution from knoppix.net.

Furthermore, the computing device **100** may include a network interface **118** to interface to a Local Area Network (LAN), Wide Area Network (WAN) or the Internet through a variety of connections including, but not limited to, standard telephone lines, LAN or WAN links (e.g., 802.11, T1, T3, 56 kb, X.25), broadband connections (e.g., ISDN, Frame Relay, ATM), wireless connections, or some combination of any or all of the above. The network interface **118** may comprise a built-in network adapter, network interface card, PCMCIA network card, card bus network adapter, wireless network adapter, USB network adapter, modem or any other device suitable for interfacing the computing device **100** to any type of network capable of communication and performing the operations described herein.

A wide variety of I/O devices **130a-130n** may be present in the computing device **100**. Input devices include keyboards, mice, trackpads, trackballs, microphones, and drawing tablets. Output devices include video displays, speakers, inkjet printers, laser printers, and dye-sublimation printers. The I/O devices **130** may be controlled by an I/O controller **123** as shown in FIG. 1E. The I/O controller may control one or more I/O devices such as a keyboard **126** and a pointing device **127**, e.g., a mouse or optical pen. Furthermore, an I/O device may also provide storage **128** and/or an installation medium **116** for the computing device **100**. In still other embodiments, the computing device **100** may provide USB connections to receive handheld USB storage devices such as the USB Flash Drive line of devices manufactured by Twintech Industry, Inc. of Los Alamitos, Calif.

In some embodiments, the computing device **100** may comprise or be connected to multiple display devices **124a-124n**, which each may be of the same or different type and/or form. As such, any of the I/O devices **130a-130n** and/or the I/O controller **123** may comprise any type and/or form of suitable hardware, software, or combination of hardware and software to support, enable or provide for the connection and use of multiple display devices **124a-124n** by the computing device **100**. For example, the computing device **100** may include any type and/or form of video adapter, video card, driver, and/or library to interface, communicate, connect or otherwise use the display devices **124a-124n**. In one embodiment, a video adapter may comprise multiple connectors to interface to multiple display devices **124a-124n**. In other embodiments, the computing device **100** may include multiple video adapters, with each video adapter connected to one or more of the display devices **124a-124n**. In some embodi-

ments, any portion of the operating system of the computing device **100** may be configured for using multiple displays **124a-124n**. In other embodiments, one or more of the display devices **124a-124n** may be provided by one or more other computing devices, such as computing devices **100a** and **100b** connected to the computing device **100**, for example, via a network. These embodiments may include any type of software designed and constructed to use another computer's display device as a second display device **124a** for the computing device **100**. One ordinarily skilled in the art will recognize and appreciate the various ways and embodiments that a computing device **100** may be configured to have multiple display devices **124a-124n**.

In further embodiments, an I/O device **130** may be a bridge **170** between the system bus **150** and an external communication bus, such as a USB bus, an Apple Desktop Bus, an RS-232 serial connection, a SCSI bus, a FireWire bus, a FireWire 800 bus, an Ethernet bus, an AppleTalk bus, a Gigabit Ethernet bus, an Asynchronous Transfer Mode bus, a HIPPI bus, a Super HIPPI bus, a SerialPlus bus, a SCI/LAMP bus, a FibreChannel bus, or a Serial Attached small computer system interface bus.

A computing device **100** of the sort depicted in FIGS. 1E and 1F typically operate under the control of operating systems, which control scheduling of tasks and access to system resources. The computing device **100** can be running any operating system such as any of the versions of the Microsoft® Windows operating systems, the different releases of the Unix and Linux operating systems, any version of the Mac OS® for Macintosh computers, any embedded operating system, any real-time operating system, any open source operating system, any proprietary operating system, any operating systems for mobile computing devices, or any other operating system capable of running on the computing device and performing the operations described herein. Typical operating systems include: WINDOWS 3.x, WINDOWS 95, WINDOWS 98, WINDOWS 2000, WINDOWS NT 3.51, WINDOWS NT 4.0, WINDOWS CE, and WINDOWS XP, all of which are manufactured by Microsoft Corporation of Redmond, Wash.; MacOS, manufactured by Apple Computer of Cupertino, Calif.; OS/2, manufactured by International Business Machines of Armonk, N.Y.; and Linux, a freely-available operating system distributed by Caldera Corp. of Salt Lake City, Utah, or any type and/or form of a Unix operating system, among others.

In other embodiments, the computing device **100** may have different processors, operating systems, and input devices consistent with the device. For example, in one embodiment the computer **100** is a Treo 180, 270, 1060, 600 or 650 smart phone manufactured by Palm, Inc. In this embodiment, the Treo smart phone is operated under the control of the PalmOS operating system and includes a stylus input device as well as a five-way navigator device. Moreover, the computing device **100** can be any workstation, desktop computer, laptop or notebook computer, server, handheld computer, mobile telephone, any other computer, or other form of computing or telecommunications device that is capable of communication and that has sufficient processor power and memory capacity to perform the operations described herein.

As shown in FIG. 1G, the computing device **100** may comprise multiple processors and may provide functionality for simultaneous execution of instructions or for simultaneous execution of one instruction on more than one piece of data. In some embodiments, the computing device **100** may comprise a parallel processor with one or more cores. In one of these embodiments, the computing device **100** is a shared memory parallel device, with multiple processors and/or mul-

tiple processor cores, accessing all available memory as a single global address space. In another of these embodiments, the computing device **100** is a distributed memory parallel device with multiple processors each accessing local memory only. In still another of these embodiments, the computing device **100** has both some memory which is shared and some memory which can only be accessed by particular processors or subsets of processors. In still even another of these embodiments, the computing device **100**, such as a multi-core micro-processor, combines two or more independent processors into a single package, often a single integrated circuit (IC). In yet another of these embodiments, the computing device **100** includes a chip having a CELL BROADBAND ENGINE architecture and including a Power processor element and a plurality of synergistic processing elements, the Power processor element and the plurality of synergistic processing elements linked together by an internal high speed bus, which may be referred to as an element interconnect bus.

In some embodiments, the processors provide functionality for execution of a single instruction simultaneously on multiple pieces of data (SIMD). In other embodiments, the processors provide functionality for execution of multiple instructions simultaneously on multiple pieces of data (MIMD). In still other embodiments, the processor may use any combination of SIMD and MIMD cores in a single device.

In some embodiments, the computing device **100** may comprise a graphics processing unit. In one of these embodiments, depicted in FIG. 1H, the computing device **100** includes at least one central processing unit **101** and at least one graphics processing unit. In another of these embodiments, the computing device **100** includes at least one parallel processing unit and at least one graphics processing unit. In still another of these embodiments, the computing device **100** includes a plurality of processing units of any type, one of the plurality of processing units comprising a graphics processing unit.

In some embodiments, a first computing device **100a** executes an application on behalf of a user of a client computing device **100b**. In other embodiments, a computing device **100a** executes a virtual machine, which provides an execution session within which applications execute on behalf of a user or a client computing devices **100b**. In one of these embodiments, the execution session is a hosted desktop session. In another of these embodiments, the computing device **100** executes a terminal services session. The terminal services session may provide a hosted desktop environment. In still another of these embodiments, the execution session provides access to a computing environment, which may comprise one or more of: an application, a plurality of applications, a desktop application, and a desktop session in which one or more applications may execute.

B. Appliance Architecture

FIG. 2A illustrates an example embodiment of the appliance **200**. The architecture of the appliance **200** in FIG. 2A is provided by way of illustration only and is not intended to be limiting. As shown in FIG. 2, appliance **200** comprises a hardware layer **206** and a software layer divided into a user space **202** and a kernel space **204**.

Hardware layer **206** provides the hardware elements upon which programs and services within kernel space **204** and user space **202** are executed. Hardware layer **206** also provides the structures and elements which allow programs and services within kernel space **204** and user space **202** to communicate data both internally and externally with respect to appliance **200**. As shown in FIG. 2, the hardware layer **206** includes a processing unit **262** for executing software pro-

grams and services, a memory **264** for storing software and data, network ports **266** for transmitting and receiving data over a network, and an encryption processor **260** for performing functions related to Secure Sockets Layer processing of data transmitted and received over the network. In some embodiments, the central processing unit **262** may perform the functions of the encryption processor **260** in a single processor. Additionally, the hardware layer **206** may comprise multiple processors for each of the processing unit **262** and the encryption processor **260**. The processor **262** may include any of the processors **101** described above in connection with FIGS. 1E and 1F. For example, in one embodiment, the appliance **200** comprises a first processor **262** and a second processor **262'**. In other embodiments, the processor **262** or **262'** comprises a multi-core processor.

Although the hardware layer **206** of appliance **200** is generally illustrated with an encryption processor **260**, processor **260** may be a processor for performing functions related to any encryption protocol, such as the Secure Socket Layer (SSL) or Transport Layer Security (TLS) protocol. In some embodiments, the processor **260** may be a general purpose processor (GPP), and in further embodiments, may have executable instructions for performing processing of any security related protocol.

Although the hardware layer **206** of appliance **200** is illustrated with certain elements in FIG. 2, the hardware portions or components of appliance **200** may comprise any type and form of elements, hardware or software, of a computing device, such as the computing device **100** illustrated and discussed herein in conjunction with FIGS. 1E and 1F. In some embodiments, the appliance **200** may comprise a server, gateway, router, switch, bridge or other type of computing or network device, and have any hardware and/or software elements associated therewith. The operating system of appliance **200** allocates, manages, or otherwise segregates the available system memory into kernel space **204** and user space **204**. In example software architecture **200**, the operating system may be any type and/or form of Unix operating system although the invention is not so limited. As such, the appliance **200** can be running any operating system such as any of the versions of the Microsoft® Windows operating systems, the different releases of the Unix and Linux operating systems, any version of the Mac OS® for Macintosh computers, any embedded operating system, any network operating system, any real-time operating system, any open source operating system, any proprietary operating system, any operating systems for mobile computing devices or network devices, or any other operating system capable of running on the appliance **200** and performing the operations described herein.

The kernel space **204** is reserved for running the kernel **230**, including any device drivers, kernel extensions or other kernel related software. As known to those skilled in the art, the kernel **230** is the core of the operating system, and provides access, control, and management of resources and hardware-related elements of the application **104**. In accordance with an embodiment of the appliance **200**, the kernel space **204** also includes a number of network services or processes working in conjunction with a cache manager **232**, sometimes also referred to as the integrated cache, the benefits of which are described in detail further herein. Additionally, the embodiment of the kernel **230** will depend on the embodiment of the operating system installed, configured, or otherwise used by the device **200**.

In one embodiment, the device **200** comprises one network stack **267**, such as a TCP/IP based stack, for communicating with the client **102** and/or the server **106**. In one embodiment,

the network stack **267** is used to communicate with a first network, such as network **108**, and a second network **110**. In some embodiments, the device **200** terminates a first transport layer connection, such as a TCP connection of a client **102**, and establishes a second transport layer connection to a server **106** for use by the client **102**, e.g., the second transport layer connection is terminated at the appliance **200** and the server **106**. The first and second transport layer connections may be established via a single network stack **267**. In other embodiments, the device **200** may comprise multiple network stacks, for example **267** and **267'**, and the first transport layer connection may be established or terminated at one network stack **267**, and the second transport layer connection on the second network stack **267'**. For example, one network stack may be for receiving and transmitting network packet on a first network, and another network stack for receiving and transmitting network packets on a second network. In one embodiment, the network stack **267** comprises a buffer **243** for queuing one or more network packets for transmission by the appliance **200**.

As shown in FIG. 2A, the kernel space **204** includes the cache manager **232**, a high-speed layer 2-7 integrated packet engine **240**, an encryption engine **234**, a policy engine **236** and multi-protocol compression logic **238**. Running these components or processes **232**, **240**, **234**, **236** and **238** in kernel space **204** or kernel mode instead of the user space **202** improves the performance of each of these components, alone and in combination. Kernel operation means that these components or processes **232**, **240**, **234**, **236** and **238** run in the core address space of the operating system of the device **200**. For example, running the encryption engine **234** in kernel mode improves encryption performance by moving encryption and decryption operations to the kernel, thereby reducing the number of transitions between the memory space or a kernel thread in kernel mode and the memory space or a thread in user mode. For example, data obtained in kernel mode may not need to be passed or copied to a process or thread running in user mode, such as from a kernel level data structure to a user level data structure. In another aspect, the number of context switches between kernel mode and user mode are also reduced. Additionally, synchronization of and communications between any of the components or processes **232**, **240**, **235**, **236** and **238** can be performed more efficiently in the kernel space **204**.

In some embodiments, any portion of the components **232**, **240**, **234**, **236** and **238** may run or operate in the kernel space **204**, while other portions of these components **232**, **240**, **234**, **236** and **238** may run or operate in user space **202**. In one embodiment, the appliance **200** uses a kernel-level data structure providing access to any portion of one or more network packets, for example, a network packet comprising a request from a client **102** or a response from a server **106**. In some embodiments, the kernel-level data structure may be obtained by the packet engine **240** via a transport layer driver interface or filter to the network stack **267**. The kernel-level data structure may comprise any interface and/or data accessible via the kernel space **204** related to the network stack **267**, network traffic or packets received or transmitted by the network stack **267**. In other embodiments, the kernel-level data structure may be used by any of the components or processes **232**, **240**, **234**, **236** and **238** to perform the desired operation of the component or process. In one embodiment, a component **232**, **240**, **234**, **236** and **238** is running in kernel mode **204** when using the kernel-level data structure, while in another embodiment, the component **232**, **240**, **234**, **236** and **238** is running in user mode when using the kernel-level data structure. In some embodiments, the kernel-level data structure

may be copied or passed to a second kernel-level data structure, or any desired user-level data structure.

The cache manager **232** may comprise software, hardware or any combination of software and hardware to provide cache access, control and management of any type and form of content, such as objects or dynamically generated objects served by the originating servers **106**. The data, objects or content processed and stored by the cache manager **232** may comprise data in any format, such as a markup language, or communicated via any protocol. In some embodiments, the cache manager **232** duplicates original data stored elsewhere or data previously computed, generated or transmitted, in which the original data may require longer access time to fetch, compute or otherwise obtain relative to reading a cache memory element. Once the data is stored in the cache memory element, future use can be made by accessing the cached copy rather than refetching or recomputing the original data, thereby reducing the access time. In some embodiments, the cache memory element may comprise a data object in memory **264** of device **200**. In other embodiments, the cache memory element may comprise memory having a faster access time than memory **264**. In another embodiment, the cache memory element may comprise any type and form of storage element of the device **200**, such as a portion of a hard disk. In some embodiments, the processing unit **262** may provide cache memory for use by the cache manager **232**. In yet further embodiments, the cache manager **232** may use any portion and combination of memory, storage, or the processing unit for caching data, objects, and other content.

Furthermore, the cache manager **232** includes any logic, functions, rules, or operations to perform any embodiments of the techniques of the appliance **200** described herein. For example, the cache manager **232** includes logic or functionality to invalidate objects based on the expiration of an invalidation time period or upon receipt of an invalidation command from a client **102** or server **106**. In some embodiments, the cache manager **232** may operate as a program, service, process or task executing in the kernel space **204**, and in other embodiments, in the user space **202**. In one embodiment, a first portion of the cache manager **232** executes in the user space **202** while a second portion executes in the kernel space **204**. In some embodiments, the cache manager **232** can comprise any type of general purpose processor (GPP), or any other type of integrated circuit, such as a Field Programmable Gate Array (FPGA), Programmable Logic Device (PLD), or Application Specific Integrated Circuit (ASIC).

The policy engine **236** may include, for example, an intelligent statistical engine or other programmable application(s). In one embodiment, the policy engine **236** provides a configuration mechanism to allow a user to identify, specify, define or configure a caching policy. Policy engine **236**, in some embodiments, also has access to memory to support data structures such as lookup tables or hash tables to enable user-selected caching policy decisions. In other embodiments, the policy engine **236** may comprise any logic, rules, functions or operations to determine and provide access, control and management of objects, data or content being cached by the appliance **200** in addition to access, control and management of security, network traffic, network access, compression or any other function or operation performed by the appliance **200**. Further examples of specific caching policies are further described herein.

The encryption engine **234** comprises any logic, business rules, functions or operations for handling the processing of any security related protocol, such as SSL or TLS, or any function related thereto. For example, the encryption engine **234** encrypts and decrypts network packets, or any portion

thereof, communicated via the appliance **200**. The encryption engine **234** may also setup or establish SSL or TLS connections on behalf of the client **102a-102n**, server **106a-106n**, or appliance **200**. As such, the encryption engine **234** provides offloading and acceleration of SSL processing. In one embodiment, the encryption engine **234** uses a tunneling protocol to provide a virtual private network between a client **102a-102n** and a server **106a-106n**. In some embodiments, the encryption engine **234** is in communication with the Encryption processor **260**. In other embodiments, the encryption engine **234** comprises executable instructions running on the Encryption processor **260**.

The multi-protocol compression engine **238** comprises any logic, business rules, function or operations for compressing one or more protocols of a network packet, such as any of the protocols used by the network stack **267** of the device **200**. In one embodiment, multi-protocol compression engine **238** compresses bi-directionally between clients **102a-102n** and servers **106a-106n** any TCP/IP based protocol, including Messaging Application Programming Interface (MAPI) (email), File Transfer Protocol (FTP), HyperText Transfer Protocol (HTTP), Common Internet File System (CIFS) protocol (file transfer), Independent Computing Architecture (ICA) protocol, Remote Desktop Protocol (RDP), Wireless Application Protocol (WAP), Mobile IP protocol, and Voice Over IP (VoIP) protocol. In other embodiments, multi-protocol compression engine **238** provides compression of HyperText Markup Language (HTML) based protocols and in some embodiments, provides compression of any markup languages, such as the Extensible Markup Language (XML). In one embodiment, the multi-protocol compression engine **238** provides compression of any high-performance protocol, such as any protocol designed for appliance **200** to appliance **200** communications. In another embodiment, the multi-protocol compression engine **238** compresses any payload of or any communication using a modified transport control protocol, such as Transaction TCP (T/TCP), TCP with selection acknowledgements (TCP-SACK), TCP with large windows (TCP-LW), a congestion prediction protocol such as the TCP-Vegas protocol, and a TCP spoofing protocol.

As such, the multi-protocol compression engine **238** accelerates performance for users accessing applications via desktop clients, e.g., Microsoft Outlook and non-Web thin clients, such as any client launched by popular enterprise applications like Oracle, SAP and Siebel, and even mobile clients, such as the Pocket PC. In some embodiments, the multi-protocol compression engine **238** by executing in the kernel mode **204** and integrating with packet processing engine **240** accessing the network stack **267** is able to compress any of the protocols carried by the TCP/IP protocol, such as any application layer protocol.

High speed layer 2-7 integrated packet engine **240**, also generally referred to as a packet processing engine or packet engine, is responsible for managing the kernel-level processing of packets received and transmitted by appliance **200** via network ports **266**. The high speed layer 2-7 integrated packet engine **240** may comprise a buffer for queuing one or more network packets during processing, such as for receipt of a network packet or transmission of a network packet. Additionally, the high speed layer 2-7 integrated packet engine **240** is in communication with one or more network stacks **267** to send and receive network packets via network ports **266**. The high speed layer 2-7 integrated packet engine **240** works in conjunction with encryption engine **234**, cache manager **232**, policy engine **236** and multi-protocol compression logic **238**. In particular, encryption engine **234** is configured to perform SSL processing of packets, policy engine **236** is configured to

perform functions related to traffic management such as request-level content switching and request-level cache redirection, and multi-protocol compression logic **238** is configured to perform functions related to compression and decompression of data.

The high speed layer 2-7 integrated packet engine **240** includes a packet processing timer **242**. In one embodiment, the packet processing timer **242** provides one or more time intervals to trigger the processing of incoming, i.e., received, or outgoing, i.e., transmitted, network packets.

In some embodiments, the high speed layer 2-7 integrated packet engine **240** processes network packets responsive to the timer **242**. The packet processing timer **242** provides any type and form of signal to the packet engine **240** to notify, trigger, or communicate a time related event, interval or occurrence. In many embodiments, the packet processing timer **242** operates in the order of milliseconds, such as for example 100 ms, 50 ms or 25 ms. For example, in some embodiments, the packet processing timer **242** provides time intervals or otherwise causes a network packet to be processed by the high speed layer 2-7 integrated packet engine **240** at a 10 ms time interval, while in other embodiments, at a 5 ms time interval, and still yet in further embodiments, as short as a 3, 2, or 1 ms time interval. The high speed layer 2-7 integrated packet engine **240** may be interfaced, integrated or in communication with the encryption engine **234**, cache manager **232**, policy engine **236** and multi-protocol compression engine **238** during operation. As such, any of the logic, functions, or operations of the encryption engine **234**, cache manager **232**, policy engine **236** and multi-protocol compression logic **238** may be performed responsive to the packet processing timer **242** and/or the packet engine **240**. Therefore, any of the logic, functions, or operations of the encryption engine **234**, cache manager **232**, policy engine **236** and multi-protocol compression logic **238** may be performed at the granularity of time intervals provided via the packet processing timer **242**, for example, at a time interval of less than or equal to 10 ms. For example, in one embodiment, the cache manager **232** may perform invalidation of any cached objects responsive to the high speed layer 2-7 integrated packet engine **240** and/or the packet processing timer **242**. In another embodiment, the expiry or invalidation time of a cached object can be set to the same order of granularity as the time interval of the packet processing timer **242**, such as at every 10 ms.

In contrast to kernel space **204**, user space **202** is the memory area or portion of the operating system used by user mode applications or programs otherwise running in user mode. A user mode application may not access kernel space **204** directly and uses service calls in order to access kernel services. As shown in FIG. 2, user space **202** of appliance **200** includes a graphical user interface (GUI) **210**, a command line interface (CLI) **212**, shell services **214**, health monitoring program **216**, and daemon services **218**. GUI **210** and CLI **212** provide a means by which a system administrator or other user can interact with and control the operation of appliance **200**, such as via the operating system of the appliance **200**. The GUI **210** or CLI **212** can comprise code running in user space **202** or kernel space **204**. The GUI **210** may be any type and form of graphical user interface and may be presented via text, graphical or otherwise, by any type of program or application, such as a browser. The CLI **212** may be any type and form of command line or text-based interface, such as a command line provided by the operating system. For example, the CLI **212** may comprise a shell, which is a tool to enable users to interact with the operating system. In some embodiments, the CLI **212** may be provided via a bash, csh,

tcsh, or ksh type shell. The shell services **214** comprises the programs, services, tasks, processes or executable instructions to support interaction with the appliance **200** or operating system by a user via the GUI **210** and/or CLI **212**.

Health monitoring program **216** is used to monitor, check, report and ensure that network systems are functioning properly and that users are receiving requested content over a network. Health monitoring program **216** comprises one or more programs, services, tasks, processes or executable instructions to provide logic, rules, functions or operations for monitoring any activity of the appliance **200**. In some embodiments, the health monitoring program **216** intercepts and inspects any network traffic passed via the appliance **200**. In other embodiments, the health monitoring program **216** interfaces by any suitable means and/or mechanisms with one or more of the following: the encryption engine **234**, cache manager **232**, policy engine **236**, multi-protocol compression logic **238**, packet engine **240**, daemon services **218**, and shell services **214**. As such, the health monitoring program **216** may call any application programming interface (API) to determine a state, status, or health of any portion of the appliance **200**. For example, the health monitoring program **216** may ping or send a status inquiry on a periodic basis to check if a program, process, service or task is active and currently running. In another example, the health monitoring program **216** may check any status, error or history logs provided by any program, process, service or task to determine any condition, status or error with any portion of the appliance **200**.

Daemon services **218** are programs that run continuously or in the background and handle periodic service requests received by appliance **200**. In some embodiments, a daemon service may forward the requests to other programs or processes, such as another daemon service **218** as appropriate. As known to those skilled in the art, a daemon service **218** may run unattended to perform continuous or periodic system wide functions, such as network control, or to perform any desired task. In some embodiments, one or more daemon services **218** run in the user space **202**, while in other embodiments, one or more daemon services **218** run in the kernel space.

Referring now to FIG. 2B, another embodiment of the appliance **200** is depicted. In brief overview, the appliance **200** provides one or more of the following services, functionality or operations: SSL VPN connectivity **280**, switching/load balancing **284**, Domain Name Service resolution **286**, acceleration **288** and an application firewall **290** for communications between one or more clients **102** and one or more servers **106**. Each of the servers **106** may provide one or more network related services **270a-270n** (referred to as services **270**). For example, a server **106** may provide an http service **270**. The appliance **200** comprises one or more virtual servers or virtual internet protocol servers, referred to as a vServer, VIP server, or just VIP **275a-275n** (also referred herein as vServer **275**). The vServer **275** receives, intercepts or otherwise processes communications between a client **102** and a server **106** in accordance with the configuration and operations of the appliance **200**.

The vServer **275** may comprise software, hardware or any combination of software and hardware. The vServer **275** may comprise any type and form of program, service, task, process or executable instructions operating in user mode **202**, kernel mode **204** or any combination thereof in the appliance **200**. The vServer **275** includes any logic, functions, rules, or operations to perform any embodiments of the techniques described herein, such as SSL VPN **280**, switching/load balancing **284**, Domain Name Service resolution **286**, accelera-

tion **288** and an application firewall **290**. In some embodiments, the vServer **275** establishes a connection to a service **270** of a server **106**. The service **275** may comprise any program, application, process, task or set of executable instructions capable of connecting to and communicating to the appliance **200**, client **102** or vServer **275**. For example, the service **275** may comprise a web server, http server, ftp, email or database server. In some embodiments, the service **270** is a daemon process or network driver for listening, receiving and/or sending communications for an application, such as email, database or an enterprise application. In some embodiments, the service **270** may communicate on a specific IP address, or IP address and port.

In some embodiments, the vServer **275** applies one or more policies of the policy engine **236** to network communications between the client **102** and server **106**. In one embodiment, the policies are associated with a vServer **275**. In another embodiment, the policies are based on a user, or a group of users. In yet another embodiment, a policy is global and applies to one or more vServers **275a-275n**, and any user or group of users communicating via the appliance **200**. In some embodiments, the policies of the policy engine have conditions upon which the policy is applied based on any content of the communication, such as internet protocol address, port, protocol type, header or fields in a packet, or the context of the communication, such as user, group of the user, vServer **275**, transport layer connection, and/or identification or attributes of the client **102** or server **106**.

In other embodiments, the appliance **200** communicates or interfaces with the policy engine **236** to determine authentication and/or authorization of a remote user or a remote client **102** to access the computing environment **15**, application, and/or data file from a server **106**. In another embodiment, the appliance **200** communicates or interfaces with the policy engine **236** to determine authentication and/or authorization of a remote user or a remote client **102** to have the application delivery system **190** deliver one or more of the computing environment **15**, application, and/or data file. In yet another embodiment, the appliance **200** establishes a VPN or SSL VPN connection based on the policy engine's **236** authentication and/or authorization of a remote user or a remote client **102**. In one embodiment, the appliance **200** controls the flow of network traffic and communication sessions based on policies of the policy engine **236**. For example, the appliance **200** may control the access to a computing environment **15**, application or data file based on the policy engine **236**.

In some embodiments, the vServer **275** establishes a transport layer connection, such as a TCP or UDP connection with a client **102** via the client agent **120**. In one embodiment, the vServer **275** listens for and receives communications from the client **102**. In other embodiments, the vServer **275** establishes a transport layer connection, such as a TCP or UDP connection with a client server **106**. In one embodiment, the vServer **275** establishes the transport layer connection to an internet protocol address and port of a server **270** running on the server **106**. In another embodiment, the vServer **275** associates a first transport layer connection to a client **102** with a second transport layer connection to the server **106**. In some embodiments, a vServer **275** establishes a pool of transport layer connections to a server **106** and multiplexes client requests via the pooled transport layer connections.

In some embodiments, the appliance **200** provides a SSL VPN connection **280** between a client **102** and a server **106**. For example, a client **102** on a first network **102** requests to establish a connection to a server **106** on a second network **104'**. In some embodiments, the second network **104'** is not routable from the first network **104**. In other embodiments,

the client **102** is on a public network **104** and the server **106** is on a private network **104'**, such as a corporate network. In one embodiment, the client agent **120** intercepts communications of the client **102** on the first network **104**, encrypts the communications, and transmits the communications via a first transport layer connection to the appliance **200**. The appliance **200** associates the first transport layer connection on the first network **104** to a second transport layer connection to the server **106** on the second network **104**. The appliance **200** receives the intercepted communication from the client agent **102**, decrypts the communications, and transmits the communication to the server **106** on the second network **104** via the second transport layer connection. The second transport layer connection may be a pooled transport layer connection. As such, the appliance **200** provides an end-to-end secure transport layer connection for the client **102** between the two networks **104, 104'**.

In one embodiment, the appliance **200** hosts an intranet internet protocol or IntranetIP **282** address of the client **102** on the virtual private network **104**. The client **102** has a local network identifier, such as an internet protocol (IP) address and/or host name on the first network **104**. When connected to the second network **104'** via the appliance **200**, the appliance **200** establishes, assigns or otherwise provides an IntranetIP address **282**, which is a network identifier, such as IP address and/or host name, for the client **102** on the second network **104'**. The appliance **200** listens for and receives on the second or private network **104'** for any communications directed towards the client **102** using the client's established IntranetIP **282**. In one embodiment, the appliance **200** acts as or on behalf of the client **102** on the second private network **104**. For example, in another embodiment, a vServer **275** listens for and responds to communications to the IntranetIP **282** of the client **102**. In some embodiments, if a computing device **100** on the second network **104'** transmits a request, the appliance **200** processes the request as if it were the client **102**. For example, the appliance **200** may respond to a ping to the client's IntranetIP **282**. In another example, the appliance may establish a connection, such as a TCP or UDP connection, with computing device **100** on the second network **104** requesting a connection with the client's IntranetIP **282**.

In some embodiments, the appliance **200** provides one or more of the following acceleration techniques **288** to communications between the client **102** and server **106**: 1) compression; 2) decompression; 3) Transmission Control Protocol pooling; 4) Transmission Control Protocol multiplexing; 5) Transmission Control Protocol buffering; and 6) caching. In one embodiment, the appliance **200** relieves servers **106** of much of the processing load caused by repeatedly opening and closing transport layers connections to clients **102** by opening one or more transport layer connections with each server **106** and maintaining these connections to allow repeated data accesses by clients via the Internet. This technique is referred to herein as "connection pooling".

In some embodiments, in order to seamlessly splice communications from a client **102** to a server **106** via a pooled transport layer connection, the appliance **200** translates or multiplexes communications by modifying sequence number and acknowledgment numbers at the transport layer protocol level. This is referred to as "connection multiplexing". In some embodiments, no application layer protocol interaction is required. For example, in the case of an in-bound packet (that is, a packet received from a client **102**), the source network address of the packet is changed to that of an output port of appliance **200**, and the destination network address is changed to that of the intended server. In the case of an outbound packet (that is, one received from a server **106**), the

source network address is changed from that of the server **106** to that of an output port of appliance **200** and the destination address is changed from that of appliance **200** to that of the requesting client **102**. The sequence numbers and acknowledgment numbers of the packet are also translated to sequence numbers and acknowledgement numbers expected by the client **102** on the appliance's **200** transport layer connection to the client **102**. In some embodiments, the packet checksum of the transport layer protocol is recalculated to account for these translations.

In another embodiment, the appliance **200** provides switching or load-balancing functionality **284** for communications between the client **102** and server **106**. In some embodiments, the appliance **200** distributes traffic and directs client requests to a server **106** based on layer 4 or application-layer request data. In one embodiment, although the network layer or layer 2 of the network packet identifies a destination server **106**, the appliance **200** determines the server **106** to distribute the network packet by application information and data carried as payload of the transport layer packet. In one embodiment, the health monitoring programs **216** of the appliance **200** monitor the health of servers to determine the server **106** for which to distribute a client's request. In some embodiments, if the appliance **200** detects a server **106** is not available or has a load over a predetermined threshold, the appliance **200** can direct or distribute client requests to another server **106**.

In some embodiments, the appliance **200** acts as a Domain Name Service (DNS) resolver or otherwise provides resolution of a DNS request from clients **102**. In some embodiments, the appliance intercepts a DNS request transmitted by the client **102**. In one embodiment, the appliance **200** responds to a client's DNS request with an IP address of or hosted by the appliance **200**. In this embodiment, the client **102** transmits network communication for the domain name to the appliance **200**. In another embodiment, the appliance **200** responds to a client's DNS request with an IP address of or hosted by a second appliance **200'**. In some embodiments, the appliance **200** responds to a client's DNS request with an IP address of a server **106** determined by the appliance **200**.

In yet another embodiment, the appliance **200** provides application firewall functionality **290** for communications between the client **102** and server **106**. In one embodiment, the policy engine **236** provides rules for detecting and blocking illegitimate requests. In some embodiments, the application firewall **290** protects against denial of service (DoS) attacks. In other embodiments, the appliance inspects the content of intercepted requests to identify and block application-based attacks. In some embodiments, the rules/policy engine **236** comprises one or more application firewall or security control policies for providing protections against various classes and types of web or Internet based vulnerabilities, such as one or more of the following: 1) buffer overflow, 2) CGI-BIN parameter manipulation, 3) form/hidden field manipulation, 4) forceful browsing, 5) cookie or session poisoning, 6) broken access control list (ACLs) or weak passwords, 7) cross-site scripting (XSS), 8) command injection, 9) SQL injection, 10) error triggering sensitive information leak, 11) insecure use of cryptography, 12) server misconfiguration, 13) back doors and debug options, 14) website defacement, 15) platform or operating systems vulnerabilities, and 16) zero-day exploits. In an embodiment, the application firewall **290** provides HTML form field protection in the form of inspecting or analyzing the network communication for one or more of the following: 1) required fields are returned, 2) no added field allowed, 3) read-only and hidden field enforcement, 4) drop-down list and radio button field

conformance, and 5) form-field max-length enforcement. In some embodiments, the application firewall 290 ensures cookies are not modified. In other embodiments, the application firewall 290 protects against forceful browsing by enforcing legal URLs.

In still yet other embodiments, the application firewall 290 protects any confidential information contained in the network communication. The application firewall 290 may inspect or analyze any network communication in accordance with the rules or policies of the engine 236 to identify any confidential information in any field of the network packet. In some embodiments, the application firewall 290 identifies in the network communication one or more occurrences of a credit card number, password, social security number, name, patient code, contact information, and age. The encoded portion of the network communication may comprise these occurrences or the confidential information. Based on these occurrences, in one embodiment, the application firewall 290 may take a policy action on the network communication, such as prevent transmission of the network communication. In another embodiment, the application firewall 290 may rewrite, remove or otherwise mask such identified occurrence or confidential information.

Still referring to FIG. 2B, the appliance 200 may include a performance monitoring agent 197 as discussed above in conjunction with FIG. 1D. In one embodiment, the appliance 200 receives the monitoring agent 197 from the monitoring service 198 or monitoring server 106 as depicted in FIG. 1D. In some embodiments, the appliance 200 stores the monitoring agent 197 in storage, such as disk, for delivery to any client or server in communication with the appliance 200. For example, in one embodiment, the appliance 200 transmits the monitoring agent 197 to a client upon receiving a request to establish a transport layer connection. In other embodiments, the appliance 200 transmits the monitoring agent 197 upon establishing the transport layer connection with the client 102. In another embodiment, the appliance 200 transmits the monitoring agent 197 to the client upon intercepting or detecting a request for a web page. In yet another embodiment, the appliance 200 transmits the monitoring agent 197 to a client or a server in response to a request from the monitoring server 198. In one embodiment, the appliance 200 transmits the monitoring agent 197 to a second appliance 200' or appliance 205.

In other embodiments, the appliance 200 executes the monitoring agent 197. In one embodiment, the monitoring agent 197 measures and monitors the performance of any application, program, process, service, task or thread executing on the appliance 200. For example, the monitoring agent 197 may monitor and measure performance and operation of vServers 275A-275N. In another embodiment, the monitoring agent 197 measures and monitors the performance of any transport layer connections of the appliance 200. In some embodiments, the monitoring agent 197 measures and monitors the performance of any user sessions traversing the appliance 200. In one embodiment, the monitoring agent 197 measures and monitors the performance of any virtual private network connections and/or sessions traversing the appliance 200, such as an SSL VPN session. In still further embodiments, the monitoring agent 197 measures and monitors the memory, CPU and disk usage and performance of the appliance 200. In yet another embodiment, the monitoring agent 197 measures and monitors the performance of any acceleration technique 288 performed by the appliance 200, such as SSL offloading, connection pooling and multiplexing, caching, and compression. In some embodiments, the monitoring agent 197 measures and monitors the performance of any load balancing

and/or content switching 284 performed by the appliance 200. In other embodiments, the monitoring agent 197 measures and monitors the performance of application firewall 290 protection and processing performed by the appliance 200.

C. Client Agent

Referring now to FIG. 3, an embodiment of the client agent 120 is depicted. The client 102 includes a client agent 120 for establishing and exchanging communications with the appliance 200 and/or server 106 via a network 104. In brief overview, the client 102 operates on computing device 100 having an operating system with a kernel mode 302 and a user mode 303, and a network stack 310 with one or more layers 310a-310b. The client 102 may have installed and/or execute one or more applications. In some embodiments, one or more applications may communicate via the network stack 310 to a network 104. One of the applications, such as a web browser, may also include a first program 322. For example, the first program 322 may be used in some embodiments to install and/or execute the client agent 120, or any portion thereof. The client agent 120 includes an interception mechanism, or interceptor 350, for intercepting network communications from the network stack 310 from the one or more applications.

The network stack 310 of the client 102 may comprise any type and form of software, or hardware, or any combinations thereof, for providing connectivity to and communications with a network. In one embodiment, the network stack 310 comprises a software implementation for a network protocol suite. The network stack 310 may comprise one or more network layers, such as any networks layers of the Open Systems Interconnection (OSI) communications model as those skilled in the art recognize and appreciate. As such, the network stack 310 may comprise any type and form of protocols for any of the following layers of the OSI model: 1) physical link layer, 2) data link layer, 3) network layer, 4) transport layer, 5) session layer, 6) presentation layer, and 7) application layer. In one embodiment, the network stack 310 may comprise a transport control protocol (TCP) over the network layer protocol of the internet protocol (IP), generally referred to as TCP/IP. In some embodiments, the TCP/IP protocol may be carried over the Ethernet protocol, which may comprise any of the family of IEEE wide-area-network (WAN) or local-area-network (LAN) protocols, such as those protocols covered by the IEEE 802.3. In some embodiments, the network stack 310 comprises any type and form of a wireless protocol, such as IEEE 802.11 and/or mobile internet protocol.

In view of a TCP/IP based network, any TCP/IP based protocol may be used, including Messaging Application Programming Interface (MAPI) (email), File Transfer Protocol (FTP), HyperText Transfer Protocol (HTTP), Common Internet File System (CIFS) protocol (file transfer), Independent Computing Architecture (ICA) protocol, Remote Desktop Protocol (RDP), Wireless Application Protocol (WAP), Mobile IP protocol, and Voice Over IP (VoIP) protocol. In another embodiment, the network stack 310 comprises any type and form of transport control protocol, such as a modified transport control protocol, for example a Transaction TCP (T/TCP), TCP with selection acknowledgements (TCP-SACK), TCP with large windows (TCP-LW), a congestion prediction protocol such as the TCP-Vegas protocol, and a TCP spoofing protocol. In other embodiments, any type and form of user datagram protocol (UDP), such as UDP over IP, may be used by the network stack 310, such as for voice communications or real-time data communications.

Furthermore, the network stack **310** may include one or more network drivers supporting the one or more layers, such as a TCP driver or a network layer driver. The network drivers may be included as part of the operating system of the computing device **100** or as part of any network interface cards or other network access components of the computing device **100**. In some embodiments, any of the network drivers of the network stack **310** may be customized, modified or adapted to provide a custom or modified portion of the network stack **310** in support of any of the techniques described herein. In other embodiments, the acceleration program **302** is designed and constructed to operate with or work in conjunction with the network stack **310** installed or otherwise provided by the operating system of the client **102**.

The network stack **310** comprises any type and form of interfaces for receiving, obtaining, providing or otherwise accessing any information and data related to network communications of the client **102**. In one embodiment, an interface to the network stack **310** comprises an application programming interface (API). The interface may also comprise any function call, hooking or filtering mechanism, event or call back mechanism, or any type of interfacing technique. The network stack **310** via the interface may receive or provide any type and form of data structure, such as an object, related to functionality or operation of the network stack **310**. For example, the data structure may comprise information and data related to a network packet or one or more network packets. In some embodiments, the data structure comprises a portion of the network packet processed at a protocol layer of the network stack **310**, such as a network packet of the transport layer. In some embodiments, the data structure **325** comprises a kernel-level data structure, while in other embodiments, the data structure **325** comprises a user-mode data structure. A kernel-level data structure may comprise a data structure obtained or related to a portion of the network stack **310** operating in kernel-mode **302**, or a network driver or other software running in kernel-mode **302**, or any data structure obtained or received by a service, process, task, thread or other executable instructions running or operating in kernel-mode of the operating system.

Additionally, some portions of the network stack **310** may execute or operate in kernel-mode **302**, for example, the data link or network layer, while other portions execute or operate in user-mode **303**, such as an application layer of the network stack **310**. For example, a first portion **310a** of the network stack may provide user-mode access to the network stack **310** to an application while a second portion **310a** of the network stack **310** provides access to a network. In some embodiments, a first portion **310a** of the network stack may comprise one or more upper layers of the network stack **310**, such as any of layers 5-7. In other embodiments, a second portion **310b** of the network stack **310** comprises one or more lower layers, such as any of layers 1-4. Each of the first portion **310a** and second portion **310b** of the network stack **310** may comprise any portion of the network stack **310**, at any one or more network layers, in user-mode **203**, kernel-mode, **202**, or combinations thereof, or at any portion of a network layer or interface point to a network layer or any portion of or interface point to the user-mode **203** and kernel-mode **203**.

The interceptor **350** may comprise software, hardware, or any combination of software and hardware. In one embodiment, the interceptor **350** intercept a network communication at any point in the network stack **310**, and redirects or transmits the network communication to a destination desired, managed or controlled by the interceptor **350** or client agent **120**. For example, the interceptor **350** may intercept a network communication of a network stack **310** of a first network

and transmit the network communication to the appliance **200** for transmission on a second network **104**. In some embodiments, the interceptor **350** comprises any type interceptor **350** comprises a driver, such as a network driver constructed and designed to interface and work with the network stack **310**. In some embodiments, the client agent **120** and/or interceptor **350** operates at one or more layers of the network stack **310**, such as at the transport layer. In one embodiment, the interceptor **350** comprises a filter driver, hooking mechanism, or any form and type of suitable network driver interface that interfaces to the transport layer of the network stack, such as via the transport driver interface (TDI). In some embodiments, the interceptor **350** interfaces to a first protocol layer, such as the transport layer and another protocol layer, such as any layer above the transport protocol layer, for example, an application protocol layer. In one embodiment, the interceptor **350** may comprise a driver complying with the Network Driver Interface Specification (NDIS), or a NDIS driver. In another embodiment, the interceptor **350** may comprise a mini-filter or a mini-port driver. In one embodiment, the interceptor **350**, or portion thereof, operates in kernel-mode **202**. In another embodiment, the interceptor **350**, or portion thereof, operates in user-mode **203**. In some embodiments, a portion of the interceptor **350** operates in kernel-mode **202** while another portion of the interceptor **350** operates in user-mode **203**. In other embodiments, the client agent **120** operates in user-mode **203** but interfaces via the interceptor **350** to a kernel-mode driver, process, service, task or portion of the operating system, such as to obtain a kernel-level data structure **225**. In further embodiments, the interceptor **350** is a user-mode application or program, such as application.

In one embodiment, the interceptor **350** intercepts any transport layer connection requests. In these embodiments, the interceptor **350** execute transport layer application programming interface (API) calls to set the destination information, such as destination IP address and/or port to a desired location for the location. In this manner, the interceptor **350** intercepts and redirects the transport layer connection to a IP address and port controlled or managed by the interceptor **350** or client agent **120**. In one embodiment, the interceptor **350** sets the destination information for the connection to a local IP address and port of the client **102** on which the client agent **120** is listening. For example, the client agent **120** may comprise a proxy service listening on a local IP address and port for redirected transport layer communications. In some embodiments, the client agent **120** then communicates the redirected transport layer communication to the appliance **200**.

In some embodiments, the interceptor **350** intercepts a Domain Name Service (DNS) request. In one embodiment, the client agent **120** and/or interceptor **350** resolves the DNS request. In another embodiment, the interceptor transmits the intercepted DNS request to the appliance **200** for DNS resolution. In one embodiment, the appliance **200** resolves the DNS request and communicates the DNS response to the client agent **120**. In some embodiments, the appliance **200** resolves the DNS request via another appliance **200'** or a DNS server **106**.

In yet another embodiment, the client agent **120** may comprise two agents **120** and **120'**. In one embodiment, a first agent **120** may comprise an interceptor **350** operating at the network layer of the network stack **310**. In some embodiments, the first agent **120** intercepts network layer requests such as Internet Control Message Protocol (ICMP) requests (e.g., ping and traceroute). In other embodiments, the second agent **120'** may operate at the transport layer and intercept transport layer communications. In some embodiments, the

first agent **120** intercepts communications at one layer of the network stack **210** and interfaces with or communicates the intercepted communication to the second agent **120**'.

The client agent **120** and/or interceptor **350** may operate at or interface with a protocol layer in a manner transparent to any other protocol layer of the network stack **310**. For example, in one embodiment, the interceptor **350** operates or interfaces with the transport layer of the network stack **310** transparently to any protocol layer below the transport layer, such as the network layer, and any protocol layer above the transport layer, such as the session, presentation or application layer protocols. This allows the other protocol layers of the network stack **310** to operate as desired and without modification for using the interceptor **350**. As such, the client agent **120** and/or interceptor **350** can interface with the transport layer to secure, optimize, accelerate, route or load-balance any communications provided via any protocol carried by the transport layer, such as any application layer protocol over TCP/IP.

Furthermore, the client agent **120** and/or interceptor may operate at or interface with the network stack **310** in a manner transparent to any application, a user of the client **102**, and any other computing device, such as a server, in communications with the client **102**. The client agent **120** and/or interceptor **350** may be installed and/or executed on the client **102** in a manner without modification of an application. In some embodiments, the user of the client **102** or a computing device in communications with the client **102** are not aware of the existence, execution or operation of the client agent **120** and/or interceptor **350**. As such, in some embodiments, the client agent **120** and/or interceptor **350** is installed, executed, and/or operated transparently to an application, user of the client **102**, another computing device, such as a server, or any of the protocol layers above and/or below the protocol layer interfaced to by the interceptor **350**.

The client agent **120** includes an acceleration program **302**, a streaming client **306**, a collection agent **304**, and/or monitoring agent **197**. In one embodiment, the client agent **120** comprises an Independent Computing Architecture (ICA) client, or any portion thereof, developed by Citrix Systems, Inc. of Fort Lauderdale, Fla., and is also referred to as an ICA client. In some embodiments, the client **120** comprises an application streaming client **306** for streaming an application from a server **106** to a client **102**. In some embodiments, the client agent **120** comprises an acceleration program **302** for accelerating communications between client **102** and server **106**. In another embodiment, the client agent **120** includes a collection agent **304** for performing end-point detection/scanning and collecting end-point information for the appliance **200** and/or server **106**.

In some embodiments, the acceleration program **302** comprises a client-side acceleration program for performing one or more acceleration techniques to accelerate, enhance or otherwise improve a client's communications with and/or access to a server **106**, such as accessing an application provided by a server **106**. The logic, functions, and/or operations of the executable instructions of the acceleration program **302** may perform one or more of the following acceleration techniques: 1) multi-protocol compression, 2) transport control protocol pooling, 3) transport control protocol multiplexing, 4) transport control protocol buffering, and 5) caching via a cache manager. Additionally, the acceleration program **302** may perform encryption and/or decryption of any communications received and/or transmitted by the client **102**. In some embodiments, the acceleration program **302** performs one or more of the acceleration techniques in an integrated manner or fashion. Additionally, the acceleration program **302** can

perform compression on any of the protocols, or multiple-protocols, carried as a payload of a network packet of the transport layer protocol. The streaming client **306** comprises an application, program, process, service, task or executable instructions for receiving and executing a streamed application from a server **106**. A server **106** may stream one or more application data files to the streaming client **306** for playing, executing or otherwise causing to be executed the application on the client **102**. In some embodiments, the server **106** transmits a set of compressed or packaged application data files to the streaming client **306**. In some embodiments, the plurality of application files are compressed and stored on a file server within an archive file such as a CAB, ZIP, SIT, TAR, JAR or other archive. In one embodiment, the server **106** decompresses, unpackages or unarchives the application files and transmits the files to the client **102**. In another embodiment, the client **102** decompresses, unpackages or unarchives the application files. The streaming client **306** dynamically installs the application, or portion thereof, and executes the application. In one embodiment, the streaming client **306** may be an executable program. In some embodiments, the streaming client **306** may be able to launch another executable program.

The collection agent **304** comprises an application, program, process, service, task or executable instructions for identifying, obtaining and/or collecting information about the client **102**. In some embodiments, the appliance **200** transmits the collection agent **304** to the client **102** or client agent **120**. The collection agent **304** may be configured according to one or more policies of the policy engine **236** of the appliance. In other embodiments, the collection agent **304** transmits collected information on the client **102** to the appliance **200**. In one embodiment, the policy engine **236** of the appliance **200** uses the collected information to determine and provide access, authentication and authorization control of the client's connection to a network **104**.

In one embodiment, the collection agent **304** comprises an end-point detection and scanning mechanism, which identifies and determines one or more attributes or characteristics of the client. For example, the collection agent **304** may identify and determine any one or more of the following client-side attributes: 1) the operating system and/or a version of an operating system, 2) a service pack of the operating system, 3) a running service, 4) a running process, and 5) a file. The collection agent **304** may also identify and determine the presence or versions of any one or more of the following on the client: 1) antivirus software, 2) personal firewall software, 3) anti-spam software, and 4) internet security software. The policy engine **236** may have one or more policies based on any one or more of the attributes or characteristics of the client or client-side attributes.

In some embodiments, the client agent **120** includes a monitoring agent **197** as discussed in conjunction with FIGS. 1D and 2B. The monitoring agent **197** may be any type and form of script, such as Visual Basic or Java script. In one embodiment, the monitoring agent **197** monitors and measures performance of any portion of the client agent **120**. For example, in some embodiments, the monitoring agent **197** monitors and measures performance of the acceleration program **302**. In another embodiment, the monitoring agent **197** monitors and measures performance of the streaming client **306**. In other embodiments, the monitoring agent **197** monitors and measures performance of the collection agent **304**. In still another embodiment, the monitoring agent **197** monitors and measures performance of the interceptor **350**. In some

embodiments, the monitoring agent 197 monitors and measures any resource of the client 102, such as memory, CPU and disk.

The monitoring agent 197 may monitor and measure performance of any application of the client. In one embodiment, the monitoring agent 197 monitors and measures performance of a browser on the client 102. In some embodiments, the monitoring agent 197 monitors and measures performance of any application delivered via the client agent 120. In other embodiments, the monitoring agent 197 measures and monitors end user response times for an application, such as web-based or HTTP response times. The monitoring agent 197 may monitor and measure performance of an ICA or RDP client. In another embodiment, the monitoring agent 197 measures and monitors metrics for a user session or application session. In some embodiments, monitoring agent 197 measures and monitors an ICA or RDP session. In one embodiment, the monitoring agent 197 measures and monitors the performance of the appliance 200 in accelerating delivery of an application and/or data to the client 102.

In some embodiments and still referring to FIG. 3, a first program 322 may be used to install and/or execute the client agent 120, or portion thereof, such as the interceptor 350, automatically, silently, transparently, or otherwise. In one embodiment, the first program 322 comprises a plugin component, such as an ActiveX control or Java control or script that is loaded into and executed by an application. For example, the first program comprises an ActiveX control loaded and run by a web browser application, such as in the memory space or context of the application. In another embodiment, the first program 322 comprises a set of executable instructions loaded into and run by the application, such as a browser. In one embodiment, the first program 322 comprises a designed and constructed program to install the client agent 120. In some embodiments, the first program 322 obtains, downloads, or receives the client agent 120 via the network from another computing device. In another embodiment, the first program 322 is an installer program or a plug and play manager for installing programs, such as network drivers, on the operating system of the client 102.

D. Systems and Methods for Providing Virtualized Application Delivery Controller

Referring now to FIG. 4A, a block diagram depicts one embodiment of a virtualization environment 400. In brief overview, a computing device 100 includes a hypervisor layer, a virtualization layer, and a hardware layer. The hypervisor layer includes a hypervisor 401 (also referred to as a virtualization manager) that allocates and manages access to a number of physical resources in the hardware layer (e.g., the processor(s) 421, and disk(s) 428) by at least one virtual machine executing in the virtualization layer. The virtualization layer includes at least one operating system 410 and a plurality of virtual resources allocated to the at least one operating system 410. Virtual resources may include, without limitation, a plurality of virtual processors 432a, 432b, 432c (generally 432), and virtual disks 442a, 442b, 442c (generally 442), as well as virtual resources such as virtual memory and virtual network interfaces. The plurality of virtual resources and the operating system 410 may be referred to as a virtual machine 406. A virtual machine 406 may include a control operating system 405 in communication with the hypervisor 401 and used to execute applications for managing and configuring other virtual machines on the computing device 100.

In greater detail, a hypervisor 401 may provide virtual resources to an operating system in any manner which simulates the operating system having access to a physical device. A hypervisor 401 may provide virtual resources to any num-

ber of guest operating systems 410a, 410b (generally 410). In some embodiments, a computing device 100 executes one or more types of hypervisors. In these embodiments, hypervisors may be used to emulate virtual hardware, partition physical hardware, virtualize physical hardware, and execute virtual machines that provide access to computing environments. Hypervisors may include those manufactured by VMWare, Inc., of Palo Alto, Calif.; the XEN hypervisor, an open source product whose development is overseen by the open source Xen.org community; HyperV, VirtualServer or virtual PC hypervisors provided by Microsoft, or others. In some embodiments, a computing device 100 executing a hypervisor that creates a virtual machine platform on which guest operating systems may execute is referred to as a host server. In one of these embodiments, for example, the computing device 100 is a XEN SERVER provided by Citrix Systems, Inc., of Fort Lauderdale, Fla.

In some embodiments, a hypervisor 401 executes within an operating system executing on a computing device. In one of these embodiments, a computing device executing an operating system and a hypervisor 401 may be said to have a host operating system (the operating system executing on the computing device), and a guest operating system (an operating system executing within a computing resource partition provided by the hypervisor 401). In other embodiments, a hypervisor 401 interacts directly with hardware on a computing device, instead of executing on a host operating system. In one of these embodiments, the hypervisor 401 may be said to be executing on "bare metal," referring to the hardware comprising the computing device.

In some embodiments, a hypervisor 401 may create a virtual machine 406a-c (generally 406) in which an operating system 410 executes. In one of these embodiments, for example, the hypervisor 401 loads a virtual machine image to create a virtual machine 406. In another of these embodiments, the hypervisor 401 executes an operating system 410 within the virtual machine 406. In still another of these embodiments, the virtual machine 406 executes an operating system 410.

In some embodiments, the hypervisor 401 controls processor scheduling and memory partitioning for a virtual machine 406 executing on the computing device 100. In one of these embodiments, the hypervisor 401 controls the execution of at least one virtual machine 406. In another of these embodiments, the hypervisor 401 presents at least one virtual machine 406 with an abstraction of at least one hardware resource provided by the computing device 100. In other embodiments, the hypervisor 401 controls whether and how physical processor capabilities are presented to the virtual machine 406.

A control operating system 405 may execute at least one application for managing and configuring the guest operating systems. In one embodiment, the control operating system 405 may execute an administrative application, such as an application including a user interface providing administrators with access to functionality for managing the execution of a virtual machine, including functionality for executing a virtual machine, terminating an execution of a virtual machine, or identifying a type of physical resource for allocation to the virtual machine. In another embodiment, the hypervisor 401 executes the control operating system 405 within a virtual machine 406 created by the hypervisor 401. In still another embodiment, the control operating system 405 executes in a virtual machine 406 that is authorized to directly access physical resources on the computing device 100. In some embodiments, a control operating system 405a on a computing device 100a may exchange data with a control

operating system **405b** on a computing device **100b**, via communications between a hypervisor **401a** and a hypervisor **401b**. In this way, one or more computing devices **100** may exchange data with one or more of the other computing devices **100** regarding processors and other physical resources available in a pool of resources. In one of these embodiments, this functionality allows a hypervisor to manage a pool of resources distributed across a plurality of physical computing devices. In another of these embodiments, multiple hypervisors manage one or more of the guest operating systems executed on one of the computing devices **100**.

In one embodiment, the control operating system **405** executes in a virtual machine **406** that is authorized to interact with at least one guest operating system **410**. In another embodiment, a guest operating system **410** communicates with the control operating system **405** via the hypervisor **401** in order to request access to a disk or a network. In still another embodiment, the guest operating system **410** and the control operating system **405** may communicate via a communication channel established by the hypervisor **401**, such as, for example, via a plurality of shared memory pages made available by the hypervisor **401**.

In some embodiments, the control operating system **405** includes a network back-end driver for communicating directly with networking hardware provided by the computing device **100**. In one of these embodiments, the network back-end driver processes at least one virtual machine request from at least one guest operating system **110**. In other embodiments, the control operating system **405** includes a block back-end driver for communicating with a storage element on the computing device **100**. In one of these embodiments, the block back-end driver reads and writes data from the storage element based upon at least one request received from a guest operating system **410**.

In one embodiment, the control operating system **405** includes a tools stack **404**. In another embodiment, a tools stack **404** provides functionality for interacting with the hypervisor **401**, communicating with other control operating systems **405** (for example, on a second computing device **100b**), or managing virtual machines **406b**, **406c** on the computing device **100**. In another embodiment, the tools stack **404** includes customized applications for providing improved management functionality to an administrator of a virtual machine farm. In some embodiments, at least one of the tools stack **404** and the control operating system **405** include a management API that provides an interface for remotely configuring and controlling virtual machines **406** running on a computing device **100**. In other embodiments, the control operating system **405** communicates with the hypervisor **401** through the tools stack **404**.

In one embodiment, the hypervisor **401** executes a guest operating system **410** within a virtual machine **406** created by the hypervisor **401**. In another embodiment, the guest operating system **410** provides a user of the computing device **100** with access to resources within a computing environment. In still another embodiment, a resource includes a program, an application, a document, a file, a plurality of applications, a plurality of files, an executable program file, a desktop environment, a computing environment, or other resource made available to a user of the computing device **100**. In yet another embodiment, the resource may be delivered to the computing device **100** via a plurality of access methods including, but not limited to, conventional installation directly on the computing device **100**, delivery to the computing device **100** via a method for application streaming, delivery to the computing device **100** of output data generated by an execution of the resource on a second computing device **100'** and communi-

ated to the computing device **100** via a presentation layer protocol, delivery to the computing device **100** of output data generated by an execution of the resource via a virtual machine executing on a second computing device **100'**, or execution from a removable storage device connected to the computing device **100**, such as a USB device, or via a virtual machine executing on the computing device **100** and generating output data. In some embodiments, the computing device **100** transmits output data generated by the execution of the resource to another computing device **100'**.

In one embodiment, the guest operating system **410**, in conjunction with the virtual machine on which it executes, forms a fully-virtualized virtual machine which is not aware that it is a virtual machine; such a machine may be referred to as a “Domain U HVM (Hardware Virtual Machine) virtual machine”. In another embodiment, a fully-virtualized machine includes software emulating a Basic Input/Output System (BIOS) in order to execute an operating system within the fully-virtualized machine. In still another embodiment, a fully-virtualized machine may include a driver that provides functionality by communicating with the hypervisor **401**. In such an embodiment, the driver may be aware that it executes within a virtualized environment. In another embodiment, the guest operating system **410**, in conjunction with the virtual machine on which it executes, forms a paravirtualized virtual machine, which is aware that it is a virtual machine; such a machine may be referred to as a “Domain U PV virtual machine”. In another embodiment, a paravirtualized machine includes additional drivers that a fully-virtualized machine does not include. In still another embodiment, the paravirtualized machine includes the network back-end driver and the block back-end driver included in a control operating system **405**, as described above.

Referring now to FIG. 4B, a block diagram depicts one embodiment of a plurality of networked computing devices in a system in which at least one physical host executes a virtual machine. In brief overview, the system includes a management component **404** and a hypervisor **401**. The system includes a plurality of computing devices **100**, a plurality of virtual machines **406**, a plurality of hypervisors **401**, a plurality of management components referred to variously as tools stacks **404** or management components **404**, and a physical resource **421**, **428**. The plurality of physical machines **100** may each be provided as computing devices **100**, described above in connection with FIGS. 1E-1H and 4A.

In greater detail, a physical disk **428** is provided by a computing device **100** and stores at least a portion of a virtual disk **442**. In some embodiments, a virtual disk **442** is associated with a plurality of physical disks **428**. In one of these embodiments, one or more computing devices **100** may exchange data with one or more of the other computing devices **100** regarding processors and other physical resources available in a pool of resources, allowing a hypervisor to manage a pool of resources distributed across a plurality of physical computing devices. In some embodiments, a computing device **100** on which a virtual machine **406** executes is referred to as a physical host **100** or as a host machine **100**.

The hypervisor executes on a processor on the computing device **100**. The hypervisor allocates, to a virtual disk, an amount of access to the physical disk. In one embodiment, the hypervisor **401** allocates an amount of space on the physical disk. In another embodiment, the hypervisor **401** allocates a plurality of pages on the physical disk. In some embodiments, the hypervisor provisions the virtual disk **442** as part of a process of initializing and executing a virtual machine **450**.

In one embodiment, the management component **404a** is referred to as a pool management component **404a**. In another embodiment, a management operating system **405a**, which may be referred to as a control operating system **405a**, includes the management component. In some embodiments, the management component is referred to as a tools stack. In one of these embodiments, the management component is the tools stack **404** described above in connection with FIG. 4A. In other embodiments, the management component **404** provides a user interface for receiving, from a user such as an administrator, an identification of a virtual machine **406** to provision and/or execute. In still other embodiments, the management component **404** provides a user interface for receiving, from a user such as an administrator, the request for migration of a virtual machine **406b** from one physical machine **100** to another. In further embodiments, the management component **404a** identifies a computing device **100b** on which to execute a requested virtual machine **406d** and instructs the hypervisor **401b** on the identified computing device **100b** to execute the identified virtual machine; such a management component may be referred to as a pool management component.

Referring now to FIG. 4C, embodiments of a virtual application delivery controller or virtual appliance **450** are depicted. In brief overview, any of the functionality and/or embodiments of the appliance **200** (e.g., an application delivery controller) described above in connection with FIGS. 2A and 2B may be deployed in any embodiment of the virtualized environment described above in connection with FIGS. 4A and 4B. Instead of the functionality of the application delivery controller being deployed in the form of an appliance **200**, such functionality may be deployed in a virtualized environment **400** on any computing device **100**, such as a client **102**, server **106** or appliance **200**.

Referring now to FIG. 4C, a diagram of an embodiment of a virtual appliance **450** operating on a hypervisor **401** of a server **106** is depicted. As with the appliance **200** of FIGS. 2A and 2B, the virtual appliance **450** may provide functionality for availability, performance, offload and security. For availability, the virtual appliance may perform load balancing between layers 4 and 7 of the network and may also perform intelligent service health monitoring. For performance increases via network traffic acceleration, the virtual appliance may perform caching and compression. To offload processing of any servers, the virtual appliance may perform connection multiplexing and pooling and/or SSL processing. For security, the virtual appliance may perform any of the application firewall functionality and SSL VPN function of appliance **200**.

Any of the modules of the appliance **200** as described in connection with FIG. 2A may be packaged, combined, designed or constructed in a form of the virtualized appliance delivery controller **450** deployable as one or more software modules or components executable in a virtualized environment **300** or non-virtualized environment on any server, such as an off the shelf server. For example, the virtual appliance may be provided in the form of an installation package to install on a computing device. With reference to FIG. 2A, any of the cache manager **232**, policy engine **236**, compression **238**, encryption engine **234**, packet engine **240**, GUI **210**, CLI **212**, shell services **214** and health monitoring programs **216** may be designed and constructed as a software component or module to run on any operating system of a computing device and/or of a virtualized environment **300**. Instead of using the encryption processor **260**, processor **262**, memory **264** and network stack **267** of the appliance **200**, the virtualized appli-

ance **400** may use any of these resources as provided by the virtualized environment **400** or as otherwise available on the server **106**.

Still referring to FIG. 4C, and in brief overview, any one or more vServers **275A-275N** may be in operation or executed in a virtualized environment **400** of any type of computing device **100**, such as any server **106**. Any of the modules or functionality of the appliance **200** described in connection with FIG. 2B may be designed and constructed to operate in either a virtualized or non-virtualized environment of a server. Any of the vServer **275**, SSL VPN **280**, Intranet UP **282**, Switching **284**, DNS **286**, acceleration **288**, App FW **280** and monitoring agent may be packaged, combined, designed or constructed in a form of application delivery controller **450** deployable as one or more software modules or components executable on a device and/or virtualized environment **400**.

In some embodiments, a server may execute multiple virtual machines **406a-406n** in the virtualization environment with each virtual machine running the same or different embodiments of the virtual application delivery controller **450**. In some embodiments, the server may execute one or more virtual appliances **450** on one or more virtual machines on a core of a multi-core processing system. In some embodiments, the server may execute one or more virtual appliances **450** on one or more virtual machines on each processor of a multiple processor device.

E. Systems and Methods for Providing A Multi-Core Architecture

In accordance with Moore's Law, the number of transistors that may be placed on an integrated circuit may double approximately every two years. However, CPU speed increases may reach plateaus, for example CPU speed has been around 3.5-4 GHz range since 2005. In some cases, CPU manufacturers may not rely on CPU speed increases to gain additional performance. Some CPU manufacturers may add additional cores to their processors to provide additional performance. Products, such as those of software and networking vendors, that rely on CPUs for performance gains may improve their performance by leveraging these multi-core CPUs. The software designed and constructed for a single CPU may be redesigned and/or rewritten to take advantage of a multi-threaded, parallel architecture or otherwise a multi-core architecture.

A multi-core architecture of the appliance **200**, referred to as nCore or multi-core technology, allows the appliance in some embodiments to break the single core performance barrier and to leverage the power of multi-core CPUs. In the previous architecture described in connection with FIG. 2A, a single network or packet engine is run. The multiple cores of the nCore technology and architecture allow multiple packet engines to run concurrently and/or in parallel. With a packet engine running on each core, the appliance architecture leverages the processing capacity of additional cores. In some embodiments, this provides up to a 7x increase in performance and scalability.

Illustrated in FIG. 5A are some embodiments of work, task, load or network traffic distribution across one or more processor cores according to a type of parallelism or parallel computing scheme, such as functional parallelism, data parallelism or flow-based data parallelism. In brief overview, FIG. 5A illustrates embodiments of a multi-core system such as an appliance **200'** with n-cores, a total of cores numbers 1 through N. In one embodiment, work, load or network traffic can be distributed among a first core **505A**, a second core **505B**, a third core **505C**, a fourth core **505D**, a fifth core **505E**, a sixth core **505F**, a seventh core **505G**, and so on such that distribution is across all or two or more of the n cores **505N**

(hereinafter referred to collectively as cores **505**.) There may be multiple VIPs **275** each running on a respective core of the plurality of cores. There may be multiple packet engines **240** each running on a respective core of the plurality of cores. Any of the approaches used may lead to different, varying or similar work load or performance level **515** across any of the cores. For a functional parallelism approach, each core may run a different function of the functionalities provided by the packet engine, a VIP **275** or appliance **200**. In a data parallelism approach, data may be paralleled or distributed across the cores based on the Network Interface Card (NIC) or VIP **275** receiving the data. In another data parallelism approach, processing may be distributed across the cores by distributing data flows to each core.

In further detail to FIG. **5A**, in some embodiments, load, work or network traffic can be distributed among cores **505** according to functional parallelism **500**. Functional parallelism may be based on each core performing one or more respective functions. In some embodiments, a first core may perform a first function while a second core performs a second function. In functional parallelism approach, the functions to be performed by the multi-core system are divided and distributed to each core according to functionality. In some embodiments, functional parallelism may be referred to as task parallelism and may be achieved when each processor or core executes a different process or function on the same or different data. The core or processor may execute the same or different code. In some cases, different execution threads or code may communicate with one another as they work. Communication may take place to pass data from one thread to the next as part of a workflow.

In some embodiments, distributing work across the cores **505** according to functional parallelism **500**, can comprise distributing network traffic according to a particular function such as network input/output management (NW I/O) **510A**, secure sockets layer (SSL) encryption and decryption **510B** and transmission control protocol (TCP) functions **510C**. This may lead to a work, performance or computing load **515** based on a volume or level of functionality being used. In some embodiments, distributing work across the cores **505** according to data parallelism **540**, can comprise distributing an amount of work **515** based on distributing data associated with a particular hardware or software component. In some embodiments, distributing work across the cores **505** according to flow-based data parallelism **520**, can comprise distributing data based on a context or flow such that the amount of work **515A-N** on each core may be similar, substantially equal or relatively evenly distributed.

In the case of the functional parallelism approach, each core may be configured to run one or more functionalities of the plurality of functionalities provided by the packet engine or VIP of the appliance. For example, core **1** may perform network I/O processing for the appliance **200'** while core **2** performs TCP connection management for the appliance. Likewise, core **3** may perform SSL offloading while core **4** may perform layer 7 or application layer processing and traffic management. Each of the cores may perform the same function or different functions. Each of the cores may perform more than one function. Any of the cores may run any of the functionality or portions thereof identified and/or described in conjunction with FIGS. **2A** and **2B**. In this the approach, the work across the cores may be divided by function in either a coarse-grained or fine-grained manner. In some cases, as illustrated in FIG. **5A**, division by function may lead to different cores running at different levels of performance or load **515**.

In the case of the functional parallelism approach, each core may be configured to run one or more functionalities of the plurality of functionalities provided by the packet engine of the appliance. For example, core **1** may perform network I/O processing for the appliance **200'** while core **2** performs TCP connection management for the appliance. Likewise, core **3** may perform SSL offloading while core **4** may perform layer 7 or application layer processing and traffic management. Each of the cores may perform the same function or different functions. Each of the cores may perform more than one function. Any of the cores may run any of the functionality or portions thereof identified and/or described in conjunction with FIGS. **2A** and **2B**. In this the approach, the work across the cores may be divided by function in either a coarse-grained or fine-grained manner. In some cases, as illustrated in FIG. **5A** division by function may lead to different cores running at different levels of load or performance.

The functionality or tasks may be distributed in any arrangement and scheme. For example, FIG. **5B** illustrates a first core, Core **1 505A**, processing applications and processes associated with network I/O functionality **510A**. Network traffic associated with network I/O, in some embodiments, can be associated with a particular port number. Thus, outgoing and incoming packets having a port destination associated with NW I/O **510A** will be directed towards Core **1 505A** which is dedicated to handling all network traffic associated with the NW I/O port. Similarly, Core **2 505B** is dedicated to handling functionality associated with SSL processing and Core **4 505D** may be dedicated handling all TCP level processing and functionality.

While FIG. **5A** illustrates functions such as network I/O, SSL and TCP, other functions can be assigned to cores. These other functions can include any one or more of the functions or operations described herein. For example, any of the functions described in conjunction with FIGS. **2A** and **2B** may be distributed across the cores on a functionality basis. In some cases, a first VIP **275A** may run on a first core while a second VIP **275B** with a different configuration may run on a second core. In some embodiments, each core **505** can handle a particular functionality such that each core **505** can handle the processing associated with that particular function. For example, Core **2 505B** may handle SSL offloading while Core **4 505D** may handle application layer processing and traffic management.

In other embodiments, work, load or network traffic may be distributed among cores **505** according to any type and form of data parallelism **540**. In some embodiments, data parallelism may be achieved in a multi-core system by each core performing the same task or functionally on different pieces of distributed data. In some embodiments, a single execution thread or code controls operations on all pieces of data. In other embodiments, different threads or instructions control the operation, but may execute the same code. In some embodiments, data parallelism is achieved from the perspective of a packet engine, vServers (VIPs) **275A-C**, network interface cards (NIC) **542D-E** and/or any other networking hardware or software included on or associated with an appliance **200**. For example, each core may run the same packet engine or VIP code or configuration but operate on different sets of distributed data. Each networking hardware or software construct can receive different, varying or substantially the same amount of data, and as a result may have varying, different or relatively the same amount of load **515**.

In the case of a data parallelism approach, the work may be divided up and distributed based on VIPs, NICs and/or data flows of the VIPs or NICs. In one of these approaches, the work of the multi-core system may be divided or distributed

among the VIPs by having each VIP work on a distributed set of data. For example, each core may be configured to run one or more VIPs. Network traffic may be distributed to the core for each VIP handling that traffic. In another of these approaches, the work of the appliance may be divided or distributed among the cores based on which NIC receives the network traffic. For example, network traffic of a first NIC may be distributed to a first core while network traffic of a second NIC may be distributed to a second core. In some cases, a core may process data from multiple NICs.

While FIG. 5A illustrates a single vServer associated with a single core 505, as is the case for VIP1 275A, VIP2 275B and VIP3 275C. In some embodiments, a single vServer can be associated with one or more cores 505. In contrast, one or more vServers can be associated with a single core 505. Associating a vServer with a core 505 may include that core 505 to process all functions associated with that particular vServer. In some embodiments, each core executes a VIP having the same code and configuration. In other embodiments, each core executes a VIP having the same code but different configuration. In some embodiments, each core executes a VIP having different code and the same or different configuration.

Like vServers, NICs can also be associated with particular cores 505. In many embodiments, NICs can be connected to one or more cores 505 such that when a NIC receives or transmits data packets, a particular core 505 handles the processing involved with receiving and transmitting the data packets. In one embodiment, a single NIC can be associated with a single core 505, as is the case with NIC1 542D and NIC2 542E. In other embodiments, one or more NICs can be associated with a single core 505. In other embodiments, a single NIC can be associated with one or more cores 505. In these embodiments, load could be distributed amongst the one or more cores 505 such that each core 505 processes a substantially similar amount of load. A core 505 associated with a NIC may process all functions and/or data associated with that particular NIC.

While distributing work across cores based on data of VIPs or NICs may have a level of independency, in some embodiments, this may lead to unbalanced use of cores as illustrated by the varying loads 515 of FIG. 5A.

In some embodiments, load, work or network traffic can be distributed among cores 505 based on any type and form of data flow. In another of these approaches, the work may be divided or distributed among cores based on data flows. For example, network traffic between a client and a server traversing the appliance may be distributed to and processed by one core of the plurality of cores. In some cases, the core initially establishing the session or connection may be the core for which network traffic for that session or connection is distributed. In some embodiments, the data flow is based on any unit or portion of network traffic, such as a transaction, a request/response communication or traffic originating from an application on a client. In this manner and in some embodiments, data flows between clients and servers traversing the appliance 200' may be distributed in a more balanced manner than the other approaches.

In flow-based data parallelism 520, distribution of data is related to any type of flow of data, such as request/response pairings, transactions, sessions, connections or application communications. For example, network traffic between a client and a server traversing the appliance may be distributed to and processed by one core of the plurality of cores. In some cases, the core initially establishing the session or connection may be the core for which network traffic for that session or connection is distributed. The distribution of data flow may be

such that each core 505 carries a substantially equal or relatively evenly distributed amount of load, data or network traffic.

In some embodiments, the data flow is based on any unit or portion of network traffic, such as a transaction, a request/response communication or traffic originating from an application on a client. In this manner and in some embodiments, data flows between clients and servers traversing the appliance 200' may be distributed in a more balanced manner than the other approached. In one embodiment, data flow can be distributed based on a transaction or a series of transactions. This transaction, in some embodiments, can be between a client and a server and can be characterized by an IP address or other packet identifier. For example, Core 1 505A can be dedicated to transactions between a particular client and a particular server, therefore the load 515A on Core 1 505A may be comprised of the network traffic associated with the transactions between the particular client and server. Allocating the network traffic to Core 1 505A can be accomplished by routing all data packets originating from either the particular client or server to Core 1 505A.

While work or load can be distributed to the cores based in part on transactions, in other embodiments load or work can be allocated on a per packet basis. In these embodiments, the appliance 200 can intercept data packets and allocate them to a core 505 having the least amount of load. For example, the appliance 200 could allocate a first incoming data packet to Core 1 505A because the load 515A on Core 1 is less than the load 515B-N on the rest of the cores 505B-N. Once the first data packet is allocated to Core 1 505A, the amount of load 515A on Core 1 505A is increased proportional to the amount of processing resources needed to process the first data packet. When the appliance 200 intercepts a second data packet, the appliance 200 will allocate the load to Core 4 505D because Core 4 505D has the second least amount of load. Allocating data packets to the core with the least amount of load can, in some embodiments, ensure that the load 515A-N distributed to each core 505 remains substantially equal.

In other embodiments, load can be allocated on a per unit basis where a section of network traffic is allocated to a particular core 505. The above-mentioned example illustrates load balancing on a per/packet basis. In other embodiments, load can be allocated based on a number of packets such that every 10, 100 or 1000 packets are allocated to the core 505 having the least amount of load. The number of packets allocated to a core 505 can be a number determined by an application, user or administrator and can be any number greater than zero. In still other embodiments, load can be allocated based on a time metric such that packets are distributed to a particular core 505 for a predetermined amount of time. In these embodiments, packets can be distributed to a particular core 505 for five milliseconds or for any period of time determined by a user, program, system, administrator or otherwise. After the predetermined time period elapses, data packets are transmitted to a different core 505 for the predetermined period of time.

Flow-based data parallelism methods for distributing work, load or network traffic among the one or more cores 505 can comprise any combination of the above-mentioned embodiments. These methods can be carried out by any part of the appliance 200, by an application or set of executable instructions executing on one of the cores 505, such as the packet engine, or by any application, program or agent executing on a computing device in communication with the appliance 200.

The functional and data parallelism computing schemes illustrated in FIG. 5A can be combined in any manner to generate a hybrid parallelism or distributed processing scheme that encompasses function parallelism 500, data parallelism 540, flow-based data parallelism 520 or any portions thereof. In some cases, the multi-core system may use any type and form of load balancing schemes to distribute load among the one or more cores 505. The load balancing scheme may be used in any combination with any of the functional and data parallelism schemes or combinations thereof.

Illustrated in FIG. 5B is an embodiment of a multi-core system 545, which may be any type and form of one or more systems, appliances, devices or components. This system 545, in some embodiments, can be included within an appliance 200 having one or more processing cores 505A-N. The system 545 can further include one or more packet engines (PE) or packet processing engines (PPE) 548A-N communicating with a memory bus 556. The memory bus may be used to communicate with the one or more processing cores 505A-N. Also included within the system 545 can be one or more network interface cards (NIC) 552 and a flow distributor 550 which can further communicate with the one or more processing cores 505A-N. The flow distributor 550 can comprise a Receive Side Scaler (RSS) or Receive Side Scaling (RSS) module 560.

Further referring to FIG. 5B, and in more detail, in one embodiment the packet engine(s) 548A-N can comprise any portion of the appliance 200 described herein, such as any portion of the appliance described in FIGS. 2A and 2B. The packet engine(s) 548A-N can, in some embodiments, comprise any of the following elements: the packet engine 240, a network stack 267; a cache manager 232; a policy engine 236; a compression engine 238; an encryption engine 234; a GUI 210; a CLI 212; shell services 214; monitoring programs 216; and any other software or hardware element able to receive data packets from one of either the memory bus 556 or the one of more cores 505A-N. In some embodiments, the packet engine(s) 548A-N can comprise one or more vServers 275A-N, or any portion thereof. In other embodiments, the packet engine(s) 548A-N can provide any combination of the following functionalities: SSL VPN 280; Intranet UP 282; switching 284; DNS 286; packet acceleration 288; App FW 280; monitoring such as the monitoring provided by a monitoring agent 197; functionalities associated with functioning as a TCP stack; load balancing; SSL offloading and processing; content switching; policy evaluation; caching; compression; encoding; decompression; decoding; application firewall functionalities; XML processing and acceleration; and SSL VPN connectivity.

The packet engine(s) 548A-N can, in some embodiments, be associated with a particular server, user, client or network. When a packet engine 548 becomes associated with a particular entity, that packet engine 548 can process data packets associated with that entity. For example, should a packet engine 548 be associated with a first user, that packet engine 548 will process and operate on packets generated by the first user, or packets having a destination address associated with the first user. Similarly, the packet engine 548 may choose not to be associated with a particular entity such that the packet engine 548 can process and otherwise operate on any data packets not generated by that entity or destined for that entity.

In some instances, the packet engine(s) 548A-N can be configured to carry out the any of the functional and/or data parallelism schemes illustrated in FIG. 5A. In these instances, the packet engine(s) 548A-N can distribute functions or data among the processing cores 505A-N so that the distribution is according to the parallelism or distribution scheme. In some

embodiments, a single packet engine(s) 548A-N carries out a load balancing scheme, while in other embodiments one or more packet engine(s) 548A-N carry out a load balancing scheme. Each core 505A-N, in one embodiment, can be associated with a particular packet engine 548 such that load balancing can be carried out by the packet engine. Load balancing may in this embodiment, require that each packet engine 548A-N associated with a core 505 communicate with the other packet engines associated with cores so that the packet engines 548A-N can collectively determine where to distribute load. One embodiment of this process can include an arbiter that receives votes from each packet engine for load. The arbiter can distribute load to each packet engine 548A-N based in part on the age of the engine's vote and in some cases a priority value associated with the current amount of load on an engine's associated core 505.

Any of the packet engines running on the cores may run in user mode, kernel or any combination thereof. In some embodiments, the packet engine operates as an application or program running in user or application space. In these embodiments, the packet engine may use any type and form of interface to access any functionality provided by the kernel. In some embodiments, the packet engine operates in kernel mode or as part of the kernel. In some embodiments, a first portion of the packet engine operates in user mode while a second portion of the packet engine operates in kernel mode. In some embodiments, a first packet engine on a first core executes in kernel mode while a second packet engine on a second core executes in user mode. In some embodiments, the packet engine or any portions thereof operates on or in conjunction with the NIC or any drivers thereof.

In some embodiments, the memory bus 556 can be any type and form of memory or computer bus. While a single memory bus 556 is depicted in FIG. 5B, the system 545 can comprise any number of memory buses 556. In one embodiment, each packet engine 548 can be associated with one or more individual memory buses 556.

The NIC 552 can in some embodiments be any of the network interface cards or mechanisms described herein. The NIC 552 can have any number of ports. The NIC can be designed and constructed to connect to any type and form of network 104. While a single NIC 552 is illustrated, the system 545 can comprise any number of NICs 552. In some embodiments, each core 505A-N can be associated with one or more single NICs 552. Thus, each core 505 can be associated with a single NIC 552 dedicated to a particular core 505.

The cores 505A-N can comprise any of the processors described herein. Further, the cores 505A-N can be configured according to any of the core 505 configurations described herein. Still further, the cores 505A-N can have any of the core 505 functionalities described herein. While FIG. 5B illustrates seven cores 505A-G, any number of cores 505 can be included within the system 545. In particular, the system 545 can comprise "N" cores, where "N" is a whole number greater than zero.

A core may have or use memory that is allocated or assigned for use to that core. The memory may be considered private or local memory of that core and only accessible by that core. A core may have or use memory that is shared or assigned to multiple cores. The memory may be considered public or shared memory that is accessible by more than one core. A core may use any combination of private and public memory. With separate address spaces for each core, some level of coordination is eliminated from the case of using the same address space. With a separate address space, a core can perform work on information and data in the core's own address space without worrying about conflicts with other

cores. Each packet engine may have a separate memory pool for TCP and/or SSL connections.

Further referring to FIG. 5B, any of the functionality and/or embodiments of the cores 505 described above in connection with FIG. 5A can be deployed in any embodiment of the virtualized environment described above in connection with FIGS. 4A and 4B. Instead of the functionality of the cores 505 being deployed in the form of a physical processor 505, such functionality may be deployed in a virtualized environment 400 on any computing device 100, such as a client 102, server 106 or appliance 200. In other embodiments, instead of the functionality of the cores 505 being deployed in the form of an appliance or a single device, the functionality may be deployed across multiple devices in any arrangement. For example, one device may comprise two or more cores and another device may comprise two or more cores. For example, a multi-core system may include a cluster of computing devices, a server farm or network of computing devices. In some embodiments, instead of the functionality of the cores 505 being deployed in the form of cores, the functionality may be deployed on a plurality of processors, such as a plurality of single core processors.

In one embodiment, the cores 505 may be any type and form of processor. In some embodiments, a core can function substantially similar to any processor or central processing unit described herein. In some embodiment, the cores 505 may comprise any portion of any processor described herein. While FIG. 5A illustrates seven cores, there can exist any "N" number of cores within an appliance 200, where "N" is any whole number greater than one. In some embodiments, the cores 505 can be installed within a common appliance 200, while in other embodiments the cores 505 can be installed within one or more appliance(s) 200 communicatively connected to one another. The cores 505 can in some embodiments comprise graphics processing software, while in other embodiments the cores 505 provide general processing capabilities. The cores 505 can be installed physically near each other and/or can be communicatively connected to each other. The cores may be connected by any type and form of bus or subsystem physically and/or communicatively coupled to the cores for transferring data between to, from and/or between the cores.

While each core 505 can comprise software for communicating with other cores, in some embodiments a core manager (not shown) can facilitate communication between each core 505. In some embodiments, the kernel may provide core management. The cores may interface or communicate with each other using a variety of interface mechanisms. In some embodiments, core to core messaging may be used to communicate between cores, such as a first core sending a message or data to a second core via a bus or subsystem connecting the cores. In some embodiments, cores may communicate via any type and form of shared memory interface. In one embodiment, there may be one or more memory locations shared among all the cores. In some embodiments, each core may have separate memory locations shared with each other core. For example, a first core may have a first shared memory with a second core and a second share memory with a third core. In some embodiments, cores may communicate via any type of programming or API, such as function calls via the kernel. In some embodiments, the operating system may recognize and support multiple core devices and provide interfaces and API for inter-core communications.

The flow distributor 550 can be any application, program, library, script, task, service, process or any type and form of executable instructions executing on any type and form of hardware. In some embodiments, the flow distributor 550

may any design and construction of circuitry to perform any of the operations and functions described herein. In some embodiments, the flow distributor distribute, forwards, routes, controls and/or manage the distribution of data packets among the cores 505 and/or packet engine or VIPs running on the cores. The flow distributor 550, in some embodiments, can be referred to as an interface master. In one embodiment, the flow distributor 550 comprises a set of executable instructions executing on a core or processor of the appliance 200. In another embodiment, the flow distributor 550 comprises a set of executable instructions executing on a computing machine in communication with the appliance 200. In some embodiments, the flow distributor 550 comprises a set of executable instructions executing on a NIC, such as firmware. In still other embodiments, the flow distributor 550 comprises any combination of software and hardware to distribute data packets among cores or processors. In one embodiment, the flow distributor 550 executes on at least one of the cores 505A-N, while in other embodiments a separate flow distributor 550 assigned to each core 505A-N executes on an associated core 505A-N. The flow distributor may use any type and form of statistical or probabilistic algorithms or decision making to balance the flows across the cores. The hardware of the appliance, such as a NIC, or the kernel may be designed and constructed to support sequential operations across the NICs and/or cores.

In embodiments where the system 545 comprises one or more flow distributors 550, each flow distributor 550 can be associated with a processor 505 or a packet engine 548. The flow distributors 550 can comprise an interface mechanism that allows each flow distributor 550 to communicate with the other flow distributors 550 executing within the system 545. In one instance, the one or more flow distributors 550 can determine how to balance load by communicating with each other. This process can operate substantially similarly to the process described above for submitting votes to an arbiter which then determines which flow distributor 550 should receive the load. In other embodiments, a first flow distributor 550' can identify the load on an associated core and determine whether to forward a first data packet to the associated core based on any of the following criteria: the load on the associated core is above a predetermined threshold; the load on the associated core is below a predetermined threshold; the load on the associated core is less than the load on the other cores; or any other metric that can be used to determine where to forward data packets based in part on the amount of load on a processor.

The flow distributor 550 can distribute network traffic among the cores 505 according to a distribution, computing or load balancing scheme such as those described herein. In one embodiment, the flow distributor can distribute network traffic according to any one of a functional parallelism distribution scheme 550, a data parallelism load distribution scheme 540, a flow-based data parallelism distribution scheme 520, or any combination of these distribution scheme or any load balancing scheme for distributing load among multiple processors. The flow distributor 550 can therefore act as a load distributor by taking in data packets and distributing them across the processors according to an operative load balancing or distribution scheme. In one embodiment, the flow distributor 550 can comprise one or more operations, functions or logic to determine how to distribute packers, work or load accordingly. In still other embodiments, the flow distributor 550 can comprise one or more sub operations, functions or logic that can identify a source address and a destination address associated with a data packet, and distribute packets accordingly.

In some embodiments, the flow distributor **550** can comprise a receive-side scaling (RSS) network driver, module **560** or any type and form of executable instructions which distribute data packets among the one or more cores **505**. The RSS module **560** can comprise any combination of hardware and software. In some embodiments, the RSS module **560** works in conjunction with the flow distributor **550** to distribute data packets across the cores **505A-N** or among multiple processors in a multi-processor network. The RSS module **560** can execute within the NIC **552** in some embodiments, and in other embodiments can execute on any one of the cores **505**.

In some embodiments, the RSS module **560** uses the MICROSOFT receive-side-scaling (RSS) scheme. In one embodiment, RSS is a Microsoft Scalable Networking initiative technology that enables receive processing to be balanced across multiple processors in the system while maintaining in-order delivery of the data. The RSS may use any type and form of hashing scheme to determine a core or processor for processing a network packet.

The RSS module **560** can apply any type and form hash function such as the Toeplitz hash function. The hash function may be applied to the hash type or any the sequence of values. The hash function may be a secure hash of any security level or is otherwise cryptographically secure. The hash function may use a hash key. The size of the key is dependent upon the hash function. For the Toeplitz hash, the size may be 40 bytes for IPv6 and 16 bytes for IPv4.

The hash function may be designed and constructed based on any one or more criteria or design goals. In some embodiments, a hash function may be used that provides an even distribution of hash result for different hash inputs and different hash types, including TCP/IPv4, TCP/IPv6, IPv4, and IPv6 headers. In some embodiments, a hash function may be used that provides a hash result that is evenly distributed when a small number of buckets are present (for example, two or four). In some embodiments, hash function may be used that provides a hash result that is randomly distributed when a large number of buckets were present (for example, 64 buckets). In some embodiments, the hash function is determined based on a level of computational or resource usage. In some embodiments, the hash function is determined based on ease or difficulty of implementing the hash in hardware. In some embodiments, the hash function is determined based on the ease or difficulty of a malicious remote host to send packets that would all hash to the same bucket.

The RSS may generate hashes from any type and form of input, such as a sequence of values. This sequence of values can include any portion of the network packet, such as any header, field or payload of network packet, or portions thereof. In some embodiments, the input to the hash may be referred to as a hash type and include any tuples of information associated with a network packet or data flow, such as any of the following: a four tuple comprising at least two IP addresses and two ports; a four tuple comprising any four sets of values; a six tuple; a two tuple; and/or any other sequence of numbers or values. The following are example of hash types that may be used by RSS:

4-tuple of source TCP Port, source IP version 4 (IPv4) address, destination TCP Port, and destination IPv4 address.

4-tuple of source TCP Port, source IP version 6 (IPv6) address, destination TCP Port, and destination IPv6 address.

2-tuple of source IPv4 address, and destination IPv4 address.

2-tuple of source IPv6 address, and destination IPv6 address.

2-tuple of source IPv6 address, and destination IPv6 address, including support for parsing IPv6 extension headers.

The hash result or any portion thereof may used to identify a core or entity, such as a packet engine or VIP, for distributing a network packet. In some embodiments, one or more hash bits or mask are applied to the hash result. The hash bit or mask may be any number of bits or bytes. A NIC may support any number of bits, such as seven bits. The network stack may set the actual number of bits to be used during initialization. The number will be between 1 and 7, inclusive.

The hash result may be used to identify the core or entity via any type and form of table, such as a bucket table or indirection table. In some embodiments, the number of hash-result bits are used to index into the table. The range of the hash mask may effectively define the size of the indirection table. ny portion of the hash result or the hast result itself may be used to index the indirection table. The values in the table may identify any of the cores or processor, such as by a core or processor identifier. In some embodiments, all of the cores of the multi-core system are identified in the table. In other embodiments, a port of the cores of the multi-core system are identified in the table. The indirection table may comprise any number of buckets for example 2 to 128 buckets that may be indexed by a hash mask. Each bucket may comprise a range of index values that identify a core or processor. In some embodiments, the flow controller and/or RSS module may rebalance the network rebalance the network load by changing the indirection table.

In some embodiments, the multi-core system **575** does not include a RSS driver or RSS module **560**. In some of these embodiments, a software steering module (not shown) or a software embodiment of the RSS module within the system can operate in conjunction with or as part of the flow distributor **550** to steer packets to cores **505** within the multi-core system **575**.

The flow distributor **550**, in some embodiments, executes within any module or program on the appliance **200**, on any one of the cores **505** and on any one of the devices or components included within the multi-core system **575**. In some embodiments, the flow distributor **550'** can execute on the first core **505A**, while in other embodiments the flow distributor **550''** can execute on the NIC **552**. In still other embodiments, an instance of the flow distributor **550'** can execute on each core **505** included in the multi-core system **575**. In this embodiment, each instance of the flow distributor **550'** can communicate with other instances of the flow distributor **550'** to forward packets back and forth across the cores **505**. There exist situations where a response to a request packet may not be processed by the same core, i.e. the first core processes the request while the second core processes the response. In these situations, the instances of the flow distributor **550'** can intercept the packet and forward it to the desired or correct core **505**, i.e. a flow distributor instance **550'** can forward the response to the first core. Multiple instances of the flow distributor **550'** can execute on any number of cores **505** and any combination of cores **505**.

The flow distributor may operate responsive to any one or more rules or policies. The rules may identify a core or packet processing engine to receive a network packet, data or data flow. The rules may identify any type and form of tuple information related to a network packet, such as a 4-tuple of source and destination IP address and source and destination ports. Based on a received packet matching the tuple specified by the rule, the flow distributor may forward the packet to a

core or packet engine. In some embodiments, the packet is forwarded to a core via shared memory and/or core to core messaging.

Although FIG. 5B illustrates the flow distributor 550 as executing within the multi-core system 575, in some embodiments the flow distributor 550 can execute on a computing device or appliance remotely located from the multi-core system 575. In such an embodiment, the flow distributor 550 can communicate with the multi-core system 575 to take in data packets and distribute the packets across the one or more cores 505. The flow distributor 550 can, in one embodiment, receive data packets destined for the appliance 200, apply a distribution scheme to the received data packets and distribute the data packets to the one or more cores 505 of the multi-core system 575. In one embodiment, the flow distributor 550 can be included in a router or other appliance such that the router can target particular cores 505 by altering meta data associated with each packet so that each packet is targeted towards a sub-node of the multi-core system 575. In such an embodiment, CISCO's vn-tag mechanism can be used to alter or tag each packet with the appropriate meta data.

Illustrated in FIG. 5C is an embodiment of a multi-core system 575 comprising one or more processing cores 505A-N. In brief overview, one of the cores 505 can be designated as a control core 505A and can be used as a control plane 570 for the other cores 505. The other cores may be secondary cores which operate in a data plane while the control core provides the control plane. The cores 505A-N may share a global cache 580. While the control core provides a control plane, the other cores in the multi-core system form or provide a data plane. These cores perform data processing functionality on network traffic while the control provides initialization, configuration and control of the multi-core system.

Further referring to FIG. 5C, and in more detail, the cores 505A-N as well as the control core 505A can be any processor described herein. Furthermore, the cores 505A-N and the control core 505A can be any processor able to function within the system 575 described in FIG. 5C. Still further, the cores 505A-N and the control core 505A can be any core or group of cores described herein. The control core may be a different type of core or processor than the other cores. In some embodiments, the control may operate a different packet engine or have a packet engine configured differently than the packet engines of the other cores.

Any portion of the memory of each of the cores may be allocated to or used for a global cache that is shared by the cores. In brief overview, a predetermined percentage or predetermined amount of each of the memory of each core may be used for the global cache. For example, 50% of each memory of each core may be dedicated or allocated to the shared global cache. That is, in the illustrated embodiment, 2 GB of each core excluding the control plane core or core 1 may be used to form a 28 GB shared global cache. The configuration of the control plane such as via the configuration services may determine the amount of memory used for the shared global cache. In some embodiments, each core may provide a different amount of memory for use by the global cache. In other embodiments, any one core may not provide any memory or use the global cache. In some embodiments, any of the cores may also have a local cache in memory not allocated to the global shared memory. Each of the cores may store any portion of network traffic to the global shared cache. Each of the cores may check the cache for any content to use in a request or response. Any of the cores may obtain content from the global shared cache to use in a data flow, request or response.

The global cache 580 can be any type and form of memory or storage element, such as any memory or storage element described herein. In some embodiments, the cores 505 may have access to a predetermined amount of memory (i.e. 32 GB or any other memory amount commensurate with the system 575). The global cache 580 can be allocated from that predetermined amount of memory while the rest of the available memory can be allocated among the cores 505. In other embodiments, each core 505 can have a predetermined amount of memory. The global cache 580 can comprise an amount of the memory allocated to each core 505. This memory amount can be measured in bytes, or can be measured as a percentage of the memory allocated to each core 505. Thus, the global cache 580 can comprise 1 GB of memory from the memory associated with each core 505, or can comprise 20 percent or one-half of the memory associated with each core 505. In some embodiments, only a portion of the cores 505 provide memory to the global cache 580, while in other embodiments the global cache 580 can comprise memory not allocated to the cores 505.

Each core 505 can use the global cache 580 to store network traffic or cache data. In some embodiments, the packet engines of the core use the global cache to cache and use data stored by the plurality of packet engines. For example, the cache manager of FIG. 2A and cache functionality of FIG. 2B may use the global cache to share data for acceleration. For example, each of the packet engines may store responses, such as HTML data, to the global cache. Any of the cache managers operating on a core may access the global cache to server caches responses to client requests.

In some embodiments, the cores 505 can use the global cache 580 to store a port allocation table which can be used to determine data flow based in part on ports. In other embodiments, the cores 505 can use the global cache 580 to store an address lookup table or any other table or list that can be used by the flow distributor to determine where to direct incoming and outgoing data packets. The cores 505 can, in some embodiments read from and write to cache 580, while in other embodiments the cores 505 can only read from or write to cache 580. The cores may use the global cache to perform core to core communications.

The global cache 580 may be sectioned into individual memory sections where each section can be dedicated to a particular core 505. In one embodiment, the control core 505A can receive a greater amount of available cache, while the other cores 505 can receiving varying amounts or access to the global cache 580.

In some embodiments, the system 575 can comprise a control core 505A. While FIG. 5C illustrates core 1 505A as the control core, the control core can be any core within the appliance 200 or multi-core system. Further, while only a single control core is depicted, the system 575 can comprise one or more control cores each having a level of control over the system. In some embodiments, one or more control cores can each control a particular aspect of the system 575. For example, one core can control deciding which distribution scheme to use, while another core can determine the size of the global cache 580.

The control plane of the multi-core system may be the designation and configuration of a core as the dedicated management core or as a master core. This control plane core may provide control, management and coordination of operation and functionality the plurality of cores in the multi-core system. This control plane core may provide control, management and coordination of allocation and use of memory of the system among the plurality of cores in the multi-core system, including initialization and configuration of the same. In

some embodiments, the control plane includes the flow distributor for controlling the assignment of data flows to cores and the distribution of network packets to cores based on data flows. In some embodiments, the control plane core runs a packet engine and in other embodiments, the control plane core is dedicated to management and control of the other cores of the system.

The control core 505A can exercise a level of control over the other cores 505 such as determining how much memory should be allocated to each core 505 or determining which core 505 should be assigned to handle a particular function or hardware/software entity. The control core 505A, in some embodiments, can exercise control over those cores 505 within the control plan 570. Thus, there can exist processors outside of the control plane 570 which are not controlled by the control core 505A. Determining the boundaries of the control plane 570 can include maintaining, by the control core 505A or agent executing within the system 575, a list of those cores 505 controlled by the control core 505A. The control core 505A can control any of the following: initialization of a core; determining when a core is unavailable; re-distributing load to other cores 505 when one core fails; determining which distribution scheme to implement; determining which core should receive network traffic; determining how much cache should be allocated to each core; determining whether to assign a particular function or element to a particular core; determining whether to permit cores to communicate with one another; determining the size of the global cache 580; and any other determination of a function, configuration or operation of the cores within the system 575.

F. Policy Based Cache Redirection to WAN Optimization Devices

Referring now to FIG. 6A, an embodiment of a system for redirecting client requests by an intermediary device to horizontally deployed Wide Area Network (WAN) optimization devices providing service to the redirected client requests. In brief overview of FIG. 6A, an intermediary device, also referred to as an intermediary 200 or appliance 200, is deployed between a client 102 and a server 106. Intermediary 200 may include a cache redirector 600 which may further include a configuration 605 and a policy 610. Intermediary 200 may also comprise a virtual server 275 for handling the network traffic traversing the intermediary 200. A client 102 may communicate with a WAN device 205A via a network 104. WAN device 205A may be in a communication with the intermediary device 200 via a network 104'. Intermediary 200 may also be in communication with another WAN device 205B via a network 104" and a server 106 via a network 104"". In some configurations, any of the client 102, server 106, intermediary 200 and WAN device 205 may be operating within a same or a different network, such as for example, the network 104.

In some aspects, FIG. 6A corresponds to an embodiment of a system in which client 102 sends a request destined for a server 106. WAN device 205A may intercept the client request and perform some services or operations to the request, such as any optimization, functionality or security services and operations. Some such services may entail that two or more WAN devices 205 service operate or service the same request before the request is sent to the server 106. WAN device 205A may modify the request to include an information or a feature that indicates that a WAN device 205 has performed an operation on the request. In some embodiments, client request is modified to identify the operation or service completed. Intermediary 200 may receive the request transmitted by the WAN device 205 and prior to forwarding the request to the destination server 106, identify that the

request was previously serviced by a WAN device 205A. Cache redirector 600 of the intermediary 200 may determine that the client request should be forwarded to a WAN device 205B so that the operation or service performed by the first WAN device 205A be completed. WAN device 205B may be deployed horizontally to the intermediary 200, and therefore not in line with the WAN device 205A, server or client. For example, the second WAN device 205B may not be in the path of network traffic from the client to server, the client to the intermediary and/or the intermediary to server. In some embodiments, the intermediary and WAN device 205B are in line or on the same network path different from the network path the intermediary may have with either the client or server. In some embodiments, the WAN device 205B may be on a different network segment than the client and/or server.

WAN device 205B may be used by intermediary 200 to complete operations or functions started or initiated by other WAN devices 205, such as WAN device 205A. WAN device 205B may receive the client request and identify the service or the operation to be implemented on the network packet. In some embodiments, WAN device 205B modifies the request to include an information or a feature that indicates that the operation started by WAN device 205A has been completed by WAN device 205B. Cache redirector 600 of the intermediary 200 may receive the request from WAN device 205B and determine that the request is ready to be forwarded to the destination server 106. Cache redirector 600 may then forward the request to any other component of the intermediary 200, such as the virtual server 275 or to the destination server 106.

In addition to aforementioned embodiments, Wide Area Network optimization device 205, or WAN device 205, may be any intermediary component, device, function or a unit performing an operation or a service on a network packet, such as a client request or a server response. WAN device 205 may include any functionality of any intermediary 200 or intermediary 205. In some embodiments, WAN device 205 includes a packet engine 548, a cache manager 232 and a policy engine 236. WAN device 205 may also include a multi-protocol compression 238, an integrated packet engine 240 and a network stack 267. WAN device 205 may include a virtual server 275, an acceleration 288, an SSL VPN 280, a monitoring agent 197, an acceleration program 302 and a streaming client 306. In some embodiments, WAN device 205 includes a client agent 120 and/or service 270.

WAN device 205 may perform any acceleration, optimization or security service or operation on a network packet. In some embodiments, WAN device 205 accelerates transmission of network packets between a client 102 and server 106 by compressing and decompressing network packets. In some embodiments, WAN device 205 performs encryption and/or decryption of a network packet. A WAN device 205 may operate with another WAN device 205 as a pair to complete a single function. For example, a WAN device 205A may compress a network packet and a WAN device 205B may decompress the same network packet. Similarly, a WAN device 205A may encrypt a network packet and a WAN device 205B may decrypt the same network packet. In some embodiments, a plurality of WAN devices 205 share a compression history used to compress one or more network packets for accelerated transmission over a wide area network. WAN devices 205A and 205B may share an encryption key, thereby being only network devices capable of completing each other's tasks.

WAN devices 205 may modify or edit any network packet. In some embodiments, WAN device 205 modifies a format or the size of the network packet. In some embodiments, WAN device compresses a network packet. In some embodiments,

WAN device decompresses a network packet. In some embodiments, WAN device 205 modifies an option field of a network packet, such as a transport layer option field. In some embodiments, WAN device 205 modifies a header of the network packet. In further embodiments, WAN device 205 modifies a body of the network packet. WAN device may modify an HTTP header of a network packet or any information at any network layer stack.

In addition to aforementioned features, virtual server 275 may include any feature or functionality to aid in network packet redirection or forwarding by a cache redirector 600. In some embodiments, virtual server 275 performs load balancing of the network packets received by the cache redirector 600. In further embodiments, virtual server 275 implements functions or instructions requested by the cache redirector 600, which may include forwarding of the network packets in accordance with cache redirector 600 instructions. In some embodiments, virtual server 275 forwards network packets, such as the client requests or server responses to the destinations to whom the network packets were originally sent. In some embodiments, virtual server 275 forwards a client request received from a cache redirector 600 to a server 106. In some embodiments, virtual server 275 forwards a server response received from a cache redirector 600 to a client 102.

Cache redirector 600 may comprise any hardware, software or any combination of hardware and software for redirecting, forwarding or managing network packets received by the intermediary 200. Cache redirector 600 may comprise any and all functionality of a virtual server 275 or a backup virtual server 276. In some embodiments, cache redirector 600 includes a virtual server 276. Cache redirector 600 may include any logic circuits, processors, functions, programs, algorithms or components that alone, or in combination, provide functionality for redirecting or forwarding the network packets traversing intermediary 200. Cache redirector 600 may include functionality to determine which network packet to forward to which outside network device. For example, cache redirector 600 may include functionality to distinguish between a network packet that is to be forwarded to a destination server 106 from a network packet that is to be forwarded to a WAN device 205. Cache redirector 600 may include policies and configurations to determine where each network packet will be forwarded.

Cache redirector 600 may comprise any information about any WAN device 205. In some embodiments, cache redirector 600 includes information about WAN device 205A and WAN device 205B. Information about the WAN device may include any relevant information, such as proximity to the intermediary 200, configuration with other WAN devices 205 and configuration with the intermediary 200. In some embodiments, cache redirector 600 includes information about WAN device 205 that is deployed horizontally to intermediary 200 in reference to other WAN devices 205. For example, cache redirector 600 may include information about a WAN device 205 to whom to forward a client request that has been compressed or encrypted by a WAN device 205 comprising a compression history. The horizontally deployed WAN device 205 may be the closest, most convenient and/or fastest resolution for decompression or decryption of the network packet. Cache redirector 600 may send to the horizontally deployed intermediary 200 the network packets that need to be serviced or operated on by a WAN device 205 prior to being forwarded to the intended destination, such as a client 102 or server 106.

Cache redirector 600 may include functionality to forward, redirect and/or manage any network packet, such as a client request, a server response, or any other data or communication traversing the cache redirector 600. Cache redirector 600

may forward or redirect any request of a client or a response of a server previously modified, edited, compressed or encrypted by a WAN device 205. In some embodiments, cache redirector 600 communicates, redirects, receives or forwards network packets to and from any network devices or environments, such as other appliances 200, WAN devices 205, application servers, proxies, routers, virtual servers 275, other clients 102 or servers 106. Cache redirector 600 may include functions, algorithms, configurations and policies for establishing, terminating, controlling or managing any connections with another WAN device 205. Cache redirector 600 may modify, edit or rewrite any portion of a network packet, such as for example a header or a body of the network packet. WAN device 205 may edit an option field of a network packet, such as an option field at a transport layer of a network packet. In some embodiments, cache redirector 600 modifies or edits a client request redirected or forwarded to a cache server, WAN device 205, or any other network device. Cache redirector 600 may modify any portion of the request, such as an internet protocol address, media access control address, port identifier or any other portion of the request or response.

Cache redirector 600 may comprise functionality to identify any change incurred on a client request or a server response by a WAN device 205. In some embodiments, cache redirector 600 identifies that a header of a network packet includes a flag, a marker or an information identifying that an operation has been performed by a WAN device 205. In further embodiments, cache redirector 600 identifies that an option field of a transport layer of a network packet includes a flag, a marker or an information which may be used to identify an operation that was performed by WAN device 205. Similarly, cache redirector 600 or the WAN device 205 may include functionality to use the flag, the marker or the information to identify that the network packet should be forwarded to another WAN device 205 for another operation to be performed. In some embodiments, cache redirector 600 uses an information from an option field to identify that a network packet is to be sent to another WAN device 205 so that decompression, decryption or a second portion of any operation or service is to be performed by WAN device 205. Cache redirector 600 may include information, settings, configurations or features to identify the appropriate destination WAN device 205 to complete a service started by a previous WAN device.

Cache redirector 600 may be configured to include any feature functionality to support any type and form of protocol or system configuration. In some embodiments, cache redirector is configured to support HTTP and TCP-based protocols. In some embodiments, cache redirector 600 is configured for TCP-based protocols, IP based protocols or any protocols of communication at any level of the network stack. In some embodiments, cache redirector 600 is further configured to support any other additional protocols of requests or responses that may traverse intermediary 200. Cache redirector 600 may include one or more configurations 605 which may identify particular modes of operation for redirecting or forwarding the network traffic. Configurations 605 may include, or work in conjunction with one or more policies 610 to identify which actions to be performed for a particular network packet. In some embodiments, cache redirector 600 may be configured to forward the network traffic having a particular feature, information, setting, format or detail to a particular network device, such as a WAN device 205 or a server 106. Cache redirector 600 may also include a configuration set to operate in a mode for forwarding a network packet in accordance with a feature of a header or a content of the payload of the network packet. Cache redirector 600 may

be include a policy 610 or a rule to forward a network packet to a virtual servers 275 or to a server 106. Cache redirector 600 may be configured to perform any actions or operations based on any number configurations 605 and/or policies 610.

Configuration 605 may include any type and form of parameter, setting or instruction for identifying, activating or triggering redirection of network packets, such as client requests or server responses. In some embodiments, configuration 605 includes settings, instructions or parameter for triggering policies 610 or rules for identifying which network packets are to be forwarded to a WAN device 205 and which to a destination client 102 or server 106. Configuration 605 may triggering operation for redirecting requests to an internal intermediary 200 component, such as a virtual server 275 or a packet engine 548. Configuration 605 may include a parameter, a setting, a function, an instruction, a character, a string or a command. Configuration 605 may be stored in any memory location of an intermediary 200. In some embodiments, configuration 605 is stored within one or more instructions for managing network packet forwarding or redirection by intermediary 200. Configuration 605 may be connection based, session based, client 102 based, server 106 based or based on any configuration by a user or an administrator. Configuration 605 may be set or configured for all network packets transmitted via a particular connection, a particular session, from a particular client 102 or a user on the client 102 or transmitted in connection with a particular server 106. In certain embodiments, configuration 605 is preconfigured or preset by a user. Configuration 605 may be installed on intermediary 200 in accordance with a setting for a policy 610. In some embodiments, configuration 605 is received from a client 102 or a server 106 to specify forwarding of particular client requests and server responses by one or more WAN devices 205. Similarly, configuration 605 may specify handling of a client request or a server response by a cache redirector 600 to determine which network packets to forward to WAN devices 205 and which network packets to forward to the intended destination device, such as the client 102 or server 106.

Configuration 605 may comprises information, policies or rules to direct the identification of network packets that have been previously serviced or operated on by a WAN device 205. In some embodiments, configuration 605 includes policies 610 or rules that distinguish a network packet that was serviced by a WAN device 200 once from a network packet that was serviced by a WAN device 205 twice. For example, configuration 605 may include policies 610 for identifying that a network packet has been compressed by a WAN device 205. Configuration 605 may identify a compressed network packet from an information stored in an option field of a header of the network packet. In some embodiments, configuration 605 identifies that a network packet has been operated on by a WAN device 205 by reading an information stored in a portion of the network packet, such as a header or an option field. In some embodiments, configuration 605 identifies that a network packet has been compressed, encrypted or otherwise modified by a WAN device 205 by identifying a particular flag, setting or a marker in a portion of the network packet, such as an option field of a transport layer of the network packet.

Configuration 605 may trigger or identify a set of policies or instructions for operations to be performed to the network packets being forwarded or transmitted between intermediary 200 and a particular WAN device 205. In some embodiments, configuration 605 includes an information identifying or triggering an operation to forward to a particular WAN device 205 a network packet that includes a particular feature

included or written into the network device by another WAN device 205A. In some embodiments, the feature of the network packet may include a feature or a property of any network layer of the request, including an IP address, a media access control address, a port identifier. The feature triggering the configuration 605 may also include an IP feature, a TCP feature, an HTTP feature, an HTML feature, a particular format or a type of the request or any other feature or property identifiable by intermediary 200 or WAN device 205. In some embodiments, configuration 605 identifies a policy 610 that identifies a set of rules or instructions identifying which network packets to forward to which WAN device 205. In further embodiments, configuration 605 identifies a policy 610 that identifies a set of rules or instructions identifying which network packets to forward to a particular virtual server 275, client 102 or server 106.

A configuration 605 of a cache redirector 600 of the intermediary device 200 may further include settings or expressions for deciding which network packets to be forwarded to a WAN device 205 and which network packets to be forwarded to a virtual server 275 of the intermediary 200. Configuration 605 may include expressions and settings for implementing policy based forwarding of network requests to horizontally deployed WAN optimization devices 205.

A configuration 605 of the cache redirector 600 may include instructions or code, such as the following:

```
enable ns mode USIP
add service SVC_BR_1 ip1 TCP port1-cacheType
TRANSPARENT
add lb vserver LB_BR_1-m MAC
bind lb vserver LB_BR_1 SVC_BR_1
add lb vserver V1 ip http 80-cacheable ON
add cr vserver CR1 TCP *-type TRANSPARENT-
cacheVserver LB_BR_1
```

The expression "SVC_BR_1" may include an internet protocol address of a WAN device 205 to whom the request is forwarded. Expression "Lb vserver V1" may identify a virtual server 275 to whom the client 102 sends the request. Virtual server 275 may be configured to include caching. In some embodiments, configurations 605 may include one or more policies to determine which network packets are forwarded to WAN devices 205 based on TCP features.

Policy 610 may provide any policy or one or more rules for cache redirector 600 for forwarding or redirecting a network packet to a particular network device, such as a WAN device 205, client 102 or server 106. Policy 610 may provide any policy or one or more rules for cache redirector 600 to determine which network packets are to be forwarded to a WAN device 205 and which to be forwarded to a server 106 or client 102. In some embodiments, policy 610 comprises policies or rules to forward or redirect a network packet to a virtual server 275 of the intermediary 200. Policy 610 may include or identify a set of rules or tasks for determining that a network packet received by a network device has been compressed or otherwise modified by another WAN device 205. In some embodiments, policy 610 provides rules and tasks for forwarding a network packet to a WAN 205B if the network packet has been serviced by WAN 205A. Similarly, policy 610 may include rules and tasks for forwarding a network packet not serviced by a WAN device 205 to a destination network device identified by the destination IP address of the network packet, such as the server 106 or the client 102. Policy 610 may further identify or provide a set of rules or tasks for identifying a particular WAN device 205 to which the network packet will be forwarded. In some embodiments, policy 610 may provide rules or tasks for identifying an operation or service to be performed on the network packet by

57

the WAN device **205** to whom the request is forwarded by intermediary **200**. Policy **610** may include any functionality for instructing the WAN device **205** or the cache redirector **600** to modify a network packet accordingly so that cache redirector **600** may correctly forward or redirect the network packet upon receipt.

The intermediary device **200** and/or WAN device **205** may include any embodiment of a policy engine **236** or **195** as previously described herein. The policy engine may operate on or execute any one or more policies. Policy **610** may include any configuration or information for maintaining IP address of a network packet, such as a policy for a CR vServer, or a cache redirector virtual server. Policy **610** may comprise an algorithm, an executable, an instruction code, a computer program, a configuration, a command or a directive. Policy **610** may be stored in memory of the intermediary **200** or cache server **620**. In some embodiments, policy **610** includes a rule identifying or providing a set of instructions to be implemented by the cache redirector **600** or the cache server **620**. The set of instructions identified or provided by the policy **610** may be for forwarding or redirecting network packets that were previously serviced by a WAN device **205A** to another WAN device **205B**. In some embodiments, the set of instructions are for determining that the network packet has been serviced by two WAN devices **205** and that no further operations by WAN devices are necessary. In further embodiments, the set of instructions are for forwarding the network packet to the virtual server **275** for further processing, such as load balancing or forwarding to the server **106**.

Referring now to FIG. **6B**, an embodiment of steps of performing a policy based redirection of network packets by an intermediary device to a horizontally deployed WAN device. At step **605**, an intermediary device receives a request from a client destined for a server, the request comprising an information stored in an option field. At step **610**, the intermediary device determines to send the request to a horizontally deployed WAN device B instead of the intended server, in response to a policy of a cache redirector. At step **615**, the intermediary device transmits the request to the WAN device B, while maintaining the information stored in the option field. At step **620**, the intermediary receives the request modified by the WAN device B. At step **625**, the intermediary determines that the modified request received from the WAN device B has been processed by the WAN device B. At step **630**, the intermediary device transmits to the destination server the modified request, such as responsive to a policy.

At step **605**, an intermediary device receives any network packet from any source network device destined to any destination network device. The network packet may include information stored in an option field, such an optional field of TCP layer or IP layer of the packet. In some embodiments, an intermediary device **200** receives a request from a client **102** destined to a server **106**. In other embodiments, the intermediary device **200** receives a response from a server **106** to a client request, the response destined to the client **102**. Intermediary device **200** may receive the network packet comprising any information about the network packet stored in a header of the network packet. In some embodiments, intermediary device **200** receives a network packet comprising a flag or a marker stored in an option field. In some embodiments, the flag, the marker or any information stored in the option field of a transport layer portion of the request or the response. The flag, the marker or any information in the option field may be entered into the option field by a WAN device **205**. The information in the option field may be processable by a WAN device **205**. The information in the option field may indicate that a WAN device **205** has compressed the

58

network packet. In some embodiments, the information stored in the option field indicates that a WAN device **205** has encrypted the network packet. The information stored in the option field may identify the first WAN device **205** operating on the network packet to any subsequent WAN device **205** that may receive the network packet in the future. In some embodiments, the information stored in the option field may identify information on processing a payload of the network packet for any subsequent WAN device **205** that may receive the network packet in the future. The information stored in the option field may indicate that the network packet has been compressed using a particular compression history. The information stored in the network packet may also identify a particular compression history used in compressing the network packet. The information stored in the network packet may identify an information used by WAN devices **205** to decompress or decrypt the compressed or encrypted network packet. In further embodiments, the information stored in the option field indicates that the network packet needs to be serviced by another WAN device **205** before being forwarded to the destination network device, such as the destination server **106** or destination client **102**.

At step **610**, the intermediary device determines to send the network packet to a WAN device B instead of the destination network device and may make the determination responsive to a policy. The intermediary device **200** may determine to redirect the network packet to a WAN device B that is horizontally deployed to the intermediary device **200**. WAN device B may be identified by a cache redirector **600** as a WAN device B most appropriate to receive and service the client requests and/or server responses sent by the intermediary **200**. In some embodiments, a cache redirector **600** determines to redirect the network packet. A cache redirector **600** may determine to redirect a client request to a WAN device B instead of the destination server **106**. In some embodiments, a cache redirector **600** determines to redirect a server response to a client request to WAN device B instead of the destination client **102**. A cache redirector **600** of the intermediary device may determine to send the network packet to the WAN device B in response to a redirection policy **610** that identifies a presence of the information stored in the option field. A cache redirector **600** may determine to send the network packet to the WAN device B in response to evaluating an expression of the redirection policy to the first option field, or concerning the first option field. In some embodiments, intermediary identifies a particular WAN device B out of a plurality of horizontally deployed WAN devices to send the network packet to, in response to a portion of the information stored in the option field. The portion of the information may identify a particular feature or a characteristic of the WAN device B, such as a configuration, a compression history, an encryption key. In some embodiments, the portion of the information identifying WAN device B includes a unique identifier of the WAN device B, such as an IP address, a MAC address, a port or a connection between the intermediary **200** and the WAN device B. The policy for redirecting to the WAN device may be based on any arrangement and/or format and/or content of the request that may be used to identify that WAN device A processed the request.

At step **615**, the intermediary device transmits the network packet to the WAN device B, while maintaining the information stored in option field of the network packet. In some embodiments, the intermediary generates a second network packet or request to send to WAN device B. In some of these embodiments, the intermediary copies the option field information from the first request or packet to the generated second request or packet. In other embodiments, the intermediary

59

modifies the network packet or first request to put in a form for sending to WAN device B. In some embodiments, cache redirector **600** of the intermediary device transmits the client request to the WAN device B while maintaining the information stored in the option field of the network packet. In other embodiments, cache redirector **600** transmits the server response to the client request to WAN device B while maintaining the information stored in the option field of the network packet. The information stored in the option field may identify for WAN device B that WAN device A has previously serviced the network packet. The information stored in the option field may further indicate to WAN device B information about the service previously performed by WAN device A, such as for example compression using a particular compression history. WAN device B may utilize the information stored in the option field to identify services or operations needed to be performed on the network packet. In some embodiments, the intermediary device establishes a transport layer connection between the intermediary device **200** and the WAN device B. The connection may be established to the WAN device B out of a plurality of available horizontally deployed WAN devices. In some embodiment, intermediary device **200** forwards the network packet to the WAN device while forwarding the information from the option field separately. In some embodiments, intermediary device **200** forwards the network packet and instructions about handling or servicing of the network packet. The instructions may have been produced by the cache redirector **600** in response to a set of configurations **605** and/or policies **610** executed based on the information stored in the option field.

At step **620**, the intermediary **200** receives the network packet modified by the WAN device B. In some embodiments, the network packet is received via a new connection established between the WAN device B and the intermediary **200**. In some embodiments, the modified network packet includes a client request modified by WAN device B. In other embodiments, the modified network packet includes a server response modified by WAN device B. The modified network packet may include a decompressed network packet. In some embodiments, the modified network packet includes a decrypted network packet. In further embodiments, the modified network packet is serviced or modified by WAN device B to be ready to be received by the destination network device, such as a destination client **102** or a destination server **106**. Intermediary **200** may receive the network packet that was modified by the WAN device B may to include the information included in the option field at step **605** into another option field of the network packet. The information in the other option field of the network packet may comprise a flag or a marker indicating that WAN device B has completed operation, such as decompression or decryption of the network packet. In some embodiments, the modified network packet includes the information in the option field modified by WAN device B to indicate that the network packet has been processed by WAN device B. In some embodiments, the modified network packet is modified so that it is in a format that is different from a format of the network packet at step **605**. In further embodiments, the modified network packet comprising a client request is modified by the WAN device B to be similar or same as the client request before being processed by WAN device A. In still further embodiments, the modified network packet comprising a server response is modified by the WAN device B to be similar or same as the server response before being processed by WAN device A.

In some embodiments, the WAN device B performs processing on the request or packet to put the request back in the same form as was transmitted from the client before WAN

60

device A processed the packet. For example, client may transmit a request that is compressed by WAN device B using a compression history. WAN device B may uncompress the compressed request using its compression history and provide back to the intermediary the request as was sent by the client.

At step **625**, the intermediary device **200** determines that the modified network packet received from the WAN device B has been processed by the WAN device B. In some embodiments, cache redirector **600** of the intermediary **200** determines that the information stored in the option field has been modified. Cache redirector **600** may determine that the information stored in the option field has been modified to indicate that no further processing by a WAN device is necessary. In some embodiments, cache redirector **600** utilizes configurations **605** and/or policies **610** to determine that the information stored in the option field indicates that the modified network packet has been processed by WAN device B. Cache redirector **600** may determine that the modified network packet, such as the modified client request or the modified server response, has been decompressed. In some embodiments, cache redirector **600** determines that the modified network packet has been decrypted. Cache redirector **600** may determine that the modified network packet is decompressed and/or decrypted based on the information stored in the option field of the modified network packet. Similarly, cache redirector **600** may determine that WAN device processing of the network packet is now complete, based on the information stored in the option field.

At step **630**, intermediary **200** may transmit to the destination network device the modified network packet and may transit the modified network packet in response to a policy **610**. In some embodiments, the cache redirector communicates the modified client request received from WAN device B to a virtual Server **175** that manages the service or server for the client request. In some embodiments, the cache redirector performs the redirection to the WAN device B and receiving of the request back from WAN device B transparently to the virtual server. The virtual server **275** may manage or load balance the network traffic being transmitted to the destination device. In some embodiments, cache redirector **600** determines, responsive to configurations **605** and/or policies **610** that the modified network packet, such as the modified client request or the modified server response from WAN device B, is to be forwarded to the destination device. In some embodiments, the intermediary receives the client request from WAN device B and responds to the client based on content stored in the cache of the intermediary device. In some embodiments, cache redirector **600** determines, based on configurations **605** and/or policies **610** that the modified network packet does not need to be forwarded to a WAN device. In response to such determination, cache redirector **600** may forward the network packet to a destination server **106** or a destination client **102**. In some embodiments, intermediary **200** transmits a client request to a destination server **106** directly and bypassing WAN device B.

We claim:

1. A method of redirecting requests by an intermediary to a horizontally deployed Wide Area Network optimization device, the method comprising steps of:

(a) receiving, by an intermediary device deployed between a plurality of clients and one or more servers, via a first transport layer connection, a first request from a client to access a server, the first request modified by a first Wide Area Network (WAN) optimization device deployed between the client and the intermediary device to

61

include information in a first option field of a transport layer processable by a second WAN optimization device;

- (b) determining, by the intermediary device responsive to a redirection policy, to send the first request to the second WAN optimization device instead of the server;
- (c) establishing, by the intermediary device, a second transport layer connection with the second WAN optimization device deployed horizontally to the intermediary device, the horizontally deployed second WAN optimization device communicating with the intermediary device via a first network path that is different from and not a part of a second network path over which network traffic between the plurality of clients and one or more servers traverses the intermediary device; and
- (d) transmitting, by the intermediary device, the first request to the second WAN optimization device via the second transport layer connection, the intermediary device maintaining the information from the first option field of the first request in a second option field of a transport layer of the first request;
- (e) receiving, by the intermediary device, the first request from the second WAN optimization device via the first network path, the first request modified by the second WAN optimization device;
- (f) determining, by the intermediary device, based on content of the modified first request, that the modified first request received from the second WAN optimization device has been processed by the second WAN optimization device; and
- (g) transmitting, by the intermediary device, the modified first request to the server via the second network path responsive to determining that the modified first request received from the second WAN optimization device has been processed by the second WAN optimization device.

2. The method of claim 1, wherein step (a) further comprises receiving, by the intermediary device, the first request including the information in the first option field identifying the first WAN optimization device to the second WAN optimization device.

3. The method of claim 1, wherein step (a) further comprises receiving, by the intermediary device, the first request including the information in the first option field identifying to the second WAN optimization device instructions on processing a payload of the first request.

4. The method of claim 1, wherein step (b) further comprises determining, by the intermediary device, to send the first request to the second WAN optimization device responsive to the redirection policy identifying a presence of the information in the first option field.

5. The method of claim 1, wherein step (b) further comprises determining, by the intermediary device, to send the first request to the second WAN optimization device responsive to evaluating an expression of the redirection policy to the first option field.

6. The method of claim 1, wherein step (c) further comprises establishing, by the intermediary device, a second transport layer connection with the second WAN optimization device of a plurality of WAN optimization devices deployed horizontally to the intermediary device.

7. The method of claim 1, wherein step (e) further comprises receiving, by the intermediary device, the first request processed by the second WAN optimization device to uncompress a payload of the first request.

62

8. The method of claim 1, wherein step (e) further comprises receiving, by the intermediary device, the first request processed by the second WAN optimization device to form a second request.

9. The method of claim 8, further comprising determining, by the intermediary device, that the second request is received after processing by the second WAN optimization device; and wherein step (g) further comprises

transmitting, by the intermediary device, the second request to the server identified by the first request.

10. The method of claim 1, transmitting, by a cache redirection server of the intermediary device, the second request to a virtual server of the intermediary device managing the server.

11. A system of redirecting requests by an intermediary to a horizontally deployed Wide Area Network optimization device, the system comprising:

a first Wide Area Network (WAN) optimization device deployed between a plurality of clients and a server receiving a first request from a client to access a server and modifying the first request to include information in a first option field of a transport layer processable by a second WAN optimization device;

an intermediary device deployed between a plurality of clients and one or more servers receiving, via a first transport layer connection, the first request from the first WAN optimization device;

a cache redirection virtual server of the intermediary device determining, responsive to a redirection policy, to send the first request to the second WAN optimization device instead of the server;

wherein the intermediary device establishes a second transport layer connection with the second WAN optimization device deployed horizontally to the intermediary device, the horizontally deployed second WAN optimization device configured to communicate with the intermediary device via a first network path that is different from and not a part of a second network path over which network traffic between the plurality of clients and the server traverses the intermediary device; and

transmits the first request to the second WAN optimization device via the second transport layer connection, the intermediary device maintaining the information from the first option field of the first request in a second option field of a transport layer of the first request;

receives the first request processed by the second WAN optimization device, the first request modified by the second WAN optimization device;

determines, based on content of the modified first request, that the modified first request received from the second WAN optimization device has been processed by the second WAN optimization device; and transmits the modified first request to the server via the second network path responsive to determining that the modified first request received from the second WAN optimization device has been processed by the second WAN optimization device.

12. The system of claim 11, wherein the intermediary device receives the first request including the information in the first option field identifying the first WAN optimization device to the second WAN optimization device.

13. The system of claim 11, wherein the intermediary device receives the first request including the information in

63

the first option field identifying to the second WAN optimization device instructions on processing a payload of the first request.

14. The system of claim **11**, wherein the cache redirection virtual server determines to send the first request to the second WAN optimization device responsive to the redirection policy identifying a presence of the information in the first option field.

15. The system of claim **11**, wherein the cache redirection virtual server determines to send the first request to the second WAN optimization device responsive to evaluating an expression of the redirection policy to the first option field.

16. The system of claim **11**, wherein the intermediary device establishes the second transport layer connection with the second WAN optimization device of a plurality of WAN optimization devices deployed horizontally to the intermediary device.

64

17. The system of claim **11**, wherein the intermediary device receives the first request processed by the second WAN optimization device to uncompress a payload of the first request.

18. The system of claim **11**, wherein the intermediary device receives the first request processed by the second WAN optimization device to form a second request.

19. The system of claim **18**, wherein the intermediary device determines that the second request is received after processing by the second WAN optimization device and transmits the second request to the server identified by the first request.

20. The system of claim **18**, wherein the cache redirection virtual server of the intermediary device communicates the second request to a second virtual server of the intermediary device managing the server.

* * * * *