

US008882829B2

(12) **United States Patent**  
**Gladdish, Jr. et al.**

(10) **Patent No.:** **US 8,882,829 B2**  
(45) **Date of Patent:** **\*Nov. 11, 2014**

(54) **LOW PROFILE IMPROVED RADIOPACITY INTRALUMINAL MEDICAL DEVICE**

(2013.01); *A61F 2250/0067* (2013.01); *A61F 2/915* (2013.01); *A61B 19/54* (2013.01); *A61L 31/022* (2013.01); *A61F 2250/0098* (2013.01)

(75) Inventors: **Bennie W. Gladdish, Jr.**, Davie, FL (US); **Marco Nino**, Miami, FL (US); **William D. Shaw, Jr.**, Miami, FL (US); **Durk C. Sijbolts**, Fremont, CA (US); **Dennis B. Vaughan**, Miami, FL (US)

USPC ..... **623/1.34**; 623/1.15  
(58) **Field of Classification Search**  
USPC ..... 623/1.15, 1.34  
See application file for complete search history.

(73) Assignee: **Cordis Corporation**

(56) **References Cited**

(\*) Notice: Subject to any disclaimer, the term of this patent is extended or adjusted under 35 U.S.C. 154(b) by 16 days.

U.S. PATENT DOCUMENTS

This patent is subject to a terminal disclaimer.

3,585,707 A 6/1971 Stevens  
4,655,771 A 4/1987 Wallsten

(Continued)

(21) Appl. No.: **13/494,416**

FOREIGN PATENT DOCUMENTS

(22) Filed: **Jun. 12, 2012**

EP 0894481 2/1999  
EP 0895760 2/1999

(Continued)

(65) **Prior Publication Data**

US 2012/0253455 A1 Oct. 4, 2012

OTHER PUBLICATIONS

**Related U.S. Application Data**

International Search Report in PCT Application No. PCT/US02/09297 dated Aug. 5, 2002.

(Continued)

(60) Division of application No. 10/127,191, filed on Apr. 22, 2002, now Pat. No. 8,197,535, which is a continuation-in-part of application No. 09/884,729, filed on Jun. 19, 2001, now Pat. No. 6,863,685.

*Primary Examiner* — Ryan Severson

(51) **Int. Cl.**

*A61F 2/82* (2013.01)  
*A61F 2/91* (2013.01)  
*A61L 31/18* (2006.01)  
*A61L 31/10* (2006.01)  
*A61L 31/02* (2006.01)  
*A61F 2/915* (2013.01)  
*A61B 19/00* (2006.01)

(57) **ABSTRACT**

A stent or other intraluminal medical device having markers formed from housings integral with the stent and marker inserts having a higher radiopacity than the stent provides for more precise placement and post-procedural visualization in a vessel, by increasing the radiopacity of the stent under X-ray fluoroscopy. The housings are formed integral to the stent and the marker inserts are made from a material close in the galvanic series to the stent material and sized to substantially minimize the effect of galvanic corrosion. The housings are also shaped to minimize their impact on the overall profile of the stent.

(52) **U.S. Cl.**

CPC ..... *A61F 2/91* (2013.01); *A61F 2002/91533* (2013.01); *A61L 2400/16* (2013.01); *A61L 31/18* (2013.01); *A61F 2002/91558* (2013.01); *A61L 31/10* (2013.01); *A61F 2310/0097*

**26 Claims, 13 Drawing Sheets**

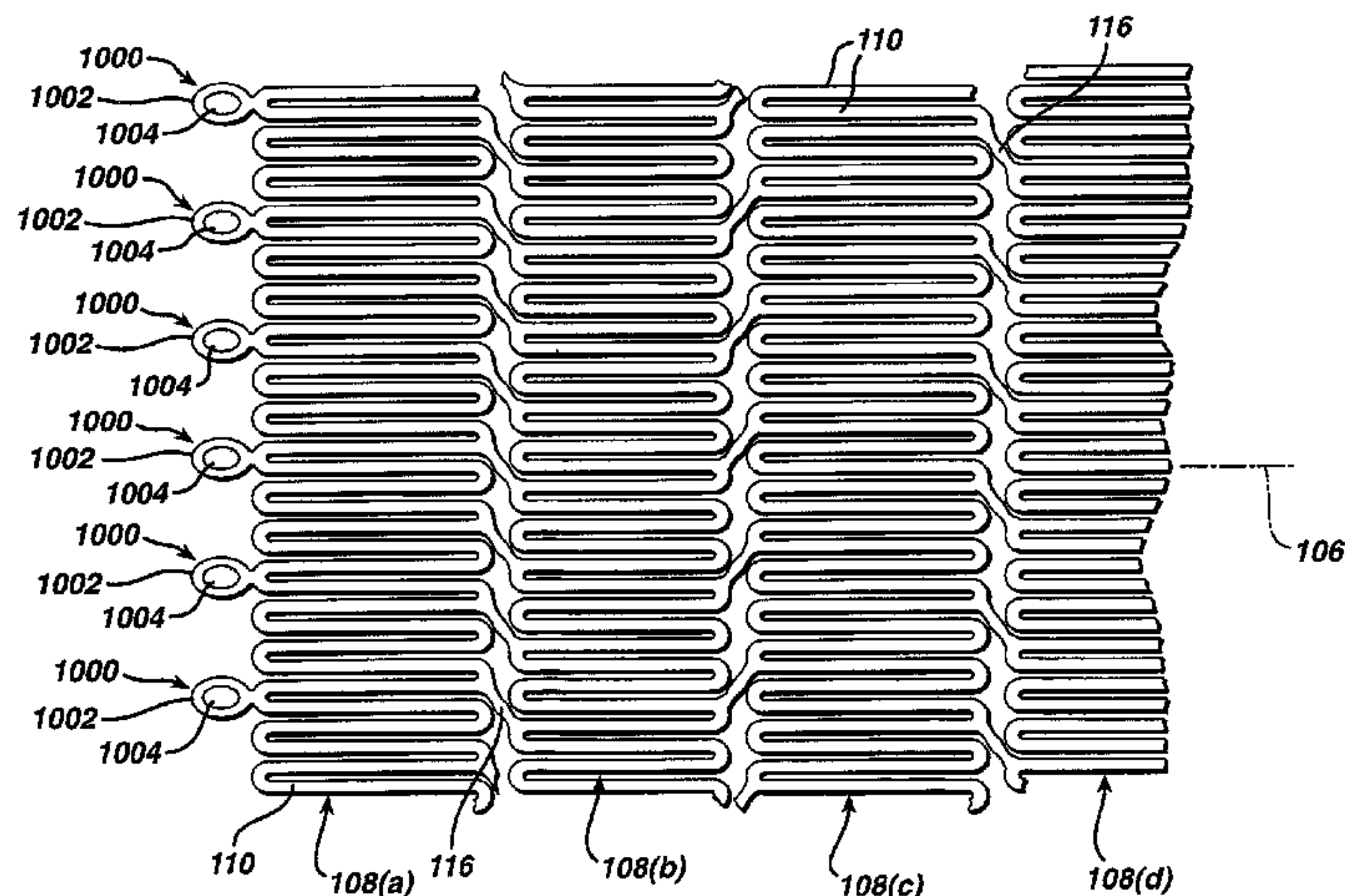

(56)

References Cited

U.S. PATENT DOCUMENTS

4,665,905 A 5/1987 Brown  
 4,733,665 A 3/1988 Palmaz  
 4,925,445 A 5/1990 Sakamoto et al.  
 5,045,072 A 9/1991 Castillo et al.  
 5,254,107 A 10/1993 Soltesz  
 5,632,771 A \* 5/1997 Boatman et al. .... 623/1.15  
 5,725,572 A \* 3/1998 Lam et al. .... 623/1.16  
 5,741,327 A \* 4/1998 Frantzen .... 623/1.34  
 5,800,526 A 9/1998 Anderson et al.  
 5,824,042 A 10/1998 Lombardi et al.  
 5,861,027 A \* 1/1999 Trapp .... 623/1.15  
 5,938,697 A \* 8/1999 Killion et al. .... 623/1.15  
 5,964,798 A \* 10/1999 Imran .... 623/1.12  
 5,976,169 A \* 11/1999 Imran .... 623/1.15  
 6,022,374 A \* 2/2000 Imran .... 623/1.34  
 6,129,754 A 10/2000 Kanesaka et al.  
 6,129,755 A \* 10/2000 Mathis et al. .... 623/1.15  
 6,159,238 A \* 12/2000 Killion et al. .... 623/1.11  
 6,203,569 B1 3/2001 Wijay  
 6,231,598 B1 \* 5/2001 Berry et al. .... 623/1.15  
 6,293,966 B1 \* 9/2001 Frantzen .... 623/1.15  
 6,315,790 B1 11/2001 Gerberding et al.  
 6,334,871 B1 \* 1/2002 Dor et al. .... 623/1.34  
 6,402,777 B1 \* 6/2002 Globerman et al. .... 623/1.11  
 6,409,752 B1 \* 6/2002 Boatman et al. .... 623/1.15  
 6,409,754 B1 \* 6/2002 Smith et al. .... 623/1.16  
 6,464,720 B2 \* 10/2002 Boatman et al. .... 623/1.15

6,623,518 B2 \* 9/2003 Thompson et al. .... 623/1.11  
 6,652,579 B1 \* 11/2003 Cox et al. .... 623/1.34  
 6,749,629 B1 \* 6/2004 Hong et al. .... 623/1.15  
 6,814,746 B2 \* 11/2004 Thompson et al. .... 623/1.11  
 6,863,685 B2 \* 3/2005 Davila et al. .... 623/1.34  
 7,264,633 B2 \* 9/2007 Bonsignore .... 623/1.15  
 2001/0001317 A1 \* 5/2001 Duerig et al. .... 623/1.15  
 2001/0027339 A1 10/2001 Boatman et al.  
 2002/0193867 A1 \* 12/2002 Gladdish et al. .... 623/1.15  
 2003/0135254 A1 \* 7/2003 Curcio et al. .... 623/1.1  
 2004/0015228 A1 \* 1/2004 Lombardi et al. .... 623/1.18  
 2004/0015229 A1 \* 1/2004 Fulkerson et al. .... 623/1.22  
 2004/0073291 A1 \* 4/2004 Brown et al. .... 623/1.15  
 2004/0088039 A1 \* 5/2004 Lee et al. .... 623/1.15

FOREIGN PATENT DOCUMENTS

EP 0945107 9/1999  
 WO 9503010 2/1995  
 WO 9733534 9/1997  
 WO 9930643 6/1999  
 WO 0215820 2/2002  
 WO 0226281 4/2002  
 WO 02078762 10/2002

OTHER PUBLICATIONS

European Search Report in Patent Application No. EP03252530 dated Jul. 23, 2003.

\* cited by examiner

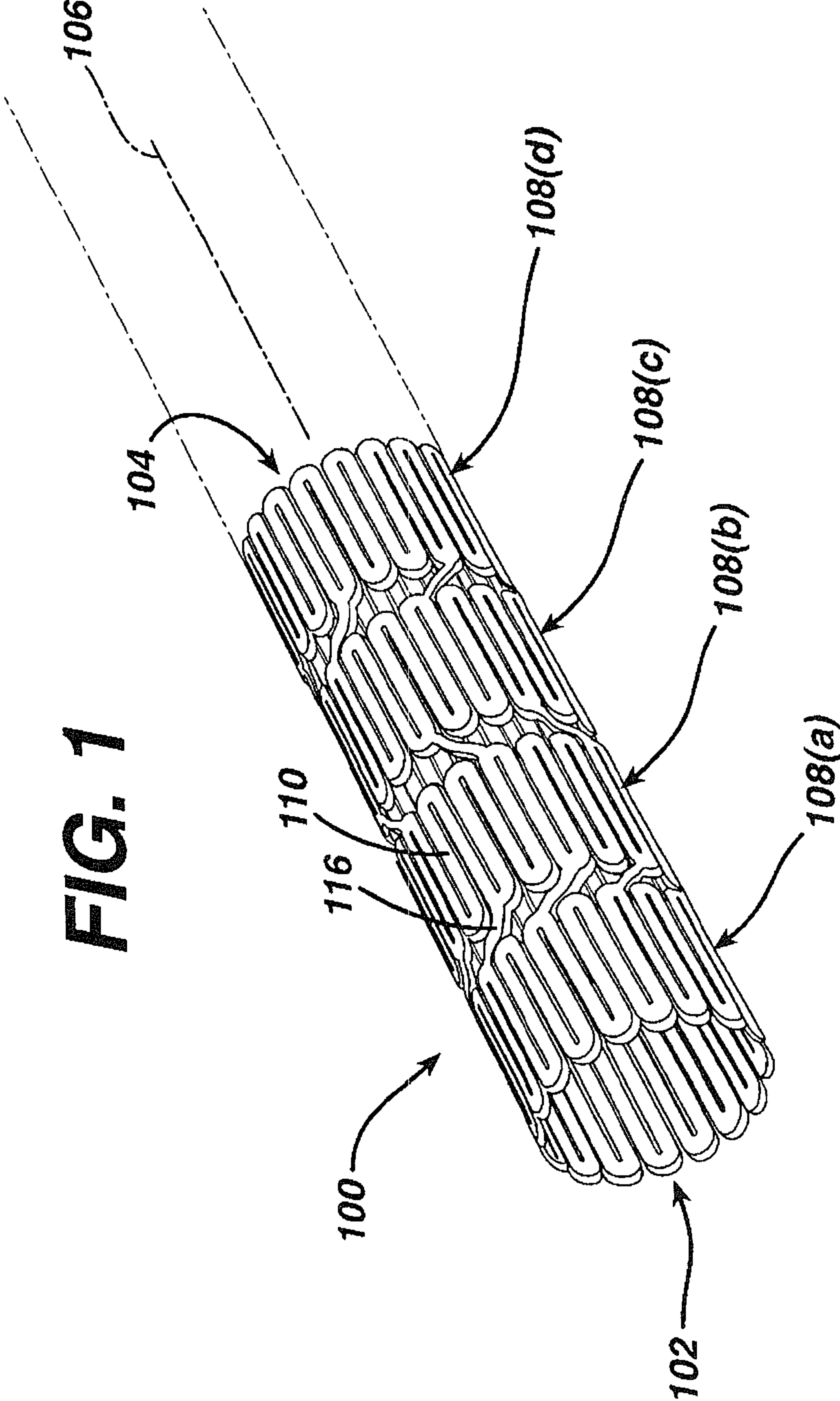
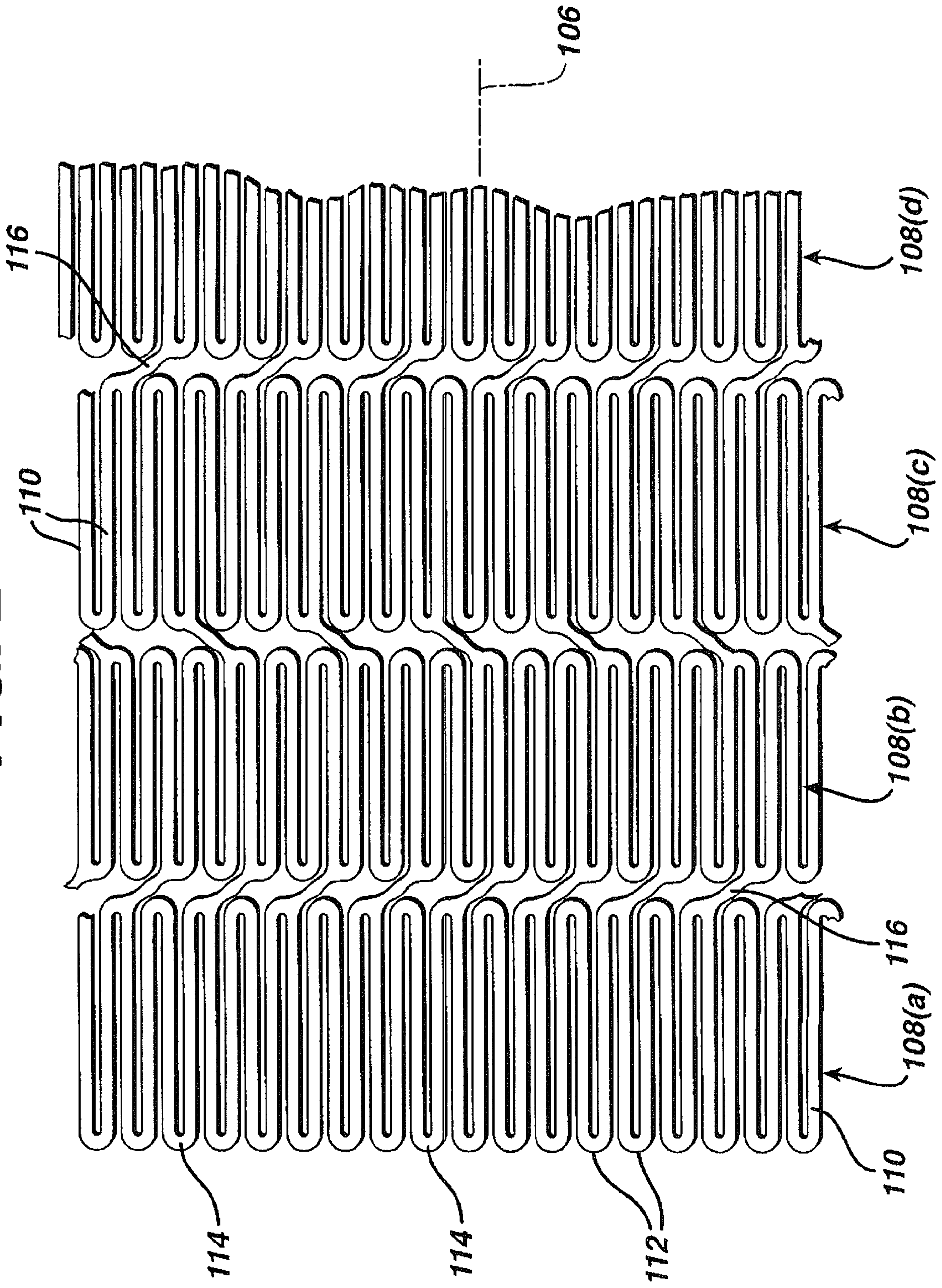
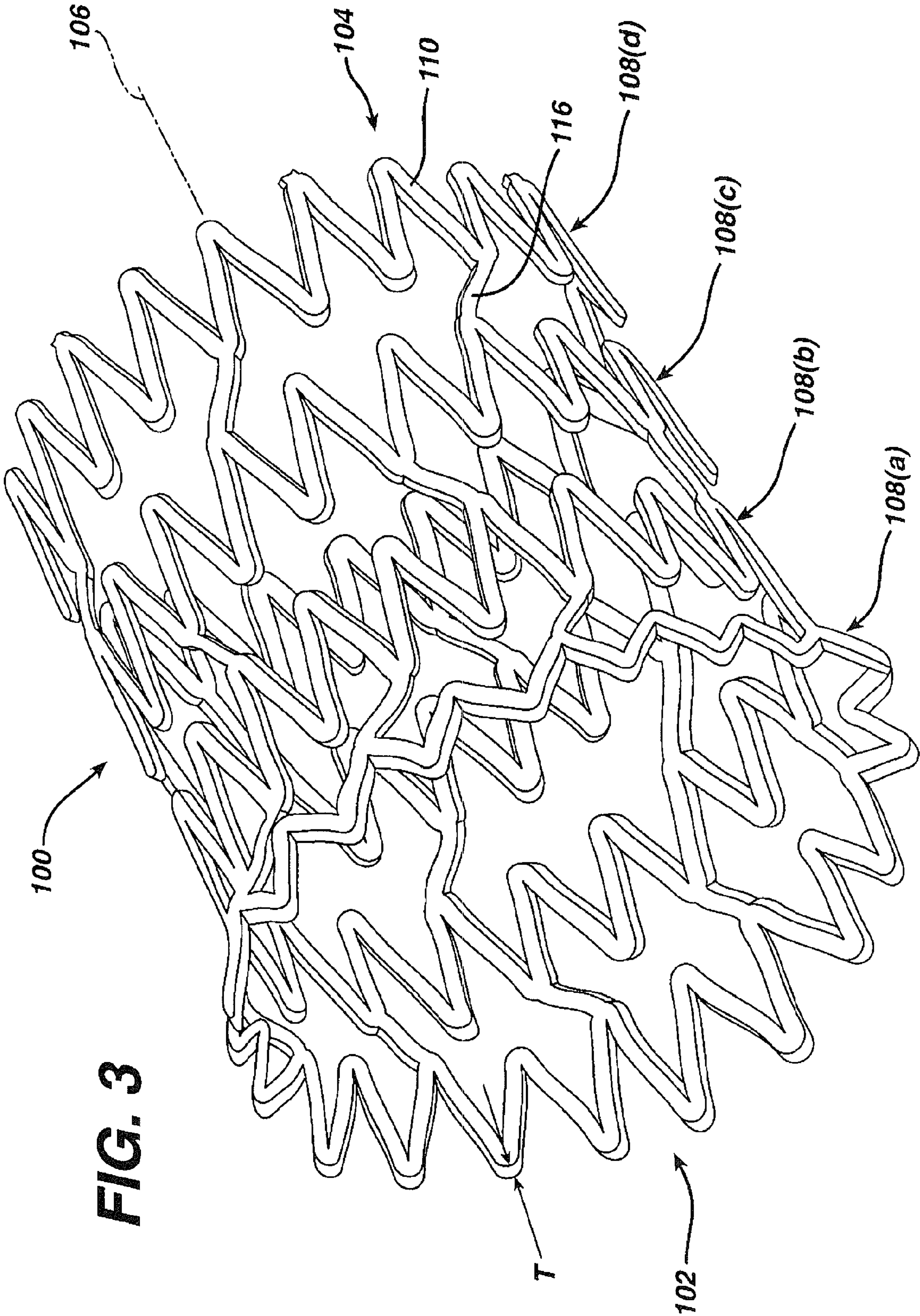



FIG. 2





**FIG. 3**

**FIG. 4**

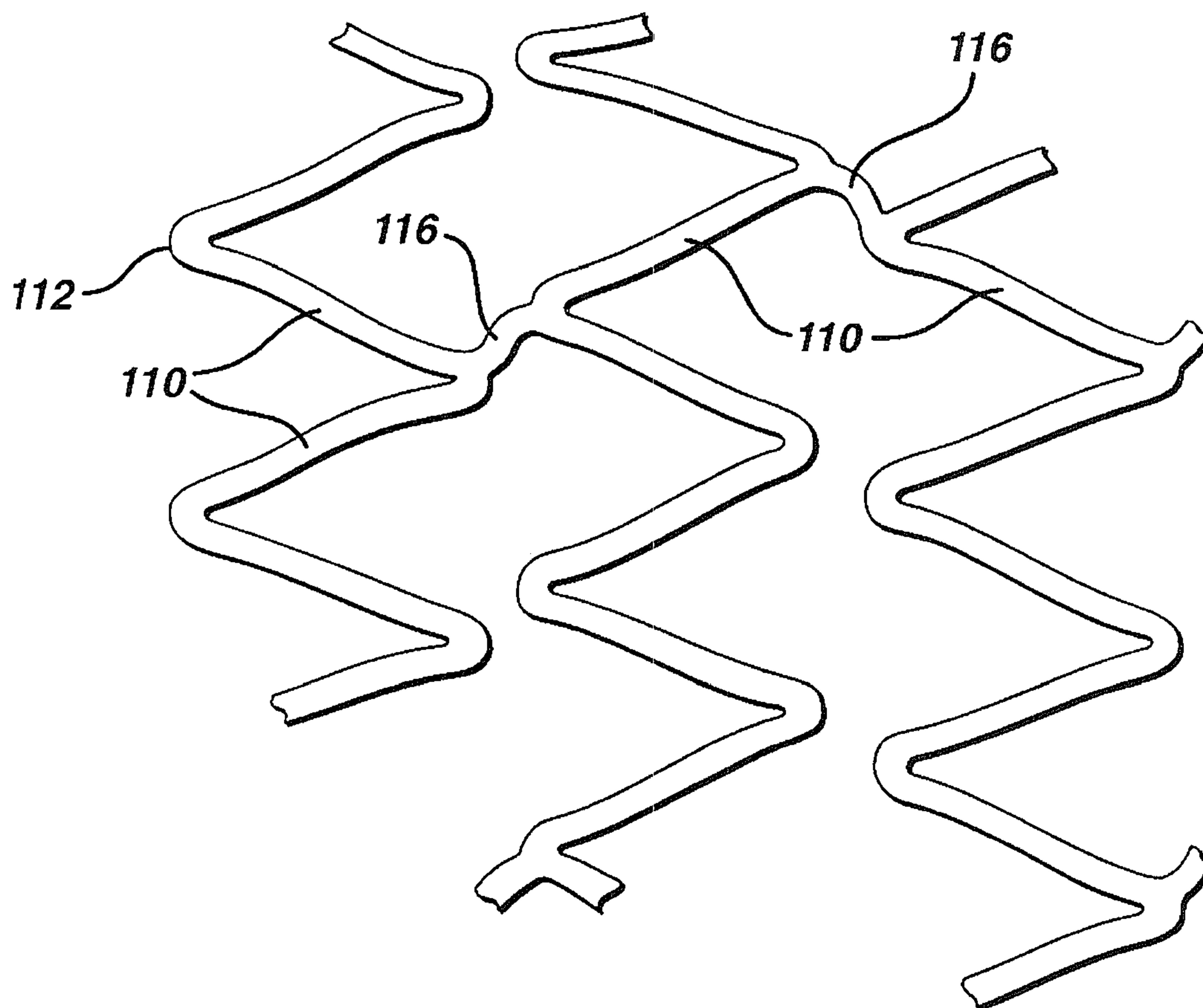
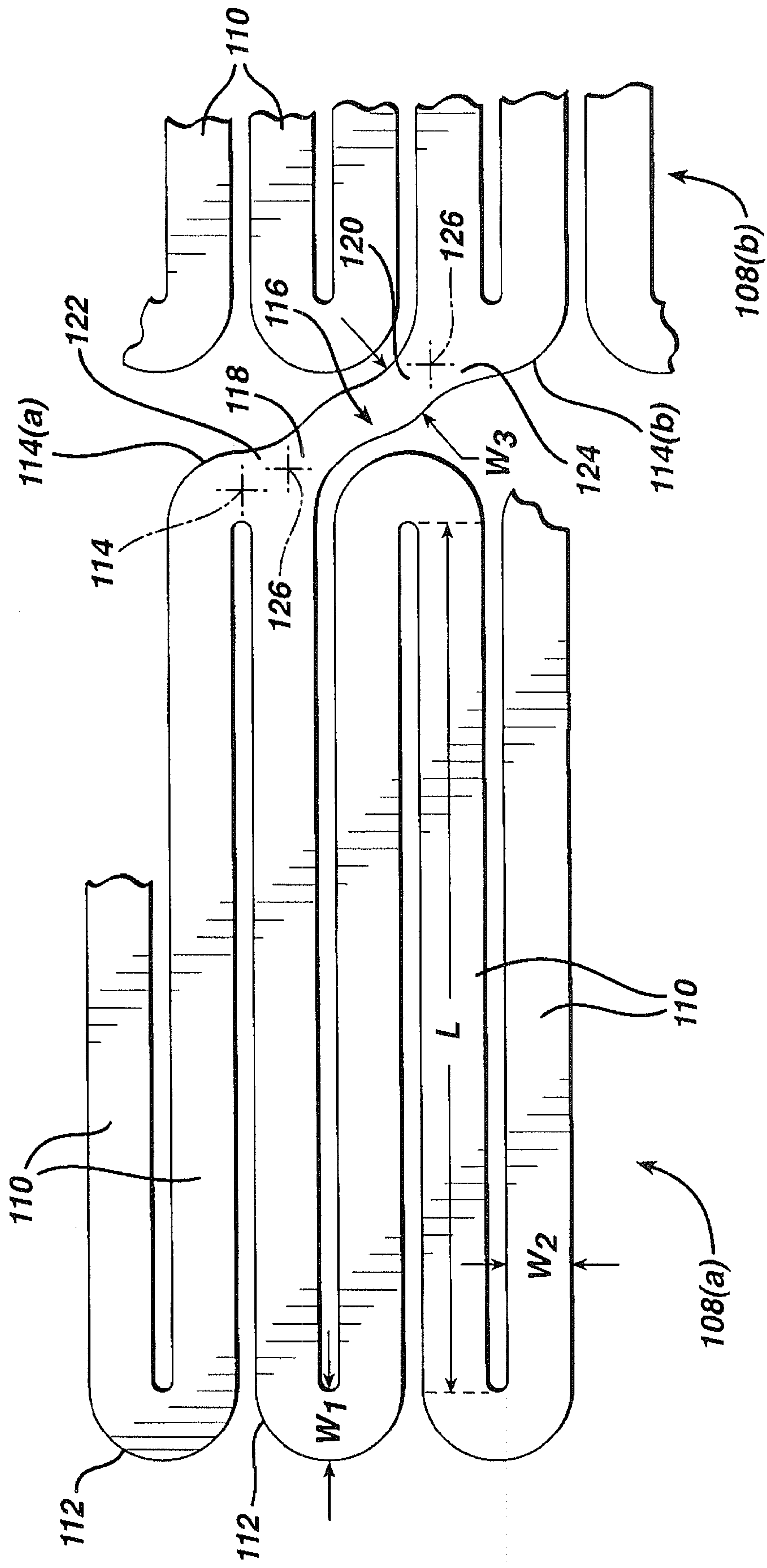
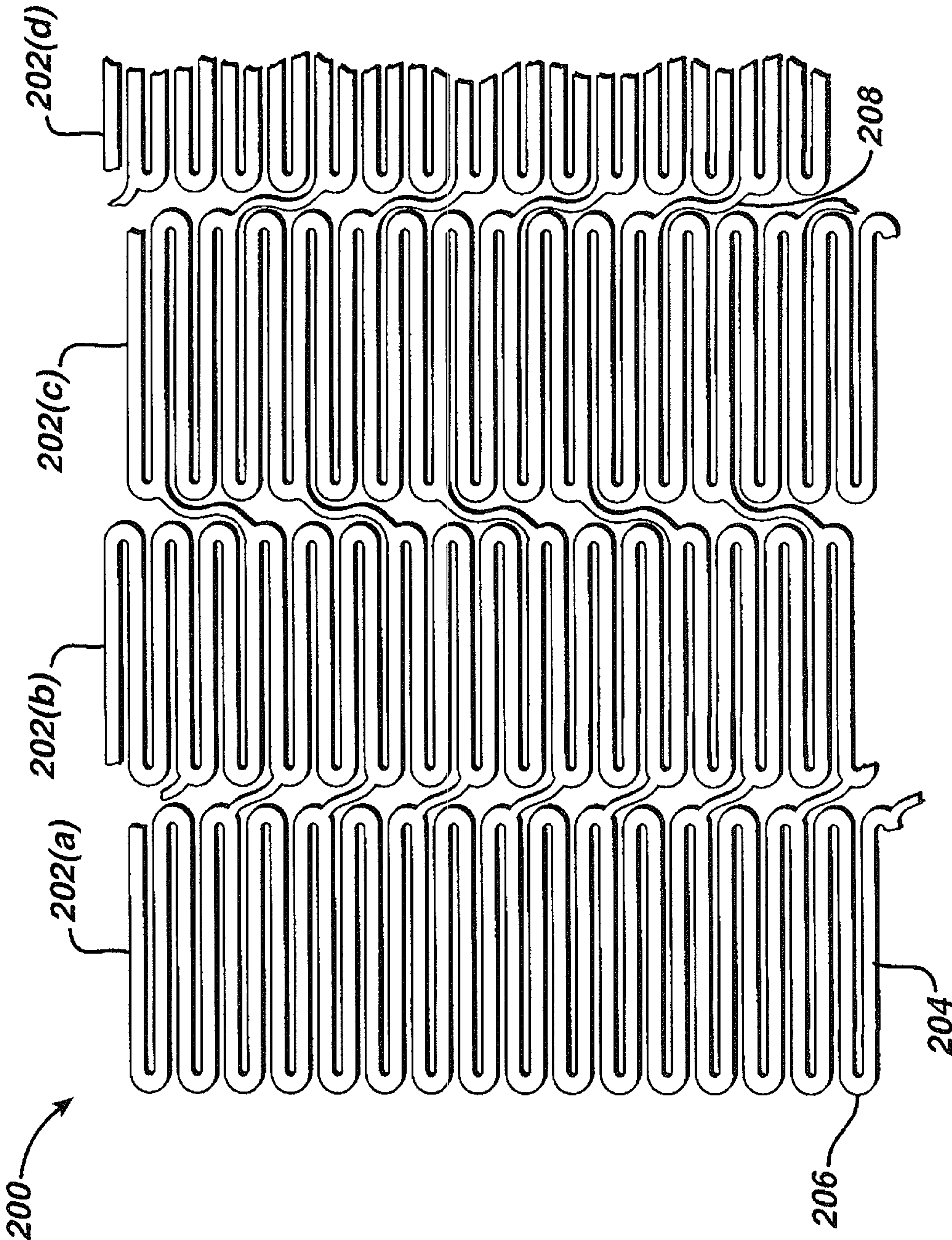



FIG. 5



**FIG. 6**





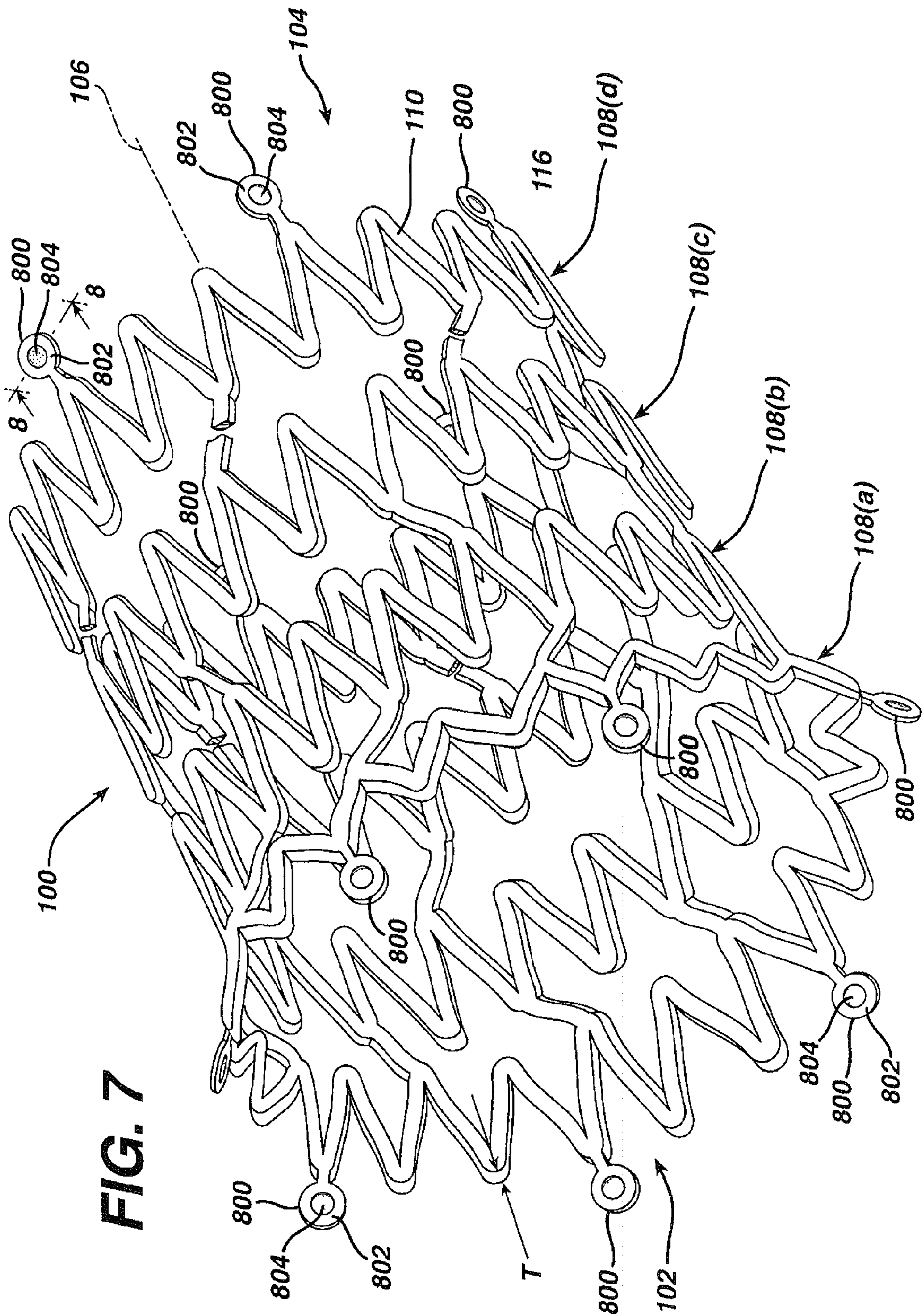

**FIG. 7**

**FIG. 8**

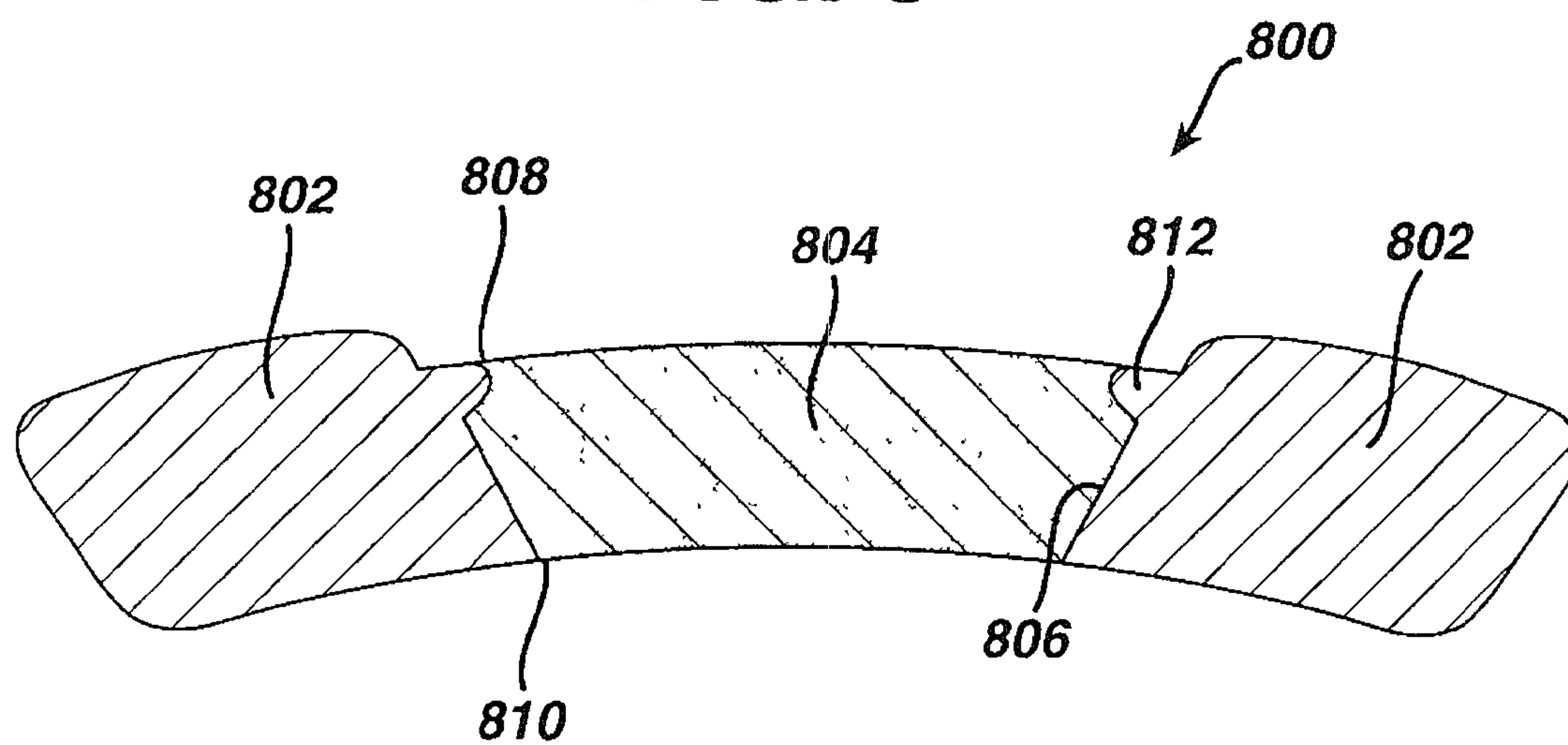

FIG. 9

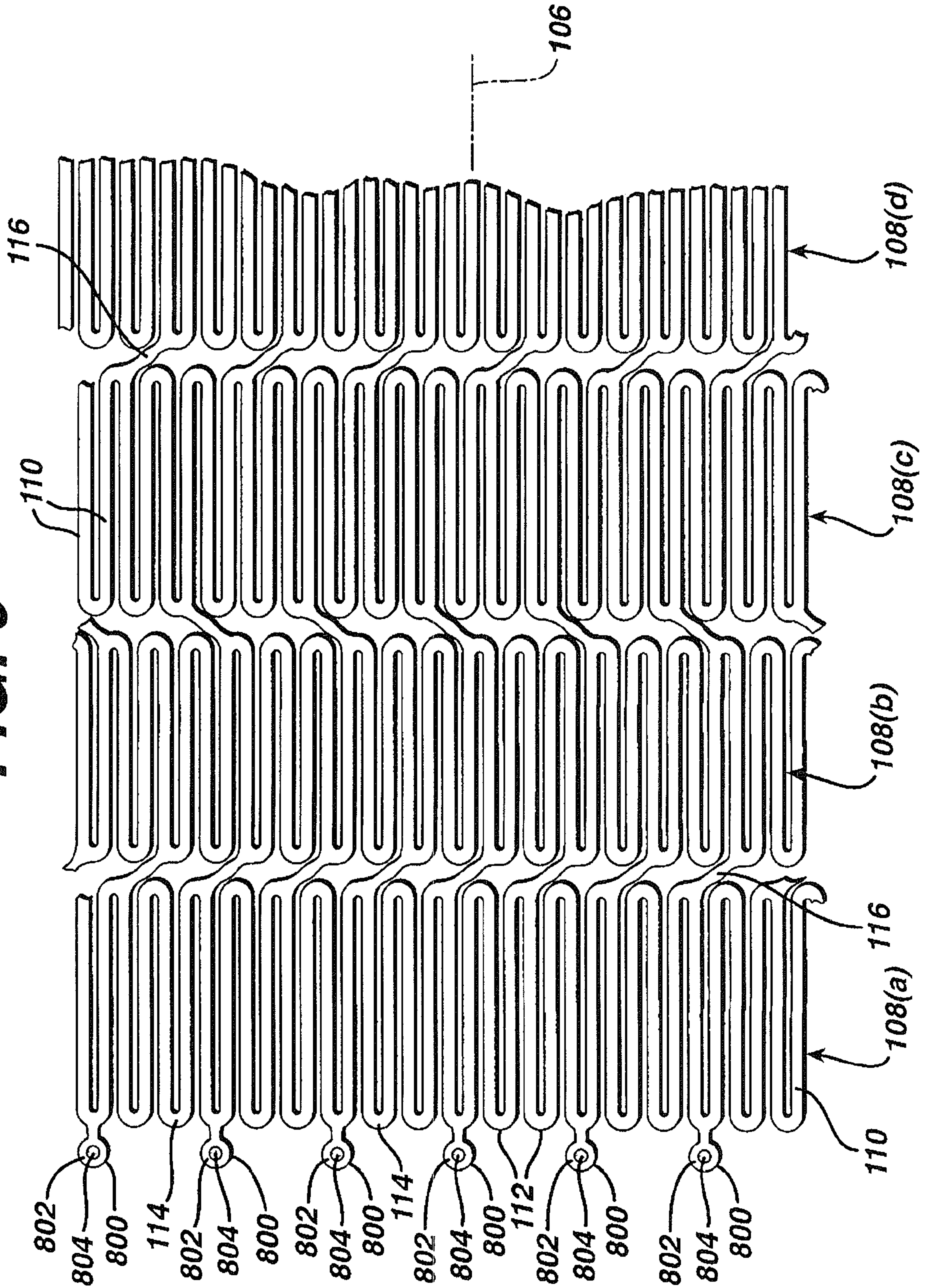



FIG. 10

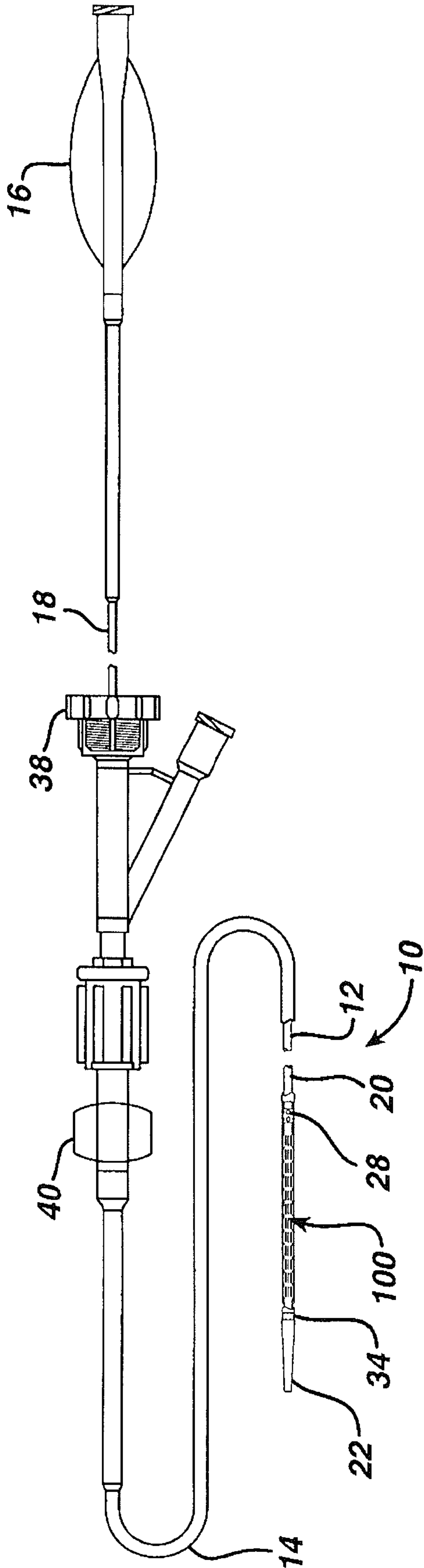

FIG. 11

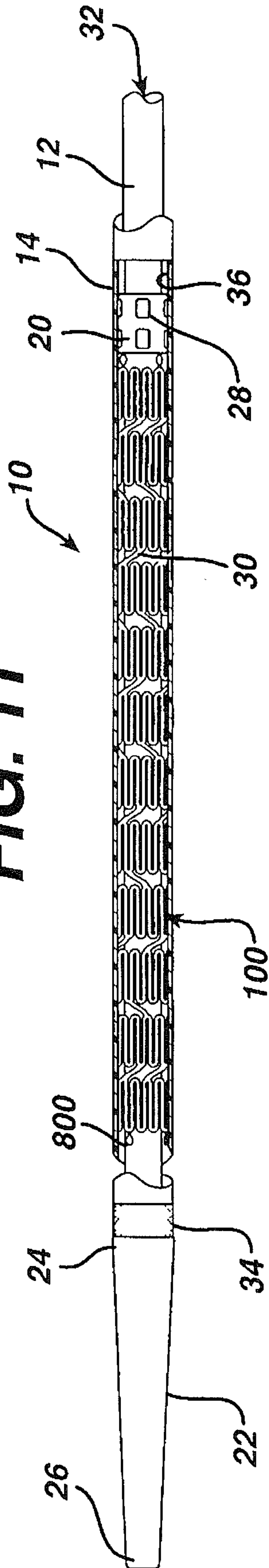

FIG. 12

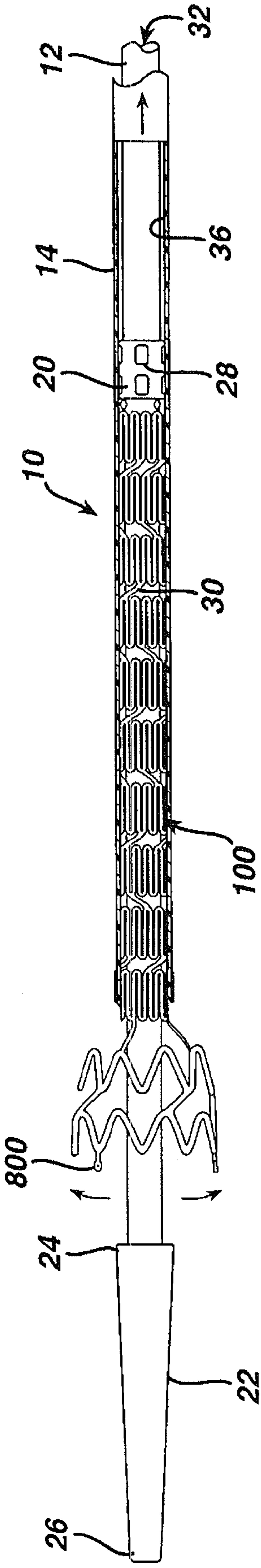
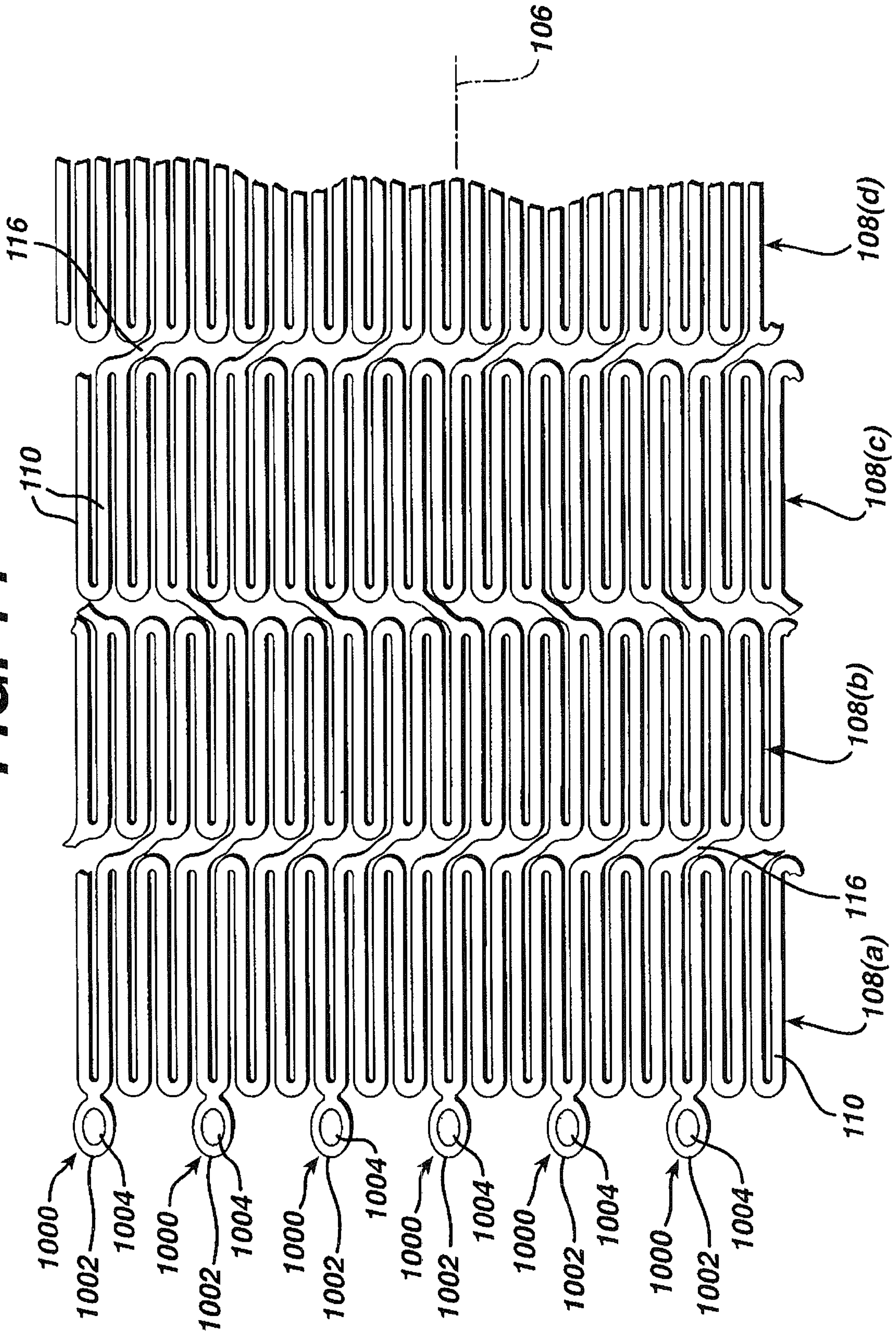





FIG. 14





## LOW PROFILE IMPROVED RADIOCAPACITY INTRALUMINAL MEDICAL DEVICE

### CROSS REFERENCE TO RELATED APPLICATIONS

This application is a divisional of U.S. patent application Ser. No. 10/127,191, now U.S. Pat. No. 8,197,535, which is a continuation-in-part application of U.S. patent application Ser. No. 09/884,729 filed Jun. 19, 2001, now U.S. Pat. No. 6,863,685.

### BACKGROUND OF THE INVENTION

#### 1. Field of the Invention

The present invention relates to intraluminal devices, and more particularly to intraluminal devices, such as stents, incorporating integral markers for increasing the radiopacity thereof.

#### 2. Discussion of Related Art

Percutaneous transluminal angioplasty (PTA) is a therapeutic medical procedure used to increase blood flow through an artery. In this procedure, the angioplasty balloon is inflated within the stenosed vessel, or body passageway, in order to shear and disrupt the wall components of the vessel to obtain an enlarged lumen. With respect to arterial stenosed lesions, the relatively incompressible plaque remains unaltered, while the more elastic medial and adventitial layers of the body passageway stretch around the plaque. This process produces dissection, or a splitting and tearing, of the body passageway wall layers, wherein the intima, or internal surface of the artery or body passageway, suffers fissuring. This dissection forms a "flap" of underlying tissue which may reduce the blood flow through the lumen, or completely block the lumen. Typically, the distending intraluminal pressure within the body passageway can hold the disrupted layer, or flap, in place. If the intimal flap created by the balloon dilation procedure is not maintained in place against the expanded intima, the intimal flap can fold down into the lumen and close off the lumen, or may even become detached and enter the body passageway. When the intimal flap closes off the body passageway, immediate surgery is necessary to correct the problem.

Recently, transluminal prostheses have been widely used in the medical arts for implantation in blood vessels, biliary ducts, or other similar organs of the living body. These prostheses are commonly referred to as stents and are used to maintain, open, or dilate tubular structures. An example of a commonly used stent is given in U.S. Pat. No. 4,733,665 to Palmaz. Such stents are often referred to as balloon expandable stents. Typically the stent is made from a solid tube of stainless steel. Thereafter, a series of cuts are made in the wall of the stent. The stent has a first smaller diameter which permits the stent to be delivered through the human vasculature by being crimped onto a balloon catheter. The stent also has a second, expanded diameter, upon application of a radially, outwardly directed force, by the balloon catheter, from the interior of the tubular shaped member.

However, one concern with such stents is that they are often impractical for use in some vessels such as the carotid artery. The carotid artery is easily accessible from the exterior of the human body, and is close to the surface of the skin. A patient having a balloon expandable stent made from stainless steel or the like, placed in their carotid artery, might be susceptible to severe injury through day to day activity. A sufficient force placed on the patient's neck could cause the stent to collapse, resulting in injury to the patient. In order to prevent this,

self-expanding stents have been proposed for use in such vessels. Self-expanding stents act like springs and will recover to their expanded or implanted configuration after being crushed.

5 One type of self-expanding stent is disclosed in U.S. Pat. No. 4,655,771. The stent disclosed in U.S. Pat. No. 4,655,771 has a radially and axially flexible, elastic tubular body with a predetermined diameter that is variable under axial movement of the ends of the body relative to each other and which  
10 is composed of a plurality of individually rigid but flexible and elastic thread elements defining a radially self-expanding helix. This type of stent is known in the art as a "braided stent" and is so designated herein. Placement of such stents in a body vessel can be achieved by a device which comprises an  
15 outer catheter for holding the stent at its distal end, and an inner piston which pushes the stent forward once it is in position.

However, braided stents have many disadvantages. They typically do not have the necessary radial strength to effectively hold open a diseased vessel. In addition, the plurality of  
20 wires or fibers used to make such stents could become dangerous if separated from the body of the stent, where they could pierce through the vessel. Therefore, there has been a desire to have a self-expanding stent which is cut from a tube of metal, which is the common manufacturing method for  
25 many commercially available balloon-expandable stents. In order to manufacture a self-expanding stent cut from a tube, the alloy used would preferably exhibit superelastic or pseudoelastic characteristics at body temperature, so that it is  
30 crush recoverable.

The prior art makes reference to the use of alloys such as Nitinol (Ni—Ti alloy), which have shape memory and/or superelastic characteristics, in medical devices which are designed to be inserted into a patient's body. The shape  
35 memory characteristics allow the devices to be deformed to facilitate their insertion into a body lumen or cavity and then be heated within the body so that the device returns to its original shape. Superelastic characteristics, on the other hand, generally allow the metal to be deformed and restrained  
40 in the deformed condition to facilitate the insertion of the medical device containing the metal into a patient's body, with such deformation causing the phase transformation. Once within the body lumen, the restraint on the superelastic member can be removed, thereby reducing the stress therein  
45 so that the superelastic member can return to its original un-deformed shape by the transformation back to the original phase.

Alloys having shape memory/superelastic characteristics generally have at least two phases. These phases are a mar-  
50 tensite phase, which has a relatively low tensile strength and which is stable at relatively low temperatures, and an austenite phase, which has a relatively high tensile strength and which is stable at temperatures higher than the martensite phase.

55 Shape memory characteristics are imparted to the alloy by heating the metal at a temperature above which the transformation from the martensite phase to the austenite phase is complete, i.e. a temperature above which the austenite phase is stable (the  $A_f$  temperature). The shape of the metal during  
60 this heat treatment is the shape "remembered." The heat-treated metal is cooled to a temperature at which the martensite phase is stable, causing the austenite phase to transform to the martensite phase. The metal in the martensite phase is then plastically deformed, e.g. to facilitate the entry thereof into a  
65 patient's body. Subsequent heating of the deformed martensite phase to a temperature above the martensite to austenite transformation temperature causes the deformed martensite



phase to transform to the austenite phase, and during this phase transformation the metal reverts back to its original shape if unrestrained. If restrained, the metal will remain martensitic until the restraint is removed.

Methods of using the shape memory characteristics of these alloys in medical devices intended to be placed within a patient's body present operational difficulties. For example, with shape memory alloys having a stable martensite temperature below body temperature, it is frequently difficult to maintain the temperature of the medical device containing such an alloy sufficiently below body temperature to prevent the transformation of the martensite phase to the austenite phase when the device was being inserted into a patient's body. With intravascular devices formed of shape memory alloys having martensite-to-austenite transformation temperatures well above body temperature, the devices can be introduced into a patient's body with little or no problem, but they must be heated to the martensite-to-austenite transformation temperature which is frequently high enough to cause tissue damage.

When stress is applied to a specimen of a metal such as Nitinol exhibiting superelastic characteristics at a temperature above which the austenite is stable (i.e. the temperature at which the transformation of martensite phase to the austenite phase is complete), the specimen deforms elastically until it reaches a particular stress level where the alloy then undergoes a stress-induced phase transformation from the austenite phase to the martensite phase. As the phase transformation proceeds, the alloy undergoes significant increases in strain but with little or no corresponding increases in stress. The strain increases while the stress remains essentially constant until the transformation of the austenite phase to the martensite phase is complete. Thereafter, further increases in stress are necessary to cause further deformation. The martensitic metal first deforms elastically upon the application of additional stress and then plastically with permanent residual deformation.

If the load on the specimen is removed before any permanent deformation has occurred, the martensitic specimen will elastically recover and transform back to the austenite phase. The reduction in stress first causes a decrease in strain. As stress reduction reaches the level at which the martensite phase transforms back into the austenite phase, the stress level in the specimen will remain essentially constant (but substantially less than the constant stress level at which the austenite transforms to the martensite) until the transformation back to the austenite phase is complete, i.e. there is significant recovery in strain with only negligible corresponding stress reduction. After the transformation back to austenite is complete, further stress reduction results in elastic strain reduction. This ability to incur significant strain at relatively constant stress upon the application of a load, and to recover from the deformation upon the removal of the load, is commonly referred to as superelasticity or pseudoelasticity. It is this property of the material which makes it useful in manufacturing tube cut self-expanding stents.

The prior art makes reference to the use of metal alloys having superelastic characteristics in medical devices which are intended to be inserted or otherwise used within a patient's body. See for example, U.S. Pat. No. 4,665,905 to Jervis and U.S. Pat. No. 4,925,445 to Sakamoto et al. However, the prior art has yet to disclose any suitable tube-cut self-expanding stents. In addition, many of the prior art stents lacked the necessary rigidity or hoop strength to keep the body vessel open. In addition, many of the prior art stents have large openings at their expanded diameter. The smaller the openings are on an expanded stent, the more plaque or

other deposits it can trap between the stent and the vessel wall. Trapping these deposits is important to the continuing health of the patient in that it helps prevent plaque prolapse into the vessel, restenosis of the vessel it is implanted into, and strokes caused by the release of embolic particles into the bloodstream.

One additional concern with stents and with other medical devices formed from superelastic materials, is that they may exhibit reduced radiopacity under X-ray fluoroscopy. To overcome this problem, it is common practice to attach markers, made from highly radiopaque materials, to the stent, or to use radiopaque materials in plating or coating processes. Those materials typically include gold, platinum, or tantalum. The prior art makes reference to these markers or processes in U.S. Pat. No. 5,632,771 to Boatman et al., U.S. Pat. No. 6,022,374 to Imran, U.S. Pat. No. 5,741,327 to Frantzen, U.S. Pat. No. 5,725,572 to Lam et al., and U.S. Pat. No. 5,800,526 to Anderson et al. However, due to the size of the markers and the relative position of the materials forming the markers in the galvanic series versus the position of the base metal of the stent in the galvanic series, there is a certain challenge to overcome; namely, that of galvanic corrosion. Also, the size of the markers increases the overall profile of the stent. In addition, typical markers are not integral to the stent and thus may interfere with the overall performance of the stent as well as become dislodged from the stent. Also, typical markers are used to indicate relative position within the lumen and not whether the device is in the deployed or undepolyed position.

#### SUMMARY OF THE INVENTION

The present invention overcomes many of the disadvantages associated with reduced radiopacity exhibited by self-expanding stents, balloon-expandable stents, and other medical devices as briefly discussed above.

In accordance with one aspect, the present invention is directed to an intraluminal medical device. The intraluminal medical device comprises a substantially tubular member having open ends, and a first diameter for insertion into a lumen of a vessel and a second diameter for anchoring in the lumen of the vessel and at least one marker connected to at least one end of the substantially tubular member, the at least one marker comprising a marker housing and a marker insert. The marker housing comprises a substantially circular shape with flattened sections. The marker housing and the marker insert have a radius of curvature equal to the radius of curvature of the substantially tubular member.

In accordance with another aspect, the present invention is directed to an intraluminal medical device. The intraluminal device comprises a thin-walled, substantially tubular member having open ends, and a first diameter for insertion into a lumen of a vessel and a second diameter for anchoring in the lumen of the vessel, the thin-walled tubular member comprising a superelastic alloy and at least one marker connected to at least one end of the thin-walled, substantially tubular member, the at least one marker comprising a marker housing and a marker insert. The marker housing comprises a substantially circular shape with flattened sections. The marker housing and the marker insert have a radius of curvature equal to the radius of curvature of the substantially tubular member.

In accordance with another aspect, the present invention is directed to a stent. The stent comprises a thin-walled, substantially tubular member having open ends, and a first diameter for insertion into a lumen of a vessel and a second diameter for anchoring in the lumen of the vessel, the thin-walled tubular member comprising a superelastic alloy and at least



one marker connected to at least one end of the thin-walled, substantially tubular member, the at least one marker comprising a marker housing and a marker insert. The marker housing comprises a substantially circular shape with flattened sections. The marker housing and the marker insert have a radius of curvature equal to the radius of curvature of the substantially tubular member.

In accordance with another aspect, the present invention is directed to an intraluminal medical device. The intraluminal medical device comprises a substantially tubular member having open ends, and a first diameter for insertion into a lumen of a vessel and a second diameter for anchoring in the lumen of the vessel. The intraluminal medical device also comprises at least one marker connected to at least one end of the substantially tubular member. The at least one marker comprises a marker housing having a substantially oval shape and a marker insert having a substantially oval shape. The marker housing and the marker insert have a radius of curvature equal to the radius of curvature of the substantially tubular member.

The improved radiopacity intraluminal medical device of the present invention utilizes high radiopacity markers to ensure proper positioning of the device within a lumen. The markers comprise a housing which is integral to the device itself, thereby ensuring minimal interference with deployment and operation of the device. The housings are also shaped to minimally impact the overall profile of the stent. For example, a properly shaped housing allows a stent to maintain a radiopaque stent marker size utilized in a seven French delivery system to fit into a six French delivery system. The markers also comprise a properly sized marker insert having a higher radiopacity than the material forming the device itself. The marker insert is sized to match the curvature of the housing thereby ensuring a tight and unobtrusive fit. The marker inserts are made from a material close in the galvanic series to the device material and sized to substantially minimize the effect of galvanic corrosion.

The improved radiopacity intraluminal medical device of the present invention provides for more precise placement and post-procedural visualization in a lumen by increasing the radiopacity of the device under X-ray fluoroscopy. Given that the marker housings are integral to the device, they are simpler and less expensive to manufacture than markers that have to be attached in a separate process.

The improved radiopacity intraluminal medical device of the present invention is manufactured utilizing a process which ensures that the marker insert is securely positioned within the marker housing. The marker housing is laser cut from the same tube and is integral to the device. As a result of the laser cutting process, the hole in the marker housing is conical in the radial direction with the outer surface diameter being larger than the inner surface diameter. The conical tapering effect in the marker housing is beneficial in providing an interference fit between the marker insert and the marker housing to prevent the marker insert from being dislodged once the device is deployed.

The marker inserts are loaded into a crimped device by punching a disk from annealed ribbon stock and shaping it to have the same radius of curvature as the marker housing. Once the disk is loaded into the marker housing, a coining process is used to properly seat the marker below the surface of the housing. The coining punch is also shaped to maintain the same radius of curvature as the marker housing. The coining process deforms the marker housing material to form a protrusion, thereby locking in the insert or disk.

## BRIEF DESCRIPTION OF THE DRAWINGS

The foregoing and other aspects of the present invention will best be appreciated with reference to the detailed description of the invention in conjunction with the accompanying drawings, wherein:

FIG. 1 is a perspective view of an exemplary stent in its compressed state which may be utilized in conjunction with the present invention.

FIG. 2 is a sectional, flat view of the stent shown in FIG. 1.

FIG. 3 is a perspective view of the stent shown in FIG. 1 but showing it in its expanded state.

FIG. 4 is an enlarged sectional view of the stent shown in FIG. 3.

FIG. 5 is an enlarged view of section of the stent shown in FIG. 2.

FIG. 6 is a view similar to that of FIG. 2 but showing an alternate embodiment of the stent.

FIG. 7 is a perspective view of the stent of FIG. 1 having a plurality of markers attached to the ends thereof in accordance with the present invention.

FIG. 8 is a cross-sectional view of a marker in accordance with the present invention.

FIG. 9 is an enlarged perspective view of an end of the stent with the markers forming a substantially straight line in accordance with the present invention.

FIG. 10 is a simplified partial cross-sectional view of a stent delivery apparatus having a stent loaded therein, which can be used with a stent made in accordance with the present invention.

FIG. 11 is a view similar to that of FIG. 10 but showing an enlarged view of the distal end of the apparatus.

FIG. 12 is a perspective view of an end of the stent with the markers in a partially expanded form as it emerges from the delivery apparatus in accordance with the present invention.

FIG. 13 is an enlarged perspective view of an end of the stent with modified markers in accordance with an alternate exemplary embodiment of the present invention.

FIG. 14 is an enlarged perspective view of an end of the stent with modified markers in accordance with another alternate exemplary embodiment of the present invention.

## DETAILED DESCRIPTION OF THE PREFERRED EMBODIMENTS

While the present invention may be used on or in connection with any number of medical devices, including stents, for ease of explanation, one exemplary embodiment of the invention with respect to self-expanding Nitinol stents will be described in detail. There is illustrated in FIGS. 1 and 2, a stent 100, which may be utilized in connection with the present invention. FIGS. 1 and 2 illustrate the exemplary stent 100 in its unexpanded or compressed state. The stent 100 is preferably made from a superelastic alloy such as Nitinol. Most preferably, the stent 100 is made from an alloy comprising from about 50.0 percent (as used herein these percentages refer to weight percentages) Ni to about 60 percent Ni, and more preferably about 55.8 percent Ni, with the remainder of the alloy being Ti. Preferably, the stent 100 is designed such that it is superelastic at body temperature, and preferably has an Af in the range from about twenty-four degrees C. to about thirty-seven degrees C. The superelastic design of the stent 100 makes it crush recoverable, which, as discussed above, makes it useful as a stent or frame for any number of vascular devices in different applications.

Stent 100 is a tubular member having front and back open ends 102 and 104 and a longitudinal axis 106 extending



therebetween. The tubular member has a first smaller diameter, FIGS. 1 and 2, for insertion into a patient and navigation through the vessels, and a second larger diameter, FIGS. 3 and 4, for deployment into the target area of a vessel. The tubular member is made from a plurality of adjacent hoops 108, FIG. 1 showing hoops 108(a)-108(d), extending between the front and back ends 102 and 104. The hoops 108 include a plurality of longitudinal struts 110 and a plurality of loops 112 connecting adjacent struts, wherein adjacent struts are connected at opposite ends so as to form a substantially S or Z shape pattern. The loops 112 are curved, substantially semi-circular with symmetrical sections about their centers 114.

Stent 100 further includes a plurality of bridges 116 which connect adjacent hoops 108 and which can best be described in detail by referring to FIG. 5. Each bridge 116 has two ends 118 and 120. The bridges 116 have one end attached to one strut and/or loop, and another end attached to a strut and/or loop on an adjacent hoop. The bridges 116 connect adjacent struts together at bridge to loop connection points 122 and 124. For example, bridge end 118 is connected to loop 114(a) at bridge to loop connection point 122, and bridge end 120 is connected to loop 114(b) at bridge to loop connection point 124. Each bridge to loop connection point has a center 126. The bridge to loop connection points are separated angularly with respect to the longitudinal axis. That is, the connection points are not immediately opposite each other. Essentially, one could not draw a straight line between the connection points, wherein such line would be parallel to the longitudinal axis of the stent.

The above described geometry helps to better distribute strain throughout the stent, prevents metal to metal contact when the stent is bent, and minimizes the opening size between the struts, loops and bridges. The number of and nature of the design of the struts, loops and bridges are important factors when determining the working properties and fatigue life properties of the stent. It was previously thought that in order to improve the rigidity of the stent, that struts should be large, and therefore there should be fewer struts per hoop. However, it has now been discovered that stents having smaller struts and more struts per hoop actually improve the construction of the stent and provide greater rigidity. Preferably, each hoop has between twenty-four to thirty-six or more struts. It has been determined that a stent having a ratio of number of struts per hoop to strut length L (in inches) which is greater than four hundred has increased rigidity over prior art stents, which typically have a ratio of under two hundred. The length of a strut is measured in its compressed state parallel to the longitudinal axis 106 of the stent 100 as illustrated in FIG. 1.

As seen from a comparison of FIGS. 2 and 3, the geometry of the stent 100 changes quite significantly as the stent 100 is deployed from its un-expanded state to its expanded state. As a stent undergoes diametric change, the strut angle and strain levels in the loops and bridges are affected. Preferably, all of the stent features will strain in a predictable manor so that the stent is reliable and uniform in strength. In addition, it is preferable to minimize the maximum strain experienced by struts loops and bridges, since Nitinol properties are more generally limited by strain rather than by stress. As will be discussed in greater detail below, the stent sits in the delivery system in its un-expanded state as shown in FIGS. 10 and 11. As the stent is deployed, it is allowed to expand towards its expanded state, as shown in FIG. 3, which preferably has a diameter which is the same or larger than the diameter of the target vessel. Nitinol stents made from wire deploy in much the same manner, and are dependent upon the same design constraints, as laser cut stents. Stainless steel stents deploy

similarly in terms of geometric changes as they are assisted by forces from balloons or other devices.

In trying to minimize the maximum strain experienced by features of the stent, the present invention utilizes structural geometries which distribute strain to areas of the stent which are less susceptible to failure than others. For example, one of the most vulnerable areas of the stent is the inside radius of the connecting loops. The connecting loops undergo the most deformation of all the stent features. The inside radius of the loop would normally be the area with the highest level of strain on the stent. This area is also critical in that it is usually the smallest radius on the stent. Stress concentrations are generally controlled or minimized by maintaining the largest radii possible. Similarly, we want to minimize local strain concentrations on the bridge and bridge connection points. One way to accomplish this is to utilize the largest possible radii while maintaining feature widths which are consistent with applied forces. Another consideration is to minimize the maximum open area of the stent. Efficient utilization of the original tube from which the stent is cut increases stent strength and its ability to trap embolic material.

Many of these design objectives have been accomplished by an exemplary embodiment of the present invention, illustrated in FIGS. 1, 2 and 5. As seen from these figures, the most compact designs which maintain the largest radii at the loop to bridge connections are non-symmetric with respect to the centerline of the strut connecting loop. That is, loop to bridge connection point centers 126 are offset from the center 114 of the loops 112 to which they are attached. This feature is particularly advantageous for stents having large expansion ratios, which in turn requires them to have extreme bending requirements where large elastic strains are required. Nitinol can withstand extremely large amounts of elastic strain deformation, so the above features are well suited to stents made from this alloy. This feature allows for maximum utilization of Ni—Ti or other material properties to enhance radial strength, to improve stent strength uniformity, to improve fatigue life by minimizing local strain levels, to allow for smaller open areas which enhance entrapment of embolic material, and to improve stent apposition in irregular vessel wall shapes and curves.

As seen in FIG. 5, stent 100 comprises strut connecting loops 112 having a width W1, as measured at the center 114 parallel to axis 106, which are greater than the strut widths W2, as measured perpendicular to axis 106 itself. In fact, it is preferable that the thickness of the loops vary so that they are thickest near their centers. This increases strain deformation at the strut and reduces the maximum strain levels at the extreme radii of the loop. This reduces the risk of stent failure and allows one to maximize radial strength properties. This feature is particularly advantageous for stents having large expansion ratios, which in turn requires them to have extreme bending requirements where large elastic strains are required. Nitinol can withstand extremely large amounts of elastic strain deformation, so the above features are well suited to stents made from this alloy. As stated above, this feature allows for maximum utilization of Ni—Ti or other material properties to enhance radial strength, to improve stent strength uniformity, to improve fatigue life by minimizing local strain levels, to allow for smaller open areas which enhance entrapment of embolic material, and to improve stent apposition in irregular vessel wall shapes and curves.

As mentioned above, bridge geometry changes as a stent is deployed from its compressed state to its expanded state and vice-versa. As a stent undergoes diametric change, strut angle and loop strain is affected. Since the bridges are connected to either the loops, struts or both, they are affected. Twisting of



one end of the stent with respect to the other, while loaded in the stent delivery system, should be avoided. Local torque delivered to the bridge ends displaces the bridge geometry. If the bridge design is duplicated around the stent perimeter, this displacement causes rotational shifting of the two loops being connected by the bridges. If the bridge design is duplicated throughout the stent, as in the present invention, this shift will occur down the length of the stent. This is a cumulative effect as one considers rotation of one end with respect to the other upon deployment. A stent delivery system, such as the one described below, will deploy the distal end first, then allow the proximal end to expand. It would be undesirable to allow the distal end to anchor into the vessel wall while holding the stent fixed in rotation, then release the proximal end. This could cause the stent to twist or whip in rotation to equilibrium after it is at least partially deployed within the vessel. Such whipping action may cause damage to the vessel.

However, one exemplary embodiment of the present invention, as illustrated in FIGS. 1 and 2, reduces the chance of such events happening when deploying the stent. By mirroring the bridge geometry longitudinally down the stent, the rotational shift of the Z-sections or S-sections may be made to alternate and will minimize large rotational changes between any two points on a given stent during deployment or constraint. That is, the bridges 116 connecting loop 108(b) to loop 108(c) are angled upwardly from left to right, while the bridges connecting loop 108(c) to loop 108(d) are angled downwardly from left to right. This alternating pattern is repeated down the length of the stent 100. This alternating pattern of bridge slopes improves the torsional characteristics of the stent so as to minimize any twisting or rotation of the stent with respect to any two hoops. This alternating bridge slope is particularly beneficial if the stent starts to twist in vivo. As the stent twists, the diameter of the stent will change. Alternating bridge slopes tend to minimize this effect. The diameter of a stent having bridges which are all sloped in the same direction will tend to grow if twisted in one direction and shrink if twisted in the other direction. With alternating bridge slopes this effect is minimized and localized.

The feature is particularly advantageous for stents having large expansion ratios, which in turn requires them to have extreme bending requirements where large elastic strains are required. Nitinol, as stated above, can withstand extremely large amounts of elastic strain deformation, so the above features are well suited to stents made from this alloy. This feature allows for maximum utilization of Ni—Ti or other material properties to enhance radial strength, to improve stent strength uniformity, to improve fatigue life by minimizing local strain levels, to allow for smaller open areas which enhance entrapment of embolic material, and to improve stent apposition in irregular vessel wall shapes and curves.

Preferably, stents are laser cut from small diameter tubing. For prior art stents, this manufacturing process led to designs with geometric features, such as struts, loops and bridges, having axial widths W2, W1 and W3, respectively, which are larger than the tube wall thickness T (illustrated in FIG. 3). When the stent is compressed, most of the bending occurs in the plane that is created if one were to cut longitudinally down the stent and flatten it out. However, for the individual bridges, loops and struts, which have widths greater than their thickness, there is a greater resistance to this in-plane bending than to out-of-plane bending. Because of this, the bridges and struts tend to twist, so that the stent as a whole may bend more easily. This twisting is a buckling condition which is unpredictable and can cause potentially high strain.

However, this problem has been solved in an exemplary embodiment of the present invention, as illustrated in FIGS.

1-5. As seen from these figures, the widths of the struts, hoops and bridges are equal to or less than the wall thickness of the tube. Therefore, substantially all bending and, therefore, all strains are “out-of-plane.” This minimizes twisting of the stent which minimizes or eliminates buckling and unpredictable strain conditions. This feature is particularly advantageous for stents having large expansion ratios, which in turn requires them to have extreme bending requirements where large elastic strains are required. Nitinol, as stated above, can withstand extremely large amounts of elastic strain deformation, so the above features are well suited to stents made from this alloy. This feature allows for maximum utilization of Ni—Ti or other material properties to enhance radial strength, to improve stent strength uniformity, to improve fatigue life by minimizing local strain levels, to allow for smaller open areas which enhance entrapment of embolic material, and to improve stent apposition in irregular vessel wall shapes and curves.

An alternate exemplary embodiment of a stent that may be utilized in conjunction with the present invention is illustrated in FIG. 6. FIG. 6 shows stent 200 which is similar to stent 100 illustrated in FIGS. 1-5. Stent 200 is made from a plurality of adjacent hoops 202, FIG. 6 showing hoops 202(a)-202(d). The hoops 202 include a plurality of longitudinal struts 204 and a plurality of loops 206 connecting adjacent struts, wherein adjacent struts are connected at opposite ends so as to form a substantially S or Z shape pattern. Stent 200 further includes a plurality of bridges 208 which connect adjacent hoops 202. As seen from the figure, bridges 208 are non-linear and curve between adjacent hoops. Having curved bridges allows the bridges to curve around the loops and struts so that the hoops can be placed closer together which in turn, minimizes the maximum open area of the stent and increases its radial strength as well. This can best be explained by referring to FIG. 4. The above described stent geometry attempts to minimize the largest circle which could be inscribed between the bridges, loops and struts, when the stent is expanded. Minimizing the size of this theoretical circle, greatly improves the stent because it is then better suited to trap embolic material once it is inserted into the patient.

As mentioned above, it is preferred that the stent of the present invention be made from a superelastic alloy and most preferably made of an alloy material having greater than 50.5 atomic percentage Nickel and the balance Titanium. Greater than 50.5 atomic percentage Nickel allows for an alloy in which the temperature at which the martensite phase transforms completely to the austenite phase (the Af temperature) is below human body temperature, and preferably is about twenty-four degrees C. to about thirty-seven degrees C., so that austenite is the only stable phase at body temperature.

In manufacturing the Nitinol stent, the material is first in the form of a tube. Nitinol tubing is commercially available from a number of suppliers including Nitinol Devices and Components, Fremont Calif. The tubular member is then loaded into a machine which will cut the predetermined pattern of the stent into the tube, as discussed above and as shown in the figures. Machines for cutting patterns in tubular devices to make stents or the like are well known to those of ordinary skill in the art and are commercially available. Such machines typically hold the metal tube between the open ends while a cutting laser, preferably under microprocessor control, cuts the pattern. The pattern dimensions and styles, laser positioning requirements, and other information are programmed into a microprocessor which controls all aspects of the process. After the stent pattern is cut, the stent is treated and polished using any number of methods or combination of methods well known to those skilled in the art. Lastly, the stent is then



cooled until it is completely martensitic, crimped down to its un-expanded diameter and then loaded into the sheath of the delivery apparatus.

As stated in previous sections of this application, markers having a radiopacity greater than that of the superelastic alloys may be utilized to facilitate more precise placement of the stent within the vasculature. In addition, markers may be utilized to determine when and if a stent is fully deployed. For example, by determining the spacing between the markers, one can determine if the deployed stent has achieved its maximum diameter and adjusted accordingly utilizing a tacking process. FIG. 7 illustrates an exemplary embodiment of the stent 100 illustrated in FIGS. 1-5 having at least one marker on each end thereof. In a preferred embodiment, a stent having thirty-six struts per hoop can accommodate six markers 800. Each marker 800 comprises a marker housing 802 and a marker insert 804. The marker insert 804 may be formed from any suitable biocompatible material having a high radiopacity under X-ray fluoroscopy. In other words, the marker inserts 804 should preferably have a radiopacity higher than that of the material comprising the stent 100. The addition of the marker housings 802 to the stent necessitates that the lengths of the struts in the last two hoops at each end of the stent 100 be longer than the strut lengths in the body of the stent to increase the fatigue life at the stent ends. The marker housings 802 are preferably cut from the same tube as the stent as briefly described above. Accordingly, the housings 802 are integral to the stent 100. Having the housings 802 integral to the stent 100 serves to ensure that the markers 800 do not interfere with the operation of the stent

FIG. 8 is a cross-sectional view of a marker housing 802. The housing 802 may be elliptical when observed from the outer surface as illustrated in FIG. 7. As a result of the laser cutting process, the hole 806 in the marker housing 802 is conical in the radial direction with the outer surface 808 having a diameter larger than the diameter of the inner surface 810, as illustrated in FIG. 8. The conical tapering in the marker housing 802 is beneficial in providing an interference fit between the marker insert 804 and the marker housing 802 to prevent the marker insert 804 from being dislodged once the stent 100 is deployed. A detailed description of the process of locking the marker insert 804 into the marker housing 802 is given below.

As set forth above, the marker inserts 804 may be made from any suitable material having a radiopacity higher than the superelastic material forming the stent or other medical device. For example, the marker insert 804 may be formed from niobium, tungsten, gold, platinum or tantalum. In the preferred embodiment, tantalum is utilized because of its closeness to nickel-titanium in the galvanic series and thus would minimize galvanic corrosion. In addition, the surface area ratio of the tantalum marker inserts 804 to the nickel-titanium is optimized to provide the largest possible tantalum marker insert, easy to see, while minimizing the galvanic corrosion potential. For example, it has been determined that up to nine marker inserts 804 having a diameter of 0.010 inches could be placed at the end of the stent 100; however, these marker inserts 804 would be less visible under X-ray fluoroscopy. On the other hand, three to four marker inserts 804 having a diameter of 0.025 inches could be accommodated on the stent 100; however, galvanic corrosion resistance would be compromised. Accordingly, in the preferred embodiment, six tantalum markers having a diameter of 0.020 inches are utilized on each end of the stent 100 for a total of twelve markers 800.

The tantalum markers 804 may be manufactured and loaded into the housing utilizing a variety of known tech-

niques. In the exemplary embodiment, the tantalum markers 804 are punched out from an annealed ribbon stock and are shaped to have the same curvature as the radius of the marker housing 802 as illustrated in FIG. 8. Once the tantalum marker insert 804 is loaded into the marker housing 802, a coining process is used to properly seat the marker insert 804 below the surface of the housing 802. The coining punch is also shaped to maintain the same radius of curvature as the marker housing 802. As illustrated in FIG. 8, the coining process deforms the marker housing 802 material to lock in the marker insert 804.

As stated above, the hole 806 in the marker housing 802 is conical in the radial direction with the outer surface 808 having a diameter larger than the diameter of the inner surface 810 as illustrated in FIG. 8. The inside and outside diameters vary depending on the radius of the tube from which the stent is cut. The marker inserts 804, as stated above, are formed by punching a tantalum disk from annealed ribbon stock and shaping it to have the same radius of curvature as the marker housing 802. It is important to note that the marker inserts 804, prior to positioning in the marker housing 804, have straight edges. In other words, they are not angled to match the hole 806. The diameter of the marker insert 804 is between the inside and outside diameter of the marker housing 802. Once the marker insert 804 is loaded into the marker housing 802, a coining process is used to properly seat the marker insert 804 below the surface of the marker housing 802. In the preferred embodiment, the thickness of the marker insert 804 is less than or equal to the thickness of the tubing and thus the thickness or height of the hole 806. Accordingly, by applying the proper pressure during the coining process and using a coining tool that is larger than the marker insert 804, the marker insert 804 may be seated in the marker housing 802 in such a way that it is locked into position by a radially oriented protrusion 812. Essentially, the applied pressure, and size and shape of the housing tool forces the marker insert 804 to form the protrusion 812 in the marker housing 802. The coining tool is also shaped to maintain the same radius of curvature as the marker housing 802. As illustrated in FIG. 8, the protrusion 812 prevents the marker insert 804 from becoming dislodged from the marker housing 802.

It is important to note that the marker inserts 804 are positioned in and locked into the marker housing 802 when the stent 100 is in its unexpanded state. This is due to the fact that it is desirable that the tube's natural curvature be utilized. If the stent were in its expanded state, the coining process would change the curvature due to the pressure or force exerted by the coining tool.

As illustrated in FIG. 9, the marker inserts 804 form a substantially solid line that clearly defines the ends of the stent in the stent delivery system when seen under fluoroscopic equipment. As the stent 100 is deployed from the stent delivery system, the markers 800 move away from each other and flower open as the stent 100 expands as illustrated in FIG. 7. The change in the marker grouping provides the physician or other health care provider with the ability to determine when the stent 100 has been fully deployed from the stent delivery system.

It is important to note that the markers 800 may be positioned at other locations on the stent 100.

FIG. 13 illustrates an alternate exemplary embodiment of a radiopaque marker 900. In this exemplary embodiment, the marker housing 902 comprises flat sides 914 and 916. The flat sides 914 and 916 serve a number of functions. Firstly, the flat sides 914 and 916 minimize the overall profile of the stent 100 without reducing the radiopacity of the stent 100 under x-ray fluoroscopy. Essentially, the flat sides 914 and 916 allow the



13

marker housings **902** to fit more closely together when the stent **100** is crimped for delivery. Accordingly, the flat sides **914** and **916** of the marker housing **902** allow for larger stents to utilize high radiopacity markers while also allowing the stent to fit into smaller delivery systems. For example, the flat sides **914** and **916** on radiopaque markers **900** of the size described above (i.e. having appropriately sized markers) allow a stent to maintain a radiopaque stent marker size utilized in a seven French delivery system to fit into a six French delivery system. Secondly, the flat sides **914** and **916** also maximize the nitinol tab to radiopaque marker material ratio, thereby further reducing the effects of any galvanic corrosion as described above. The marker insert **904** and the marker hole **906** are formed of the same materials and have the same shape as described above with respect to FIGS. 1-12. The markers **900** are also constructed utilizing the same coining process as described above.

FIG. 14 illustrates yet another alternate exemplary embodiment of a radiopaque marker **1000**. This exemplary embodiment offers the same advantages as the above-described embodiment; namely, reduced profile without reduction in radiopacity and a reduction in the effects of galvanic corrosion. In this exemplary embodiment, the radiopaque marker **1000** has substantially the same total area as that of the markers **900**, **800** described above, but with an oval shape rather than a circular shape or circular shape with flat sides. As illustrated, the marker **1000** comprises a substantially oval shaped marker housing **1002** and a substantially oval shaped marker insert **1004**. Essentially, in this exemplary embodiment, the marker **1000** is longer in the axial direction and shorter in the radial direction to allow a larger stent to fit into a smaller delivery system as described above. Also as in the above-described exemplary embodiment, the nitinol tab to radiopaque marker material ratio is improved. In addition, the substantially oval shape provides for a more constant marker housing **1002** thickness around the marker insert **1004**. Once again, the markers **1000** are constructed from the same materials and are constructed utilizing the same coining process as described above.

It is believed that many of the advantages of the present invention can be better understood through a brief description of a delivery apparatus for the stent, as shown in FIGS. 10 and 11. FIGS. 10 and 11 show a self-expanding stent delivery apparatus **10** for a stent made in accordance with the present invention. Apparatus **10** comprises inner and outer coaxial tubes. The inner tube is called the shaft **12** and the outer tube is called the sheath **14**. Shaft **12** has proximal and distal ends. The proximal end of the shaft **12** terminates at a luer lock hub **16**. Preferably, shaft **12** has a proximal portion **18** which is made from a relatively stiff material such as stainless steel, Nitinol, or any other suitable material, and a distal portion **20** which may be made from a polyethylene, polyimide, Pellethane, Pebax, Vestamid, Cristamid, Grillamid or any other suitable material known to those of ordinary skill in the art. The two portions are joined together by any number of means known to those of ordinary skill in the art. The stainless steel proximal end gives the shaft the necessary rigidity or stiffness it needs to effectively push out the stent, while the polymeric distal portion provides the necessary flexibility to navigate tortuous vessels.

The distal portion **20** of the shaft **12** has a distal tip **22** attached thereto. The distal tip **22** has a proximal end **24** whose diameter is substantially the same as the outer diameter of the sheath **14**. The distal tip **22** tapers to a smaller diameter from its proximal end to its distal end, wherein the distal end **26** of the distal tip **22** has a diameter smaller than the inner diameter of the sheath **14**. Also attached to the distal

14

portion **20** of shaft **12** is a stop **28** which is proximal to the distal tip **22**. Stop **28** may be made from any number of materials known in the art, including stainless steel, and is even more preferably made from a highly radiopaque material such as platinum, gold or tantalum. The diameter of stop **28** is substantially the same as the inner diameter of sheath **14**, and would actually make frictional contact with the inner surface of the sheath. Stop **28** helps to push the stent out of the sheath during deployment, and helps keep the stent from migrating proximally into the sheath **14**.

A stent bed **30** is defined as being that portion of the shaft between the distal tip **22** and the stop **28**. The stent bed **30** and the stent **100** are coaxial so that the distal portion **20** of shaft **12** comprising the stent bed **30** is located within the lumen of the stent **100**. However, the stent bed **30** does not make any contact with stent **100** itself. Lastly, shaft **12** has a guidewire lumen **32** extending along its length from its proximal end and exiting through its distal tip **22**. This allows the shaft **12** to receive a guidewire much in the same way that an ordinary balloon angioplasty catheter receives a guidewire. Such guidewires are well known in art and help guide catheters and other medical devices through the vasculature of the body.

Sheath **14** is preferably a polymeric catheter and has a proximal end terminating at a sheath hub **40**. Sheath **14** also has a distal end which terminates at the proximal end **24** of distal tip **22** of the shaft **12**, when the stent is in its fully un-deployed position as shown in the figures. The distal end of sheath **14** includes a radiopaque marker band **34** disposed along its outer surface. As will be explained below, the stent is fully deployed from the delivery apparatus when the marker band **34** is lined up with radiopaque stop **28**, thus indicating to the physician that it is now safe to remove the apparatus **10** from the body. Sheath **14** preferably comprises an outer polymeric layer and an inner polymeric layer. Positioned between outer and inner layers is a braided reinforcing layer. Braided reinforcing layer is preferably made from stainless steel. The use of braided reinforcing layers in other types of medical devices can be found in U.S. Pat. No. 3,585,707 issued to Stevens on Jun. 22, 1971, U.S. Pat. No. 5,045,072 issued to Castillo et al. on Sep. 3, 1991, and U.S. Pat. No. 5,254,107 issued to Soltesz on Oct. 19, 1993.

FIGS. 10 and 11 illustrate the stent **100** as being in its fully un-deployed position. This is the position the stent is in when the apparatus **10** is inserted into the vasculature and its distal end is navigated to a target site. Stent **100** is disposed around stent bed **30** and at the distal end of sheath **14**. The distal tip **22** of the shaft **12** is distal to the distal end of the sheath **14**, and the proximal end of the shaft **12** is proximal to the proximal end of the sheath **14**. The stent **100** is in a compressed state and makes frictional contact with the inner surface **36** of the sheath **14**.

When being inserted into a patient, sheath **14** and shaft **12** are locked together at their proximal ends by a Tuohy Borst valve **38**. This prevents any sliding movement between the shaft and sheath which could result in a premature deployment or partial deployment of the stent **100**. When the stent **100** reaches its target site and is ready for deployment, the Tuohy Borst valve **38** is opened so that that the sheath **14** and shaft **12** are no longer locked together.

The method under which the apparatus **10** deploys the stent **100** is readily apparent. The apparatus **10** is first inserted into the vessel until the radiopaque stent markers **800** (leading **102** and trailing **104** ends, see FIG. 7) are proximal and distal to the target lesion. Once this has occurred the physician would open the Tuohy Borst valve **38**. The physician would then grasp hub **16** of shaft **12** so as to hold it in place. Thereafter, the physician would grasp the proximal end of the sheath **14**



## 15

and slide it proximal, relative to the shaft 12. Stop 28 prevents the stent 100 from sliding back with the sheath 14, so that as the sheath 14 is moved back, the stent 100 is pushed out of the distal end of the sheath 14. As stent 100 is being deployed the radiopaque stent markers 800 move apart once they come out of the distal end of sheath 14. Stent deployment is complete when the marker 34 on the outer sheath 14 passes the stop 28 on the inner shaft 12. The apparatus 10 can now be withdrawn through the stent 100 and removed from the patient.

FIG. 12 illustrates the stent 100 in a partially deployed state. As illustrated, as the stent 100 expands from the delivery device 10, the markers 800 move apart from one another and expand in a flower like manner.

Although shown and described is what is believed to be the most practical and preferred embodiments, it is apparent that departures from specific designs and methods described and shown will suggest themselves to those skilled in the art and may be used without departing from the spirit and scope of the invention. The present invention is not restricted to the particular constructions described and illustrated, but should be constructed to cohere with all modifications that may fall within the scope of the appended claims.

What is claimed is:

1. An intraluminal medical device comprising: a substantially tubular member having open ends, and a first diameter for insertion into a lumen of a vessel and a second diameter for anchoring in the lumen of the vessel; and at least one marker connected to at least one end of the substantially tubular member, the at least one marker comprising a marker housing having a substantially oval shape with a continuous perimeter and a marker insert having a substantially oval shape, both having a radius of curvature equal to the radius of curvature of the substantially tubular member.

2. The intraluminal medical device according to claim 1, wherein the intraluminal medical device comprises a superelastic alloy.

3. The intraluminal medical device according to claim 2, wherein the marker housing comprises the same material as the intraluminal medical device and is integral thereto, thereby forming a unitary structure.

4. The intraluminal medical device according to claim 3, wherein the marker insert comprises a material having a radiopacity higher than that of the material comprising the intraluminal medical device.

5. The intraluminal medical device according to claim 4, wherein the marker insert comprises Tantalum.

6. The intraluminal medical device according to claim 5, wherein the marker insert is secured in the marker housing by frictional, locking engagement.

7. The intraluminal medical device according to claim 6, wherein the marker insert is secured in the marker housing by a protruding ridge.

8. An intraluminal medical device comprising:

a thin-walled, substantially tubular member, defining a longitudinal axis with a radius of curvature, having open ends, and a first diameter for insertion into a lumen of a vessel and a second diameter for anchoring in the lumen of the vessel, the thin-walled tubular member comprising a superelastic alloy, the substantially tubular member comprising a plurality of adjacent hoops interconnected by a plurality of bridges, the plurality of adjacent hoops being formed from a plurality of longitudinal struts and a plurality of loops connecting adjacent struts; and

at least one marker extending from and connected to at least one end of the thin-walled, substantially tubular member, the at least one marker comprising a marker

## 16

housing having a substantially circular shape with a continuous perimeter defining a circumference having first and second flattened sections, wherein the first and second flattened sections are aligned with the longitudinal axis, substantially parallel to the plurality of longitudinal struts when the substantially tubular member is at its first diameter and to each other and a marker insert, both having a radius of curvature equal to the radius of curvature of the substantially tubular member.

9. The intraluminal medical device according to claim 8, wherein the marker housing comprises the same material as the intraluminal medical device and is integral thereto, thereby forming a unitary structure.

10. The intraluminal medical device according to claim 9, wherein the marker housing defines a substantially elliptical opening having a predetermined curvature.

11. The intraluminal medical device according to claim 10, wherein the marker insert comprises a material having a radiopacity higher than that of the material comprising the intraluminal medical device.

12. The intraluminal medical device according to claim 11, wherein the marker insert comprises Tantalum.

13. The intraluminal medical device according to claim 12, wherein the marker insert has a curvature equal to that of the curvature of the opening in the marker housing.

14. The intraluminal medical device according to claim 13, wherein the marker insert has a diameter of 0.02 inches.

15. The intraluminal medical device according to claim 14, wherein the marker insert is secured in the marker housing by frictional, locking engagement.

16. The intraluminal medical device according to claim 15, wherein the marker insert is secured in the marker housing by a protruding ridge.

17. A stent comprising: a thin-walled, substantially tubular member defining a longitudinal axis with a radius of curvature, having open ends, and a first diameter for insertion into a lumen of a vessel and a second diameter for anchoring in the lumen of the vessel, the thin-walled tubular member comprising a superelastic alloy, the substantially tubular member comprising a plurality of adjacent hoops interconnected by a plurality of bridges, the plurality of adjacent hoops being formed from a plurality of longitudinal struts and a plurality of loops connecting adjacent struts; and at least one marker extending from and connected to at least one end of the thin-walled, substantially tubular member, the at least one marker comprising a marker housing having a substantially circular shape with a continuous perimeter, defining a circumference having first and second flattened sections, wherein the first and second flattened sections are aligned with the longitudinal axis, and a marker insert, both having a radius of curvature equal to the radius of curvature of the substantially tubular member.

18. The stent according to claim 17, wherein the marker housing comprises the same material as the stent and is integral thereto, thereby forming a unitary structure.

19. The stent according to claim 18, wherein the marker housing defines a substantially elliptical opening having a predetermined curvature.

20. The stent according to claim 19, wherein the marker insert comprises a material having a radiopacity higher than that of the material comprising the stent.

21. The stent according to claim 20, wherein the marker insert comprises Tantalum.

22. The stent according to claim 21, wherein the marker insert has a curvature equal to that of the curvature of the opening in the marker housing.



23. The stent according to claim 22, wherein the marker insert has a diameter of 0.02 inches.

24. The stent according to claim 23, wherein the marker insert is secured in the marker housing by frictional, locking engagement.

5

25. The intraluminal medical device according to claim 24, wherein the marker insert is secured in the marker housing by a protruding ridge.

26. The stent according to claim 17, further comprising six markers attached to each end of the thin-walled, substantially tubular member.

10

\* \* \* \* \*