



US008621106B2

(12) **United States Patent**
Gagliardi et al.

(10) **Patent No.:** **US 8,621,106 B2**
(45) **Date of Patent:** ***Dec. 31, 2013**

(54) **CONTENT DELIVERY NETWORK**

(75) Inventors: **Joshua D. Gagliardi**, Lake Mary, FL (US); **Timothy S. Munger**, Phoenix, AZ (US)

(73) Assignee: **Highwinds Holdings, Inc.**, Winter Park, FL (US)

(*) Notice: Subject to any disclaimer, the term of this patent is extended or adjusted under 35 U.S.C. 154(b) by 0 days.

This patent is subject to a terminal disclaimer.

6,671,715	B1	12/2003	Langseth et al.
6,877,007	B1	4/2005	Hentzel et al.
7,111,061	B2	9/2006	Leighton
7,113,993	B1	9/2006	Cappiello
7,149,797	B1	12/2006	Weller
7,181,523	B2	2/2007	Sim
7,484,002	B2	1/2009	Swildens
7,502,994	B2	3/2009	Kocol
7,543,224	B2	6/2009	Schwartz
7,680,912	B1	3/2010	McNabb
2002/0065864	A1	5/2002	Hartsell et al.
2003/0014503	A1	1/2003	Legout
2003/0046396	A1	3/2003	Richter et al.

(Continued)

(21) Appl. No.: **13/159,282**

(22) Filed: **Jun. 13, 2011**

(65) **Prior Publication Data**

US 2011/0258342 A1 Oct. 20, 2011

Related U.S. Application Data

(63) Continuation of application No. 12/334,430, filed on Dec. 12, 2008, now Pat. No. 7,962,580.

(60) Provisional application No. 61/013,584, filed on Dec. 13, 2007, provisional application No. 61/014,682, filed on Dec. 18, 2007.

(51) **Int. Cl.**
G06F 15/173 (2006.01)

(52) **U.S. Cl.**
USPC **709/241**; 709/238

(58) **Field of Classification Search**
None
See application file for complete search history.

(56) **References Cited**

U.S. PATENT DOCUMENTS

6,108,703	A	8/2000	Leighton
6,553,413	B1	4/2003	Leighton

Josh Gagliardi, Usenet Training, May 5-7, 2004, Highwinds Software.

(Continued)

Primary Examiner — Ario Etienne

Assistant Examiner — Clayton R Williams

(74) *Attorney, Agent, or Firm* — Knobbe Martens Olson & Bear LLP

(57) **ABSTRACT**

A content delivery system for providing content from a content delivery network to end users may include a plurality of delivery servers that host one or more content items and an inventory server having an inventory of content. The inventory of content can indicate which of the delivery servers host the content items. The inventory server may receive a request for a content item from an end user system and may access the inventory of content to determine one or more delivery servers that host the content item. In response to this determination, the inventory server may redirect the request for the content item to a selected one of the delivery servers. The selected delivery server can then serve the content item to the end user system.

18 Claims, 12 Drawing Sheets

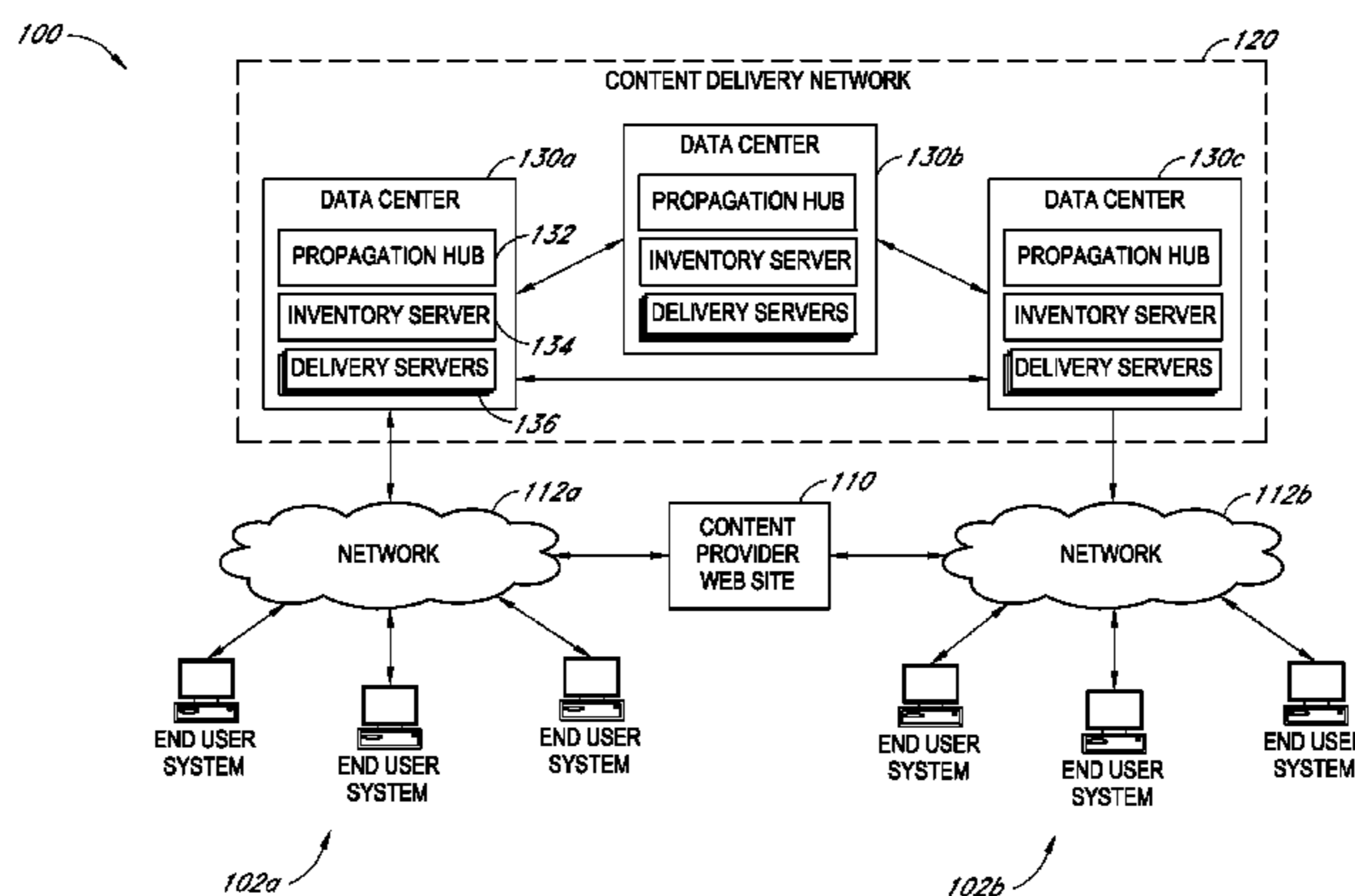

(56)

References Cited

U.S. PATENT DOCUMENTS

2003/0115283 A1* 6/2003 Barbir et al. 709/217
 2003/0236745 A1 12/2003 Hartsell et al.
 2004/0122943 A1 6/2004 Error et al.
 2004/0128346 A1 7/2004 Melamed
 2005/0005025 A1* 1/2005 Harville et al. 709/241
 2005/0108418 A1 5/2005 Bedi
 2005/0198250 A1* 9/2005 Wang 709/223
 2005/0223093 A1 10/2005 Hanson et al.
 2007/0118668 A1 5/2007 McCarthy
 2007/0168517 A1 7/2007 Weller
 2007/0204003 A1 8/2007 Abramson
 2007/0209005 A1 9/2007 Shaver et al.
 2007/0239609 A1 10/2007 Fish et al.
 2007/0261072 A1 11/2007 Boulet et al.
 2008/0065604 A1 3/2008 Tiu et al.
 2008/0065759 A1 3/2008 Gassewitz et al.
 2008/0086524 A1 4/2008 Afergan et al.
 2008/0086574 A1* 4/2008 Raciborski et al. 709/245
 2008/0155061 A1 6/2008 Afergan et al.
 2008/0184245 A1 7/2008 St-Jean
 2008/0198752 A1 8/2008 Fan
 2008/0228891 A1 9/2008 Cama
 2009/0070673 A1 3/2009 Barkan et al.
 2009/0083788 A1 3/2009 Russell et al.
 2009/0131152 A1 5/2009 Busse
 2009/0210549 A1* 8/2009 Hudson et al. 709/231

2010/0030887 A1 2/2010 Mousseau et al.
 2010/0036949 A1* 2/2010 Li et al. 709/225
 2010/0131642 A1 5/2010 Chalikouras et al.
 2010/0161729 A1 6/2010 Leblanc et al.
 2010/0218112 A1 8/2010 Park et al.
 2010/0235494 A1 9/2010 Sood et al.
 2011/0125593 A1 5/2011 Wright et al.

OTHER PUBLICATIONS

Josh Kuo, Google Analytics is Worth a Look, Jan. 27, 2007, InfoWorld.
 Thomas Claburn, Google Analytics Adds Enterprises Features, Oct. 22, 2008, InformationWeek, CPM Media LLC.
 Omniture Named a Web Analytics Leader by Independent Research Firm, Sep. 11, 2007, Market Wire, Sys-Con Media Inc.
 International Search Report and Written Opinion mailed Apr. 7, 2009 regarding International Application No. PCT/US08/86721, in 15 pages.
 Estan, C. et al., New Directions in Traffic Measurement and Accounting: Focusing on the Elephants, Ignoring the Mice, ACM Transactions on Computer Systems, vol. 21, No. 3, Aug. 2003, p. 270-313.
 International Search Report and Written Opinion from PCT/US2010/045940 mailed Oct. 20, 2010.
 Henry, Mapping the Web: Clicky is Free, Real-Time Web Analytics, <http://www.mappingtheweb.com/2007/02/05/clicky-is-free-real-time-web-analytics/>, Feb. 5, 2007.

* cited by examiner

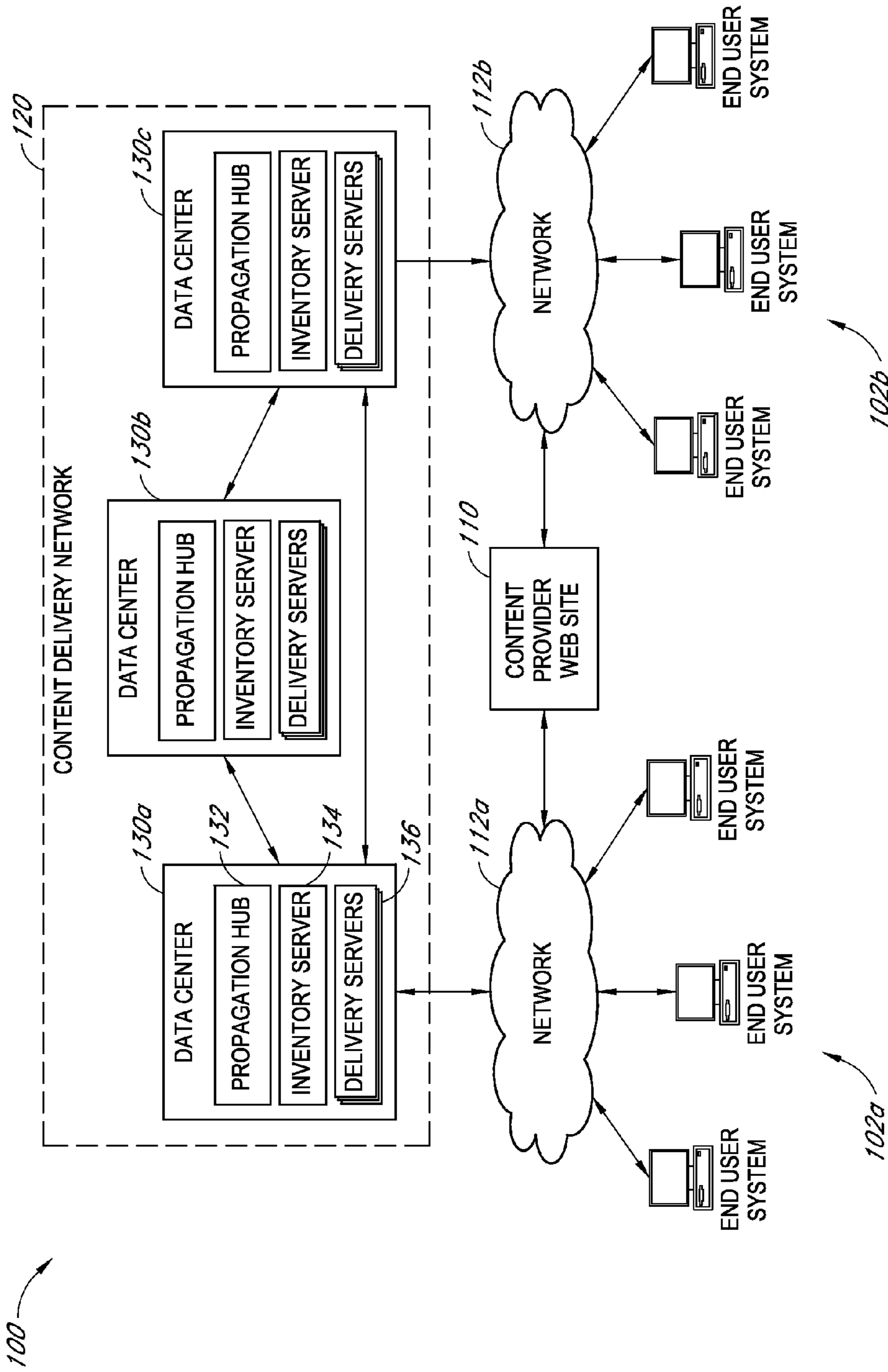

FIG. 1

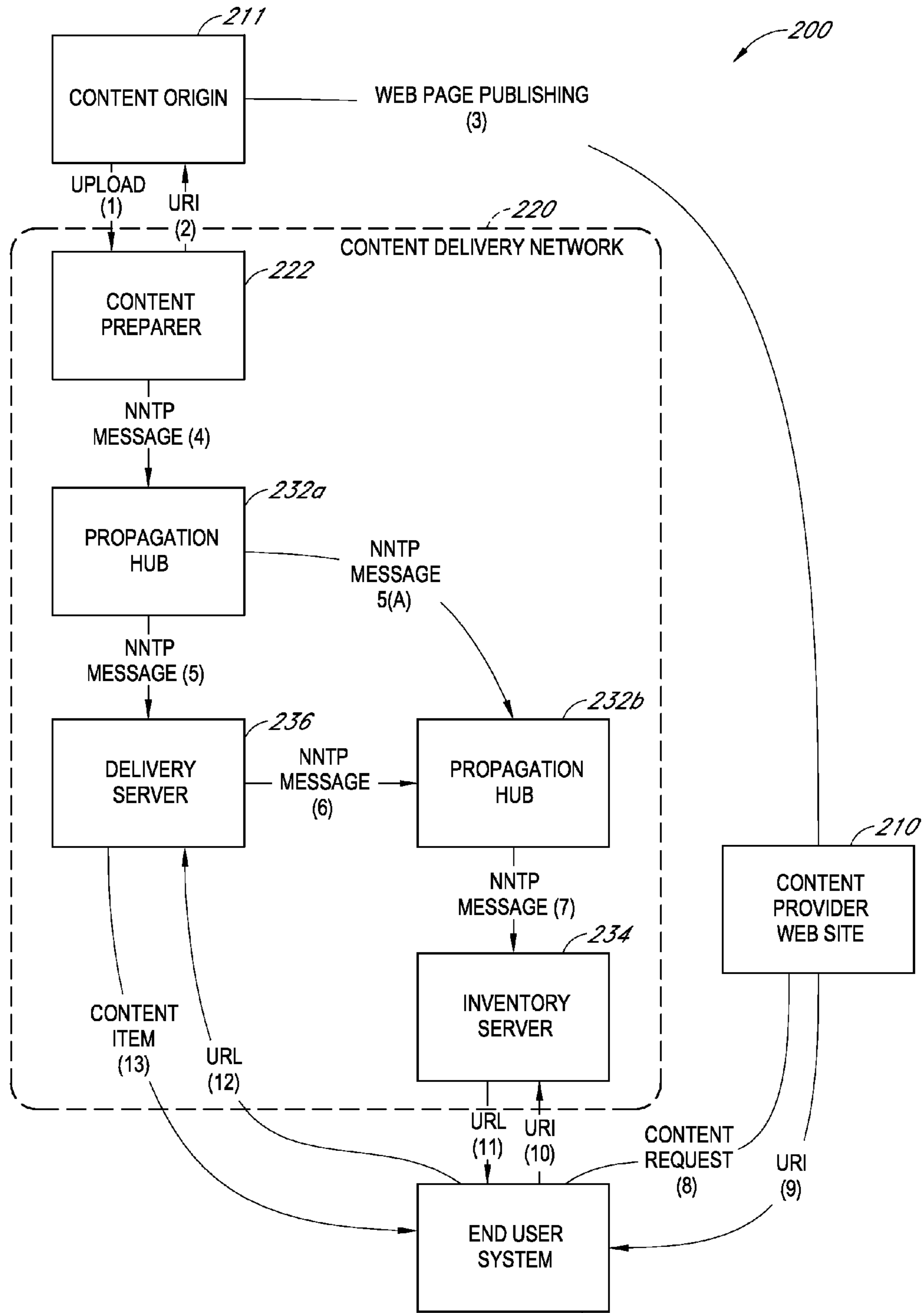

FIG. 2

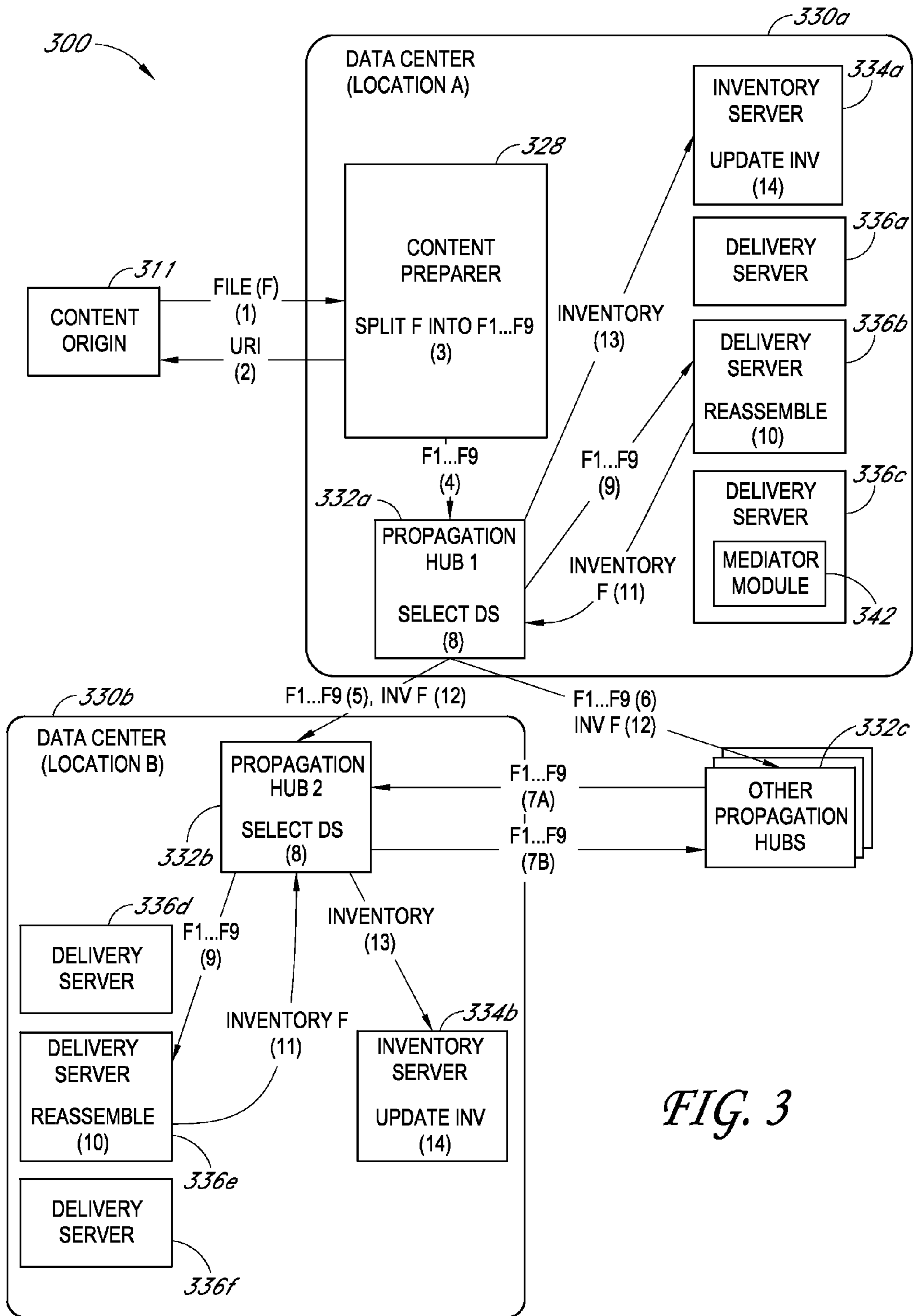

FIG. 3

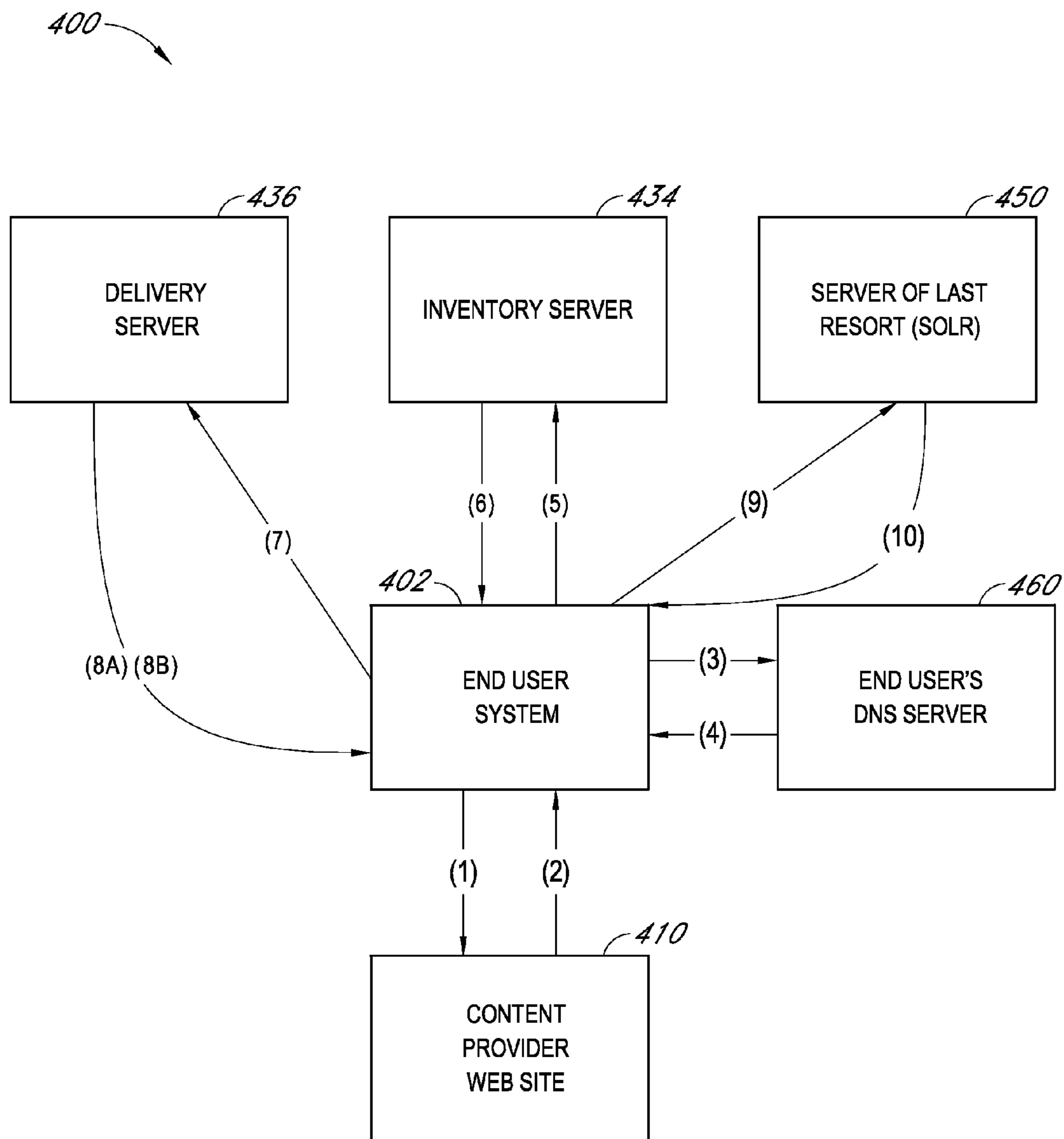

FIG. 4

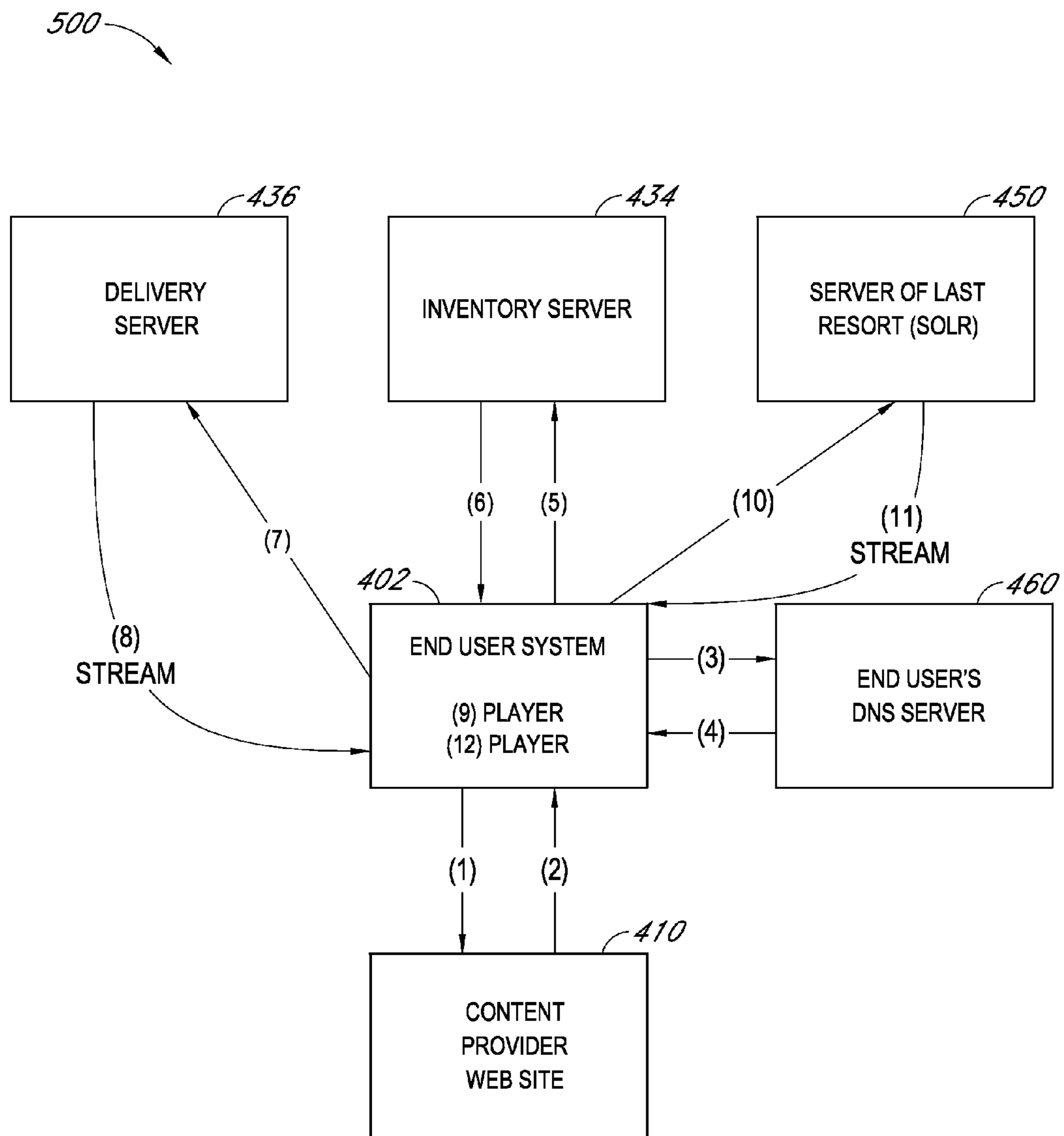

FIG. 5

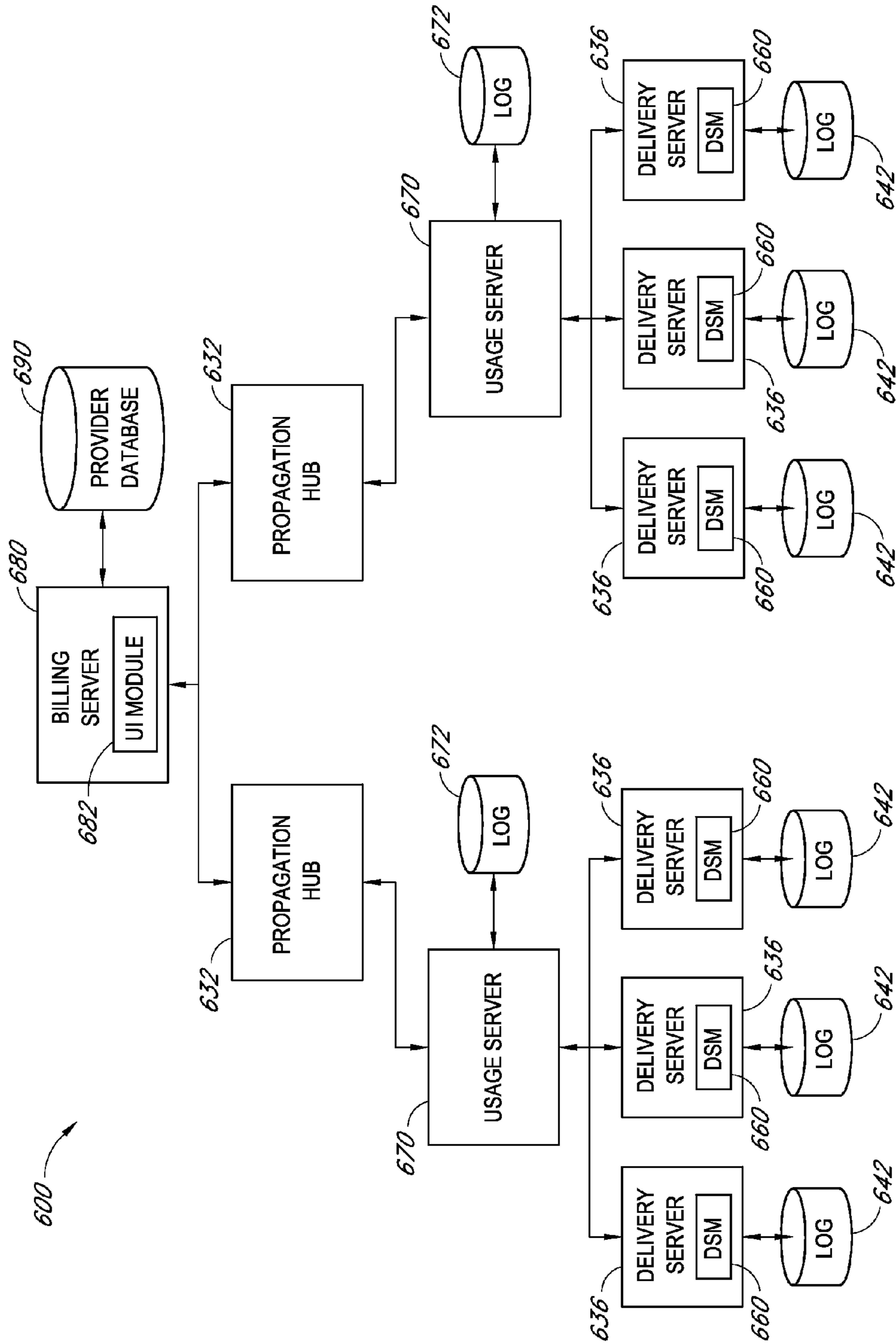

FIG. 6

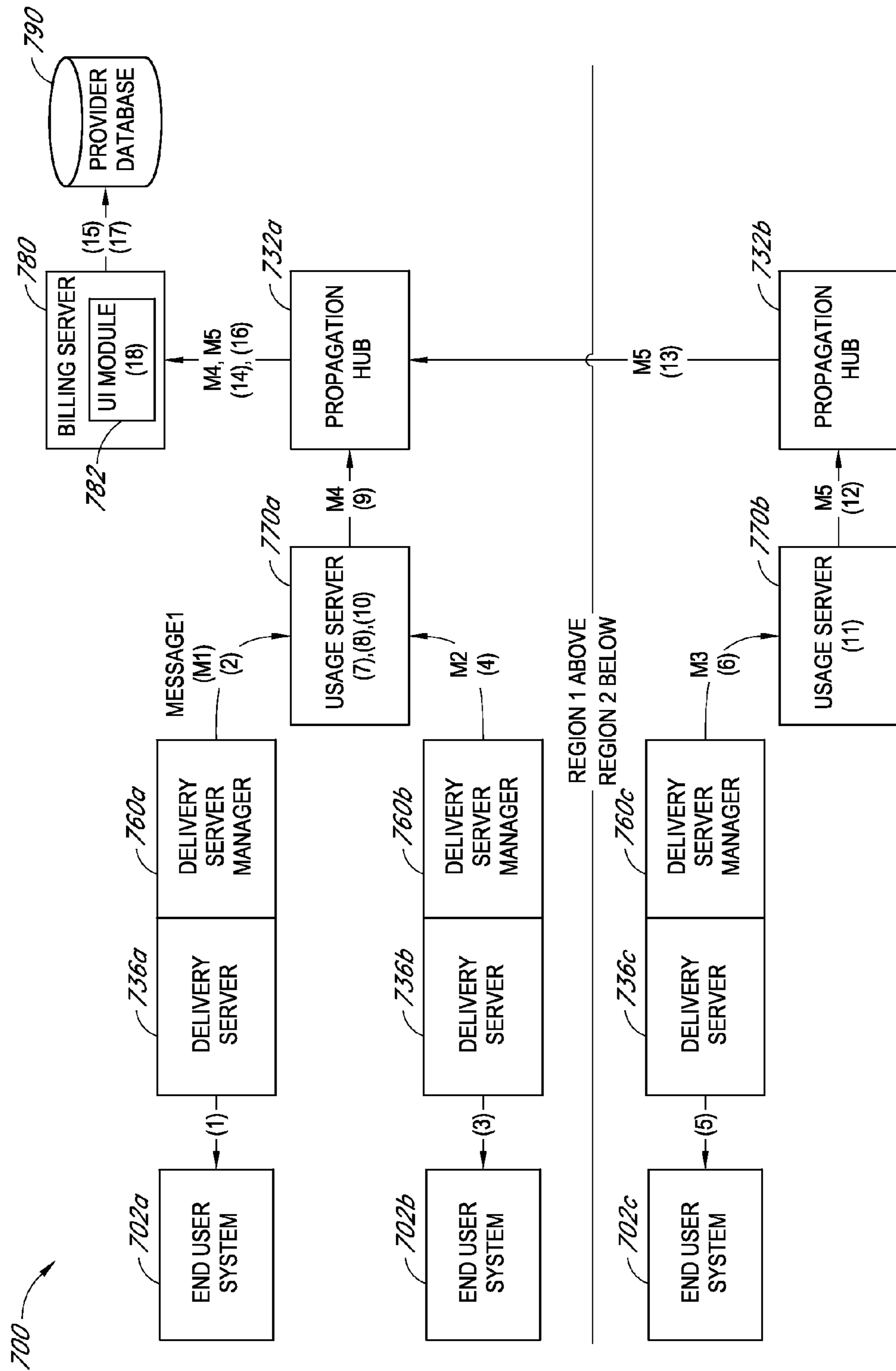
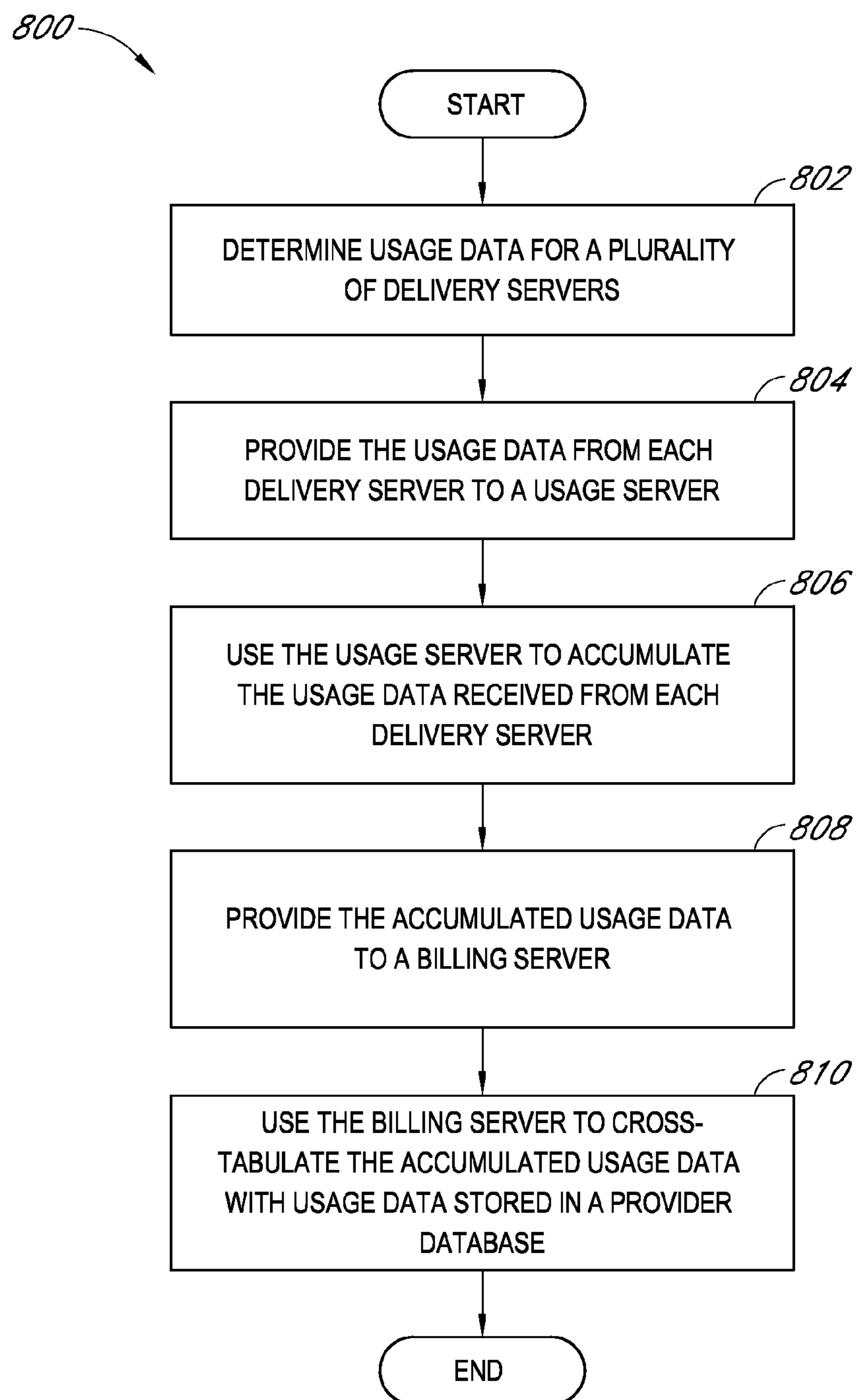
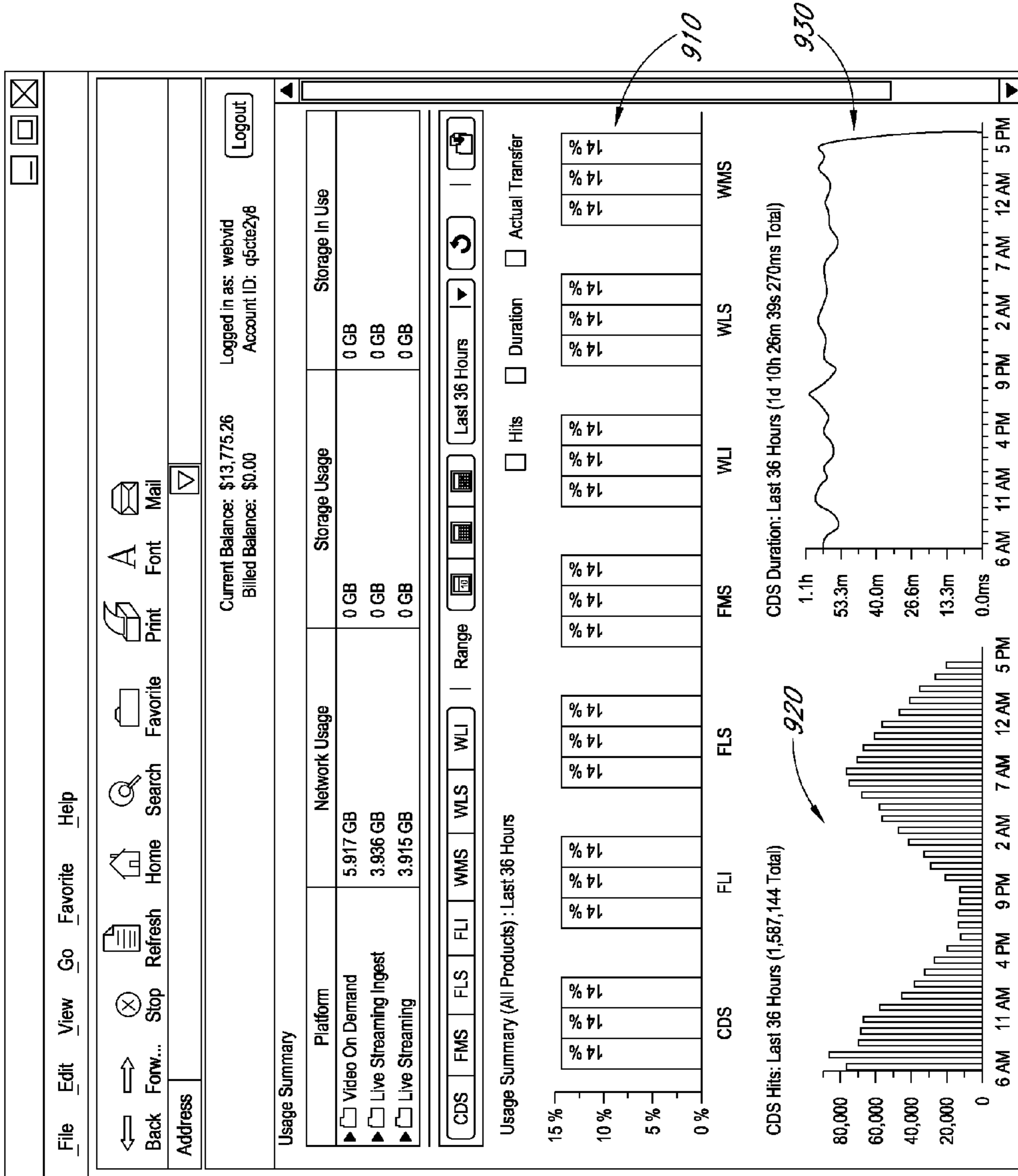

FIG. 7

*FIG. 8*



900

FIG. 9

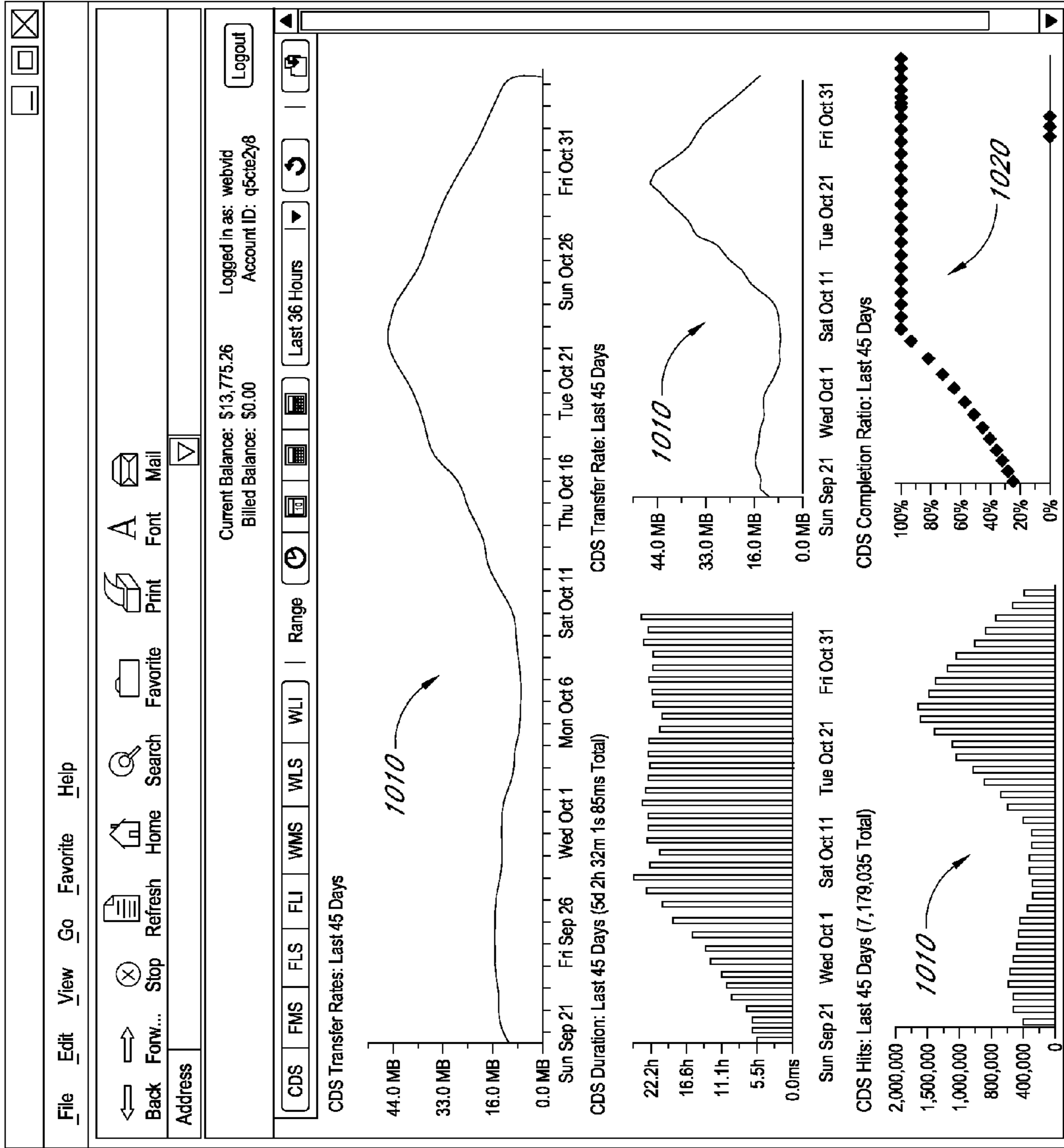

1000

FIG. 10

1100

File Edit View Go Favorite Help

Back Forw... Stop Refresh Home Search Favorite Print Font Mail

Address

Current Balance: \$13,775.26 Logged in as: webvid
Billed Balance: \$0.00 Account ID: q5cte2y8

CDS FMS FLS WMS WLS | Range Last 36 Hours

Logout

Top 100 File Paths by Hits for FMS - Last 36 Hours

Filters File Paths hits >= 0 Transfer Rate kb/s >= 0 Completion % >= 0 Reset Filters

File Path	Hits	Actual Transfer	Completion Ratio	Transfer Rate	Duration
picture.flv	18,908	4.0 GB	100.00%	27.6 Mb/s	23 m 31s 979ms
router.flv	18,520	5.2 GB	100.00%	29.2 Mb/s	23 m 55s 284ms
lizads.flv	18,404	5.1 GB	100.00%	30.2 Mb/s	22 m 39s 814ms
paper.flv	18,007	4.9 GB	100.00%	29.2 Mb/s	22 m 34s 670ms
whiskey.flv	17,789	4.7 GB	100.00%	27.0 Mb/s	22 m 54s 950ms
trains.flv	17,702	5.0 GB	100.00%	30.1 Mb/s	22 m 6s 356ms

1120

FIG. 11

1200

File Edit View Go Favorite Help

Back Forw... Stop Refresh Home Search Favorite Print Font Mail

Address

Current Balance: \$13,775.26 Logged in as: webvid
 Billed Balance: \$0.00 Account ID: q5cte2y8 Logout

CDS FMS FLS WMS WLS | Range Last 36 Hours

Top 100 Region by Hits for CDS - Last 36 Hours

Select Top Region Details with List Select Top Region Details with Map

Filters File Paths hits >= 0 Transfer Rate kbs >= 0 Completion % >= 0 Reset Filters

Region	Hits	Actual Transfer	Completion Ratio	Transfer Rate	Duration
United States, CA	16	65.4 MB	29.22%	31.4 Mb/s	4h 27m 15s 229ms
United States, FL	2	390.9 MB	100.00%	6.6 Mb/s	7m 50s 706ms

1230

FIG. 12

CONTENT DELIVERY NETWORK

RELATED APPLICATIONS

This application claims the benefit of priority under 35 U.S.C. §120 as a continuation of U.S. application Ser. No. 12/334,430, filed on Dec. 12, 2008, which claims priority under 35 U.S.C. §119(e) to U.S. Provisional Patent Application No. 61/013,584, filed on Dec. 13, 2007, and entitled “Hybrid NNTP Content Library Propagation and Delivery in a Content Delivery Network,” and U.S. Provisional Patent Application No. 61/014,682, filed on Dec. 18, 2007, entitled “Apparatus for Real-Time Distributed Accounting of Managed Internet Services.” The disclosures of each of the foregoing applications are hereby incorporated by reference in their entirety.

BACKGROUND

In a content delivery network (CDN), a content provider typically has a group of files or content library which they wish to make available for retrieval to a geographically distributed set of end users, typically by download or streaming protocols. A content delivery provider provisions these files to multiple computers or “edge nodes” over a network, such as the Internet, so that for many users there is a download or streaming location which can be physically closer to the users. The download or streaming location may also provide lower network latency or have higher capacity than the original location where the content provider’s files are stored.

Rapid provisioning of these files to many locations is one problem faced by CDNs. Also, many CDNs are structured in a sparsely connected mesh, where several files to be provisioned on the edge nodes are first provisioned on one of a smaller number of servers. These servers may not be near the content library’s original storage location.

SUMMARY

In certain embodiments, a content delivery system for providing content from a content delivery network to end users includes a plurality of delivery servers that host one or more content items and an inventory server having an inventory of content. The inventory of content can indicate which of the delivery servers host the content items. The inventory server may receive a request for a content item from an end user system and may access the inventory of content to determine one or more delivery servers that host the content item. In response to this determination, the inventory server may redirect the request for the content item to a selected one of the delivery servers. The selected delivery server can then serve the content item to the end user system.

In various embodiments, a system for cross-tabulating content usage information at multiple nodes of a content delivery network includes a plurality of delivery servers that each provide access to content. Each of the delivery servers may have one or more processors that can determine usage data that includes information corresponding to delivery of content from the delivery server. The content may be hosted by the delivery servers on behalf of one or more content providers that each have an account with an operator of the content delivery network. Each of the delivery servers may also batch at least a portion of the usage data to produce first batched usage data, where the first batched usage data may include a summary of the usage data. In addition, each of the delivery servers may also provide the first batched usage data to a usage server.

In certain embodiments, a computer-implemented method of providing content to end users from a content delivery network having one or more delivery servers each having computer hardware and an inventory server having computer hardware includes receiving, with a content delivery network, a content item from a content provider, where the content provider provides a web site. The method may also include returning a uniform resource indicator (URI) corresponding to the content item, where the URI can identify the inventory server in the content delivery network. The method may also include provisioning the content item to the one or more delivery servers in the content delivery network, where the one or more delivery servers each comprising computer hardware. In response to the one or more delivery servers receiving the content item, the method may also include providing to the inventory server a message from each of the one or more delivery servers that have received the content item, where the message reflects the receiving of the content item by the one or more delivery servers. The method may also include storing inventory information in an inventory of the inventory server, where the inventory information describes which of the one or more delivery servers hosts the content item. The method may also include receiving, with the inventory server, a request for the content item from an end user, where the request specifies the URI, and where the end user having received the URI in response to accessing the web site of the content provider. The method may also include accessing the inventory to determine a selected delivery server that hosts the content item. The method may also include redirecting the request for the content item to the selected delivery server and providing the content item to the end user from the selected delivery server.

In certain embodiments, a computer-implemented method of provisioning content in a content delivery network includes provisioning a content item to first delivery servers selected from a plurality of delivery servers, where each of the plurality of delivery servers has computer hardware. In response to a selected one of the first delivery servers receiving the content item, the method may further include providing to an inventory server an inventory message from the selected delivery server, where the inventory message reflects the receiving of the content item by the selected delivery server. The method may further include storing, with the inventory server, an inventory in physical computer storage, where the inventory indicates which of the delivery servers hosts the content item.

In certain embodiments, a content delivery system for providing content from a content delivery network to end users includes a plurality of delivery servers in a content delivery network, where the delivery servers have computer hardware. At least some of the delivery servers may host one or more content items. The system may further include an inventory server that includes an inventory of content, where the inventory of content indicates which of the delivery servers host the one or more content items. The inventory server can receive a request for a content item, where the request specifies a logical location of the content item, use the logical location of the content item to access the inventory of content to determine one or more delivery servers that host the content item, and redirect the request for the content item to a selected one of the delivery servers, such that the selected delivery server is operative to serve the content item.

In certain embodiments, a system for provisioning content in a content delivery network includes a content delivery network having a plurality of delivery servers, where each of the delivery servers has computer hardware. The system may further include one or more propagation servers that can

3

provision a content item to first delivery servers selected from the plurality of delivery servers. Each of the first delivery servers can provide to a server a message reflecting the receiving of the content item by the first delivery server, in response to the first delivery server receiving the content item. The server may store an inventory in physical computer storage, where the inventory indicates which of the delivery servers hosts the content item.

In certain embodiments, a system for providing media owners with media delivery reports showing statistics of each media file delivered includes a plurality of delivery servers in a content delivery network, where each of the delivery servers delivers media files to users over the Internet, and where the media files may be owned by a plurality of different media owners. Each of the delivery servers can be programmed to: log the time, date, file size in bytes, delivered bytes in case of partial delivery, and delivery duration of each media file delivered to the user over the internet, for each event when a media file is delivered to a user, analyze the log events to generate an event report for each media file including the number of deliveries of any portion of each media file according to the time of day and date, and the total number of bytes of each media file delivered, and provide event reports to a usage server. The usage server can be programmed to: receive the event reports from each of the delivery servers, combine the event reports from each of the delivery servers into combined event reports, such that the amount of each media file delivered by the plurality of delivery servers is summed to reflect a cumulative total amount of each media file delivered by the plurality of delivery servers, and provide the combined event reports to a billing server. The billing server can be programmed to: combine the combined event reports with historical log event data stored in a provider database to produce overall delivery statistics, calculate a delivery completion percentage for each media file by dividing the total amount of bytes of each media file delivered by the size of the respective media file; and output a content user interface for display to each of the content owners, the content user interface. The content user interface can display the delivery completion percentage for each media file, so that each media owner can determine which of the media files are being completely delivered to end users as well as the respective average proportions of the media files that are only partially delivered to users, thereby enabling the media owners to determine which of the media files are more often viewed in their entirety by users and which are only partially viewed by the users.

In certain embodiments, a system for cross-tabulating content usage information at multiple nodes of a content delivery network architecture includes: a plurality of delivery servers in a content delivery network, where each of the delivery servers can provide access to content. Each of the delivery servers can include one or more processors that can: determine usage data, where the usage data includes information corresponding to delivery of content from the delivery server, and where the content is hosted by the delivery servers on behalf of one or more content providers, and where each of the one or more content providers has an account with an operator of the content delivery network. Each of the delivery servers may also batch at least a portion of the usage data to produce first batched usage data, where the first batched usage data includes a summary of the usage data, and provide the first batched usage data to a usage server. The usage server can receive the first batched usage data from each of the delivery servers, batch the first batched usage data from each of the delivery servers into second batched usage data, and provide the second batched usage data to a billing server. The

4

billing server can cross-tabulate the second batched usage data with usage data stored in a provider database to produce overall usage data.

In certain embodiments, a system for tracking content deliveries in a content delivery network includes a plurality of delivery servers in a content delivery network, where the delivery servers have computer hardware. Each of the delivery servers can: track delivery data corresponding to content deliveries performed by the delivery server, cross-tabulate the delivery data to produce condensed delivery data, and provide the condensed delivery data to a usage server. The usage server can cross-tabulate the condensed delivery data received from each of the delivery servers to produce second condensed delivery data.

In certain embodiments, a method for tracking content delivery information in a content delivery network includes receiving, with a first usage server having one or more processors, first delivery data corresponding to first content deliveries performed by a first delivery server, where the first delivery data has information about deliveries of content by the first delivery server. The method may further include receiving, with the first usage server, second delivery data corresponding to second content deliveries performed by a second delivery server. The method may further include combining, using the one or more processors of the first usage server, the first and second delivery data received from the first and second delivery servers to produce first summarized delivery data. The method may further include providing the first summarized delivery data to a billing server, where the billing server can combine the first summarized delivery data with second summarized delivery data received from a second usage server to produce combined delivery data and can store the combined delivery data in a provider database comprising physical computer storage.

The usage server can receive the first batched usage data from each of the delivery servers, batch the first batched usage data from each of the delivery servers into second batched usage data, and provide the second batched usage data to a billing server. The billing server can cross-tabulate the second batched usage data with usage data stored in a provider database to produce overall usage data.

For purposes of summarizing the disclosure, certain aspects, advantages and novel features of the inventions have been described herein. It is to be understood that not necessarily all such advantages may be achieved in accordance with any particular embodiment of the inventions disclosed herein. Thus, the inventions disclosed herein may be embodied or carried out in a manner that achieves or optimizes one advantage or group of advantages as taught herein without necessarily achieving other advantages as may be taught or suggested herein.

BRIEF DESCRIPTION OF THE DRAWINGS

Throughout the drawings, reference numbers may be used to indicate correspondence between referenced elements. The drawings are provided to illustrate embodiments of the inventions described herein and not to limit the scope thereof.

FIG. 1 illustrates an embodiment of a network environment for providing content to end users;

FIG. 2 illustrates an embodiment of a process flow for providing content from a content delivery network to an end user;

FIG. 3 illustrates an embodiment of a process flow for propagating content through the content delivery network;

5

FIGS. 4 and 5 illustrate additional embodiments of process flows for providing content from the content delivery network to an end user;

FIG. 6 illustrates an embodiment of a system for tracking content usage in the content delivery network;

FIG. 7 illustrates an embodiment of a process flow for tracking content usage;

FIG. 8 illustrates an embodiment of a process for tracking content usage; and

FIGS. 9 through 12 illustrate example administrative displays for viewing usage data related to the content delivery network.

DETAILED DESCRIPTION

In addition to the disadvantages of typical CDNs described above, many CDNs have little or no knowledge of which files are provisioned on which servers in the network. As a result, a CDN might replicate all files on most or all edge nodes of the network, to attempt to ensure that a user directed to an edge node will find a desired file. If the user is directed to an edge node that does not have the desired file, the edge node may request the file from another node in the sparsely-connected mesh. This request can introduce delays in responding to the user's request.

This disclosure describes certain systems and methods for enhanced content delivery in a CDN. In certain embodiments, a CDN includes delivery servers that host content items. When a delivery server is provisioned with a content item, the delivery server can inform an inventory server about the provisioning of the content item. The inventory server can store a mapping between the delivery server and the content item in an inventory. Then, an end user system that accesses a web page specifying the content item can be directed to the inventory server. Because the inventory server knows, in certain embodiments, the location of the content item, the inventory server can redirect the end user system to the proper delivery server.

The CDN may also include a usage tracking system that streamlines the tracking of content usage. In certain embodiments, delivery servers send log messages that include usage data to usage servers. The usage servers may cross-tabulate the log messages received from the delivery servers. The usage servers can then provide log messages to a billing server, which can accumulate the usage data in a provider database. Advantageously, in certain embodiments, the usage tracking system can streamline the reporting and tabulating of usage data and thereby enable the CDN to provide content providers with access to recent usage data.

FIGS. 1-5 describe content delivery features of the CDN. FIGS. 6-12 describe various usage tracking features of the CDN.

I. Content Delivery Features

Referring to FIG. 1, an embodiment of a network environment 100 is shown for providing users with access to content. The network environment 100 includes a content delivery network (CDN) 120. In certain embodiments, the CDN 120 includes inventory information about the location of content in the CDN 120. This inventory information advantageously enables the CDN 120, in certain implementations, to more efficiently use computing resources and bandwidth. As a result, the CDN 120 may be able to provide better service to users than certain other CDNs.

The CDN 120 may host content that is associated with a web site 110 of a content provider. The content may include various types of media, such as music, videos, and images. The content provider may employ the services of the CDN

6

120 to more efficiently distribute the content associated with the web site 110 to end user systems 102. Users that access the content provider web site 110 over a network 112 such as the Internet may, for example, receive a base web page from the web site 110. The users can access content items or objects referenced in the web page from the CDN 120.

The content provider web site 110 may include one or more physical computing devices, such as servers. Likewise, the end user systems 102 may include various types of computing devices, such as, for example, desktop computers, workstations, web pads, personal digital assistants (PDAs), mobile phones, set-top television boxes, media players, laptop computers, tablets, combinations of the same and the like. The end user systems 102 can also include various software applications for accessing the web site 110 and the content of the CDN 120, such as browser software applications, stand-alone software applications, plug-ins, media players, interfaces, combinations of the same, and the like.

The CDN 120 of the depicted embodiment includes a plurality of data centers 130. Each data center 130 may be located in a different geographical area from the other data centers 130, to increase the number of end users that are physically close to a data center 130. As a simplified example, a first data center 130a may be accessed by end-user systems 102a in one location through the network 112a, and a second data center 130c in another location may be accessed by other end user systems 102b. Three data centers 130 are depicted for ease of illustration; more or fewer data centers 130 may be provided in various implementations. In addition, end user systems 102 may access more remote data centers 130, for example, if latency of those data centers 130 is less than latency of more proximate data centers 130.

In certain embodiments, each data center 130 includes a propagation hub 132, an inventory server 134, and one or more delivery servers 136, each of which may include one or more physical computing devices. However, this grouping of servers in one data center 130 is merely illustrative. The propagation hub 132 may be a server that provisions content received from a content provider to the delivery servers 136. The propagation hub 132 may also provide or propagate content to other propagation hubs 132 of other data centers 130. In the depicted embodiment, arrows connecting the data centers 130 indicate that each data center 130 may communicate with each other. For example, the propagation hub 132 of one data center 130 may communicate with the propagation hubs 132 of each other data center 130.

Because each propagation hub 132 may talk with every other propagation hub 132 in the depicted embodiment, the propagation hubs 132 are in a fully-connected or substantially fully-connected mesh configuration or topology. Advantageously, certain embodiments of the CDN 120 are therefore not constrained to the rigid hierarchical tree topologies of other CDNs. As will be described in greater detail below with respect to FIGS. 2 and 3, the fully-connected mesh structure of the CDN 120 can enable more efficient propagation of content and other data through the CDN 120. In addition, the mesh topology of the CDN 120 can make the CDN 120 more robust in the face of network failures and congestion.

The fully-connected mesh topology shown in FIG. 1 is merely an illustrative topology for the CDN 120. In other embodiments, the CDN 120 may have an arbitrary topology, for example, a topology with a portion of all propagation hubs 130 in communication with each other, a hierarchical or partially hierarchical topology, combinations of the same, and the like.

The delivery servers 136 can receive the content from the propagation hubs 132 and host or otherwise store the content.

Upon receiving the content from the propagation hubs **132**, the delivery servers **136** may report content location information to the inventory server **134**. The inventory server **134** can in turn store an inventory of the content locations. This inventory may include one or more data structures that map content items to delivery servers **136** and/or content items to specific directories on delivery servers **136**. In some implementations, inventory servers **134** also report their inventory to other inventory servers **134** through the propagation hubs **132**. As a result, each inventory server **134** may have an inventory reflecting the contents of all or substantially all of the delivery servers **136** in the CDN **120**. The inventory servers **134** may each store the entire inventory in volatile storage (e.g., memory), to improve inventory performance.

In operation, the content provider may upload a content item to the CDN **120**, which may be received by one of the propagation hubs **132**. The CDN **120** may provide the content provider with a network address for the content item (see FIG. 2). The content provider may then embed the network address in one or more pages or documents of the content provider web site **110**. The propagation hub **132** may provide the content item to one or more delivery servers **136**, which in turn may report the receipt of the content item to one or more inventory servers **134**.

An end user system **102** accessing the content provider web site **110** may be directed to the network address to retrieve the content item. Advantageously, in certain embodiments, the network address is an address of one of the inventory servers **134**. Thus, the end user system **102** can request the content item from the inventory server **134**. In response, the inventory server **134** may access its inventory to determine which of the delivery servers **136** has the content item. The inventory server **134** may select a delivery server **136** that may be optimal for the end user based at least in part on geographical proximity, network congestion, and/or other network conditions.

The inventory server **134** may provide a network address of one of the delivery servers **136** to the end user system **102**. The end user system **102** may then access the content item from the delivery server **136**. Advantageously, because the inventory servers **134** have information regarding content item location on delivery servers **136**, fewer than all of the delivery servers **136** may be used to store any one content item.

In contrast, other CDNs may not have inventory knowledge of delivery servers. As a result, these CDNs typically provision most or all delivery servers with each content item. As a result, storage space can be wasted on the delivery servers of other systems. In addition, other CDNs often provide content providers with network addresses for delivery servers, which the content providers can embed in their web sites. An end user accessing a content provider web site may then be redirected to a specific delivery server to access the content item. However, because these CDNs do not have content inventory, the network address may point to a delivery server that does not have the content item. The delivery server may then have to obtain the content item from another server in the CDN hierarchy. This cache-on-demand architecture can result in delays to the user.

Certain embodiments of the CDN **120** can use delivery server **136** storage space more efficiently and can have fewer delays than certain cache-on-demand CDN systems. Moreover, because the CDN **120** may use storage space more efficiently, the delivery servers **136** may require little or no cache management, other than that provided natively by an operating system on each server **136**. In contrast, in other CDN systems, significant software overhead may be used to

manage caches, for example, to ensure that popular items do not dominate a cache and thereby leave little cache space for less popular items.

In alternative embodiments, fewer than all of the data centers **130** may have inventory servers **134**. One inventory server **134** may be used for the entire CDN **120**, or a plurality of inventory servers **134** may be spread amongst various data centers **130**. Likewise, although the propagation hub **132**, inventory server **134**, and delivery servers **136** are shown grouped together in one geographic location (e.g., the data center **130a**), these servers may be located in separate, geographically different locations or in different data centers **130**.

In addition, the inventory of the inventory servers **134** may be installed on certain of the delivery servers **236** or other servers, such that no separate server is used for inventory storage. However, it may be advantageous, but not necessary, to use the inventory servers **134** only for storing inventory and redirecting requests to delivery servers **134** to improve the performance of the inventory servers **134**.

FIG. 2 illustrates an embodiment of a content process flow **200** for an example CDN **220**. The CDN **220** may include all the features of the CDN **120** described above. For instance, the CDN **220** includes propagation hubs **232a**, **232b**, a delivery server **236**, and an inventory server **234**. The CDN **220** also includes a content preparer **222**. The process flow **200** illustrates the provisioning of one or more content items to the CDN **220** and the retrieval of the one or more content items by an end user system **202**. The CDN **220** is shown with a simplified number of servers for ease of illustration; however, many other servers may be included in the CDN **220** in certain implementations.

A content origin server **211** is shown that may include one or more computing devices. The content origin server **211** may be a file server or media company content management system, where a content provider has stored a content library of content items (e.g., digital files). These files may be numerous and large, for example thousands or more files each up to several gigabytes or more in size. The content origin server **211** may be owned or operated by the content provider.

In the depicted embodiment, at state **1** the content origin server **211** uploads one or more content files from the content library to the content preparer **222** of the CDN **220**. The content origin server **211** may upload the files via FTP, HTTP, NNTP, or another protocol. The content preparer **222** may be a server comprising computer hardware and/or software, an application on another server (such as a propagation hub **232**), or the like. In response to receiving each file, at state **2** the content preparer **222** returns a network address for the file to the content origin server **211**. The network address may be a uniform resource indicator, or URI. A "URI," in addition to having its ordinary meaning, can be a resource identifier that includes a network address which is semi-independent from the location where that resource is stored. An example URI is described below with respect to FIG. 4.

If a content file is designated for download delivery, then the returned URI may refer to the file itself. If the content is designated for streaming media delivery, then the URI may refer to a playlist file that may have a name derived from the content file. Playlists may be XML documents or the like that provide a series of media resources to play a content item. Playlists may permit multiple delivery servers **236** to stream the series of media resources.

At state **3**, the content provider may publish a web page or other network application to a content provider web site **210** that identifies one or more content items by the URI(s) received from the content preparer **222**. The web page or

other network application may include references to the URI (s) directly or to application code which calls another server to find out the URI(s).

The content preparer **222** can, at state **4**, provide a message containing at least a portion of the file to a propagation hub **232a**. In certain embodiments, the content preparer **222** repackages the uploaded content library for propagation by splitting large content files into smaller pieces, and packaging those pieces into messages. In certain embodiments, the content preparer **222** packages the file pieces into Network News Transfer Protocol (NNTP) messages. Each NNTP message may include a series of bytes formatted according to Request For Comments (RFC) 822, 977, 3977, and the like. The message may include a string of bytes with a header area having keys and values, and a body area containing arbitrary content. Some fields in the message might include a Message-Id field, which can uniquely identify a message; a Newsgroups field, which can indicate one or more NNTP families of messages to which a message belongs; a From field, which can identify the message author (e.g., a server name); and a Subject field, which may give a short string describing the message.

For example, the content preparer **222** may split a 100 megabyte content file into ten 10-megabyte files. The content preparer **222** may label each piece of the file with specific propagation instructions in an NNTP message header or in the beginning of an NNTP message body. The content preparer **222** may insert a string representing the original filename and possibly an original path location for the file in the Message-ID field. The content preparer **222** can provide the NNTP message to a propagation hub **232a** by posting the message to one or more NNTP newsgroups through appropriate use of the Newsgroups NNTP field. In an embodiment, the content preparer **222** uses the Newsgroups field to identify a channel or channels to which the delivery server **236** subscribes.

The propagation hub **232a** can run an application which manages the propagation of NNTP messages. In response to receiving messages from the content preparer **222**, the propagation hub **232a** can offer each message at state **5A** to any other propagation hub (e.g., the propagation hub **232b**) not known to already have the message. In certain embodiments, the propagation hub **232a** provides the message to propagation hubs **232** which indicate willingness to accept the message. The propagation hubs **232** may indicate this willingness by subscribing to one or more channels. The propagation hub **232a** may also provide the message at state **5B** to one or more delivery servers **236**, e.g., delivery servers **236** that are in a same data center as the propagation hub **232a**.

In certain embodiments, the propagation hubs **232** can differ from NNTP message routers in that they can detect and take action based on the specially-formatted NNTP Message-Ids set by the content preparer **222** as well as propagation instructions contained in the packaging of the file parts in the NNTP messages. Depending on the configuration of the propagation hub **232a** and propagation instructions in the messages, a message might be sent to other propagation hubs **232**, to all delivery servers **236**, to a subset of delivery **236** servers, or to a combination of the above. In one embodiment, a message is sent to all other propagation hubs **232** and a portion of the delivery servers **236** in the same location or data center as the propagation hub **332a**.

Each propagation hub **232** can open multiple channels to the other servers to which it is connected. Messages therefore can travel in parallel from one server to another. Consequently, in one embodiment, the propagation hub **232** may transfer one very large file to another delivery server **236** or

propagation hub **232** in less time compared with one large serial transfer because messages containing portions of the file can all travel at the same or substantially the same time. This effect can be particularly pronounced when multiple propagation hub **232** hops are used to send a message from one end of the CDN **220** to another.

In some implementations, a plurality of propagation hubs **232** can act like a bus architecture, where messages posted to one propagation hub **232** are delivered to other propagation hubs **232** that are listening for those messages. Each message may therefore be addressed to a set of channels, which may define which geographical regions those messages are sent to. Similarly, each propagation hub **232** may subscribe to one or more of those channels. A propagation hub **232** that is subscribed to a channel for one geographical region might therefore receive all messages directed to that region. A master channel may also be provide that allows messages to be sent to all propagation hubs **232**, regardless of which regions the propagation hubs **232** are individually subscribed to.

The propagation hub **232** can also propagate other types of messages between different servers, including inventory announcements from delivery servers **236** indicating which files are available to provide to end-users. Inventory announcements are described below. Another type of message the propagation hub **232** may propagate indicates an operation to be taken on the delivery servers **236**, such as deleting or renaming a file. Advantageously, in certain embodiments, because the inventory servers **234** know the location of all or substantially all the files in the CDN **220**, the propagation hubs **232** can propagate deletion, renaming, and other file operations quickly through the CDN **220**.

Propagation hubs **232** can be stackable: for operational stability and as the amount of traffic grows, a propagation hub **232** may be split into several propagation hub applications, each responsible for a subset of the hosts (e.g., delivery servers **236** and inventory servers **234**) or traffic for which the previous propagation hub **232** was responsible. For instance, a propagation hub **232** can be split such that one propagation hub **232** communicates with remote propagation hubs **232**, while another propagation hub **232** communicates with a group of delivery servers **236**. Alternately, a propagation hub **232** processing inventory and file propagation traffic might be split into two propagation hubs **232**, one processing inventory and the other processing file propagation.

Additionally, proper configuration of the content preparer **222** and the propagation hubs **232** may permit charging customers of the CDN **220** (e.g., content providers) for different levels of propagation. For example, different billing can be provided for propagation to delivery servers **236** in a subset of geographic locations, or redundant propagation to certain delivery servers **236**, including possibly every delivery server **236**, in several or all locations.

The delivery server **236** can receive NNTP messages from the propagation hub **232a** and manage the re-assembly of pieces of files into the original form in which they existed on the content origin **211**. Because of the parallel propagation of the file portions in certain embodiments, messages containing portions of files may arrive out of order. The delivery server **236**, in one implementation, can manage the file portions separately until sufficient portions are present to re-assemble them, when the delivery server **236** may reconstitute a file in its original form.

The delivery server **236** may re-organize files into the same or different directory structure from that in which the files existed on the content origin **211**. One delivery server **236** can manage files for many different customers. The delivery server **236** may be able to serve files to end-users directly via

11

HTTP, FTP, or other download protocol. If download delivery is not desired, for example in order to prevent users from saving copies of content, the delivery server **236** can provide tighter-controlled delivery of the re-assembled files to end users via a media-streaming protocol like the Real Time Mes-

saging Protocol (RTMP) or the Real Time Streaming Protocol (RTSP).
 When file re-assembly is complete or substantially complete, at state **6** the delivery server **236** can send an NNTP inventory message to one or more propagation hubs (e.g., the propagation hub **232b**) announcing the newly available file. The propagation hub **232b** can send these inventory messages on to the inventory server **234** at state **7**. In addition, the propagation hub **232b** can send the inventory messages to other propagation hubs **232**, which may provide the inventory messages to other inventory servers **234**.

At state **8**, an end user system **202** requests content from the content provider web site **210**. The content provider web site **210** may return a base web page and one or more URIs for content items hosted by the CDN **220** at state **9**. The end user system **202** can then use each URI to access the content. At state **10**, each URI directs the end user system **202** to an inventory server **234**. Each URI may direct the user to a possibly different inventory server **234**. In response to receiving the URI, each inventory server **234** can use the URI to consult an internal inventory to find a delivery server **236** where the content item can be downloaded from, or a list of one or more delivery servers **236** from which the content item can be streamed. Any inventory server **234** in the CDN **220** can be contacted by an end user system **202** and provide an acceptable reply.

At state **11**, for a given URI, the inventory server **234** redirects the end user system **202** to a delivery server **236**, e.g., by returning a uniform resource locator (URL) or IP address to the end user system **202**. For HTTP delivery, for example, the inventory server **234** can generate HTTP redirect messages giving the URL or IP address of a delivery server **236** known to host the file and suspected to be near the end user system **202**. In another embodiment, the inventory server **234** redirect in the TCP layer by sending a raw internet protocol (IP) datagram to the delivery server **236**, tearing down the connection between the end user system **202** and the inventory server **234**, and silently creating a new connection between the end user system **202** and the delivery server **236**. In still other embodiments, the inventory server **234** can redirect by using direct server return techniques (DSR). The end user system **202** can access the delivery server **236** using the URL (or IP address) at state **12**. In response, the delivery server **236** can provide the content item to the end user system **202** at state **13**.

Because the inventory server **234** can have explicit knowledge of the inventory of the delivery servers **236**, content delivery time can be reduced compared with existing cache-on-demand systems where the delivery server may be asked to serve content which it in turn has to request from another host. In addition, the content preparer **222** described above may designate channels for the propagation messages that refer to different delivery servers **236**. The content preparer **222** may use a load balancing algorithm to cycle through different delivery servers **236**, so as to perform load balancing on the delivery servers **236**.

In addition, the CDN **220** may provide other advantages in certain embodiments. For example, when content propagation is easy (e.g., there is little network congestion), it may be possible to serve as a hot backup for other CDNs on short notice. The inventory servers **234** may be provided with the URLs of another CDN's content, for instance. In response,

12

the inventory servers **234** can provide the other CDN with URI's to embed in the web pages or network applications of its customers. As a result, the CDN **220** can rapidly act as a backup for other CDNs. Another potential advantage in some implementations is that if content rises rapidly in popularity, the CDN **220** may be able to push the content to many delivery servers **236** quickly, on short notice, and without changing URIs for the content. This advantage can provide good response times for content delivery when demand is high.

Another advantage provided in certain embodiments is that the various roles of servers in the CDN **220** are segregated to allow for scalability. In certain embodiments, the propagation hubs **232** permit horizontal scalability, which can include the ability to provision additional small delivery servers **236** rather than replace small delivery servers **236** with large ones. The clean segregation of roles can reduce the cost of individual servers in the CDN **220** by reducing each server's hardware requirements, as compared with a solution where the roles of servers are less clear. For instance, the inventory servers **234** may have a significant portion of memory or RAM, a relatively lower capacity CPU, and relatively small hard disk space. Delivery servers **236** may have a large portion of memory or RAM, a relatively lower capacity CPU, and a relatively large, possibly slow hard disk.

Role segregation may also help vertical segregation, which can include the ability to host more traffic per server, by permitting the operating system of each server to focus on one type of work. Role segregation can also provide business scalability by permitting the scaling of one server's role based on shifting business demands. For instance, if content file sizes increase, the disk drives in the delivery servers **236** can be made larger without purchasing additional inventory servers. Conversely, if the average hit rate increases, the number of inventory servers **234** can be increased, without expanding delivery servers' **236** size or capacity. Other content delivery networks with less clear roles may require expansion of all components to expand the capacity in a single component.

In certain embodiments, this load balancing does not take into account the location of the end user systems **202**. Rather, an inventory server **234** contacted by the end user system **202** directs the user to a delivery server that may be close to the end user system **202**. Thus, the URI might direct the end user system **202** to a remote inventory server **234**, which in turn redirects the end user system **202** to a closer delivery server **236**.

Although the embodiments shown are described primarily in the context of NNTP messages, other push-based network protocols may be used to provision servers with content and inventory. For instance, IBM MQ Series protocols or a Tera-data architecture may be used in place of NNTP.

FIG. **3** illustrates a more detailed embodiment of a process flow **300** for propagating content files in a CDN. In the process flow **300**, two example data centers **330a**, **330b** of a CDN are shown. The data centers **330** and associated servers may include all of the features described above. The process flow **300** illustrates an example of parallel file propagation to multiple propagation hubs **332** in a fully-connected mesh.

At state **1**, a content file is provided from a content origin **311** to a content preparer **328** at a data center **330a**. In this example, the file is arbitrarily chosen to be a 90 megabyte (MB) movie file (designated "F" in the FIGURE). In certain embodiments, a software application on the content origin **311** (or on a client device connected to the content origin **311**) accesses a network application installed on the content preparer **328** to upload the file. In return, the content preparer **328** provides a URI for the file F at state **2**, which the content provider can embed into web pages, a web page generation

system, or any other network-enabled application which the content provider desires to deploy.

The content preparer **328** at state **3** splits the file into nine 10-megabyte NNTP message segments, indicated as “F1” through “F9” in the FIGURE. Any number of pieces may be used for a file; thus, nine pieces is merely illustrative. The content preparer **328** can package each message segment with meta-data about the total file F and the message segment. In addition, the content preparer **328** may generate extra messages containing checksums, parity calculations, or other integrity information for the file F. In addition, the content preparer **328** may generate extra messages containing digital rights management restrictions on the file F. At state **4**, the content preparer **328** in certain embodiments begins offering the file segments to the nearest propagation hub **332a**, via NNTP. The content preparer **328** may have been configured to use this propagation hub **332a** for this content provider, or the content preparer **328** may have selected the propagation hub **332a** randomly or according to performance metrics.

Once the propagation hub **332a** begins receiving NNTP messages containing the file parts F1-F9, it begins offering at states **5** and **6** these messages to other propagation hubs **332b**, **332c**, e.g., according to NNTP’s Flood Fill algorithm. Depending on the network load and on the network segments interconnecting the propagation hubs **332**, the propagation hub **332b** may receive some segments at state **7A** from a propagation hub **332c** before it receives them from the propagation hub **332a**. Likewise, the propagation hub **332c** may receive some segments from the propagation hub **332b** (state **7B**) before it receives them from the propagation hub **332a**.

For redundancy, the content preparer **328** may offer file segments F1-F9 to the propagation hub **332b** or the propagation hubs **332c** directly after offering them to the propagation hub **332a** or if a failure is detected. If the path from the propagation hub **332a** to the propagation hub **332b** has roughly the same distance as the path from the propagation hub **332a** to the propagation hub **332c**, and if the path between the propagation hub **332b** and the propagation hub **332c** is short, a possible result is that the propagation hub **332b** will receive half of its parts from the propagation hub **332a** and half from the propagation hub **332c**. If the propagation hub **332b** has already received a message segment, it can turn down that message segment when it receives it from other propagation hubs **332**. Because each propagation hub **332** can receive message segments from multiple propagation hubs **332**, in certain embodiments, the propagation hubs **332** may receive the message segments in a highly efficient amount of time.

In addition to offering file segments F1-F9 to other propagation hubs **332**, the propagation hub **332a** may provide the file segments to one or more of three nearby delivery servers **336a**, **336b**, and **336c** in the depicted embodiment. At state **8**, the propagation hub **332a** selects the delivery server **336** based at least partly on, for example, propagation instructions packaged in file segments F1-F9, the filename of F, and current network statistics known to the propagation hub **332a**, among other things. Upon selecting the delivery server **336**, the propagation hub **332a** sends the file segments to the delivery server **336** at state **9**. In the depicted embodiment, the propagation hub **332a** has sent the file segments to the delivery server **336b**.

The propagation hub **332a** may instead randomly select which delivery server(s) **336** receive the file. For example, the propagation hub **332a** could hash the filename of the file F into a number and perform a modulo operation on the number, such as a modulo of the number of servers (e.g., 3 servers in the present example). The propagation hub **332a** might then

send the file segments F1-F9 to the delivery server having the resulting number. To illustrate, if the filename were hashed into the number 14, $14 \bmod 3$ would equal 2. If one of the delivery servers **336** were logically assigned the number 2, the propagation hub **332a** could forward the file to that number 2 delivery server **336**.

Similarly, at state **8**, the propagation hub **332b** can likewise select one or more delivery servers **336** from its local servers **336d**, **336e**, or **336f**, and at state **9** send the file segments F1-F9 to that server **336**. In the depicted embodiment, the propagation hub **332a** has sent the file segments to the delivery server **336e**. The other propagation hubs **332c** can proceed in a similar fashion.

Once delivery servers **336b** and **336e** have received all or substantially all of the parts F1-F9 from propagation hubs **332**, each delivery server **336b**, **336e** can construct at state **10** an inventory change announcement indicating that the file F has been received. Each delivery server **336b**, **336e** can send this announcement as an NNTP message posted to a characteristic newsgroup or channel through use of the Newsgroups header field.

Each inventory message may further contain one or more URLs which can be used to access the re-assembled file. The delivery server **336b** can send this announcement at state **11** to the propagation hub **332a** via NNTP. At state **12**, the propagation hub **332a** can propagate the inventory announcement to other propagation hubs **332** and to the inventory server **334a** at state **13**. Similar actions may occur between the propagation hub **332b**, the delivery server **336e**, and the inventory server **334b**.

Upon receiving the inventory announcement, at state **14** the inventory server **334a** and the other inventory servers **334** may update their mappings of URIs to delivery servers **336** and thereby become ready to service user requests for the file F. At this point, the file F can be considered provisioned for delivery. The content provider can now use the URI for F in its web pages or other services.

Each delivery server **336** may include a mediator module **340** that keeps track of content demand. For ease of illustration, the mediator module **340** is depicted on only one of the delivery servers **336c**. As the demand for a file exceeds a particular bandwidth threshold, or as a particular server exceeds a bandwidth threshold, the mediator module **340** can notify a propagation hub **332**. For instance, the mediator module **340** can send an NNTP message requesting the propagation hub **332** to provision one or more files on additional delivery servers **336**.

In response, the propagation hub **332** may provision the files to additional servers **336**. Conversely, the mediator module **340** may determine that demand is below a threshold, and delete one or more files from the delivery server **336**. The mediator module **340** can send a message to a propagation hub **332**, requesting the propagation hub **332** to propagate a delete command for at least some of the files on other delivery servers **332**.

FIG. 4 illustrates an embodiment of a process flow **400** for providing content to end users via download. The process flow **400** includes an end user’s system **402**, a content provider web site **410**, a delivery server **436**, and an inventory server **434**, each of which may have all of the features described above. In addition, an end user’s Domain Name Service (DNS) server **460** and a server of last resort (SOLR) **450** are shown.

The end user’s DNS server **460** may be a local DNS server or the like that is provided by the end user’s ISP. The end user’s DNS server **460** can be the first DNS server contacted

by the end user system **402** when the end user system **402** requests a domain name resolution.

The SOLR **450** can include one or more servers that may be specially configured to host all content (or at least a portion thereof) on the CDN. In one embodiment, the SOLR **450** is not normally used for traffic delivery, but is used to attempt to service mis-routed requests or in failure scenarios. In some implementations, the SOLR **450** is a cluster of an inventory server and delivery servers, and may just be a designation of one such cluster which is otherwise in normal use.

In the process flow **400**, a file **F** has been designated for download delivery (e.g., via HTTP) when the content provider uploaded it to the CDN. The content provider has received a URI from the content preparer, and the content provider has published a web page or other network application containing that URI on the content provider web site **410**.

At state **1**, an end user, using the end user system **402**, accesses the content provider's web site **410**. The content provider web site **410** provides, at state **2**, a web page or other network application containing a URI for the file **F**. In an embodiment, this URI points to the inventory server **434** of the CDN, rather than to any servers hosted by the content provider.

An example URI might be as follows: `http://cdn.net/a4f2i3q1/cds/picture.jpg`. The first part of the URI refers to the HTTP protocol (`http://`). The hostname, `cdn.net`, can refer to an inventory server **434** of the CDN, or to multiple inventory servers with the same DNS name and IP address hosted in geographically separate locations. In one embodiment, anycast routing may therefore be used to connect the end user system **402** to one of a plurality of inventory servers **434**. The remainder of the URI, `/a4f2i3q1/cds/picture.jpg`, refers to the filename of the file **F** ("picture.jpg") and a path where it may be found (`/a4f2i3q1/cds/`). The characters `a4f2i3q1` may be generated in a variety of ways. For example, these characters can be a hash of the filename. The path need not be specified in certain embodiments, or the path and/or filename may also be hashed so as to mask the location of the file **F**. The path and filename may be the same as the path and filename on the content origin of the content provider, so as to reduce the coding burden on the content provider.

At state **3**, the end user system **402** traverses this URI by looking up the hostname in the URI with its DNS server **460**. At state **4**, the end user system **402** receives an IP address of the inventory server **434**. The end user system **402** (e.g., browser software on the system **402**) connects at state **5** to the inventory server **434**. The inventory server **434** replies at state **6** with, for example, an HTTP redirect to a URL containing the IP address of the delivery server **436**. The delivery server **436** in certain embodiments is known to the inventory server **434** to host the content based on the inventory announcements described above. This URL may be a modified version of the URI provided by the content provider web site **410**. An example URL might be as follows: `http://server5.d1.cdn.net/a4f2i3q1/cds/picture.jpg`. In this example, the hostname has been modified from `cdn.net` to a specific hostname for the delivery server **436**, `server5.d1.cdn.net`.

The end user system **402** contacts the delivery server **436** at state **7** and receives the file via HTTP at state **8a**. In one embodiment, the delivery server **436** is normally able to comply with the end user's request. If for some reason the delivery server **436** is unable to serve the content, for example because of a storage failure, the delivery server **436** may reply at state **8b** with another HTTP redirect. This redirect can include a URL which refers the end user system **402** to the SOLR **450**.

The end user system **402** can request the file, at state **9**, from the SOLR **450**. The SOLR **450** may reply with the file at state **10**.

FIG. **5** illustrates an embodiment of a process flow **500** for providing content to end users via streaming. The process flow **500** includes all of the components of the process flow **400**, each of which may have all of the functionality described above. In this example, a file **F** could be designated for streaming delivery by the content provider, through a service such as Windows Media Streaming. The content provider has received a URI from the content preparer, and the content provider has published a web page or other network application containing that URI on the content provider web site **410**.

At state **1**, the end user system **402** requests the content provider's web site **410** and receives, at state **2**, a web page or the like containing a streaming media player and a URI for a playlist which the player wishes to render. Alternatively, the end user system **402** may have previously downloaded the player. When the player activates, the end user system **402** looks up the hostname in the URI at state **3** and receives the IP address of the inventory server **434** at state **4**.

The player then connects at state **5** to the inventory server **434** and requests a playlist file. At state **6**, the inventory server **434** provides a playlist reply containing a URL for stream rendering of the file **F** on the delivery server **436**, based on inventory information. The inventory server **434** may also provide a URL of the SOLR **450**, in case the delivery server **436** is unable to stream the file **F**.

At state **7**, the player contacts the delivery server **436** and receives a media stream at state **8**. At state **9**, the player renders the stream. If for some reason the download server **436** is unable to serve the stream, the player contacts the SOLR **450** at state **10**. The SOLR **450** provides the stream at state **11**, and the player renders the stream at state **12**.

II. Usage Tracking Features

FIG. **6** illustrates an embodiment of a usage tracking system **600** for processing content usage in a CDN. The usage tracking system **600** includes delivery servers **636** and propagation hubs **632**, which may have all of the functionality described above. In addition, the usage tracking system **600** includes usage servers **670** and a billing server **608**, which are described below. Advantageously, in certain embodiments, some or all nodes or servers of the usage tracking system **600** batch or cross-tabulate content delivery or usage data prior to sending delivery data to other nodes. Thus, the usage tracking system **600** may be able to track delivery data more efficiently and faster than other CDNs. As a result, content providers may be provided with more recent usage data, enabling them to more accurately gauge changes in the popularity of content items.

In certain embodiments, the delivery servers **636** can produce delivery or usage data that includes log events for each content delivery attempt to end user systems (not shown). Each log event in the delivery data can include data corresponding to a number of delivery or usage attributes, such as the amount of data successfully transferred, timestamps of the beginning and end of user sessions, IP addresses of end-users, demographic information for end users in the form of HTTP cookies and headers, end-user client application names and versions, combinations of the same, and the like. For streaming protocols, the log events may also include stream start and stop events.

Each delivery server **636** may store the log events of the delivery data in volatile storage (e.g., memory). In addition, each delivery server **636** may store the log events persistently in a log data repository **642**, in case network failures or other problems prevent the delivery servers **636** from transmitting

the log events to other servers. For instance, the delivery servers **636** may store log events persistently in response to determining that a connection cannot be established with a usage server **670**.

Each delivery server **636** may include a delivery server manager (DSM) **660**, which can include one or more software components for managing log events on the delivery server **636**. The DSM **660** can obtain the log events from memory or from the log data repository **642**.

In certain embodiments, the DSM **660** packages, combines, aggregates, or otherwise batches delivery data into log messages for transmission to one of the usage servers **670**. For example, the DSM **660** can cross-tabulate the delivery data to condense or summarize the data. The DSM **660** cross-tabulates the data based on the delivery or usage attributes in certain embodiments. Some delivery attributes for which cross-tabulations can be performed may be directly contained in the log events, such as the IP addresses of the originating requests, the names of the requested files, the IP address of various delivery servers **636**, the content items which were downloaded or streamed, an amount of bytes or the like of content items that were successfully delivered, affiliate-based codes for affiliates of the content provider, product based identifiers related to content files, and the like.

Other delivery attributes can be calculated by the DSM **660** through use of lookup tables, such as the geographic regions where the user IP addresses originated or autonomous system numbers which own the IP addresses. Other delivery attributes can be calculated via mathematical operations on the fields in the log events, such as number of attempts, total bytes transferred, session duration, throughput, download or streaming completion percentage, and the like. For example, a completion percentage can be calculated by dividing a number of bytes actually downloaded of a file by the size of the file. In some embodiments, the completion percentage or other delivery attributes can be determined by the usage servers **670** or by the billing server **680** (see below).

As one example, one log event might include data regarding a first content item for which 40 KB was downloaded of a 100 KB file to a user system having a first IP address. A second log event might include data regarding the same content item for which 80 KB was downloaded of the same 100 KB file to a second user system having a second IP address. The DSM **660** might cross-tabulate these log events by combining the download amounts to equal 40 KB+80 KB=120 KB. The DSM **660** might also calculate that the downloads had an average 60% completion rate between the two users. Additionally, the DSM **660** might lookup each IP address in a lookup table and determine that both user systems are in California. The DSM **660** may provide this cross-tabulated usage data in a message to the propagation hub **632**, instead of a separate message for each log event. As a result, in certain embodiments, the DSM **660** can reduce the number of log messages sent over the network.

By sending a message having data from multiple log events, as well as at least some accumulated data, in certain embodiments the DSM **660** can reduce a volume and/or size of log messages sent over the CDN. In one embodiment, the DSM **660** formats and sends the log messages according to NNTP. The DSM **660** can send the log message in response to one or more usage-based triggering actions. These actions might include the DSM **660** determining that enough log event data has been accumulated by volume (e.g., according a number of access requests or bytes delivered) or by financial value, or enough traffic has accumulated per file or IP address or content provider, or that enough time has passed since the last time an NNTP message was sent, or the like. The DSM

660 may also send log messages to the usage server **670** on a configurable periodic basis, such as each minute, each hour, each day, each week, or the like.

If a DSM **660** is unable to contact its designated usage server **670** or a propagation hub **632**, the DSM **660** can persistently queue log messages destined for that usage server **670** in the non-volatile data repository **642** for periodic re-attempts. In certain embodiments, this makes the usage tracking system **600** robust against transient communication failures.

Each usage server **670** may run an NNTP application or the like which receives messages containing accumulated log events from one or more DSMs **660**. For some configurations, to enhance speed, the usage servers **670** may have an average amount of memory or RAM and a relatively fast, small hard disk. Although not shown, the messages may have been handled intermediately by a propagation hub. Like the delivery servers **636**, the usage servers **670** can batch, aggregate, or otherwise cross-tabulate log events received in log messages from delivery servers **636**. The usage server **670** can cross-tabulate log events based on values for attributes of the log events, such as originating geographic region or requested file. For example, if one delivery server **636** reports that 1.2 GB of data were downloaded for a given file, and another delivery server **636** reports that 656 MB were downloaded of the same file, the usage server **670** can cross-tabulate these amounts to produce 1.856 GB downloaded for that file.

Some delivery attributes for which cross-tabulations can be performed may be the same as those performed by the delivery servers **636**. For example, the delivery attributes can be directly contained in the log events, such as the IP address of the originating requests, the names of the requested files, the IP address of various delivery servers **636**, product based identifiers related to content files, and the content items which were downloaded or streamed. Other delivery attributes can be calculated by the usage server **670** through use of lookup tables, such as the geographic region where the user IP address originates or autonomous system numbers which own the IP addresses.

Other delivery attributes can be calculated via mathematical operations on the fields in the log events, such as number of attempts, total bytes transferred, session duration, throughput, download or streaming completion percentage, and the like. The delivery servers **636** and usage servers **670** can be configured to cross-tabulate different types of log events or the same types of log events. In certain embodiments, the delivery servers **636** do not cross-tabulate log events, and only the usage servers **670** and the billing server **680** cross-tabulate events.

When a usage server **670** has accumulated a high enough volume of usage information for a given attribute value, or the financial value of the usage information is high enough, or enough traffic has accumulated per file or IP address or content provider, or enough time has passed since the usage information was received, the usage server **670** can send an NNTP message to a propagation hub **632** giving the cross-tabulated usage. In some cases, the usage server **670** may pass at least some of the original log event NNTP messages on to the propagation hub **632**. If the propagation hub **632** is unavailable, then the usage server **670** can store the NNTP message in non-volatile storage for later sending. The arrival of a message from a DSM **660** may thus only be loosely coupled to the sending of a message from the usage server **670** to the propagation hub **632** in certain embodiments.

Each propagation hub **632** can forward the messages it receives from usage servers **670** on to a billing server **680**. For each message the billing server **680** receives, the billing

server **680** can cross-tabulate the delivery data in the message with data stored in a provider database **690**. Like the usage servers **670**, the billing server **608** can cross-tabulate the delivery data in the provider database **690** based on attributes. Thus, in addition to providing accurate and recent billing data, the provider database **690** can provide content providers with access to useful statistics about the delivery data, such as completion percentage, geographic distribution of content requests, and so forth. A user interface (UI) module **682** may, for instance, provide content providers with access to the data stored in the provider database **690**.

In certain embodiments, the usage tracking system **600** has at least the following advantages over existing log-harvesting CDN architectures. First, the system **600** can be robust against node and network failures. If a DSM **660** or usage server **670** is temporarily or permanently disabled, in certain embodiments only the in-memory usage data is lost. If network connectivity between servers is temporarily disrupted, persistent storage of messages in the interim can cause usage data to be delivered once network connectivity is restored.

Second, the system can be horizontally scalable by adding additional DSM **660** or usage server **670** instances in any role. If the volume of usage information from DSMs **660** that is to be processed in a service provider facility exceeds the capability of a single usage server **670**, additional usage servers **670** can be installed and the DSMs **660** can be partitioned amongst the old and new usage servers **670**.

Third, the usage tracking system **600** can provide better-than-linear vertical scaling as the volume of usage information increases. If the total delivery rate of delivery servers **636** doubles, the totals in the summary data in the usage messages can double, but the number of messages may not double. Since the processing time can be proportional to the number of messages, the usage tracking system **600** can be robust against both sustained and transient traffic increases.

FIG. 7 illustrates an embodiment of a process flow **700** for processing content usage in a CDN. The process flow **700** includes several components described above, such as end user systems **702**, delivery servers **736**, propagation hubs **732**, usage servers **770**, and a billing server **780**. These components may have all of the functionality described above. Advantageously, in certain embodiments, the process flow **700** enables usage of content in the CDN to be tracked more efficiently and faster than in other CDNs.

In the following example process flow **700**, simplified example numerical values are used, illustrating batching of the delivery attributes of bytes downloaded and number of access requests. However, these values are merely illustrative. At state **1**, an end user system **702a** downloads two 110-kilobyte (KB) files hosted on behalf of a content provider, from a delivery server **736a**. The delivery server **736a** includes a DSM **706a** that sends, at state **2**, a raw usage message **M1** to a usage server **770a**. The message **M1** indicates 220 KB of usage and two downloads. The message **M1** may contain summary data for the downloads, rather than individual records of the downloads themselves.

At approximately the same time in this example, an end user system **702b** downloads a 120 KB file hosted on behalf of the same content provider, from delivery server **736b** (state **3**). The delivery server **736b** includes a DSM **706b** that sends, at state **4**, a usage message **M2** to the usage server **770a**. The message **M2** indicates 120 KB of usage and one download. The message **M2** may contain summary or batched data for the download, rather than an individual record of the download.

Also approximately the same time in this example, an end user system **702c** downloads a 210 KB file hosted on behalf of

the same content provider, from a delivery server **736c** (state **5**). The delivery server **736c** sends, at state **6**, a message **M3** to a usage server **770b**. The message **M3** indicates 210 KB of usage and one download. The message **M2** may contain summary or batched data for the download, rather than an individual record of the download.

At state **7**, when the usage server **770a** receives the message **M1**, it adds 220 KB of usage and two downloads to an in-memory table (not shown) for the content provider. At state **8**, when the usage server **770a** receives the message **M2**, it adds 120 KB of usage and one download to the same in-memory table, giving a total of 340 KB of usage and three downloads. Thus, the usage server **770a** cross-tabulates the event data from the two messages **M1** and **M2**.

The usage server **770a** sends a message **M4**, which indicates a total usage of 340 KB and three downloads, to a propagation hub **732a** at state **9**. When the message **M4** has been successfully sent to the propagation hub **732a**, or the message has been committed to non-volatile storage for later re-attempt, the usage server **770a** may clear the in-memory totals for the content provider at state **10**.

When the usage server **770b** receives the message **M3**, it adds 210 KB of usage and one download to in-memory storage tables for the content provider at state **11**. At state **12**, the usage server **770b** sends a message **M5** to a propagation hub **732b**, indicating a total usage of 210 KB and one download. When the propagation hub **732b** receives the message **M4**, it sends the message on to the propagation hub **732a** at state **13**.

When the propagation hub **732a** receives the messages **M4** and **M5**, the propagation hub **732a** sends both messages on to a billing server **780** at states **14** and **16**. When the billing server **780** receives the message **M4**, it cross-tabulates data in the messages by incrementing fields in a provider database **790** at state **15** to reflect an additional 340 KB of data usage and three more downloads. Similarly, when the billing server **780** receives the message **M5**, it increments fields in the provider database **790** at state **17** to reflect an additional 210 KB of data usage and one download. A content provider user can access the updated usage data in the provider database via a user interface (UI) module **782** at state **18**.

FIG. 8 illustrates an embodiment of a process **800** for tracking usage in a CDN. The process **800** may be performed by any of the systems described above. In particular, in certain embodiments, the process **800** is performed by the usage tracking system **600**.

At block **802**, usage data for a plurality of delivery servers is determined. The usage data may include log events corresponding to end user accesses of content stored on the delivery servers. This block may be performed by a DMS installed on each of the delivery servers. At block **804**, the usage data is provided from each delivery server to a usage server. This block may also be performed by the DMS. In an embodiment, the DMS does not send each log event individually to the usage server but instead packages a set of log events in a single message for transmission to the usage server. Alternatively, the DMS may send at least some individual log events to the usage server. This may occur, for example, if a single log event has occurred during an entire period in which the DMS customarily sends log messages.

At block **806**, the usage server may be used to accumulate the usage data received from each delivery server. This block may include cross-tabulating usage statistics for a variety of attributes of each log event described in the log messages. After a period of time, the accumulated usage data is provided to a billing server at block **808**. The usage data may be provided at periodic, scheduled times, in response to a certain volume of data being accumulated, or the like. The usage data

may be provided to the billing server by the usage server, through possibly one or more propagation hubs. At block **810**, the billing server may be used to cross-tabulate the accumulated usage data with usage data stored in a provider database.

FIGS. **9** through **12** illustrate example administrative displays **900** through **1200** for viewing usage data related to the CDN. The administrative displays **900** through **1200** may be created, for example, by the UI module **682** or **782** described above. Advantageously, in certain embodiments, the administrative displays **900** through **1200** enable content providers to see accurate, recent usage data. The displays shown are merely illustrative, and many other configurations of the displays may be provided in other embodiments.

Referring to FIG. **9**, the display **900** provides an overview of a content provider's usage statistics. A usage summary **910** displays hits, durations, and transfers for a variety of download and streaming technologies. Some example technologies displayed include CDS (HTTP downloads), FMS (Flash Media), FLS (Flash Live Streaming), WMS (Windows Media), and WLS (Windows Live Streaming). Also shown are download hit counts **920** over the previous 24-hour period and download durations **930** over the same period.

Advantageously, this up-to-date, recent usage data is made possible in certain embodiments by the streamlined usage tracking techniques described above. For example, the transmission of accumulated log events to the billing server, rather than individual log events, can result in faster usage data updating than in systems that cross-tabulate all log events in a provider database. Content providers may use this up-to-date data to analyze the popularity of downloads and streams, for example, and adjust the content they provide accordingly.

Turning to FIG. **10**, various measures **1010** of usage data are shown for longer time periods than in FIG. **9**. In addition, aggregate completion statistics **1020** are shown, which indicate to what extent files that users started to access were fully downloaded or streamed. Item-specific completion statistics **1120** are shown in FIG. **11**. Content providers may use these statistics **1020** to determine which content items are more popular with users.

Completion statistics **1020**, **1120** can be useful for market testing of various items. For instance, a content provider might release two movie trailers online and analyze the completion statistics **1020**, **1120** to determine which trailer is being more completely downloaded or streamed. The trailer that is being completely accessed more may be more popular with users. The content provider may then decide to exclusively show the more popular trailer, or adjust the degree to which one trailer is shown. Content providers may also use these techniques with online games, advertisements, and the like. Other statistics shown in the display **1100**, such as hits, duration, actual transfers, and so on, may be used in a similar manner.

Referring to FIG. **12**, the display **1200** includes geographical statistics **1230**. The geographical statistics **1230** can show the popularity of content items in different parts of the world. A map (not shown) may also be provided to give a visual depiction of the popularity of content across the world. This information can assist content providers in market research regarding geographical preferences. For instance, content providers can use this data in A-B market testing, where the content provider deploys two advertisements (ad A and ad B) in different geographical regions. The content provider can analyze the geographical statistics **1230** to determine which advertisement is being clicked on more, being viewed completely, and so forth. Advantageously, in certain embodi-

ments, the recency of these statistics **1230** is made possible by the accumulation features of the usage tracking system described above.

CONCLUSION

The various blocks and modules of the systems described herein can be implemented as software applications, hardware and/or software modules, or components on one or more machines, such as computers, servers, or the like. While the various modules are illustrated separately, they may share some or all of the same underlying logic or code. In addition, each of the processes, components, and algorithms described above may also be embodied in, and fully automated by, modules executed by one or more computers or computer processors. The modules may be stored on any type of computer-readable medium or computer storage device. In addition, in some embodiments, certain processes, components, and algorithms described herein may be implemented monolithically.

The processes and algorithms may also be implemented partially or wholly in application-specific circuitry. The results of the disclosed processes and process states may be stored, persistently or otherwise, in any type of computer storage. In one embodiment, the modules may be configured to execute on one or more processors, including sub-processors. In addition, the modules may comprise, but are not limited to, any of the following: software or hardware components such as software object-oriented software components, class components and task components, processes methods, functions, attributes, procedures, subroutines, segments of program code, drivers, firmware, microcode, circuitry, data, databases, data structures, tables, arrays, variables, combinations of the same, and the like.

The various features and processes described above may be used independently of one another, or may be combined in various ways. All possible combinations and subcombinations are intended to fall within the scope of this disclosure. In addition, certain method or process blocks or states may be omitted in some implementations. The methods and processes described herein are also not limited to any particular sequence, and the blocks, states, or states relating thereto can be performed in other sequences that are appropriate. For example, described blocks, states, or states may be performed in an order other than that specifically disclosed, or multiple blocks, states, or states may be combined in a single block, state, or state.

Conditional language used herein, such as, among others, "can," "could," "might," "may," "e.g.," and the like, unless specifically stated otherwise, or otherwise understood within the context as used, is generally intended to convey that certain embodiments include, while other embodiments do not include, certain features, elements and/or states. Thus, such conditional language is not generally intended to imply that features, elements and/or states are in any way required for one or more embodiments or that one or more embodiments necessarily include logic for deciding, with or without author input or prompting, whether these features, elements and/or states are included or are to be performed in any particular embodiment.

While certain embodiments of the inventions disclosed herein have been described, these embodiments have been presented by way of example only, and are not intended to limit the scope of the inventions disclosed herein. Indeed, the novel methods and systems described herein may be embodied in a variety of other forms; furthermore, various omissions, substitutions and changes in the form of the methods

and systems described herein may be made without departing from the spirit of the inventions disclosed herein. The accompanying claims and their equivalents are intended to cover such forms or modifications as would fall within the scope and spirit of certain of the inventions disclosed herein. 5

What is claimed is:

1. A method of providing content to end users from a content delivery network, the method comprising:

storing inventory information in an inventory of each of a plurality of inventory servers in a content delivery network, the inventory information describing which delivery servers within the content delivery network hosts a media file;

providing a uniform resource indicator (URI) corresponding to the media file, the URI configured to identify multiple ones of the inventory servers;

receiving, at a first one of the inventory servers, a request for the media file from a user system, the request specifying the URI and configured to access the first inventory server via anycast routing;

in response to receiving the request for the media file, accessing the inventory of the first inventory server to identify a selected one of the delivery servers within the content delivery network that hosts the media file, based at least in part on geographic proximity of the selected delivery server to the user system; and

redirecting the request for the media file from the first inventory server to the selected delivery server within the content delivery network, thereby enabling the user system to access the media file from the selected delivery server within the content delivery network. 30

2. The method of claim 1, wherein said redirecting the request comprises performing an HTTP redirect.

3. The method of claim 1, wherein said redirecting the request comprises sending an internet protocol (IP) datagram to the selected delivery server, thereby enabling a new connection to be created between the user system and the selected delivery server. 35

4. The method of claim 1, wherein the anycast routing enables the first one of the inventory servers to be selected as a relatively more geographically proximate server to the user system than others of the inventory servers. 40

5. The method of claim 1, further comprising provisioning the media file to a subset of the delivery servers in the content delivery network. 45

6. The method of claim 5, further comprising providing to the plurality of inventory servers a message from each of the delivery servers that was provisioned with the media file, the message announcing the receiving of the media file. 50

7. The method of claim 6, wherein the message comprises location information identifying a location of the media file on the respective delivery server.

8. A method of accessing content from a content delivery network, the method comprising:

receiving a uniform resource indicator (URI) corresponding to a media file at a user system comprising computer hardware;

submitting a request for delivery of the media file from the user system, the request being submitted to the URI, the URI configured to identify a plurality of inventory servers in a content delivery network;

receiving a response at the user system from a first one of the inventory servers selected via anycast routing, the first inventory server comprising an inventory describing which delivery servers within the content delivery network host the media file; 65

receiving a redirected connection at the user system from the first inventory server to a selected one of the delivery servers that hosts the media file and that has closer geographic proximity to the user system than another of the delivery servers within the content delivery network; and

receiving the media file at the user system from the selected delivery server.

9. The method of claim 8, wherein the redirected connection is configured to be performed as an HTTP redirect.

10. The method of claim 8, wherein the computer system further comprises a plurality of computing devices.

11. The method of claim 8, further comprising: provisioning the media file to a subset of the delivery servers in the content delivery network; and

providing to the plurality of inventory servers a message from each of the delivery servers that was provisioned with the media file, the message announcing the receiving of the media file, wherein the message comprises location information identifying a location of the media file on the respective delivery server.

12. A system for providing content to end users from a content delivery network, the system comprising:

a plurality of edge nodes in a content delivery network, at least some of the edge nodes hosting a media item;

a content origin server in the content delivery network, the content origin server configured to provide a uniform resource indicator (URI) corresponding to the media item, the URI configured to identify multiple ones of a plurality of inventory servers in the content delivery network; and

means for distributing inventory decisions amongst the plurality of inventory servers in the content delivery network, whereby each of the inventory servers is configured to obtain an inventory specifying locations of the media item in the edge nodes within the content delivery network, wherein each of the inventory servers are configured to:

process requests received from end user systems for access to the media item, the requests each specifying the URI for the media item, and

enable the end user systems to connect to a selected one of the edge nodes within the content delivery network based on the inventory stored with the inventory server and based at least in part on geographic proximity of the selected one of the edge nodes to the end user systems, thereby enabling the end user systems to access the media item from the selected edge node within the content delivery network.

13. The system of claim 12, wherein the means for distributing the inventory decisions comprises one or more of the following: an inventory server, a propagation server, and a delivery server.

14. The system of claim 12, wherein each of the inventory servers is further configured to enable the end user systems to connect to the selected edge node by implementing a redirection mechanism. 55

15. The system of claim 12, wherein the inventory decisions comprise determining which of the edge nodes to connect to the end user systems.

16. The system of claim 12, wherein the inventory decisions comprise determining which items of inventory are to be used to satisfy the requests.

17. The system of claim 12, wherein the means for distributing inventory decisions is configured to update the inventory in the plurality of inventory servers based on inventory announcements from the edge nodes that host the media item.

18. The system of claim 17, wherein the inventory announcements comprising location information corresponding to the media item.

* * * * *

UNITED STATES PATENT AND TRADEMARK OFFICE
CERTIFICATE OF CORRECTION

PATENT NO. : 8,621,106 B2
APPLICATION NO. : 13/159282
DATED : December 31, 2013
INVENTOR(S) : Gagliardi et al.

Page 1 of 1

It is certified that error appears in the above-identified patent and that said Letters Patent is hereby corrected as shown below:

In the Claims

In column 23 at line 66, In Claim 8, after “servers” delete “i”.

Signed and Sealed this
First Day of July, 2014



Michelle K. Lee
Deputy Director of the United States Patent and Trademark Office