

US008518671B2

(12) **United States Patent**
Grenier et al.

(10) **Patent No.:** **US 8,518,671 B2**
(45) **Date of Patent:** ***Aug. 27, 2013**

(54) **SOLID SUPPORT ASSAY SYSTEMS AND METHODS UTILIZING NON-STANDARD BASES**

(75) Inventors: **Jennifer K. Grenier**, Madison, WI (US); **David J. Marshall**, Madison, WI (US); **James R. Prudent**, Madison, WI (US); **Craig S. Richmond**, Madison, WI (US); **Eric B. Roesch**, Oregon, WI (US); **Christopher W. Scherrer**, Rio, WI (US); **Christopher B. Sherrill**, Madison, WI (US); **Jerod L. Ptacin**, Beloit, WI (US)

(73) Assignee: **Luminex Corporation**, Austin, TX (US)

(*) Notice: Subject to any disclaimer, the term of this patent is extended or adjusted under 35 U.S.C. 154(b) by 0 days.

This patent is subject to a terminal disclaimer.

(21) Appl. No.: **13/478,586**

(22) Filed: **May 23, 2012**

(65) **Prior Publication Data**

US 2012/0295808 A1 Nov. 22, 2012

Related U.S. Application Data

(60) Division of application No. 11/490,319, filed on Jul. 20, 2006, now Pat. No. 8,217,160, which is a continuation of application No. 11/284,307, filed on Nov. 19, 2005, now Pat. No. 7,892,796, which is a continuation of application No. 09/977,615, filed on Oct. 15, 2001, now Pat. No. 6,977,161, and a continuation-in-part of application No. 09/861,292, filed on May 18, 2001, now Pat. No. 7,422,850.

(60) Provisional application No. 60/293,259, filed on May 22, 2001, provisional application No. 60/282,831, filed on Apr. 10, 2001, provisional application No. 60/240,397, filed on Oct. 14, 2000, provisional application No. 60/240,398, filed on Oct. 14, 2000, provisional application No. 60/205,712, filed on May 19, 2000.

(51) **Int. Cl.**

C12P 19/34 (2006.01)
C12Q 1/68 (2006.01)
C07H 21/02 (2006.01)
C07H 21/04 (2006.01)
C07H 21/00 (2006.01)

(52) **U.S. Cl.**

USPC **435/91.2**; 435/6.1; 435/6.11; 435/6.12; 435/91.1; 536/23.1; 536/24.3; 536/24.33; 536/25.3

(58) **Field of Classification Search**

USPC 435/6.1, 6.11, 6.12, 91.1, 91.2, 91.51, 435/183, 287.1, 287.2; 436/94, 501; 536/23.1, 536/24.3, 24.33, 25.3

See application file for complete search history.

(56) **References Cited**

U.S. PATENT DOCUMENTS

4,458,066 A 7/1984 Caruthers et al.
4,683,195 A 7/1987 Mullis et al.
4,683,202 A 7/1987 Mullis
4,800,159 A 1/1989 Mullis et al.
4,996,143 A 2/1991 Heller et al.
5,200,314 A 4/1993 Urdea
5,210,015 A 5/1993 Gelfand et al.
5,432,272 A 7/1995 Benner
5,589,329 A 12/1996 Winkler et al.
5,604,097 A 2/1997 Brenner
5,605,794 A 2/1997 Rust et al.
5,654,138 A 8/1997 Lerman
5,679,524 A 10/1997 Nikiforov et al.
5,681,702 A 10/1997 Collins et al.
5,736,330 A 4/1998 Fulton
5,780,233 A 7/1998 Guo et al.
5,843,669 A 12/1998 Kaiser et al.
5,846,717 A 12/1998 Brow et al.
5,856,092 A 1/1999 Dale et al.
5,866,337 A * 2/1999 Schon 435/6.18
5,928,869 A 7/1999 Nadeau et al.
5,965,364 A 10/1999 Benner
5,980,861 A 11/1999 Hnatowich et al.
6,001,983 A 12/1999 Benner
6,007,984 A 12/1999 Wang et al.
6,037,120 A 3/2000 Benner
6,046,807 A 4/2000 Chandler

(Continued)

FOREIGN PATENT DOCUMENTS

EP 0 382 433 8/1990
EP 0 416 815 3/1991

(Continued)

OTHER PUBLICATIONS

Beaucage et al., "Deoxynucleoside phosphoramidites—A new class of key intermediates for deoxypolynucleotide synthesis," *Tetrahedron Letters*, 22(20): 1859-1862, 1981. Borer et al., "Stability of ribonucleic acid double-stranded helices," *J. Mol. Biol.*, 86(4):843-853, 1974.

Brown et al., "Chemical synthesis and cloning of tyrosine tRNA gene," *Methods in Enzymology*, 68:109-51, 1979.

Bult et al., "Complete genome sequence of the ethanogenic archaeon, *Methanococcus jannaschii*," *Science*, 273:1058-1073, 1996.

Cantor, "Lighting up hybridization," *Nature Biotechnology*, 14(3):264, 1996.

Chou et al., "Solid-phase synthesis and high-resolution NMR studies of two synthetic double-helical RNA dodecamers: r(CGCGAAUUCGCG) and r(CGCGUAUACGCG)," *Biochemistry*, 28:2422-2435, 1989.

(Continued)

Primary Examiner — Frank Lu

(74) *Attorney, Agent, or Firm* — ParkerHighlander PLLC

(57) **ABSTRACT**

Solid support assays using non-standard bases are described. A capture oligonucleotide comprising a molecular recognition sequence is attached to a solid support and hybridized with a target. In some instances, the molecular recognition sequence includes one or more non-standard bases and hybridizes to a complementary tagging sequence of the target oligonucleotide. In other instances, incorporation of a non-standard base (e.g., via PCR or ligation) is used in the assay.

12 Claims, 17 Drawing Sheets

(56)

References Cited

U.S. PATENT DOCUMENTS

6,057,107	A	5/2000	Fulton	
6,077,668	A	6/2000	Kool	
6,140,496	A	10/2000	Benner	
6,232,462	B1	5/2001	Collins et al.	
6,287,766	B1	9/2001	Nolan et al.	
6,294,336	B1	9/2001	Boyce-Jacino et al.	
6,511,809	B2	1/2003	Baez et al.	
6,548,250	B1	4/2003	Sorge	
6,783,985	B1	8/2004	Roemer et al.	
6,830,889	B1	12/2004	Matsumoto et al.	
6,833,257	B2	12/2004	Lee et al.	
6,977,161	B2*	12/2005	Grenier et al.	435/91.2
7,033,757	B2	4/2006	Makrigiorgos	
7,892,796	B2*	2/2011	Prudent et al.	435/91.2
2002/0132221	A1	9/2002	Chee et al.	
2003/0194705	A1	10/2003	Schroth	

FOREIGN PATENT DOCUMENTS

EP	0 416 817	3/1991
EP	0 742 287	11/1996
EP	0 915 174	5/1999
WO	WO 90/06042	6/1990
WO	WO 94/21820	9/1994
WO	WO 96/31622	10/1996
WO	WO 97/46711	12/1997
WO	WO 98/14610	4/1998

OTHER PUBLICATIONS

Cobianchi and Wilson, "Enzymes for modifying and labeling DNA and RNA," *Methods in Enzymology*, 152:94-110, 1987.

Dong et al., "Flexible use of high-density oligonucleotide arrays for single-nucleotide polymorphism discovery and validation," *Genome Research*, 11(8):1418-1424, 2001.

European Search Report for Application No. 01 981 538, dated Jan. 25, 2005.

Examiner's First Report for Australian Application No. 2002213175, dated Mar. 17, 2006.

Examiner's First Report in Australian Application No. 2001271254, dated Oct. 17, 2005.

Examiner's Report issued in Canadian Application No. 2,425,747, dated Dec. 21, 2009.

Examiner's Second Report for Australian Application No. 2002213175, dated May 17, 2007.

First Office Action for Chinese Application No. 01812665, dated Oct. 14, 2005.

First Office Action for Chinese Application No. 01820515, dated Mar. 24, 2006.

Guatelli et al., "Isothermal, in vitro amplification of nucleic acids by a multienzyme reaction modeled after retroviral replication," *Proc. Nat'l. Acad. Sci.*, 87:1874-1878, 1990.

Hacia et al., "Detection of heterozygous mutations in BRCA1 using high density oligonucleotide arrays and two-colour fluorescence analysis," *Nature Genetics*, 14:441-447, 1996.

Hosfield et al., "Newly discovered archaeobacterial flap endonucleases show a structure-specific mechanism for DNA substrate binding and catalysis resembling human flap endonuclease-1," *J. Biol. Chem.*, 273(42):27154-27164, 1998.

International Search Report for PCT/US2001/16359, dated Mar. 19, 2003.

International Search Report for PCT/US2001/31993, dated Jul. 8, 2003.

Jain, "Applications of biochip and microarray systems in pharmacogenomics," *Pharmacogenomics*, 1(3):289-307, 2000.

Jurczyk et al., "Synthesis of 2'-deoxyisoguanosine 5'-triphosphate and 2'-deoxy-5-methylisocytosine 5'-triphosphate," *Helvetica Chimica Acta*, 82:1005-1015, 1999.

Kälin et al., "Evaluation of the ligase chain reaction (LCR) for the detection of point mutations," *Mutat. Res.*, 283(2):119-123, 1992.

La Rocco et al., "Evaluation of a commercial rRNA amplification assay for direct detection of Mycobacterium tuberculosis in processed sputum," *Eur. J. Clin. Microbiol. Infect. Dis.*, 13(9):726-731, 1994.

Livak et al., "Oligonucleotides with fluorescent dyes at opposite ends provide a quenched probe system useful for detecting PCR product and nucleic acid hybridization," *PCR Methods and Applications*, 4(6):357-362, 1995.

Lizardi et al., "Mutation detection and single-molecule counting using isothermal rolling-circle amplification," *Nat. Genet.*, 19(3):225-232, 1998.

McMinn et al., "Efforts toward expansion of the genetic alphabet: DNA polymerase recognition of a highly stable, self-pairing hydrophobic base," *J. Am. Chem. Soc.*, 121(49):11585-6, 1999.

Narang et al., "Improved phosphotriester method for the synthesis of gene fragments," *Methods in Enzymology*, 68:90-98, 1979.

Newton et al., "The production of PCR products with 5' single-stranded tails using primers that incorporate novel phosphoramidite intermediates," *Nucleic Acids Research*, 21(5):1155-1162, 1993.

Nolan et al., "SNP scoring for drug discovery applications," In: *Integrated Technologies for Drug Discovery*, Houn-Ya Mei and Anthony W. Czamik, Eds., New York: Marcel Dekker, Inc., Chapter 6, pp. 145-161, 2002.

Notice of Acceptance for Australian Application No. 2001271254, dated Apr. 23, 2007.

Notice of Reasons for Rejection for Japanese Application No. 2002-536094, dated Sep. 21, 2007.

Office Action for EP Application No. 01 950 231.9, dated May 16, 2007.

Office Action for EP Application No. 01 981 538, dated Feb. 1, 2005.

Office Action for EP Application No. 01 981 538, dated Nov. 21, 2005.

Office Action for EP Application No. 01 981 538, dated Sep. 9, 2004.

Office Action for EP Application No. 01 981 538, dated Sep. 25, 2006.

Office Communication issued in Chinese Patent Application No. 01812665.0, dated Sep. 12, 2008. (English translation).

Office Communication issued in European Patent Application No. 01 950 231.9, dated Jul. 30, 2009.

Office Communication issued in Japanese Patent Application No. 2002-536094, dated Mar. 16, 2009. (English translation).

Office Communication issued in Japanese Patent Application No. 2001-586611, dated Apr. 11, 2012. (English translation).

Office Communication issued in Japanese Patent Application No. 2001-586611, dated Feb. 23, 2011. (English translation).

Office Communication issued in U.S. Appl. No. 11/490,319, dated Dec. 8, 2010.

Office Communication issued in U.S. Appl. No. 11/490,319, dated Jun. 14, 2010.

Office Communication issued in U.S. Appl. No. 11/490,319, dated Feb. 2, 2010.

Office Communication issued in U.S. Appl. No. 11/490,319, dated May 28, 2009.

Office Communication issued in U.S. Appl. No. 11/490,319, dated Jan. 28, 2009.

Office Communication issued in U.S. Appl. No. 11/284,307, dated Aug. 10, 2010.

Office Communication issued in U.S. Appl. No. 11/284,307, dated Dec. 16, 2009.

Office Communication issued in U.S. Appl. No. 11/284,307, dated Nov. 17, 2008.

Office Communication issued in U.S. Appl. No. 11/284,307, dated Apr. 30, 2008.

Office Communication issued in U.S. Appl. No. 11/284,307, dated Jan. 11, 2008.

Office Communication issued in U.S. Appl. No. 09/977,615, dated Jun. 1, 2004.

Office Communication issued in U.S. Appl. No. 09/977,615, dated Jul. 31, 2003.

Office Communication issued in U.S. Appl. No. 09/861,292, dated May 21, 2003.

Office Communication issued in U.S. Appl. No. 09/861,292, dated Sep. 12, 2002.

Office Communication issued in U.S. Appl. No. 09/861,292, dated Jun. 17, 2008.

Office Communication issued in U.S. Appl. No. 09/861,292, dated Jun. 19, 2007.

- Office Communication issued in U.S. Appl. No. 09/861,292, dated Sep. 5, 2006.
- Office Communication issued in U.S. Appl. No. 09/861,292, dated Jul. 12, 2006.
- Office Communication issued in U.S. Appl. No. 09/861,292, dated Feb. 22, 2006.
- Office Communication issued in U.S. Appl. No. 09/861,292, dated Sep. 7, 2005.
- Office Communication issued in U.S. Appl. No. 09/861,292, dated Mar. 14, 2005.
- Office Communication issued in U.S. Appl. No. 09/861,292, dated Dec. 3, 2004.
- Office Communication issued in U.S. Appl. No. 09/861,292, dated Mar. 23, 2004.
- Ogawa et al., "Efforts toward the expansion of the genetic alphabet: Information storage and replication with unnatural hydrophobic base pairs," *J. Am. Chem. Soc.*, 122:3274-3287, 2000.
- PCT International Preliminary Examination Report issued in International application No. PCT/US01/31993, dated Sep. 10, 2004.
- Petersheim and Turner, "Base-stacking and base-pairing contributions to helix stability: thermodynamics of double-helix formation with CCGG, CCGGp, CCGGAp, ACCGGp, CCGGUp, and ACCGGUp," *Biochemistry*, 22(2):256-263, 1983.
- Peyret et al., "Nearest-Neighbor Thermodynamics and NMR of DNA Sequences with Internal A•A, C•C, G•G, and T•T Mismatches," *Biochemistry*, 38(12):3468-3477, 1999.
- Ren et al., "Naphthalene, Phenanthrene, and Pyrene as DNA Base Analogues: Synthesis, Structure, and Fluorescence in DNA," *J. Am. Chem. Soc.*, 118(33):7671-7678, 1996.
- Roberts et al., "Theoretical and experimental study of isoguanine and isocytosine: base pairing in an expanded genetic system," *J. Am. Chem. Soc.*, 119(20):4640-4649, 1997.
- SantaLucia et al., "Improved Nearest-Neighbor Parameters for Predicting DNA Duplex Stability," *Biochemistry*, 35(11):3555-3562, 1996.
- Second Office Action for Chinese Application No. 01812665, dated Oct. 20, 2006.
- Sherrill et al., "Nucleic Acid Analysis Using an Expanded Genetic Alphabet to Quench Fluorescence," *J. Am. Chem. Soc.*, 126(14):4550-4556, 2004.
- Switzer et al., "Enzymatic recognition of the base pair between isocytidine and isoguanosine," *Biochemistry*, 32(39):10489-10496, 1993.
- Taylor et al., "Flow Cytometric Platform for High-Throughput Single Nucleotide Polymorphism Analysis," *BioTechniques*, 30(3):661-669, 2001.
- The Stratagene Catalog, p. 39, 1988.
- Tor et al., "Site specific enzymatic incorporation of an unnatural base, N6-(6-Aminohexyl)isoguanosine, into RNA," *J. Am. Chem. Soc.*, 115:4461-4467, 1993.
- Ugozzoli et al., "Detection of specific alleles by using allele-specific primer extension followed by capture on solid support," *GATA*, 9(4):107-112, 1992.
- Walker et al., "Isothermal in vitro amplification of DNA by a restriction enzyme/DNA polymerase system," *Proc. Nat'l. Acad. Sci. USA*, 89(1):392-396, 1992.
- Whitcombe et al., "Detection of PCR products using self-probing amplicons and fluorescence," *Nature Biotech*, 17(8):804-807, 1999.

* cited by examiner

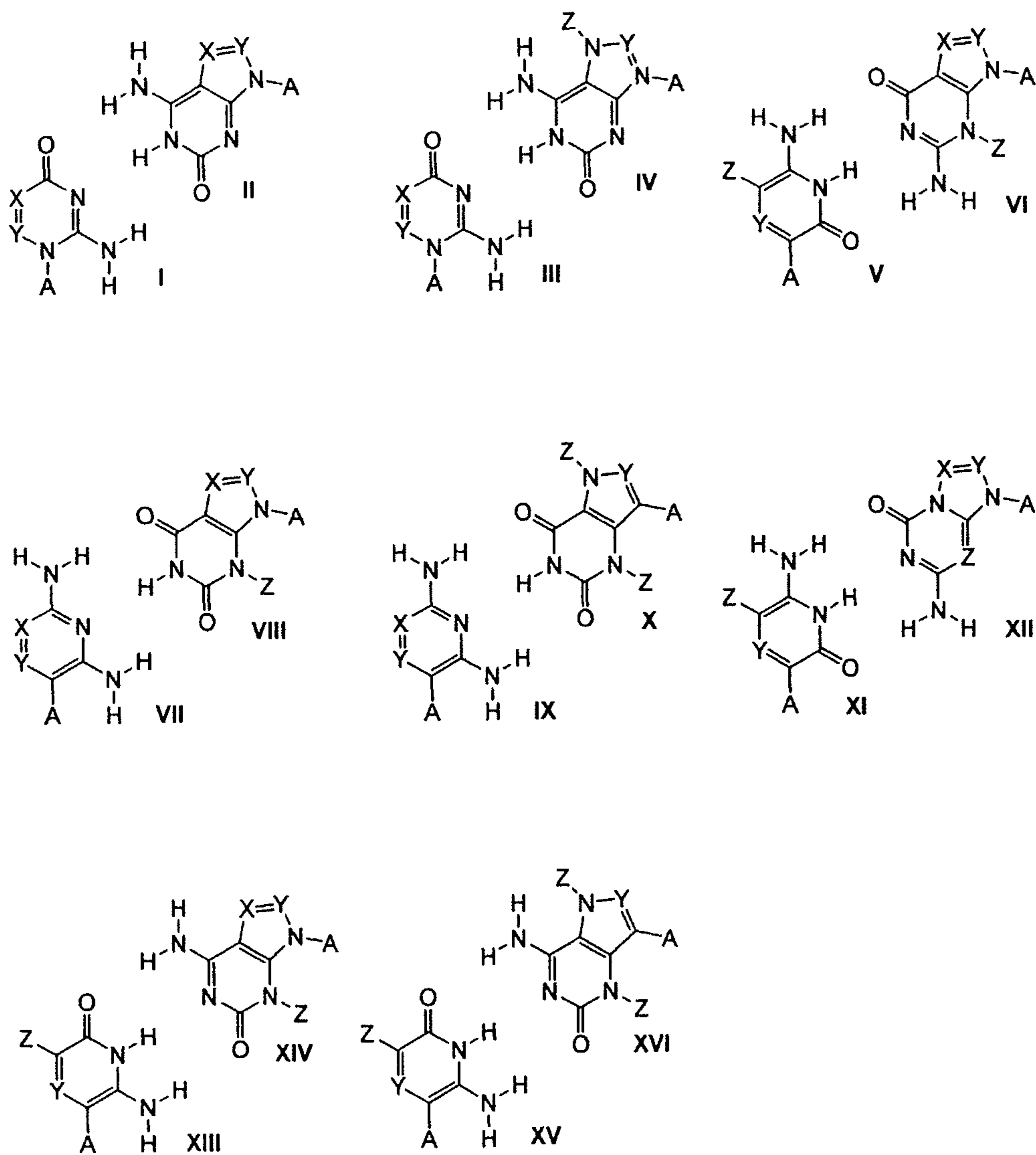

A is the point of attachment to a polymeric backbone
 X is N or C-Z
 Y is N or C-H
 Z is H or a substituted or unsubstituted alkyl group

Fig. 1

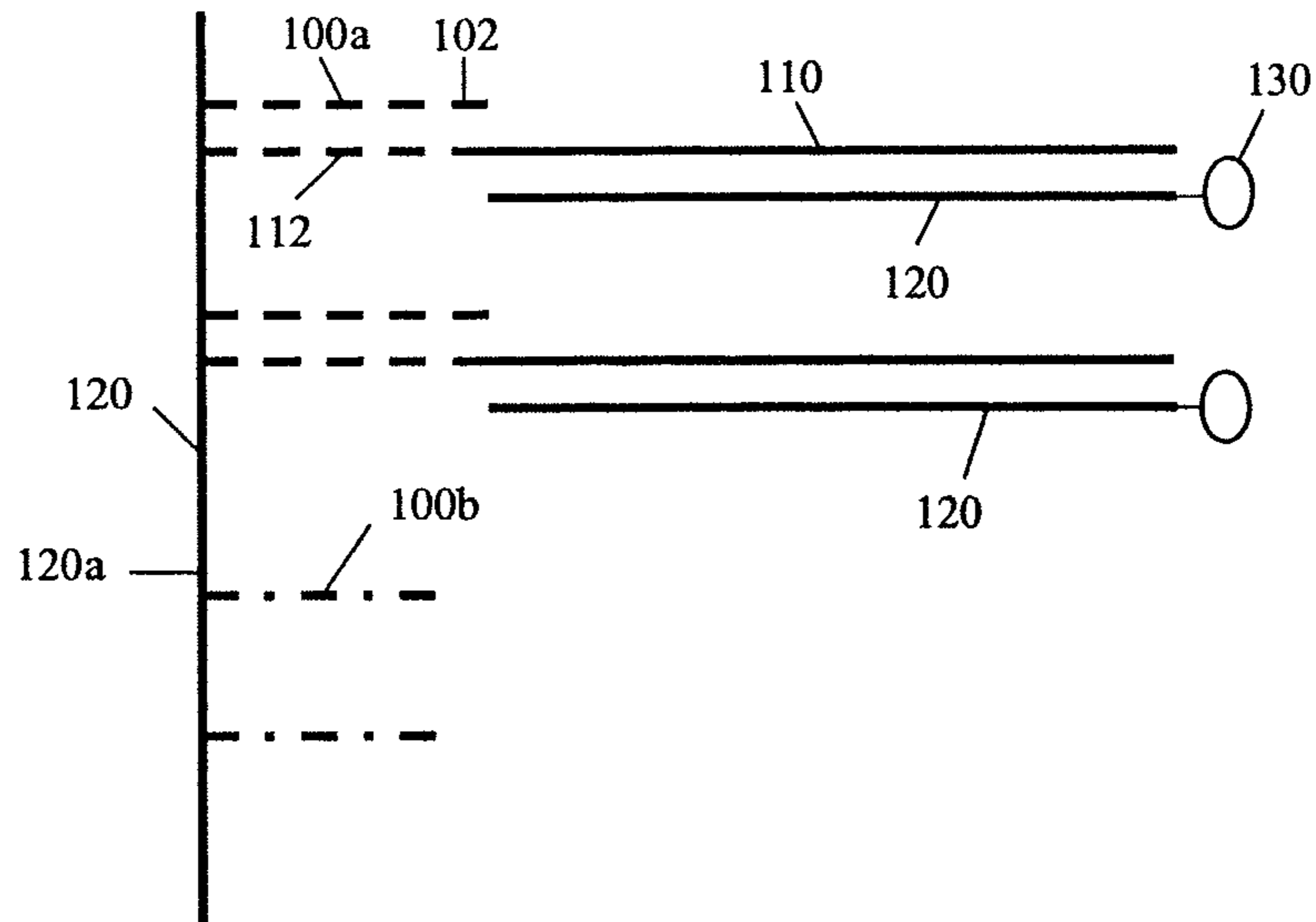

Fig. 2A

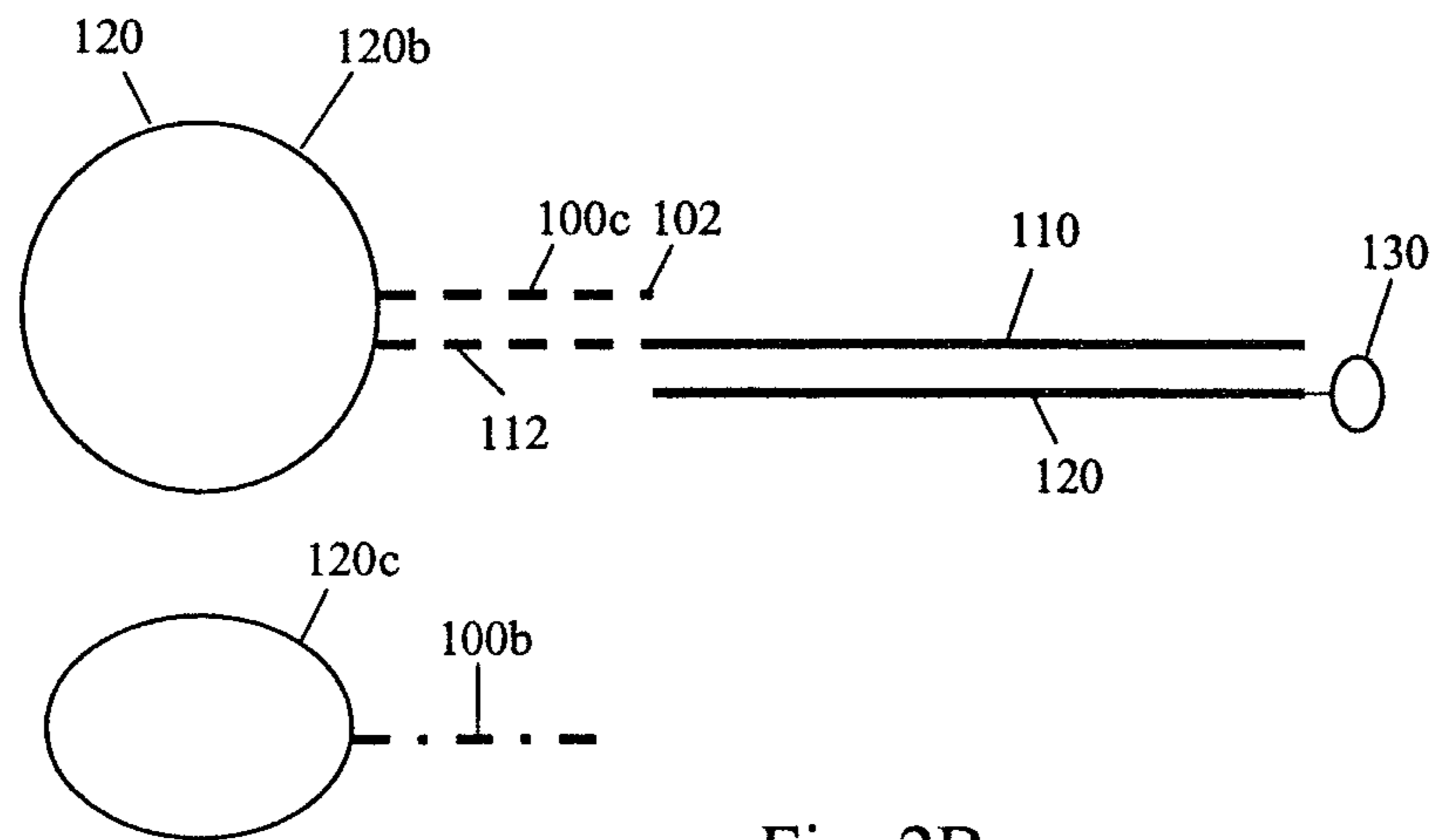

Fig. 2B

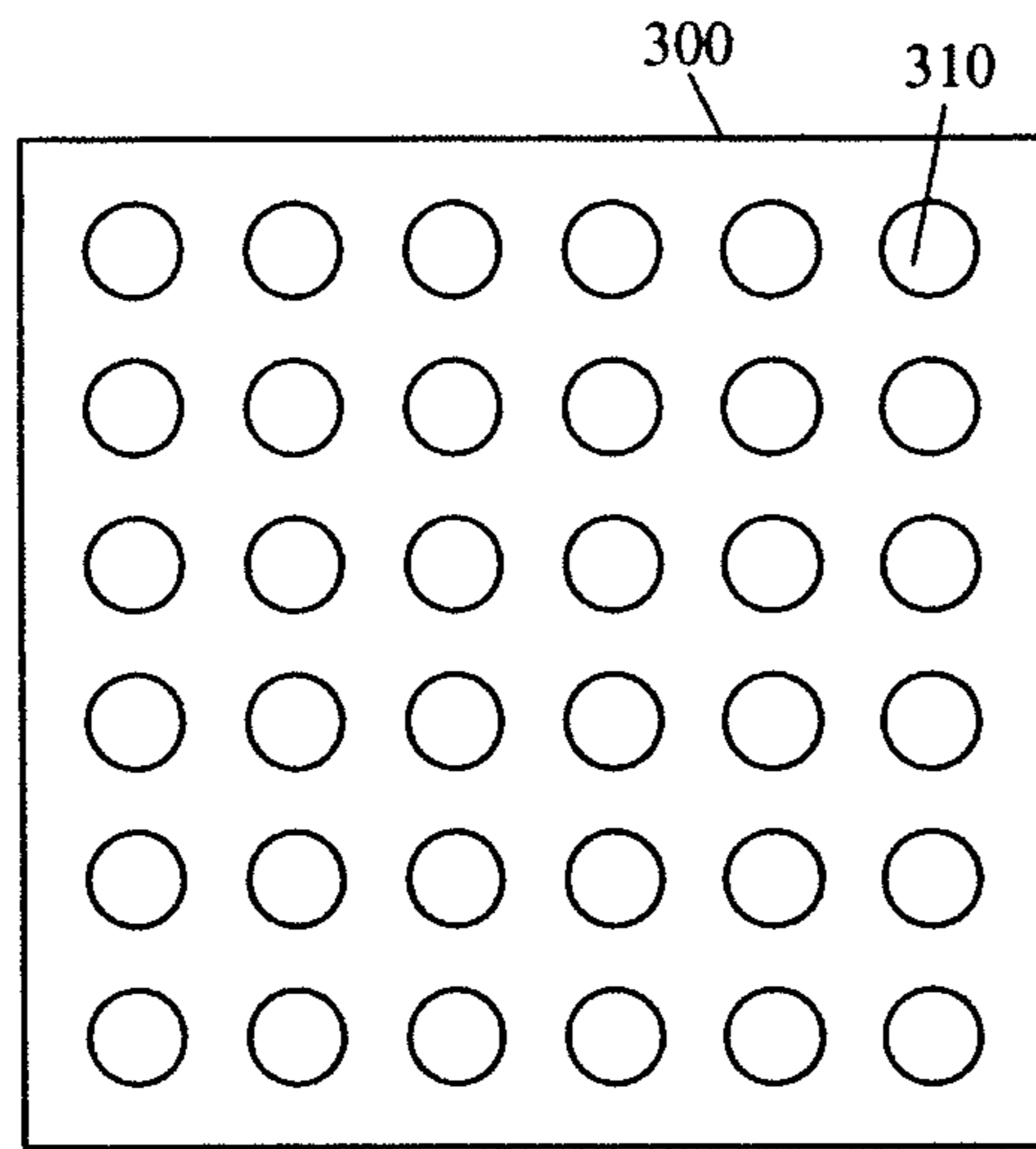

Fig. 3

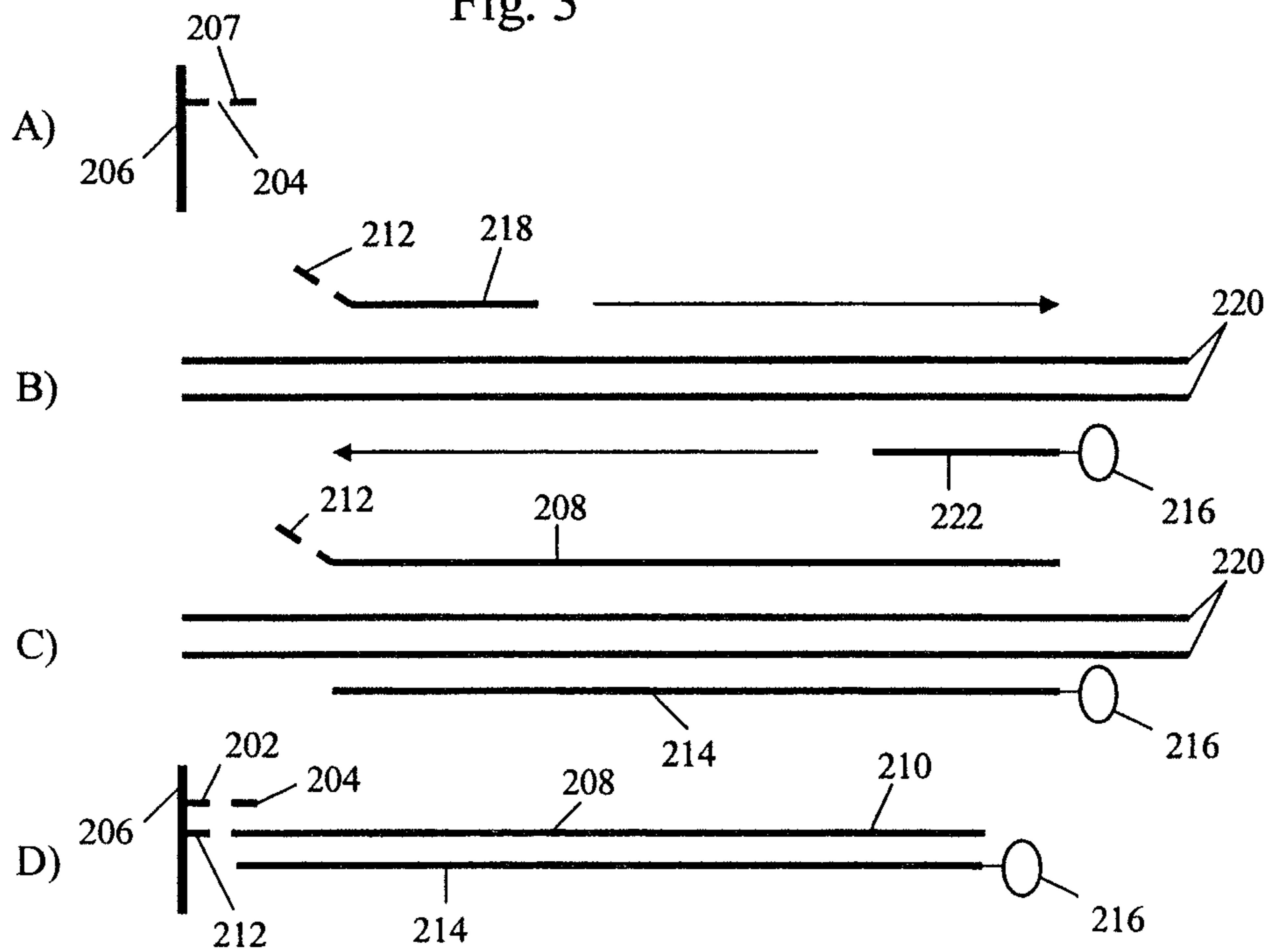

Fig. 4

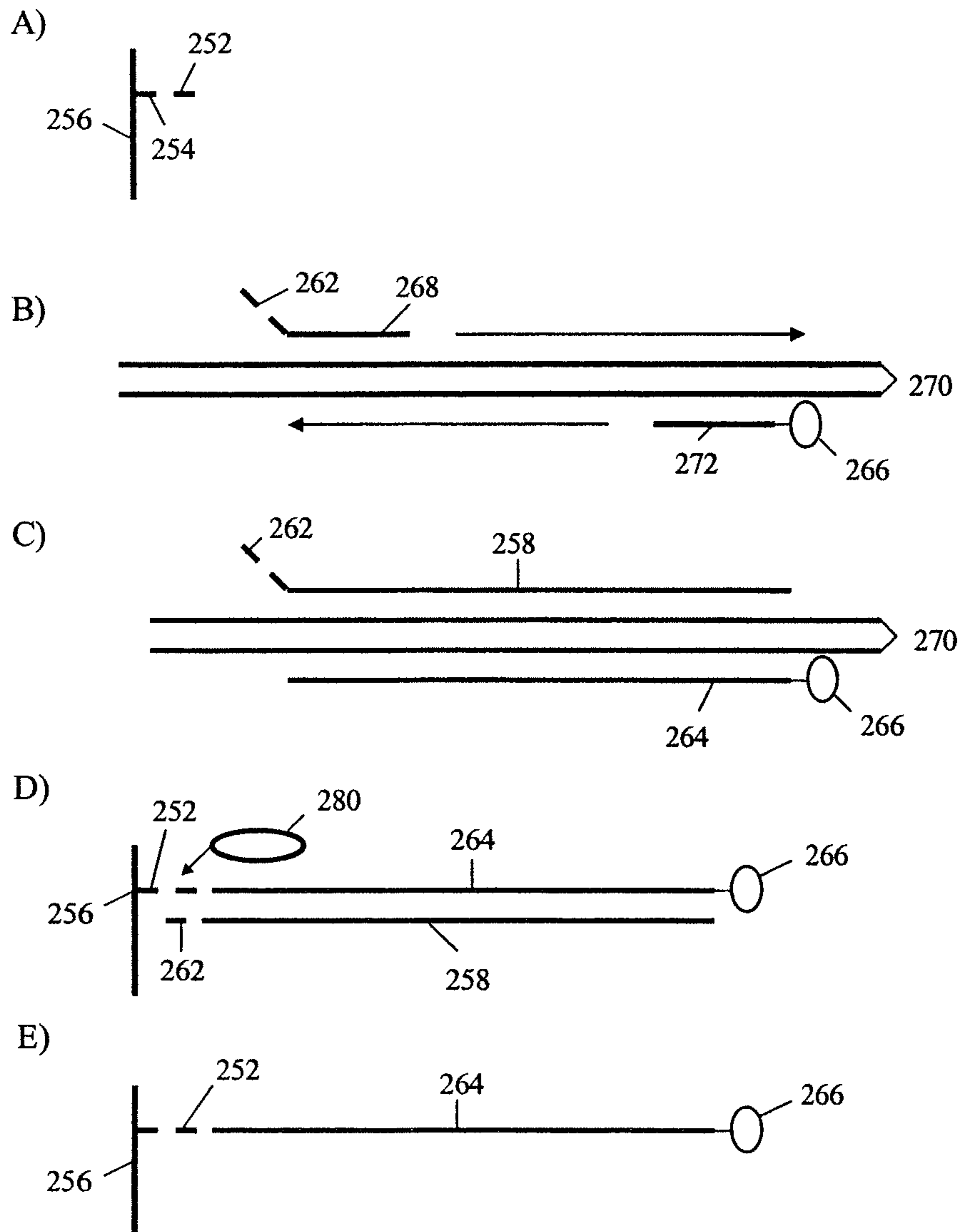

Fig. 5

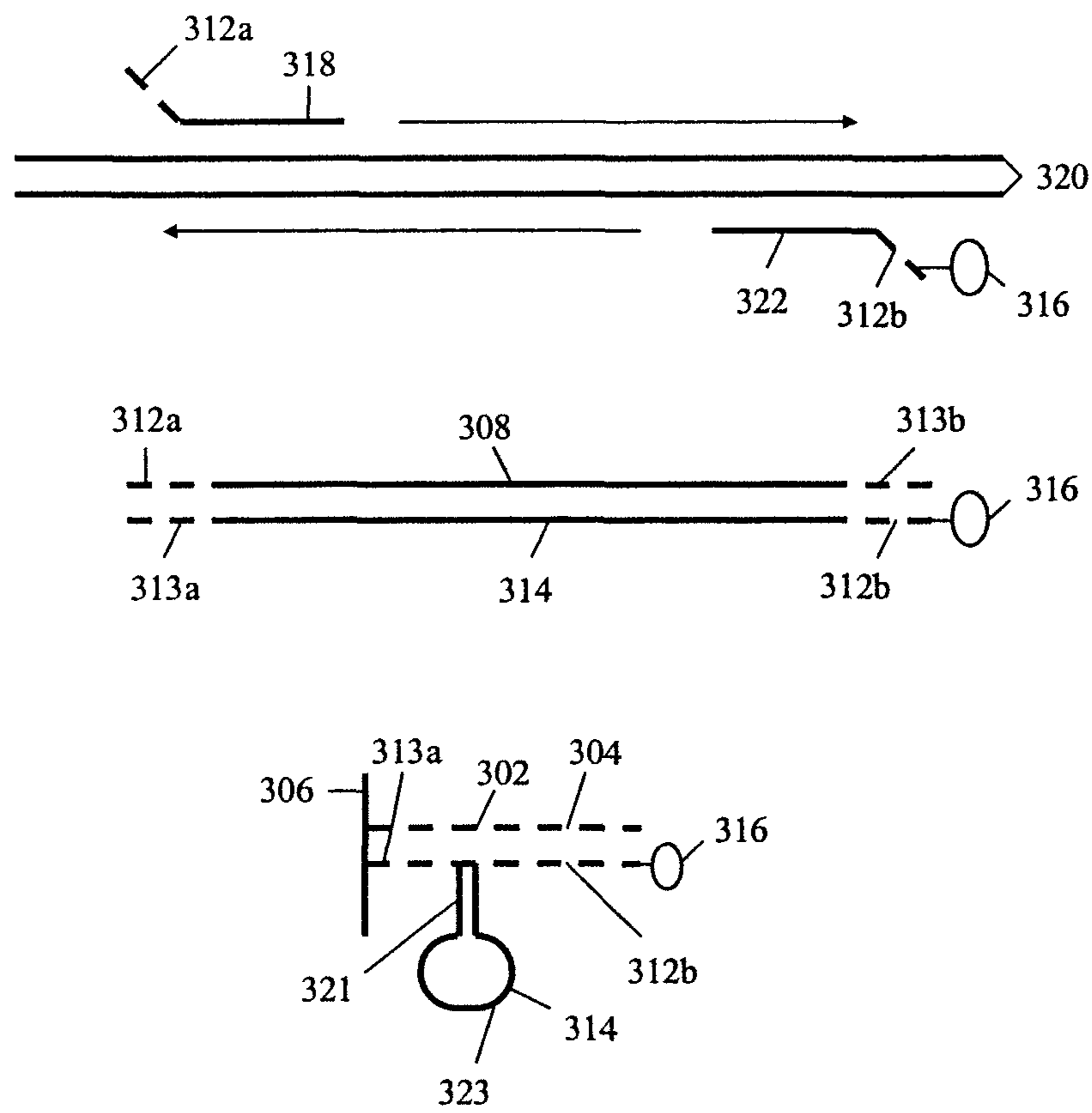

Fig. 6

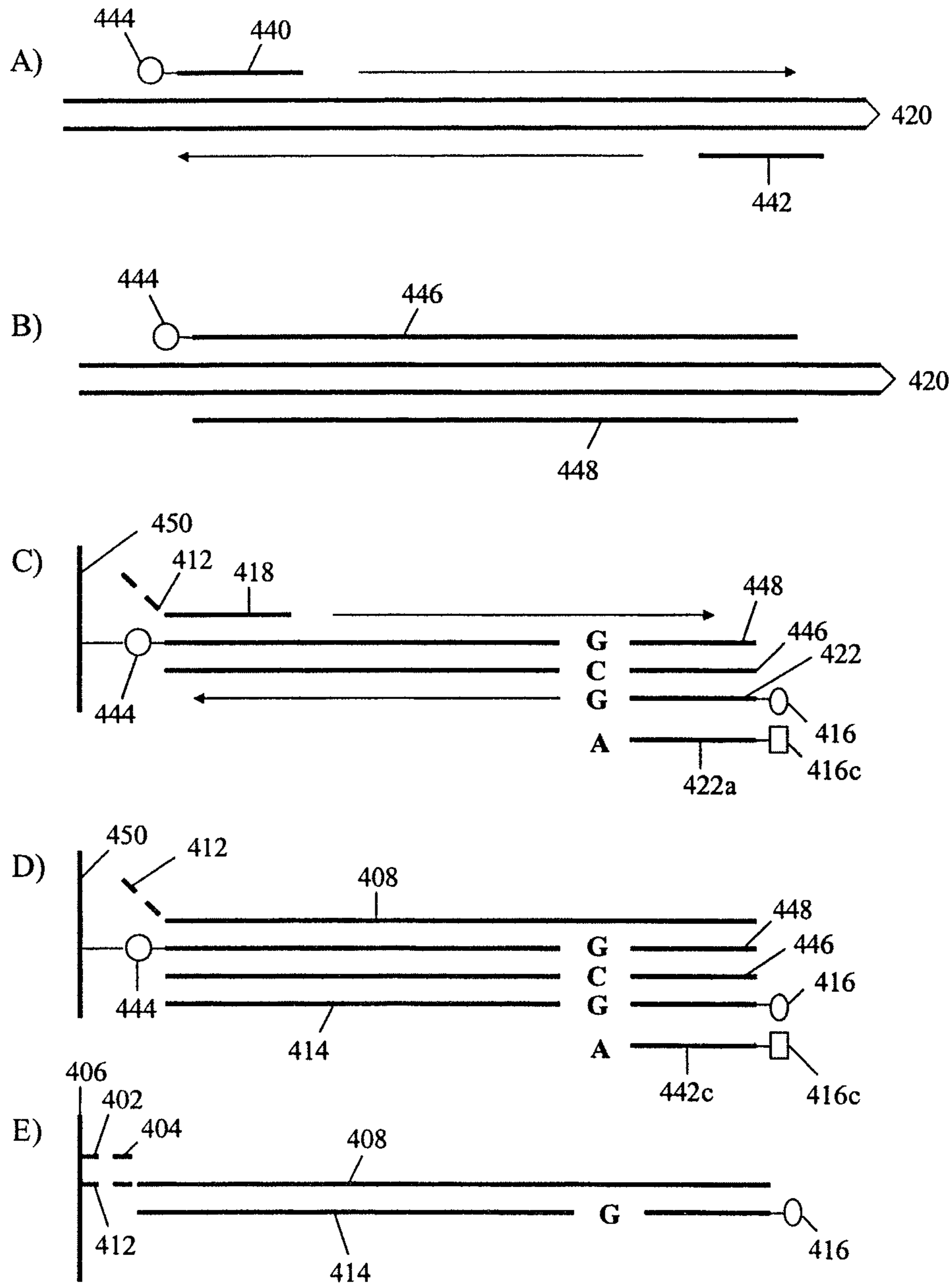

Fig. 7

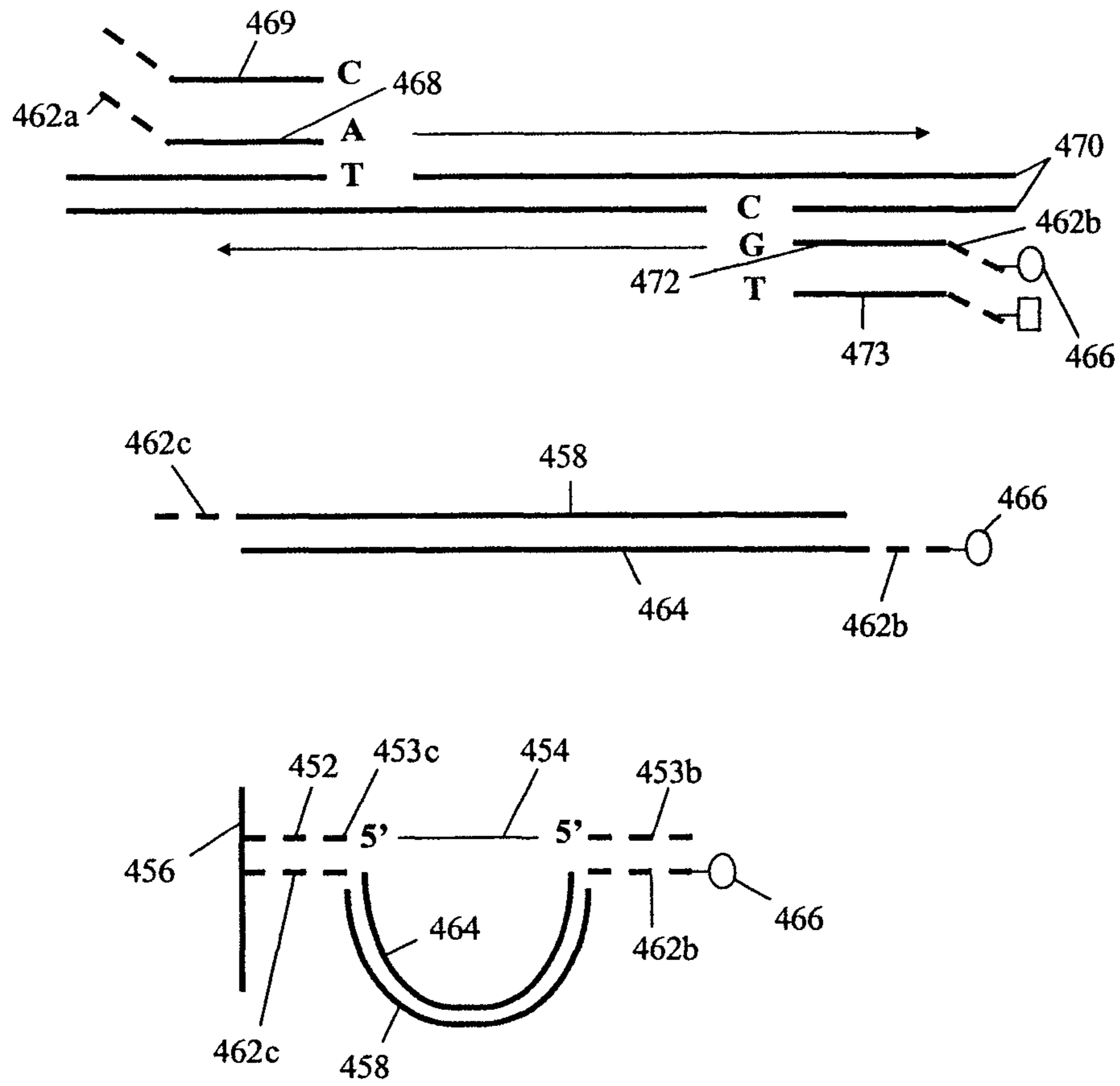

Fig. 8

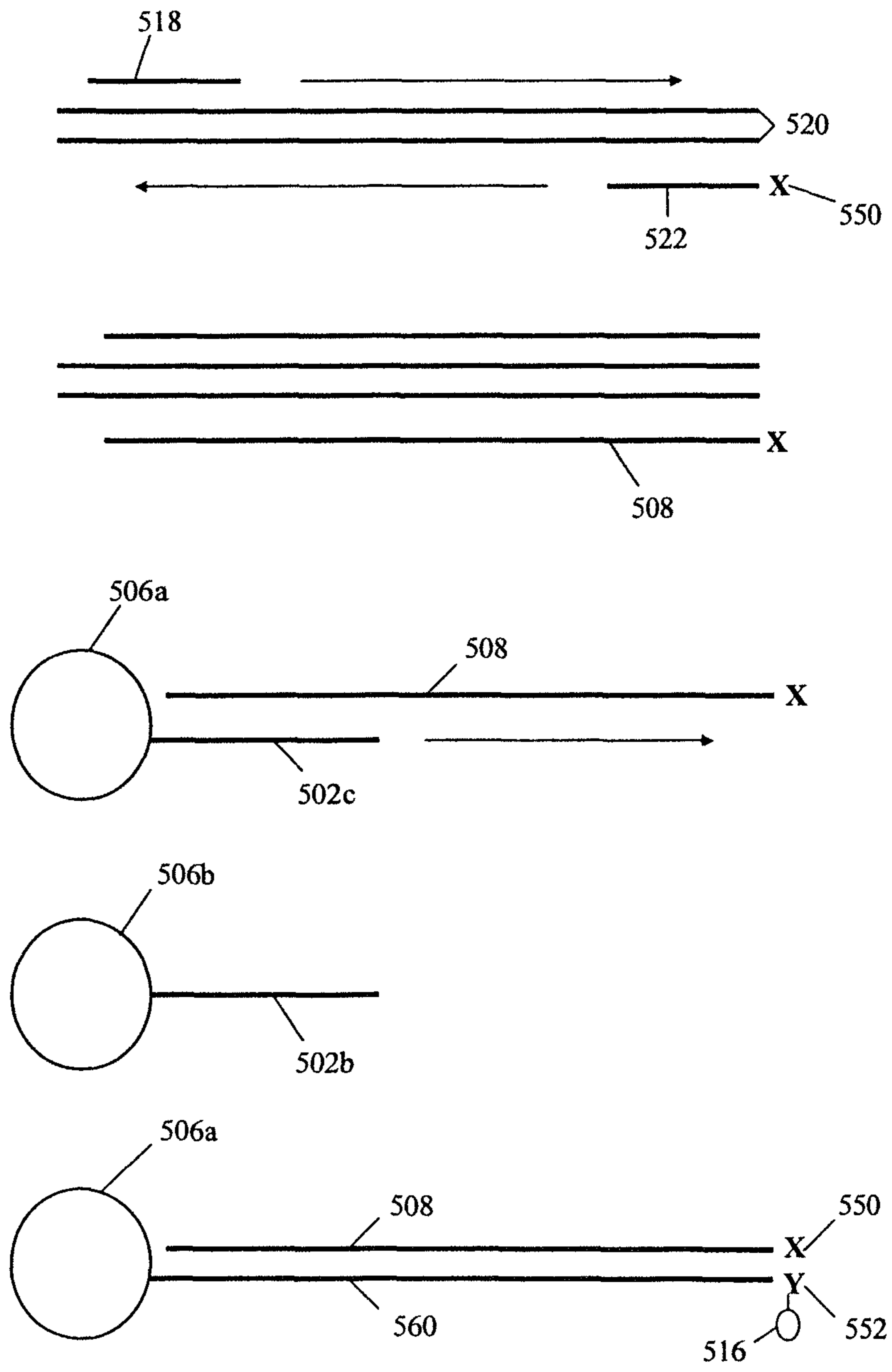

Fig. 9

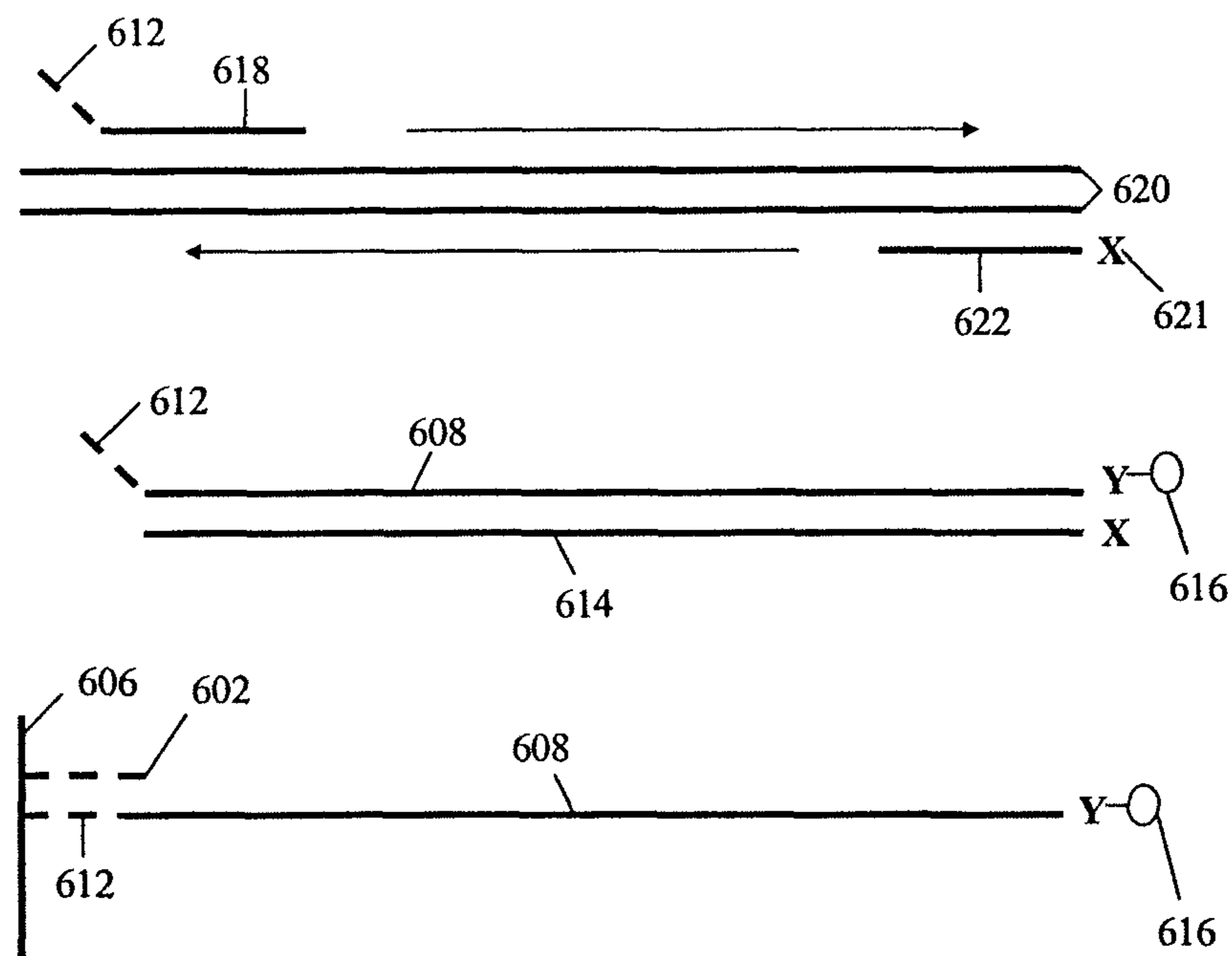

Fig. 10

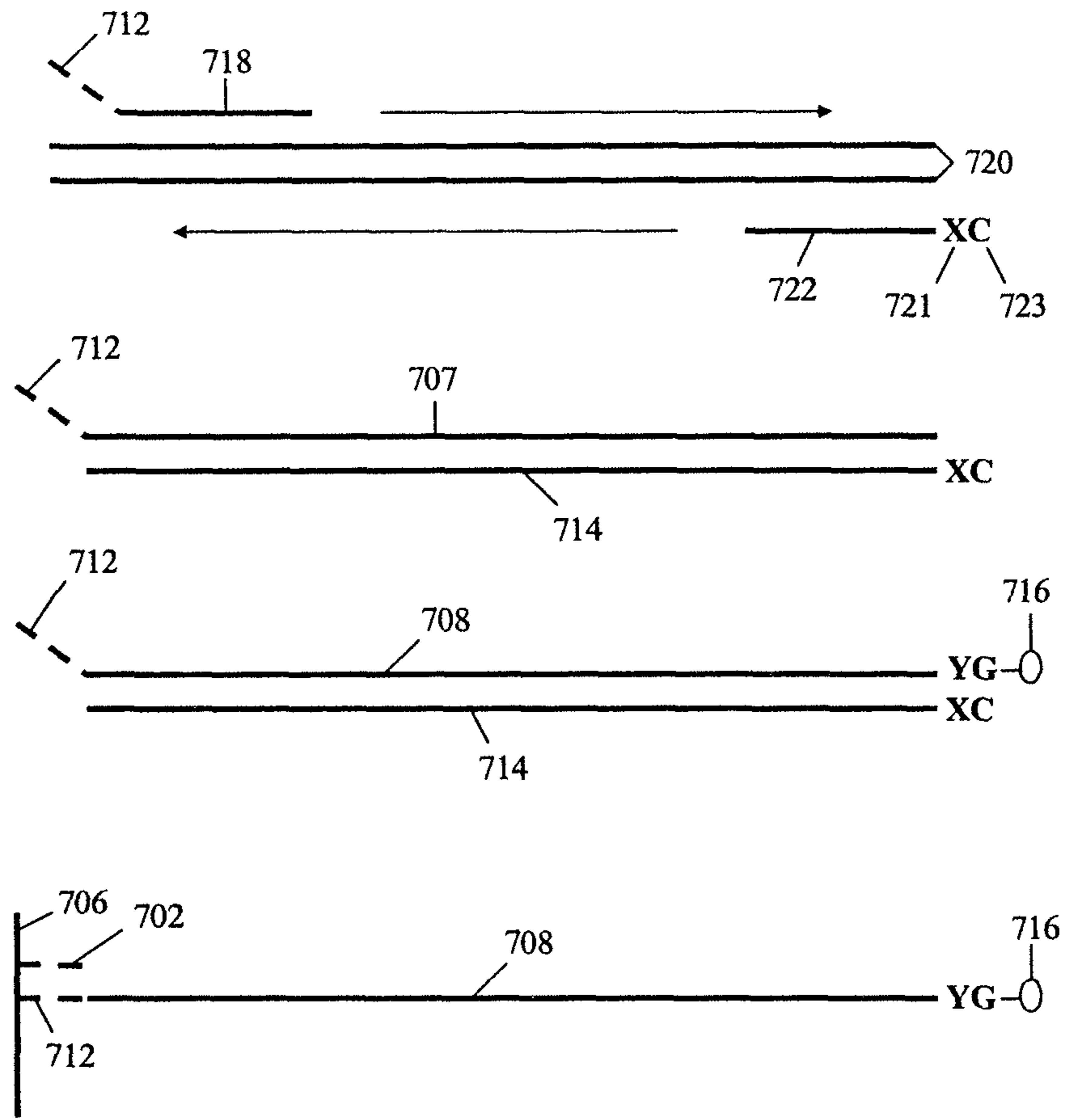

Fig. 11

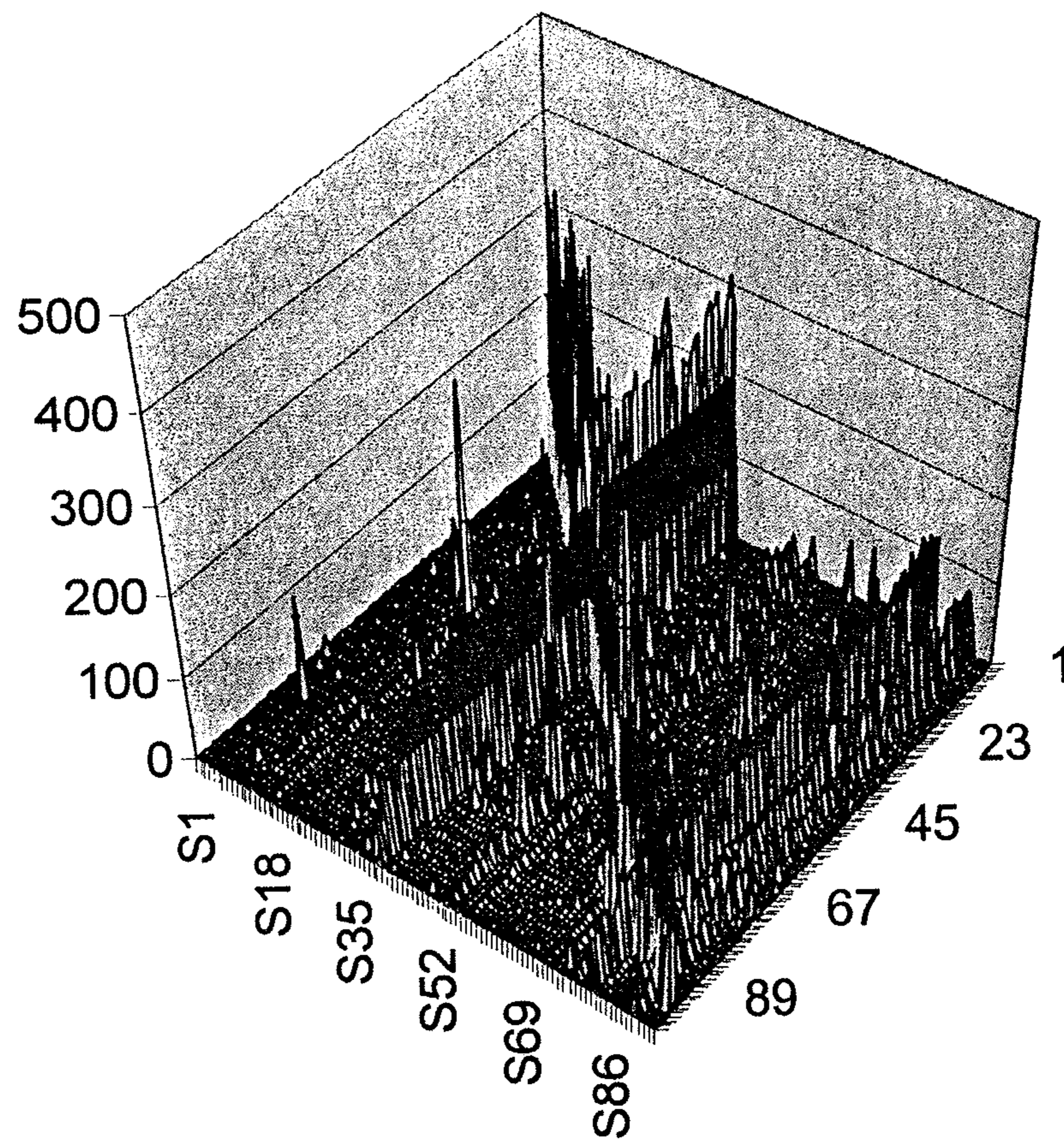

Fig. 12

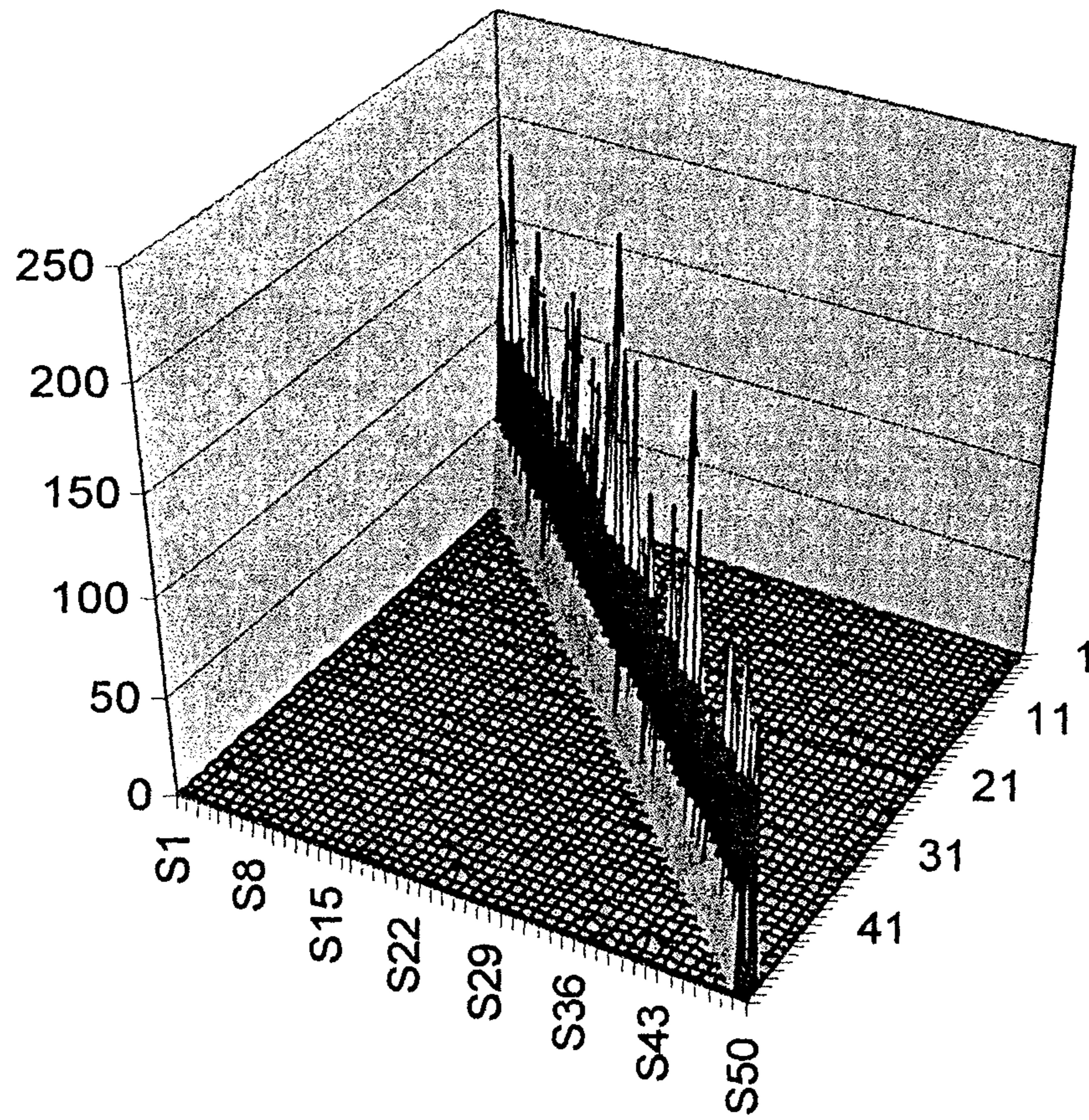

Fig. 13

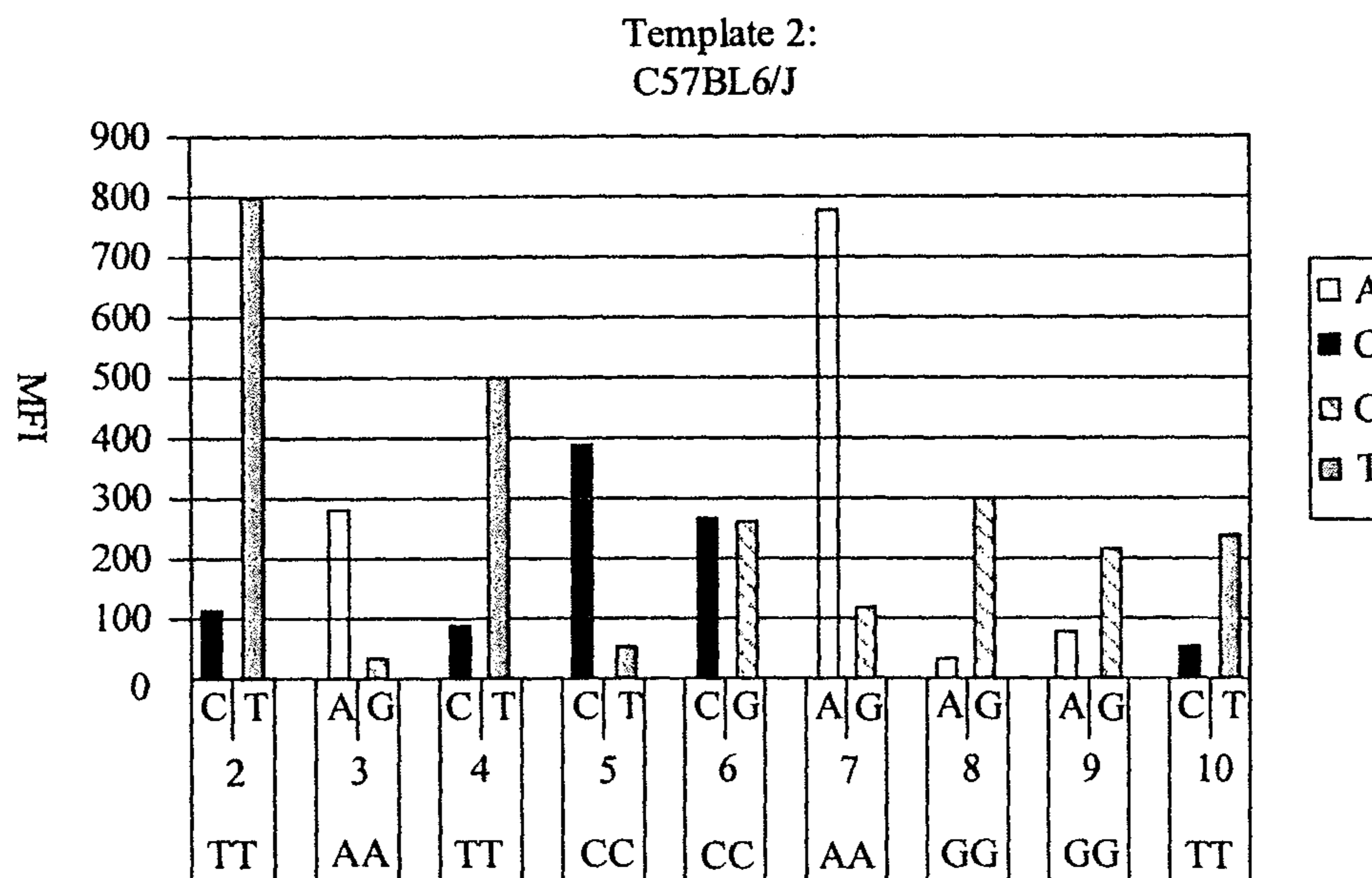
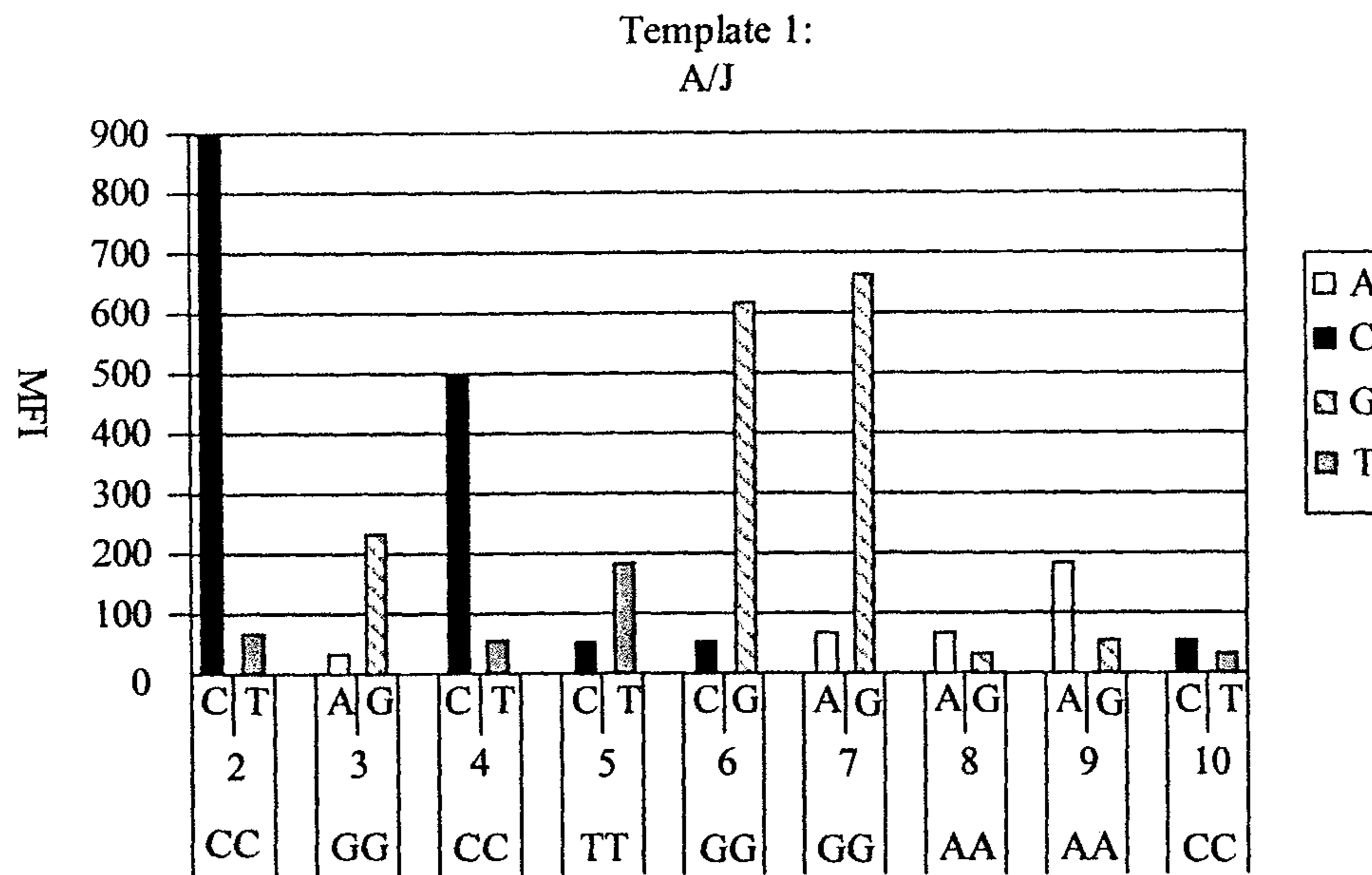

Fig. 14

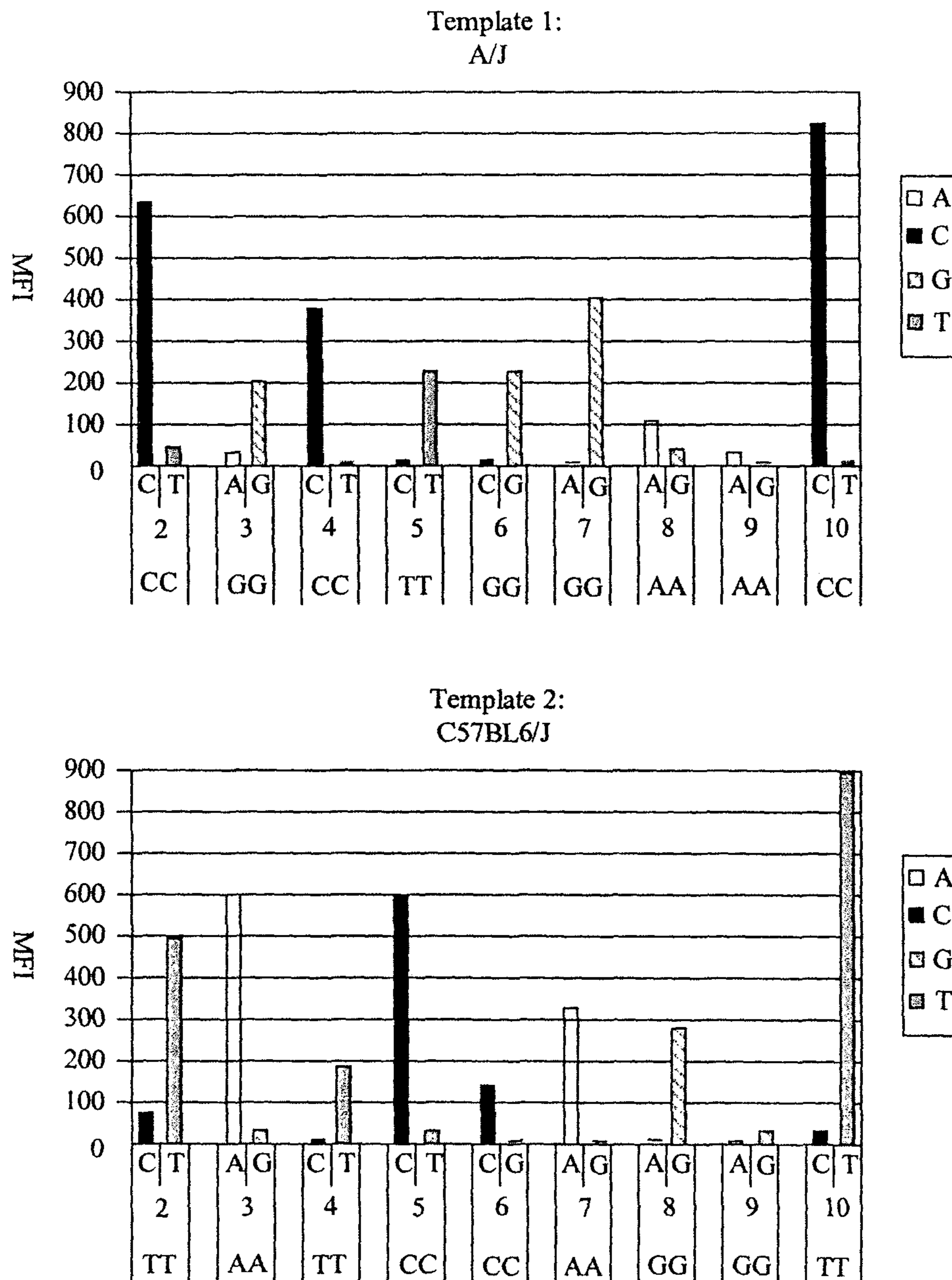

Fig. 15a

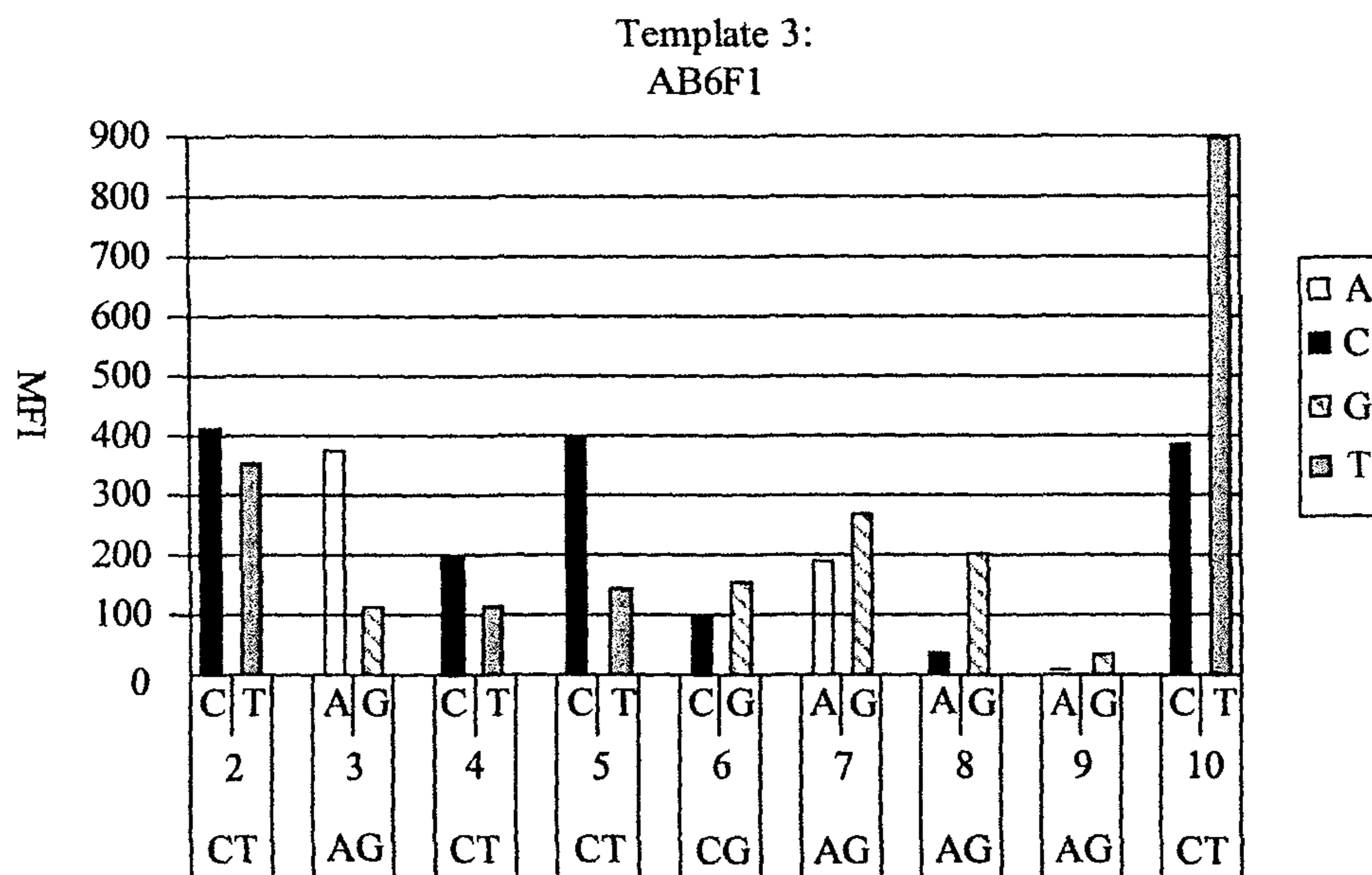

Fig. 15b

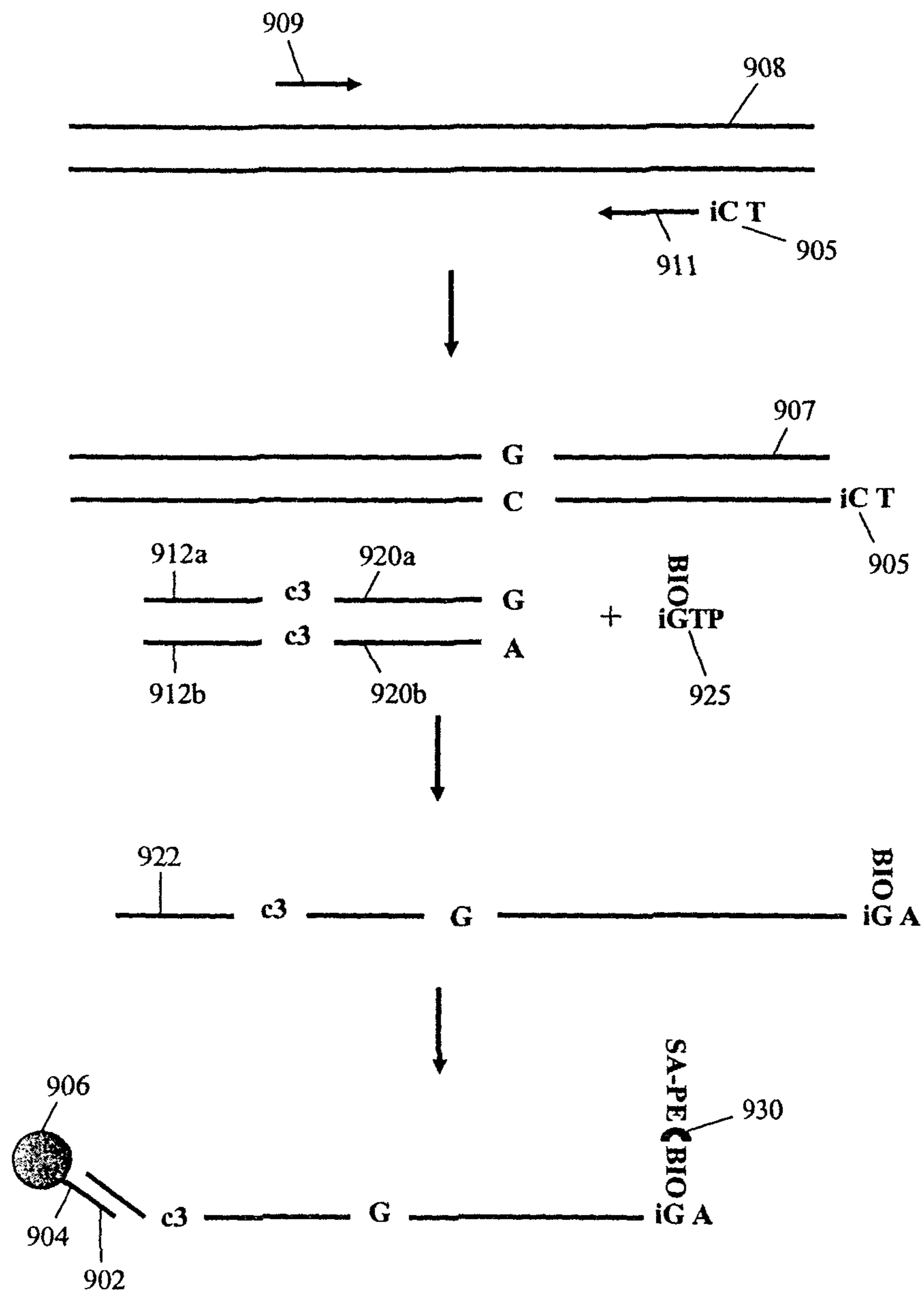

Fig. 16

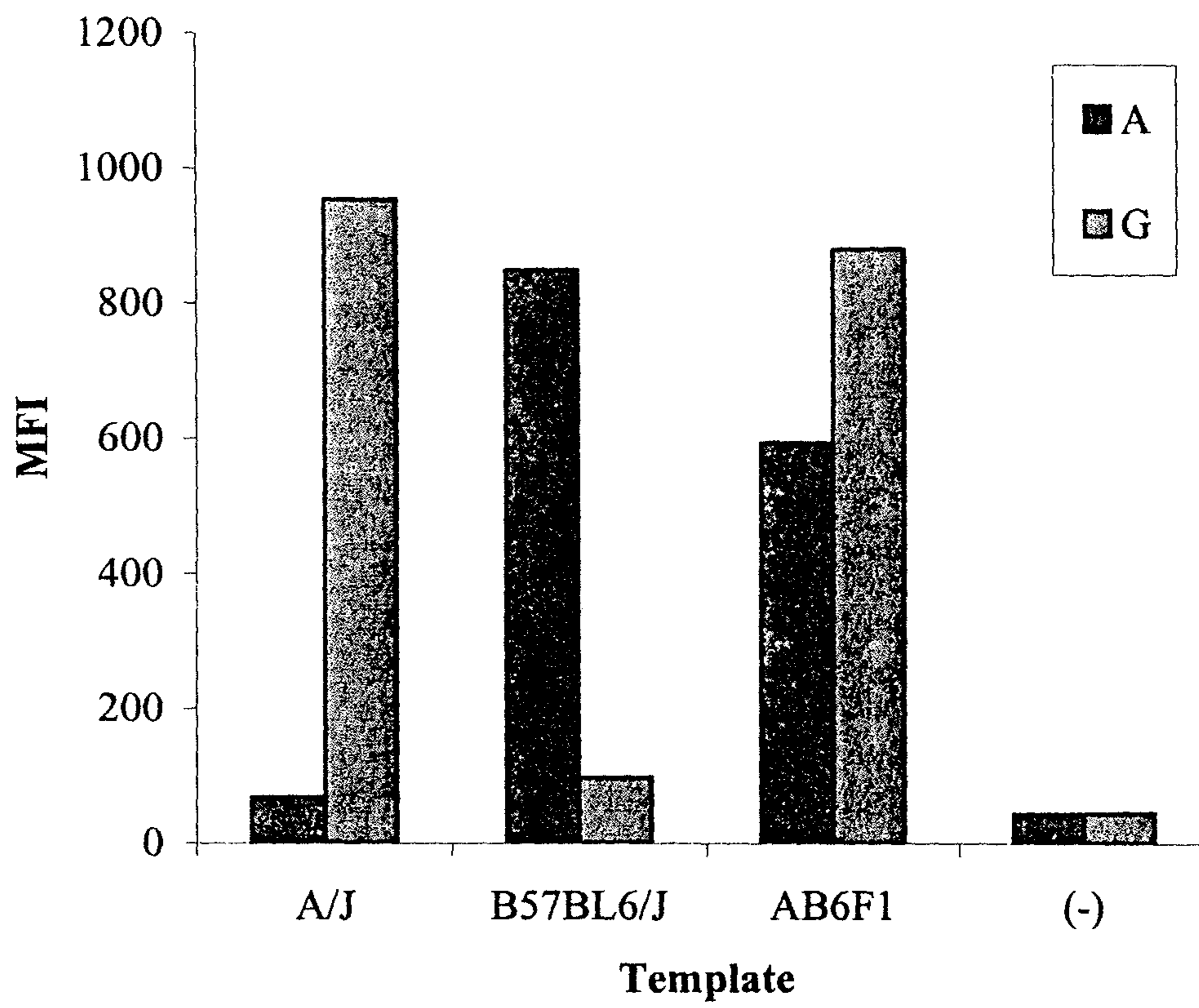

Fig. 17

1

**SOLID SUPPORT ASSAY SYSTEMS AND
METHODS UTILIZING NON-STANDARD
BASES**

CROSS-REFERENCE TO RELATED
APPLICATION

This application is a divisional of U.S. patent application Ser. No. 11/490,319 filed Jul. 20, 2006, now U.S. Pat. No. 8,217,160, which is a continuation of U.S. application Ser. No. 11/284,307, filed on Nov. 19, 2005, now U.S. Pat. No. 7,892,796; which is a continuation of U.S. application Ser. No. 09/977,615, filed on Oct. 15, 2001, now U.S. Pat. No. 6,977,161; which claims the benefit of U.S. Provisional Application Ser. Nos. 60/293,259, filed on May 22, 2001; 60/282,831, filed on Apr. 10, 2001; and 60/240,397, filed on Oct. 14, 2000. U.S. application Ser. No. 09/977,615 is a continuation-in-part of U.S. application Ser. No. 09/861,292, filed on May 18, 2001, now U.S. Pat. No. 7,422,850, which claims the benefit of U.S. Provisional Application Ser. Nos. 60/282,831, filed on Apr. 10, 2001; 60/240,398, filed on Oct. 14, 2000; and 60/205,712, filed on May 19, 2000. The aforementioned applications are incorporated herein by reference in their entireties.

BACKGROUND OF THE INVENTION

A variety of different methods have been developed to assay oligonucleotides, including DNA or RNA fragments. Such assays are typically directed to determining whether a sample includes oligonucleotides having a particular target oligonucleotide sequence. In some instances, oligonucleotide sequences differ by only a few nucleotides, as in the case of many allelic sequences. Single nucleotide polymorphisms (SNPs) refer to alleles that differ by a single nucleotide. Even this single nucleotide difference can, at least in some instances, change the associated genetic response or traits. Accordingly, to determine which allele is present in a sample, the assay technique must be sufficiently sensitive to distinguish between closely related sequences.

Many assay techniques include multiple components, each of which hybridizes to other component(s) in the assay. Non-specific hybridization between components (i.e., the hybridization of two non-complementary sequences) produces background noise in the assay. For example, closely related, but not identical, sequences can form imperfect duplexes in which base pairing is interrupted at positions where the two single strands are not complementary. Non-specific hybridization increases when the hybridizing components have similar sequences, as would be the case, for example, for many alleles and particularly for SNP alleles. Thus, for example, hybridization assays to determine which allele is present in a sample would benefit from methods that reduce non-specific hybridization or reduce the impact of non-specific hybridization on the assay.

BRIEF SUMMARY OF THE INVENTION

Generally, the present invention relates to methods, kits, and compositions for assaying oligonucleotides. In addition, the invention relates to methods, kits, and compositions for assaying oligonucleotides using non-standard bases. One embodiment provides a method of assaying an analyte-specific sequence. A capture oligonucleotide comprising a molecular recognition sequence having at least one non-standard base coupled to a support (e.g., a single solid support, such as a chip or wafer, or a particulate support) is contacted

2

with a sample under suitable hybridizing conditions to hybridize to a target oligonucleotide, if present in the sample. The target oligonucleotide comprises a tagging sequence complementary to the molecular recognition sequence of the capture oligonucleotide and the analyte-specific sequence or a complement of the analyte-specific sequence. Hybridization of the target oligonucleotide to the capture oligonucleotide is detected.

Another embodiment provides another method of assaying an analyte-specific sequence. A capture oligonucleotide coupled to a support and comprising a molecular recognition sequence that is the same as or complementary to at least a portion of the analyte-specific sequence is contacted with a sample under hybridizing conditions to hybridize to a target oligonucleotide. The target oligonucleotide comprises a tagging sequence comprising at least one non-standard base and the analyte-specific sequence or a complement of the analyte-specific sequence. The capture oligonucleotide is enzymatically extended using the target oligonucleotide as a template and a complementary non-standard base is incorporated opposite the non-standard base of the tagging sequence. A reporter group is also incorporated into an extended portion of the capture oligonucleotide. Hybridization of the target oligonucleotide to the capture oligonucleotide is detected.

Yet another embodiment provides another method of assaying an analyte-specific sequence. An analyte having the analyte-specific sequence is contacted with a first primer and a second primer. The first primer comprises a tagging sequence and a sequence complementary to a first sequence of the analyte. The second primer comprises a sequence complementary to a second sequence of the analyte and a non-standard base. The first and second primers are enzymatically extended to form a target oligonucleotide and a second oligonucleotide, respectively. One of the target oligonucleotide and the second oligonucleotide comprises the analyte-specific sequence, and the other comprises a sequence complementary to the analyte-specific sequence. Extension of the first primer is substantially halted when the non-standard base of the second primer is encountered. A non-standard base complementary to the non-standard base of the second primer is incorporated into the extended first primer opposite the non-standard base of the second primer. A capture oligonucleotide molecular recognition sequence that is the same as or complementary to at least a portion of the analyte-specific sequence coupled to a support is contacted with the target oligonucleotide under hybridizing conditions to hybridize to the target oligonucleotide comprising a tagging sequence and the analyte-specific sequence or complement thereof. Hybridization of the target oligonucleotide to the capture oligonucleotide is detected.

Other embodiments include kits for applying the methods described above. The kits include support(s) and capture oligonucleotides. The kits also include the target oligonucleotides or components for making the target oligonucleotides from an analyte. Such components can include, for example, a polymerase and first and second primers that are complementary to sequences of the analyte, where either the first or second primers include the tagging sequence. For some methods, the kit can also include a non-standard base or nucleotide triphosphate of a non-standard base for incorporation.

The above summary of the present invention is not intended to describe each disclosed embodiment or every implementation of the present invention. The Figures and the detailed description which follow more particularly exemplify these embodiments.

BRIEF DESCRIPTION OF THE DRAWINGS

The invention may be more completely understood in consideration of the following detailed description of various embodiments of the invention in connection with the accompanying drawings, in which:

FIG. 1 displays chemical structures for a number of non-standard bases, where A is the point of attachment to a polymeric backbone, X is N or C—Z, Y is N or C—H, and Z is H or a substituted or unsubstituted alkyl group;

FIGS. 2A and 2B schematically illustrate two examples of oligonucleotide hybridization to a solid support, according to the invention;

FIG. 3 illustrates steps in a first assay for an analyte-specific sequence, according to the invention;

FIG. 4 illustrates steps in a second assay for an analyte-specific sequence, according to the invention;

FIG. 5 illustrates steps in a third assay for an analyte-specific sequence, according to the invention;

FIG. 6 illustrates steps in a fourth assay for an analyte-specific sequence, according to the invention;

FIG. 7 illustrates steps in a fifth assay for an analyte-specific sequence, according to the invention;

FIG. 8 illustrates steps in a sixth assay for an analyte-specific sequence, according to the invention;

FIG. 9 illustrates steps in a seventh assay for an analyte-specific sequence, according to the invention;

FIG. 10 illustrates steps in an eighth assay for an analyte-specific sequence, according to the invention;

FIG. 11 illustrates steps in a ninth assay for an analyte-specific sequence, according to the invention;

FIG. 12 is a 3D surface map illustrating, for 98 molecular recognition sequences (y-axis), the hybridization of complementary tagging sequences (x-axis) for each of the 100 molecular recognition sequences;

FIG. 13 is a 3D surface map illustrating, for 50 molecular recognition sequences (y-axis), the hybridization of complementary tagging sequences (x-axis) for each of the 50 molecular recognition sequences;

FIG. 14 is a graph illustrating results from an assay of alleles, according to the invention;

FIGS. 15A and 15B are graphs illustrating results from another assay of alleles, according to the invention; and

FIG. 16 illustrates steps in a tenth assay for an analyte-specific sequence, according to the invention.

FIG. 17 is a graph of results from an assay of alleles, according to the invention.

Although the invention is amenable to various modifications and alternative forms, specifics thereof have been shown by way of example in the drawings and will be described in detail. It should be understood, however, that the invention is not limited to the particular embodiments described. On the contrary, the intention is to cover all modifications, equivalents, and alternatives falling within the spirit and scope of the invention.

DETAILED DESCRIPTION OF THE PREFERRED EMBODIMENT

The present invention relates to assays and methods of assaying oligonucleotides. In particular, the present invention is directed to assays and methods of assaying oligonucleotides using one or more non-standard bases. Although the present invention is not so limited, an appreciation of various aspects of the inventions described herein will be gained through the discussion provided below. Other related assay

methods for use with non-standard bases are described in U.S. Patent Provisional Application Ser. No. 60/240,397, filed Oct. 14, 2000.

As used herein, “nucleic acids” include polymeric molecules such as deoxyribonucleic acid (DNA), ribonucleic acid (RNA), peptide nucleic acid (PNA), or any sequence of what are commonly referred to as bases joined by a chemical backbone where the bases have the ability to form base pairs or hybridize with a complementary chemical structure. Suitable non-nucleotidic chemical backbones include, for example, polyamide and polymorpholino backbones. The term “nucleic acids” includes oligonucleotide, nucleotide, or polynucleotide sequences, and fragments or portions thereof. The nucleic acid can be provided in any suitable form, e.g., isolated from natural sources, recombinantly produced, or artificially synthesized, can be single- or double-stranded, and can represent the sense or antisense strand.

The term “oligonucleotide” refers generally to short chain (e.g., less than about 100 nucleotides in length, and typically 6 to 50 nucleotides in length) nucleic acid sequences as prepared using techniques presently available in the art such as, for example, solid support nucleic acid synthesis, DNA replication, reverse transcription, restriction digest, run-off transcription, or the like. The exact size of the oligonucleotide will typically depend upon a variety of factors, which in turn will depend upon the ultimate function or use of the oligonucleotide.

A “sequence” refers to an ordered arrangement of nucleotides.

The term “sample” includes a specimen or culture (e.g., microbiological cultures), as well as biological samples, samples derived from biological fluids, and samples from non-biological sources.

The term “analyte” refers to a nucleic acid suspected to be in a sample. The analyte is the object of the assay (e.g., the assay determines the presence, absence, concentration, or amount of the analyte in the sample). The analyte can be directly or indirectly assayed. In at least some embodiments involving indirect assay, the analyte, if present in the sample, is used as a template to form target oligonucleotides using, for example, PCR techniques. The target oligonucleotides are then assayed to indicate the presence, absence, concentration, or amount of the analyte in the sample.

The term “target oligonucleotide” refers to oligonucleotides that are actually assayed during an assay procedure. The target oligonucleotide can be, for example, an analyte or it can be an oligonucleotide containing an analyte-specific sequence that is the same as or complementary to a sequence of the analyte. For example, the target oligonucleotide can be a product of PCR amplification of an analyte or a portion of an analyte.

The term “capture oligonucleotide” refers to an oligonucleotide having a molecular recognition sequence and coupled to a solid surface to hybridize with a target oligonucleotide having a tagging sequence or an analyte specific sequence complementary to the molecular recognition sequence, thereby capturing the target oligonucleotide on the solid surface.

A “molecular recognition sequence” as used herein is an oligonucleotide sequence complementary to the tagging sequence or to the analyte-specific sequence of a target oligonucleotide.

As used herein, the terms “complementary” or “complementarity,” when used in reference to nucleic acids (i.e., a sequence of nucleotides such as an oligonucleotide or a target nucleic acid), refer to sequences that are related by base-pairing rules. For natural bases, the base pairing rules are

those developed by Watson and Crick. For non-standard bases, as described herein, the base-pairing rules refer to the formation of hydrogen bonds in a manner similar to the Watson-Crick base pairing rules or the formation of specific base pairs by hydrophobic, entropic, or van der Waals forces. As an example, for the sequence "T-G-A", the complementary sequence is "A-C-T." Complementarity can be "partial," in which only some of the bases of the nucleic acids are matched according to the base pairing rules. Alternatively, there can be "complete" or "total" complementarity between the nucleic acids. The degree of complementarity between the nucleic acid strands affects the efficiency and strength of hybridization between the nucleic acid strands.

The term "hybridization" is used in reference to the pairing of complementary nucleic acids. Hybridization and the strength of hybridization (i.e., the strength of the association between the nucleic acids) is influenced by such factors as the degree of complementarity between the nucleic acids, stringency of the hybridization conditions involved, the melting temperature (T_m) of the formed hybrid, and the G:C ratio within the nucleic acids.

Assays are performed to determine whether a sample includes an analyte having a particular nucleic acid sequence (or its complement). This nucleic acid sequence will be referred to as the "analyte-specific sequence". In at least some instances, the original sample is not directly assayed. Instead, the analyte, if present, is cloned or amplified (e.g., by PCR techniques) to provide an assay sample with a detectable amount of a target oligonucleotide that contains the analyte-specific sequence. Other techniques for amplification include, for example, nucleic acid sequence based amplification (NASBA, e.g., Guatelli, et al., Proc. Nat'l. Acad. Sci. 87, 1874 (1990), incorporated herein by reference), strand displacement amplification (SDA, e.g., Walker, et al., Proc. Nat'l. Acad. Sci. 89, 392-96 (1992), incorporated herein by reference), ligase chain reaction (LCR, e.g., Kalin, et al., Mutat. Res., 283, 119-23 (1992), incorporated herein by reference), transcription mediated amplification (TMA, e.g., La Rocco, et al., Eur. J. Clin. Microbiol. Infect. Dis., 13, 726-31 (1994), incorporated herein by reference), and rolling circle amplification (RCA, e.g., Lizardi, et al., Nat. Genet., 19, 225-32 (1998), incorporated herein by reference). At least a portion of the target oligonucleotide typically corresponds to either a) the analyte, b) a portion of the analyte, c) a complement of the analyte, or d) a complement of a portion of the analyte. Detection of the target oligonucleotide by the assay indicates presence of the analyte in the original sample.

In general, an assay system for detecting one or more analyte-specific sequences includes a solid support (e.g., a chip, wafer, or a collection of solid particles). Capture oligonucleotides are disposed on the solid support in a manner which permits identification of the capture oligonucleotide (e.g., by position on a chip or wafer or by unique characteristic of particles to which particular capture oligonucleotides are attached). The capture oligonucleotides include a molecular recognition sequence. Different capture oligonucleotides with different molecular recognition sequences are used to detect different analyte-specific sequences. Using these different capture oligonucleotides, a single assay system can be designed to analyze a sample for multiple analyte-specific sequences.

Target oligonucleotides containing the analyte-specific sequences are brought into contact with the capture oligonucleotides. In addition to the analyte-specific sequence, the target oligonucleotides also each include a tagging sequence. A particular tagging sequence is associated with each analyte-specific sequence. The tagging sequence is generally

complementary to one of the molecular recognition sequences. Thus, under hybridization conditions, the target oligonucleotides hybridize with the appropriate capture oligonucleotides. Alternatively, in certain methods of the present invention, the analyte-specific sequence may be complementary to one of the molecular recognition sequences.

The target oligonucleotide or its complement typically includes a reporter or a coupling agent for attachment of a reporter. Observation of the solid support to determine the presence or absence of the reporter associated with a particular capture oligonucleotide indicates whether a particular analyte-specific sequence is present in the sample. Suitable reporters include, without limitation, biotin, fluorescents, chemiluminescents, digoxigenin, spin labels, radio labels, DNA cleavage moieties, chromophors or fluorophors. Examples of suitable coupling moieties include, but are not limited to, amines, thiols, hydrosines, alcohols or alkyl groups.

Examples of suitable assay systems are schematically illustrated in FIGS. 2A and 2B. In these assays, capture oligonucleotides **100a**, **100b** are coupled to a solid support **120**, such as, for example, a single solid substrate **120a** (e.g., a chip or wafer) or one of a number of solid particles **120b**. Typically, at least one of the capture oligonucleotides (e.g., capture oligonucleotide **100a**) has a molecular recognition sequence **102** that is complementary to a tagging sequence **112** of a target oligonucleotide **110** so that, under hybridization conditions, the target oligonucleotide **110** hybridizes to the capture oligonucleotide **100a**.

Although assays can be prepared with all of the capture oligonucleotides having the same global molecular recognition sequence, typically, two or more different groups of capture oligonucleotides **100a**, **100b** are used. Each group of capture oligonucleotides has a different molecular recognition sequence. On a single solid substrate, each group of capture oligonucleotides are typically disposed on a particular region or regions of the substrate such that the region(s) is/are associated with a particular molecular recognition sequence. When a particle support is used, each group of capture oligonucleotides **100a**, **100b** is disposed on at least one group of particles **120b**, **120c** having a unique characteristic such that the capture oligonucleotide of a particular particle is determined from the characteristic of the particle to which it is attached. Such assays can be used to, for example, a) determine which allele is present in a sample by associating different capture oligonucleotides (and different regions of a substrate or different groups of particles) with each allele, b) assay for multiple related or unrelated oligonucleotides or c) both. As illustrated in FIGS. 2A and 2B, the target oligonucleotide preferentially hybridizes to a corresponding capture oligonucleotide permitting determination of the presence or absence of an analyte-specific sequence by observation of the presence or absence of a target oligonucleotide on a particular spatial position of the single support (FIG. 2A) or attached to a particular group of particles (FIG. 2B).

An additional component of the assay system is a reporter **130** that couples to the target oligonucleotide **110** (or its complement **120**), as described below. The reporter **130** is the component of the assay that is subsequently detected by a detection technique (e.g., by colorimetric, fluorescence, electrophoretic, electrochemical, spectroscopic, chromatographic, densitometric, or radiographic techniques) to indicate the presence or concentration of the target oligonucleotide. The reporter will typically be determined by

7

the detection technique (e.g., fluorophore reporters for fluorescent techniques and radio-labels for radiographic techniques.)

In some assays, one or both of the capture oligonucleotide and the target oligonucleotide include at least one non-standard base. The use of non-standard base(s) can improve the specificity of an assay that includes hybridization because non-standard bases preferentially hybridize to other complementary non-standard bases. The use of longer oligonucleotides can also increase the rate of specific hybridization. The hybridization of nucleic acids generally includes the sampling of about three to four bases for complete complementarity. These form nucleation sites. If a nucleation site is found, the hybridization proceeds down the strand. If the bases down the strand are not complementary, then the two strands release. Because the nucleation process takes time, the possibilities of finding a nucleation site when non-standard bases are used is reduced, thereby reducing the number of sampling steps needed to find a complete complement.

Alternatively, the non-standard bases are used to direct the addition of another non-standard base into a sequence (using, for example, PCR techniques). The added non-standard base can include a reporter or a coupling agent to which a reporter can be attached, thereby, permitting the highly selective incorporation of a reporter group for detection of the target oligonucleotide.

Oligonucleotides and Bases

DNA and RNA are oligonucleotides that include deoxyribose or ribose, respectively, coupled by phosphodiester bonds. Each deoxyribose or ribose includes a base coupled to a sugar. The bases incorporated in naturally-occurring DNA and RNA are adenosine (A), guanosine (G), thymidine (T), cytidine (C), and uridine (U). These five bases are "natural bases". According to the rules of base pairing elaborated by Watson and Crick, the natural bases can hybridize to form purine-pyrimidine base pairs, where G pairs with C and A pairs with T or U. These pairing rules facilitate specific hybridization of an oligonucleotide with a complementary oligonucleotide.

The formation of these base pairs by the natural bases is facilitated by the generation of two or three hydrogen bonds between the two bases of each base pair. Each of the bases includes two or three hydrogen bond donor(s) and hydrogen bond acceptor(s). The hydrogen bonds of the base pair are each formed by the interaction of at least one hydrogen bond donor on one base with a hydrogen bond acceptor on the other base. Hydrogen bond donors include, for example, heteroatoms (e.g., oxygen or nitrogen) that have at least one attached hydrogen. Hydrogen bond acceptors include, for example, heteroatoms (e.g., oxygen or nitrogen) that have a lone pair of electrons.

The natural bases, A, G, C, T, and U, can be derivatized by substitution at non-hydrogen bonding sites to form modified natural bases. For example, a natural base can be derivatized for attachment to a support by coupling a reactive functional group (e.g., thiol, hydrazine, alcohol, or amine) to a non-hydrogen bonding atom of the base. Other possible substituents include biotin, digoxigenin, fluorescent groups, and alkyl groups (e.g., methyl or ethyl).

Non-standard bases, which form hydrogen-bonding base pairs, can also be constructed as described, for example, in U.S. Pat. Nos. 5,432,272, 5,965,364, 6,001,983, and 6,037,120 and U.S. patent application Ser. No. 08/775,401, all of which are incorporated herein by reference. By "non-standard base" it is meant a base other than A, G, C, T, or U that is susceptible of incorporation into an oligonucleotide and which is capable of base-pairing by hydrogen bonding, or by

8

hydrophobic, entropic, or van der Waals interactions to form base pairs with a complementary base. FIG. 1 illustrates several examples of suitable bases and their corresponding base pairs. Specific examples of these bases include the following bases in base pair combinations (iso-C/iso-G, K/X, H/J, and M/N):

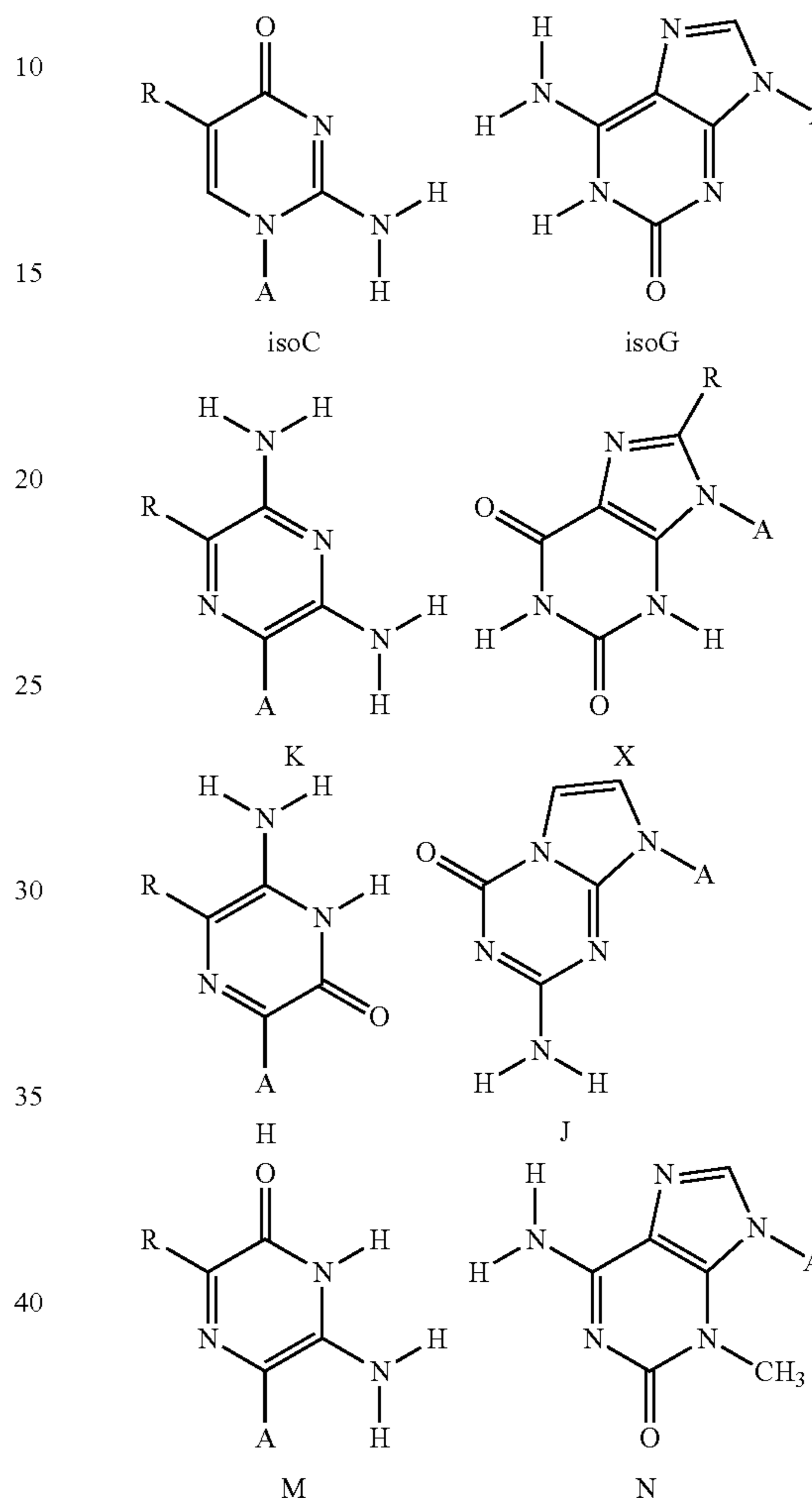

where A is the point of attachment to the sugar or other portion of the polymeric backbone and R is H or a substituted or unsubstituted alkyl group. It will be recognized that other non-standard bases utilizing hydrogen bonding can be prepared, as well as modifications of the above-identified non-standard bases by incorporation of functional groups at the non-hydrogen bonding atoms of the bases. To designate these non-standard bases in FIGS. 3 to 9, the following symbols will be used: X indicates iso-C and Y indicates iso-G.

The hydrogen bonding of these non-standard base pairs is similar to those of the natural bases where two or three hydrogen bonds are formed between hydrogen bond acceptors and hydrogen bond donors of the pairing non-standard bases. One of the differences between the natural bases and these non-standard bases is the number and position of hydrogen bond acceptors and hydrogen bond donors. For example, cytosine can be considered a donor/acceptor/acceptor base with guanine being the complementary acceptor/donor/donor base. Iso-C is an acceptor/acceptor/donor base and iso-G is the complementary donor/donor/acceptor base, as illustrated in U.S. Pat. No. 6,037,120, incorporated herein by reference.

Other non-standard bases for use in oligonucleotides include, for example, naphthalene, phenanthrene, and pyrene derivatives as discussed, for example, in Ren et al., *J. Am. Chem. Soc.* 118, 1671 (1996) and McMinin et al., *J. Am. Chem. Soc.* 121, 11585 (1999), both of which are incorporated herein by reference. These bases do not utilize hydrogen bonding for stabilization, but instead rely on hydrophobic, entropic, or van der Waals interactions to form base pairs.

Solid Supports

The assay is carried out, at least in part, using a solid support. Generally, the capture oligonucleotides are coupled to or otherwise disposed on a surface of the support. A variety of different supports can be used. In some embodiments, the solid support is a single solid support, such as a chip or wafer, or the interior or exterior surface of a tube, cone, or other article. The solid support is fabricated from any suitable material to provide an optimal combination of such desired properties as stability, dimensions, shape, and surface smoothness. Preferred materials do not interfere with nucleic acid hybridization and are not subject to high amounts of non-specific binding of nucleic acids. Suitable materials include biological or nonbiological, organic or inorganic materials. For example, the master array can be fabricated from any suitable plastic or polymer, silicon, glass, ceramic, or metal, and can be provided in the form of a solid, resin, gel, rigid film, or flexible membrane. Suitable polymers include, for example, polystyrene, poly(alkyl)methacrylate, poly(vinylbenzophenone), polycarbonate, polyethylene, polypropylene, polyamide, polyvinylidene fluoride, and the like. Preferred materials include polystyrene, glass, and silicon.

In some embodiments, the single solid support **300** is divided into individual regions **310** with capture oligonucleotides disposed on the support in each region, as illustrated in FIG. 3. In each of the regions or on each particle support, the capture oligonucleotides have predominantly (e.g., at least 75%) the same molecular recognition sequence. Preferably, substantially all (e.g., at least 90% and, more preferably, at least 99%) of the capture oligonucleotides have the same molecular recognition sequence in each region or on each particle support. The capture oligonucleotides of different regions typically have different sequences, although in some instances, the same capture oligonucleotides can be used in two or more regions, for example, as a control or verification of results.

A solid support with different regions can form a regular or irregular array for testing samples and determining the presence or absence of a number of different analyte-specific sequences. For example, an array can be formed to test for 10, 100, 1000 or more different analyte-specific sequences.

Dimensions of the solid support are determined based upon such factors as the desired number of regions and the number of analyte-specific sequences to be assayed. As an example, a solid support can be provided with planar dimensions of about 0.5 cm to about 7.5 cm in length, and about 0.5 cm to about 7.5 cm in width. Solid supports can also be singly or multiply positioned on other supports, such as microscope slides (e.g., having dimensions of about 7.5 cm by about 2.5 cm). The dimensions of the solid support can be readily adapted for a particular application.

Other types of solid supports can be used. In some embodiments, the solid support is a particulate support. In these embodiments, the capture oligonucleotides are coupled to particles. Typically, the particles form groups in which particles within each group have a particular characteristic, such as, for example, color, fluorescence frequency, density, size, or shape, which can be used to distinguish or separate those

particles from particles of other groups. Preferably, the particles can be separated using techniques, such as, for example, flow cytometry.

As contemplated in the invention, the particles can be fabricated from virtually any insoluble or solid material. For example, the particles can be fabricated from silica gel, glass, nylon, resins, Sephadex™, Sepharose™, cellulose, magnetic material, a metal (e.g., steel, gold, silver, aluminum, copper, or an alloy) or metal-coated material, a plastic material (e.g., polyethylene, polypropylene, polyamide, polyester, polyvinylidene fluoride (PVDF)) and the like, and combinations thereof. Examples of suitable micro-beads are described, for example, in U.S. Pat. Nos. 5,736,330, 6,046,807, and 6,057,107, all of which are incorporated herein by reference. Examples of suitable particles are available, for example, from Luminex Corp., Austin, Tex.

In one embodiment, the particulate supports with associated capture oligonucleotides are disposed in a holder, such as, for example, a vial, tube, or well. The target oligonucleotide is added to the holder and the assay is conducted under hybridization conditions. The particulate supports are then separated on the basis of the unique characteristics of each group of supports. The groups of supports are then investigated to determine which support(s) have attached target oligonucleotides. Optionally, the supports can be washed to reduce the effects of cross-hybridization. One or more washes can be performed at the same or different levels of stringency, as described below. As another optional alternative, prior to contact with the support(s) and capture oligonucleotides, the solution containing target oligonucleotides can be subjected to, for example, size exclusion chromatography, differential precipitation, spin columns, or filter columns to remove primers that have not been amplified or to remove other materials that are not the same size as the target oligonucleotides.

In some embodiments, multiple holders (e.g., vials, tubes, and the like) are used to assay multiple samples or have different combinations of capture oligonucleotides (and associated supports) within each holder. As another alternative, each holder can include a single type of capture oligonucleotide (and associated support).

As another example, the support can be a group of individual support surfaces that are optionally coupled together. For example, the support can include individual optical fibers or other support members that are individually coupled to different capture oligonucleotides and then bound together to form a single article, such as a matrix.

Typically, the support (whether a single or particulate support) is capable of binding or otherwise holding the capture oligonucleotide to the surface of the support in a sufficiently stable manner to accomplish the purposes described herein. Such binding can include, for example, the formation of covalent, ionic, coordinative, hydrogen, or van der Waals bonds between the support and the capture oligonucleotides or attraction to a positively or negatively charged support. Capture oligonucleotides are attached to the solid support surface directly or via linkers. In one embodiment, capture oligonucleotides are directly attached to the support surface by providing or derivatizing either the surface, the oligonucleotide, or both, with one or more reactive groups. For example, the surface of the Luminex™ particles can be modified with, for example, carboxylate, maleimide, or hydrazide functionalities or avidin and glass surfaces can be treated with, for example, silane or aldehyde (to form Schiff base aldehyde-amine couplings with DNA). In some embodiments, the support or a material disposed on the support (as, for example, a coating on the support) includes reactive functional groups that can couple with a reactive functional group

on the capture oligonucleotides. As examples, the support can be functionalized (e.g., a metal or polymer surface that is reactively functionalized) or contain functionalities (e.g., a polymer with pending functional groups) to provide sites for coupling the capture oligonucleotides.

As an alternative, the capture oligonucleotides can be retained on the surface by cross-linking of the capture oligonucleotides. Preferably, a capture oligonucleotide that is cross-linked includes a cross-linking portion and a capture portion, where the capture portion includes a molecular recognition sequence that hybridizes to the tagging sequence of the target oligonucleotide.

As yet another alternative, the support can be partially or completely coated with a binding agent, such as streptavidin, antibody, antigen, enzyme, enzyme cofactor or inhibitor, hormone, or hormone receptor. The binding agent is typically a biological or synthetic molecule that has high affinity for another molecule or macromolecule, through covalent or non-covalent bonding. The capture oligonucleotide is coupled to a complement of the binding agent (e.g., biotin, antigen, antibody, enzyme cofactor or inhibitor, enzyme, hormone receptor, or hormone). The capture oligonucleotide is then brought in contact with the binding agent to hold the capture oligonucleotide on the support. Other known coupling techniques can be readily adapted and used in the systems and methods described herein.

Capture and Target Oligonucleotides

The capture oligonucleotide includes a molecular recognition sequence that can capture, by hybridization, a target oligonucleotide having a complementary tagging sequence. The hybridization of the molecular recognition sequence of a capture oligonucleotide and the tagging sequence of a target oligonucleotide results in the coupling of the target oligonucleotide to the solid support. The molecular recognition sequence and tagging sequence are associated with a particular analyte-specific sequence (also part of the target oligonucleotide), thus indicating, if hybridization occurs, the presence or concentration of analyte with the analyte-specific sequence (or its complement) in the original sample.

The coding and tagging sequences typically include at least six nucleotides and, in some instances, include at least 8, 10, 15, or 20 or more nucleotides. In some assays, as described below, the molecular recognition sequence and tagging sequence include one or more non-standard bases. In other assays, the molecular recognition sequence and tagging sequence do not contain non-standard bases.

The capture oligonucleotide also typically includes a functional group that permits binding of the capture oligonucleotide to the solid support or functional groups disposed on or extending from the solid support. The functional group can be attached directly to the polymeric backbone or can be attached to a base in the nucleotidic sequence. As an alternative, the capture oligonucleotide can include a crosslinking portion to facilitate crosslinking, as described above, or can be electrostatically held on the surface. The capture oligonucleotides can be formed by a variety of techniques, including, for example, solid state synthesis, DNA replication, reverse transcription, restriction digest, run-off transcription, and the like.

In addition to the tagging sequence, the target oligonucleotide includes an analyte-specific sequence which corresponds to or is a complement to a sequence of interest in the analyte. The analyte-specific sequence can be independent from the tagging sequence or some or all of the tagging sequence can be part of the analyte-specific sequence.

The length of the capture oligonucleotides can be optimized for desired hybridization strength and kinetics. Usu-

ally, the length of the molecular recognition sequence is in the 6 to 20 (preferably, 8 to 12) nucleotide range. In a preferred embodiment, the different molecular recognition sequences of the capture oligonucleotides are not complementary to one another and, more preferably, to any known natural gene sequence or gene fragment that has a significant probability of being present in a substantial amount in the sample to be tested. As a result, the capture molecular recognition sequences of the capture oligonucleotides will primarily hybridize to the respective complementary tagging sequences of the target oligonucleotides.

The target oligonucleotide (or an oligonucleotide complementary to at least a portion of the target oligonucleotide) includes a reporter or a coupling agent for attachment of a reporter. The reporter or coupling agent can be attached to the polymeric backbone or any of the bases of the target or complementary oligonucleotide. Techniques are known for attaching a reporter group to nucleotide bases (both natural and non-standard bases). Examples of reporter groups include biotin, digoxigenin, spin-label groups, radio labels, DNA-cleaving moieties, chromophores, and fluorophores such as fluorescein. Examples of coupling agents include biotin or substituents containing reactive functional groups. The reporter group is then attached to streptavidin or contains a reactive functional group that interacts with the coupling agent to bind the reporter group to the target or complementary oligonucleotide.

Polymerase Chain Reaction (PCR) Techniques

A variety of Polymerase Chain Reaction (PCR) techniques are known and can be used in the assays described below. PCR techniques are typically used for the amplification of at least a portion of an oligonucleotide. The sample to be tested for the presence of an analyte-specific sequence is contacted with the first and second oligonucleotide primers; a nucleic acid polymerase; and nucleotide triphosphates corresponding to the nucleotides to be added during PCR. The natural base nucleotide triphosphates include dATP, dCTP, dGTP, dTTP, and dUTP. Nucleoside triphosphates of non-standard bases can also be added, if desired or needed. Suitable polymerases for PCR are known and include, for example, thermostable polymerases such as native and altered polymerases of *Thermus* species, including, but not limited to *Thermus aquaticus* (Taq), *Thermus flavus* (Tfl), and *Thermus thermophilus* (Tth), as well as the Klenow fragment of DNA polymerase I and the HIV-1 polymerase.

The first and second primers are complementary to different portions on different strands of the double stranded oligonucleotide that is to be amplified. The sequence of the oligonucleotide that is amplified includes the two primer sequences that hybridize to the analyte and the region between the two primers. The primers can be formed by a variety of techniques including, for example, solid state synthesis, DNA replication, reverse transcription, restriction digest, run-off transcription, and the like.

PCR includes the cycling steps of (i) annealing the first oligonucleotide primer and the second oligonucleotide primer to the double stranded oligonucleotide that is to be amplified or to extension products formed in previous cycles; (ii) extending the annealed first and second oligonucleotide primers by the nucleic acid polymerase to synthesize primer extension products; and (iii) denaturing the products to obtain single stranded nucleic acids. Varieties of PCR have been developed by modifying the steps or varying conditions (e.g., time and temperature). Generally, any of these varieties of PCR can be used in the assays described below, although some may be more useful than others for particular assays.

One variety of PCR developed for some of the assays described below is “fast-shot PCR” in which primer extension times are reduced or eliminated. As used herein, the term “fast-shot polymerase chain reaction” or “fast-shot PCR” refers to PCR where the extension step, as well as the stops for the annealing and melting steps, are very short or eliminated. Typically, for this method, the 3' ends of the two primers are separated by no more than 10 bases on the template nucleic acid.

Enhanced specificity is achieved by using fast-shot PCR cycles where the extension step, as well as the stops for the annealing and melting steps, are very short or eliminated. In some embodiments, the PCR solution is rapidly cycled between about 90 to 100° C. and about 55 to 65° C. with a maximum of about a one second hold at each temperature, thereby leaving the polymerase very little time to extend mismatched primers. In one embodiment, the reaction is cycled between about 95° C. and about 58° C. with about a one second hold at each temperature.

This rapid cycling is facilitated by generating a short PCR product by, in general, leaving a gap of about zero (0) to ten (10) bases on the template nucleic acid between the 3' bases of the first and second primers. Preferably, the primers are designed to have a T_m of approximately 55 to 60° C. For some embodiments, a total of about 37 cycles is typically adequate to detect as little as 30 target oligonucleotides.

Allele specific PCR primers can be used to discriminate SNP (single nucleotide polymorphism) and other alleles. For SNP detection, these primers are designed to be complementary to each allele such that the polymorphic base of interest is positioned at or near (typically, within three or five bases) the 3' end of the first or second primer. High levels of allelic discrimination are achieved in part by the limited ability of Taq polymerase to extend a primer which has a nucleotide mismatch at its 3' end with that of the target DNA, i.e., the corresponding allele to which the primer is not specific. Other polymerases can also be used.

Additionally, allelic discrimination can be obtained by placing the mismatch at other positions in the allele specific primer. These alternate positions for the nucleotide mismatch in the primer can be used to achieve selective amplification in two primary ways: 1) by simply lowering the T_m (melting temperature) of the primer so that it is not hybridized on the template DNA during thermal cycling so that the polymerase can not extend the primers, or 2) by creating an unfavorable primer/template structure that the polymerase will not extend.

Examples of Assays

Assays with Non-standard Bases in the Coding and Tagging Sequences

In one assay illustrated in FIG. 4, two or more groups of capture oligonucleotides **202** are prepared. Each group of capture oligonucleotides **202** includes a unique molecular recognition sequence **204**. The molecular recognition sequence of each group includes at least one (and, typically, two or more) non-standard bases (denoted by the use of dashed lines in the Figures). The use of non-standard bases substantially reduces the likelihood that the capture oligonucleotides will hybridize with sequences that include only natural bases. This will typically result in less non-specific hybridization when compared to a similar assay using oligonucleotides with only natural bases. The capture oligonucleotide also typically includes a reactive functional group for attachment to the solid support **206**, although other attachment methods can be used, as described above.

The support for the assay can be, for example, a single solid support, such as, for example, a glass, metal, plastic, or inorganic chip. The capture oligonucleotides are disposed on the

support and typically held by one of the methods described above (e.g., coupling via reactive groups on the capture oligonucleotide and support, use of a binding agent disposed on the support, or cross-linking of the capture oligonucleotides). Each of the groups is disposed in one or more unique regions of the solid support so that the region(s) can be associated with a particular capture oligonucleotide.

In another embodiment (not shown), the support for the assay is a particulate support (e.g., beads). It will be understood that any of the assays described herein can be performed on a single solid support, on a particulate support, or any other support. The particulate support is divided into groups of particles, each group of particles having a characteristic (e.g., color, shape, size, density, or other chemical or physical property) that distinguishes that group of particles from other groups. Each group of capture oligonucleotides is coupled to one or more groups of particles. This produces an association of a particular group of particles with a particular group of capture oligonucleotides, allowing the determination of the capture oligonucleotide by observation of the unique particle support characteristic.

Returning to FIG. 4, the target oligonucleotide **208**, if present in the assayed sample, contains an analyte-specific sequence **210** and a tagging sequence **212** complementary to the molecular recognition sequence **204** of one group of the capture oligonucleotides **202**. The tagging sequence **212** contains at least one non-standard base; otherwise the tagging sequence would not be complementary to the molecular recognition sequence of the capture oligonucleotide. An oligonucleotide **214** complementary to a portion of the target oligonucleotide **208** includes a reporter **216** or a coupling agent (not shown) for attachment of a reporter.

The target oligonucleotide **208** and complementary oligonucleotide **214** can be formed by, for example, PCR amplification of an analyte containing the analyte-specific sequence or its complement. In PCR amplification, two different primers are used (as illustrated at B of FIG. 4). A first primer **218** contains a sequence complementary to a first sequence on a first strand of the analyte **220**. A second primer **222** contains a sequence that is the complementary to a second sequence on a second strand of the analyte **220** which is upstream or downstream of the first sequence. The analyte-specific sequence typically includes the sequence of the analyte stretching between, and including, the sequences (or complements) to which the primers hybridize. The first primer **218** includes the tagging sequence **212** and the second primer **222** includes the reporter **216** (or a coupling agent for a reporter). Extension of the first and second primers and amplification proceeds using known PCR amplification techniques or the fast-shot PCR techniques described above to produce the target oligonucleotide **208** and complementary oligonucleotide **214** (as illustrated at C of FIG. 4). Other known synthetic methods, such as, for example, solid state synthesis, DNA replication, reverse transcription and the like, can be used to form the target and complementary oligonucleotides.

Returning to the assay, the target oligonucleotide **208** is typically brought into contact with the support **206** (or a container holding a particulate support) with associated capture oligonucleotides **202**. Conditions are controlled to promote selective hybridization of the tagging sequence of the target oligonucleotide with a complementary molecular recognition sequence of a capture oligonucleotide, if an appropriate capture oligonucleotide is present on the support (as illustrated at D of FIG. 4). A reporter is also added (unless the complementary oligonucleotide **214** already contains the reporter) for coupling to the complementary oligonucleotide **214**. Optionally, unincorporated primers can be removed

prior to hybridization by techniques such as, for example, size exclusion chromatography, differential precipitation, spin columns, or filter columns, or after hybridization by, for example, washing.

For assays on a planar solid support, the assay can be read by determining whether the reporter group is present at each of the individual regions on the support. The presence of the reporter group indicates that the original sample contains an analyte having the analyte-specific sequence associated with the particular tagging sequence and molecular recognition sequence for that region of the support. The absence of the reporter group suggests that the sample did not contain an analyte having the particular analyte-specific sequence.

For assays on particle supports, the particles can be separated according to the unique characteristics and then it is determined which particles have a reporter coupled to the particle via the capture and target oligonucleotides. Techniques for accomplishing the separation include, for example, flow cytometry. The presence of the reporter group indicates that the sample contains the target oligonucleotide having the analyte-specific sequence associated with a particular tagging sequence and the molecular recognition sequence of a particular capture oligonucleotide.

The assay illustrated in FIG. 4 can be adapted for use in determining the presence of alleles in a sample. For example, the assay includes allele-specific primers (either the first or second primers **218**, **222** or both) corresponding to two or more alleles. Each of the allele-specific primers includes a sequence that specifically hybridizes to only one allele. The tagging sequence or reporter (or coupling agent) attached to the allele-specific primer is also specific for the allele. If the allele is present in the sample, the allele-specific primer(s) associated with that allele will extend and will be detected by either hybridizing to a complementary, allele-specific capture oligonucleotide on the support or observing an allele-specific reporter group. It will be recognized that the assay can also be used to determine the presence or absence of non-allelic analyte-specific sequences in the analyte.

This method can be used to detect SNP (single nucleotide polymorphism) alleles. Either the first or second primers will be SNP-specific. Typically, two (or more) different SNP-specific primers will be used in the assay. Preferably, the SNP-specific primers will have the SNP site positioned at or near (e.g., within three or five bases) the extendable end of the primer. "Fast-shot PCR" techniques can be useful in this SNP assay because the short extension times will substantially reduce the likelihood that non-complementary primers will extend.

Hybridization of the capture oligonucleotides and target oligonucleotides is a feature of the assays described herein. This hybridization takes place in a hybridization mixture that contains salts (e.g., sodium salts or magnesium salts), a buffer (e.g., TRIS, TAPS, BICINE, or MOPs), a non-specific blocking agent (e.g., SDS, BSA, or sheared genomic DNA), and a protecting agent (e.g., EDTA or an azide), as is used in many conventional hybridization methods. Typically, the hybridization takes place at a sodium ion (or other cation) concentration of at least 0.01 to 1.0 M and a pH of 7.0 to 8.3. Generally, this hybridization and any washing steps are performed at a temperature and salt concentration that meet desired stringency conditions for maintaining hybridization. Stringency conditions are sequence dependent. Stepwise increases in stringency conditions can be used, if desired, over several washing steps.

"Low stringency conditions" are selected to be about 10 to 15° C. below the thermal melting point (T_m) for the specific sequence at the ionic strength and pH of the hybridizing

solution. T_m is the temperature (for the ionic strength, pH, and nucleic acid concentration) at which about 50% of the tagging sequences hybridize to complementary molecular recognition sequences at equilibrium.

"Moderate stringency conditions" are selected to be about 5 to 10° C. below the thermal melting point (T_m) for the specific sequence at the ionic strength and pH of the hybridizing solution.

"High stringency conditions" are selected to be no more than about 5° C. below the thermal melting point (T_m) for the specific sequence at the ionic strength and pH of the hybridizing solution.

In another assay illustrated in FIG. 5, two or more groups of capture oligonucleotides **252** are prepared and placed on a support **256**, as illustrated at A of FIG. 5. Each group of capture oligonucleotides **252** includes a unique molecular recognition sequence **254**. The molecular recognition sequence of each group includes at least one (and, typically, two or more) non-standard bases. A target oligonucleotide **258** and complementary oligonucleotide **264** can be formed by, for example, PCR amplification of an analyte containing the analyte-specific sequence or its complement. In PCR amplification, two different primers are used (as illustrated at B and C of FIG. 5). A first primer **268** contains a sequence complementary to a first sequence on a first strand of the analyte **270**. A second primer **272** contains a sequence that is the complementary to a second sequence on a second strand of the analyte **270** which is upstream or downstream of the first sequence. The analyte-specific sequence typically includes the sequence of the analyte stretching between, and including, the sequences (or complements) to which the primers hybridize. The first primer **268** includes the tagging sequence **262** and the second primer **272** includes the reporter **266** (or a coupling agent for a reporter).

The target oligonucleotide **258** is typically brought into contact with the support **256** (or a container holding a particulate support) with associated capture oligonucleotides **252**. Conditions are controlled to promote selective hybridization of the tagging sequence of the target oligonucleotide with a complementary molecular recognition sequence of a capture oligonucleotide, if an appropriate capture oligonucleotide is present on the support (as illustrated at D of FIG. 5). A reporter is also added (unless the complementary oligonucleotide **264** already contains the reporter) for coupling to the complementary oligonucleotide **264**. Optionally, unincorporated primers can be removed prior to hybridization by techniques such as, for example, size exclusion chromatography, or after hybridization by, for example, washing.

An enzyme **280** is then provided to covalently couple the complementary oligonucleotide **264** to the capture oligonucleotide **252**. Suitable enzymes include ligases. Optionally, the target oligonucleotide **258** is denatured from the complementary oligonucleotide **264** and the target oligonucleotide and other components of the assay are washed away leaving the complementary oligonucleotide **264** bound to the support **256**, as illustrated at E of FIG. 5. The reporter **266** can then be detected.

In yet another assay illustrated in FIG. 6, the target oligonucleotide **314** forms a hairpin or stem-loop structure **321**, **323** (or structure other than the typical double helix). In this assay, each of the first and second primers **318**, **322** includes a portion of the tagging sequence **312b** or a complement to a portion of the tagging sequence **312a**. In addition, one of the primers **322** has a reporter **316** (or coupling agent for a reporter) attached to the portion of the tagging sequence **312b**. Using, for example, PCR techniques, the first and second primers **318**, **322** amplify the analyte **320** to produce a

target oligonucleotide **314** and its complement **308**. The tagging sequence **312b**, **313a** of the target oligonucleotide **314** is distributed at both ends of the target oligonucleotide.

The target oligonucleotide **314** is denatured from its complement **308** and brought into contact with the solid support **306** having capture oligonucleotides **302** with molecular recognition sequences **304**. If the molecular recognition sequence **304** of one of the capture oligonucleotides is complementary to the tagging sequence **312b**, **313a** of the target oligonucleotide **314**, the target oligonucleotide **314** will hybridize to that capture oligonucleotide. In some embodiments, the capture oligonucleotide is divided into two parts, each part complementary with one of the parts of the tagging sequence **312b**, **313a**. The two parts are coupled by a linker. The linker can be additional nucleotides or any other chemical linking moiety. The target sequence of the target oligonucleotide **314** forms at least part of a stem-loop structure **321**, **323** (or structure other than a double helix). Detection is then performed as discussed above in the previous example.

In an alternative assay illustrated in FIG. 7, an analyte **420** is contacted by initial primers **440**, **442** each having a sequence that is complementary to a sequence of the analyte **420**, as illustrated at A of FIG. 7. One of the initial primers **440** also includes a coupling group **444** (e.g., biotin or a substituent containing a reactive functionality) for attachment to a substrate **450**. The initial primers **440**, **442** are extended using, for example, PCR techniques, as illustrated at B of FIG. 7. The extended initial primers **446**, **448** each include the analyte-specific sequence or its complement.

The extended initial primers **446**, **448** are then brought into contact with a substrate **450** that interacts with the coupling group **444** of extended initial primer **446** to attach the extended initial primer **446** to the substrate **450**, as illustrated at C of FIG. 7. For example, the substrate can be coated with streptavidin and the extended initial primer include biotin.

Next, first and second primers **418**, **422** are brought into contact with the extended initial primers **446**, **448**, as illustrated at C of FIG. 7. The first primer **418** has a tagging sequence **412** and the second primer **422** has a reporter **416** (or coupling agent for a reporter). Both primers also include a sequence complementary to a section of the extended initial primers **446**, **448**. The assay illustrated in FIG. 7 also shows that other primers **422a** can be added. This is not a necessary feature of the assay, but is used to illustrate one embodiment of an assay for detecting alleles. The use of allele specific primers can be used in any of the other assays illustrated herein.

In the illustrated assay, primers **422**, **422a** are allele-specific primers with allele-specific reporters **416**, **416a**. In the illustrated example, the alleles differ by a single nucleotide, although it will be understood that other allele-specific assays with more than one nucleotide difference can be performed using these techniques. Primer **422** is extended because it is complementary to a sequence on the extended initial primer **446**. Primer **422a** does not extend because it is not complementary to extended initial primer **446**. It will be recognized that an alternative assay includes several different allele-specific primers with allele-specific tagging sequences (as opposed to allele-specific reporters). It will also be recognized that another alternative assay includes non-allelic primers for determination of the presence or absence of non-allelic analyte-specific sequences in the analyte.

The primers **418**, **422** are extended to form the target oligonucleotide **408** with the tagging sequence **412** and the complementary oligonucleotide **414** with the reporter **416** (or a coupling agent for a reporter). The target oligonucleotide

408 and complementary oligonucleotide **414** are denatured from the extended initial primers **446**, **448** and brought into contact with capture oligonucleotides **402** on a solid support **406** (e.g., chip, wafer, or particles). The target oligonucleotide **414** hybridizes to a capture oligonucleotide **402** having a molecular recognition sequence **404** complementary to the tagging sequence **412**. The presence or absence of particular analyte-specific sequences in the analyte is determined by observation of the presence or absence of reporter associated with each unique group of capture oligonucleotides.

In another example of an assay, a first primer **468** and a second primer **472** are brought into contact with an analyte **470** and extended to form a target oligonucleotide **458** and complementary oligonucleotide **464**. In the illustrated example, the first and second primers **468**, **472** are both allele-specific, but specific to different alleles. In addition to the first and second primers **468**, **472**, other first and second primers **469**, **473** are included to amplify other alleles, if present in the sample.

The first primer **468** includes a first part **462a** of a tagging sequence and the second primer **472** includes a second part **462b** of the tagging sequence. One of the parts **462a**, **462b** includes a reporter **466** (or coupling agent for a reporter). Typically, the parts **462a**, **462b** of the tagging sequence will be configured so that the extension of the primers **468**, **472** does not proceed through the tagging sequence. For example, the parts **462a**, **462b** can include a non-standard base as the base linking the part of the tagging sequence to the extendable portion of the primers **468**, **472**. In this embodiment, the nucleotide triphosphate of the complement of the non-standard base is not included in the PCR amplification process. Alternatively, a chemical linker can be used to couple the part of the tagging sequence to the extendable portion of the primer. Examples of suitable linkers include, but are not limited to, n-propyl, triethylene glycol, hexaethylene glycol, 1',2' dideoxyribose, 2'-O-methylribose nucleotides, deoxyisocytidine, or any linkage that would halt the polymerase.

A coupling oligonucleotide **452** is provided on a support **456**. The coupling oligonucleotide **452** includes parts **453a**, **453b** that are complementary to the parts **462a**, **462b** of the tagging sequence. These parts **453a**, **453b** are coupled by a chemical or nucleotidic linker **454** that is capable of coupling 5' (or 3') ends of two nucleotidic sequences.

The target oligonucleotide **458** and complementary oligonucleotide **464** are brought in contact with the support **456** and capture oligonucleotide **452** to hybridize the corresponding parts **453a**, **453b** of the capture oligonucleotide with the respective parts **462a**, **462b** of the tagging sequence. The remainder of the target oligonucleotide **458** and complementary oligonucleotide **464** will typically form a structure such as that illustrated in FIG. 8.

Assays in which Non-standard Bases are Added by PCR Techniques

Although labeled natural nucleotide bases have many uses, there are shortcomings associated with labeled natural nucleotides. For example, site specific incorporation of a labeled natural nucleotide base is difficult to achieve. Generally, to label a position in an oligonucleotide which contains adenine, labeled adenosine triphosphate (dATP*) is added as a substrate to a reaction mix which includes an oligonucleotide template, dGTP, dCTP and dTTP, and a polymerase enzyme. If all dATP's in the reaction mix are labeled, all the adenine residues in the oligonucleotide sequence will be labeled. If a fraction of the dATP's in the reaction mix are labeled, adenine residues in random positions in the sequence are labeled. It is thus extremely difficult to label a single nucleotide residue in an oligonucleotide.

To overcome the problems associated with the incorporation of multiple labeled nucleotide residues, labeled dideoxynucleic acids have been used. Because the dideoxynucleic acid lacks a 3' hydroxyl group, the oligonucleotide is terminated at the position where the labeled dideoxynucleic acid is introduced. To determine the position of the labeled nucleotide, ladders are run to sequence the oligonucleotide. Because the oligonucleotide is terminated at the position where the dideoxynucleic acid is introduced, dideoxynucleic acids cannot generally be used in connection with amplification of the oligonucleotide strand.

FIG. 9 illustrates one type of assay, according to the invention, which includes the incorporation of a non-standard base by PCR. First and second primers **518**, **522** are hybridized to analyte **520** and extended. One of the primers **522** includes a non-standard base **550** which, when extended, becomes the target oligonucleotide **508**. Optionally, additional bases can be provided after the non-standard base **550**. The target oligonucleotide **508** with the non-standard base **550** is then brought into contact with the solid support **506a**, **506b** that includes capture oligonucleotides **502a**, **502b**. The solid support illustrated in FIG. 9 is the particulate support discussed above, however, it will be recognized that a single solid support (e.g., a chip or wafer) could also be used.

The capture oligonucleotides **502a**, **502b** are different and are attached to different supports **506a**, **506b**, respectively, so that the capture oligonucleotide can be recognized by observing the unique property of the support to which it is attached. One capture oligonucleotide **502a** hybridizes with the target oligonucleotide **508**. The capture oligonucleotide **502a** in this embodiment has a sequence that is complementary to at least a portion of the analyte-specific sequence of the target oligonucleotide **508**.

After hybridization of the target oligonucleotide **508**, the capture oligonucleotide **502a** is extended in a PCR solution that includes dATP, dUTP, dGTP, dCTP, and the nucleotide triphosphate of a second non-standard base (e.g., diso-GTP) **552** complementary to the non-standard base **550** on the target oligonucleotide **508**. The second non-standard base **552** is labeled with a reporter **516** (or coupling agent for a reporter). As the capture oligonucleotide is extended, the second non-standard base **552** with the reporter **516** is incorporated into the extended capture oligonucleotide opposite the non-standard base **550**. Thus, the presence or absence of a reporter on a particular group of particulate supports indicates the presence or absence of a particular target oligonucleotide associated with the capture oligonucleotide.

FIG. 10 illustrates another assay. In this assay, the first primer **618** includes a tagging sequence **612** and the second primer **622** has a non-standard base **621** (or a sequence containing a non-standard base) at its 5' end. The primers **618**, **622** amplify the analyte **620** in the presence of the dATP, dCTP, dGTP, dTTP, and the nucleotide triphosphate of the non-standard base complementary to non-standard base **621**. This non-standard base nucleotide triphosphate is labeled with a reporter **616** (or coupling group for a reporter) and is incorporated opposite non-standard base **621** to form the target oligonucleotide **608**.

The target oligonucleotide **608** is brought into contact with the solid support **606** having capture oligonucleotides **602** with molecular recognition sequences. If one of the molecular recognition sequences is complementary to the tagging sequence **612** of the target oligonucleotide **608**, the target oligonucleotide **608** will hybridize to the capture oligonucleotide **602**. Detection is then performed as discussed above in the previous examples.

FIG. 11 illustrates yet another assay. In this assay, the first primer **718** includes a tagging sequence **712** and the second primer **722** has a non-standard base **721** followed by a natural base **723** (or a sequence of natural bases) at its 5' end. The primers **718**, **722** amplify the analyte **720** in the presence of the dATP, dCTP, dGTP, and dTTP only to form a partially extended target oligonucleotide **707** and its complement **714**. The extension of the partially extended target oligonucleotide is limited by the non-standard base **721**. After this initial amplification, the amplification products **707**, **714** are washed to remove dATP, dCTP, dGTP, and dTTP.

A second extension step is then performed, in the presence of the triphosphate of the non-standard base complementary to non-standard base **721** and at least the triphosphate of the natural base complementary to natural base **723**. This natural base triphosphate is labeled with a reporter **716** (or coupling group for a reporter) and is incorporated opposite natural base **723** to form the target oligonucleotide **708**.

The target oligonucleotide **708** is brought into contact with the solid support **706** having capture oligonucleotides **702** with molecular recognition sequences. If one of the molecular recognition sequences is complementary to the tagging sequence **712** of the target oligonucleotide **708**, the target oligonucleotide **708** will hybridize to the capture oligonucleotide **702**. Detection is then performed as discussed above in the previous examples.

In one embodiment, allele-specific second primers are used with the same first primer. The allele-specific second primers are differentiated in the portion of the second primer that anneals to the analyte. A different natural base **723** is selected for each allele. During the second extension step, where bases are added opposite the non-standard base **721** and natural base **723**, the nucleotide triphosphates of two or more natural bases are added to the extension mixture. The different nucleotide triphosphates are labeled with different reporters. Thus, if the natural base **723** can be A or C, depending on the allele, the dTTP and dGTP used in the extension step are labeled with different reporters. The identity of the reporter can be used to determine the presence of a particular, associated allele. Thus, for example, four different alleles can be simultaneously tested using this method and, with appropriate choice of reporters, can be indicated using four different colors.

Other Assays

In one assay illustrated in FIG. 16, two or more groups of capture oligonucleotides **902** are prepared. Each group of capture oligonucleotides **902** includes a unique molecular recognition sequence **904**. The molecular recognition sequence of each group optionally includes at least one or more non-standard bases. The capture oligonucleotide also typically includes a reactive functional group for attachment to a solid support **906**, although other attachment methods can be used, as described above.

In one embodiment, the support for the assay is a particulate support (e.g., beads). It will be understood that any of the assays described herein can be performed on a single solid support, on a particulate support, or any other support. The particulate support is divided into groups of particles, each group of particles having a characteristic (e.g., color, shape, size, density, or other chemical or physical property) that distinguishes that group of particles from other groups. Each group of capture oligonucleotides is coupled to one or more groups of particles. This produces an association of a particular group of particles with a particular group of capture oligonucleotides, allowing the determination of the capture oligonucleotide by observation of the unique particle support characteristic.

In another embodiment (not shown), the support for the assay can be, for example, a single solid support, such as, for example, a glass, metal, plastic, or inorganic chip. The capture oligonucleotides are disposed on the support and typically held by one of the methods described above (e.g., coupling via reactive groups on the capture oligonucleotide and support, use of a binding agent disposed on the support, or cross-linking of the capture oligonucleotides). Each of the groups is disposed in one or more unique regions of the solid support so that the region(s) can be associated with a particular capture oligonucleotide.

Returning to FIG. 16, the target oligonucleotide **908**, if present in the assayed sample, is contacted with a first primer **909** and a second primer **911**. The first and second primers **909**, **911** can be allele-specific or, preferably, are not complementary to allele specific portions of the target oligonucleotide (i.e., the allele specific portions of interest are positioned within the target oligonucleotide between the regions that hybridize to the two primers). The second primer **911** also includes a non-complementary attachment region **905**. This non-complementary reporter attachment region **905** optionally includes one or more non-standard bases. The target oligonucleotide **908** is amplified using the first and second primers **909**, **911** and PCR techniques to obtain an amplification product **907** that includes the reporter attachment region **905**.

The amplification product **907** is then contacted with allele specific primers **920a**, **920b** that are then extended, if the particular allele is present, using reaction conditions and reaction components similar to PCR to provide an allele specific extension product **922**. Each allele specific primer **920a**, **920b** has an allele-specific tagging sequence **912a**, **912b** that is complementary to different molecular recognition sequences **904** and capture oligonucleotides **902**. When extending the allele specific primers **920a**, **920b**, a labeled nucleotide **925** (or oligonucleotide) that is complementary to one or more bases of the attachment region **905** is provided. The labeled nucleotide **925** or oligonucleotide can include a reporter or a coupling agent, such as biotin, for attachment of a reporter.

After forming the extension product **922**, contact is made with the capture oligonucleotides **902** and with a reporter **930** (unless a reporter was already attached). The capture oligonucleotide **902** and the support **906** identify which allele(s) is/are present in the sample and the reporter provides for detection of the extension product **922**. For assays on particle supports, the particles can be separated according to the unique characteristics and then it is determined which particles **906** have a reporter coupled to the particle via the capture oligonucleotide **902** and extension product **922**. Techniques for accomplishing the separation include, for example, flow cytometry. The presence of the reporter group indicates that the sample contains the allele associated with a particular allele-specific tagging sequence.

Selection of Molecular Recognition Sequences

When multiple molecular recognition sequences are used to form an assay system that can detect more than one analyte-specific sequence with application of a single sample, a collection of different molecular recognition sequences is typically needed. Preferably, the molecular recognition sequences are sufficiently different to permit reliable detection of analyte-specific sequences under a desired set of stringency conditions. A variety of different methods can be used to choose the collection of molecular recognition sequences. The following is a description of some methods and criteria that can be used. The methods and criteria can be used individually or in combinations.

The following are examples of criteria that can be used in creating a collection of molecular recognition sequences: the number of bases in the sequence, the number of non-standard bases in the sequence, the number of consecutive natural bases in the sequence, the number of consecutive bases (in either the forward or reverse directions) that are the same in any two sequences, specific required sequences (e.g., GC clamps at the 3' or 5' ends or both) and the estimated or actual melting temperature. One example of a method for determining T_m is described in Peyret et al., *Biochemistry*, 38, 3468-77 (1999), incorporated herein by reference. The non-standard bases can be estimated or accounted for using, for example, values for other bases (e.g., iso-G/iso-C can be estimated using G/C) or using experimental data such as that described below.

The following are a set of steps that can be used to form the collection of molecular recognition sequences:

- 1) Create a set of all possible oligonucleotides having a length of n_1 (e.g., 8, 9, or 10 nucleotides) using the natural bases and the desired non-standard bases (e.g., iso-C, iso-G, or both).
- 2) Optionally require that the oligonucleotides have a particular subsequence (e.g., GC clamps on the 3' or 5' ends or both ends).
- 3) Remove oligonucleotides without at least n_2 non-standard bases (e.g., without at least two iso-C bases) or with more than n_3 non-standard bases (e.g., with more than two iso-C bases) or both (e.g., accept only oligonucleotides with exactly two iso-C bases).
- 4) Optionally remove oligonucleotides with n_4 (e.g., four or five) natural bases in a row.
- 5) Select one of the remaining oligonucleotides and eliminate any of the remaining oligonucleotides that have n_5 bases (e.g., five or six bases) in the same order anywhere in the oligonucleotide sequence. Repeat for each non-eliminated oligonucleotide.
- 6) Optionally select one of the remaining oligonucleotides and determine its reverse complement (e.g., the reverse complement of "ACT" is "AGT"), then eliminate any of the other oligonucleotides that have n_6 consecutive bases (e.g., four or five bases) that are the same as a portion of the sequence of the reverse complement. Repeat for each non-eliminated oligonucleotide.
- 7) Optionally select only the remaining oligonucleotides that have an estimated or actual melting temperature (T_m) within a desired temperature range, above a desired temperature limit, or below a desired temperature limit. For example, oligonucleotides can be eliminated that having a melting temperature below room temperature (about 22° C.).

EXAMPLES

Example 1

Cross-hybridization Analysis of Coding and Tagging Sequences

The equipment used in this analysis includes Luminex® 100 and Luminex® microbeads, DNA synthesizer (Northwestern Engineering, Inc.), Spectrophotometer for spot checking synthesis yields, thin layer chromatography (TLC) (SI250F TLC plate-silica gel, JTBaker) for oligonucleotide quality control, centrifuge, sonicator (Ney Dental), Vortex Genie (Vortex), and various pipettes (2, 20, 200, and 1000 μ L).

A set of more than 100 oligonucleotides (molecular recognition sequences) and their complements (tagging sequences)

23

were designed and synthesized. The two sets of oligonucleotides contained non-standard (isoC and isoG)(EraGen Biosciences, Inc., Madison, Wis.) and natural (A, G, C, and T) (Perkin-Elmer/ABI) nucleotides and were 9 to 10 bases in length. The first set of the oligonucleotides was designated as molecular recognition sequences and labeled on the five prime end with an amino modifier (C6-TFA, Glen Research). The complement sets of oligonucleotides were designated the tagging sequence and labeled on the five prime end with Cy3 (Glen Research).

The following reagents were used in coupling the molecular recognition sequence to the unique Luminex beads: 0.1 mM pH4.5, 2-[N-morpholino]ethanesulfonic acid (MES) (Sigma).

1-ethyl-3-(3-dimethylaminopropyl) carbodiimide-HCl (EDC) (Pierce), 0.02% (v/v) Tween (Sigma), 0.1% (w/v) SDS (Sigma).

The hybridization step included a hybridization buffer Sourav 0.5 containing 10 mM Tris (Sigma), 1 mM EDTA (Sigma), 200 mM NaCl (Aldrich), 10 mM MgCl₂ (Aldrich), and 1% (w/v) PEG 8000 (Sigma).

Ninety-eight of the molecular recognition sequences were diluted to 1 nmol/ μ L in MES. Ninety-eight unique sets of Luminex® beads were prepared for coupling. The beads were sonicated for 20 seconds and vortexed for 10 seconds before being aliquoted. From the stock beads (1.25 \times 10⁷ beads/mL), 5 million beads were selected and placed in a 1.5 mL microcentrifuge tube. The beads were centrifuged at 10,000 rcf for 1 minute. The beads were then decanted, being careful not to disturb the beads. Finally, the beads were brought to 50 μ L in MES, sonicated and vortexed. To couple the molecular recognition sequence to a distinct bead, 1 nmol of each molecular recognition sequence was added to one of the unique bead sets. Next, 1.75 μ L of a fresh EDC (20 mg EDC/1 mL ddH₂O) was added to the mixture, sonicated and vortexed. The mixture was then allowed to incubate at room temperature in the dark for 30 minutes, vortexing every 10 minutes. After 30 minutes, another 1.75 μ L of a fresh EDC was added and incubated for 30 minutes, vortexing every 10 minutes.

After coupling, the beads were washed by adding 400 μ L Tween-20, vortexed, centrifuged (10,000 rcf/1 min) and decanted. Next 400 μ L SDS was added, centrifuged, decanted and finally brought up in 100 μ L in MES and enumerated.

The complementary oligonucleotides (the tagging sequences) were quantified and qualified using TLC and polyacrylamide gel, and diluted to a final working concentration of 50 fmol/ μ L in MOPS.

After enumeration, the Luminex® bead/molecular recognition sequences were combined into a 98 bead set (1000 beads/bead region/well) for analysis. From the 98 bead set, a 50 bead set (2500 beads/bead region/well) was created. Table 1 includes the molecular recognition sequences for the 50 bead set and Table 2 includes the molecular recognition sequences for the 98 bead set.

To setup the cross hybridization experiment, 50 femtomoles of tagging sequences (1->98) were pipetted into wells in two 96 well plates (wells 1 and 2 were used for controls). Current limitations of the Luminex® 100, trimmed the dataset to 98 tagging sequences, with 2 controls for background subtraction (no tagging sequence).

The master mix of beads (98 mix), 10 μ L/well, was then added to each well along with 31 μ L of 2 \times Sourav 0.5 hybridization buffer and sufficient quantity of ddH₂O, to give a final volume of 62 μ L/well. The reagents were mixed well and allowed to incubate at room temperature for approximately 10 minutes. The samples were immediately analyzed by flow cytometry on the Luminex®100.

24

The 50 bead master mix was also run with its complementary molecular recognition sequences and tagging sequences, however the tagging sequences were at 500 fmol per well.

The resulting data is reported as Median Fluorescence Intensity (MFI) per bead for both sets. FIG. 12 shows the 3D surface map graphical results of the data collected in the 98 bead master mix experiment. The Y axis represents the molecular recognition sequence and the X axis represents the tagging sequence. FIG. 13 shows the 3D surface map graphical results of the data collected in the 50 bead master mix experiment.

TABLE 1

50 Bead Molecular recognition sequences (Y = iso-G and X = iso-C)		
Bead No.	Molecular recognition sequence	Seq Id No.
1	GAXGTXGTGTC	1
2	CXGTTXTTCC	2
3	GGXTTGXTAG	3
4	C1TXGXTCTC	4
5	CXTCAXGAAC	5
6	GTAGXTAXGC	6
7	GGAXGXTAAC	7
8	CXGTATXGTG	8
9	CATXGGTAXG	9
10	GATTXTCGXC	10
11	GTTXAXGACC	11
12	CXGAAXGATC	12
13	CAAXTACGXC	13
14	CGGXATAXAC	14
15	GXAAAXXAGG	15
16	GTCXTAGXXC	16
17	GXCCTXTAXC	17
18	CCXACXTGAG	18
19	CTXXCAXAGG	19
20	GTXGAXATGC	20
21	GAAAXTGXXG	21
22	GCTGXAXATC	22
23	CGCAXATXAC	23
24	CTGGXTCXAG	24
25	GGAAXAXXCC	25
26	CXTCGCXTAC	26
27	GXCXAAAAXG	27
28	CXXGACXATC	28
29	CCATXAGXCC	29
30	GGCAXXTTGG	30
31	CTXAACXGGG	31

25

TABLE 1-continued

50 Bead Molecular recognition sequences (Y = iso-G and X = iso-C)		
Bead No.	Molecular recognition sequence	Seq Id No:
32	GGAXACGXG	32
33	GCGXTTAXG	33
34	GAGXAGTXC	34
35	GXCTAAXCCG	35
36	GCXTGTXCAC	36
37	GXCAGAXTCG	37
38	CGTXCTAGXG	38
39	CGXXTAGTXG	39
40	CXAGGXAACC	40
41	CXAGAXGAXG	41
42	CGXTGXGTC	42
43	CAGXCGTXAG	43
44	GGCTXTGXAC	44
45	CCAGXGXAAG	45
46	GGCXAATXGC	46
47	GXCTGCXGG	47
48	GAXCTXCGGC	48
49	GTXCGAXGGG	49
50	GGXXATCCXG	50

TABLE 2

98 Bead Molecular recognition sequences (Y = iso-G and X = iso-C)		
Bead No.	Molecular recognition sequence	Seq Id No:
1	GAXGTXTGTC	1
2	CXGTXTTCC	2
3	GGXTTGXTAG	3
4	CTTXGXTCTC	4
5	CXTCAXGAAC	5
6	GXCTTCXATG	51
7	GTAGXTAXGC	6
8	GGAXGXTAAC	7
9	CXGTATXGTG	8
10	CATXGGTAXG	9
11	GATTXTCGXC	10
12	GTTXAXGACC	11
13	CXTCTTXXCC	52
14	CXGAAXGATC	12
15	CAAXTACGXC	13
16	CTCTXAXCCC	53
17	CTCXTGGTXC	54
18	CGGXATAAXC	14
19	GXAAAXXAGG	15
20	GTCXTAGXXC	16
21	GXCCTXTAXC	17

26

TABLE 2-continued

98 Bead Molecular recognition sequences (Y = iso-G and X = iso-C)		
Bead No.	Molecular recognition sequence	Seq Id No:
22	CCXACXTGAG	18
23	CTXXCAXAGG	19
24	GXCAAAXCAC	55
25	GTXGAXATGC	20
26	GTTXGCXTTG	56
27	GAAAXTGXXG	21
28	GCTGXAXATC	22
29	CXCXTXCAAC	57
30	CTXXACAXXC	58
31	CXACTCXACC	59
32	GACXCAXXTG	60
33	CGCAXATXAC	23
34	CTCXCTXACG	61
35	CTGGXTCXAG	24
36	GGAAXAXXCC	25
37	GTGGXCTXTC	62
38	CXTCGCXTAC	26
39	CAXXACCXAG	63
40	GXCXAAAAXG	27
41	GTXCXAXACC	64
42	CXXGACXATC	28
43	CCATXAGXCC	29
44	CACXXTGXTC	65
45	GGCAXTGTGG	30
46	CTXAACXGGG	31
47	GXTCCTXGTC	66
48	GGAXACGXG	32
49	GCGXTTAXG	33
50	CCXXATGTXG	67
51	GAGXAGTXC	34
52	GXCTAAXCCG	35
53	GCXTGTXCAC	36
54	GXCAGAXTCG	37
55	CGTXCTAGXG	38
56	CGXXTAGTXG	39
57	CXAGGXAACC	40
58	GXGGTTXXTC	68
59	CXAGAXGAXG	41
60	CGXTGXGTC	42
61	CAGXCGTXAG	43
62	GGCTXTGXAC	44
63	CXCCGXAATC	69
64	GXXACXACAC	70

TABLE 2-continued

98 Bead Molecular recognition sequences (Y = iso-G and X = iso-C)		
Bead No.	Molecular recognition sequence	Seq Id No:
65	GCXCXGTXC	71
66	GXCXGGAXC	72
67	CGAXAGCAXC	73
68	CCCAXTCCXC	74
69	GTXCXCXCAG	75
70	CXCCTAXCGG	76
71	GXGTTGXCG	77
72	CXAAGXAXCG	78
73	GGAGXCXXTC	79
74	CXGXAXGTAC	80
75	GXACGAXTXG	81
76	GXGCTXCATG	82
77	GTGXAGAGXG	83
78	GCCGXCXTC	84
79	CAAXCGXTCCG	85
80	CACAXACXGC	86
81	CCAGXGXAAG	45
82	GGCXAATXGC	46
83	GXCTGCXGG	47
84	GXTGGXXCG	87
85	GCCXCCXGT	88
86	CXAXGGTCXC	89
87	CCXXGXGTG	90
88	GGXACXCCAG	91
89	GAXCTXCGGC	48
90	GCCTXCXGAC	92
91	GTXCXGAXGG	49
92	CXTTXCGCXC	93
93	GGXXATCCXG	50
94	CXCTAXGXXG	94
95	CXGCXAGXG	95
96	CXAGCXACGG	96
97	GACAXGCXCC	97
98	GGGXCGXXA	98

Example 2

Preliminary Determination of Non-standard Base Contributions to the Nearest-Neighbor Parameters for Predicting Nucleic Acid Duplex Stability

5

A Beckman DU-7500 spectrometer with temperature controller and sample carriage was utilized. Six samples can simultaneously be measured with precise temperature control. In order to cover a one hundred fold range of sample concentrations, quartz cuvettes of pathlengths 0.1 cm, 0.2 cm, 0.5 cm and 1.0 cm, were obtained from Hellma, USA. DNA were synthesized on a Model 392 DNA synthesizer from Perkin-Elmer/ABI. TLC Chromatography Tank (Fisher), and TLC plates (Si250F, JTBaker). A Savant SpeedVac was used for DNA prep, as are Sep-pak C-18 purification cartridges (Waters), UV lamp, a vortex, 10 cc syringes, and various pipetters (2, 20, 200, 1000 μ L)

Oligonucleotides were synthesized from natural (A, G, C, and T) nucleotides (Perkin-Elmer/ABI) and isoC, and isoG (EraGen Biosciences, Inc., Madison, Wis.). The synthesized self-complementary and non-self-complementary sequences are in tables 3 and 4.

25

TABLE 3

Self-Complementary Sequences (isoC = X , isoG = Y)	
3A	GGA CGT CC Control
3B	GGA YXT CC Tandem isoC-isoG effect
3C	GXA YXT YC IsoC-isoG in penultimate position
3D	GGA GCT CC Control
3E	GGA XYT CC swapped tandem isoC-isoG effect

30

35

TABLE 4

Non-Self-Complementary Sequences (isoC = X , isoG = Y)	
4A	SEQ ID NO: 99 5' GCC AGT TTA A 3' control 3' CGG TCA AAT T 5'
4B	SEQ ID NO: 100 5' GCC AXT TTA A 3' Single isoC-isoG in AT, TA 3' CGG TYA AAT T 5' context
4C	SEQ ID NO: 101 5' GCX AGT TTA A 3' Single isoC-isoG in mixed 3' CGY TCA AAT T 5' GC and AT context
4D	SEQ ID NO: 102 5' GYC AGT TTA A 3' Single isoC-isoG in mixed 3' CXG TCA AAT T 5' GC and CG context
4E	SEQ ID NO: 103 5' GYY AGT TTA A 3' Final tandem isoC-isoG 3' CXX TCA AAT T 5' substitution

The following reagents were used in the purification of the oligonucleotides and melting experiments: TLC purification was performed by eluting for 5-6 hrs with n-propanol/ammonia/water (55:35:10 by volume) (Chou, S.-H., Flynn, P., and Reid, B. (1989) *Biochemistry* 28, 2422-2435, incorporated herein by reference). Hybridization experiments were carried out in degassed 1xSL Buffer (1.0M NaCl (Fisher), 10 mM sodium cacodylate (Fisher), 0.5 mM Na₂EDTA (Fisher), pH 7) (SantaLucia, J., Allawi, H., and Seneviratne, P. A., (1996) *Biochemistry* 35, 3555-3562, incorporated herein by reference).

60

65

29

Determination of thermodynamic parameters were obtained from melting curve data using Meltwin™ v3.0 as described in Petersheim, M., and Turner, D. H. (1983) *Biochemistry* 22, 253-263, incorporated herein by reference.

After synthesis the oligonucleotides were deprotected in ammonia at 50° C. overnight, lyophilized and purified by TLC by dissolving each sample in 175 μL ddH₂O and eluting for 5-6 hours. The most intense, least mobile band was visualized, scraped from the plate, and eluted three times with 3 mL ddH₂O. The oligonucleotides were further desalted and purified with the Sep-pak™ columns by eluting with 30% acetonitrile, 10 mM ammonium bicarbonate, pH 7 (Santa Lucia, J., Allawi, H., and Seneviratne, P. A., (1996) *Biochemistry* 35, 3555-3562), and finally dried in the SpeedVac™.

Self-complementary oligonucleotides were quantified and 2.0 OD₂₆₀ of each was collected and re-dried in the SpeedVac™. Oligonucleotides were then diluted in series to provide a one hundred fold dilution series in 1×SL Buffer. Absorbance vs. temperature profiles were measured with the Beckman DU-7500 spectrophotometer utilizing the various custom micro-cuvettes, sample carriage and temperature controller. See tables 5 and 6 for sample dilution series. The dilution series were prepared for each of the samples of Tables 3 and 4.

TABLE 5

Series A			
Sample	volume (μL)	Add(μL)	Place into cuvette(μL)
A1	0.0	94.5	34.5
A2	57.5	40.2	34.5
A3	63.2	44.3	34.5
A4	73.0	51.2	69.0
A5	55.2	38.5	69.0

After running samples A1-A5 the dilutions for the second series were assembled. For Series B, the remaining 24.7 μL

30

from the last sample was combined with the dilutions in cuvettes A-3, A-4 and A-5 (~172.5 μL total) and an additional 345 μL of 1×SL Buffer.

TABLE 6

Series B			
Sample	volume (μL)	Add(μL)	Place into cuvette(μL)
B1	542.2	0.0	172.5
B2	369.8	230.0	172.5
B3	427.2	270.0	345.0
B4	352.5	224.0	345.0
B5	231.5	132.2	345.0

The volumes placed in the cuvettes leaving approximately 4% head space in each cuvette for thermoexpansion of the samples during the melts.

For each run the samples were further degassed and then annealed by raising the temperature to 85° C. for five minutes, and then cooled to 10° C. over five more minutes. To limit condensation, a blanket of dry argon was utilized at low temperatures. For series A and B, measurements were taken at 260 nm and 280 nm, simultaneously. Samples were heated at a constant rate from 10° C. to 90° C. at 1.0° C./min.

The data collected from the melting experiment were then analyzed with the Meltwin™ software by curve fit analysis of T_m^{-1} vs $\ln(C_T)$, where C_T is the total strand concentration and T_m^{-1} is the reciprocal melting temperature (Borer, P. N., Dengler, B., Tinoco, I., Jr., and Uhlenbeck, O. C. (1974) *J. Mol. Biol.* 86, 843-853, incorporated herein by reference).

Non-self-complementary oligonucleotides were combined in equal molar amounts to 2.0 OD₂₆₀ (optical density at 260 nm) and diluted in the same manner as the self-complementary oligonucleotides dilution series in Tables 5 and 6. Similar melt data was collected and analyzed with Meltwin™ for the non-self-complementary oligonucleotides.

The resulting thermodynamic parameters determined by Meltwin™ for the self-complementary and non-self-complementary oligonucleotides are summarized in Tables 7 and 8.

TABLE 7

Self-Complementary Sequences Thermodynamic Data (isoC = X, isoG = Y)					
		$-\Delta G_{37}$ (kcal/mol)	$-\Delta H$ (kcal/mol)	$-\Delta S$ (cal/K•mol)	T_M (° C.) 1.0e-4M
1A	GGA CGT CC	8.27	53.5	145.9	52.8
1B	GGA YXT CC	9.41	57.62	155.4	58.5
1C	GXA CGT YC	10.89	66.27	178.6	63.5
1D	GGA GCT CC	8.10	51.04	138.5	52.4
1E	GGA XYT CC	9.70	57.77	155.0	60.2

55

TABLE 8

Non-Self-Complementary Sequences Thermodynamic Data (isoC = X, isoG = Y)							
			$-\Delta G_{37}$ (kcal/mol)	$-\Delta H$ (kcal/mol)	$-\Delta S$ (cal/K•mol)	T_M (° C.) 1.0e-4M	
4A	SEQ ID	5' GCC AGT TTA A 3'	8.43	69.22	196.0	45.8	
	NO: 99	3' CGG TCA AAT T 5'					

TABLE 8-continued

		Non-Self-Complementary Sequences Thermodynamic Data (isoC = X, isoG = Y)			
		$-\Delta G_{37}$ (kcal/mol)	$-\Delta H$ (kcal/mol)	$-\Delta S$ (cal/K•mol)	T_M (° C.) 1.0e-4M
4B	SEQ ID NO: 100	9.56	56.66	151.9	54.5
	5' GCC AXT TTA A 3' 3' CGG TYA AAT T 5'				
4C	SEQ ID NO: 101	9.36	62.98	172.9	51.6
	5' GCY AGT TTA A 3' 3' CGX TCA AAT T 5'				
4D	SEQ ID NO: 102	9.62	54.30	144.1	55.7
	5' GYC AGT TTA A 3' 3' CXG TCA AAT T 5'				
4E	SEQ ID NO: 103	10.59	70.19	192.2	56.0
	5' GYY AGT TTA A 3' 3' CXX TCA AAT T 5'				

All samples have concentration dependant T_M s and monophasic melting transitions. IsoC and isoG contributions to duplex formation appear to be substantial, adding up to an additional 5° C. (Sample 3B and 4C) per isoC/isoG pair to 10° C. (Sample 3C and 4E) compared to natural (A, G, C, and T) Watson-Crick oligonucleotides.

Tables 7 and 8 show some the extent of the nearest-neighbor effects that are occurring when AEGIS bases are mixed with natural DNA.

Example 3 and Comparative Example

Site Gated Incorporation

First primer

(SEQ ID NO: 154)

5'AGAACCCTTTCTCTTCC

Target

(SEQ ID NO: 155)

5'AAGAACCCTTTCTCTTCCGATGCAGGATACTTAACAATAAATATTT

Second Primer

(SEQ ID NO: 156)

CTACGTCCTATGAATTGTTATTTATAAAXAGGACAGACG 5'

X=isoCTP

The sequences of the first primer, target, and second primer are shown in SEQ ID NO:154, SEQ ID NO:155, and SEQ ID NO:156, respectively.

PCR was performed using the following mixture: 0.2 μ M first primer, 0.2 μ M second primer, 50 fM target, 50 μ M each dGTP, dATP, dTTP and dCTP, 10 mM Tris pH 8, 0.1% BSA, 0.1% Triton X-100, 0.1 μ g/ μ l degraded herring sperm DNA, 40 mM KAc, 2 mM MgCl₂, 1 U Amplitaq Stoffel (Perkin Elmer Biosciences, Foster City, Calif.) in a 20 μ l reaction volume. The mixture was held for 2 minutes at 95° C. Then was cycled 30 times between 95° C. with a 1 second hold and 58° C. with a 10 second hold. Finally, the mixture was held for 2 minutes at 58° C.

Two PCR reaction mixtures were prepared. Each PCR reaction mixture was desalted using an AutoSeg™ G-50 microspin column (Amersham Pharmacia Biotech Inc., Piscataway, N.J.) to remove unincorporated dNTP's, the column buffer had been exchanged for ddH₂O prior to desalting the sample. The desalted samples were adjusted to these final concentrations for the following reaction components: 10 mM Tris pH 8, 0.1% BSA, 0.1% Triton X-100, 0.1 μ g/ μ l degraded herring sperm DNA, 40 mM KAc, 2 mM MgCl₂, 1

U/reaction Amplitaq Stoffel (Perkin Elmer Biosciences, Foster City, Calif.), and 10 μ M Cy3-dTTP (NEN Life Science Products, Inc., Boston, Mass.) in a 25 μ l reaction volume. In addition, disoGTP was added in the following concentrations: 0 μ M (Comparative Example) or 40 μ M (Example 3).

The reaction mixtures were incubated at 68° C. for 15 minutes, and 5 μ l of the resulting reactions were examined by electrophoresis on a 10% denaturing polyacrylamide gel. The gel was imaged for Cy3 containing extension products using a 595 Fluorimager (Molecular Dynamics, Sunnyvale, Calif.).

The results (data not shown) indicated that there was no additional extension of the first primer during the final PCR step when disoGTP was not present (i.e., there was little or no misincorporation of bases opposite the iso-C of the second primer).

Example 4

Synthesis of Labeled deoxyisoGuanosine 5'-Triphosphates

For the following chemical reactions, tributylammonium pyrophosphate was purchased from Sigma; biotin N-hydroxysuccinimide ester, was purchased from Pierce Chemical Company; all other chemicals were purchased from Aldrich Chemical Co. or Fisher Chemical Co. and were used without further purification. Solvents were dried over 4 Å molecular sieves. Reactions were carried out under dry argon in oven-dry glassware. Column chromatography was performed with silica gel (230-425 mesh).

Abbreviations:

Ac₂O Acetic anhydride
DMF N,N-Dimethylformamide
DMAP 4,4'-Dimethylaminopyridine
DMT 4,4'-Dimethoxytrityl
Et₃N Triethylamine
MeCN Acetonitrile
MeOH Methyl alcohol
Tol p-Tolyl

1-(p,p'-Dimethoxytrityl)-hexamethylenediamine (2)

Hexamethylenediamine (10 eq., 375 mmol, 43.5 g) was coevaporated two times from pyridine and dissolved in 100 ml pyridine. DMAP (0.1 eq., 3.75 mmol, 457 mg) was added and the reaction flask placed in an ice bath. DMT-chloride (1 eq., 37.5 mmol, 12.69 g), dissolved in 100 ml pyridine, was added dropwise over 2 h. It was stirred at room temperature

33

for 4 h, MeOH (5 ml) added, the reaction mixture concentrated and the remaining residue extracted with aqueous NaHCO₃/ethyl acetate. The organic layer was washed twice with aqueous NaHCO₃ solution, dried and the solvent evaporated. The obtained product was used in next step without further purification.

Yield: 14.895 g (35.634 mmol, 95%) sticky oil.

2-Chloro-6-(6-p,p'-dimethoxytritylaminoethyl)-aminopurine-2'-deoxy-3',5'-ditoluoylriboside (3)

Compound 2 (1.3 equiv., 31.916 mmol, 13.34 g) was coevaporated with DMF and dissolved in 100 ml DMF. Diisopropylethylamine (3.9 equiv., 95.748 mmol, 16.65 ml) and compound 1 (1 equiv., 24.551 mmol, 13.282 g), dissolved in 100 ml DMF, were added and it was stirred at room temperature for 3 h. It was concentrated, the residue extracted with aqueous NaHCO₃/ethyl acetate, the organic layer dried and the solvent evaporated. The residue was triturated with ether twice and the obtained solid product used further after drying in vacuum without further purification.

2-Benzyloxy-6-(6-p,p'-dimethoxytritylaminoethyl)-aminopurine-2'-deoxyriboside (4)

Compound 3 (1 equiv., 19.23 mmol, 17.74 g) was dissolved in DMF (25 ml) and added to a solution of NaH (10 eq., 192.3 mmol, 7.69 g of a 60% dispersion in mineral oil) in benzylalcohol (128 mL). The reaction mixture was heated (120° C., 6 h) and then stirred at room temperature (15 h) before filtrated over Celite, the filtrate evaporated, the residue extracted (ethyl acetate/water), the organic layer washed (NaHCO₃-solution), dried, the solvent evaporated and the residue triturated 5 times with ether/hexane 1:10. TLC: CHCl₃/10% MeOH R_F=0.26.

Yield: 10.280 g (13.562 mmol, 70.5% for 2 steps) foam.

2-Benzyloxy-6-(6-p,p'-dimethoxytritylaminoethyl)-aminopurine-2'-deoxy-5'-O-p,p'-dimethoxytritylriboside (5)

Compound 4 (14.7388 mmol, 11.172 g) was coevaporated with pyridine, dissolved in 150 ml pyridine and DMAP (0.25 equiv., 3.6847 mmol, 450 mg) added. The flask was placed in an ice bath and DMTCl (1.5 equiv., 22.108 mmol, 7.484 g) was added slowly over 2 h. It was stirred at room temperature for 22 h, then MeOH (1 ml) added, the reaction mixture concentrated and the residue extracted (chloroform/aqueous NaHCO₃). The organic layer was dried, the solvent evaporated and the residue triturated with ether/hexane 1:1 to remove the excess DMT and the insoluble solid product was dried and used further without additional purification.

Yield: 14.890 g (14.047 mmol, 95%) light brown foam.

2-Benzyloxy-6-(6-p,p'-dimethoxytritylaminoethyl)-aminopurine-3'-O-acetyl-2'-deoxy-5'-O-p,p'-dimethoxytritylriboside (6)

Compound 5 (14.047 mmol, 14.89 g) was coevaporated with pyridine, dissolved in 200 ml pyridine and DMAP (0.25 equiv., 3.5117 mmol, 428 mg), Et₃N (5 equiv., 70.235 mmol, 9.7 ml) and Ac₂O (2.5 equiv., 35.1175 mmol, 3.582 g) were added. It was stirred at room temperature for 4.5 h, then MeOH (2 ml) added, the reaction mixture concentrated and the residue extracted (ethyl acetate/aqueous NaHCO₃). The organic layer was dried, the solvent evaporated and the residue purified by column chromatography using an one step

34

gradient of ethyl acetate/hexane/Et₃N 30:60:1, then 65:35:3. Yield: 5.93 g (5.385 mmol, 38%), yellow foam.

2-Benzyloxy-6-(6-aminohexyl)-aminopurine-3'-O-acetyl-2'-deoxyriboside (7)

Compound 6 (2.471 mmol, 2.723 g) was dissolved in 50 ml acetonitrile/2 ml water and Ce(NH₄)₂(NO₃)₃ (0.3 equiv., 0.74 mmol, 406 mg) was added. It was refluxed for 45 min., then another 0.15 equiv. Ce(NH₄)₂(NO₃)₃ (0.37 mmol, 205 mg) added and refluxing continued for 1 h. Then, it was evaporated, the residue triturated with ether to remove the DMT, the insoluble product dried and used further without additional purification.

2-Benzyloxy-6-(6-trifluoroacetamidoethyl)-aminopurine-3'-O-acetyl-2'-deoxyriboside (8)

The above obtained compound 7 (max. 5.385 mmol) was dissolved in 30 ml MeOH/50 ml ethyl trifluoroacetate/5 ml Et₃N and the reaction mixture stirred at room temperature for 21.5 h. TLC (chloroform/17.5 MeOH): R_F=0.72) indicated complete conversion. It was evaporated, the residue extracted (brine/ethyl acetate), the organic layer dried, the solvent evaporated and the residue purified by silica gel column chromatography using a one step gradient of chloroform/1.5% MeOH, then 17.5% MeOH. Yield: 2.80 g (4.714 mmol, 87%) foam.

2-Benzyloxy-6-(6-trifluoroacetamidoethyl)-aminopurine-3'-O-acetyl-5'-triphosphoryl-2'-deoxyriboside (9)

Imidazole (61 eq., 306 mg, 4.5 mmol, recrystallised) was dissolved in acetonitrile (3.6 mL) and chilled (0° C.). POCl₃ (19 eq., 0.128 mL) and triethylamine (61 eq., 0.633 mL) were then added and the mixture was stirred (0° C., 0.5 h) before adding a portion (0.309 mL) to 8 (1 eq., 0.074 mmol, 44 mg). This mixture was stirred (r.t., 0.5 h) before adding DMF (1.5 mL) containing tributylammonium pyrophosphate (2 eq., 0.16 mmol, 73 mg). The reaction was then quenched (2 mL, 10% NH₄COO) 24 h later and lyophilized. Product was purified by anion-exchange chromatography (Dionex ProPac SAX-10) using 20% MeCN and a gradient of (NH₄)₂CO₃/20% MeCN. Collected product was repetitively lyophilized to remove excess salt. Yield 0.007 mmol (10%), white solid.

6-(6-aminohexyl)-aminopurine-5'-triphosphoryl-2'-deoxyriboside (10)

Compound 9 (0.007 mmol) was dissolved in methanol (2.5 mL) before adding Pd/C (10%, 5 mg) and NH₄COO (0.05 mmol, 31 mg). The suspension was refluxed (1 h) before filtering off the catalyst and evaporating the solvent. The residue was then treated with 28% ammonium hydroxide (1.5 mL, 3 h, room temp.) before the reaction was dried and the product purified by anion-exchange chromatography (Dionex ProPac SAX-10) using 20% MeCN and a gradient of (NH₄)₂CO₃/20% MeCN. Collected product was repetitively lyophilized to remove excess salt. Yield 0.0063 mmol (90%), white solid.

6-(6-biotinylamidoethyl)-aminopurine-5'-triphosphoryl-2'-deoxyriboside (11)

To 10 (0.88 μmol, triethylammonium salt) in H₂O (40 μL) was added sodium borate (10.5 μL, 1M, pH 8.5) followed by

35

DMF (216 μ L) containing biotin N-hydroxysuccinimide ester (2.6 μ mol, 3 eq.). The reaction proceeded (3 h, 55° C.) before it was diluted with 20% MeCN and the product puri-

36

fied by anion-exchange chromatography (Dionex ProPac SAX-10) using H₂O and a gradient of an NH₄HCO₃ solution. Yields approximately 70%.

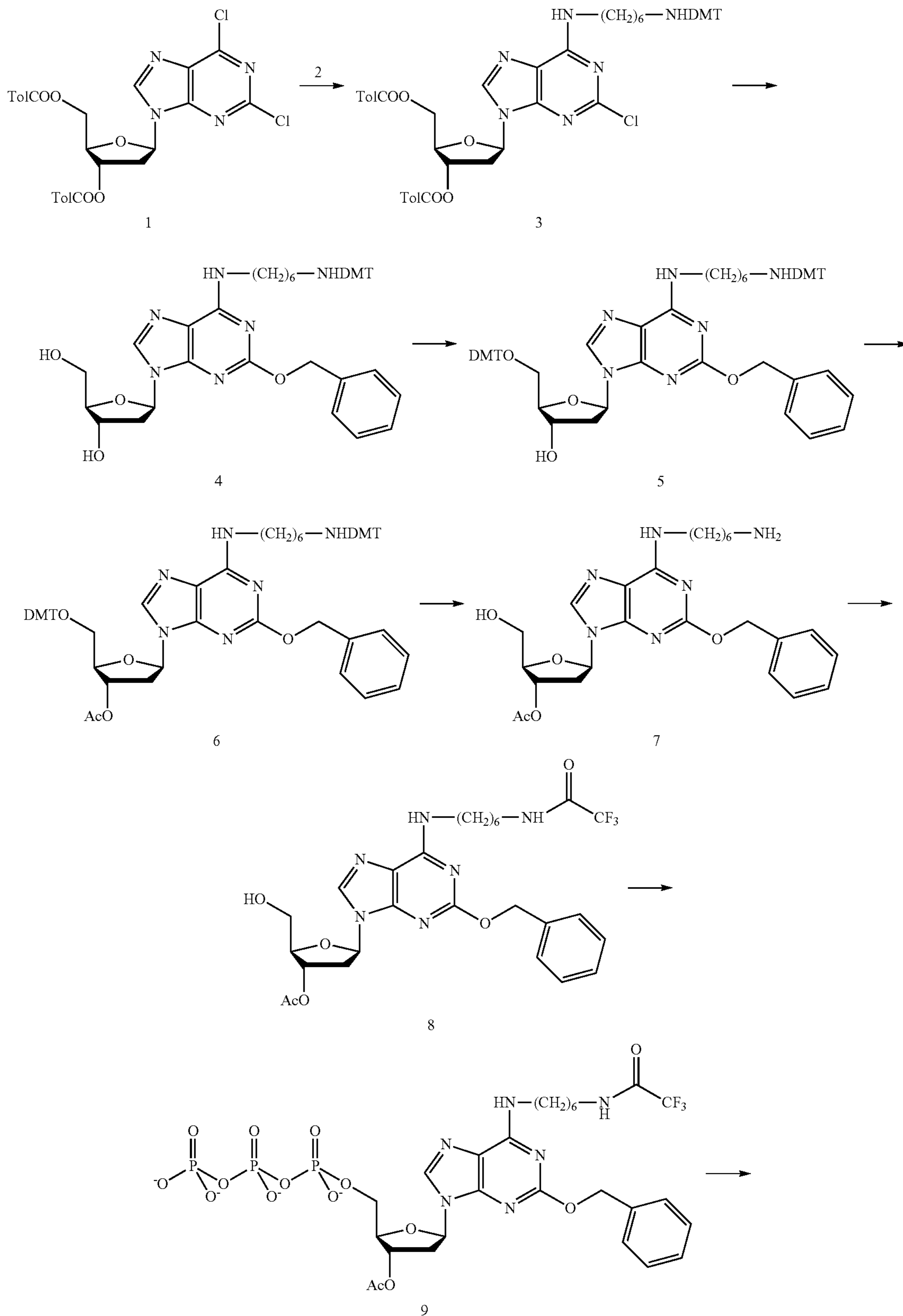

37

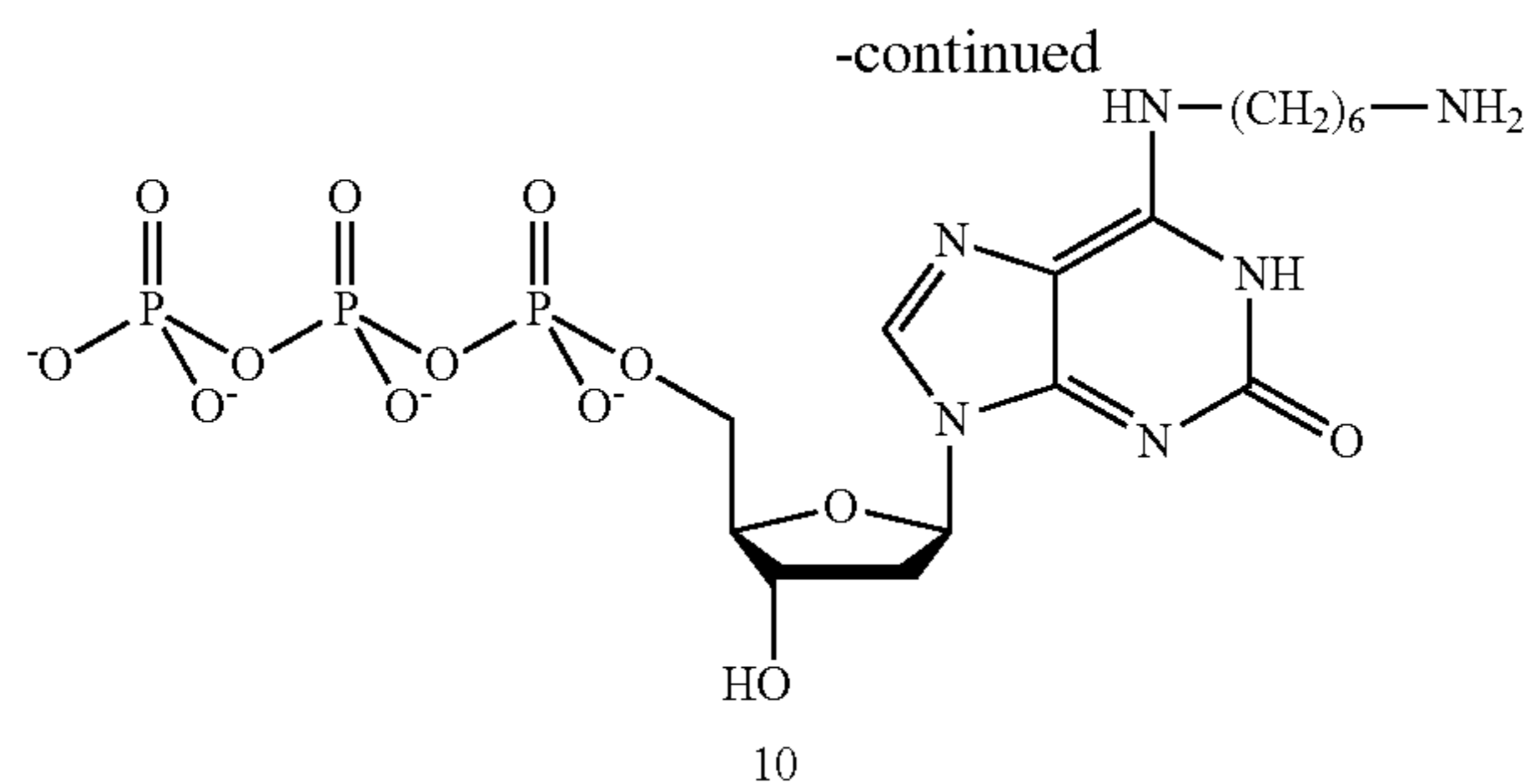

38

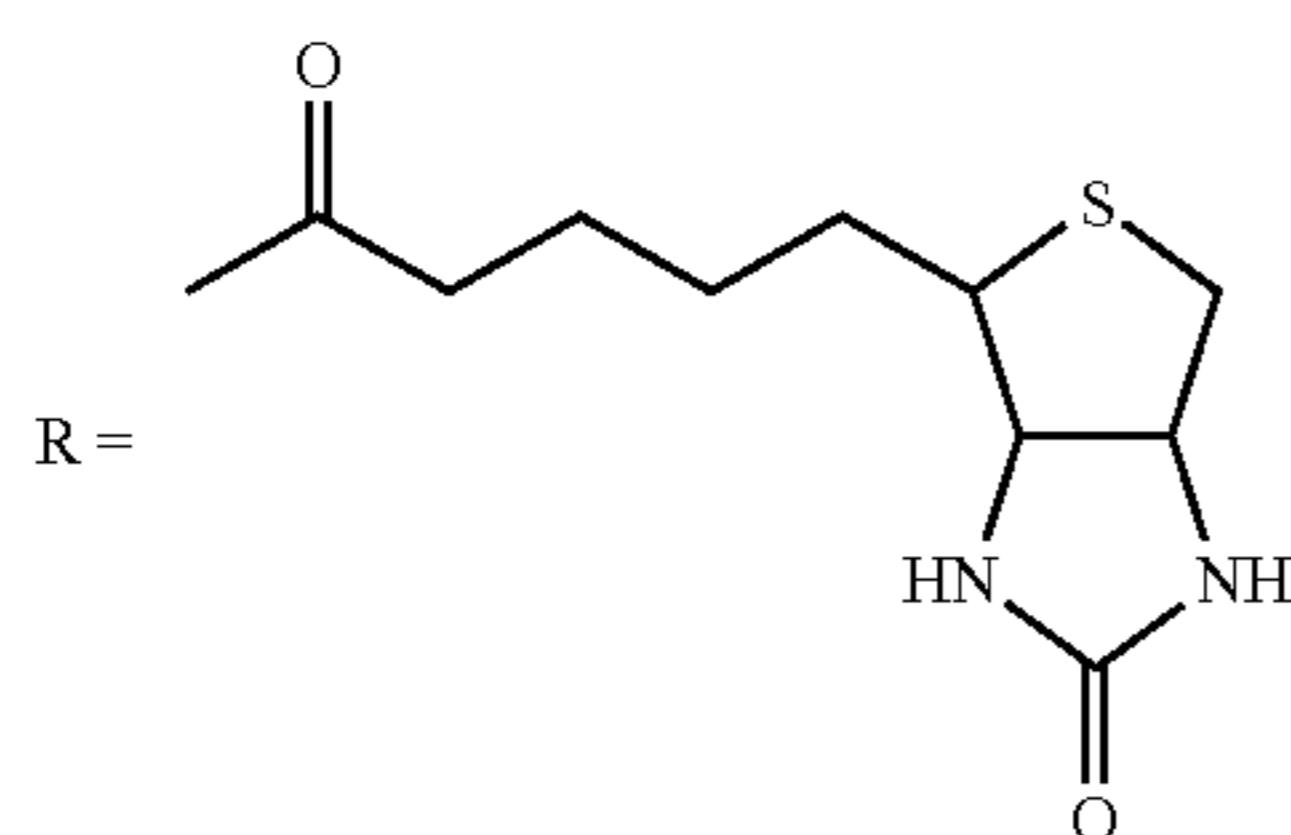
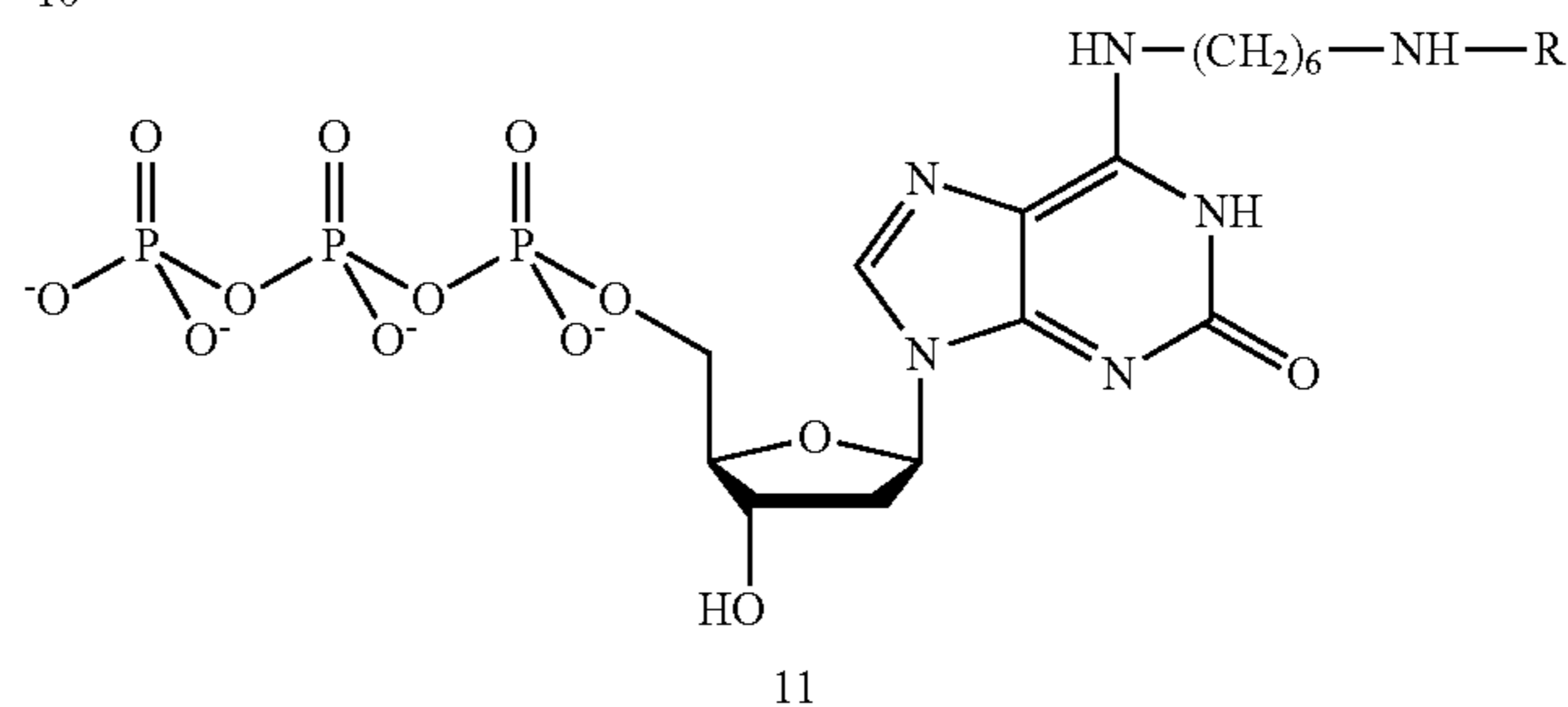

Example 5

Multiplexed Genotyping of Genomic DNA Using
Incorporation of a Labeled Base and Capture on
Solid Support Microspheres

The genotypes of nine polymorphic loci were determined following the amplification, query, and capture of targeted nucleic acid sequences from genomic DNA samples. The first step, a multiplex PCR reaction, included a multiplexed set of paired PCR primers. Each pair of PCR primers included a first primer A and a second primer B that were designed to hybridize to and to amplify a region of mouse genomic DNA that encompasses a known polymorphic site. The second step, a multiplex allele-specific primer extension (ASPE) reaction, included a multiplexed set of tagged allele-specific primers. Each tagged allele-specific primer included a 5' tagging sequence containing non-standard nucleotides (iso-G), followed by a c3 (n-propylene) spacer, followed by a 3' sequence designed to hybridize to one of the DNA strands amplified in the previous multiplex PCR step. The allele specificity was determined by the 3' nucleotide of each tagged allele-specific

primer. The multiplexed set of tagged allele-specific primers was designed to query the set of known polymorphic sites embedded in the set of multiplex PCR amplified sequences. A labeled triphosphate (dATP-Biotin) was added to the ASPE reaction, so that allele-specific extension of a tagged allele-specific primer led to the incorporation of dATP-Biotin. Unincorporated dATP-Biotin was removed prior to the subsequent capture step.

The third step, capture of the multiplex ASPE reaction products, used capture sequences containing non-standard nucleotides (iso-C) that were each covalently coupled to unique Luminex™ microsphere identities. The capture sequences were complementary to the tagging sequences used in the set of tagged allele-specific primers in the preceding ASPE reaction. Phycoerythrin was added to bind to the Biotin label on the extended tagged allele-specific primer strands and provide a fluorescent signal. Following hybridization between the capture sequences and the tagging sequences, the microspheres were injected into a Luminex100™ instrument to detect signal associated with each unique microsphere identity.

Nine polymorphic regions of the mouse genome were targeted in this example:

Target SEQ ID NO:	Sequence	A/J	C57BL6/J
2	104 AGAAACAACCATCTAATCCCACACTAAAAT TCAAGGCTCCACAGACGAAACAGTGAAGA TAATTGTTTCAGCATACTAACCAACTGATTA CATATTTACCATACTCAGGTTTGTGCTTCA TACAAACCCAC/TAGTCCGGCGCTCCCTGTT GATG	CC	TT

-continued

Target SEQ ID NO	Sequence	A/J	C57BL6/J
3	105 CTTCTCCATTGCCAGGGCACTCTCCTCT GTAGAA/GTAGACTGATC/TTTTGTGGAGACATC A	GG	AA
4	106 AGTGCCTGCTACCTGTGAGGTGAAAATTTT TTAGTGATCCC/TAAGCTCAATGGGTGCGGGC TTGCAGG	CC	TT
5	107 GGTTGGAATGTTTGCACATGCAGTGTAGT TATTTGGGC/TGATACTACTTAGCTTATCT GCCTGGTCCAGC	TT	CC
6	108 CTGATCTGACCTCAGACTGTTGTGCTAACA GATATAACACCAGTAAGTTGAC/GTCAAAT TGCAGGAAGTAGAGCCTTGC	GG	CC
7	109 GACTGCTGGAGAGCTGAGGGAGGCTGTGGA GAATAAGGAGAGAGCA/GTAGTCTCGTGCCCT GCCCTGCCCATACTGAGCAGCCAAGACAC	GG	AA
8	110 GGACTGTCCAAKGGATCTCAAGGAGAAT GTCCTTGCTATTAA/GGAGTATAAAGGCATAA AAGAGGTCATAGGGACAACCATGACCAAG AAGTTG	AA	GG
9	111 CCTTCCTGCAYTCCACAGTATAAACACAGA ATGCACACTGCA/GGTCGTTGTATTTGTGTTC GATGTGAATTAAGATGCTTTGGCTAAGCC AGGAGATGATAAATACTG	AA	GG
10	112 CACATACACCATGTCAGCCATCAGCGCAA GCCTTCGAGTTTCAGCTGTGAGATGAAGGC TTGGAGAAGCACGTGATCTGCAAAGAAG AAAGGAGCTAGCGGAGGCC/TGGTCACTGACC GACTGCTCA	CC	TT

The following nucleic acids were used in the multiplex PCR step for this example:

Nucleic acid component	Sequence	SEQ ID NO
PCR Primer 1A	5' - CATCTAACAGGGAGCGCC - 3'	113
PCR Primer 1B	5' - 6FAM-AGAAACAACCATCTAATCCCACA - 3'	114
PCR Primer 2A	5' - 6FAM-CTTCTCCATTGCCAGG - 3'	115
PCR Primer 2B	5' - TGATGTCTCCACAAAGATCAGTC - 3'	116
PCR Primer 3A	5' - AGTGCCTGCTACCTGTGAG - 3'	117
PCR Primer 3B	5' - 6FAM-CCTGCAAGCCAGCACC - 3'	118
PCR Primer 4A	5' - 6FAM-GGTTGGAATGTTTGCACATGC - 3'	119
PCR Primer 4B	5' - GCTGGACCAGGCTAGATAAGC - 3'	120
PCR Primer 5A	5' - 6FAM-CTGATCTGACCTCAGACTGTTG - 3'	121
PCR Primer 5B	5' - GCAAGGCTCTACTTCCTGC - 3'	122
PCR Primer 6A	5' - 6FAM-GACTGCTGGAGAGCTGAGG - 3'	123
PCR Primer 6B	5' - GTGTCTTGGCTGCTCAGTATG - 3'	124
PCR Primer 7A	5' - 6FAM-GGACTGTCCAAAGGGATCTC - 3'	125
PCR Primer 7B	5' - CAACTTCTTGGTCATGGTTGTC - 3'	126
PCR Primer 8A	5' - Cy3-CCTTCCTGCAYTCCACAG - 5'	127

-continued

Nucleic acid component	Sequence	SEQ ID NO
PCR Primer 8B	5'-6FAM-CAGTATTATCATCTCCTGGCTTAGC-3'	128
PCR Primer 9A	5'-6FAM-CACATACACCATGTGTCAGCC-3'	129
PCR Primer 9B	5'-TGAGCAGTCGGTCAGTG-3'	130
Template 1	Mouse genomic DNA; Strain: A/J	
Template 2	Mouse genomic DNA; Strain: C57BL6/J	

PCR primers were synthesized and diluted in 1 mM MOPS pH 7.5, 0.1 mM EDTA. The 6FAM or Cy3 fluor on some of the PCR primers is added to allow investigation of the multiplex PCR reaction on a polyacrylamide gel.

Mouse genomic DNA samples were purchased from the Jackson Laboratory (Bar Harbor, Me.). All genomic DNA samples were diluted to 5 ng/ μ L in 1 mM MOPS pH 7.5, 0.1 mM EDTA. PCR reaction components were:

Component	1X Concentration	Supplier and Location
10X PCR Buffer II	1.2 X	Applied Biosystems, Foster City, CA
MgCl ₂	2 mM	Sigma, St. Louis, MO
dATP	200 μ M	Amersham
dGTP	200 μ M	Amersham
dCTP	200 μ M	Amersham
dTTP	200 μ M	Amersham
Amplitaq™ Gold DNA Polymerase	0.1 U/ μ L	Applied Biosystems, Foster City, CA
PCR Primers (each)	0.1 μ M	

A Master Mix of all listed components was prepared at 1.09 \times concentration for 25 μ L final reaction volumes. 23 μ L

Master Mix was combined with 2 μ L of genomic DNA template (5 ng/ μ L) in individual PCR tubes. A negative control included water in place of genomic DNA template. PCR reactions were cycled as follows:

Cycle #	Step	Temp	Time
1	1	95° C.	9 minutes
2-41	1	95° C.	5 seconds
	2	55° C.	30 seconds
	3	62° C.	30 seconds
42	1	62° C.	5 minutes
43	1	4° C.	hold

Following PCR cycling, 2 μ L of each PCR reaction was transferred to act as template in the multiplex ASPE reaction. The following synthetic nucleic acids were used as tagged allele-specific (TAS) primers in the multiplex ASPE reaction:

Nucleic acid component	Sequence	SEQ ID NO
TAS Primer 1	5'-GTGYACAYGC-c3-GCTTCATACAAACCCAC-3'	131
TAS Primer 2	5'-CGAYTCTGYC-c3-GCTTCATACAAACCCAT-3'	132
TAS Primer 3	5'-CTAYCAAYCC-c3-CACTCTCCTCTGTAGAA-3'	133
TAS Primer 4	5'-GAGAYCYAAG-c3-CACTCTCCTCTGTAGAG-3'	134
TAS Primer 5	5'-GTTTCYTAYG-c3-GAAAATTTCTTAGTGATCCT-3'	135
TAS Primer 6	5'-GCYTAYCTAC-c3-AAAATTTCTTAGTGATCCC-3'	136
TAS Primer 7	5'-GTTAYCYTCC-c3-AGTGTAGTTATTTGGGT-3'	137
TAS Primer 8	5'-CACYATACYG-c3-GTGTAGTTATTTGGGC-3'	138
TAS Primer 9	5'-CYTACCYATG-c3-TAACACCAGTAAGTTGAC-3'	139
TAS Primer 10	5'-GYCGAYAATC-c3-TAACACCAGTAAGTTGAG-3'	140
TAS Primer 11	5'-GYCGTAYTTG-c3-AGAATAAGGAGAGAGCA-3'	141
TAS Primer 12	5'-GTYTATYCCG-c3-GAATAAGGAGAGAGCG-3'	142
TAS Primer 13	5'-GACAYACYTC-c3-AGAATAGTCCTTGCTATTAA-3'	143
TAS Primer 14	5'-GGAAYAACYG-c3-AGAATAGTCCTTGCTATTAG-3'	144
TAS Primer 15	5'-GATYTYCAGC-c3-AGAATGCACACTGCA-3'	145

-continued

Nucleic acid component	Sequence	SEQ ID NO
TAS Primer 16	5'-GTYATYTGCG-c3-GAATGCACACTGCG-3'	146
TAS Primer 17	5'-GATYGTCYYG-c3-GCTAGCGGAGGCC-3'	147
TAS Primer 18	5'-GGYCTYATGG-c3-GCTAGCGGAGGCT-3'	148

Components of the ASPE reaction were:

Component	1X Concentration	Supplier and Location
Bis-Tris-Propane pH 8.9	10 mM	Sigma, St. Louis, MO
Potassium Acetate	40 mM	Sigma, St. Louis, MO
MgCl ₂	2 mM	Sigma, St. Louis, MO
Biotin-11-dATP,	4 μM	NEN, Boston, MA
dGTP	200 μM	Amersham Pharmacia, Piscataway, NJ
dCTP	200 μM	Amersham Pharmacia, Piscataway, NJ
dTTP	200 μM	Amersham Pharmacia, Piscataway, NJ
Amplitaq™ Gold DNA Polymerase	0.067 U/μL	Applied Biosystems, Foster City, CA
TAS Primers (each)	0.067 μM	EraGen Biosciences, Inc., Madison, WI

A Master Mix containing all of the above components except TAS primers was prepared at 1.36x. Each ASPE reaction consisted of 11 μL Master Mix, 2 μL multiplex TAS primer mix (0.5 μM each), 2 μL PCR reaction (from previous step). ASPE reactions were cycled as follows:

Cycle #	Step	Temp	Time
1	1	95° C.	12 minutes
2-5	1	95° C.	3 seconds
	2	48° C.	15 seconds
	slow ramp	30 degrees per minute	
6	3	62° C.	30 seconds
	1	4° C.	hold

Following ASPE cycling, 10 μL of the reaction volume was combined with 5 μL of a solution containing 40 mM Tris, 40 mM EDTA to stop the activity of the polymerase. The reaction was purified over a G-50 column to remove unincorporated dATP-Biotin. The purified multiplex ASPE reaction was then deconvoluted by capture sequences coupled to Luminex™ microspheres (Luminex Corp, Houston, Tex.). The coupled microspheres were:

Microsphere Identity	SEQ ID NO:	Capture Sequence
1	2	CXGTTXTTCC
2	9	CATXGGTAXG
7	14	CGGXATAXAC
15	13	CAAXTACGXC

-continued

Microsphere Identity	SEQ ID NO:	Capture Sequence
17	22	GCTGXAXATC
18	23	CGCAXATXAC
19	1	GAXGTXTGTC
20	3	GGXTTGXTAG
21	4	CTTXGXTCTC
22	5	CXTCAXGAAC
34	7	GGAXGXTAAC
35	8	CXGTATXGTG
37	6	GTAGXTAXGC
38	10	GATTXTCGXC
45	28	CXXGACXATC
47	29	CCATXAGXCC
61	36	GCXTGTXCAC
62	37	GXCAGAXTCG

The coupled microspheres were combined in a mixture containing equal numbers of each microsphere identity in a storage buffer (10 mM MOPS pH 7.5, 200 mM NaCl, 1 mM EDTA, 1% PEG8000, 0.05% SDS). The components of the capture hybridization reaction were:

Component	1X Concentration	Supplier and Location
MOPS pH 7.5	10 mM	Fisher Chemical, Fair Lawn, NJ
NaCl	200 mM	Fisher Chemical, Fair Lawn, NJ
MgCl ₂	50 mM	Sigma, St. Louis, MO
EDTA	1 mM	Fisher Chemical, Fair Lawn, NJ
PEG8000	1%	Sigma, St. Louis, MO
SDS	0.05%	Fisher Chemical, Fair Lawn, NJ
Herring sperm DNA	0.1 mg/mL	Promega, Madison, WI
Microsphere mix	1000 each identity	EraGen Biosciences, Inc., Madison, WI

A Master Mix of all listed components was prepared at 1.2x concentration for 60 μL final reaction volume. 50 μL Master Mix was combined with 10 μL of the purified multiplex ASPE reaction and allowed to hybridize at room temperature for 10 minutes. 10 μL of a 0.01 mg/mL solution of Streptavidin Phycoerethrin (Molecular Probes, Eugene, Oreg.) in hybridization buffer (10 mM MOPS pH7.5, 200 mM NaCl, 50 mM MgCl₂, 1 mM EDTA, 1% PEG8000, 0.05% SDS) was added to each capture hybridization reaction prior to injection into a Luminex100™ instrument.

For each capture hybridization reaction, 55 μ L was injected into the Luminex100™ at a rate of 60 μ L/min and the read continued until 50 of each microsphere identity were counted. The median fluorescence intensity was used as a measurement of the fluorescent signal associated with each microsphere identity. The results are shown in FIG. 14.

Example 6

Multiplexed Genotyping of Genomic DNA Using Site-specific Incorporation of a Labeled Non-standard Base and Capture on Solid Support Microspheres

The genotypes of nine polymorphic loci were determined following the amplification, query, and capture of targeted nucleic acid sequences from genomic DNA samples. The first step, a multiplex PCR reaction, included a multiplexed set of paired PCR primers. Each pair of PCR primers included a first primer A and a second primer B, and the second primer B included a non-standard nucleotide (iso-C) near its 5' end. Each primer pair was designed to hybridize to and to amplify a region of mouse genomic DNA that encompasses a known polymorphic site. The next step, a multiplex allele-specific primer extension (ASPE) reaction, included a multiplexed set of tagged allele-specific primers. Each tagged allele-specific primer included a 5' tagging sequence containing non-standard nucleotides (iso-G), followed by a c3 (n-propylene) spacer, followed by a 3' sequence designed to hybridize to one

of the DNA strands amplified in the previous multiplex PCR step. The allele specificity was determined by the 3' nucleotide of each tagged allele-specific primer. The multiplexed set of tagged allele-specific primers was designed to query the set of known polymorphic sites embedded in the set of multiplex PCR amplified sequences. A labeled non-standard triphosphate (isoGTP-Biotin) was added to the ASPE reaction, so that allele-specific extension of a tagged allele-specific primer led to the incorporation of the labeled non-standard triphosphate (isoGTP-Biotin) opposite the non-standard nucleotide (iso-C) in the template strand created in the preceding multiplex PCR reaction. Unincorporated isoGTP-Biotin was removed prior to the subsequent capture step.

The third step, capture of the multiplex ASPE reaction products, used capture sequences containing non-standard nucleotides (iso-C) that were each covalently coupled to unique Luminex™ microsphere identities. The capture sequences were complementary to the tagging sequences used in the set of tagged allele-specific primers in the preceding ASPE reaction. Phycoerythrin was added to bind to the Biotin label on the extended tagged allele-specific primer strands and provide fluorescent signal. Following hybridization between the capture sequences and the tagging sequences, the microspheres were injected into a Luminex100™ instrument to detect signal associated with each unique microsphere identity.

Nine polymorphic regions of the mouse genome were targeted in this example:

Target ID	SEQ NO	Sequence	A/J	C57BL6/J	AB6F1
2	104	AGAAACAACCATCTAATCCCACACTAAAAT TCAAGGCTCCACAGACGAAACAGTGAAGAA TAATTGTTTCAGCATACTAACCAACTGATTA CATATTTACCATACTCAGGTTTGTGCTTCA TACAAACCCAC/TAGTCCGGCGCTCCCTGTTA GATG	CC	TT	CT
3	105	CTTCTCCCATGCCCAGGGCACTCTCCTCT GTAGAA/GTAGACTGATYTTTGTGGAGACATC A	GG	AA	AG
4	106	AGTGCCTGCTACCTGTTCAGGTGAAAATTTT TTAGTGATCCC/TAAGCTCAATGGGTGCGYGGC TTGCAGG	CC	TT	CT
5	107	GGTTGGAATGTTTGCACATGCAGTGTAG TATTTGGGC/TGATAACTACTTAGCTTATC GCCTGGTCCAGC	TT	CC	CT
6	108	CTGATCTGACCTCAGACTGTTGTGCTAACA GATATAACACCAGTAAGTTGAC/GTCAAATAC TGCAGGAAGTAGAGCCTTGC	GG	CC	CG
7	109	GACTGCTGGAGAGCTGAGGGAGGCTGTGGA GAATAAGGAGAGAGCA/GTAGTCTCGTGCCCT GCCCTGCCATACTGAGCAGCCAAGACAC	GG	AA	AG
8	110	GGACTGTCCAAKGGATCTCAAGGAGAATA GTCTTGCTATTAA/GGAGTATAAAGGCATAA AAGAGGTCATAGGGGACAACCATGACCAAG AAGTTG	AA	GG	AG
9	111	CCTTCCTGCAYTCCACAGTATAAACACAG ATGCACACTGCA/GGTCGTTGTATTTGTGT GATGTGAATTAAGATGCTTTGGCTAAGC AGGAGATGATAATACTG	AA	GG	AG
10	112	CACATACACCATGTCAGCCATCAGCGCAA GCCTTCGAGTTTCAGCTGTGAGATGAAGG TTGGAGAAGCACGTTGATCTGCAAAGAAGC	CC	TT	CT

-continued

SEQ Target ID NO: Sequence	A/J	C57BL6/J	AB6F1
AAAGGAGCTAGCGGAGGCC/TGGTCACTGACC GACTGCTCA			

The following nucleic acids were used in the multiplex PCR step for this example:

Nucleic acid component	Sequence	SEQ ID NO
PCR Primer 1A	5' - 6FAM-AGAAACAACCATCTAATCCCACA-3'	114
PCR Primer 1B	5' - TXCATCTAACAGGGAGCGCC-3'	157
PCR Primer 2A	5' - 6FAM-CTTCTCCCATTGCCAGG-3'	115
PCR Primer 2B	5' - TXTGATGTCTCCACAAAGATCAGTC-3'	158
PCR Primer 3A	5' - 6FAM-CCTGCAAGCCAGCACC-3'	118
PCR Primer 3B	5' - TXCCTGCAAGCCAGCACC-3'	159
PCR Primer 4A	5' - 6FAM-GGTTGGAATGTTGCACATGC-3'	119
PCR Primer 4B	5' - TXGCTGGACCAGGCTAGATAAGC-3'	160
PCR Primer 5A	5' - 6FAM-CTGATCTGACCTCAGACTGTTG-3'	121
PCR Primer 5B	5' - TXGCAAGGCTCTACTTCCTGC-3'	161
PCR Primer 6A	5' - 6FAM-GACTGCTGGAGAGCTGAGG-3'	123
PCR Primer 6B	5' - TXGTGTCTTGGCTGCTCAGTATG-3'	162
PCR Primer 7A	5' - 6FAM-GGACTGTCCAAAGGGATCTC-3'	125
PCR Primer 7B	5' - TXCAACTTCTTGGTCATGGTTGTC-3'	163
PCR Primer 8A	5' - 6FAM-CAGTATTATCATCTCCTGGCTTAGC-3'	128
PCR Primer 8B	5' - TXCCTTCTGCACTCCACAG-3'	164
PCR Primer 9A	5' - 6FAM-CACATACACCATGTCAGCC-3'	129
PCR Primer 9B	5' - TXTGAGCAGTCGGTCAGTG-3'	165
Template 1	Mouse genomic DNA; Strain: A/J	
Template 2	Mouse genomic DNA; Strain: C57BL6/J	
Template 3	Mouse genomic DNA; Strain: AB6F1	

PCR primers were synthesized and diluted in 1 mM MOPS pH 7.5, 0.1 mM EDTA. Mouse genomic DNA samples were purchased from the Jackson Laboratory in (Bar Harbor, Me.). All genomic DNA samples were diluted to 5 ng/ μ L in 1 mM MOPS pH 7.5, 0.1 mM EDTA. PCR reaction components were:

Component	1X Concentration	Supplier and Location
10X PCR Buffer II	1.2 X	Applied Biosystems, Foster City, CA
MgCl ₂	2 mM	Sigma, St. Louis, MO
DATP	200 μ M	Amersham
DGTP	200 μ M	Amersham
DCTP	200 μ M	Amersham

50

-continued

Component	1X Concentration	Supplier and Location
DTTP	200 μ M	Amersham
Amplitaq™ Gold DNA Polymerase	0.1 U/ μ L	Applied Biosystems, Foster City, CA
PCR Primers (each)	0.2 μ M	

60

A Master Mix of all listed components was prepared at 1.09 \times concentration for 25 μ L final reaction volumes. 23 μ L Master Mix was combined with 2 μ L of genomic DNA template (5 ng/ μ L) in individual PCR tubes. A negative control included water in place of genomic DNA template. PCR reactions were cycled as follows:

Cycle #	Step	Temp	Time
1	1	95° C.	9 minutes
2-41	1	95° C.	10 seconds
	2	55° C.	10 seconds
	3	70° C.	30 seconds
42	1	70° C.	5 minutes
43	1	4° C.	hold

Following PCR cycling, 2 μ L of each PCR reaction was transferred to act as template in the multiplex ASPE reaction. The following synthetic nucleic acids were used as tagged allele-specific (TAS) primers in the multiplex ASPE reaction:

Nucleic acid component	Sequence	SEQ ID NO
TAS Primer 1	5' -GTGYACAYGC-c3-GCTTCATACAAACCCAC-3'	131
TAS Primer 2	5' -CGAYTCTGYC-c3-GCTTCATACAAACCCAT-3'	132
TAS Primer 3	5' -CTAYCAAYCC-c3-CACTCTCCTCTGTAGAA-3'	133
TAS Primer 4	5' -GAGAYCYAAG-c3-CACTCTCCTCTGTAGAG-3'	134
TAS Primer 5	5' -GTTCYTGAYG-c3-GAAAATTTCTTAGTGATCCT-3'	135
TAS Primer 6	5' -GCTAYCTAC-c3-AAAATTTCTTAGTGATCCC-3'	136
TAS Primer 7	5' -GTTAYCYTCC-c3-AGTGTTAGTTATTTGGGT-3'	137
TAS Primer 8	5' -CACYATACYG-c3-GTGTTAGTTATTTGGGC-3'	138
TAS Primer 9	5' -CYTACCYATG-c3-TAACACCAGTAAGTTGAC-3'	139
TAS Primer 10	5' -GYCGAYAATC-c3-TAACACCAGTAAGTTGAG-3'	140
TAS Primer 11	5' -GYCGTAYTTG-c3-AGAATAAGGAGAGAGCA-3'	141
TAS Primer 12	5' -GTYTATYCCG-c3-GAATAAGGAGAGAGCG-3'	142
TAS Primer 13	5' -GACAYACYTC-c3-AGAATAGTCCTTGCTATTAA-3'	143
TAS Primer 14	5' -GGAAAYAACYG-c3-AGAATAGTCMGCTATTAG-3'	144
TAS Primer 15	5' -GATYTYCAGC-c3-AGAATGCACACTGCA-3'	145
TAS Primer 16	5' -GTYATYTGCG-c3-GAATGCACACTGCG-3'	146
TAS Primer 17	5' -GATYGTCTYYG-c3-GCTAGCGGAGGCC-3'	147
TAS Primer 18	5' -GGYCTYATGG-c3-GCTAGCGGAGGCT-3'	148

Components of the ASPE reaction were:

Component	1X Concentration	Supplier and Location
Bis-Tris-Propane pH 8.9	10 mM	Sigma, St. Louis, MO
Potassium Acetate	40 mM	Sigma, St. Louis, MO
MgCl ₂	2 mM	Sigma, St. Louis, MO
dATP	50 μ M	Amersham Pharmacia, Piscataway, NJ
dGTP	50 μ M	Amersham Pharmacia, Piscataway, NJ
dCTP	50 μ M	Amersham Pharmacia, Piscataway, NJ
dTTP	50 μ M	Amersham Pharmacia, Piscataway, NJ
d-isoGTP-Biotin	10 μ M	EraGen Biosciences, Inc., Madison, WI

-continued

Component	1X Concentration	Supplier and Location
5 Klentaq DNA Polymerase	0.067 U/ μ L	Ab Peptides, St. Louis, MO
TAS Primers (each)	0.067 μ M	EraGen Biosciences, Inc., Madison, WI

10 A Master Mix containing all of the above components was prepared at 1.15 \times . Each ASPE reaction consisted of 13 μ L Master Mix and 2 μ L PCR reaction (from previous step). ASPE reactions were cycled as follows:

Cycle #	Step	Temp	Time
1	1	95° C.	2 minutes
2-11	1	95° C.	1 seconds
	2	48° C.	1 seconds
	3	72° C.	1 minutes
12	1	72° C.	5 minutes
13	1	4° C.	hold

60 Following ASPE cycling, 5 μ L of a solution containing 40 mM Tris, 40 mM EDTA was added to the multiplex ASPE reaction to stop the activity of the polymerase. The reaction was purified over a G-50 column to remove unincorporated d-isoGTP-Biotin. The purified multiplex ASPE reaction was then deconvoluted by capture sequences coupled to Luminex™ microspheres (Luminex Corp, Houston, Tex.). The coupled microspheres were:

65

Microsphere Identity	SEQ ID NO:	Capture Sequence
1	2	CXGTTXTTCC
2	9	CATXGGTAXG
7	14	CGGXATAXAC
15	13	CAAXTACGXC
17	22	GCTGXAXATC
18	23	CGCAXATXAC
19	1	GAXGTXTGTC
20	3	GGXTTGXTAG
21	4	CTTXGXTCCTC
22	5	CXTCAXGAAC
34	7	GGAXGXTAAC
35	8	CXGTATXGTG
37	6	GTAGXTAXGC
38	10	GATTXTCGXC
45	28	CXXGACXATC
47	29	CCATXAGXCC
61	36	GCXTGTXCAC
62	37	GXCAGAXTCG

The coupled microspheres were combined in a mixture containing equal numbers of each microsphere identity in a storage buffer (10 mM MOPS pH 7.5, 200 mM NaCl, 1 mM EDTA, 1% PEG8000, 0.05% SDS). The components of the capture hybridization reaction were:

Component	1X Concentration	Supplier and Location
MOPS pH 7.5	10 mM	Fisher Chemical, Fair Lawn, NJ
NaCl	200 mM	Fisher Chemical, Fair Lawn, NJ
MgCl ₂	50 mM	Sigma, St. Louis, MO
EDTA	1 mM	Fisher Chemical, Fair Lawn, NJ
PEG8000	1%	Sigma, St. Louis, MO
SDS	0.5%	Fisher Chemical, Fair Lawn, NJ
Herring sperm DNA	0.1 mg/mL	Promega, Madison, WI
Microsphere mix	1000 each identity	EraGen Biosciences, Inc., Madison, WI

A Master Mix of all listed components was prepared at 1.2x concentration for 60 μ L final reaction volume. 50 μ L Master Mix was combined with 10 μ L of the purified multiplex ASPE reaction and allowed to hybridize at room temperature for 10 minutes. 10 μ L of a 0.01 mg/mL solution of Streptavidin Phycoerethrin (Molecular Probes, Eugene, Oreg.) in hybridization buffer (10 mM MOPS pH7.5, 200 mM NaCl, 50 mM MgCl₂, 1 mM EDTA, 1% PEG8000, 0.05% SDS) was added to each capture hybridization reaction prior to injection into a Luminex100™ instrument.

For each capture hybridization reaction, 55 μ L was injected into the Luminex100™ at a rate of 60 μ L/min and the read continued until 50 of each microsphere identity were counted. The median fluorescence intensity was used as a measurement of the fluorescent signal associated with each microsphere identity. The results are shown in FIG. 15.

The present invention should not be considered limited to the particular examples described above, but rather should be understood to cover all aspects of the invention as fairly set out in the attached claims. Various modifications, equivalent processes, as well as numerous structures to which the present invention may be applicable will be readily apparent to those of skill in the art to which the present invention is directed upon review of the instant specification.

Example 7

Genotyping of Genomic DNA Using Site Specific Ligation of a Reporter Oligonucleotide to an Allele Specific Extension Product and Capture on Solid Support Microspheres

The genotype of a polymorphic loci was determined following the amplification, query, and capture of target nucleic acid sequences from genomic DNA samples. The first step, a PCR reaction, included a set of PCR primers: a first primer A and a second primer B. The primer B contained a 5' sequence non-complementary to the target with an iso-C at the junction of the analyte specific and non-complementary portion. The primer pair was designed to hybridize to and amplify a region of mouse genomic DNA that encompasses a known polymorphic site. The second step, an allele specific primer extension (ASPE) reaction, included a set of tagged allele-specific primers. Each tagged allele-specific primer was composed of a 5' tagging sequence containing non-standard nucleotides (iso-G), followed by a c3 spacer, followed by a 3' sequence designed to hybridize to one of the DNA strands amplified in the previous PCR step. The allele specificity was determined by the 3' nucleotide of each tagged allele-specific primer. The set of tagged allele-specific primers was designed to query a known polymorphic site embedded in the amplified sequence. A DNA ligase and a reporter oligonucleotide containing a 5' phosphate, and a 3' biotin modifications were included in the ASPE reaction. This reporter oligonucleotide was complimentary to the 5' region of primer B used to generate the amplicon that was queried. The strand of the amplified product containing this non-standard base containing region served as the template for the ASPE reaction. During allele specific primer extension, the DNA polymerase terminates at the base prior to the iso-C in the template strand, thus leaving a single stranded region to which the reporter oligonucleotide to hybridize. The complex between the extended ASPE primer, the template, and the reporter oligonucleotide results in a nick structure suitable for ligation by a DNA ligase.

The third step, capture of the multiplex ASPE reaction products, used sequences containing non-standard nucleotides (iso-C) that were each covalently coupled to unique Luminex microsphere identities. The capture sequences were complementary to the tagging sequences used in the set of tagged allele-specific primers in the preceding ASPE reaction. Streptavidin-phycoerethrin was added to bind to the biotin label on the extended and ligated allele-specific primer strands to provide fluorescent signal. Following hybridization between the capture sequences and the tagging sequences, the microspheres were injected into a Luminex 100 instrument to detect signal associated with each unique microsphere identity.

A single polymorphic region of the mouse genome was targeted in this example:

SEQ ID NO:	Target Sequence	A/J	C57BL6/J	AB6F1
149	5' CTTCTCCCATTGCCAGGGCACTCT CCTCTGTAGARTAGACTGATMTG TGGAGACATCA 3'	GG	AA	AG

Nucleic Acid Component	Sequence 5'-3'	SEQ ID NO:
PCR Primer A	PO ₄ -CTTCTCCCATTGCCAGG	115
PCR Primer B	CXGCGXAGXGATXTGATGTCTCCACAAAGATCAGTC	150
Template 1	Mouse genomic DNA; Strain: A/J	
Template 1	Mouse genomic DNA; Strain: C57BL6/J	
Template 1	Mouse genomic DNA; Strain: AB6F1	

Mouse Genomic DNA samples were purchased from Jackson Laboratories (Bar Harbor, Me.). All genomic DNA samples were diluted to 10 ng/ul in 1 mM MOPS pH 7.5, 0.1 mM EDTA. PCR reaction components were:

Component	1X Concentration	Supplier and Location
10X PCR Buffer II	1.2 X	Applied Biosystems, Foster City, CA
MgCl ₂	2 mM	Sigma, St. Louis, MO
dGTP	200 uM	Promega, Madison, WI
dATP	200 uM	Promega, Madison, WI
dTTP	200 uM	Promega, Madison, WI
dCTP	200 uM	Promega, Madison, WI
Amplitaq DNA Polymerase	0.2 U/ul	Applied Biosystems, Foster City, CA
Stoffel Fragment		
PCR Primer A	0.2 uM	
PCR Primer B	0.2 uM	

A master mix of all listed components was prepared at 1.07x concentration for 30 ul final reaction volume. 23 ul of master mix was combined with 2 ul of genomic DNA template (5 ng/ul) in individual PCR tubes. A negative control included water in place of genomic DNA template. PCR reactions were thermal cycled as follows:

Cycle #	Step	Temp	Time
1	1	95° C.	2 minutes
2-41	1	95° C.	10 seconds
	2	55° C.	10 seconds
	3	65° C.	30 seconds
42	1	65° C.	5 minutes
43	1	4° C.	hold

Following PCR cycling, 3 ul of 5 U/ul lambda exonuclease (New England Biolabs, Beverly, Mass.) was added to each reaction to remove the non-template strand of the amplicon created by PCR primer A. Following addition of lambda exonuclease the reaction tubes were heated to 37° C. for 5 minutes, then to 95° C. for 2 minutes. Following this digest, 1 ul of each PCR reaction was transferred to act as template in the ASPE reaction. The following nucleic acid sequences were used as tagged allele-specific (TAS) primers in the ASPE reaction:

Nucleic acid component	Sequence 5'-3'	SEQ ID NO:
TAS Primer 1	CTAYCAAAYCC-c3-CACTCTCCT CTGTAGAA	151
TAS Primer 2	GAGAYCYAAG-c3-CACTCTCCT CTGTAGAG	152
Reporter oligonucleotide	PO ₄ -YATCYCTYGCYG-Biotin	153

Components of the ASPE reaction were:

Component	1X Concentration	Supplier and Location
10X PCR Buffer II	1.2 X	Applied Biosystems, Foster City, CA
MgCl ₂	2 mM	Sigma, St. Louis, MO
DGTP	200 uM	Promega, Madison, WI
DATP	200 uM	Promega, Madison, WI
DTTP	200 uM	Promega, Madison, WI
DCTP	200 uM	Promega, Madison, WI
Amplitaq DNA Polymerase	0.1 U/ul	Applied Biosystems, Foster City, CA
Stoffel Fragment		
TAS Primer 1	0.1 uM	
TAS Primer 2	0.1 uM	
Reporter oligonucleotide	0.2 uM	
DTT	5 mM	Fisher Scientific, Pittsburgh, PA
NAD	1 mM	Roche, Indianapolis, IN
Taq DNA ligase	2 U/ul	New England Biolabs, Beverly, MA

A master mix containing all of the above components was prepared at 1.11x. Each ASPE reaction consisted of 9 ul master mix and 1 ul PCR reaction (from previous step). ASPE reactions were cycled as follows:

Cycle #	Step	Temp	Time
1	1	95° C.	30 seconds
2-13	1	95° C.	1 seconds
	2	48° C.	1 seconds
	3	58° C.	2 minutes
14	1	4° C.	hold

55

Following ASPE cycling the reactions were deconvoluted by capture sequences coupled to Luminex microspheres (Luminex Corp, Austin, Tex.). The coupled microspheres were:

Microsphere Identity	SEQ ID NO:	Capture sequence 5'-3'
20	3	GGXTTGXTAG
21	4	CTTXGXTCTC

The coupled microspheres were combined in a mixture containing equal numbers of each microsphere identity in a storage buffer (10 mM MOPS pH 7.5, 200 mM NaCl, 1 mM EDTA, 1% PEG8000, 0.05% SDS), The components of the capture hybridization reaction were:

Component	1X Concentration	Supplier and Location
MOPS pH 7.5	10 mM	Sigma, St. Louis, MO
NaCl	200 mM	Sigma, St. Louis, MO
MgCl ₂	50 mM	Sigma, St. Louis, MO
EDTA	1 mM	Sigma, St. Louis, MO
PEG 8000	1%	Sigma, St. Louis, MO
SDS	0.05%	Sigma, St. Louis, MO
Herring Sperm DNA	0.1 mg/ml	Promega, Madison, WI

56

-continued

Component	1X Concentration	Supplier and Location
5 Microsphere mix	1000 each identity	Luminex Corp., Austin, TX

A master mix containing all of the above components was prepared at 1.2x concentration for a 60 ul final reaction volume. 50 ul of this master mix was added to each ASPE reaction and allowed to hybridize for 10 minutes at room temperature. 10 ul of solution of streptavidin-phycoerythrin (0.075 mg/ml in 10 mM MOPS pH 7.5, NaCl 200 mM, MgCl₂ 50 mM, EDTA 1 mM, PEG 8000 1%, SDS 0.05) (Molecular Probes, Eugene, Oreg.) was added to each capture hybridization prior to injection into a Luminex 100 instrument.

For each capture hybridization reaction, 45 ul of the reaction mixture was injected into the Luminex 100 at a rate of 60 ul/min and the read continued until 100 of each microsphere identity were counted. The median fluorescence intensity (MFI) was used as a measurement of the fluorescent signal associated with each identity. The results are shown in FIG. 17.

In the above example, the non-standard base of primer B at the junction of the 5' non-complementary sequence and the analyte-specific sequence is designed to prevent extension by the polymerase at the junction of the tagging and analyte specific sequences. It is specifically envisioned that other suitable linkers may be used to stop the polymerase, including, for example, 2'-O-methyl bases such as 2'-O-methyl ribonucleotides.

SEQUENCE LISTING

<160> NUMBER OF SEQ ID NOS: 165

<210> SEQ ID NO 1
 <211> LENGTH: 10
 <212> TYPE: DNA
 <213> ORGANISM: Artificial
 <220> FEATURE:
 <223> OTHER INFORMATION: synthetic oligonucleotide
 <220> FEATURE:
 <221> NAME/KEY: modified_base
 <222> LOCATION: (3)..(3)
 <223> OTHER INFORMATION: n represents iso-cytosine
 <220> FEATURE:
 <221> NAME/KEY: modified_base
 <222> LOCATION: (6)..(6)
 <223> OTHER INFORMATION: n represents iso-cytosine

<400> SEQUENCE: 1

gangtntgtc

10

<210> SEQ ID NO 2
 <211> LENGTH: 10
 <212> TYPE: DNA
 <213> ORGANISM: Artificial
 <220> FEATURE:
 <223> OTHER INFORMATION: synthetic oligonucleotide
 <220> FEATURE:
 <221> NAME/KEY: modified_base
 <222> LOCATION: (2)..(2)
 <223> OTHER INFORMATION: n represents iso-cytosine
 <220> FEATURE:
 <221> NAME/KEY: modified_base
 <222> LOCATION: (6)..(6)
 <223> OTHER INFORMATION: n represents iso-cytosine

<400> SEQUENCE: 2

cngtnttcc

10

-continued

<210> SEQ ID NO 3
 <211> LENGTH: 10
 <212> TYPE: DNA
 <213> ORGANISM: Artificial
 <220> FEATURE:
 <223> OTHER INFORMATION: synthetic oligonucleotide
 <220> FEATURE:
 <221> NAME/KEY: modified_base
 <222> LOCATION: (3)..(3)
 <223> OTHER INFORMATION: n represents iso-cytosine
 <220> FEATURE:
 <221> NAME/KEY: modified_base
 <222> LOCATION: (7)..(7)
 <223> OTHER INFORMATION: n represents iso-cytosine
 <400> SEQUENCE: 3

ggnttgntag 10

<210> SEQ ID NO 4
 <211> LENGTH: 10
 <212> TYPE: DNA
 <213> ORGANISM: Artificial
 <220> FEATURE:
 <223> OTHER INFORMATION: synthetic oligonucleotide
 <220> FEATURE:
 <221> NAME/KEY: modified_base
 <222> LOCATION: (4)..(4)
 <223> OTHER INFORMATION: n represents iso-cytosine
 <220> FEATURE:
 <221> NAME/KEY: modified_base
 <222> LOCATION: (6)..(6)
 <223> OTHER INFORMATION: n represents iso-cytosine
 <400> SEQUENCE: 4

cttngntctc 10

<210> SEQ ID NO 5
 <211> LENGTH: 10
 <212> TYPE: DNA
 <213> ORGANISM: Artificial
 <220> FEATURE:
 <223> OTHER INFORMATION: synthetic oligonucleotide
 <220> FEATURE:
 <221> NAME/KEY: modified_base
 <222> LOCATION: (2)..(2)
 <223> OTHER INFORMATION: n represents iso-cytosine
 <220> FEATURE:
 <221> NAME/KEY: modified_base
 <222> LOCATION: (6)..(6)
 <223> OTHER INFORMATION: n represents iso-cytosine
 <400> SEQUENCE: 5

cntcangaac 10

<210> SEQ ID NO 6
 <211> LENGTH: 10
 <212> TYPE: DNA
 <213> ORGANISM: Artificial
 <220> FEATURE:
 <223> OTHER INFORMATION: synthetic oligonucleotide
 <220> FEATURE:
 <221> NAME/KEY: modified_base
 <222> LOCATION: (5)..(5)
 <223> OTHER INFORMATION: n represents iso-cytosine
 <220> FEATURE:
 <221> NAME/KEY: modified_base
 <222> LOCATION: (8)..(8)
 <223> OTHER INFORMATION: n represents iso-cytosine
 <400> SEQUENCE: 6

gtagntangc 10

-continued

<210> SEQ ID NO 7
 <211> LENGTH: 10
 <212> TYPE: DNA
 <213> ORGANISM: Artificial
 <220> FEATURE:
 <223> OTHER INFORMATION: synthetic oligonucleotide
 <220> FEATURE:
 <221> NAME/KEY: modified_base
 <222> LOCATION: (4)..(4)
 <223> OTHER INFORMATION: n represents iso-cytosine
 <220> FEATURE:
 <221> NAME/KEY: modified_base
 <222> LOCATION: (6)..(6)
 <223> OTHER INFORMATION: n represents iso-cytosine
 <400> SEQUENCE: 7

ggangntaac 10

<210> SEQ ID NO 8
 <211> LENGTH: 10
 <212> TYPE: DNA
 <213> ORGANISM: Artificial
 <220> FEATURE:
 <223> OTHER INFORMATION: synthetic oligonucleotide
 <220> FEATURE:
 <221> NAME/KEY: modified_base
 <222> LOCATION: (2)..(2)
 <223> OTHER INFORMATION: n represents iso-cytosine
 <220> FEATURE:
 <221> NAME/KEY: modified_base
 <222> LOCATION: (7)..(7)
 <223> OTHER INFORMATION: n represents iso-cytosine
 <400> SEQUENCE: 8

cngtatngtg 10

<210> SEQ ID NO 9
 <211> LENGTH: 10
 <212> TYPE: DNA
 <213> ORGANISM: Artificial
 <220> FEATURE:
 <223> OTHER INFORMATION: synthetic oligonucleotide
 <220> FEATURE:
 <221> NAME/KEY: modified_base
 <222> LOCATION: (4)..(4)
 <223> OTHER INFORMATION: n represents iso-cytosine
 <220> FEATURE:
 <221> NAME/KEY: modified_base
 <222> LOCATION: (9)..(9)
 <223> OTHER INFORMATION: n represents iso-cytosine
 <400> SEQUENCE: 9

catnggtang 10

<210> SEQ ID NO 10
 <211> LENGTH: 10
 <212> TYPE: DNA
 <213> ORGANISM: Artificial
 <220> FEATURE:
 <223> OTHER INFORMATION: synthetic oligonucleotide
 <220> FEATURE:
 <221> NAME/KEY: modified_base
 <222> LOCATION: (5)..(5)
 <223> OTHER INFORMATION: n represents iso-cytosine
 <220> FEATURE:
 <221> NAME/KEY: modified_base
 <222> LOCATION: (9)..(9)
 <223> OTHER INFORMATION: n represents iso-cytosine
 <400> SEQUENCE: 10

gattntcgnc 10

-continued

<210> SEQ ID NO 11
 <211> LENGTH: 10
 <212> TYPE: DNA
 <213> ORGANISM: Artificial
 <220> FEATURE:
 <223> OTHER INFORMATION: synthetic oligonucleotide
 <220> FEATURE:
 <221> NAME/KEY: modified_base
 <222> LOCATION: (4)..(4)
 <223> OTHER INFORMATION: n represents iso-cytosine
 <220> FEATURE:
 <221> NAME/KEY: modified_base
 <222> LOCATION: (6)..(6)
 <223> OTHER INFORMATION: n represents iso-cytosine
 <400> SEQUENCE: 11

gttnangacc 10

<210> SEQ ID NO 12
 <211> LENGTH: 10
 <212> TYPE: DNA
 <213> ORGANISM: Artificial
 <220> FEATURE:
 <223> OTHER INFORMATION: synthetic oligonucleotide
 <220> FEATURE:
 <221> NAME/KEY: modified_base
 <222> LOCATION: (2)..(2)
 <223> OTHER INFORMATION: n represents iso-cytosine
 <220> FEATURE:
 <221> NAME/KEY: modified_base
 <222> LOCATION: (6)..(6)
 <223> OTHER INFORMATION: n represents iso-cytosine
 <400> SEQUENCE: 12

cngaangatc 10

<210> SEQ ID NO 13
 <211> LENGTH: 10
 <212> TYPE: DNA
 <213> ORGANISM: Artificial
 <220> FEATURE:
 <223> OTHER INFORMATION: synthetic oligonucleotide
 <220> FEATURE:
 <221> NAME/KEY: modified_base
 <222> LOCATION: (4)..(4)
 <223> OTHER INFORMATION: n represents iso-cytosine
 <220> FEATURE:
 <221> NAME/KEY: modified_base
 <222> LOCATION: (9)..(9)
 <223> OTHER INFORMATION: n represents iso-cytosine
 <400> SEQUENCE: 13

caantacgnc 10

<210> SEQ ID NO 14
 <211> LENGTH: 10
 <212> TYPE: DNA
 <213> ORGANISM: Artificial
 <220> FEATURE:
 <223> OTHER INFORMATION: synthetic oligonucleotide
 <220> FEATURE:
 <221> NAME/KEY: modified_base
 <222> LOCATION: (4)..(4)
 <223> OTHER INFORMATION: n represents iso-cytosine
 <220> FEATURE:
 <221> NAME/KEY: modified_base
 <222> LOCATION: (8)..(8)
 <223> OTHER INFORMATION: n represents iso-cytosine
 <400> SEQUENCE: 14

cggnatanac 10

-continued

<210> SEQ ID NO 15
 <211> LENGTH: 10
 <212> TYPE: DNA
 <213> ORGANISM: Artificial
 <220> FEATURE:
 <223> OTHER INFORMATION: synthetic oligonucleotide
 <220> FEATURE:
 <221> NAME/KEY: modified_base
 <222> LOCATION: (2)..(2)
 <223> OTHER INFORMATION: n represents iso-cytosine
 <220> FEATURE:
 <221> NAME/KEY: modified_base
 <222> LOCATION: (6)..(6)
 <223> OTHER INFORMATION: n represents iso-cytosine
 <220> FEATURE:
 <221> NAME/KEY: modified_base
 <222> LOCATION: (7)..(7)
 <223> OTHER INFORMATION: n represents iso-cytosine

 <400> SEQUENCE: 15

gnaaannagg

10

<210> SEQ ID NO 16
 <211> LENGTH: 10
 <212> TYPE: DNA
 <213> ORGANISM: Artificial
 <220> FEATURE:
 <223> OTHER INFORMATION: synthetic oligonucleotide
 <220> FEATURE:
 <221> NAME/KEY: modified_base
 <222> LOCATION: (4)..(4)
 <223> OTHER INFORMATION: n represents iso-cytosine
 <220> FEATURE:
 <221> NAME/KEY: modified_base
 <222> LOCATION: (8)..(8)
 <223> OTHER INFORMATION: n represents iso-cytosine
 <220> FEATURE:
 <221> NAME/KEY: modified_base
 <222> LOCATION: (9)..(9)
 <223> OTHER INFORMATION: n represents iso-cytosine

 <400> SEQUENCE: 16

gtcntagnnc

10

<210> SEQ ID NO 17
 <211> LENGTH: 10
 <212> TYPE: DNA
 <213> ORGANISM: Artificial
 <220> FEATURE:
 <223> OTHER INFORMATION: synthetic oligonucleotide
 <220> FEATURE:
 <221> NAME/KEY: modified_base
 <222> LOCATION: (2)..(2)
 <223> OTHER INFORMATION: n represents iso-cytosine
 <220> FEATURE:
 <221> NAME/KEY: modified_base
 <222> LOCATION: (6)..(6)
 <223> OTHER INFORMATION: n represents iso-cytosine
 <220> FEATURE:
 <221> NAME/KEY: modified_base
 <222> LOCATION: (9)..(9)
 <223> OTHER INFORMATION: n represents iso-cytosine

 <400> SEQUENCE: 17

gncctntanc

10

<210> SEQ ID NO 18
 <211> LENGTH: 10
 <212> TYPE: DNA
 <213> ORGANISM: Artificial
 <220> FEATURE:
 <223> OTHER INFORMATION: synthetic oligonucleotide

-continued

<220> FEATURE:
 <221> NAME/KEY: modified_base
 <222> LOCATION: (3)..(3)
 <223> OTHER INFORMATION: n represents iso-cytosine
 <220> FEATURE:
 <221> NAME/KEY: modified_base
 <222> LOCATION: (6)..(6)
 <223> OTHER INFORMATION: n represents iso-cytosine

<400> SEQUENCE: 18

ccnacntgag

10

<210> SEQ ID NO 19
 <211> LENGTH: 10
 <212> TYPE: DNA
 <213> ORGANISM: Artificial
 <220> FEATURE:
 <223> OTHER INFORMATION: synthetic oligonucleotide
 <220> FEATURE:
 <221> NAME/KEY: modified_base
 <222> LOCATION: (3)..(3)
 <223> OTHER INFORMATION: n represents iso-cytosine
 <220> FEATURE:
 <221> NAME/KEY: modified_base
 <222> LOCATION: (4)..(4)
 <223> OTHER INFORMATION: n represents iso-cytosine
 <220> FEATURE:
 <221> NAME/KEY: modified_base
 <222> LOCATION: (7)..(7)
 <223> OTHER INFORMATION: n represents iso-cytosine

<400> SEQUENCE: 19

ctnncanagg

10

<210> SEQ ID NO 20
 <211> LENGTH: 10
 <212> TYPE: DNA
 <213> ORGANISM: Artificial
 <220> FEATURE:
 <223> OTHER INFORMATION: synthetic oligonucleotide
 <220> FEATURE:
 <221> NAME/KEY: modified_base
 <222> LOCATION: (3)..(3)
 <223> OTHER INFORMATION: n represents iso-cytosine
 <220> FEATURE:
 <221> NAME/KEY: modified_base
 <222> LOCATION: (6)..(6)
 <223> OTHER INFORMATION: n represents iso-cytosine

<400> SEQUENCE: 20

gtnganatgc

10

<210> SEQ ID NO 21
 <211> LENGTH: 10
 <212> TYPE: DNA
 <213> ORGANISM: Artificial
 <220> FEATURE:
 <223> OTHER INFORMATION: synthetic oligonucleotide
 <220> FEATURE:
 <221> NAME/KEY: modified_base
 <222> LOCATION: (5)..(5)
 <223> OTHER INFORMATION: n represents iso-cytosine
 <220> FEATURE:
 <221> NAME/KEY: modified_base
 <222> LOCATION: (8)..(8)
 <223> OTHER INFORMATION: n represents iso-cytosine
 <220> FEATURE:
 <221> NAME/KEY: modified_base
 <222> LOCATION: (9)..(9)
 <223> OTHER INFORMATION: n represents iso-cytosine

<400> SEQUENCE: 21

gaaantgnng

10

-continued

<210> SEQ ID NO 22
 <211> LENGTH: 10
 <212> TYPE: DNA
 <213> ORGANISM: Artificial
 <220> FEATURE:
 <223> OTHER INFORMATION: synthetic oligonucleotide
 <220> FEATURE:
 <221> NAME/KEY: modified_base
 <222> LOCATION: (5)..(5)
 <223> OTHER INFORMATION: n represents iso-cytosine
 <220> FEATURE:
 <221> NAME/KEY: modified_base
 <222> LOCATION: (7)..(7)
 <223> OTHER INFORMATION: n represents iso-cytosine
 <400> SEQUENCE: 22

gctgnanatc

10

<210> SEQ ID NO 23
 <211> LENGTH: 10
 <212> TYPE: DNA
 <213> ORGANISM: Artificial
 <220> FEATURE:
 <223> OTHER INFORMATION: synthetic oligonucleotide
 <220> FEATURE:
 <221> NAME/KEY: modified_base
 <222> LOCATION: (5)..(5)
 <223> OTHER INFORMATION: n represents iso-cytosine
 <220> FEATURE:
 <221> NAME/KEY: modified_base
 <222> LOCATION: (8)..(8)
 <223> OTHER INFORMATION: n represents iso-cytosine
 <400> SEQUENCE: 23

cgcanatnac

10

<210> SEQ ID NO 24
 <211> LENGTH: 10
 <212> TYPE: DNA
 <213> ORGANISM: Artificial
 <220> FEATURE:
 <223> OTHER INFORMATION: synthetic oligonucleotide
 <220> FEATURE:
 <221> NAME/KEY: modified_base
 <222> LOCATION: (5)..(5)
 <223> OTHER INFORMATION: n represents iso-cytosine
 <220> FEATURE:
 <221> NAME/KEY: modified_base
 <222> LOCATION: (8)..(8)
 <223> OTHER INFORMATION: n represents iso-cytosine
 <400> SEQUENCE: 24

ctggntcnag

10

<210> SEQ ID NO 25
 <211> LENGTH: 10
 <212> TYPE: DNA
 <213> ORGANISM: Artificial
 <220> FEATURE:
 <223> OTHER INFORMATION: synthetic oligonucleotide
 <220> FEATURE:
 <221> NAME/KEY: modified_base
 <222> LOCATION: (5)..(5)
 <223> OTHER INFORMATION: n represents iso-cytosine
 <220> FEATURE:
 <221> NAME/KEY: modified_base
 <222> LOCATION: (7)..(7)
 <223> OTHER INFORMATION: n represents iso-cytosine
 <220> FEATURE:
 <221> NAME/KEY: modified_base
 <222> LOCATION: (8)..(8)
 <223> OTHER INFORMATION: n represents iso-cytosine

-continued

<400> SEQUENCE: 25

ggaananncc

10

<210> SEQ ID NO 26

<211> LENGTH: 10

<212> TYPE: DNA

<213> ORGANISM: Artificial

<220> FEATURE:

<223> OTHER INFORMATION: synthetic oligonucleotide

<220> FEATURE:

<221> NAME/KEY: modified_base

<222> LOCATION: (2)..(2)

<223> OTHER INFORMATION: n represents iso-cytosine

<220> FEATURE:

<221> NAME/KEY: modified_base

<222> LOCATION: (7)..(7)

<223> OTHER INFORMATION: n represents iso-cytosine

<400> SEQUENCE: 26

cntcgentac

10

<210> SEQ ID NO 27

<211> LENGTH: 10

<212> TYPE: DNA

<213> ORGANISM: Artificial

<220> FEATURE:

<223> OTHER INFORMATION: synthetic oligonucleotide

<220> FEATURE:

<221> NAME/KEY: modified_base

<222> LOCATION: (2)..(2)

<223> OTHER INFORMATION: n represents iso-cytosine

<220> FEATURE:

<221> NAME/KEY: modified_base

<222> LOCATION: (4)..(4)

<223> OTHER INFORMATION: n represents iso-cytosine

<220> FEATURE:

<221> NAME/KEY: modified_base

<222> LOCATION: (9)..(9)

<223> OTHER INFORMATION: n represents iso-cytosine

<400> SEQUENCE: 27

gncnaaaang

10

<210> SEQ ID NO 28

<211> LENGTH: 10

<212> TYPE: DNA

<213> ORGANISM: Artificial

<220> FEATURE:

<223> OTHER INFORMATION: synthetic oligonucleotide

<220> FEATURE:

<221> NAME/KEY: modified_base

<222> LOCATION: (2)..(2)

<223> OTHER INFORMATION: n represents iso-cytosine

<220> FEATURE:

<221> NAME/KEY: modified_base

<222> LOCATION: (3)..(3)

<223> OTHER INFORMATION: n represents iso-cytosine

<220> FEATURE:

<221> NAME/KEY: modified_base

<222> LOCATION: (7)..(7)

<223> OTHER INFORMATION: n represents iso-cytosine

<400> SEQUENCE: 28

cnngacnadc

10

<210> SEQ ID NO 29

<211> LENGTH: 10

<212> TYPE: DNA

<213> ORGANISM: Artificial

<220> FEATURE:

<223> OTHER INFORMATION: synthetic oligonucleotide

-continued

<220> FEATURE:
 <221> NAME/KEY: modified_base
 <222> LOCATION: (5)..(5)
 <223> OTHER INFORMATION: n represents iso-cytosine
 <220> FEATURE:
 <221> NAME/KEY: modified_base
 <222> LOCATION: (8)..(8)
 <223> OTHER INFORMATION: n represents iso-cytosine

 <400> SEQUENCE: 29

 ccatnagncc 10

 <210> SEQ ID NO 30
 <211> LENGTH: 10
 <212> TYPE: DNA
 <213> ORGANISM: Artificial
 <220> FEATURE:
 <223> OTHER INFORMATION: synthetic oligonucleotide
 <220> FEATURE:
 <221> NAME/KEY: modified_base
 <222> LOCATION: (5)..(5)
 <223> OTHER INFORMATION: n represents iso-cytosine
 <220> FEATURE:
 <221> NAME/KEY: modified_base
 <222> LOCATION: (7)..(7)
 <223> OTHER INFORMATION: n represents iso-cytosine

 <400> SEQUENCE: 30

 ggcantntgg 10

 <210> SEQ ID NO 31
 <211> LENGTH: 10
 <212> TYPE: DNA
 <213> ORGANISM: Artificial
 <220> FEATURE:
 <223> OTHER INFORMATION: synthetic oligonucleotide
 <220> FEATURE:
 <221> NAME/KEY: modified_base
 <222> LOCATION: (3)..(3)
 <223> OTHER INFORMATION: n represents iso-cytosine
 <220> FEATURE:
 <221> NAME/KEY: modified_base
 <222> LOCATION: (7)..(7)
 <223> OTHER INFORMATION: n represents iso-cytosine

 <400> SEQUENCE: 31

 ctnaacnggg 10

 <210> SEQ ID NO 32
 <211> LENGTH: 9
 <212> TYPE: DNA
 <213> ORGANISM: Artificial
 <220> FEATURE:
 <223> OTHER INFORMATION: synthetic oligonucleotide
 <220> FEATURE:
 <221> NAME/KEY: modified_base
 <222> LOCATION: (4)..(4)
 <223> OTHER INFORMATION: n represents iso-cytosine
 <220> FEATURE:
 <221> NAME/KEY: modified_base
 <222> LOCATION: (8)..(8)
 <223> OTHER INFORMATION: n represents iso-cytosine

 <400> SEQUENCE: 32

 gganacgng 9

 <210> SEQ ID NO 33
 <211> LENGTH: 10
 <212> TYPE: DNA
 <213> ORGANISM: Artificial
 <220> FEATURE:
 <223> OTHER INFORMATION: synthetic oligonucleotide

-continued

<220> FEATURE:
 <221> NAME/KEY: modified_base
 <222> LOCATION: (4)..(4)
 <223> OTHER INFORMATION: n represents iso-cytosine
 <220> FEATURE:
 <221> NAME/KEY: modified_base
 <222> LOCATION: (9)..(9)
 <223> OTHER INFORMATION: n represents iso-cytosine

 <400> SEQUENCE: 33

 gcgntttang 10

 <210> SEQ ID NO 34
 <211> LENGTH: 10
 <212> TYPE: DNA
 <213> ORGANISM: Artificial
 <220> FEATURE:
 <223> OTHER INFORMATION: synthetic oligonucleotide
 <220> FEATURE:
 <221> NAME/KEY: modified_base
 <222> LOCATION: (4)..(4)
 <223> OTHER INFORMATION: n represents iso-cytosine
 <220> FEATURE:
 <221> NAME/KEY: modified_base
 <222> LOCATION: (7)..(7)
 <223> OTHER INFORMATION: n represents iso-cytosine
 <220> FEATURE:
 <221> NAME/KEY: modified_base
 <222> LOCATION: (9)..(9)
 <223> OTHER INFORMATION: n represents iso-cytosine

 <400> SEQUENCE: 34

 gagnagntnc 10

 <210> SEQ ID NO 35
 <211> LENGTH: 10
 <212> TYPE: DNA
 <213> ORGANISM: Artificial
 <220> FEATURE:
 <223> OTHER INFORMATION: synthetic oligonucleotide
 <220> FEATURE:
 <221> NAME/KEY: modified_base
 <222> LOCATION: (2)..(2)
 <223> OTHER INFORMATION: n represents iso-cytosine
 <220> FEATURE:
 <221> NAME/KEY: modified_base
 <222> LOCATION: (7)..(7)
 <223> OTHER INFORMATION: n represents iso-cytosine

 <400> SEQUENCE: 35

 gnctaancg 10

 <210> SEQ ID NO 36
 <211> LENGTH: 10
 <212> TYPE: DNA
 <213> ORGANISM: Artificial
 <220> FEATURE:
 <223> OTHER INFORMATION: synthetic oligonucleotide
 <220> FEATURE:
 <221> NAME/KEY: modified_base
 <222> LOCATION: (3)..(3)
 <223> OTHER INFORMATION: n represents iso-cytosine
 <220> FEATURE:
 <221> NAME/KEY: modified_base
 <222> LOCATION: (7)..(7)
 <223> OTHER INFORMATION: n represents iso-cytosine

 <400> SEQUENCE: 36

 gcntgtncac 10

 <210> SEQ ID NO 37
 <211> LENGTH: 10

-continued

<212> TYPE: DNA
 <213> ORGANISM: Artificial
 <220> FEATURE:
 <223> OTHER INFORMATION: synthetic oligonucleotide
 <220> FEATURE:
 <221> NAME/KEY: modified_base
 <222> LOCATION: (2)..(2)
 <223> OTHER INFORMATION: n represents iso-cytosine
 <220> FEATURE:
 <221> NAME/KEY: modified_base
 <222> LOCATION: (7)..(7)
 <223> OTHER INFORMATION: n represents iso-cytosine

 <400> SEQUENCE: 37

gncagantcg

10

<210> SEQ ID NO 38
 <211> LENGTH: 10
 <212> TYPE: DNA
 <213> ORGANISM: Artificial
 <220> FEATURE:
 <223> OTHER INFORMATION: synthetic oligonucleotide
 <220> FEATURE:
 <221> NAME/KEY: modified_base
 <222> LOCATION: (4)..(4)
 <223> OTHER INFORMATION: n represents iso-cytosine
 <220> FEATURE:
 <221> NAME/KEY: modified_base
 <222> LOCATION: (9)..(9)
 <223> OTHER INFORMATION: n represents iso-cytosine

 <400> SEQUENCE: 38

cgtnctagng

10

<210> SEQ ID NO 39
 <211> LENGTH: 10
 <212> TYPE: DNA
 <213> ORGANISM: Artificial
 <220> FEATURE:
 <223> OTHER INFORMATION: synthetic oligonucleotide
 <220> FEATURE:
 <221> NAME/KEY: modified_base
 <222> LOCATION: (3)..(3)
 <223> OTHER INFORMATION: n represents iso-cytosine
 <220> FEATURE:
 <221> NAME/KEY: modified_base
 <222> LOCATION: (4)..(4)
 <223> OTHER INFORMATION: n represents iso-cytosine
 <220> FEATURE:
 <221> NAME/KEY: modified_base
 <222> LOCATION: (9)..(9)
 <223> OTHER INFORMATION: n represents iso-cytosine

 <400> SEQUENCE: 39

cgnntagtnng

10

<210> SEQ ID NO 40
 <211> LENGTH: 10
 <212> TYPE: DNA
 <213> ORGANISM: Artificial
 <220> FEATURE:
 <223> OTHER INFORMATION: synthetic oligonucleotide
 <220> FEATURE:
 <221> NAME/KEY: modified_base
 <222> LOCATION: (2)..(2)
 <223> OTHER INFORMATION: n represents iso-cytosine
 <220> FEATURE:
 <221> NAME/KEY: modified_base
 <222> LOCATION: (6)..(6)
 <223> OTHER INFORMATION: n represents iso-cytosine

 <400> SEQUENCE: 40

cnaggaacc

10

-continued

<210> SEQ ID NO 41
 <211> LENGTH: 10
 <212> TYPE: DNA
 <213> ORGANISM: Artificial
 <220> FEATURE:
 <223> OTHER INFORMATION: synthetic oligonucleotide
 <220> FEATURE:
 <221> NAME/KEY: modified_base
 <222> LOCATION: (2)..(2)
 <223> OTHER INFORMATION: n represents iso-cytosine
 <220> FEATURE:
 <221> NAME/KEY: modified_base
 <222> LOCATION: (6)..(6)
 <223> OTHER INFORMATION: n represents iso-cytosine
 <220> FEATURE:
 <221> NAME/KEY: modified_base
 <222> LOCATION: (9)..(9)
 <223> OTHER INFORMATION: n represents iso-cytosine

 <400> SEQUENCE: 41

cnagangang

10

<210> SEQ ID NO 42
 <211> LENGTH: 9
 <212> TYPE: DNA
 <213> ORGANISM: Artificial
 <220> FEATURE:
 <223> OTHER INFORMATION: synthetic oligonucleotide
 <220> FEATURE:
 <221> NAME/KEY: modified_base
 <222> LOCATION: (3)..(3)
 <223> OTHER INFORMATION: n represents iso-cytosine
 <220> FEATURE:
 <221> NAME/KEY: modified_base
 <222> LOCATION: (6)..(6)
 <223> OTHER INFORMATION: n represents iso-cytosine

 <400> SEQUENCE: 42

cgntgngtc

9

<210> SEQ ID NO 43
 <211> LENGTH: 10
 <212> TYPE: DNA
 <213> ORGANISM: Artificial
 <220> FEATURE:
 <223> OTHER INFORMATION: synthetic oligonucleotide
 <220> FEATURE:
 <221> NAME/KEY: modified_base
 <222> LOCATION: (4)..(4)
 <223> OTHER INFORMATION: n represents iso-cytosine
 <220> FEATURE:
 <221> NAME/KEY: modified_base
 <222> LOCATION: (8)..(8)
 <223> OTHER INFORMATION: n represents iso-cytosine

 <400> SEQUENCE: 43

cagncgttag

10

<210> SEQ ID NO 44
 <211> LENGTH: 10
 <212> TYPE: DNA
 <213> ORGANISM: Artificial
 <220> FEATURE:
 <223> OTHER INFORMATION: synthetic oligonucleotide
 <220> FEATURE:
 <221> NAME/KEY: modified_base
 <222> LOCATION: (5)..(5)
 <223> OTHER INFORMATION: n represents iso-cytosine
 <220> FEATURE:
 <221> NAME/KEY: modified_base
 <222> LOCATION: (8)..(8)
 <223> OTHER INFORMATION: n represents iso-cytosine

-continued

<220> FEATURE:

<400> SEQUENCE: 44

ggctntgnac

10

<210> SEQ ID NO 45

<211> LENGTH: 10

<212> TYPE: DNA

<213> ORGANISM: Artificial

<220> FEATURE:

<223> OTHER INFORMATION: synthetic oligonucleotide

<220> FEATURE:

<221> NAME/KEY: modified_base

<222> LOCATION: (5)..(5)

<223> OTHER INFORMATION: n represents iso-cytosine

<220> FEATURE:

<221> NAME/KEY: modified_base

<222> LOCATION: (7)..(7)

<223> OTHER INFORMATION: n represents iso-cytosine

<400> SEQUENCE: 45

ccagnngaag

10

<210> SEQ ID NO 46

<211> LENGTH: 10

<212> TYPE: DNA

<213> ORGANISM: Artificial

<220> FEATURE:

<223> OTHER INFORMATION: synthetic oligonucleotide

<220> FEATURE:

<221> NAME/KEY: modified_base

<222> LOCATION: (4)..(4)

<223> OTHER INFORMATION: n represent iso-cytosine

<220> FEATURE:

<221> NAME/KEY: modified_base

<222> LOCATION: (8)..(8)

<223> OTHER INFORMATION: n represent iso-cytosine

<400> SEQUENCE: 46

ggcnaatngc

10

<210> SEQ ID NO 47

<211> LENGTH: 9

<212> TYPE: DNA

<213> ORGANISM: Artificial

<220> FEATURE:

<223> OTHER INFORMATION: synthetic oligonucleotide

<220> FEATURE:

<221> NAME/KEY: modified_base

<222> LOCATION: (2)..(2)

<223> OTHER INFORMATION: n represents iso-cytosine

<220> FEATURE:

<221> NAME/KEY: modified_base

<222> LOCATION: (7)..(7)

<223> OTHER INFORMATION: n represents iso-cytosine

<400> SEQUENCE: 47

gnctgcnng

9

<210> SEQ ID NO 48

<211> LENGTH: 10

<212> TYPE: DNA

<213> ORGANISM: Artificial

<220> FEATURE:

<223> OTHER INFORMATION: synthetic oligonucleotide

<220> FEATURE:

<221> NAME/KEY: modified_base

<222> LOCATION: (3)..(3)

<223> OTHER INFORMATION: n represents iso-cytosine

<220> FEATURE:

<221> NAME/KEY: modified_base

<222> LOCATION: (6)..(6)

-continued

<223> OTHER INFORMATION: n represents iso-cytosine

<400> SEQUENCE: 48

ganctnccggc

10

<210> SEQ ID NO 49

<211> LENGTH: 10

<212> TYPE: DNA

<213> ORGANISM: Artificial

<220> FEATURE:

<223> OTHER INFORMATION: synthetic oligonucleotide

<220> FEATURE:

<221> NAME/KEY: modified_base

<222> LOCATION: (3)..(3)

<223> OTHER INFORMATION: n represents iso-cytosine

<220> FEATURE:

<221> NAME/KEY: modified_base

<222> LOCATION: (7)..(7)

<223> OTHER INFORMATION: n represents iso-cytosine

<400> SEQUENCE: 49

gtncganggg

10

<210> SEQ ID NO 50

<211> LENGTH: 10

<212> TYPE: DNA

<213> ORGANISM: Artificial

<220> FEATURE:

<223> OTHER INFORMATION: synthetic oligonucleotide

<220> FEATURE:

<221> NAME/KEY: modified_base

<222> LOCATION: (3)..(3)

<223> OTHER INFORMATION: n represents iso-cytosine

<220> FEATURE:

<221> NAME/KEY: modified_base

<222> LOCATION: (4)..(4)

<223> OTHER INFORMATION: n represents iso-cytosine

<220> FEATURE:

<221> NAME/KEY: modified_base

<222> LOCATION: (9)..(9)

<223> OTHER INFORMATION: n represents iso-cytosine

<400> SEQUENCE: 50

ggnatccng

10

<210> SEQ ID NO 51

<211> LENGTH: 10

<212> TYPE: DNA

<213> ORGANISM: Artificial

<220> FEATURE:

<223> OTHER INFORMATION: synthetic oligonucleotide

<220> FEATURE:

<221> NAME/KEY: modified_base

<222> LOCATION: (2)..(2)

<223> OTHER INFORMATION: n represents iso-cytosine

<220> FEATURE:

<221> NAME/KEY: modified_base

<222> LOCATION: (7)..(7)

<223> OTHER INFORMATION: n represents iso-cytosine

<400> SEQUENCE: 51

gncttcnatg

10

<210> SEQ ID NO 52

<211> LENGTH: 10

<212> TYPE: DNA

<213> ORGANISM: Artificial

<220> FEATURE:

<223> OTHER INFORMATION: synthetic oligonucleotide

<220> FEATURE:

<221> NAME/KEY: modified_base

<222> LOCATION: (2)..(2)

-continued

<223> OTHER INFORMATION: n represents iso-cytosine
 <220> FEATURE:
 <221> NAME/KEY: modified_base
 <222> LOCATION: (7)..(7)
 <223> OTHER INFORMATION: n represents iso-cytosine
 <220> FEATURE:
 <221> NAME/KEY: modified_base
 <222> LOCATION: (8)..(8)
 <223> OTHER INFORMATION: n represents iso-cytosine

<400> SEQUENCE: 52

cntcttnncc

10

<210> SEQ ID NO 53
 <211> LENGTH: 10
 <212> TYPE: DNA
 <213> ORGANISM: Artificial
 <220> FEATURE:
 <223> OTHER INFORMATION: synthetic oligonucleotide
 <220> FEATURE:
 <221> NAME/KEY: modified_base
 <222> LOCATION: (5)..(5)
 <223> OTHER INFORMATION: n represents iso-cytosine
 <220> FEATURE:
 <221> NAME/KEY: modified_base
 <222> LOCATION: (7)..(7)
 <223> OTHER INFORMATION: n represents iso-cytosine

<400> SEQUENCE: 53

ctctnanccc

10

<210> SEQ ID NO 54
 <211> LENGTH: 10
 <212> TYPE: DNA
 <213> ORGANISM: Artificial
 <220> FEATURE:
 <223> OTHER INFORMATION: synthetic oligonucleotide
 <220> FEATURE:
 <221> NAME/KEY: modified_base
 <222> LOCATION: (4)..(4)
 <223> OTHER INFORMATION: n represents iso-cytosine
 <220> FEATURE:
 <221> NAME/KEY: modified_base
 <222> LOCATION: (9)..(9)
 <223> OTHER INFORMATION: n represents iso-cytosine

<400> SEQUENCE: 54

ctcntggtnc

10

<210> SEQ ID NO 55
 <211> LENGTH: 10
 <212> TYPE: DNA
 <213> ORGANISM: Artificial
 <220> FEATURE:
 <223> OTHER INFORMATION: synthetic oligonucleotide
 <220> FEATURE:
 <221> NAME/KEY: modified_base
 <222> LOCATION: (2)..(2)
 <223> OTHER INFORMATION: n represents iso-cytosine
 <220> FEATURE:
 <221> NAME/KEY: modified_base
 <222> LOCATION: (7)..(7)
 <223> OTHER INFORMATION: n represents iso-cytosine

<400> SEQUENCE: 55

gncaaancac

10

<210> SEQ ID NO 56
 <211> LENGTH: 10
 <212> TYPE: DNA
 <213> ORGANISM: Artificial
 <220> FEATURE:

-continued

```

<223> OTHER INFORMATION: synthetic oligonucleotide
<220> FEATURE:
<221> NAME/KEY: modified_base
<222> LOCATION: (4)..(4)
<223> OTHER INFORMATION: n represents iso-cytosine
<220> FEATURE:
<221> NAME/KEY: modified_base
<222> LOCATION: (7)..(7)
<223> OTHER INFORMATION: n represents iso-cytosine

```

```

<400> SEQUENCE: 56

```

```

gtnngcnttg

```

10

```

<210> SEQ ID NO 57
<211> LENGTH: 10
<212> TYPE: DNA
<213> ORGANISM: Artificial
<220> FEATURE:
<223> OTHER INFORMATION: synthetic oligonucleotide
<220> FEATURE:
<221> NAME/KEY: modified_base
<222> LOCATION: (2)..(2)
<223> OTHER INFORMATION: n represents iso-cytosine
<220> FEATURE:
<221> NAME/KEY: modified_base
<222> LOCATION: (4)..(4)
<223> OTHER INFORMATION: n represents iso-cytosine
<220> FEATURE:
<221> NAME/KEY: modified_base
<222> LOCATION: (6)..(6)
<223> OTHER INFORMATION: n represents iso-cytosine

```

```

<400> SEQUENCE: 57

```

```

cncntncaac

```

10

```

<210> SEQ ID NO 58
<211> LENGTH: 10
<212> TYPE: DNA
<213> ORGANISM: Artificial
<220> FEATURE:
<223> OTHER INFORMATION: synthetic oligonucleotide
<220> FEATURE:
<221> NAME/KEY: modified_base
<222> LOCATION: (3)..(3)
<223> OTHER INFORMATION: n represents iso-cytosine
<220> FEATURE:
<221> NAME/KEY: modified_base
<222> LOCATION: (4)..(4)
<223> OTHER INFORMATION: n represents iso-cytosine
<220> FEATURE:
<221> NAME/KEY: modified_base
<222> LOCATION: (8)..(8)
<223> OTHER INFORMATION: n represents iso-cytosine
<220> FEATURE:
<221> NAME/KEY: modified_base
<222> LOCATION: (9)..(9)
<223> OTHER INFORMATION: n represents iso-cytosine

```

```

<400> SEQUENCE: 58

```

```

ctnnacannc

```

10

```

<210> SEQ ID NO 59
<211> LENGTH: 10
<212> TYPE: DNA
<213> ORGANISM: Artificial
<220> FEATURE:
<223> OTHER INFORMATION: synthetic oligonucleotide
<220> FEATURE:
<221> NAME/KEY: modified_base
<222> LOCATION: (2)..(2)
<223> OTHER INFORMATION: n represents iso-cytosine
<220> FEATURE:
<221> NAME/KEY: modified_base
<222> LOCATION: (7)..(7)

```

-continued

<223> OTHER INFORMATION: n represents iso-cytosine

<400> SEQUENCE: 59

cnactcnacc

10

<210> SEQ ID NO 60

<211> LENGTH: 10

<212> TYPE: DNA

<213> ORGANISM: Artificial

<220> FEATURE:

<223> OTHER INFORMATION: synthetic oligonucleotide

<220> FEATURE:

<221> NAME/KEY: modified_base

<222> LOCATION: (4)..(4)

<223> OTHER INFORMATION: n represents iso-cytosine

<220> FEATURE:

<221> NAME/KEY: modified_base

<222> LOCATION: (7)..(7)

<223> OTHER INFORMATION: n represents iso-cytosine

<220> FEATURE:

<221> NAME/KEY: modified_base

<222> LOCATION: (8)..(8)

<223> OTHER INFORMATION: n represents iso-cytosine

<400> SEQUENCE: 60

gacncanmtg

10

<210> SEQ ID NO 61

<211> LENGTH: 10

<212> TYPE: DNA

<213> ORGANISM: Artificial

<220> FEATURE:

<223> OTHER INFORMATION: synthetic oligonucleotide

<220> FEATURE:

<221> NAME/KEY: modified_base

<222> LOCATION: (4)..(4)

<223> OTHER INFORMATION: n represents iso-cytosine

<220> FEATURE:

<221> NAME/KEY: modified_base

<222> LOCATION: (7)..(7)

<223> OTHER INFORMATION: n represents iso-cytosine

<400> SEQUENCE: 61

ctcnctnacg

10

<210> SEQ ID NO 62

<211> LENGTH: 10

<212> TYPE: DNA

<213> ORGANISM: Artificial

<220> FEATURE:

<223> OTHER INFORMATION: synthetic oligonucleotide

<220> FEATURE:

<221> NAME/KEY: modified_base

<222> LOCATION: (5)..(5)

<223> OTHER INFORMATION: n represents iso-cytosine

<220> FEATURE:

<221> NAME/KEY: modified_base

<222> LOCATION: (8)..(8)

<223> OTHER INFORMATION: n represents iso-cytosine

<400> SEQUENCE: 62

gtggncntnc

10

<210> SEQ ID NO 63

<211> LENGTH: 10

<212> TYPE: DNA

<213> ORGANISM: Artificial

<220> FEATURE:

<223> OTHER INFORMATION: synthetic oligonucleotide

<220> FEATURE:

<221> NAME/KEY: modified_base

<222> LOCATION: (3)..(3)

-continued

<223> OTHER INFORMATION: n represents iso-cytosine
 <220> FEATURE:
 <221> NAME/KEY: modified_base
 <222> LOCATION: (4)..(4)
 <223> OTHER INFORMATION: n represents iso-cytosine
 <220> FEATURE:
 <221> NAME/KEY: modified_base
 <222> LOCATION: (8)..(8)
 <223> OTHER INFORMATION: n represents iso-cytosine

<400> SEQUENCE: 63

cannaccnag

10

<210> SEQ ID NO 64
 <211> LENGTH: 10
 <212> TYPE: DNA
 <213> ORGANISM: Artificial
 <220> FEATURE:
 <223> OTHER INFORMATION: synthetic oligonucleotide
 <220> FEATURE:
 <221> NAME/KEY: modified_base
 <222> LOCATION: (3)..(3)
 <223> OTHER INFORMATION: n represents iso-cytosine
 <220> FEATURE:
 <221> NAME/KEY: modified_base
 <222> LOCATION: (5)..(5)
 <223> OTHER INFORMATION: n represents iso-cytosine
 <220> FEATURE:
 <221> NAME/KEY: modified_base
 <222> LOCATION: (7)..(7)
 <223> OTHER INFORMATION: n represents iso-cytosine

<400> SEQUENCE: 64

gtncnanacc

10

<210> SEQ ID NO 65
 <211> LENGTH: 10
 <212> TYPE: DNA
 <213> ORGANISM: Artificial
 <220> FEATURE:
 <223> OTHER INFORMATION: synthetic oligonucleotide
 <220> FEATURE:
 <221> NAME/KEY: modified_base
 <222> LOCATION: (4)..(4)
 <223> OTHER INFORMATION: n represents iso-cytosine
 <220> FEATURE:
 <221> NAME/KEY: modified_base
 <222> LOCATION: (5)..(5)
 <223> OTHER INFORMATION: n represents iso-cytosine
 <220> FEATURE:
 <221> NAME/KEY: modified_base
 <222> LOCATION: (8)..(8)
 <223> OTHER INFORMATION: n represents iso-cytosine

<400> SEQUENCE: 65

cacnntgntc

10

<210> SEQ ID NO 66
 <211> LENGTH: 10
 <212> TYPE: DNA
 <213> ORGANISM: Artificial
 <220> FEATURE:
 <223> OTHER INFORMATION: synthetic oligonucleotide
 <220> FEATURE:
 <221> NAME/KEY: modified_base
 <222> LOCATION: (2)..(2)
 <223> OTHER INFORMATION: n represents iso-cytosine
 <220> FEATURE:
 <221> NAME/KEY: modified_base
 <222> LOCATION: (7)..(7)
 <223> OTHER INFORMATION: n represents iso-cytosine

<400> SEQUENCE: 66

-continued

gntcctngtc 10

<210> SEQ ID NO 67
 <211> LENGTH: 10
 <212> TYPE: DNA
 <213> ORGANISM: Artificial
 <220> FEATURE:
 <223> OTHER INFORMATION: synthetic oligonucleotide
 <220> FEATURE:
 <221> NAME/KEY: modified_base
 <222> LOCATION: (3)..(3)
 <223> OTHER INFORMATION: n represents iso-cytosine
 <220> FEATURE:
 <221> NAME/KEY: modified_base
 <222> LOCATION: (4)..(4)
 <223> OTHER INFORMATION: n represents iso-cytosine
 <220> FEATURE:
 <221> NAME/KEY: modified_base
 <222> LOCATION: (9)..(9)
 <223> OTHER INFORMATION: n represents iso-cytosine

 <400> SEQUENCE: 67

ccnmatgtng 10

<210> SEQ ID NO 68
 <211> LENGTH: 10
 <212> TYPE: DNA
 <213> ORGANISM: Artificial
 <220> FEATURE:
 <223> OTHER INFORMATION: synthetic oligonucleotide
 <220> FEATURE:
 <221> NAME/KEY: modified_base
 <222> LOCATION: (2)..(2)
 <223> OTHER INFORMATION: n represents iso-cytosine
 <220> FEATURE:
 <221> NAME/KEY: modified_base
 <222> LOCATION: (7)..(7)
 <223> OTHER INFORMATION: n represents iso-cytosine
 <220> FEATURE:
 <221> NAME/KEY: modified_base
 <222> LOCATION: (8)..(8)
 <223> OTHER INFORMATION: n represents iso-cytosine

 <400> SEQUENCE: 68

gnggttnntc 10

<210> SEQ ID NO 69
 <211> LENGTH: 10
 <212> TYPE: DNA
 <213> ORGANISM: Artificial
 <220> FEATURE:
 <223> OTHER INFORMATION: synthetic oligonucleotide
 <220> FEATURE:
 <221> NAME/KEY: modified_base
 <222> LOCATION: (2)..(2)
 <223> OTHER INFORMATION: n represents iso-cytosine
 <220> FEATURE:
 <221> NAME/KEY: modified_base
 <222> LOCATION: (6)..(6)
 <223> OTHER INFORMATION: n represents iso-cytosine

 <400> SEQUENCE: 69

cnccgnaatc 10

<210> SEQ ID NO 70
 <211> LENGTH: 10
 <212> TYPE: DNA
 <213> ORGANISM: Artificial
 <220> FEATURE:
 <223> OTHER INFORMATION: synthetic oligonucleotide
 <220> FEATURE:
 <221> NAME/KEY: modified_base
 <222> LOCATION: (2)..(2)

-continued

<223> OTHER INFORMATION: n represents iso-cytosine
 <220> FEATURE:
 <221> NAME/KEY: modified_base
 <222> LOCATION: (3)..(3)
 <223> OTHER INFORMATION: n represents iso-cytosine
 <220> FEATURE:
 <221> NAME/KEY: modified_base
 <222> LOCATION: (6)..(6)
 <223> OTHER INFORMATION: n represents iso-cytosine

<400> SEQUENCE: 70

gmnacnacac

10

<210> SEQ ID NO 71
 <211> LENGTH: 9
 <212> TYPE: DNA
 <213> ORGANISM: Artificial
 <220> FEATURE:
 <223> OTHER INFORMATION: synthetic oligonucleotide
 <220> FEATURE:
 <221> NAME/KEY: modified_base
 <222> LOCATION: (3)..(3)
 <223> OTHER INFORMATION: n represents iso-cytosine
 <220> FEATURE:
 <221> NAME/KEY: modified_base
 <222> LOCATION: (5)..(5)
 <223> OTHER INFORMATION: n represents iso-cytosine
 <220> FEATURE:
 <221> NAME/KEY: modified_base
 <222> LOCATION: (8)..(8)
 <223> OTHER INFORMATION: n represents iso-cytosine

<400> SEQUENCE: 71

gcnngtnc

9

<210> SEQ ID NO 72
 <211> LENGTH: 9
 <212> TYPE: DNA
 <213> ORGANISM: Artificial
 <220> FEATURE:
 <223> OTHER INFORMATION: synthetic oligonucleotide
 <220> FEATURE:
 <221> NAME/KEY: modified_base
 <222> LOCATION: (2)..(2)
 <223> OTHER INFORMATION: n represents iso-cytosine
 <220> FEATURE:
 <221> NAME/KEY: modified_base
 <222> LOCATION: (4)..(4)
 <223> OTHER INFORMATION: n represents iso-cytosine
 <220> FEATURE:
 <221> NAME/KEY: modified_base
 <222> LOCATION: (8)..(8)
 <223> OTHER INFORMATION: n represents iso-cytosine

<400> SEQUENCE: 72

gncngganc

9

<210> SEQ ID NO 73
 <211> LENGTH: 10
 <212> TYPE: DNA
 <213> ORGANISM: Artificial
 <220> FEATURE:
 <223> OTHER INFORMATION: synthetic oligonucleotide
 <220> FEATURE:
 <221> NAME/KEY: modified_base
 <222> LOCATION: (4)..(4)
 <223> OTHER INFORMATION: n represents iso-cytosine
 <220> FEATURE:
 <221> NAME/KEY: modified_base
 <222> LOCATION: (9)..(9)
 <223> OTHER INFORMATION: n represents iso-cytosine

<400> SEQUENCE: 73

-continued

 cganagcanc 10

<210> SEQ ID NO 74
 <211> LENGTH: 10
 <212> TYPE: DNA
 <213> ORGANISM: Artificial
 <220> FEATURE:
 <223> OTHER INFORMATION: synthetic oligonucleotide
 <220> FEATURE:
 <221> NAME/KEY: modified_base
 <222> LOCATION: (5)..(5)
 <223> OTHER INFORMATION: n represents iso-cytosine
 <220> FEATURE:
 <221> NAME/KEY: modified_base
 <222> LOCATION: (9)..(9)
 <223> OTHER INFORMATION: n represents iso-cytosine

 <400> SEQUENCE: 74

cccantccnc 10

<210> SEQ ID NO 75
 <211> LENGTH: 10
 <212> TYPE: DNA
 <213> ORGANISM: Artificial
 <220> FEATURE:
 <223> OTHER INFORMATION: synthetic oligonucleotide
 <220> FEATURE:
 <221> NAME/KEY: modified_base
 <222> LOCATION: (3)..(3)
 <223> OTHER INFORMATION: n represents iso-cytosine
 <220> FEATURE:
 <221> NAME/KEY: modified_base
 <222> LOCATION: (6)..(6)
 <223> OTHER INFORMATION: n represents iso-cytosine
 <220> FEATURE:
 <221> NAME/KEY: modified_base
 <222> LOCATION: (7)..(7)
 <223> OTHER INFORMATION: n represents iso-cytosine

 <400> SEQUENCE: 75

gtncncncag 10

<210> SEQ ID NO 76
 <211> LENGTH: 10
 <212> TYPE: DNA
 <213> ORGANISM: Artificial
 <220> FEATURE:
 <223> OTHER INFORMATION: synthetic oligonucleotide
 <220> FEATURE:
 <221> NAME/KEY: modified_base
 <222> LOCATION: (2)..(2)
 <223> OTHER INFORMATION: n represents iso-cytosine
 <220> FEATURE:
 <221> NAME/KEY: modified_base
 <222> LOCATION: (7)..(7)
 <223> OTHER INFORMATION: n represents iso-cytosine

 <400> SEQUENCE: 76

cncctancgg 10

<210> SEQ ID NO 77
 <211> LENGTH: 9
 <212> TYPE: DNA
 <213> ORGANISM: Artificial
 <220> FEATURE:
 <223> OTHER INFORMATION: synthetic oligonucleotide
 <220> FEATURE:
 <221> NAME/KEY: modified_base
 <222> LOCATION: (2)..(2)
 <223> OTHER INFORMATION: n represents iso-cytosine
 <220> FEATURE:
 <221> NAME/KEY: modified_base
 <222> LOCATION: (7)..(7)

-continued

<223> OTHER INFORMATION: n represents iso-cytosine

<400> SEQUENCE: 77

gngttgncg

9

<210> SEQ ID NO 78

<211> LENGTH: 10

<212> TYPE: DNA

<213> ORGANISM: Artificial

<220> FEATURE:

<223> OTHER INFORMATION: synthetic oligonucleotide

<220> FEATURE:

<221> NAME/KEY: modified_base

<222> LOCATION: (2)..(2)

<223> OTHER INFORMATION: n represents iso-cytosine

<220> FEATURE:

<221> NAME/KEY: modified_base

<222> LOCATION: (6)..(6)

<223> OTHER INFORMATION: n represents iso-cytosine

<220> FEATURE:

<221> NAME/KEY: modified_base

<222> LOCATION: (8)..(8)

<223> OTHER INFORMATION: n represents iso-cytosine

<400> SEQUENCE: 78

cnaagnancg

10

<210> SEQ ID NO 79

<211> LENGTH: 10

<212> TYPE: DNA

<213> ORGANISM: Artificial

<220> FEATURE:

<223> OTHER INFORMATION: synthetic oligonucleotide

<220> FEATURE:

<221> NAME/KEY: modified_base

<222> LOCATION: (5)..(5)

<223> OTHER INFORMATION: n represents iso-cytosine

<220> FEATURE:

<221> NAME/KEY: modified_base

<222> LOCATION: (7)..(7)

<223> OTHER INFORMATION: n represents iso-cytosine

<220> FEATURE:

<221> NAME/KEY: modified_base

<222> LOCATION: (8)..(8)

<223> OTHER INFORMATION: n represents iso-cytosine

<400> SEQUENCE: 79

ggagncntc

10

<210> SEQ ID NO 80

<211> LENGTH: 10

<212> TYPE: DNA

<213> ORGANISM: Artificial

<220> FEATURE:

<223> OTHER INFORMATION: synthetic oligonucleotide

<220> FEATURE:

<221> NAME/KEY: modified_base

<222> LOCATION: (2)..(2)

<223> OTHER INFORMATION: n represents iso-cytosine

<220> FEATURE:

<221> NAME/KEY: modified_base

<222> LOCATION: (4)..(4)

<223> OTHER INFORMATION: n represents iso-cytosine

<220> FEATURE:

<221> NAME/KEY: modified_base

<222> LOCATION: (6)..(6)

<223> OTHER INFORMATION: n represents iso-cytosine

<400> SEQUENCE: 80

cnngnangtac

10

<210> SEQ ID NO 81

-continued

<211> LENGTH: 10
 <212> TYPE: DNA
 <213> ORGANISM: Artificial
 <220> FEATURE:
 <223> OTHER INFORMATION: synthetic oligonucleotide
 <220> FEATURE:
 <221> NAME/KEY: modified_base
 <222> LOCATION: (2)..(2)
 <223> OTHER INFORMATION: n represents iso-cytosine
 <220> FEATURE:
 <221> NAME/KEY: modified_base
 <222> LOCATION: (7)..(7)
 <223> OTHER INFORMATION: n represents iso-cytosine
 <220> FEATURE:
 <221> NAME/KEY: modified_base
 <222> LOCATION: (9)..(9)
 <223> OTHER INFORMATION: n represents iso-cytosine

 <400> SEQUENCE: 81

gnacgantng

10

<210> SEQ ID NO 82
 <211> LENGTH: 10
 <212> TYPE: DNA
 <213> ORGANISM: Artificial
 <220> FEATURE:
 <223> OTHER INFORMATION: synthetic oligonucleotide
 <220> FEATURE:
 <221> NAME/KEY: modified_base
 <222> LOCATION: (2)..(2)
 <223> OTHER INFORMATION: n represents iso-cytosine
 <220> FEATURE:
 <221> NAME/KEY: modified_base
 <222> LOCATION: (6)..(6)
 <223> OTHER INFORMATION: n represents iso-cytosine

 <400> SEQUENCE: 82

gngctncatg

10

<210> SEQ ID NO 83
 <211> LENGTH: 10
 <212> TYPE: DNA
 <213> ORGANISM: Artificial
 <220> FEATURE:
 <223> OTHER INFORMATION: synthetic oligonucleotide
 <220> FEATURE:
 <221> NAME/KEY: modified_base
 <222> LOCATION: (4)..(4)
 <223> OTHER INFORMATION: n represents iso-cytosine
 <220> FEATURE:
 <221> NAME/KEY: modified_base
 <222> LOCATION: (9)..(9)
 <223> OTHER INFORMATION: n represents iso-cytosine

 <400> SEQUENCE: 83

gtgnagagng

10

<210> SEQ ID NO 84
 <211> LENGTH: 9
 <212> TYPE: DNA
 <213> ORGANISM: Artificial
 <220> FEATURE:
 <223> OTHER INFORMATION: synthetic oligonucleotide
 <220> FEATURE:
 <221> NAME/KEY: modified_base
 <222> LOCATION: (5)..(5)
 <223> OTHER INFORMATION: n represents iso-cytosine
 <220> FEATURE:
 <221> NAME/KEY: modified_base
 <222> LOCATION: (7)..(7)
 <223> OTHER INFORMATION: n represents iso-cytosine

 <400> SEQUENCE: 84

-continued

gccgncntc

9

<210> SEQ ID NO 85
 <211> LENGTH: 10
 <212> TYPE: DNA
 <213> ORGANISM: Artificial
 <220> FEATURE:
 <223> OTHER INFORMATION: synthetic oligonucleotide
 <220> FEATURE:
 <221> NAME/KEY: modified_base
 <222> LOCATION: (4)..(4)
 <223> OTHER INFORMATION: n represents iso-cytosine
 <220> FEATURE:
 <221> NAME/KEY: modified_base
 <222> LOCATION: (7)..(7)
 <223> OTHER INFORMATION: n represents iso-cytosine

 <400> SEQUENCE: 85

caancgntcg

10

<210> SEQ ID NO 86
 <211> LENGTH: 10
 <212> TYPE: DNA
 <213> ORGANISM: Artificial
 <220> FEATURE:
 <223> OTHER INFORMATION: synthetic oligonucleotide
 <220> FEATURE:
 <221> NAME/KEY: modified_base
 <222> LOCATION: (5)..(5)
 <223> OTHER INFORMATION: n represents iso-cytosine
 <220> FEATURE:
 <221> NAME/KEY: modified_base
 <222> LOCATION: (8)..(8)
 <223> OTHER INFORMATION: n represents iso-cytosine

 <400> SEQUENCE: 86

cacanacngc

10

<210> SEQ ID NO 87
 <211> LENGTH: 9
 <212> TYPE: DNA
 <213> ORGANISM: Artificial
 <220> FEATURE:
 <223> OTHER INFORMATION: synthetic oligonucleotide
 <220> FEATURE:
 <221> NAME/KEY: modified_base
 <222> LOCATION: (2)..(2)
 <223> OTHER INFORMATION: n represents iso-cytosine
 <220> FEATURE:
 <221> NAME/KEY: modified_base
 <222> LOCATION: (6)..(6)
 <223> OTHER INFORMATION: n represents iso-cytosine
 <220> FEATURE:
 <221> NAME/KEY: modified_base
 <222> LOCATION: (7)..(7)
 <223> OTHER INFORMATION: n represents iso-cytosine

 <400> SEQUENCE: 87

gntggncg

9

<210> SEQ ID NO 88
 <211> LENGTH: 9
 <212> TYPE: DNA
 <213> ORGANISM: Artificial
 <220> FEATURE:
 <223> OTHER INFORMATION: synthetic oligonucleotide
 <220> FEATURE:
 <221> NAME/KEY: modified_base
 <222> LOCATION: (4)..(4)
 <223> OTHER INFORMATION: n represents iso-cytosine
 <220> FEATURE:
 <221> NAME/KEY: modified_base
 <222> LOCATION: (7)..(7)

-continued

<223> OTHER INFORMATION: n represents iso-cytosine

<400> SEQUENCE: 88

gccnccngt

9

<210> SEQ ID NO 89

<211> LENGTH: 10

<212> TYPE: DNA

<213> ORGANISM: Artificial

<220> FEATURE:

<223> OTHER INFORMATION: synthetic oligonucleotide

<220> FEATURE:

<221> NAME/KEY: modified_base

<222> LOCATION: (2)..(2)

<223> OTHER INFORMATION: n represents iso-cytosine

<220> FEATURE:

<221> NAME/KEY: modified_base

<222> LOCATION: (4)..(4)

<223> OTHER INFORMATION: n represents iso-cytosine

<220> FEATURE:

<221> NAME/KEY: modified_base

<222> LOCATION: (9)..(9)

<223> OTHER INFORMATION: n represents iso-cytosine

<400> SEQUENCE: 89

cnanggtcnc

10

<210> SEQ ID NO 90

<211> LENGTH: 9

<212> TYPE: DNA

<213> ORGANISM: Artificial

<220> FEATURE:

<223> OTHER INFORMATION: synthetic oligonucleotide

<220> FEATURE:

<221> NAME/KEY: modified_base

<222> LOCATION: (3)..(3)

<223> OTHER INFORMATION: n represents iso-cytosine

<220> FEATURE:

<221> NAME/KEY: modified_base

<222> LOCATION: (4)..(4)

<223> OTHER INFORMATION: n represents iso-cytosine

<220> FEATURE:

<221> NAME/KEY: modified_base

<222> LOCATION: (6)..(6)

<223> OTHER INFORMATION: n represents iso-cytosine

<400> SEQUENCE: 90

ccnngngtg

9

<210> SEQ ID NO 91

<211> LENGTH: 10

<212> TYPE: DNA

<213> ORGANISM: Artificial

<220> FEATURE:

<223> OTHER INFORMATION: synthetic oligonucleotide

<220> FEATURE:

<221> NAME/KEY: modified_base

<222> LOCATION: (3)..(3)

<223> OTHER INFORMATION: n represents iso-cytosine

<220> FEATURE:

<221> NAME/KEY: modified_base

<222> LOCATION: (6)..(6)

<223> OTHER INFORMATION: n represents iso-cytosine

<400> SEQUENCE: 91

ggnacnccag

10

<210> SEQ ID NO 92

<211> LENGTH: 10

<212> TYPE: DNA

<213> ORGANISM: Artificial

<220> FEATURE:

-continued

<223> OTHER INFORMATION: synthetic oligonucleotide
 <220> FEATURE:
 <221> NAME/KEY: modified_base
 <222> LOCATION: (5)..(5)
 <223> OTHER INFORMATION: n represents iso-cytosine
 <220> FEATURE:
 <221> NAME/KEY: modified_base
 <222> LOCATION: (7)..(7)
 <223> OTHER INFORMATION: n represents iso-cytosine

<400> SEQUENCE: 92

gcctncngac

10

<210> SEQ ID NO 93
 <211> LENGTH: 10
 <212> TYPE: DNA
 <213> ORGANISM: Artificial
 <220> FEATURE:
 <223> OTHER INFORMATION: synthetic oligonucleotide
 <220> FEATURE:
 <221> NAME/KEY: modified_base
 <222> LOCATION: (2)..(2)
 <223> OTHER INFORMATION: n represents iso-cytosine
 <220> FEATURE:
 <221> NAME/KEY: modified_base
 <222> LOCATION: (5)..(5)
 <223> OTHER INFORMATION: n represents iso-cytosine
 <220> FEATURE:
 <221> NAME/KEY: modified_base
 <222> LOCATION: (9)..(9)
 <223> OTHER INFORMATION: n represents iso-cytosine

<400> SEQUENCE: 93

cnttncgnc

10

<210> SEQ ID NO 94
 <211> LENGTH: 10
 <212> TYPE: DNA
 <213> ORGANISM: Artificial
 <220> FEATURE:
 <223> OTHER INFORMATION: synthetic oligonucleotide
 <220> FEATURE:
 <221> NAME/KEY: modified_base
 <222> LOCATION: (2)..(2)
 <223> OTHER INFORMATION: n represents iso-cytosine
 <220> FEATURE:
 <221> NAME/KEY: modified_base
 <222> LOCATION: (6)..(6)
 <223> OTHER INFORMATION: n represents iso-cytosine
 <220> FEATURE:
 <221> NAME/KEY: modified_base
 <222> LOCATION: (8)..(8)
 <223> OTHER INFORMATION: n represents iso-cytosine
 <220> FEATURE:
 <221> NAME/KEY: modified_base
 <222> LOCATION: (9)..(9)
 <223> OTHER INFORMATION: n represents iso-cytosine

<400> SEQUENCE: 94

cnctangnng

10

<210> SEQ ID NO 95
 <211> LENGTH: 9
 <212> TYPE: DNA
 <213> ORGANISM: Artificial
 <220> FEATURE:
 <223> OTHER INFORMATION: synthetic oligonucleotide
 <220> FEATURE:
 <221> NAME/KEY: modified_base
 <222> LOCATION: (2)..(2)
 <223> OTHER INFORMATION: n represents iso-cytosine
 <220> FEATURE:
 <221> NAME/KEY: modified_base
 <222> LOCATION: (5)..(5)

-continued

<223> OTHER INFORMATION: n represents iso-cytosine
 <220> FEATURE:
 <221> NAME/KEY: modified_base
 <222> LOCATION: (8)..(8)
 <223> OTHER INFORMATION: n represents iso-cytosine
 <400> SEQUENCE: 95

cngcnagng

9

<210> SEQ ID NO 96
 <211> LENGTH: 10
 <212> TYPE: DNA
 <213> ORGANISM: Artificial
 <220> FEATURE:
 <223> OTHER INFORMATION: synthetic oligonucleotide
 <220> FEATURE:
 <221> NAME/KEY: modified_base
 <222> LOCATION: (2)..(2)
 <223> OTHER INFORMATION: n represents iso-cytosine
 <220> FEATURE:
 <221> NAME/KEY: modified_base
 <222> LOCATION: (6)..(6)
 <223> OTHER INFORMATION: n represents iso-cytosine
 <400> SEQUENCE: 96

cnagcnacgg

10

<210> SEQ ID NO 97
 <211> LENGTH: 10
 <212> TYPE: DNA
 <213> ORGANISM: Artificial
 <220> FEATURE:
 <223> OTHER INFORMATION: synthetic oligonucleotide
 <220> FEATURE:
 <221> NAME/KEY: modified_base
 <222> LOCATION: (5)..(5)
 <223> OTHER INFORMATION: n represents iso-cytosine
 <220> FEATURE:
 <221> NAME/KEY: modified_base
 <222> LOCATION: (8)..(8)
 <223> OTHER INFORMATION: n represents iso-cytosine
 <400> SEQUENCE: 97

gacangcnc

10

<210> SEQ ID NO 98
 <211> LENGTH: 9
 <212> TYPE: DNA
 <213> ORGANISM: Artificial
 <220> FEATURE:
 <223> OTHER INFORMATION: synthetic oligonucleotide
 <220> FEATURE:
 <221> NAME/KEY: modified_base
 <222> LOCATION: (4)..(4)
 <223> OTHER INFORMATION: n represents iso-cytosine
 <220> FEATURE:
 <221> NAME/KEY: modified_base
 <222> LOCATION: (7)..(7)
 <223> OTHER INFORMATION: n represents iso-cytosine
 <220> FEATURE:
 <221> NAME/KEY: modified_base
 <222> LOCATION: (8)..(8)
 <223> OTHER INFORMATION: n represents iso-cytosine
 <400> SEQUENCE: 98

gggncgna

9

<210> SEQ ID NO 99
 <211> LENGTH: 10
 <212> TYPE: DNA
 <213> ORGANISM: Artificial
 <220> FEATURE:

-continued

<223> OTHER INFORMATION: synthetic oligonucleotide

<400> SEQUENCE: 99

gccagttaa 10

<210> SEQ ID NO 100

<211> LENGTH: 10

<212> TYPE: DNA

<213> ORGANISM: Artificial

<220> FEATURE:

<223> OTHER INFORMATION: synthetic oligonucleotide

<220> FEATURE:

<221> NAME/KEY: modified_base

<222> LOCATION: (5)..(5)

<223> OTHER INFORMATION: n represents iso-cytosine

<400> SEQUENCE: 100

gccanttaa 10

<210> SEQ ID NO 101

<211> LENGTH: 10

<212> TYPE: DNA

<213> ORGANISM: Artificial

<220> FEATURE:

<223> OTHER INFORMATION: synthetic oligonucleotide

<220> FEATURE:

<221> NAME/KEY: modified_base

<222> LOCATION: (3)..(3)

<223> OTHER INFORMATION: n represents iso-cytosine

<400> SEQUENCE: 101

gcnagttaa 10

<210> SEQ ID NO 102

<211> LENGTH: 10

<212> TYPE: DNA

<213> ORGANISM: Artificial

<220> FEATURE:

<223> OTHER INFORMATION: synthetic oligonucleotide

<220> FEATURE:

<221> NAME/KEY: modified_base

<222> LOCATION: (2)..(2)

<223> OTHER INFORMATION: n represents iso-guanine

<400> SEQUENCE: 102

gncagttaa 10

<210> SEQ ID NO 103

<211> LENGTH: 10

<212> TYPE: DNA

<213> ORGANISM: Artificial

<220> FEATURE:

<223> OTHER INFORMATION: synthetic oligonucleotide

<220> FEATURE:

<221> NAME/KEY: modified_base

<222> LOCATION: (2)..(2)

<223> OTHER INFORMATION: n represents iso-guanine

<220> FEATURE:

<221> NAME/KEY: modified_base

<222> LOCATION: (3)..(3)

<223> OTHER INFORMATION: n represents iso-guanine

<400> SEQUENCE: 103

gmnagttaa 10

<210> SEQ ID NO 104

<211> LENGTH: 154

<212> TYPE: DNA

<213> ORGANISM: Mus musculus

<300> PUBLICATION INFORMATION:

-continued

<308> DATABASE ACCESSION NUMBER: NT_039491.1
 <309> DATABASE ENTRY DATE: 2003-02-25
 <313> RELEVANT RESIDUES IN SEQ ID NO: (1729106)..(1729259)

<400> SEQUENCE: 104

agaaacaacc atctaataccc aactaaaat tcaaggctcc acagacgaaa cagtgaagaa 60
 taattgttca gcatactaac caactgatta catatctacc atactcaggt ttgtgcttca 120
 taaaaacca yagtcggcg ctccctgtta gatg 154

<210> SEQ ID NO 105
 <211> LENGTH: 61
 <212> TYPE: DNA
 <213> ORGANISM: Mus musculus
 <300> PUBLICATION INFORMATION:
 <308> DATABASE ACCESSION NUMBER: NT_039209.1
 <309> DATABASE ENTRY DATE: 2003-02-25
 <313> RELEVANT RESIDUES IN SEQ ID NO: (27172470)..(27172530)

<400> SEQUENCE: 105

cttctcccat tgcccagggc actctctctct gtagartaga ctgatytcttg tggagacatc 60
 a 61

<210> SEQ ID NO 106
 <211> LENGTH: 67
 <212> TYPE: DNA
 <213> ORGANISM: Mus musculus
 <300> PUBLICATION INFORMATION:
 <308> DATABASE ACCESSION NUMBER: NT_039473.1
 <309> DATABASE ENTRY DATE: 2003-02-25
 <313> RELEVANT RESIDUES IN SEQ ID NO: (532094)..(532160)

<400> SEQUENCE: 106

agtgcctgct acctgtcagg tgaaaatttc ttagtgatcc yaagctcaat ggggtgcyggc 60
 ttgcagg 67

<210> SEQ ID NO 107
 <211> LENGTH: 72
 <212> TYPE: DNA
 <213> ORGANISM: Mus musculus
 <300> PUBLICATION INFORMATION:
 <308> DATABASE ACCESSION NUMBER: NT_039674.1
 <309> DATABASE ENTRY DATE: 2003-02-25
 <313> RELEVANT RESIDUES IN SEQ ID NO: (46479067)..(46479138)

<400> SEQUENCE: 107

ggttggaatg tttgcacatg cagtgttagt tatttgggyg ataactactt agcttatcta 60
 gcctggteca gc 72

<210> SEQ ID NO 108
 <211> LENGTH: 80
 <212> TYPE: DNA
 <213> ORGANISM: Mus musculus
 <300> PUBLICATION INFORMATION:
 <308> DATABASE ACCESSION NUMBER: NT_039662.1
 <309> DATABASE ENTRY DATE: 2003-02-25
 <313> RELEVANT RESIDUES IN SEQ ID NO: (658679)..(658758)

<400> SEQUENCE: 108

ctgatctgac ctgactgt tgtgctaaca gatataaac cagtaagttg astcaaatac 60
 tgcaggaagt agagccttgc 80

<210> SEQ ID NO 109
 <211> LENGTH: 89
 <212> TYPE: DNA

-continued

<213> ORGANISM: Mus musculus
 <300> PUBLICATION INFORMATION:
 <308> DATABASE ACCESSION NUMBER: NT_039212.1
 <309> DATABASE ENTRY DATE: 2003-02-25
 <313> RELEVANT RESIDUES IN SEQ ID NO: (3887249)..(3887337)

<400> SEQUENCE: 109

gactgctgga gagctgaggg aggctgtgga gaataaggag agagcrtagt ctcgtgccct 60
 gccctgccc tactgagcag ccaagacac 89

<210> SEQ ID NO 110
 <211> LENGTH: 96
 <212> TYPE: DNA
 <213> ORGANISM: Mus musculus
 <300> PUBLICATION INFORMATION:
 <308> DATABASE ACCESSION NUMBER: NT_039586.1
 <309> DATABASE ENTRY DATE: 2003-02-25
 <313> RELEVANT RESIDUES IN SEQ ID NO: (6594595)..(6594690)

<400> SEQUENCE: 110

ggactgtcca aakggatctc aaggagaata gtccttgcta ttargagtat aaaggcataa 60
 aagaggtcat aggggacaac catgaccaag aagttg 96

<210> SEQ ID NO 111
 <211> LENGTH: 107
 <212> TYPE: DNA
 <213> ORGANISM: Mus musculus
 <300> PUBLICATION INFORMATION:
 <308> DATABASE ACCESSION NUMBER: NT_039551.1
 <309> DATABASE ENTRY DATE: 2003-02-25
 <313> RELEVANT RESIDUES IN SEQ ID NO: (15414183)..(15414289)

<400> SEQUENCE: 111

ccttctgca ytccacagta taaacacaga atgcacactg crgtcgttgt atttgtgttc 60
 gatgtgaatt aaagatgctt tggctaagcc aggagatgat aatactg 107

<210> SEQ ID NO 112
 <211> LENGTH: 129
 <212> TYPE: DNA
 <213> ORGANISM: Mus musculus
 <300> PUBLICATION INFORMATION:
 <308> DATABASE ACCESSION NUMBER: NT_039209.1
 <309> DATABASE ENTRY DATE: 2003-02-25
 <313> RELEVANT RESIDUES IN SEQ ID NO: (26992396)..(26992524)

<400> SEQUENCE: 112

cacatacacc atgtcagcca tcagcgcaaa gccttcgagt ttcagctgtg agatgaaggc 60
 ttggagaagc acgttgatct gcaaagaagc aaaggagcta gcggaggcyg gtcactgacc 120
 gactgctca 129

<210> SEQ ID NO 113
 <211> LENGTH: 18
 <212> TYPE: DNA
 <213> ORGANISM: Artificial
 <220> FEATURE:
 <223> OTHER INFORMATION: synthetic oligonucleotide

<400> SEQUENCE: 113

catctaacag ggagcgcc 18

<210> SEQ ID NO 114
 <211> LENGTH: 24
 <212> TYPE: DNA
 <213> ORGANISM: Artificial
 <220> FEATURE:

-continued

<223> OTHER INFORMATION: synthetic oligonucleotide
 <220> FEATURE:
 <221> NAME/KEY: modified_base
 <222> LOCATION: (1)..(1)
 <223> OTHER INFORMATION: n represents deoxythymidylate labeled with 6-carboxyfluorescein (6-FAM)

 <400> SEQUENCE: 114

 nagaacaac catctaatcc caca 24

 <210> SEQ ID NO 115
 <211> LENGTH: 19
 <212> TYPE: DNA
 <213> ORGANISM: Artificial
 <220> FEATURE:
 <223> OTHER INFORMATION: synthetic oligonucleotide
 <220> FEATURE:
 <221> NAME/KEY: modified_base
 <222> LOCATION: (1)..(1)
 <223> OTHER INFORMATION: n represents deoxythymidylate labeled with 6-carboxyfluorescein (6-FAM)

 <400> SEQUENCE: 115

 ncttctocca ttgccagg 19

 <210> SEQ ID NO 116
 <211> LENGTH: 23
 <212> TYPE: DNA
 <213> ORGANISM: Artificial
 <220> FEATURE:
 <223> OTHER INFORMATION: synthetic oligonucleotide

 <400> SEQUENCE: 116

 tgatgtctcc acaagatca gtc 23

 <210> SEQ ID NO 117
 <211> LENGTH: 19
 <212> TYPE: DNA
 <213> ORGANISM: Artificial
 <220> FEATURE:
 <223> OTHER INFORMATION: synthetic oligonucleotide

 <400> SEQUENCE: 117

 agtgctgct acctgtcag 19

 <210> SEQ ID NO 118
 <211> LENGTH: 17
 <212> TYPE: DNA
 <213> ORGANISM: Artificial
 <220> FEATURE:
 <223> OTHER INFORMATION: synthetic oligonucleotide
 <220> FEATURE:
 <221> NAME/KEY: modified_base
 <222> LOCATION: (1)..(1)
 <223> OTHER INFORMATION: n represents deoxythymidylate labeled with 6-carboxyfluorescein (6-FAM)

 <400> SEQUENCE: 118

 ncctgcaagc cagcacc 17

 <210> SEQ ID NO 119
 <211> LENGTH: 22
 <212> TYPE: DNA
 <213> ORGANISM: Artificial
 <220> FEATURE:
 <223> OTHER INFORMATION: synthetic oligonucleotide
 <220> FEATURE:
 <221> NAME/KEY: modified_base
 <222> LOCATION: (1)..(1)
 <223> OTHER INFORMATION: n represents deoxythymidylate labeled with 6-

-continued

carboxyfluorescein (6-FAM)

<400> SEQUENCE: 119

ngggttggat gtttgacat gc 22

<210> SEQ ID NO 120
 <211> LENGTH: 21
 <212> TYPE: DNA
 <213> ORGANISM: Artificial
 <220> FEATURE:
 <223> OTHER INFORMATION: synthetic oligonucleotide

<400> SEQUENCE: 120

gctggaccag gctagataag c 21

<210> SEQ ID NO 121
 <211> LENGTH: 23
 <212> TYPE: DNA
 <213> ORGANISM: Artificial
 <220> FEATURE:
 <223> OTHER INFORMATION: synthetic oligonucleotide
 <220> FEATURE:
 <221> NAME/KEY: modified_base
 <222> LOCATION: (1)..(1)
 <223> OTHER INFORMATION: n represents deoxythymidylate labeled with 6-carboxyfluorescein (6-FAM)

<400> SEQUENCE: 121

nctgatctga cctcagactg ttg 23

<210> SEQ ID NO 122
 <211> LENGTH: 19
 <212> TYPE: DNA
 <213> ORGANISM: Artificial
 <220> FEATURE:
 <223> OTHER INFORMATION: synthetic oligonucleotide

<400> SEQUENCE: 122

gcaaggctct acttctctgc 19

<210> SEQ ID NO 123
 <211> LENGTH: 20
 <212> TYPE: DNA
 <213> ORGANISM: Artificial
 <220> FEATURE:
 <223> OTHER INFORMATION: synthetic oligonucleotide
 <220> FEATURE:
 <221> NAME/KEY: modified_base
 <222> LOCATION: (1)..(1)
 <223> OTHER INFORMATION: n represents deoxythymidylate labeled with 6-carboxyfluorescein (6-FAM)

<400> SEQUENCE: 123

ngactgctgg agagctgagg 20

<210> SEQ ID NO 124
 <211> LENGTH: 21
 <212> TYPE: DNA
 <213> ORGANISM: Artificial
 <220> FEATURE:
 <223> OTHER INFORMATION: synthetic oligonucleotide

<400> SEQUENCE: 124

gtgtcttggc tgctcagat g 21

<210> SEQ ID NO 125
 <211> LENGTH: 21
 <212> TYPE: DNA

-continued

<213> ORGANISM: Artificial
 <220> FEATURE:
 <223> OTHER INFORMATION: synthetic oligonucleotide
 <220> FEATURE:
 <221> NAME/KEY: modified_base
 <222> LOCATION: (1)..(1)
 <223> OTHER INFORMATION: n represents deoxythymidylate labeled with 6-carboxyfluorescein (6-FAM)

 <400> SEQUENCE: 125

 nggactgtcc aaaggatct c 21

 <210> SEQ ID NO 126
 <211> LENGTH: 22
 <212> TYPE: DNA
 <213> ORGANISM: Artificial
 <220> FEATURE:
 <223> OTHER INFORMATION: synthetic oligonucleotide

 <400> SEQUENCE: 126

 caacttcttg gtcattggtg tc 22

 <210> SEQ ID NO 127
 <211> LENGTH: 19
 <212> TYPE: DNA
 <213> ORGANISM: Artificial
 <220> FEATURE:
 <223> OTHER INFORMATION: synthetic oligonucleotide
 <220> FEATURE:
 <221> NAME/KEY: modified_base
 <222> LOCATION: (1)..(1)
 <223> OTHER INFORMATION: n represents indodicarbocyanine 3-1-O-(2-cyanoethyl)-(N,N-diisopropyl)-phosphoramidite (Cy3)

 <400> SEQUENCE: 127

 nccttctgc aytccacag 19

 <210> SEQ ID NO 128
 <211> LENGTH: 26
 <212> TYPE: DNA
 <213> ORGANISM: Artificial
 <220> FEATURE:
 <223> OTHER INFORMATION: synthetic oligonucleotide
 <220> FEATURE:
 <221> NAME/KEY: modified_base
 <222> LOCATION: (1)..(1)
 <223> OTHER INFORMATION: n represents deoxythymidylate labeled with 6-carboxyfluorescein (6-FAM)

 <400> SEQUENCE: 128

 ncagtattat catctctgg ctttagc 26

 <210> SEQ ID NO 129
 <211> LENGTH: 20
 <212> TYPE: DNA
 <213> ORGANISM: Artificial
 <220> FEATURE:
 <223> OTHER INFORMATION: synthetic oligonucleotide
 <220> FEATURE:
 <221> NAME/KEY: modified_base
 <222> LOCATION: (1)..(1)
 <223> OTHER INFORMATION: n represents deoxythymidylate labeled with 6-carboxyfluorescein (6-FAM)

 <400> SEQUENCE: 129

 ncacatacac catgtcagcc 20

 <210> SEQ ID NO 130
 <211> LENGTH: 17
 <212> TYPE: DNA

-continued

<213> ORGANISM: Artificial
 <220> FEATURE:
 <223> OTHER INFORMATION: synthetic oligonucleotide

<400> SEQUENCE: 130

tgagcagtcg gtcagtg

17

<210> SEQ ID NO 131
 <211> LENGTH: 27
 <212> TYPE: DNA
 <213> ORGANISM: Artificial
 <220> FEATURE:
 <223> OTHER INFORMATION: synthetic oligonucleotide
 <220> FEATURE:
 <221> NAME/KEY: modified_base
 <222> LOCATION: (4)..(4)
 <223> OTHER INFORMATION: n represents iso-guanine
 <220> FEATURE:
 <221> NAME/KEY: modified_base
 <222> LOCATION: (8)..(8)
 <223> OTHER INFORMATION: n represents iso-guanine
 <220> FEATURE:
 <221> NAME/KEY: misc_feature
 <222> LOCATION: (10)..(11)
 <223> OTHER INFORMATION: an n-propylene spacer (c3) between these locations

<400> SEQUENCE: 131

gtgnacangc gttcataca aaccac

27

<210> SEQ ID NO 132
 <211> LENGTH: 27
 <212> TYPE: DNA
 <213> ORGANISM: Artificial
 <220> FEATURE:
 <223> OTHER INFORMATION: synthetic oligonucleotide
 <220> FEATURE:
 <221> NAME/KEY: modified_base
 <222> LOCATION: (4)..(4)
 <223> OTHER INFORMATION: n represents iso-guanine
 <220> FEATURE:
 <221> NAME/KEY: modified_base
 <222> LOCATION: (9)..(9)
 <223> OTHER INFORMATION: n represents iso-guanine
 <220> FEATURE:
 <221> NAME/KEY: misc_feature
 <222> LOCATION: (10)..(11)
 <223> OTHER INFORMATION: an n-propylene spacer (c3) between these locations

<400> SEQUENCE: 132

cgantctgnc gttcataca aaccat

27

<210> SEQ ID NO 133
 <211> LENGTH: 27
 <212> TYPE: DNA
 <213> ORGANISM: Artificial
 <220> FEATURE:
 <223> OTHER INFORMATION: synthetic oligonucleotide
 <220> FEATURE:
 <221> NAME/KEY: modified_base
 <222> LOCATION: (4)..(4)
 <223> OTHER INFORMATION: n represents iso-guanine
 <220> FEATURE:
 <221> NAME/KEY: modified_base
 <222> LOCATION: (8)..(8)
 <223> OTHER INFORMATION: n represents iso-guanine
 <220> FEATURE:
 <221> NAME/KEY: misc_feature
 <222> LOCATION: (10)..(11)
 <223> OTHER INFORMATION: an n-propylene spacer (c3) between these locations

<400> SEQUENCE: 133

-continued

ctancaance cactctcctc tgtagaa

27

<210> SEQ ID NO 134
 <211> LENGTH: 27
 <212> TYPE: DNA
 <213> ORGANISM: Artificial
 <220> FEATURE:
 <223> OTHER INFORMATION: synthetic oligonucleotide
 <220> FEATURE:
 <221> NAME/KEY: modified_base
 <222> LOCATION: (5)..(5)
 <223> OTHER INFORMATION: n represents iso-guanine
 <220> FEATURE:
 <221> NAME/KEY: modified_base
 <222> LOCATION: (7)..(7)
 <223> OTHER INFORMATION: n represents iso-guanine
 <220> FEATURE:
 <221> NAME/KEY: misc_feature
 <222> LOCATION: (10)..(11)
 <223> OTHER INFORMATION: an n-propylene spacer (c3) between these locations

 <400> SEQUENCE: 134

gagancnaag cactctcctc tgtagag

27

<210> SEQ ID NO 135
 <211> LENGTH: 30
 <212> TYPE: DNA
 <213> ORGANISM: Artificial
 <220> FEATURE:
 <223> OTHER INFORMATION: synthetic oligonucleotide
 <220> FEATURE:
 <221> NAME/KEY: modified_base
 <222> LOCATION: (5)..(5)
 <223> OTHER INFORMATION: n represents iso-guanine
 <220> FEATURE:
 <221> NAME/KEY: modified_base
 <222> LOCATION: (9)..(9)
 <223> OTHER INFORMATION: n represents iso-guanine
 <220> FEATURE:
 <221> NAME/KEY: misc_feature
 <222> LOCATION: (10)..(11)
 <223> OTHER INFORMATION: an n-propylene spacer (c3) between these locations

 <400> SEQUENCE: 135

gttcntgang gaaaatttct tagtgatcct

30

<210> SEQ ID NO 136
 <211> LENGTH: 29
 <212> TYPE: DNA
 <213> ORGANISM: Artificial
 <220> FEATURE:
 <223> OTHER INFORMATION: synthetic oligonucleotide
 <220> FEATURE:
 <221> NAME/KEY: modified_base
 <222> LOCATION: (3)..(3)
 <223> OTHER INFORMATION: n represents iso-guanine
 <220> FEATURE:
 <221> NAME/KEY: modified_base
 <222> LOCATION: (6)..(6)
 <223> OTHER INFORMATION: n represents iso-guanine
 <220> FEATURE:
 <221> NAME/KEY: misc_feature
 <222> LOCATION: (10)..(11)
 <223> OTHER INFORMATION: an n-propylene spacer (c3) between these locations

 <400> SEQUENCE: 136

gcntanctac aaaatttctt agtgatccc

29

<210> SEQ ID NO 137

-continued

```

<211> LENGTH: 28
<212> TYPE: DNA
<213> ORGANISM: Artificial
<220> FEATURE:
<223> OTHER INFORMATION: synthetic oligonucleotide
<220> FEATURE:
<221> NAME/KEY: modified_base
<222> LOCATION: (5)..(5)
<223> OTHER INFORMATION: n represents iso-guanine
<220> FEATURE:
<221> NAME/KEY: modified_base
<222> LOCATION: (7)..(7)
<223> OTHER INFORMATION: n represents iso-guanine
<220> FEATURE:
<221> NAME/KEY: misc_feature
<222> LOCATION: (10)..(11)
<223> OTHER INFORMATION: an n-propylene spacer (c3) between these
    locations

<400> SEQUENCE: 137

gttancntcc agtgtagtt atttgggt                28

```

```

<210> SEQ ID NO 138
<211> LENGTH: 27
<212> TYPE: DNA
<213> ORGANISM: Artificial
<220> FEATURE:
<223> OTHER INFORMATION: synthetic oligonucleotide
<220> FEATURE:
<221> NAME/KEY: modified_base
<222> LOCATION: (4)..(4)
<223> OTHER INFORMATION: n represents iso-guanine
<220> FEATURE:
<221> NAME/KEY: modified_base
<222> LOCATION: (9)..(9)
<223> OTHER INFORMATION: n represents iso-guanine
<220> FEATURE:
<221> NAME/KEY: misc_feature
<222> LOCATION: (10)..(11)
<223> OTHER INFORMATION: an n-propylene spacer (c3) between these
    locations

<400> SEQUENCE: 138

cacnatacng gtgtagtta tttgggc                27

```

```

<210> SEQ ID NO 139
<211> LENGTH: 28
<212> TYPE: DNA
<213> ORGANISM: Artificial
<220> FEATURE:
<223> OTHER INFORMATION: synthetic oligonucleotide
<220> FEATURE:
<221> NAME/KEY: modified_base
<222> LOCATION: (2)..(2)
<223> OTHER INFORMATION: n represents iso-guanine
<220> FEATURE:
<221> NAME/KEY: modified_base
<222> LOCATION: (7)..(7)
<223> OTHER INFORMATION: n represents iso-guanine
<220> FEATURE:
<221> NAME/KEY: misc_feature
<222> LOCATION: (10)..(11)
<223> OTHER INFORMATION: an n-propylene spacer (c3) between these
    locations

<400> SEQUENCE: 139

cntaccnatg taacaccagt aagttgac                28

```

```

<210> SEQ ID NO 140
<211> LENGTH: 28
<212> TYPE: DNA
<213> ORGANISM: Artificial
<220> FEATURE:
<223> OTHER INFORMATION: synthetic oligonucleotide

```

-continued

```

<220> FEATURE:
<221> NAME/KEY: modified_base
<222> LOCATION: (2)..(2)
<223> OTHER INFORMATION: n represents iso-guanine
<220> FEATURE:
<221> NAME/KEY: modified_base
<222> LOCATION: (6)..(6)
<223> OTHER INFORMATION: n represents iso-guanine
<220> FEATURE:
<221> NAME/KEY: misc_feature
<222> LOCATION: (10)..(11)
<223> OTHER INFORMATION: an n-propylene spacer (c3) between these
    locations

<400> SEQUENCE: 140

gncganaatc taacaccagt aagttgag                28

<210> SEQ ID NO 141
<211> LENGTH: 27
<212> TYPE: DNA
<213> ORGANISM: Artificial
<220> FEATURE:
<223> OTHER INFORMATION: synthetic oligonucleotide
<220> FEATURE:
<221> NAME/KEY: modified_base
<222> LOCATION: (2)..(2)
<223> OTHER INFORMATION: n represents iso-guanine
<220> FEATURE:
<221> NAME/KEY: modified_base
<222> LOCATION: (7)..(7)
<223> OTHER INFORMATION: n represents iso-guanine
<220> FEATURE:
<221> NAME/KEY: misc_feature
<222> LOCATION: (10)..(11)
<223> OTHER INFORMATION: an n-propylene spacer (c3) between these
    locations

<400> SEQUENCE: 141

gncgtanttg agaataagga gagagca                27

<210> SEQ ID NO 142
<211> LENGTH: 26
<212> TYPE: DNA
<213> ORGANISM: Artificial
<220> FEATURE:
<223> OTHER INFORMATION: synthetic oligonucleotide
<220> FEATURE:
<221> NAME/KEY: modified_base
<222> LOCATION: (3)..(3)
<223> OTHER INFORMATION: n represents iso-guanine
<220> FEATURE:
<221> NAME/KEY: modified_base
<222> LOCATION: (7)..(7)
<223> OTHER INFORMATION: n represents iso-guanine
<220> FEATURE:
<221> NAME/KEY: misc_feature
<222> LOCATION: (10)..(11)
<223> OTHER INFORMATION: an n-propylene spacer (c3) between these
    locations

<400> SEQUENCE: 142

gtntatnccg gaataaggag agagcg                26

<210> SEQ ID NO 143
<211> LENGTH: 30
<212> TYPE: DNA
<213> ORGANISM: Artificial
<220> FEATURE:
<223> OTHER INFORMATION: synthetic oligonucleotide
<220> FEATURE:
<221> NAME/KEY: modified_base
<222> LOCATION: (5)..(5)
<223> OTHER INFORMATION: n represents iso-guanine
<220> FEATURE:

```

-continued

```

<221> NAME/KEY: modified_base
<222> LOCATION: (8)..(8)
<223> OTHER INFORMATION: n represents iso-guanine
<220> FEATURE:
<221> NAME/KEY: misc_feature
<222> LOCATION: (10)..(11)
<223> OTHER INFORMATION: an n-propylene spacer (c3) between these
      locations

<400> SEQUENCE: 143

gacanaentc  agaatagtcc ttgctatta a 30

```

```

<210> SEQ ID NO 144
<211> LENGTH: 30
<212> TYPE: DNA
<213> ORGANISM: Artificial
<220> FEATURE:
<223> OTHER INFORMATION: synthetic oligonucleotide
<220> FEATURE:
<221> NAME/KEY: modified_base
<222> LOCATION: (5)..(5)
<223> OTHER INFORMATION: n represents iso-guanine
<220> FEATURE:
<221> NAME/KEY: modified_base
<222> LOCATION: (9)..(9)
<223> OTHER INFORMATION: n represents iso-guanine
<220> FEATURE:
<221> NAME/KEY: misc_feature
<222> LOCATION: (11)..(11)
<223> OTHER INFORMATION: an n-propylene spacer (c3) between these
      locations

<400> SEQUENCE: 144

ggaanaacng agaatagtcc ttgctatta g 30

```

```

<210> SEQ ID NO 145
<211> LENGTH: 25
<212> TYPE: DNA
<213> ORGANISM: Artificial
<220> FEATURE:
<223> OTHER INFORMATION: synthetic oligonucleotide
<220> FEATURE:
<221> NAME/KEY: modified_base
<222> LOCATION: (4)..(4)
<223> OTHER INFORMATION: n represents iso-guanine
<220> FEATURE:
<221> NAME/KEY: modified_base
<222> LOCATION: (6)..(6)
<223> OTHER INFORMATION: n represents iso-guanine
<220> FEATURE:
<221> NAME/KEY: misc_feature
<222> LOCATION: (10)..(11)
<223> OTHER INFORMATION: an n-propylene spacer (c3) between these
      locations

<400> SEQUENCE: 145

gatntncagc agaatgcaca ctgca 25

```

```

<210> SEQ ID NO 146
<211> LENGTH: 24
<212> TYPE: DNA
<213> ORGANISM: Artificial
<220> FEATURE:
<223> OTHER INFORMATION: synthetic oligonucleotide
<220> FEATURE:
<221> NAME/KEY: modified_base
<222> LOCATION: (3)..(3)
<223> OTHER INFORMATION: n represents iso-guanine
<220> FEATURE:
<221> NAME/KEY: modified_base
<222> LOCATION: (6)..(6)
<223> OTHER INFORMATION: n represents iso-guanine
<220> FEATURE:
<221> NAME/KEY: misc_feature

```

-continued

<222> LOCATION: (10)..(11)
 <223> OTHER INFORMATION: an n-propylene spacer (c3) between these locations

<400> SEQUENCE: 146

gtnatntgcg gaatgcacac tgcg 24

<210> SEQ ID NO 147
 <211> LENGTH: 23
 <212> TYPE: DNA
 <213> ORGANISM: Artificial
 <220> FEATURE:
 <223> OTHER INFORMATION: synthetic oligonucleotide
 <220> FEATURE:
 <221> NAME/KEY: modified_base
 <222> LOCATION: (4)..(4)
 <223> OTHER INFORMATION: n represents iso-guanine
 <220> FEATURE:
 <221> NAME/KEY: modified_base
 <222> LOCATION: (8)..(8)
 <223> OTHER INFORMATION: n represents iso-guanine
 <220> FEATURE:
 <221> NAME/KEY: modified_base
 <222> LOCATION: (9)..(9)
 <223> OTHER INFORMATION: n represents iso-guanine
 <220> FEATURE:
 <221> NAME/KEY: misc_feature
 <222> LOCATION: (10)..(11)
 <223> OTHER INFORMATION: an n-propylene spacer (c3) between these locations

<400> SEQUENCE: 147

gatngtcnng gctagcggag gcc 23

<210> SEQ ID NO 148
 <211> LENGTH: 23
 <212> TYPE: DNA
 <213> ORGANISM: Artificial
 <220> FEATURE:
 <223> OTHER INFORMATION: synthetic oligonucleotide
 <220> FEATURE:
 <221> NAME/KEY: modified_base
 <222> LOCATION: (3)..(3)
 <223> OTHER INFORMATION: n represents iso-guanine
 <220> FEATURE:
 <221> NAME/KEY: modified_base
 <222> LOCATION: (6)..(6)
 <223> OTHER INFORMATION: n represents iso-guanine
 <220> FEATURE:
 <221> NAME/KEY: misc_feature
 <222> LOCATION: (10)..(11)
 <223> OTHER INFORMATION: an n-propylene spacer (c3) between these locations

<400> SEQUENCE: 148

ggncnatgg gctagcggag gct 23

<210> SEQ ID NO 149
 <211> LENGTH: 61
 <212> TYPE: DNA
 <213> ORGANISM: Artificial
 <220> FEATURE:
 <223> OTHER INFORMATION: synthetic oligonucleotide

<400> SEQUENCE: 149

cttctcccat tgcccagggc actctctctct gtagartaga ctgatytgtg tggagacatc 60

a 61

<210> SEQ ID NO 150
 <211> LENGTH: 35
 <212> TYPE: DNA

-continued

<213> ORGANISM: Artificial
 <220> FEATURE:
 <223> OTHER INFORMATION: synthetic oligonucleotide
 <220> FEATURE:
 <221> NAME/KEY: modified_base
 <222> LOCATION: (2)..(2)
 <223> OTHER INFORMATION: n represents iso-cytosine
 <220> FEATURE:
 <221> NAME/KEY: modified_base
 <222> LOCATION: (5)..(5)
 <223> OTHER INFORMATION: n represents iso-cytosine
 <220> FEATURE:
 <221> NAME/KEY: modified_base
 <222> LOCATION: (8)..(8)
 <223> OTHER INFORMATION: n represents iso-cytosine
 <220> FEATURE:
 <221> NAME/KEY: modified_base
 <222> LOCATION: (12)..(12)
 <223> OTHER INFORMATION: n represents iso-cytosine

 <400> SEQUENCE: 150

cngcnagnga tntgatgtct ccacaaagat cagtc

35

<210> SEQ ID NO 151
 <211> LENGTH: 27
 <212> TYPE: DNA
 <213> ORGANISM: Artificial
 <220> FEATURE:
 <223> OTHER INFORMATION: synthetic oligonucleotide
 <220> FEATURE:
 <221> NAME/KEY: modified_base
 <222> LOCATION: (4)..(4)
 <223> OTHER INFORMATION: n represents iso-guanine
 <220> FEATURE:
 <221> NAME/KEY: modified_base
 <222> LOCATION: (8)..(8)
 <223> OTHER INFORMATION: n represents iso-guanine
 <220> FEATURE:
 <221> NAME/KEY: misc_feature
 <222> LOCATION: (11)..(11)
 <223> OTHER INFORMATION: an n-propylene spacer (c3) between these
 locations

 <400> SEQUENCE: 151

ctancaancc cactctcctc tgtagaa

27

<210> SEQ ID NO 152
 <211> LENGTH: 27
 <212> TYPE: DNA
 <213> ORGANISM: Artificial
 <220> FEATURE:
 <223> OTHER INFORMATION: synthetic oligonucleotide
 <220> FEATURE:
 <221> NAME/KEY: modified_base
 <222> LOCATION: (5)..(5)
 <223> OTHER INFORMATION: n represents iso-guanine
 <220> FEATURE:
 <221> NAME/KEY: modified_base
 <222> LOCATION: (7)..(7)
 <223> OTHER INFORMATION: n represents iso-guanine
 <220> FEATURE:
 <221> NAME/KEY: misc_feature
 <222> LOCATION: (10)..(11)
 <223> OTHER INFORMATION: an n-propylene spacer (c3) between these
 locations

 <400> SEQUENCE: 152

gagancnaag cactctcctc tgtagag

27

<210> SEQ ID NO 153
 <211> LENGTH: 13
 <212> TYPE: DNA
 <213> ORGANISM: Artificial
 <220> FEATURE:

-continued

<211> LENGTH: 25
 <212> TYPE: DNA
 <213> ORGANISM: Artificial
 <220> FEATURE:
 <223> OTHER INFORMATION: synthetic oligonucleotide
 <220> FEATURE:
 <221> NAME/KEY: modified_base
 <222> LOCATION: (2)..(2)
 <223> OTHER INFORMATION: n represents iso-cytosine

 <400> SEQUENCE: 158

 tntgatgtct ccacaagat cagtc 25

<210> SEQ ID NO 159
 <211> LENGTH: 18
 <212> TYPE: DNA
 <213> ORGANISM: Artificial
 <220> FEATURE:
 <223> OTHER INFORMATION: synthetic oligonucleotide
 <220> FEATURE:
 <221> NAME/KEY: modified_base
 <222> LOCATION: (2)..(2)
 <223> OTHER INFORMATION: n represents iso-cytosine

 <400> SEQUENCE: 159

 tncctgcaag ccagcacc 18

<210> SEQ ID NO 160
 <211> LENGTH: 23
 <212> TYPE: DNA
 <213> ORGANISM: Artificial
 <220> FEATURE:
 <223> OTHER INFORMATION: synthetic oligonucleotide
 <220> FEATURE:
 <221> NAME/KEY: modified_base
 <222> LOCATION: (2)..(2)
 <223> OTHER INFORMATION: n represents iso-cytosine

 <400> SEQUENCE: 160

 tngctggacc aggctagata agc 23

<210> SEQ ID NO 161
 <211> LENGTH: 21
 <212> TYPE: DNA
 <213> ORGANISM: Artificial
 <220> FEATURE:
 <223> OTHER INFORMATION: synthetic oligonucleotide
 <220> FEATURE:
 <221> NAME/KEY: modified_base
 <222> LOCATION: (2)..(2)
 <223> OTHER INFORMATION: n represents iso-cytosine

 <400> SEQUENCE: 161

 tngcaaggct ctacttcctg c 21

<210> SEQ ID NO 162
 <211> LENGTH: 23
 <212> TYPE: DNA
 <213> ORGANISM: Artificial
 <220> FEATURE:
 <223> OTHER INFORMATION: synthetic oligonucleotide
 <220> FEATURE:
 <221> NAME/KEY: modified_base
 <222> LOCATION: (2)..(2)
 <223> OTHER INFORMATION: n represents iso-cytosine

 <400> SEQUENCE: 162

 tngtgtcttg gctgctcagt atg 23

<210> SEQ ID NO 163

-continued

<211> LENGTH: 24
 <212> TYPE: DNA
 <213> ORGANISM: Artificial
 <220> FEATURE:
 <223> OTHER INFORMATION: synthetic oligonucleotide
 <220> FEATURE:
 <221> NAME/KEY: modified_base
 <222> LOCATION: (2)..(2)
 <223> OTHER INFORMATION: n represents iso-cytosine

<400> SEQUENCE: 163

tncaacttct tggatcatggt tgtc

24

<210> SEQ ID NO 164
 <211> LENGTH: 20
 <212> TYPE: DNA
 <213> ORGANISM: Artificial
 <220> FEATURE:
 <223> OTHER INFORMATION: synthetic oligonucleotide
 <220> FEATURE:
 <221> NAME/KEY: modified_base
 <222> LOCATION: (2)..(2)
 <223> OTHER INFORMATION: n represents iso-cytosine

<400> SEQUENCE: 164

tnccttctg cactccacag

20

<210> SEQ ID NO 165
 <211> LENGTH: 19
 <212> TYPE: DNA
 <213> ORGANISM: Artificial
 <220> FEATURE:
 <223> OTHER INFORMATION: synthetic oligonucleotide
 <220> FEATURE:
 <221> NAME/KEY: modified_base
 <222> LOCATION: (2)..(2)
 <223> OTHER INFORMATION: n represents iso-cytosine

<400> SEQUENCE: 165

tntgagcagt cggtcagt

19

40

What is claimed is:

1. A method for detecting a target nucleic acid in a sample comprising:

- a) synthesizing a nucleic acid comprising a copy of the target nucleic acid or a complement of the target nucleic acid using a reaction mixture that comprises (i) a first primer comprising a tagging sequence and a sequence complementary to a first sequence of the target nucleic acid or the complement of the target nucleic acid, (ii) a second primer comprising at least one non-natural base and a sequence complementary to a second sequence of the target nucleic acid or the complement of the target nucleic acid, and (iii) a labeled, non-natural nucleotide triphosphate having a non-natural base that is complementary to the non-natural base of the second primer;
- b) contacting the synthesized nucleic acid with an oligonucleotide bound to a solid support, wherein the oligonucleotide comprises a molecular recognition sequence that is complementary to the tagging sequence of the first primer; and
- c) detecting specific hybridization of the synthesized nucleic acid and the oligonucleotide bound to the solid support, thereby detecting the target nucleic acid.

2. The method of claim 1, wherein the label comprises a coupling agent.

3. The method of claim 2, wherein the coupling agent comprises biotin.

4. The method of claim 3, wherein the method further comprises contacting the synthesized nucleic acid with a streptavidin-phycoerythrin.

5. The method of claim 1, wherein the label comprises a fluorophore.

6. The method of claim 1, wherein the non-natural base is selected from the group consisting of iso-cytosine and iso-guanine.

7. The method of claim 1, wherein the target nucleic acid is detected quantitatively.

8. The method of claim 1, wherein the specific hybridization is detected without performing washing.

9. The method of claim 1, wherein the specific hybridization is detected at room temperature.

10. The method of claim 1, wherein the first primer comprises a n-propylene spacer between the tagging sequence and the sequence complementary to a first sequence of the target nucleic acid or the complement of the target nucleic acid.

11. The method of claim 1, wherein the tagging sequence and the molecular recognition sequence each comprise at least one non-natural base, and further wherein the at least one non-natural base of the tagging sequence is complementary to the at least one non-natural base of the molecular recognition sequence.

141

12. The method of claim 11, wherein the non-natural base is selected from the group consisting of iso-cytosine and iso-guanine.

* * * * *

142

UNITED STATES PATENT AND TRADEMARK OFFICE
CERTIFICATE OF CORRECTION

PATENT NO. : 8,518,671 B2
APPLICATION NO. : 13/478586
DATED : August 27, 2013
INVENTOR(S) : Jennifer K. Grenier et al.

Page 1 of 1

It is certified that error appears in the above-identified patent and that said Letters Patent is hereby corrected as shown below:

In the Claims:

In claim 1, column 1, line 54, after the word “having” insert --a label and--.

In claim 1, column 1, line 55, after the word “primer” insert --, and forming a synthesized nucleic acid--.

In claim 1, column 1, line 61, after the word “detecting” insert --a--.

In claim 1, column 1, line 63, after the word “acid” insert --in the sample--.

In claim 4, column 2, line 42-43, delete “wherein the method further comprises” and insert --further comprising-- therefor.

In claim 10, column 2, line 59, delete “a” and insert --the-- therefor.

In claim 11, column 2, line 62, after the word “wherein” insert --each of--.

In claim 11, column 2, line 63, delete “each comprise” and insert --comprises-- therefor.

In claim 11, column 2, line 64, delete “further wherein”.

Signed and Sealed this
First Day of October, 2013



Teresa Stanek Rea
Deputy Director of the United States Patent and Trademark Office