

US008462673B2

(12) **United States Patent**
Stanwood et al.

(10) **Patent No.:** **US 8,462,673 B2**
(45) **Date of Patent:** ***Jun. 11, 2013**

(54) **FRAMING FOR AN ADAPTIVE MODULATION COMMUNICATION SYSTEM**

(75) Inventors: **Kenneth L. Stanwood**, Cardiff by the Sea, CA (US); **Israel Jay Klein**, San Diego, CA (US); **George Lin**, Del Mar, CA (US); **An Chen**, San Diego, CA (US)

(73) Assignee: **Wi-Lan, Inc.**, Ottawa (CA)

(*) Notice: Subject to any disclaimer, the term of this patent is extended or adjusted under 35 U.S.C. 154(b) by 0 days.

This patent is subject to a terminal disclaimer.

(21) Appl. No.: **13/427,692**

(22) Filed: **Mar. 22, 2012**

(65) **Prior Publication Data**

US 2012/0182952 A1 Jul. 19, 2012

Related U.S. Application Data

(60) Continuation of application No. 12/035,549, filed on Feb. 22, 2008, now Pat. No. 8,165,046, which is a continuation of application No. 11/674,548, filed on Feb. 13, 2007, now Pat. No. 7,379,441, which is a division of application No. 09/991,532, filed on Nov. 15, 2001, now Pat. No. 7,197,022.

(60) Provisional application No. 60/249,065, filed on Nov. 15, 2000.

(51) **Int. Cl.**
H04J 3/00 (2006.01)

(52) **U.S. Cl.**
USPC **370/280; 370/281; 370/294; 370/295; 370/334; 370/345; 370/347; 370/442**

(58) **Field of Classification Search**
USPC 370/280, 281, 294, 295, 334, 345, 370/347, 442; 375/261
See application file for complete search history.

(56) **References Cited**

U.S. PATENT DOCUMENTS

3,949,404 A 4/1976 Fletcher et al.
4,495,619 A 1/1985 Acampora

(Continued)

FOREIGN PATENT DOCUMENTS

EP 0507384 B1 3/1992
EP 0622924 A2 11/1994

(Continued)

OTHER PUBLICATIONS

Dutton. "Asynchronous Transfer Mode (ATM) Technical Overview?" 2.sup.nd Edition, Prentice Hall, Oct. 1995, Chap. 3, pp. 21-25.

(Continued)

Primary Examiner — Christopher Grey

(74) *Attorney, Agent, or Firm* — Procopio, Cory, Hargreaves & Savitch LLP

(57) **ABSTRACT**

A system and method for mapping a combined frequency division duplexing (FDD) Time Division Multiplexing (TDM)/Time Division Multiple Access (TDMA) downlink subframe for use with half-duplex and full-duplex terminals in a communication system. Embodiments of the downlink subframe vary Forward Error Correction (FEC) types for a given modulation scheme as well as support the implementation of a smart antennae at a base station in the communication system. Embodiments of the system are also used in a TDD communication system to support the implementation of smart antennae. A scheduling algorithm allows TDM and TDMA portions of a downlink to efficiently co-exist in the same downlink subframe and simultaneously support full and half-duplex terminals.

20 Claims, 17 Drawing Sheets

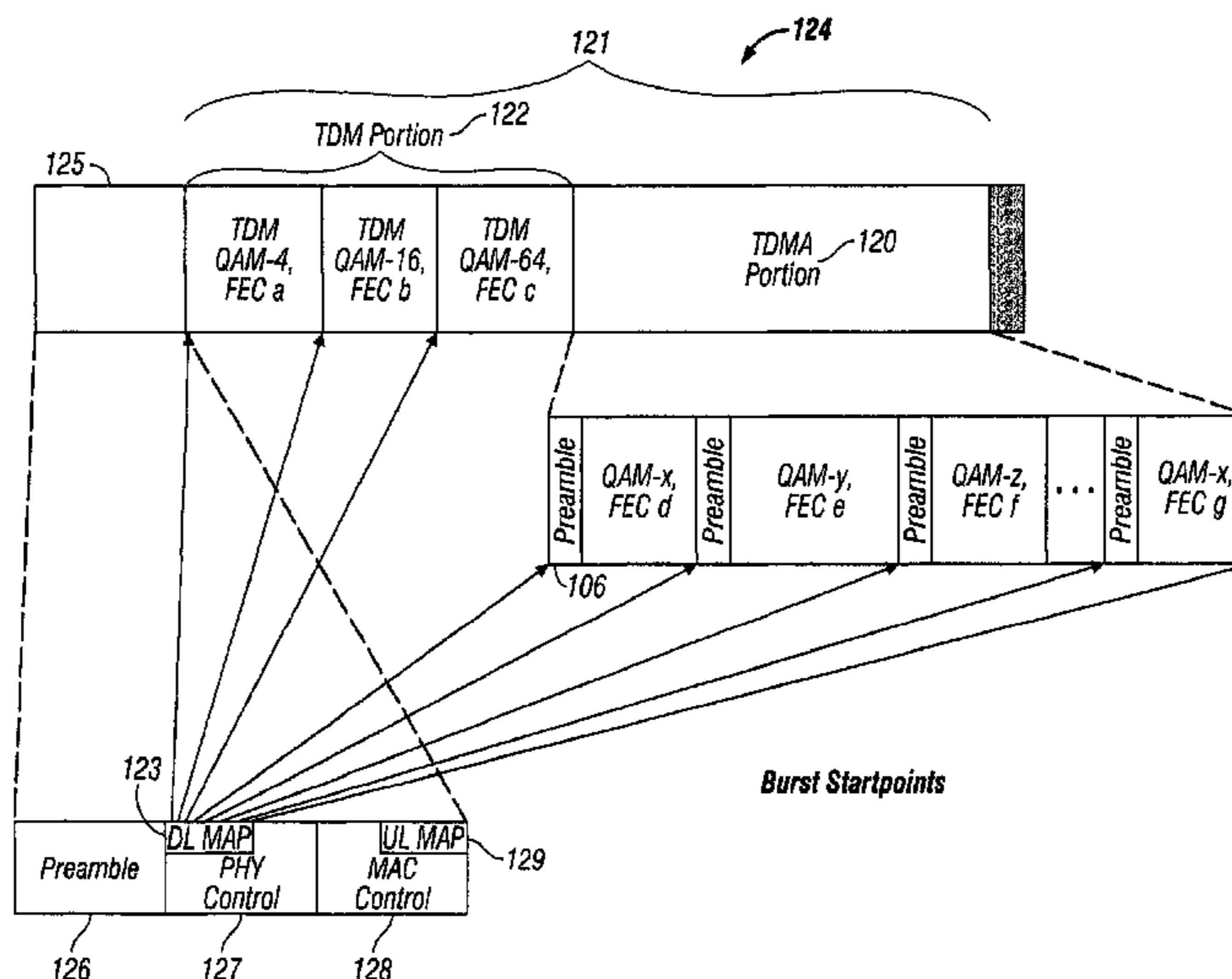

U.S. PATENT DOCUMENTS

4,975,906 A 12/1990 Takiyasu et al.
 5,130,983 A 7/1992 Heffner, III
 5,297,144 A 3/1994 Gilbert et al.
 5,402,422 A 3/1995 Liu et al.
 5,404,374 A 4/1995 Mullins et al.
 5,420,851 A 5/1995 Seshadri et al.
 5,444,698 A 8/1995 Kito
 5,457,687 A 10/1995 Newman
 5,511,082 A 4/1996 How et al.
 5,517,503 A 5/1996 Hess et al.
 5,615,212 A 3/1997 Ruszczyc et al.
 5,638,371 A 6/1997 Raychaudhuri et al.
 5,638,374 A 6/1997 Heath
 5,666,358 A 9/1997 Paratore et al.
 5,675,573 A 10/1997 Karol et al.
 5,684,791 A 11/1997 Raychaudhuri et al.
 5,751,708 A 5/1998 Eng et al.
 5,768,254 A 6/1998 Papadopoulos et al.
 5,774,461 A 6/1998 Hyden et al.
 5,818,842 A 10/1998 Burwell et al.
 5,828,695 A 10/1998 Webb
 5,844,906 A 12/1998 Khelghatti et al.
 5,859,619 A 1/1999 Wu et al.
 5,859,848 A 1/1999 Miura et al.
 5,890,055 A 3/1999 Chu et al.
 5,909,469 A 6/1999 Frodigh et al.
 5,912,920 A 6/1999 Marchok et al.
 5,918,171 A 6/1999 Funke et al.
 5,946,313 A 8/1999 Allan et al.
 5,963,543 A 10/1999 Rostoker et al.
 5,970,062 A 10/1999 Bauchot
 5,987,034 A 11/1999 Simon et al.
 6,006,069 A 12/1999 Langston et al.
 6,011,786 A 1/2000 Dent et al.
 6,016,311 A 1/2000 Gilbert et al.
 6,016,313 A 1/2000 Foster et al.
 6,016,401 A 1/2000 Rostoker et al.
 6,026,133 A 2/2000 Sokoler et al.
 6,031,827 A 2/2000 Rikkinen et al.
 6,038,455 A 3/2000 Gardner et al.
 6,094,421 A 7/2000 Scott
 6,112,080 A 8/2000 Anderson et al.
 6,125,148 A * 9/2000 Frodigh et al. 375/261
 6,128,293 A 10/2000 Pfeffer et al.
 6,147,989 A 11/2000 Esaki et al.
 6,151,318 A 11/2000 Woodward et al.
 6,163,547 A 12/2000 De Vriendt et al.
 6,167,031 A 12/2000 Olofsson et al.
 6,188,680 B1 2/2001 Ohki
 6,189,041 B1 2/2001 Cox et al.
 6,201,811 B1 3/2001 Larsson et al.
 6,201,813 B1 3/2001 Klausmeier et al.
 6,233,231 B1 5/2001 Felix et al.
 6,339,585 B1 1/2002 Hulyalkar et al.
 6,351,499 B1 2/2002 Paulraj et al.
 6,359,934 B1 3/2002 Yoshida
 6,366,961 B1 4/2002 Subbiah et al.
 6,370,112 B1 4/2002 Voelker
 6,392,994 B1 5/2002 Dubuc
 6,400,755 B1 6/2002 Harris et al.
 6,452,927 B1 9/2002 Rich
 6,452,964 B1 9/2002 Yoshida
 6,463,107 B1 10/2002 Lindoff et al.
 6,469,991 B1 10/2002 Chuah
 6,483,854 B1 11/2002 Klausmeier et al.
 6,493,342 B1 12/2002 Breslow et al.
 6,496,142 B1 12/2002 Iinuma
 6,549,759 B2 4/2003 Arviv et al.
 6,567,383 B1 5/2003 Böhnke
 6,608,841 B1 8/2003 Koodli
 6,631,130 B1 10/2003 Roy et al.
 6,665,292 B1 12/2003 Bradshaw et al.
 6,665,296 B1 12/2003 Sturza et al.
 6,674,731 B1 1/2004 Bradshaw et al.
 6,683,866 B1 1/2004 Stanwood et al.
 6,697,364 B1 2/2004 Kekki et al.
 6,711,176 B1 3/2004 Pezeshki-Esfahani
 6,721,286 B1 4/2004 Williams et al.

6,741,614 B1 * 5/2004 Porter et al. 370/508
 6,747,977 B1 6/2004 Smith et al.
 6,760,599 B1 7/2004 Uhlik
 6,771,660 B1 8/2004 Bourlas et al.
 6,785,252 B1 8/2004 Zimmerman et al.
 6,804,251 B1 10/2004 Limb et al.
 6,862,622 B2 3/2005 Jorgensen
 6,870,932 B2 3/2005 Jiang
 6,907,048 B1 6/2005 Treadaway et al.
 6,918,034 B1 7/2005 Sengodan et al.
 6,925,068 B1 8/2005 Stanwood et al.
 6,931,030 B1 8/2005 Dogan
 6,940,823 B1 9/2005 Park et al.
 6,944,672 B2 9/2005 Crow et al.
 6,963,751 B1 11/2005 Kordsmeyer et al.
 6,968,554 B1 11/2005 Macdonald
 6,970,941 B1 11/2005 Caronni et al.
 7,006,525 B1 2/2006 Jha
 7,006,526 B1 2/2006 Biederman
 7,020,715 B2 3/2006 Venkataraman et al.
 7,031,281 B1 4/2006 Zhang
 7,050,407 B1 5/2006 Frazer et al.
 7,061,935 B1 6/2006 Roy et al.
 7,068,639 B1 6/2006 Varma et al.
 7,085,291 B2 8/2006 Zhang et al.
 7,197,022 B2 3/2007 Stanwood et al.
 7,230,931 B2 6/2007 Struhsaker
 7,260,405 B2 8/2007 Kim et al.
 7,321,569 B2 1/2008 Takagi et al.
 7,433,334 B2 10/2008 Marjelund et al.
 7,443,814 B2 10/2008 Agarwal et al.
 7,471,620 B2 * 12/2008 Alazraki et al. 370/204
 7,570,645 B2 8/2009 Agarwal
 7,583,623 B2 9/2009 Zimmerman et al.
 2001/0015985 A1 8/2001 Van Grinsven et al.
 2001/0048681 A1 12/2001 Bilic et al.
 2002/0016852 A1 2/2002 Nishihara
 2002/0089984 A1 7/2002 Jiang
 2002/0090005 A1 7/2002 Jiang et al.
 2002/0126677 A1 9/2002 Hathaway et al.
 2003/0169722 A1 9/2003 Petrus et al.
 2004/0132459 A1 7/2004 Varma et al.
 2005/0100120 A1 5/2005 Barton et al.
 2005/0220110 A1 10/2005 Agarwal
 2006/0062250 A1 3/2006 Payne
 2006/0262808 A1 11/2006 Lin et al.
 2008/0081651 A1 4/2008 Kuroda et al.

FOREIGN PATENT DOCUMENTS

EP 0720405 A2 7/1996
 EP 0845916 B1 12/1997
 EP 0891060 A2 1/1999
 EP 0944200 B1 6/2009
 JP 11-266231 A 9/1999
 WO 97/13388 A1 4/1997
 WO 98/10568 A1 3/1998
 WO 99/38343 A2 7/1999
 WO 99/39532 A1 8/1999
 WO 00/01188 A1 1/2000
 WO 92/22162 A1 12/2002

OTHER PUBLICATIONS

Shannon. "A Mathematical Theory of Communication." Bell System Technical Journal, pp. 379-423 (Part 1), 623-656 (Part 2), Jul. 1948.
 Cable Television Laboratories, Inc., "Data-Over-Cable Service Interface Specifications Radio Frequency Interface Specification", SP-RFIV1.1-101-990311, 1999-2005, 320 pages.
 Narlikar et al. "Designing Multihop Wireless Backhand Networks with Delay Guarantees." Bell Labs, 2005.
 International Preliminary Examination Report for PCT/US00/29687 dated Dec. 18, 2001.
 International Search Report for PCT/US00/20577 dated Jan. 5, 2001, 5 pages.
 International Search Report for PCT/US00/29687 dated Mar. 21, 2001, 3 pages.
 International Search Report for PCT/US00/29687 dated Mar. 28, 2001.

- International Search Report for PCT/US01/43582 dated Aug. 20, 2002, 3 pages.
- Pons et al. "Bit Error Rate Characterisation and Modelling for GSM." IEEE 1998, pp. 3722-3727.
- Andersen et al. "Prediction of Future Fading Based on Past Measurements." Vehicular Technology Conference, VTC 99, vol. 1, pp. 151-155.
- Torrance et al. "Upper bound performance of adaptive modulation in a slow Rayleigh fading channel." IEEE Electronics Letters. 32(8):718-719, Apr. 11, 1996.
- Jain. "On the Impact of Channel and Channel Quality Estimation on Adaptive Modulation." Dec. 2002, 92 pages.
- Lee. "Convolutional Coding, Fundamentals and Applications." Artech House, Inc. 1997, p. 11-51.
- Lin et al. "Error Control Coding, Fundamentals and Applications." Prentice-Hall Computer Applications in Electrical Engineering Series., 1993, pp. 315-349.
- Notice of Allowance for U.S. Appl. No. 09/430,379 issued on Jul. 28, 2003.
- Office Action issued in U.S. Appl. No. 09/430,379 on Jan. 15, 2003.
- Bender et al. "CDMA/HDR: A Bandwidth Efficient High Speed Wireless Data Service for Nomadic Users." Communications Magazine, IEEE. 38(7):70-77. Jul. 2000.
- Papadopoulos et al. "Reduction of MiXed Co-channel Interference in Microcellular STDD Systems." Vehicular Technology Conference. 1995 IEEE 45.sup.th, vol. 2, pp. 759-763.
- Redl et al. "An Introduction to GSM." Artech House, Inc. 1995, pp. 84-85 and 95.
- Sampei et al. "Adaptive Modulation/TDMA Scheme for Personal Multi-Media Communication System." Proceedings of the Global Telecommunications Conference, U.S., New York, IEEE. Nov. 28, 1994, pp. 989-993.
- Sater et al. "Media Access Control Layer Proposal for the 802.16.1 Air Interface Specification." IEEE 802.16 Broadband Wireless Access Working Group, Online! Jul. 7, 2000, XP002210334 retrieved from the Internet: <URL: <http://wirelessman.org/tgl/mac/contrib/802161mc-00.sub.1321rl.pdf>> retrieved Aug. 20, 2002, pp. 69-80.
- U.S. District Court, Northern District of California, "Amended Complaint for Declaratory Judgment Demand for Jury Trial" filed Sep. 30, 2008 in Case No. 5:08-cv-4555.
- Ue et al. "Symbol Rate and Modulation Level Controlled Adaptive Modulation/TDMA/TDD for Personal Communication Systems." Proceedings of the Vehicular Technology Conference, U.S., New York, IEEE, vol. Conf. 45, Jul. 25, 1995, pp. 306-310.
- Ulm et al. "Data-Over-Cable Interface Specifications, Radio Frequency Interface Specification." Hewlett Packard Interim Specification, Doc. Control No. SP-RFII01-970321, published Mar. 21, 1997 by MCNS Holdings, L.P. Section 6, pp. 43-85.
- Wolf et al. "On the Weight Distribution of Linear Block Codes Formed From Convolutional Codes." IEEE, IEEE Transactions on Communications, vol. 44, Sep. 9, 1996.
- Matsuoka et al. "Adaptive Modulation System with Variable Coding Rate Concatenated Code for High Quality Multi-Media Communication Systems." Apr. 28, 1996. IEEE. pp. 487-491.

* cited by examiner

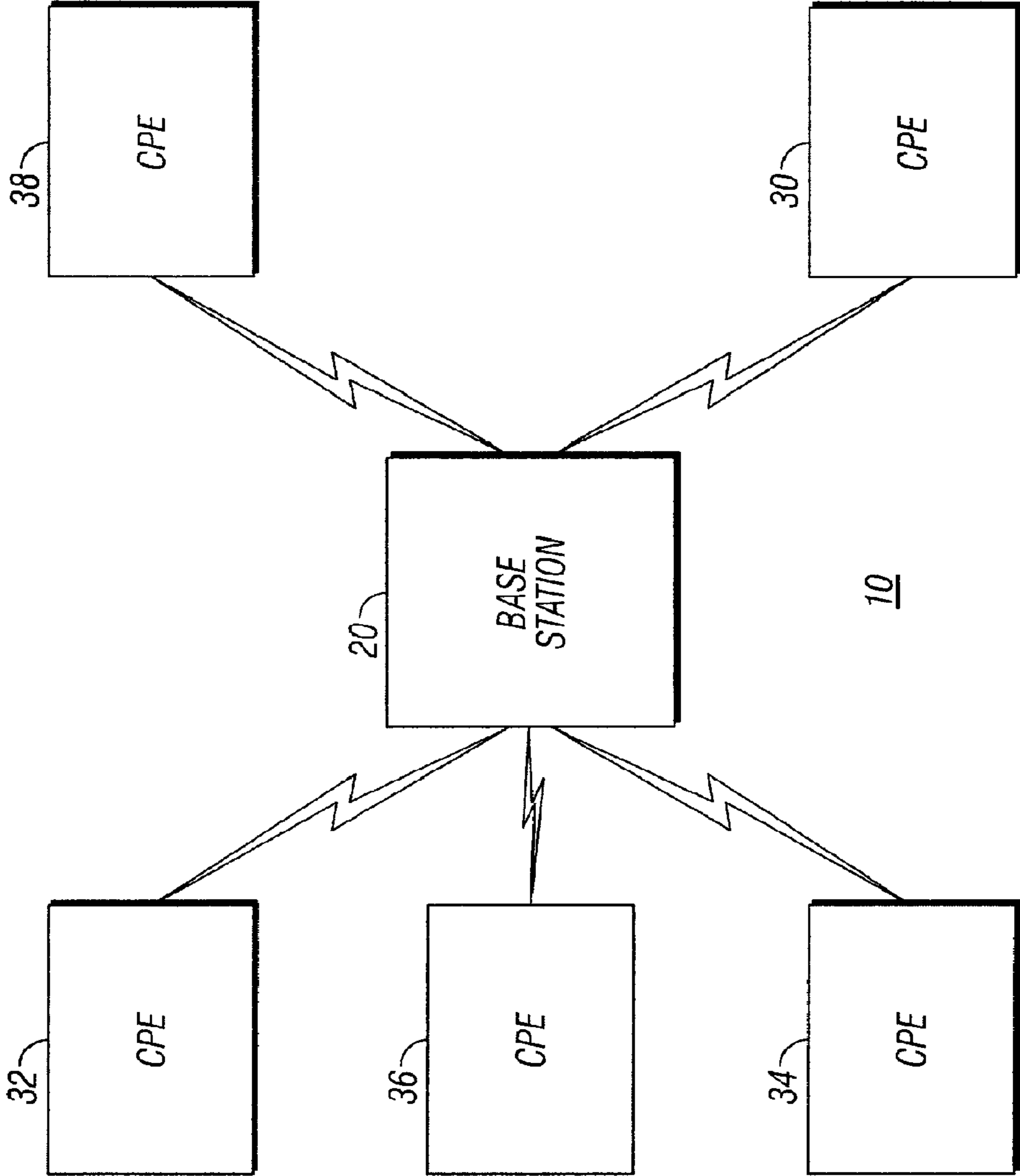

FIG. 1

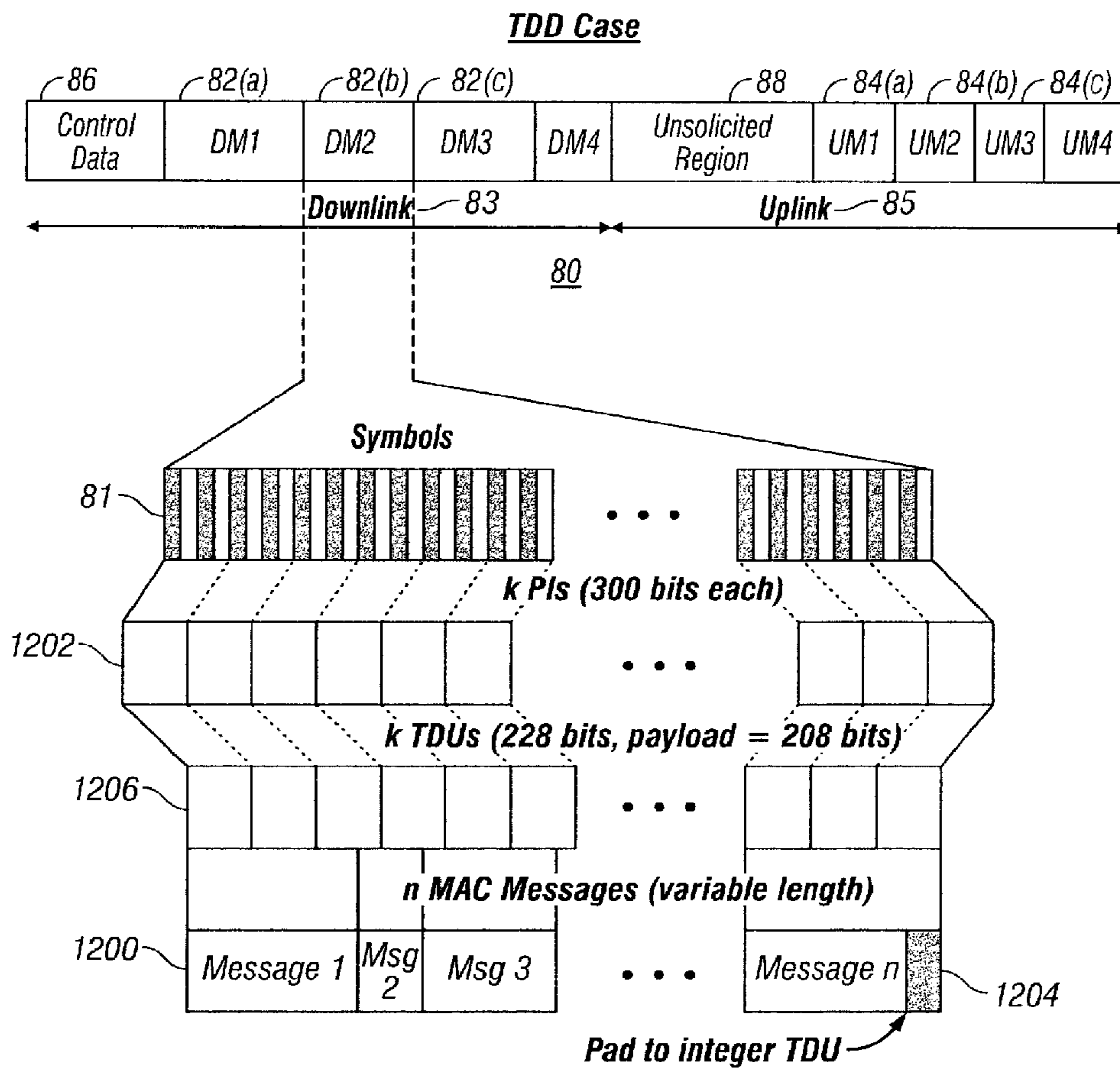

FIG. 2

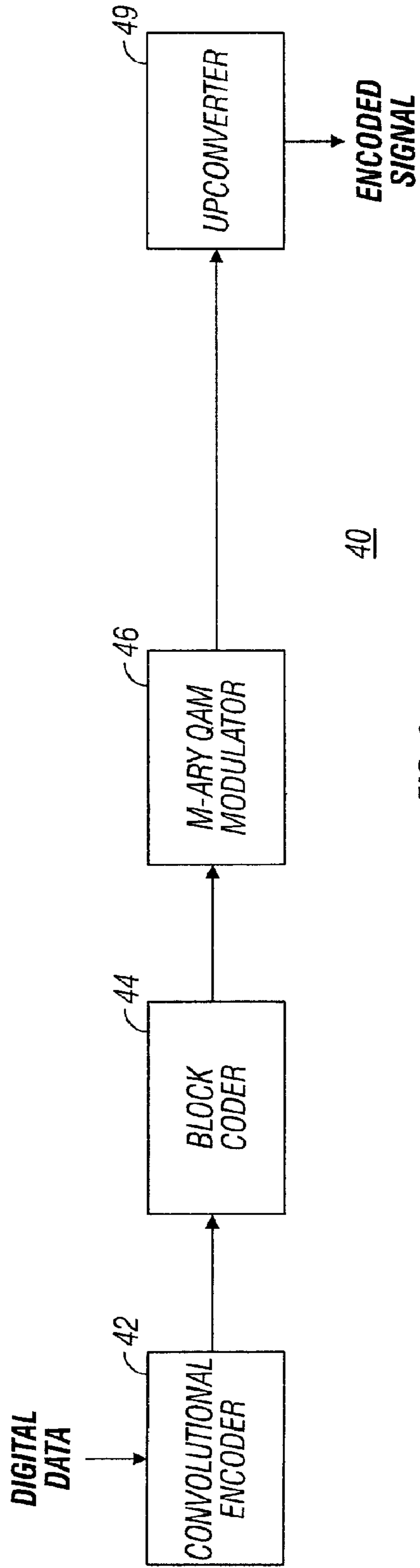

FIG. 3

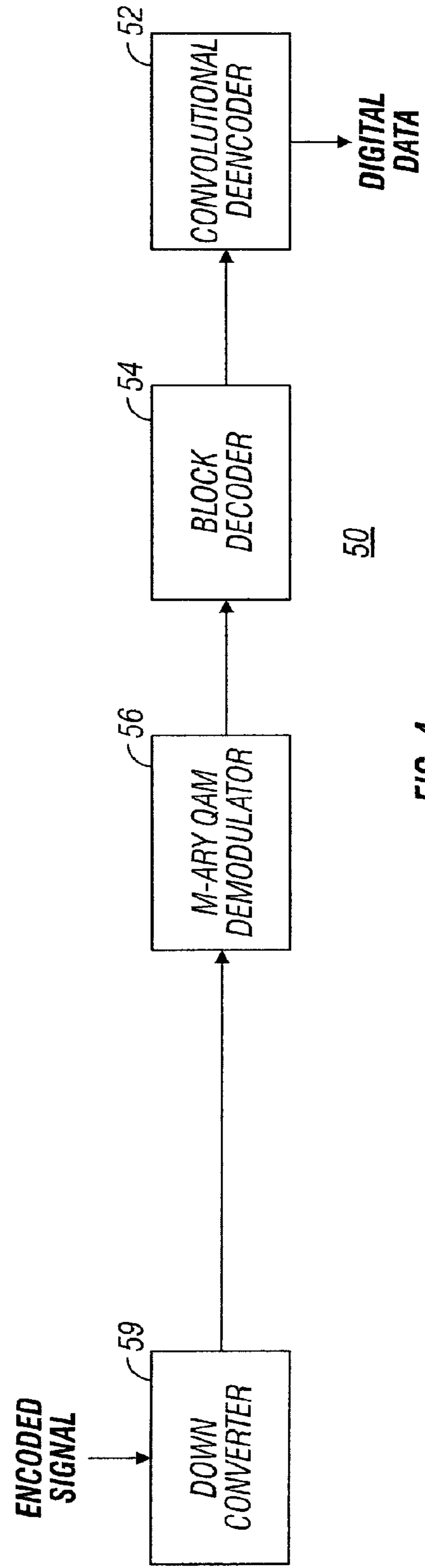

FIG. 4

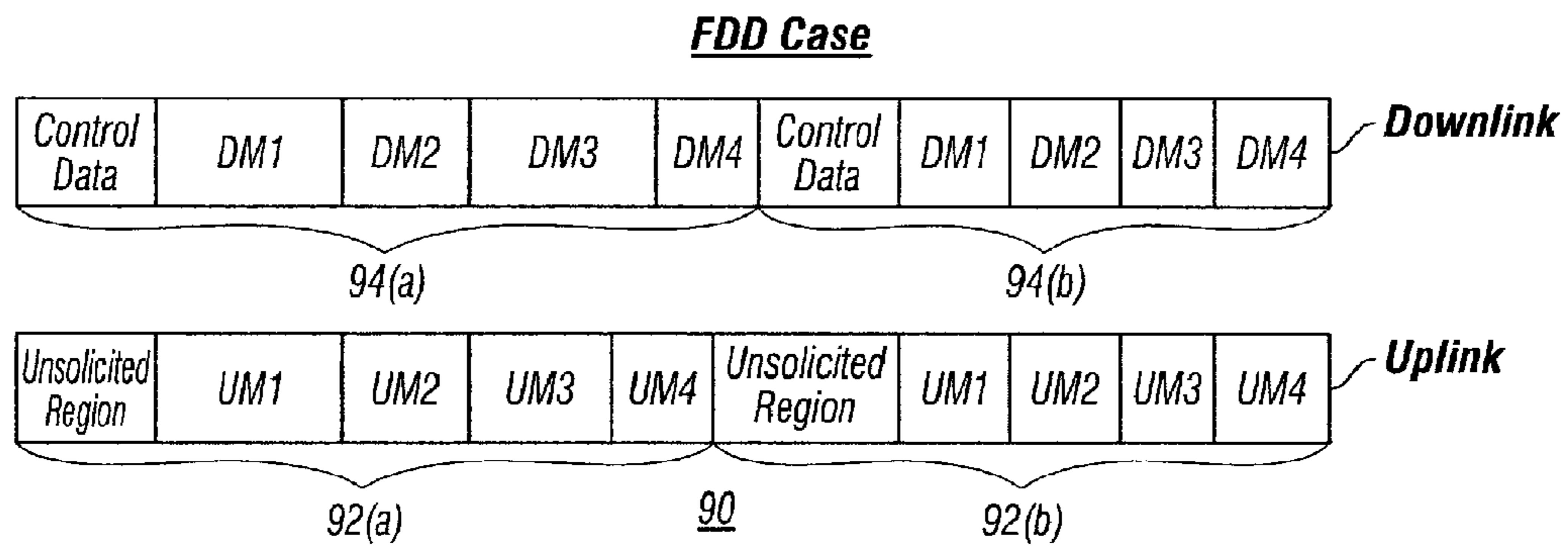

FIG. 5

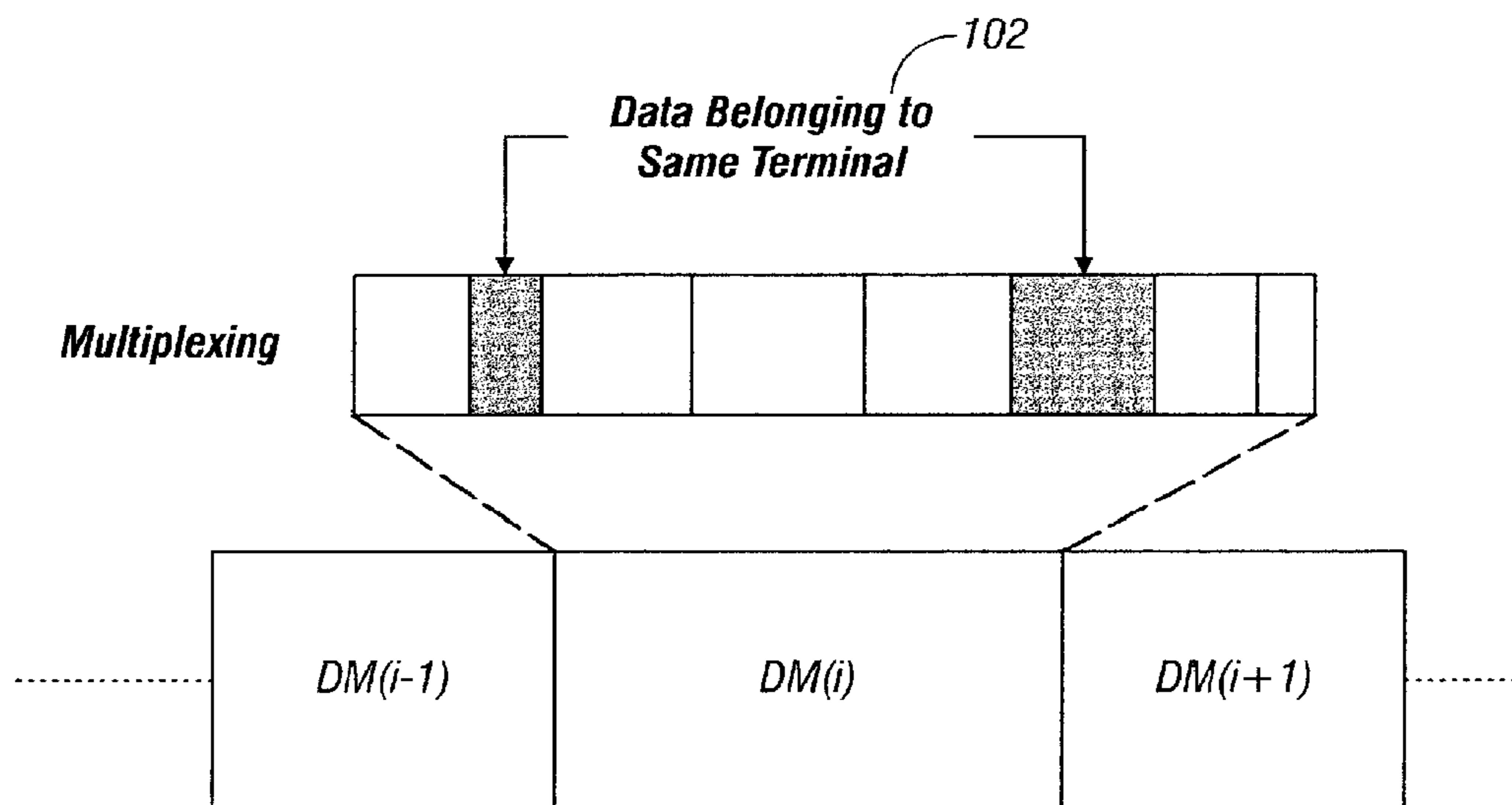

FIG. 6

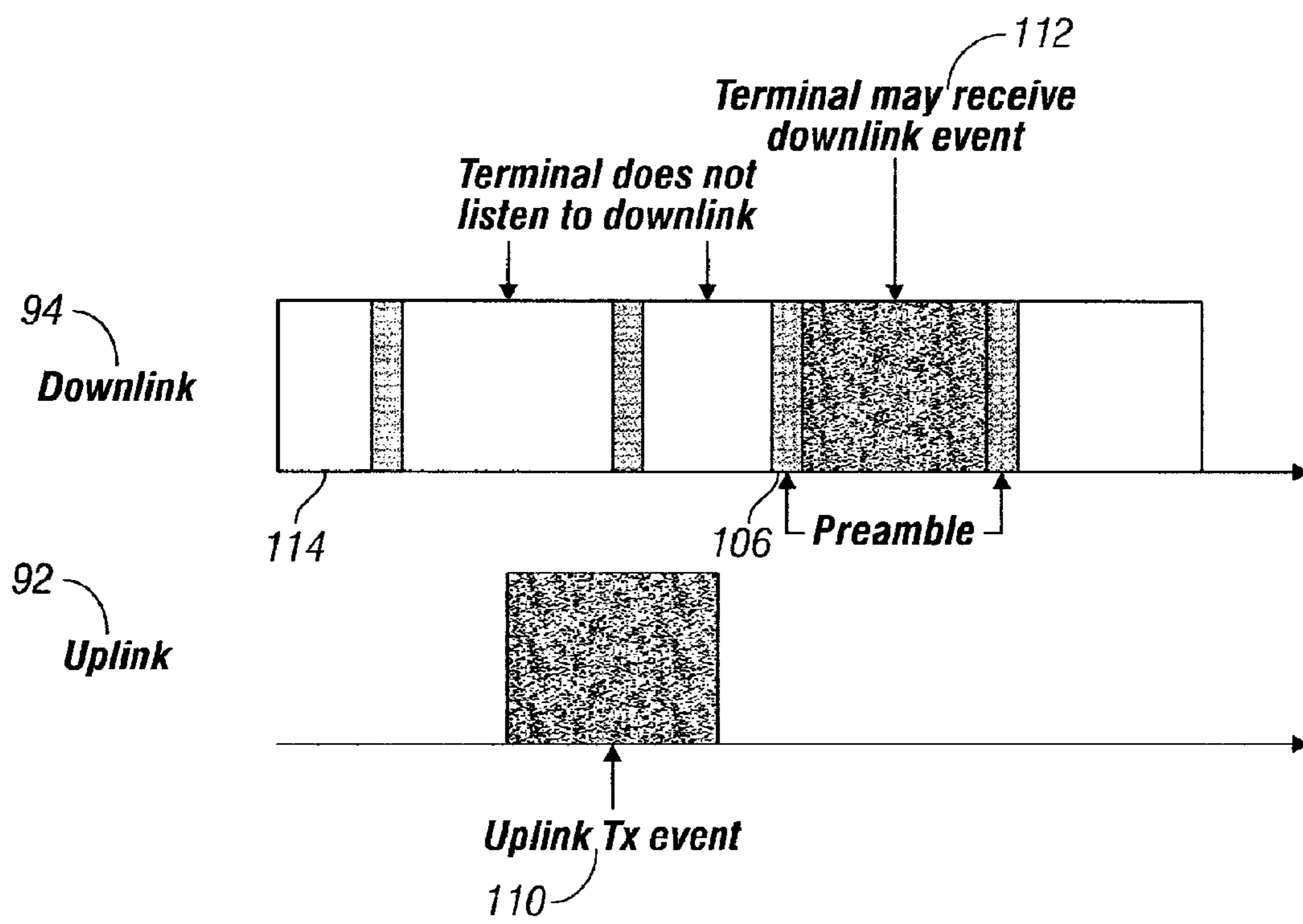

FIG. 7

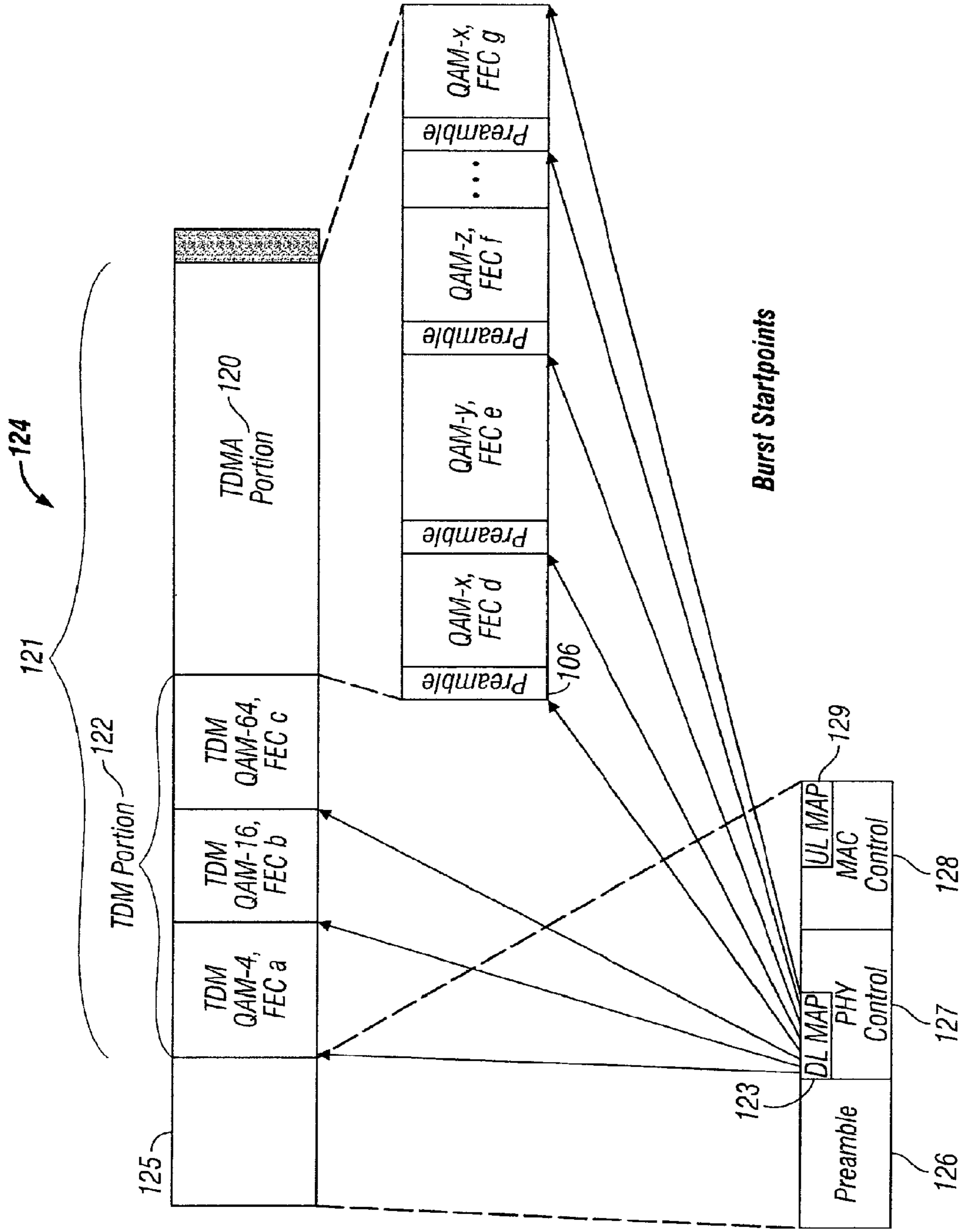

FIG. 8

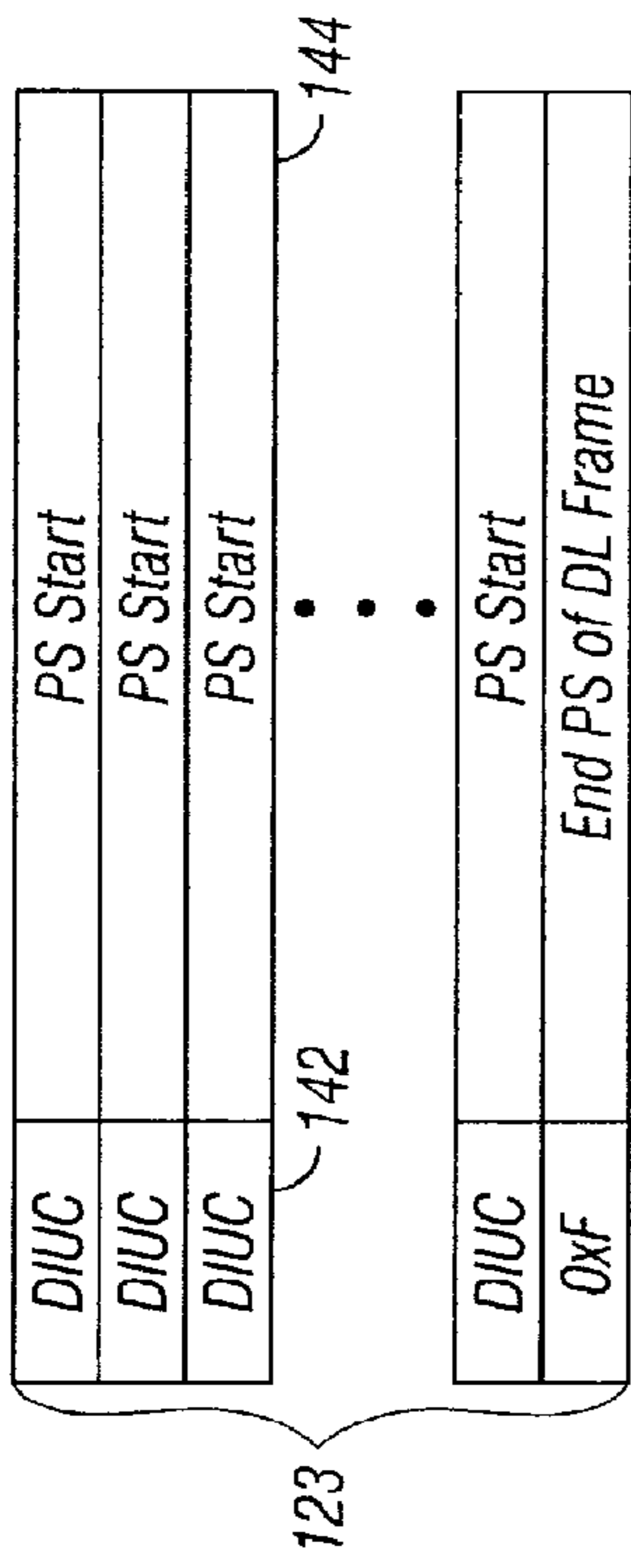

FIG. 9

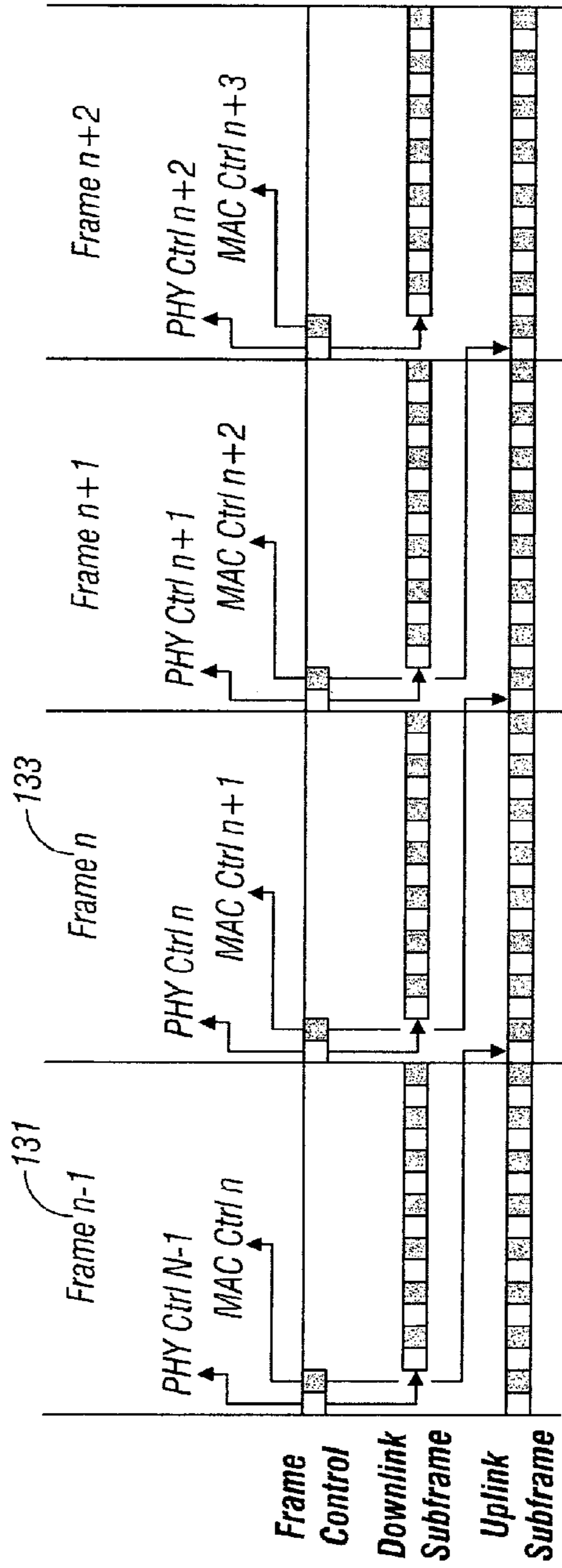

FIG. 10

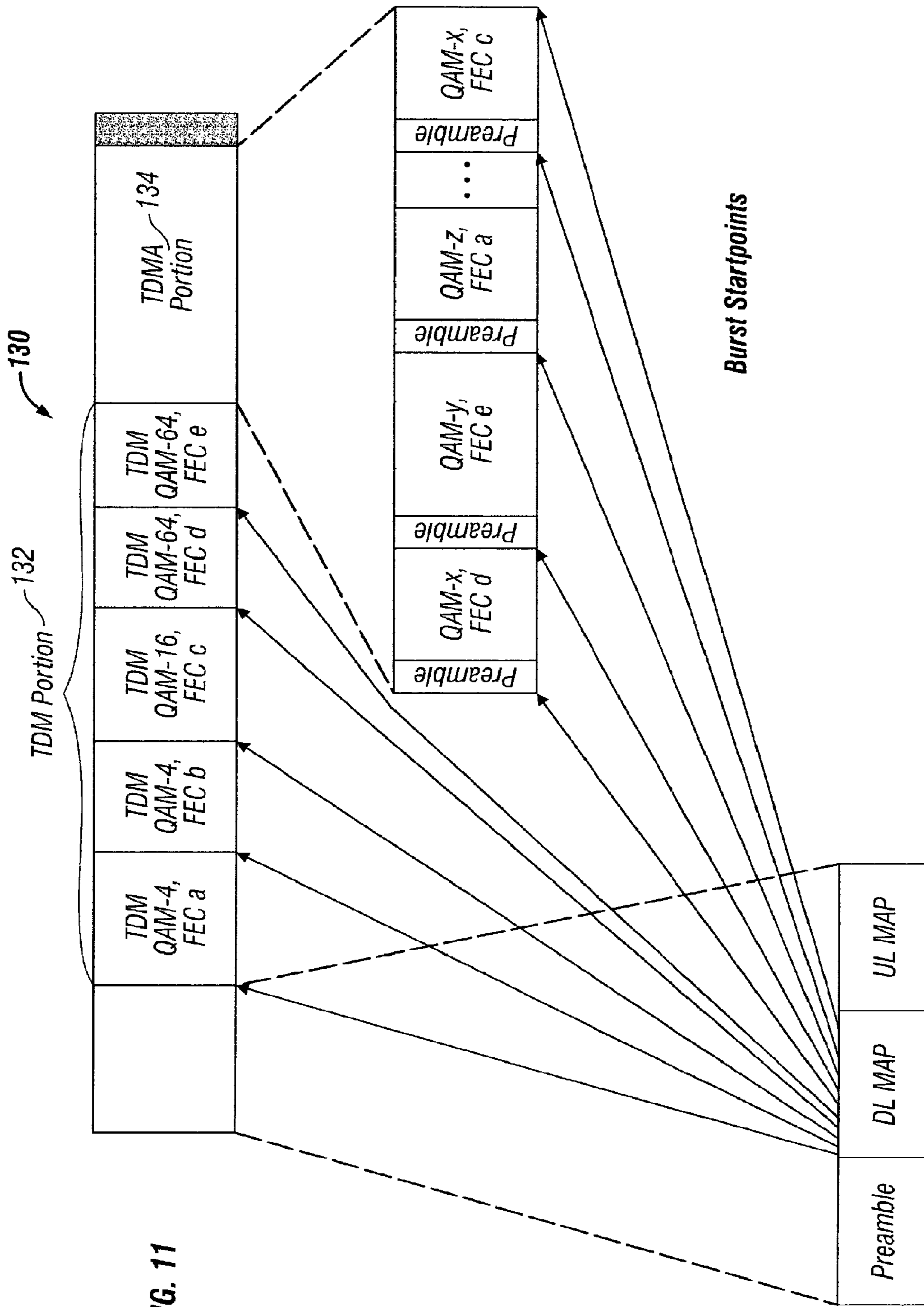

FIG. 11

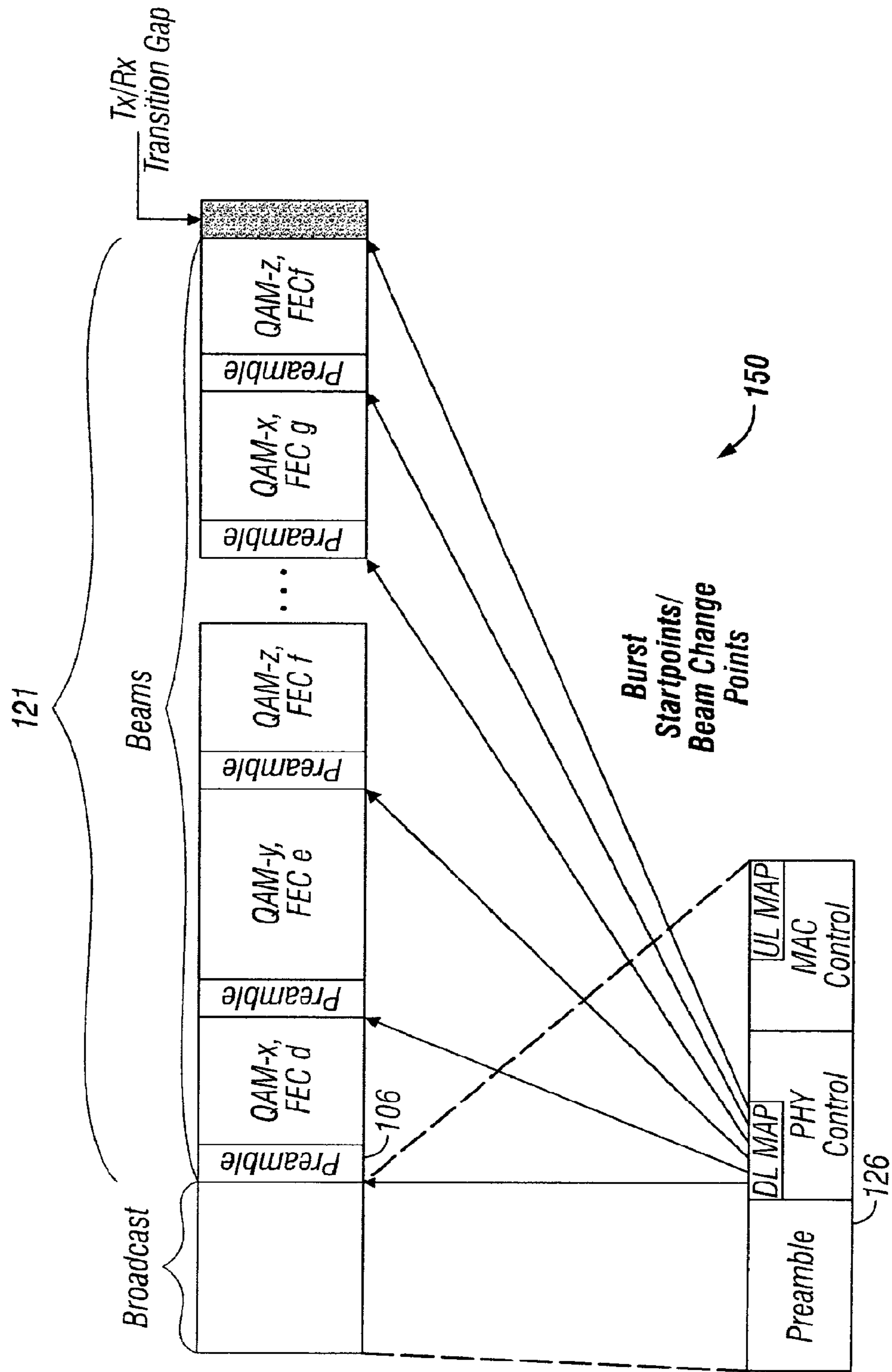

FIG. 12

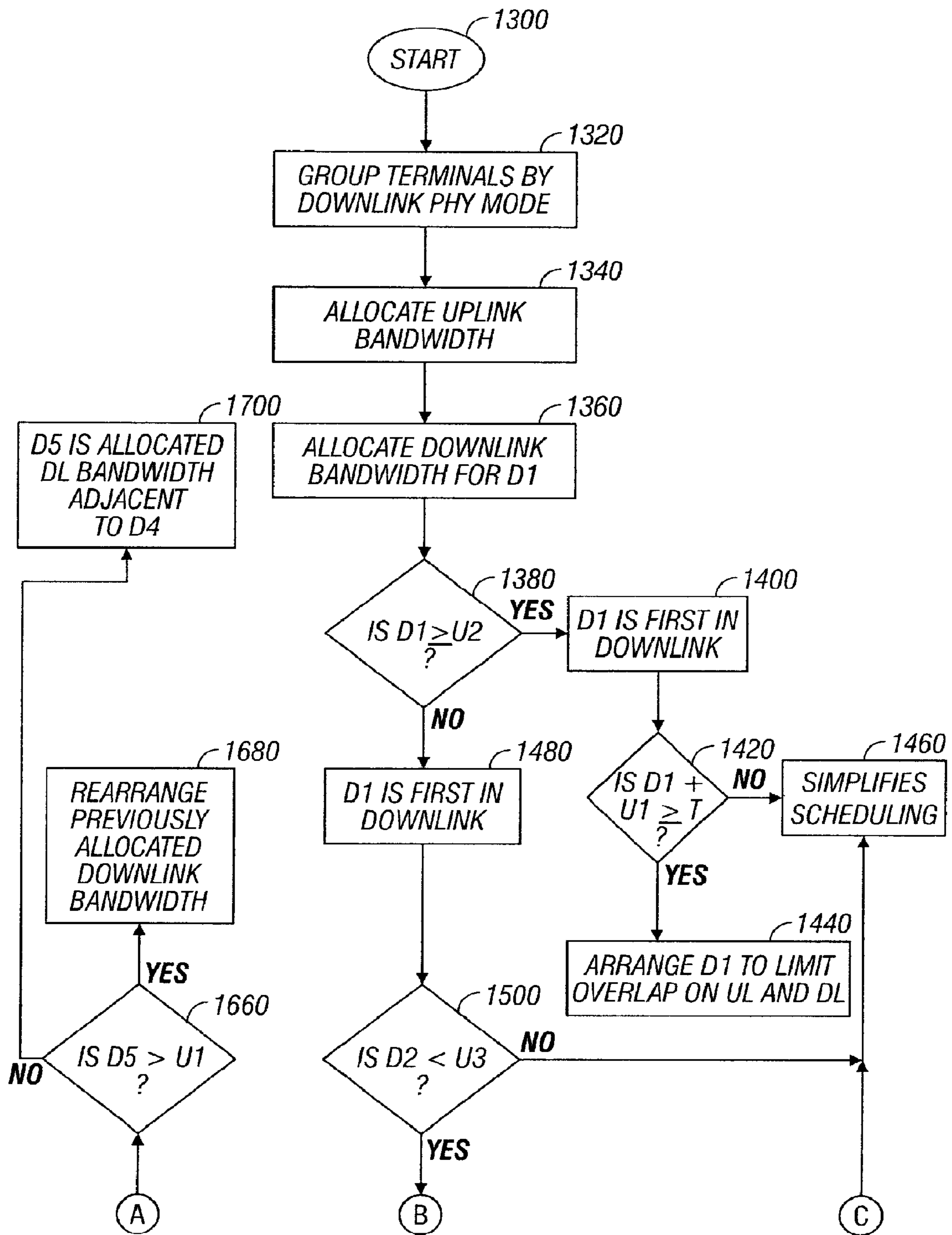

FIG. 13

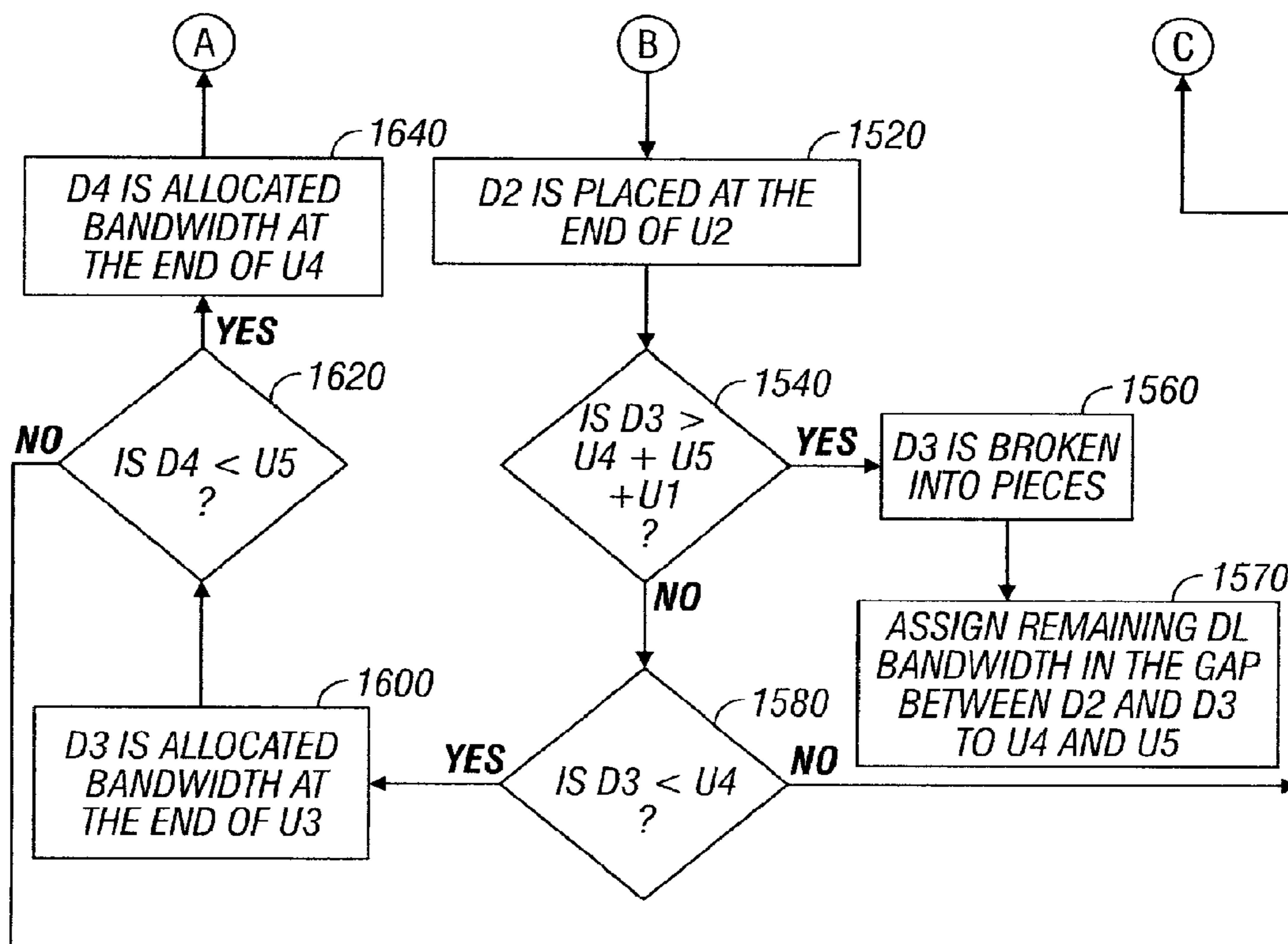

FIG. 13
(Continued)

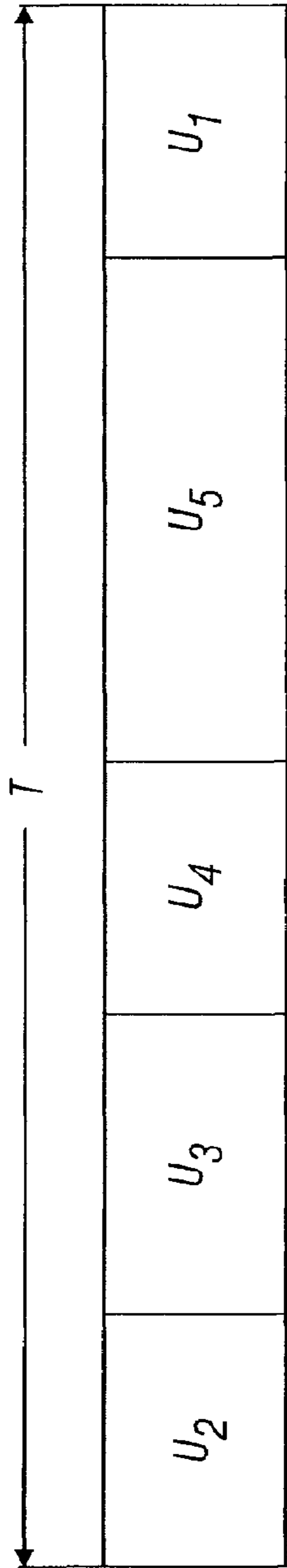

FIG. 14

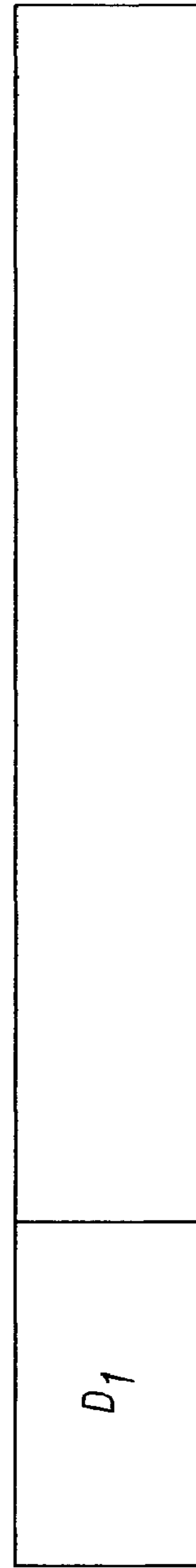
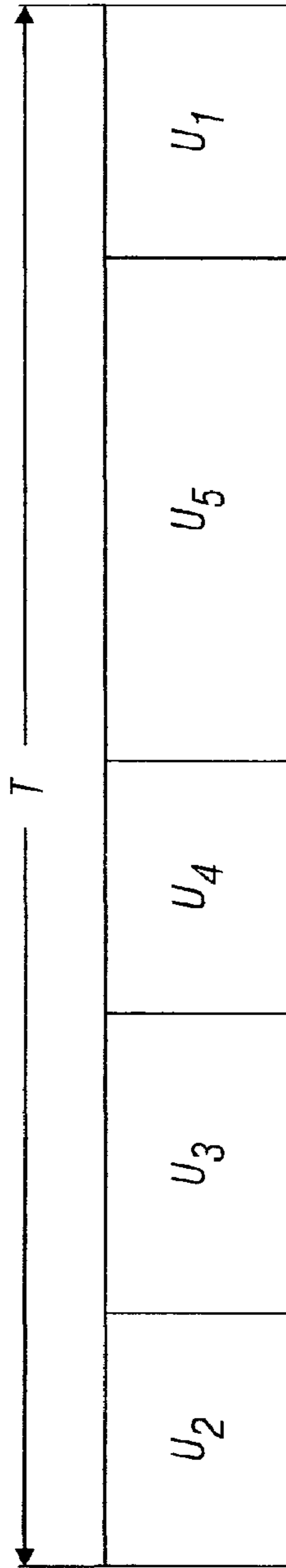

FIG. 15: $D_1 \geq U_2$

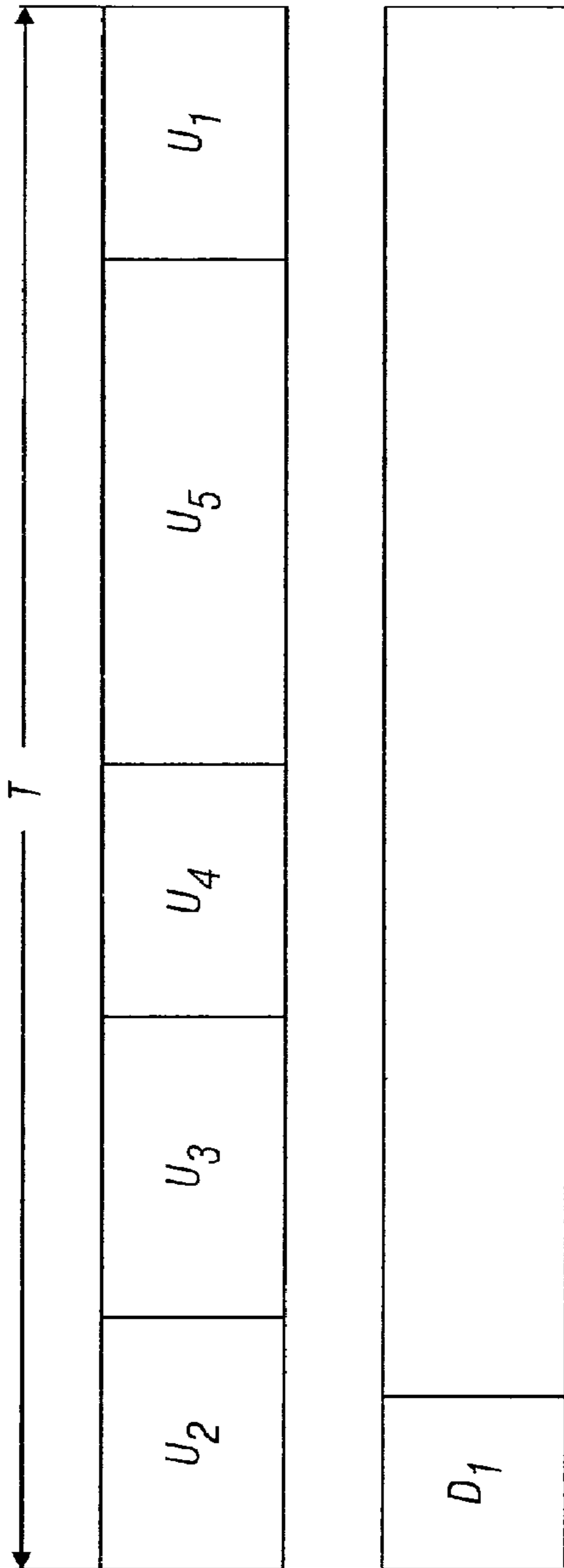

FIG. 16: $D_1 < U_2$

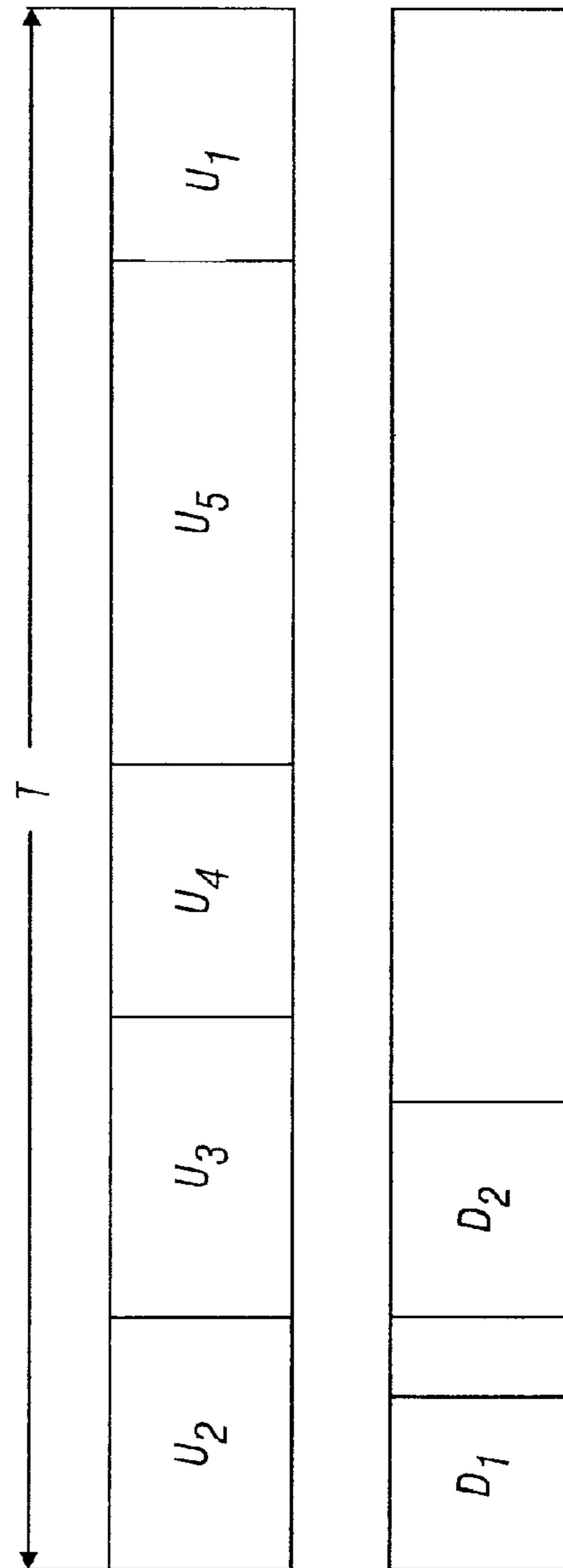

FIG. 17: $D_2 < U_3$

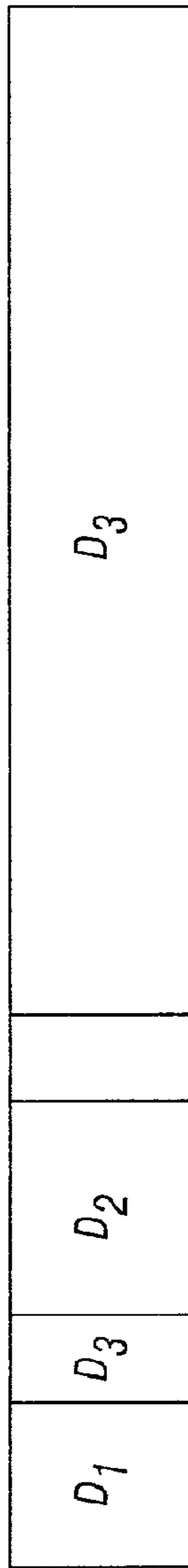
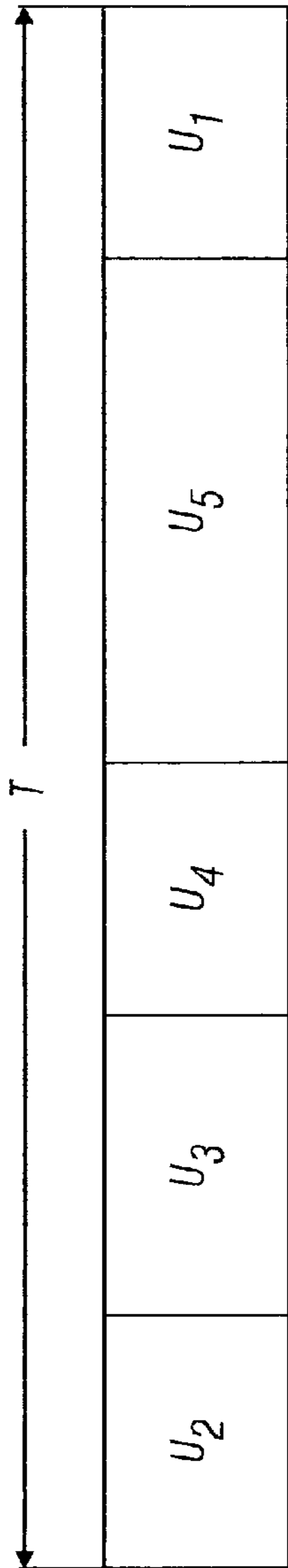

FIG. 18: $D_3 > U_4 + U_5 + U_1$

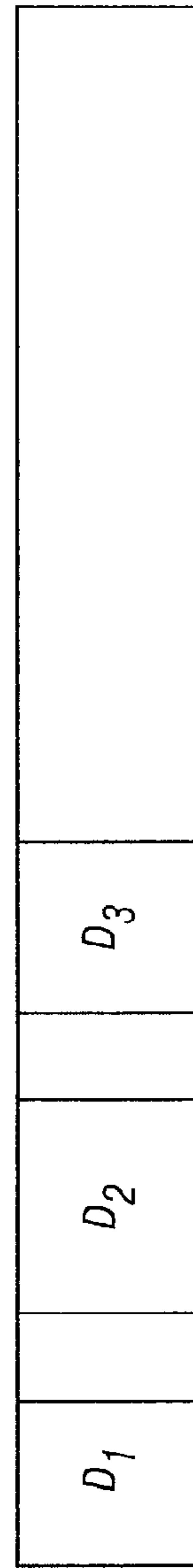
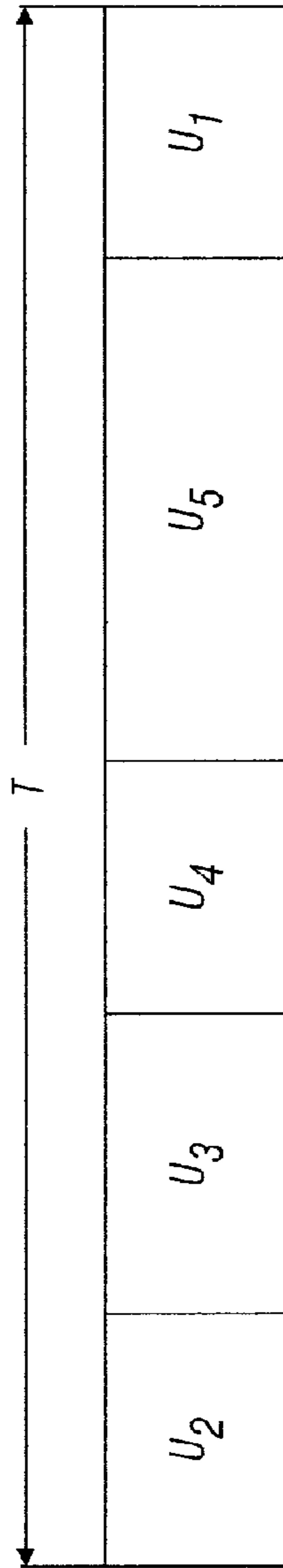

FIG. 19: $D_3 < U_4$

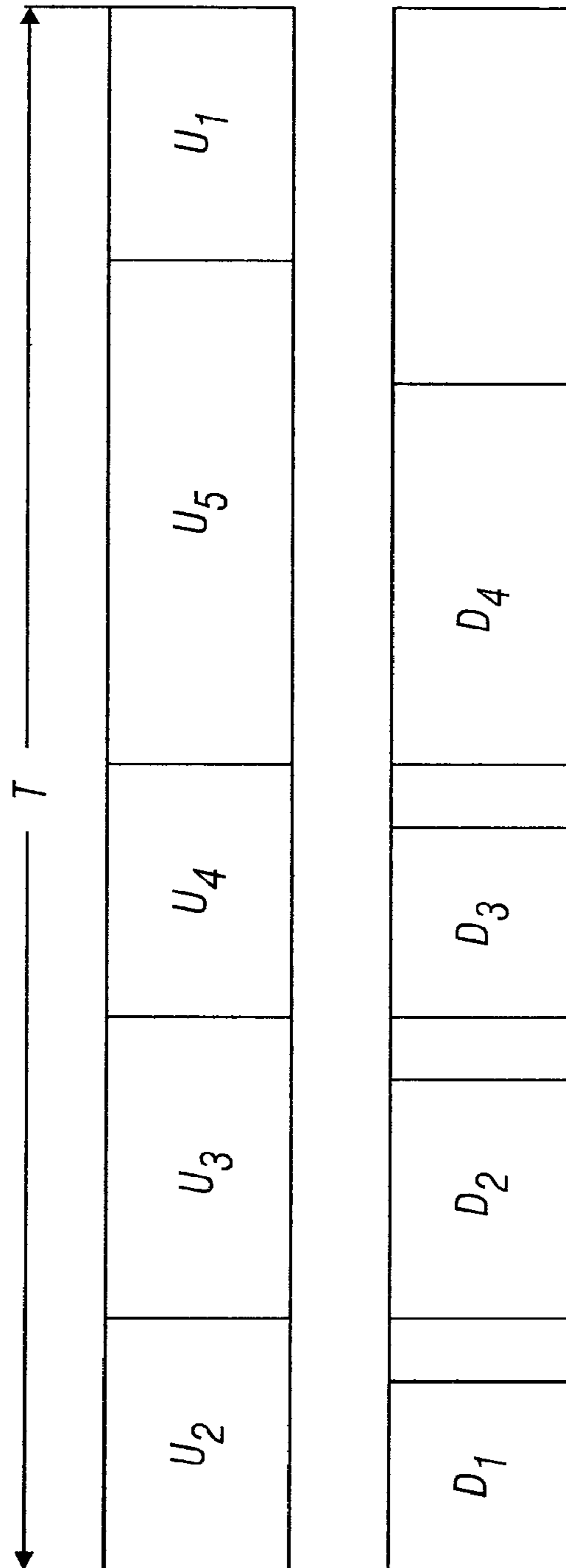

FIG. 20: $D_4 < U_5$

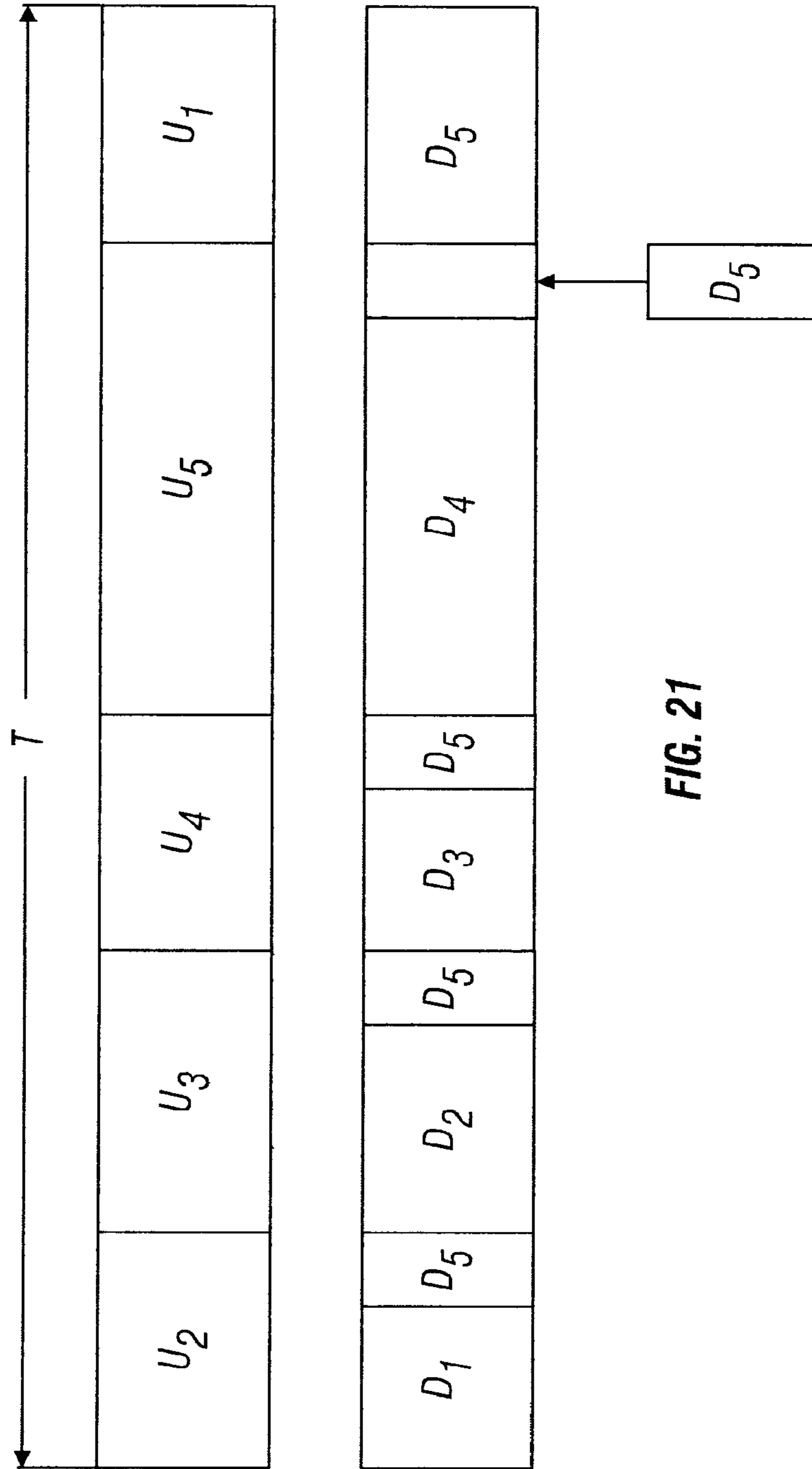

FIG. 21

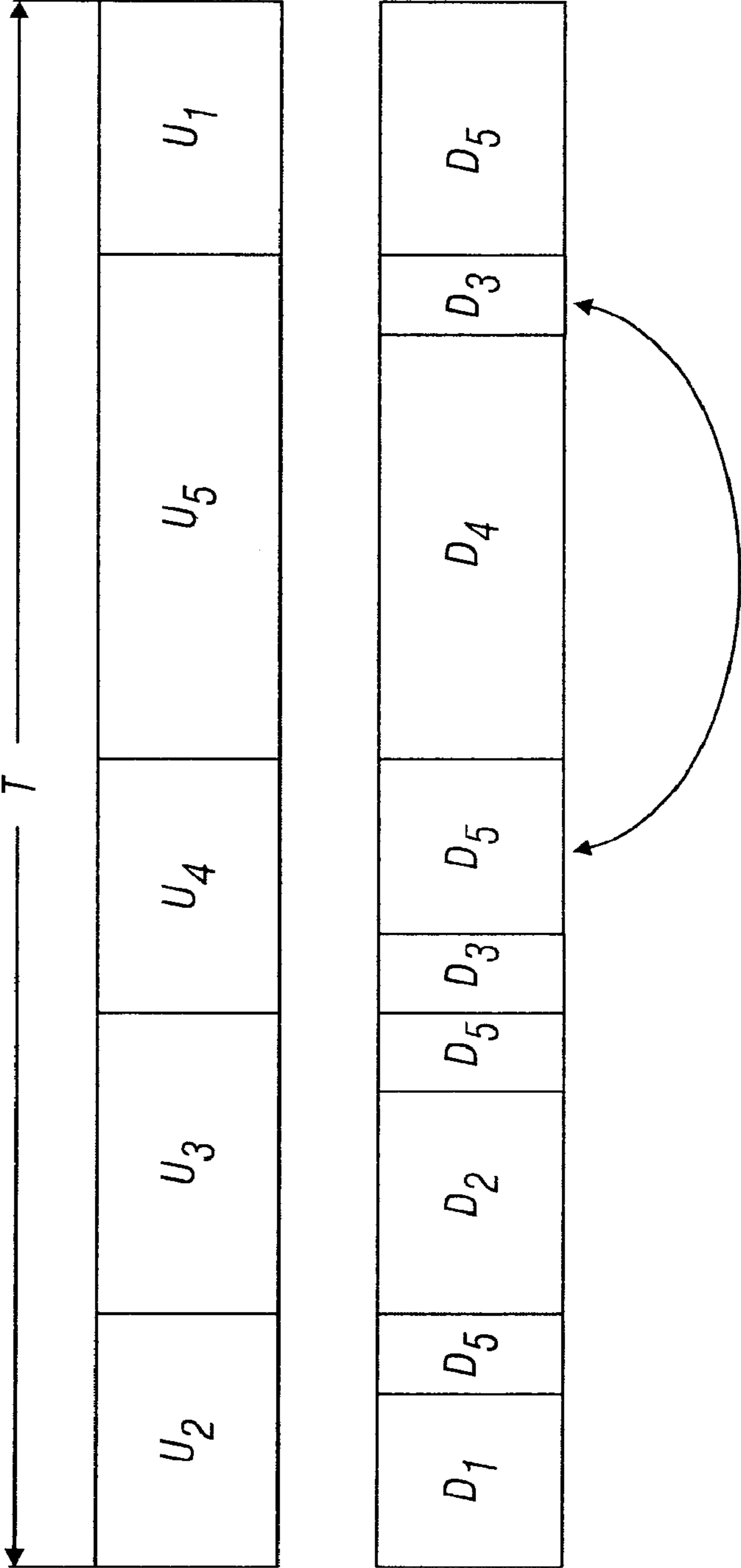

FIG. 22

FRAMING FOR AN ADAPTIVE MODULATION COMMUNICATION SYSTEM

RELATED APPLICATIONS

This application is a continuation of U.S. patent application Ser. No. 12/035,549 filed Feb. 22, 2008, which is a continuation of U.S. patent application Ser. No. 11/674,548 filed Feb. 13, 2007, now U.S. Pat. No. 7,379,441, which is a divisional of U.S. patent application Ser. No. 09/991,532 filed Nov. 15, 2001, now U.S. Pat. No. 7,197,022, titled "Framing For An Adaptive Modulation Communication System" which claims priority to a U.S. provisional patent application Ser. No. 60/249,065, filed Nov. 15, 2000, titled "Framing For an Adaptive Modulation Communication System," all of which are hereby incorporated by reference in their entirety.

BACKGROUND OF THE INVENTION

1. Field of the Invention

This invention relates to frame structures for communication systems and more particularly to frame structures for adaptive modulation wireless communication systems.

2. Description of Related Art

A wireless communication system facilitates two-way communication between a plurality of subscriber units (fixed and portable) and a fixed network infrastructure. Exemplary communication systems include mobile cellular telephone systems, personal communication systems (PCS), and cordless telephones. The key objective of these wireless communication systems is to provide communication channels on demand between the plurality of consumer subscriber units and their respective base stations in order to connect the subscriber unit user with the fixed network infrastructure.

Subscriber units typically communicate through a terminal with the base station using a "duplexing" scheme thus allowing the exchange of information in both directions of connection. Transmissions from the base station to the terminals are commonly referred to as "downlink" transmissions. Transmissions from the terminals to the base station are commonly referred to as "uplink" transmissions. In wireless systems having multiple access schemes a time "frame" is used as the basic information transmission unit.

Depending upon the design criteria of a given system, systems have typically used either time division duplexing (TDD) or frequency division duplexing (FDD) methods to facilitate the exchange of information between the base station and the terminals. In a TDD communication system, the base station and the terminals use the same channel, however, their downlink and uplink transmissions alternate one after the other to prevent interference. In a FDD communication system, the base station and the terminals use different channels for their downlink and uplink transmissions, respectively. Thus, the concern for interference between uplink and downlink transmissions is mitigated in a FDD communication system as compared to a system using TDD. However, the increased cost and complexity in deploying a FDD communication system often outweighs this obvious advantage over a TDD communication system.

In both TDD and FDD systems, each base station and terminal includes a modem configured to modulate an outgoing signal and demodulate an incoming signal. If the modem is configured to modulate and demodulate simultaneously, the modem is a "full-duplex" modem. If the modem is not configured to modulate and demodulate simultaneously, but rather switches between modulating and demodulating, the modem is a "half-duplex" modem.

In an exemplary FDD communication system, each terminal's modem operates simultaneously to transmit and receive information in a full-duplex manner. Such a terminal can continually receive data from the base station. By continually receiving information, the terminal is able to maintain its synchronization with the base station. By maintaining its synchronization, the terminal is less dependent on the base station transmitting control information and preambles to assist the terminal in locating its data within the downlink.

Because a half-duplex terminal does not receive information from the base station when the terminal transmits it uplink to the base station, it may fall out of synchronization with the base station. When this occurs, the terminal may require the base station to downlink additional control information or a preamble to allow the terminal to re-synchronize prior to it receiving downlink data from the base station.

SUMMARY OF THE INVENTION

The systems and methods have several features, no single one of which is solely responsible for its desirable attributes. Without limiting the scope as expressed by the claims which follow, its more prominent features will now be discussed briefly. After considering this discussion, and particularly after reading the section entitled "Detailed Description" one will understand how the features of the system and methods provide several advantages over traditional framing techniques.

One aspect is a frequency division duplexing (FDD) wireless communication method for use by a base station, at least one full-duplex terminal, and at least one half-duplex terminal, wherein the base station transmits using a downlink subframe on a first channel and the full-duplex and half-duplex terminals transmit using an uplink subframe on a second channel, wherein the downlink subframe includes a broadcast preamble, a time division multiplex (TDM) portion, and a Time Division Multiple Access (TDMA) portion, and wherein the TDMA portion includes at least one modulation/forward error correction (PHY) mode with an associated preamble, both of which are intended for the at least one half-duplex terminal. The method comprises transmitting a broadcast preamble from a base station to a full-duplex terminal and a half-duplex terminal during a downlink subframe on a first channel, synchronizing the full-duplex terminal and the half-duplex terminal to the base station based on the broadcast preamble, transmitting modulated data from the half-duplex terminal to the base station during an uplink subframe on a second channel, and transmitting modulated data from the base station to the full-duplex terminal during a TDM portion of the downlink subframe on the first channel after the full-duplex terminal is synchronized with the base station. The method further includes transmitting a preamble by the base station during a TDMA portion of the downlink subframe on the first channel, wherein the preamble is transmitted after the half-duplex terminal has transmitted its modulated data to the base station, re-synchronizing the half-duplex terminal with the base station based on the preamble transmitted by the base station on the first channel.

Another aspect is a system for a frequency division duplexing (FDD) wireless communication system including a base station, at least one full-duplex terminal, and at least one half-duplex terminal, wherein the base station transmits using a downlink subframe on a first channel and the full-duplex and half-duplex terminals transmit using an uplink subframe on a second channel, wherein the downlink subframe includes a broadcast preamble, a time division multiplex (TDM) portion, and a Time Division Multiple Access

(TDMA) portion, and wherein the TDMA portion includes at least one modulation/forward error correction (PHY) mode with an associated preamble, both of which are intended for the at least one half-duplex terminal. The system comprises at least one half-duplex terminal configured to alternate between transmitting on a first channel and receiving on a second channel, at least one full-duplex terminal configured to transmit on the first channel while receiving on the second channel, and a base station configured to transmit a broadcast preamble to the half-duplex terminal and the full-duplex terminal during a TDM portion of a downlink subframe and to transmit a preamble during a TDMA portion of the downlink subframe, wherein the half-duplex terminal synchronizes with the base station based on the broadcast preamble and re-synchronizes with the base station based on the preamble.

Still another aspect is a method for scheduling modulation/forward error correction (PHY) modes for a frequency division duplex (FDD) communication system which includes a plurality of terminals and a base station, both configured to communicate using adaptive modulations in a downlink subframe and an uplink subframe, with each of the plurality of terminals having an associated preferred downlink PHY mode, D_1, D_2, \dots, D_N , wherein D_1 is a most robust modulation and D_N is a least robust modulation, and wherein each of the plurality of terminals and their associated preferred downlink PHY mode have an associated uplink PHY mode, U_1, U_2, \dots, U_N , and wherein U_1 is associated with the plurality of terminals that have the preferred downlink PHY mode D_1 , and wherein U_N is associated with the plurality of terminals that have the preferred downlink PHY mode D_N , such that a number of downlink map entries does not exceed $2N+1$. The method comprises grouping the plurality of terminals based on preferred downlink PHY modes, allocating uplink bandwidth in an uplink subframe such that the plurality of terminals are put in order of their preferred downlink PHY modes, from a second most robust preferred downlink PHY mode and continuing in order of decreasing robustness with a most robust preferred downlink PHY mode last, allocating the plurality of terminals that use a D_1 PHY mode to begin at a start of a downlink subframe, and if a time duration for the plurality of terminals that have a D_N PHY mode is less than a time duration for the plurality of terminals that are assigned to a U_{N+1} PHY mode, allocating bandwidth of the downlink subframe to the plurality of terminals that use the D_N PHY mode, beginning at a time that a U_N PHY mode ends. The method further includes that if the time duration for the plurality of terminals that have the D_N PHY mode is greater than or equal to the time duration for the plurality of terminals that are assigned to the U_{N+1} PHY mode, allocating bandwidth of the downlink subframe to the plurality of terminals that use the D_N PHY mode, beginning at an end of a D_{N-1} PHY mode, if the time duration of the plurality of terminals that have the D_N PHY mode is longer in duration than a combined time duration of a U_1 PHY mode and gaps that are not aligned with the U_N PHY mode, rearranging downlink bandwidth of the downlink subframe to accommodate a remainder of the D_N PHY mode such that the remainder is not aligned with the U_N PHY mode, and if the time duration of the plurality of terminals that have the D_N PHY mode is shorter in duration than the combined time duration of the U_1 PHY mode and the gaps that are not aligned with the U_N PHY mode, allocating bandwidth of the downlink subframe to the plurality of terminals that use the D_N PHY mode, beginning at the end of the D_{N-1} PHY mode and also interleaved in the gaps in the downlink subframe.

Still other aspects include methods and systems for use in a TDD communication system to support the implementation of smart antennae.

BRIEF DESCRIPTION OF THE DRAWINGS

FIG. 1 is a diagram of a configuration of a communication system with a base station and several associated terminals.

FIG. 2 is a diagram of an exemplary time division duplex ("TDD") frame structure along with an exemplary mapping structure.

FIG. 3 is a block diagram of an exemplary transmitter.

FIG. 4 is a block diagram of an exemplary receiver.

FIG. 5 is the TDD frame structure from FIG. 2 adapted for FDD operation.

FIG. 6 shows an arrangement for user data from multiple terminals in a TDM time block.

FIG. 7 shows a downlink conflict for a FDD unit restricted to half duplex operation.

FIG. 8 is a mapping diagram for a combined FDD TDM/TDMA downlink subframe.

FIG. 9 shows an exemplary downlink map structure.

FIG. 10 shows an exemplary relationship between frame mapping data and the data it maps for a FDD communication system.

FIG. 11 is a mapping diagram for an FDD TDM/TDMA downlink subframe which varies PHY modes based on modulation and FEC.

FIG. 12 is a mapping diagram for a TDD TDM/TDMA downlink subframe that supports smart antennae.

FIG. 13 is a flow chart for a scheduling algorithm.

FIG. 14 shows an ordering of uplink PHY modes, U_2, U_3, U_4, U_5, U_1 , within an uplink subframe.

FIG. 15 represents the situation where the duration of downlink PHY mode D_1 equals or exceeds the duration of uplink PHY mode U_2 .

FIG. 16 represents the converse case to FIG. 15, in which the duration of downlink PHY mode D_1 is less than the duration of uplink PHY mode U_2 .

FIG. 17 represents the situation where the duration of uplink PHY mode U_3 exceeds the duration of downlink PHY mode D_2 .

FIG. 18 represents the situation where the duration of downlink PHY mode D_3 exceeds the combined duration of uplink PHY modes U_4, U_5 , and U_1 .

FIG. 19 represents the situation where the duration of downlink PHY mode D_3 is less than the duration of uplink PHY mode U_4 .

FIG. 20 represent the situation where the duration of downlink PHY mode D_4 is less than the duration of uplink PHY mode U_5 .

FIG. 21 represents a scheduling of downlink PHY mode D_5 within the downlink subframe that results in PHY mode D_5 having to transmit while it receives.

FIG. 22 represents further rearrangement of downlink PHY mode D_5 with downlink PHY mode D_3 so that downlink PHY mode D_5 does not transmit while it receives.

DETAILED DESCRIPTION

The following detailed description is directed to certain specific embodiments of the invention. However, the invention can be embodied in a multitude of different systems and methods. In this description, reference is made to the drawings wherein like parts are designated with like numerals throughout.

5

FIG. 1 is a diagram of an exemplary cell **10** that includes a base station **20** located centrally in cell **10** and a plurality of terminals **30, 32, 34, 36, 38** associated with the base station. FIG. 1 does not show buildings or other physical obstructions (such as trees or hills, for example), that may cause channel interference between signals of the terminals. The terminals and the base station communicate by transmitting radio frequency signals. The term channel is used to mean a band or range of radio frequencies of sufficient width for communication, e.g., 26.500 GHz to 26.525 GHz (a 25 MHz wide channel). Although the following discussion relates to a system that transmits information within the Local Multi-Point Distribution Services (LMDS) band at frequencies of approximately 28 GHz, the system is not so limited. Embodiments of the system are designed to transmit information between the terminals and base station at frequencies, for example, of 10 GHz to 66 GHz using Quadrature Amplitude Modulation (QAM) symbols. The base station and terminals use adaptive modulation and forward error correction (FEC) schemes to communicate. Adaptive modulation, or adaptable modulation density, includes varying the bit per symbol rate modulation scheme, or modulation robustness, of signals transmitted between a terminal and a base station. Adaptive FEC includes varying the amount of error correction data that is transmitted in the signal. Both the modulation and FEC can be adapted independently to transmit data between the base station and terminals. For ease of explanation, the phrase "PHY mode" is used to indicate a combination of a selected modulation scheme with a selected FEC.

The systems and methods described herein can also be implemented in a Multichannel Multi-point Distribution Service (MMDS) which operates below 10 GHz. In the MMDS, Orthogonal Frequency Division Multiplexing (OFDM) symbols may be transmitted between the base station and terminals as an alternative to QAM modulation. In such a system, the methods and systems are applied to one or more of the OFDM subchannels.

The PHY mode(s) selected for use in the cell **10** is normally determined as a function of the geographical relationship between the BS and the terminal, the rain region, and the implementation or modem complexity of the terminals. However, the selection of a single PHY mode based on the lowest bit per symbol rate modulation scheme and maximum FEC supported by all terminals may not optimize bandwidth utilization within the cell **10**. In particular, better environmental conditions, e.g., less distance, between some terminals (such as units **38, 30** for example) and the BS may permit the use of a less robust PHY mode that has an error level below the maximum desirable error level.

FIG. 2 is diagram of an exemplary physical layer frame structure for use in the cell **10** that enables adaptive PHY modes to be employed. FIG. 2 also illustrates a process for mapping data to the physical layer frame structure for transmission to one or more terminals. The PHY mode may be modified from frame to frame or remain constant for a plurality of frames for a particular terminal. Further, a terminal may select or indicate a preferred PHY mode.

Frame **80** includes a plurality of time blocks. The total time duration of the plurality of time blocks in frame **80** can vary. For example, time durations of 0.5 msec, 1 msec, and 2 msec could be used. In this example there are ten time blocks where the first through fifth time blocks are for a downlink subframe **83**. The downlink subframe contains downlink data **82(a)-82(n)** (from the base station **10** to one or more terminals). The sixth through tenth time blocks form an uplink subframe **85**. The uplink subframe contains uplink data **84(a)-84(n)** (to the

6

base station **10** from one or more terminals). Data within a single time block is transmitted or received using a single PHY mode.

In this example, each downlink subframe time block has a different PHY mode, e.g. $DM_1, DM_2, DM_3,$ and DM_4 . The data transmitted using each downlink PHY mode is intended for one or more terminals. The receiving terminal will retrieve data that was transmitted using its preferred PHY mode and/or a more robust PHY mode. Many terminals may be assigned to any one downlink PHY mode where each terminal retrieves its data during the same time block based on an address or identifier. Consequently, a terminal may only retrieve data from a portion of a time block.

Still referring to FIG. 2, the uplink subframe time blocks are associated with PHY modes, e.g. $UM_1, UM_2, UM_3,$ and UM_4 . Uplink time blocks are assigned to terminals for transmission of data from one or more terminals to the base station. Multiple terminals may be assigned to a single time block based on the terminals preferred PHY mode. For example, terminals **30, 38** could be assigned to UM_1 . The length of the UM_1 will account for the bandwidth requirements of both terminals. In such a case, a transition gap (not shown) may be included between the portions of the uplink subframe time block, UM_1 , that are assigned to the two terminals. The transition gap can include a preamble for the base station to synchronize with the transmitting terminal. As with the downlink PHY modes, an individual terminal may be assigned more than one uplink PHY mode.

The length, or duration, of each time block can vary. The PHY modes used for the data in each time block can also vary for each downlink and uplink time block between frames. Varying the time duration of the uplink and downlink time blocks, PHY modes, is generally useful, since uplink and downlink data amounts are likely to vary. The TDD frame structure may apply adaptive PHY modes only for the downlink and use a different scheme for the uplink. For example, a fixed modulation scheme could be used for the uplink. Conversely, a different scheme (e.g. fixed modulation) can be used on the downlink, while using adaptive PHY modes on the uplink.

A scheduling approach is used to arrange data from terminals within the frame **80**. An uplink scheduling approach may be selected independently from the downlink scheduling approach. The uplink/downlink scheduling approaches may be based on physical layer issues, including interference minimization, propagation delays (including round trip delays), etc., as well as modulation use (specific ordering by PHY mode). Alternatively, the uplink/downlink scheduling approaches may be based completely on data traffic requirements and not on physical layer issues.

One downlink scheduling approach arranges the PHY modes such that DM_1 (most robust) $\leq DM_2 \leq DM_3 \leq DM_4$ (least robust). Thus, the data in the downlink subframe is arranged from the most robust PHY mode to the least robust PHY mode. Each terminal listens to its preferred PHY mode and any PHY modes that are more robust than its preferred PHY mode. The terminals receive all of the data they are capable of receiving, and can keep or discard portions of the data depending on whether the data is intended for them. By using this scheduling approach, each terminal is able to maintain its synchronization with the base station from the start of the downlink subframe, through PHY modes that are more robust than its preferred PHY mode, and finally during its preferred PHY mode.

The uplink scheduling information may be conveyed to the terminals by a map through control data **86**. The control data **86** may be located at the start of the downlink subframe **83**.

The control data **86** can indicate where the PHY mode transitions occur within the frame **80**. A typical map is a list of time indicators pointing out transmission location (such as by referencing start and end, or start and length, or offsets relative to a previous transmission). The map can also include terminal identification associating the map entry with a specific terminal. The control data **86** can be encoded using the most robust PHY mode of the system. An exemplary downlink map is discussed below with reference to FIG. 9.

Still referring to FIG. 2, an unsolicited region **88** of the uplink subframe **85** is used by the terminals to communicate control information, such as, bandwidth and registration requests, to the base station. Information placed in the unsolicited region **88** can be encoded using the most robust PHY mode of the system. The unsolicited region **88** can be located at the beginning of the uplink subframe **85**.

The downlink subframe **83** transmits the control data **86** along with downlink data **82** intended for one or more terminals. Downlink data symbols **81** are used for transmitting data to the terminals. The symbols may be grouped by the PHY mode, terminal identification, and user ID. For example, symbols **81** are grouped by PHY mode, DM2. Thus, the symbols **81** destined for terminals that are scheduled to receive during DM2 were modulated using the same PHY mode. Once grouped by PHY modes, each time block is transmitted in a pre-defined modulation sequence using a scheduling approach as previously discussed. For example, DM1 is QAM-4, DM2 is QAM-16, DM3 is QAM-64, and DM4 is QAM-256. In any downlink subframe **83**, any one or more of the PHY modes may be absent.

The data transmitted during frame **80** is in the form of symbols **81**. Communication systems that operate using the LMDS band map Quadrature Amplitude Modulation (QAM) symbols to each time block of frame **80**. Alternatively, communication systems that operate using the MMDS band do the same or may map Orthogonal Frequency Division Multiplexing (OFDM) symbols to each time block of frame **80**.

FIG. 2 also shows an exemplary downlink mapping of a stream of variable length media access control (MAC) messages **1200** to symbols **81** for transmission during the frame **80**. More specifically, the mapping shown in FIG. 2 is used for messages intended for terminals with the same preferred PHY mode, DM2. One or more MAC messages **1200** are fragmented and packed into Transmission Convergence Data Units (TDUs) **1206**. Each TDU **1206** includes downlink data **82(b)** in the form of i bits which may include Transmission Convergence (TC) layer overhead. Each TDU **1206** for a given PHY mode has a fixed length. For example, in FIG. 2, each TDU is comprised of $i=228$ bits which include 20 bits of TC overhead resulting in the ability to carry 208 bits of MAC message data. Forward error correction (FEC) j bits are added to the i bits of the TDU **1206** to form Physical Information (PI) elements **1202**, alternatively called FEC blocks. Each PI element **1202** has a length of k bits (i bits + j bits). The addition of j bits reduces the likelihood of bit errors occurring during demodulation by the terminals. For example, the 228-bit TDUs **1206** can be mapped to 300-bit PIs **1202** by encoding the data in the TDUs **1206**. The 228-bit TDU **1206** may be encoded using the well-known Reed-Solomon coding technique to create the 300-bit PI elements **1202**. Other minimum quantities of the physical and logical units can be used without departing from the scope of the present invention.

Padding may be added to a MAC message to form an integer multiple of TDUs **1206**. For example, FIG. 2 shows padding being added to "message n " so that the result will form an integer multiple of TDUs **1206** and, therefore, an integer multiple of PI elements **1202**. The padding can use a

fill byte, for example, 0x55. Alternatively, the last PI element **1202** may be shortened, if allowed by the FEC, resulting in a shortened TDU. The process of producing shortened PI elements **1202**, a.k.a. FEC blocks, is well-known in the arts.

The PI elements **1202** are then modulated using a modulation scheme to form symbols **81**. For example, QAM symbols or OFDM symbols could be used. The number of symbols **81** required to transmit the PI elements **1202** may vary with the PHY mode selected. For example, if QAM-4 is used for DM2, each resulting symbol represents two bits. If QAM-64 is used for DM2, each resulting symbol represents six bits. For convenience, multiple symbols can be further mapped to a physical slot (PS) to decrease the granularity of the data allocation boundaries. For example, a 4-symbol physical slot could be used to decrease the number of bits required to express allocation boundaries in maps.

FIG. 3 is a block diagram of functional elements of an exemplary transmitter **40**. The transmitter **40** can include a convolutional encoder **42**, a block encoder **44**, a M-ary Modulator **46**, and an up-converter **49**. The transmitter **40** receives i bits of data and encodes the data, packs the encoded bits of data into frame **80** and upconverts the frame of data to a transmission frequency. The convolutional encoder **42** and block coder **44** supply the FEC data that converts the i bits of data into FEC blocks. For example, the convolutional encoder **42** can use a selected ratio to encode i bits of data. The block coder uses the selected code level to encode the convoluted data to produce FEC blocks.

Then, the M-ary QAM modulator converts the FEC blocks into QAM symbols based on the selected bit per symbol rate for each time block. The symbols can then be inserted into the frame **80** using a scheduling technique. Up-converter **49** frequency shifts the packed frame of data to a frequency suitable for transmission between a terminal and base station based on schemes known to those of skill in the art.

FIG. 4 is a block diagram of functional elements of an exemplary receiver **50**. The receiver **50** converts the frequency shifted frame of data back into groups of bits of data. The receiver **50** includes a down-converter **59**, M-ary QAM demodulator **56**, block decoder **54**, and convolutional decoder **52**. The down-converter **59** frequency shifts the received signal back to baseband using schemes known to those of skill in the art. Block decoder **54** decodes the symbols into FEC blocks using schemes known to those of skill in the art. Then, the convolutional decoder decodes the FEC blocks to produce i bits of data. The methods and frame structures described below are performed by the functional elements of the transmitter and receiver described above with reference to FIGS. 3 and 4.

Referring now to FIG. 5, a frame structure **90**, which has been adapted from frame structure **80** (see FIG. 2), for use in a FDD communication system is shown. The terminals and base station communicate using a series of uplink subframes and a series of downlink subframes. FIG. 5 illustrates two uplink subframes **92(a)**, **92(b)** in a series of uplink subframes and two downlink subframes **94(a)**, **94(b)** in a series of downlink subframes. The downlink subframe is transmitted simultaneously with the uplink subframe on different frequency carriers. This is not possible in the TDD system of FIG. 2. Between the downlink and uplink subframes, the modulation regions may differ in size. This is generally useful, since uplink and downlink data amounts are likely to vary between different terminals. The different modulation densities available to different terminals will affect the transport time they require.

In the FDD frame structure **90**, the uplink and the downlink operation may or may not be synchronized. For example, a

frame start and a frame end, hence frame length, may be identical, or not, depending on the specific implementation. The FDD frame structure may apply adaptive modulation only for the downlink and use a different scheme for the uplink. For example, a fixed modulation scheme could be used for the uplink. Conversely, a different scheme (e.g. fixed modulation) can be used on the downlink, while using adaptive modulation on the uplink.

FIG. 6 shows an arrangement for arranging data from multiple terminals into a single Time Division Multiplexing (TDM) time block. Terminals receiving the same modulation (or, more generally, having the same modulation and FEC, i.e. PHY mode) will often be grouped together for downlink transmissions. The data from all terminals using the same PHY mode are multiplexed together. This means that various data packets **102** associated with one terminal could be mixed with data packets of other terminals depending on the exact queuing mechanism which prepared the data for transmission. In this case, while a terminal is receiving a downlink transmission it is required to demodulate all symbols in the time block which uses its assigned modulation. A higher layer addressing mechanism, such as headers, associates the terminal with the data belonging to it.

FIG. 7 shows a potential downlink conflict for an FDD terminal restricted to half-duplex operation. The half-duplex terminal can represent a terminal **30, 32, 34, 36, 38** (see FIG. 1) operating in an FDD communication system. The half-duplex terminal is unable to simultaneously receive while transmitting. The half-duplex terminal has knowledge of the least robust PHY mode the base station will use to transmit, and will listen to PHY modes which are at least as robust as its preferred PHY mode. However, the half-duplex terminal will be unable to listen to PHY modes that conflict with their scheduled uplink events. Thus, a conflict can occur if the terminal was scheduled to transmit to the base station while receiving from the base station.

To prevent a conflict from occurring, the terminal's uplink transmission (Tx) event **110** is preferably not scheduled at the same time as its downlink event **112**. However, the terminal may lose synchronization with the base station during its uplink Tx event **110** and be unable to re-synchronize prior to the base station transmitting its downlink event **112**. The loss of synchronization may become more problematic in a communication system that includes multiple terminals restricted to half-duplex operation. For example, in a case where all of the terminals in an FDD communication system operate in a half-duplex fashion, time gaps may occur in a frame during a downlink or uplink. Such time gaps may constitute a significant part of that portion of the frame to which such a terminal's use is restricted.

The downlink subframe structure shown in FIG. 7 alleviates this issue by allowing re-synchronization of half-duplex terminals during the downlink subframe. Specifically, the frame structure of the downlink **94** is Time Division Multiple Access (TDMA). The TDMA structure allocates a portion of the downlink subframe for preambles **106**. If a terminal loses synchronization with the base station during the uplink Tx event **110**, the preamble **106** allows the terminal to re-synchronize with the base station prior to receiving its downlink.

Each terminal synchronizes and picks up control data **114**, including uplink and downlink mapping information, at the beginning of every downlink subframe **94**. The uplink map defines when the next uplink Tx event **110** will occur for each terminal in the uplink subframe **92**. Similarly, the downlink map is used by terminals to determine when downlink events **112** will occur in the downlink subframe **94**. For example, a

downlink map entry can indicate when the downlink subframe will transmit data with a specific PHY mode.

Uplink and downlink events can contain data associated with more than one user of the terminal. Higher layer addressing may be applied to determine specific associations of user data. The downlink map entry is not required to contain terminal identification information. Instead, a terminal which ended its uplink transmission and is available for downlink reception can use the downlink map to determine the next event which is relevant for it, that is, the next event that uses its preferred PHY mode, i.e. modulation parameters and FEC, which correspond to its settings. This mapping information will be further explained with reference to FIG. 9. The downlink event **112** for a terminal is preceded by a preamble **106** in the downlink subframe **94**. The preamble allows the terminal to quickly re-synchronize prior to demodulating the data in the downlink event **112**. When the downlink event **112** ends (meaning that demodulation process of the associated data terminates), the terminal is ready for the next uplink Tx event as defined in the uplink map.

FIG. 8 is a mapping diagram for a combined FDD TDM/TDMA downlink subframe for use with half-duplex and full-duplex terminals. When an FDD communication system includes differing terminal types, i.e. half-duplex and full-duplex, additional scheduling difficulties may occur. The frame structure shown in FIG. 8 alleviates these issues by combining TDMA and TDM in a single downlink subframe **124**. The TDM is utilized for bandwidth efficiency and the TDMA is used for half-duplex terminal support as will be explained below. In an FDD communication system having only full-duplex terminals, there is no need to use the TDMA portion. The same is true for any individual frame in which only full-duplex terminals are scheduled to transmit in the uplink. Conversely, in a typical TDD communication system only the TDM portion needs be used even if the communication system includes half-duplex terminals. However, the use of the TDMA portion in a TDD communication system allows the base station to utilize a smart antenna for downlinks. In such a TDD system, each terminal can re-synchronize with the base station during the downlink subframe.

Each downlink subframe **124** can include a frame control header **125** and downlink data **121**. The frame control header **125** can include a preamble **126**, PHY control information **127**, and media access control (MAC) information **128**. The preamble **126** is used for synchronizing the terminals with the base station. For example, preamble **126** allows the terminals to synchronize with the base station at the beginning of the downlink subframe **124**. The preamble can be transmitted using a robust PHY mode. A robust PHY mode allows terminals that are configured for receiving only robust modulation schemes to demodulate the preamble and synchronize with the base station.

The PHY control information **127** can include a downlink map **123**. The downlink map **123** indicates to the terminals where and what modulation changes occur in the downlink data **121**. An exemplary downlink map **123** is discussed below with reference to FIG. 9.

The MAC control information **128** provides terminals with instructions on transmission protocols for the uplink subframe. These instructions can include an uplink map **129**. The uplink map **129** is a map of a subsequent uplink subframe that is to be transmitted by the terminals.

To minimize errors in the mapping process, the base station transmits the downlink map and the uplink map using a robust PHY mode. Moreover, the base station can allocate a minimum number of symbols for the TDM portion **122** to accommodate the time required for the terminals to process and act

11

upon the first downlink map entry. The downlink map **123** is the first information broadcast to the terminals in a downlink subframe to maximize the amount of time between receiving the downlink map and when the first terminal is required to act based on the downlink map. All other control information **125**, including the uplink map **129**, can come after the broadcast of the downlink map **123**.

A full-duplex terminal, and any half-duplex terminal that receives later than it transmits within a frame, can take advantage of the TDM portion **122** of the downlink subframe **121**. Thus, the downlink data **124** starts with a TDM portion **122**. Additionally, to increase statistical multiplexing gain, it should be noted that full-duplex terminals are also able to re-synchronize with the base station in the TDMA portion **120** to receive data. Accordingly, the downlink subframe **124** is constructed with a TDM portion **122** followed by a TDMA portion **120**. The downlink map **123** for a pure TDMA downlink subframe would have the same number of map entries as the TDM/TDMA downlink subframe of FIG. 8. However, differences include the presence or absence of preambles **106** in the TDMA portion **120**, and the desirability of ordering the TDM portion **122** by PHY mode robustness.

FIG. 9 shows the structure of an exemplary downlink map **123** from FIG. 8 for use with a TDM/TDMA frame structure. The downlink map **123** allows the terminals to recognize PHY mode transitions in the downlink. The exemplary downlink map **123** can be any sequence of time indicators pointing out transmission location (such as by referencing start and end, or start and length, or offsets relative to a previous transmission) and terminal identification associating the map entry with a specific terminal. The time location information can be stated as a number of symbols referenced to frame start, or as any pre-defined unit of time understandable by the terminal. For example, if there are four modulation regions then four map entries are expected. If the map elements are using modulation symbols as time ticks, then a map containing "0123", "0234", "1119", and "2123" is interpreted as DM1 starting on symbol 123, DM2 starting on symbol 234, DM3 starting on symbol 1119, and DM4 starting at symbol 2123.

The exemplary downlink map **123** of FIG. 9 can include a sequence of 20 bit entries. In this example, four bits can contain a Downlink Interval Usage Code (DIUC) entry **142**. The DIUC defines the downlink PHY mode for each PHY mode in the downlink data **121** (see FIG. 8). The DIUC can indicate the PHY mode (i.e. modulation, FEC) and also whether the PHY mode is preceded by a preamble (TDMA) or not (TDM). For example, if a base station had five downlink PHY modes to select from for its downlink transmissions, the base station would require ten unique DIUCs to identify the possible combinations. Thus, the DIUCs could describe the transition points between PHY modes in the TDM portion **122** as well as for each PHY mode in the TDMA portion **120**. For example, the downlink map **123** may include entries for a begin TDM portion, a TDM transition to Q16, a TDM transition to Q64, an end of TDM portion, and an end of TDMA portion. Some formats have flexibility in terms of channel bandwidth and frame length. In these cases, the PS start field **144** may be used to represent physical slots rather than symbols, giving lower granularity of downlink allocation.

FIG. 10 shows one relationship between frame mapping data and the data it maps for an FDD communication system. The downlink map **123** (see FIG. 8) is valid for the frame in which it appears. For example, the downlink map in PHY Ctrl n-1 is valid for frame n-1 **131**. Similarly, the downlink map in PHY Ctrl n is valid for frame n **133**. The uplink map **129**

12

(see FIG. 8) can be valid for the next uplink subframe as shown in FIG. 10. The uplink subframe in FIG. 10 is shown synchronized with the downlink subframe. However, the start of the downlink subframe and the start of the uplink subframe do not have to be synchronized. In this case, the uplink map **129** in frame n-1 **131** can be valid for an uplink subframe that begins during frame n-1 **131**.

FIG. 11 is a mapping diagram for a FDD TDM/TDMA downlink subframe that varies FEC types for a given modulation scheme. The downlink subframe **130** is the same as described with respect to FIG. 8 except that a TDM portion **132** and a TDMA portion **134** both use a plurality of different FEC types in combination with different modulation types. For example, QAM-4 is used with FEC a in the TDM portion **132**. FEC a is the most robust FEC and is used for weak channels. Slightly stronger channels may use QAM-4 with a somewhat less robust FEC b in the TDM portion. A less forgiving modulation, such as QAM-64, may be used with different levels of FEC, such as FEC d and FEC e, in the TDM portion **132**. The TDMA portion **134** may also be defined by modulation type in combination with FEC type. For example, QAM-x is used with both FEC d and FEC c in the TDMA portion **134** of the downlink subframe **130**.

FIG. 12 is a mapping diagram for a TDM/TDMA downlink subframe that supports smart antennae. The downlink subframe **150** is the same as described with respect to FIG. 8 except that the TDMA portion is used for all of the downlink data **121**. While not recommended for efficiency, a downlink could be scheduled to be entirely TDMA. In practice, the TDMA portion need only be used in the presence of half-duplex terminals in a FDD communication system, and then only when the half-duplex terminals cannot be scheduled to receive earlier in the frame than they transmit. However, by extending the TDMA resynchronization capability to the entire downlink data **121** the base station could use smart antenna for its transmissions. This would allow the base station **20** to transmit to an individual terminal or a group of terminals within cell **10**. Each individual terminal or group of terminals would be able to re-synchronize with the base station **20** at the beginning of their burst.

Full-duplex terminals and half-duplex terminals that receive before they transmit could both use TDMA. The order of the PHY modes within the downlink subframe **150** could be varied. Each terminal would still receive a broadcast preamble **126** from the base station which would indicate when their preamble **106** would be transmitted by the base station. The use of a smart antenna would increase the gain of the received signal at the terminal. However, some bandwidth would be lost due to the addition of preambles and map entries.

A TDD communication system could also use the design of the TDMA downlink subframe **150** to incorporate a base station smart antenna. In the TDD communication system, only one channel is used for uplinks and downlinks. The terminals do not lose synchronization between the broadcast preamble **126** and the transmission of their data. Thus, if the PHY modes are ordered in the downlink and broadcast to an entire cell without a smart antenna, the terminals are able to maintain their synchronization. By incorporating a smart antenna at the base station, the terminals within the cell will lose synchronization. However, the use of a TDMA downlink subframe **150** and its preambles **106** as described above would allow the terminals to resynchronize with the base station prior to receiving their data.

When building an FDD communication system, full-duplex terminals are more efficiently served by a TDM downlink. Half-duplex terminals, however, are better served by a

TDMA downlink. However, in communication systems where both full and half-duplex terminals exist, scheduling the downlink and uplink transmission opportunities for the half-duplex terminals is non-trivial, since these terminals cannot transmit and receive simultaneously. Some half-duplex terminals may be scheduled to receive before they transmit. In this case, the base station can transmit downlink data to such half-duplex terminals in the TDM portion, since these terminals get synchronization from the preamble at the beginning of the downlink subframe. However, some half-duplex terminals are unable to be scheduled to transmit after they receive their data. Such terminals would lose the synchronization as they transmit, because they complete the transmission in the middle of the downlink subframe and hence have no preamble to use to synchronize their receiver to the base station.

One solution is to schedule the downlink data transmissions of these half-duplex terminals in a TDMA portion. This allows the terminals to receive the preamble at the beginning of the TDMA burst for receiver synchronization. Although this approach resolves the problem of half-duplex terminal receiver synchronization, each burst in the TDMA portion requires a DIUC message. The number of DIUC or map entries may grow if the number of TDMA bursts increases, wasting bandwidth for actual data transmission. Furthermore uplink maps are typically built only one frame ahead of time. Therefore, it is not possible to know the size of the downlink data for those half-duplex terminals in order to properly schedule the downlink data reception before transmission.

Scheduling Algorithm

A scheduling algorithm will now be described to allow TDM and TDMA portions of a downlink to co-exist in the same downlink subframe. The algorithm allows maximum flexibility and efficiency for FDD communication systems that must simultaneously support full and half-duplex terminals. The algorithm further allows the TDM of multiple terminals in a TDMA burst to minimize the number of map entries in a downlink map. The algorithm limits the number of downlink map entries to $(2 \times n) + 1$, where n is the number of PHY modes. The algorithm works for pure TDMA downlinks (see FIG. 12), and for downlinks where TDM and TDMA co-exist (see FIGS. 8 and 11). The scheduling algorithm is intended to be used in communication systems which allocate the uplink subframe ahead of building the downlink subframe.

Algorithm Description

First, all terminals are grouped together by the modulation/FEC (PHY mode) in which they receive downlink data. The number of groups formed will be equal to the number of PHY modes being used for downlink in the communication system. Uplink bandwidth is allocated to the terminals such that the uplink transmission opportunities of terminals belonging to the same group are kept contiguous in time.

Within these groupings, the uplink bandwidth allocated to an individual terminal is contiguous in time. The groups themselves can be ordered in a particular order to maximize the TDM portion of the downlink. To avoid the problem of scheduling the downlink and uplink transmission simultaneously in time for the terminals within the same group, the downlink data of the first group is scheduled first to overlap with the uplink bandwidth of the next group to be allocated. This proceeds until all the downlink data has been allocated.

Notations Used in the Scheduling Algorithm

n : the number of downlink (DL) PHY modes (e.g. FEC-type/Modulation combinations) used by system.

S_n : set of DL PHY modes, where PHY mode j , is more robust (comes earlier in the downlink TDM section) than DL PHY mode $j+1, j \in S_n$.

U_j : total amount of uplink bandwidth, in symbols (or in time, in an asymmetric FDD system), allocated for all terminals that receive downlink data using DL PHY mode j , where $j \in S_n$.

D_j : total amount of downlink bandwidth, in symbols (or in time, in an asymmetric FDD system), allocated for all terminals that receive downlink data using DL PHY mode j , where $j \in S_n$.

T : total amount of bandwidth, in symbols (or in time, in an asymmetric FDD system), available on the downlink channel.

u_k : total amount of uplink bandwidth, in symbols (or in time, in an asymmetric FDD system), allocated for an individual terminal, k .

d_k : total amount of downlink bandwidth, in symbols (or in time, in an asymmetric FDD system), allocated for an individual terminal, k .

System Constraints

The worst case scheduling is the case where all terminals are half-duplex.

For a half duplex terminal k , $d_k + u_k \leq T$.

There can only be one j , such that $D_j + U_j \geq T$.

Worst case is when

$$\sum_{j \in S_n} (D_j + U_j) = 2T$$

(The link is full, both uplink and downlink).

The following description is shown for the case when $n=5$. Those skilled in the art will understand that the algorithm may readily be extended to any value of n .

FIG. 13 is a flow chart for a scheduling algorithm. The scheduling algorithm process begins at a start state 1300. Next at a state 1320, all of the terminals are grouped by their downlink PHY modes. Flow proceeds to a state 1340 where uplink bandwidth is allocated for the terminals. The uplink bandwidth transmission opportunities are contiguous for terminals with the same downlink PHY mode. The total uplink bandwidth allocated for group j is U_j , where $j \in S_n$. Flow moves to a state 1360 where the groups are ordered in the downlink subframe. The uplink groups, U_j , are put in order of the robustness of their PHY modes, starting with the second most robust downlink ($j=2$) and continuing in order of decreasing robustness. The terminal group with the most robust DL PHY mode, U_n , last. This is shown in FIG. 14.

Flow continues to a state 1360 where the terminal group identified as $D_j, j=1$, is allocated downlink bandwidth at the start of the downlink subframe. Next, at a decision state 1380, the process determines whether $D_1 \geq U_2$. If $D_1 \geq U_2$ then flow continues to a state 1400 where the scheduling algorithm allocates downlink bandwidth for D_1 at the start of the downlink subframe. This is shown in FIG. 15.

Flow continues to a decision block 1420 to determine whether $D_1 + U_1 \geq T$. If $D_1 + U_1 \geq T$, the process continues to a state 1440 where D_1 is arranged such that an individual terminal's bandwidth does not overlap on the uplink and downlink, even while guaranteeing that the downlink map will not exceed $2n+1$. In this case there must be more than one terminal represented by D_1 .

Returning to decision block 1420, if $D_1 + U_1 \geq T$ is not true, then the process continues to a state 1460 where the downlink scheduling becomes easier since U_2 will not be transmitting while receiving. Subsequent allocations of downlink band-

15

width are placed adjacent to the prior allocations. For example, D_2 is placed next to D_1 in FIG. 15.

Returning to decision block 1380, if $D_1 < U_2$, then the process moves to a state 1480 where the scheduling algorithm allocates downlink bandwidth for D_1 at the start of the downlink subframe. This is shown in FIG. 16.

Flow continues to a decision block 1500 where a determination is made whether $D_2 < U_3$. If $D_2 < U_3$ is not true, flow continues to state 1460 where the downlink scheduling becomes easier since U_3 will not be transmitting while receiving. Subsequent allocations of downlink bandwidth are placed adjacent to the prior allocations. For example, D_3 is placed next to D_2 .

Returning to decision block 1500, if $D_2 < U_3$ flow continues to a state 1520 where the scheduling algorithm allocates downlink bandwidth for D_2 at the end of the uplink bandwidth that was allocated for U_2 . In this case, once the half-duplex terminal assigned to U_2 finishes its uplink transmission, it will begin receiving its downlink transmission during D_2 from the base station. A gap in the downlink subframe is left between D_1 and D_2 . This is shown in FIG. 17. If D_2 had been allocated downlink bandwidth adjacent to D_1 , a terminal assigned to D_2/U_2 would have possibly had a conflict. Note that in an event that D_2 overlaps with U_2 , terminals can be arranged such that no terminal in this group has uplink and downlink bandwidth overlap.

Next, at decision block 1540, a determination is made whether $D_3 > U_4 + U_5 + U_1$. If $D_3 > U_4 + U_5 + U_1$ is true, the process continues to a state 1560 where D_3 is broken into multiple pieces. The pieces are then inserted in the remaining gaps in the downlink subframe. This is shown in FIG. 18. Note that if D_3 overlaps with U_3 , terminals assigned to D_3 can be arranged such that no terminal in this group has uplink and downlink bandwidth overlap. The process continues to a state 1570 where the remaining downlink bandwidth, located between D_2 and D_3 , is allocated for downlink transmissions by terminals assigned to D_4 and D_5 .

Returning to decision block 1540, if a determination is made that $D_3 > U_4 + U_5 + U_1$ is not true, flow continues to decision block 1580 where a determination is made as to whether $D_3 < U_4$. If $D_3 < U_4$ is not true, the process returns to state 1460 where the downlink scheduling becomes easier since U_4 will not be transmitting while receiving.

Returning to decision block 1580, if $D_3 < U_4$, the process moves to a state 1600 where D_3 is allocated a portion of the downlink subframe beginning from the end of U_3 . A gap in the downlink subframe is left between D_2 and D_3 . This is shown in FIG. 19.

Next at decision block 1620, a determination is made whether $D_4 < U_5$. If $D_4 < U_5$ is not true, the process returns to state 1460 where the scheduling is easier. D_4 is placed at the end of its assigned uplink U_4 , so that D_4 will downlink once it finishes receiving its uplink, U_4 . Subsequent allocations of downlink bandwidth are placed adjacent to the prior allocations. For example, D_5 is placed next to D_4 .

Returning to decision block 1620, if $D_4 < U_5$, the process continues to a state 1640 where D_4 is placed at the end of U_4 . This is shown in FIG. 20. Next, at a decision state 1660, the algorithm determines whether the last downlink segment D_5 is longer in duration than U_1 and all remaining fragments excluding any fragment that is aligned with U_5 . If the algorithm determines downlink segment D_5 is longer in duration than U_1 and all remaining fragments excluding any fragment that is in aligned with U_5 (as shown in FIG. 21), the process continues to a state 1680 where bandwidth rearrangement is performed. There will be other downlink bandwidth alloca-

16

tions that can be moved in line with U_5 to make room for the remainder of D_5 . The final rearrangement of downlink scheduling is shown in FIG. 22.

Returning to decision block 1660, if the last downlink segment D_5 is shorter in duration than U_1 and all remaining fragments excluding any fragment that is aligned with U_5 , then the process moves to a state 1700 where D_5 is placed at the end of D_4 and interleaved in the gaps in the downlink subframe. No subsequent rearrangement is required. The foregoing algorithm ensures that the number of map entries will not exceed $2n+1$. However, after employing the algorithm, under many circumstances further rearrangement of the downlink will be possible to further reduce the number of downlink map elements below $2n$.

While the above detailed description has shown, described, and pointed out novel features as applied to various embodiments, it will be understood that various omissions, substitutions, and changes in the form and details of the device or process illustrated may be made by those skilled in the art without departing from the spirit. The scope is indicated by the appended claims rather than by the foregoing description. All changes which come within the meaning and range of equivalency of the claims are to be embraced within their scope.

The invention claimed is:

1. A subscriber unit in a point-to-multipoint wireless communication system, where a base station allocates uplink (UL) and downlink (DL) resources to a plurality of subscriber units on demand, the subscriber unit comprising:

an antenna system for transmitting to the base station UL data and receiving from the base station a DL sub-frame including

a) control information including a preamble for synchronizing the subscriber unit with the base station, information on an UL scheduled event and a DL scheduled event pertaining to the subscriber unit, identification of a UL physical (PHY) mode associated with the UL scheduled event, and a DL PHY mode associated with the DL scheduled event, and

b) a data block with DL data the subscriber unit, the DL data being encoded according to the DL PHY mode provided for the subscriber unit;

a receiver configured to decode the control information to identify the DL PHY mode and the UL PHY mode and the information on the DL and UL scheduled events, the receiver being further configured to decode the DL data from the data block based on the DL PHY mode and the information on the DL scheduled event; and

a transmitter configured to encode the UL data using the UL PHY mode and to map the UL data into an uplink sub-frame based on the information on the UL scheduled event,

wherein the control information is encoded using a DL PHY mode which includes a most robust PHY mode compatible with the subscriber units scheduled to receive data in the DL sub-frame.

2. A subscriber unit as claimed in claim 1, wherein the UL PHY mode is different from the DL PHY mode.

3. A subscriber unit as claimed in claim 1, wherein the UL data block is transmitted over sub-carriers assigned to the subscriber unit.

4. A subscriber unit as claimed in claim 1, wherein the DL data block is received over sub-carriers assigned to the subscriber unit.

5. A subscriber unit as claimed in claim 1, wherein the subscriber unit is a mobile device.

6. A subscriber unit as claimed in claim 1, wherein the UL PHY mode includes an UL modulation format and an UL forward error correction (FEC) coding to be used for encoding the UL data.

7. A subscriber unit as claimed in claim 1, wherein the UL PHY mode is a function of the quality of a wireless link established between the subscriber unit and the base station.

8. A subscriber unit in a point-to-multipoint wireless communication system, where a base station allocates uplink (UL) and downlink (DL) resources to a plurality of subscriber units on demand, the subscriber unit comprising:

an antenna system for transmitting to the base station UL data and receiving from the base station a downlink sub-frame including

a) control information including a preamble for synchronizing the subscriber unit with the base station, information on an UL scheduled event and a DL scheduled event pertaining to the subscriber unit, identification of a UL physical (PHY) mode associated with the UL scheduled event, and a DL PHY mode associated with the DL scheduled event, and

b) a data block with DL data for the subscriber unit, the DL data being encoded according to the DL PHY mode provided for the subscriber unit;

a receiver configured to decode the control information to identify the DL PHY mode and the UL PHY mode and the information on the UL and DL scheduled events, the receiver being further configured to decode the DL data from the data block based on the DL PHY mode and the information on the DL scheduled event,

wherein the DL PHY mode includes a DL modulation format and a DL forward error correction (FEC) coding, selected independently of each other based on one or more DL communication parameters.

9. A subscriber unit as claimed in claim 8, further comprising a transmitter configured to encode the UL data into an UL sub-frame using the UL PHY mode specified in the control information.

10. A subscriber unit as claimed, in claim 9, wherein the transmitter maps the UL data into the UL sub-frame based on the information on the UL scheduled event specified in the control information.

11. A subscriber unit as claimed in claim 9, wherein the UL PHY mode includes an UL modulation format and an uplink forward error correction (FEC) coding selected independently of each other based on one or more uplink communication parameters.

12. A subscriber unit as claimed in claim 8, wherein the data block is received over sub-carriers assigned to the subscriber unit.

13. A subscriber unit as claimed in claim 8, wherein the subscriber unit is a mobile device.

14. A subscriber unit as claimed in claim 8, further comprising a transmitter adapted to encode the UL data using the UL PHY mode and to map the UL data to an uplink sub-frame based on the information on the UL scheduled event.

15. A subscriber unit as claimed in claim 8, wherein the UL PHY mode is selected based on the quality of a wireless link established between the subscriber unit and the base station.

16. A subscriber unit as claimed in claim 8, wherein, DL PHY modes selected based on the quality of a wireless link established between the base station and the subscriber unit.

17. A method of processing data received in a subscriber unit in a point-to-multipoint wireless communication system, where a base station allocates uplink (UL) and downlink (DL) resources to a plurality of subscriber units on demand, the method comprising:

receiving a DL sub-frame with control information including a preamble for synchronizing the subscriber unit with the base station, information on a DL scheduled event pertaining to the subscriber unit, and identification of a DL physical (PHY) mode associated with the DL scheduled event;

decoding the control information for identifying the DL PHY mode and the information on the DL scheduled event, the information on the DL scheduled event including information on bandwidth allocated to the subscriber unit in the downlink sub-frame;

receiving a data block with DL data for the subscriber unit; and

decoding the DL data from the data block based on the DL PHY mode and the information on the DL scheduled event provided in the control information,

wherein the DL PHY mode includes a DL modulation format and a DL forward error correction (FEC) coding, the DL modulation format and DL FEC coding being selected independently of each other based on one or more communication parameters.

18. A method as claimed in claim 17, further comprising distributing the downlink data decoded from the data block between one or more user connections established at the subscriber unit.

19. A method of processing data received at a subscriber unit in a point-to-multipoint wireless communication system, where a base station allocates uplink (UL) and downlink (DL) resources to a plurality of subscriber units on demand, the method comprising:

receiving control information from the base station including a preamble for synchronizing the subscriber unit with the base station, information on an UL scheduled event pertaining to the subscriber unit, and identification of an UL physical (PHY) mode associated with the UL scheduled event;

encoding UL data according to the UL PHY mode provided for the subscriber unit by the control information; mapping the encoded UL data to a data block based on the information on the UL scheduled event provided by the control information, the UL scheduled event providing information on bandwidth allocated to the subscriber unit for UL transmission to the base station; and

transmitting the data block with the UL data to the base station within an UL sub-frame;

wherein the UL PHY mode includes an UL modulation format and an UL forward error correction (FEC) coding, the UL modulation format and the UL FEC coding being selected independently of each other based on one or more communication parameters.

20. A method as claimed in claim 19, wherein the UL PHY mode is a function of the quality of a wireless link established between the subscriber station and the base station.

UNITED STATES PATENT AND TRADEMARK OFFICE
CERTIFICATE OF CORRECTION

PATENT NO. : 8,462,673 B2
APPLICATION NO. : 13/427692
DATED : June 11, 2013
INVENTOR(S) : Stanwood et al.

Page 1 of 1

It is certified that error appears in the above-identified patent and that said Letters Patent is hereby corrected as shown below:

In the Claims:

Column 16, Line 41, please insert --for-- between “b) a data block with DL data” and “the subscriber unit,”.

Signed and Sealed this
Twenty-seventh Day of May, 2014



Michelle K. Lee
Deputy Director of the United States Patent and Trademark Office

UNITED STATES PATENT AND TRADEMARK OFFICE
CERTIFICATE OF CORRECTION

PATENT NO. : 8,462,673 B2
APPLICATION NO. : 13/427692
DATED : June 11, 2013
INVENTOR(S) : Kenneth L. Stanwood et al.

Page 1 of 1

It is certified that error appears in the above-identified patent and that said Letters Patent is hereby corrected as shown below:

In the Claims:

Column 18, line 25, between the phrases "of each" and "based on", replace "of" with --other--.

Signed and Sealed this
Twelfth Day of August, 2014



Michelle K. Lee
Deputy Director of the United States Patent and Trademark Office