



US008180030B2

(12) **United States Patent**  
**Katis et al.**

(10) **Patent No.:** **US 8,180,030 B2**  
(45) **Date of Patent:** **\*May 15, 2012**

(54) **TELECOMMUNICATION AND MULTIMEDIA  
MANAGEMENT METHOD AND APPARATUS**

(75) Inventors: **Thomas E. Katis**, Jackson, WY (US);  
**James T. Panttaja**, Healdsburg, CA  
(US); **Mary G. Panttaja**, Healdsburg,  
CA (US); **Matthew J. Ranney**, Oakland,  
CA (US)

(73) Assignee: **Voxer IP LLC**, San Francisco, CA (US)

(\*) Notice: Subject to any disclaimer, the term of this  
patent is extended or adjusted under 35  
U.S.C. 154(b) by 961 days.

This patent is subject to a terminal dis-  
claimer.

(21) Appl. No.: **12/032,426**

(22) Filed: **Feb. 15, 2008**

(65) **Prior Publication Data**

US 2009/0003339 A1 Jan. 1, 2009

**Related U.S. Application Data**

(63) Continuation of application No. 12/028,400, filed on  
Feb. 8, 2008.

(60) Provisional application No. 60/937,552, filed on Jun.  
28, 2007, provisional application No. 60/999,619,  
filed on Oct. 19, 2007.

(51) **Int. Cl.**  
**H04M 11/00** (2006.01)

(52) **U.S. Cl.** ..... **379/93.01; 379/88.13; 379/88.16;**  
**379/88.17; 379/45**

(58) **Field of Classification Search** ..... **379/93.01,**  
**379/90.01, 88.04, 88.06, 88.07, 88.08, 88.22–88.28,**  
**379/93.24; 709/204–206**

See application file for complete search history.

(56) **References Cited**

U.S. PATENT DOCUMENTS

4,807,224 A 2/1989 Naron et al.  
5,117,422 A 5/1992 Hauptschein et al.  
5,283,818 A 2/1994 Klausner et al.  
5,375,018 A 12/1994 Klausner et al.  
5,390,236 A 2/1995 Klausner et al.  
5,487,167 A 1/1996 Dinallo et al.

(Continued)

FOREIGN PATENT DOCUMENTS

WO WO 03/073642 9/2003

(Continued)

OTHER PUBLICATIONS

“Dirproxy,” <http://home.pcisys.net/~tbc/hacks/dirproxy.htm>,  
Downloaded on Sep. 26, 2008, 1 page.

(Continued)

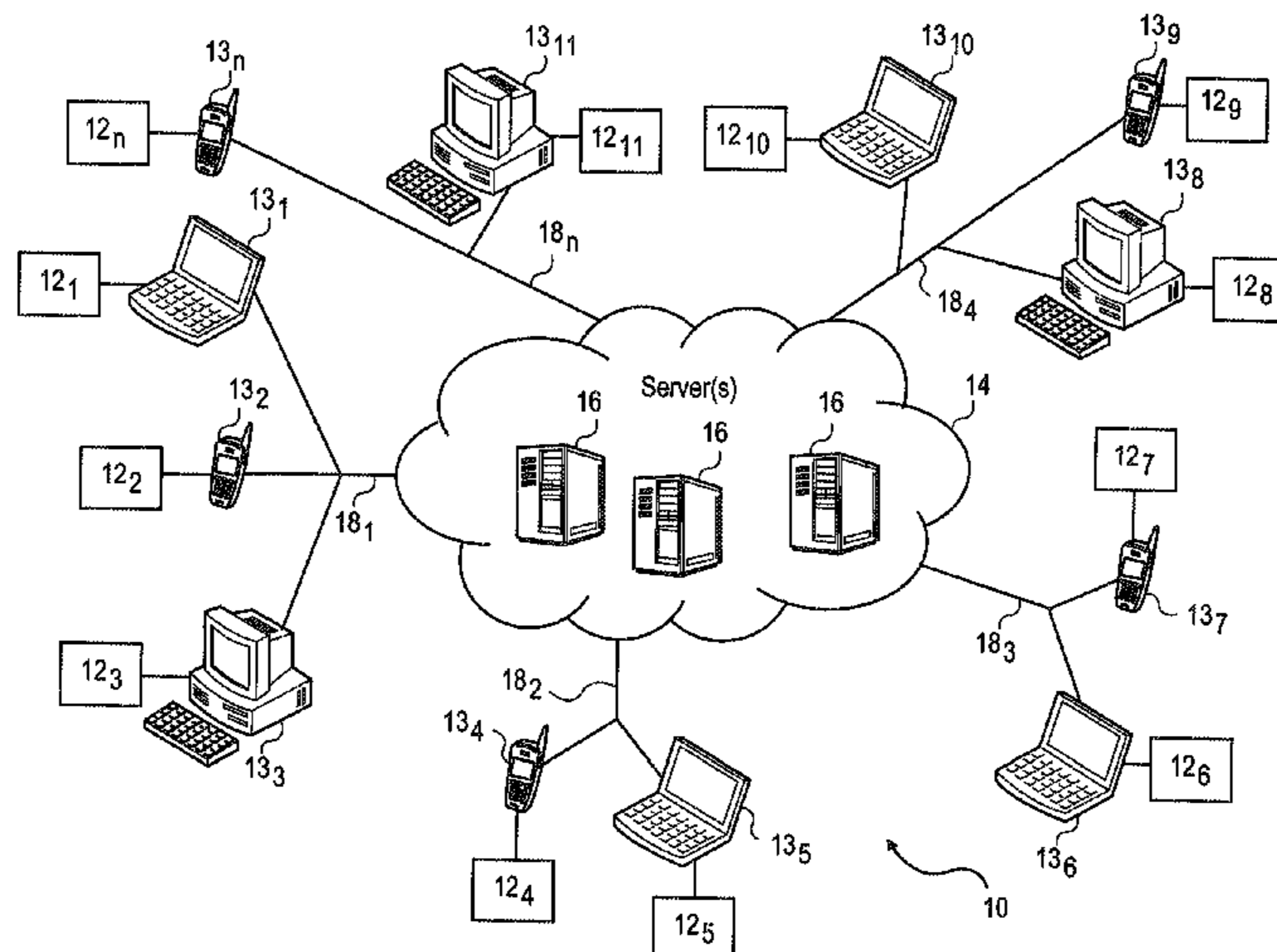
Primary Examiner — Melur Ramakrishnaiah

(74) Attorney, Agent, or Firm — Beyer Law Group LLP

(57) **ABSTRACT**

A telecommunication and multimedia management apparatus and method that supports voice and other media communications and that enables users to: (i) participate in multiple conversation modes, including live phone calls, conference calls, instant voice messaging or tactical communications; (ii) review the messages of conversations in either a live mode or a time-shifted mode and to seamlessly transition back and forth between the two modes; (iii) participate in multiple conversations either concurrently or simultaneously; (iv) archive the messages of conversations for later review or processing; and (v) persistently store media either created or received on the communication devices of users. The latter feature enables users to generate or review media when either disconnected from the network or network conditions are poor and to optimize the delivery of media over the network based on network conditions and the intention of the users participating in conversations.

**48 Claims, 33 Drawing Sheets**



# US 8,180,030 B2

U.S. PATENT DOCUMENTS							
5,524,140	A	6/1996	Klausner et al.	2004/0074448	A1	4/2004	Bunt
5,572,576	A	11/1996	Klausner et al.	2004/0090959	A1	5/2004	Cinghita et al.
5,651,054	A	7/1997	Dunn et al.	2004/0095900	A1	5/2004	Siegel
5,692,213	A	11/1997	Goldberg et al.	2004/0117722	A1	6/2004	Harada
5,734,963	A	3/1998	Fitzgerald et al.	2004/0192353	A1	9/2004	Mason et al.
5,737,011	A	4/1998	Lukacs	2004/0192378	A1	9/2004	Wulkan
5,918,158	A	6/1999	LaPorta et al.	2004/0207724	A1	10/2004	Crouch et al.
5,963,551	A	10/1999	Minko	2004/0252679	A1	12/2004	Williams et al.
5,970,122	A	10/1999	LaPorta et al.	2004/0255148	A1	12/2004	Monteiro et al.
6,037,932	A	3/2000	Feinleib	2004/0258220	A1	12/2004	Levine et al.
6,092,120	A	7/2000	Swaminathan et al.	2005/0020246	A1	1/2005	Kang
6,104,757	A	8/2000	Rhee	2005/0021819	A1	1/2005	Kilkki
6,175,619	B1	1/2001	DeSimone	2005/0025308	A1	2/2005	Tischer et al.
6,233,389	B1	5/2001	Barton et al.	2005/0030932	A1	2/2005	Kelly et al.
6,262,994	B1	7/2001	Dirschedl et al.	2005/0037706	A1	2/2005	Settle
6,378,035	B1	4/2002	Parry et al.	2005/0053033	A1	3/2005	Kelly et al.
6,480,783	B1	11/2002	Myr	2005/0102358	A1	5/2005	Gold et al.
6,507,586	B1	1/2003	Satran et al.	2005/0135333	A1*	6/2005	Rojas ..... 370/352
6,564,261	B1	5/2003	Gudjonsson et al.	2005/0144247	A1	6/2005	Christensen et al.
6,577,599	B1	6/2003	Gupta et al.	2005/0160345	A1	7/2005	Walsh et al.
6,580,694	B1	6/2003	Baker	2005/0202807	A1	9/2005	Ayyasamy
6,594,693	B1	7/2003	Borwankar et al.	2005/0207487	A1	9/2005	Monroe
6,671,732	B1	12/2003	Weiner	2005/0215228	A1	9/2005	Fostick et al.
6,700,902	B1*	3/2004	Meyer ..... 370/468	2005/0220137	A1	10/2005	Prigent et al.
6,717,925	B1	4/2004	Leppisaari et al.	2005/0259682	A1	11/2005	Yosef et al.
6,721,703	B2	4/2004	Jackson et al.	2005/0288101	A1	12/2005	Lockton et al.
6,791,949	B1	9/2004	Ryu et al.	2006/0007943	A1	1/2006	Fellman
6,807,565	B1	10/2004	Dodrill et al.	2006/0045038	A1	3/2006	Kay et al.
6,807,578	B2	10/2004	Satran et al.	2006/0059267	A1	3/2006	Cugi et al.
6,829,473	B2	12/2004	Raman et al.	2006/0059342	A1	3/2006	Medvinsky et al.
6,834,039	B1	12/2004	Kelly et al.	2006/0093304	A1	5/2006	Bathey et al.
6,850,965	B2	2/2005	Allen	2006/0107285	A1	5/2006	Medvinsky
6,912,544	B1	6/2005	Weiner	2006/0146822	A1	7/2006	Kolakowski et al.
6,931,114	B1	8/2005	Martin	2006/0160522	A1*	7/2006	Jennings ..... 455/404.1
6,970,926	B1	11/2005	Needham et al.	2006/0168003	A1	7/2006	Vau et al.
6,973,309	B1	12/2005	Rygula et al.	2006/0187897	A1	8/2006	Dabbs et al.
6,993,009	B2	1/2006	Kelly et al.	2006/0189305	A1	8/2006	Ando et al.
6,996,624	B1	2/2006	LeCroy et al.	2006/0212582	A1	9/2006	Gupta et al.
7,002,913	B2	2/2006	Huang et al.	2006/0212592	A1	9/2006	Gupta et al.
7,039,040	B1	5/2006	Burg	2006/0221995	A1	10/2006	Berkman
7,039,675	B1	5/2006	Kato	2006/0224748	A1	10/2006	Gupta et al.
7,047,030	B2	5/2006	Forsyth	2006/0244588	A1	11/2006	Hannah et al.
7,111,044	B2	9/2006	Lee	2006/0245367	A1	11/2006	Jeffery et al.
7,117,521	B2	10/2006	Puthiyedath	2006/0248149	A1	11/2006	Kraft et al.
7,139,371	B2	11/2006	McElvaney	2006/0253599	A1	11/2006	Monteiro et al.
7,171,491	B1	1/2007	O'Toole et al.	2006/0268750	A1	11/2006	Weiner
7,187,941	B2	3/2007	Siegel	2006/0274698	A1	12/2006	Twitchell
7,218,709	B2	5/2007	Garg et al.	2006/0276714	A1	12/2006	Holt et al.
7,233,589	B2	6/2007	Tanigawa et al.	2006/0282544	A1	12/2006	Monteiro et al.
7,236,738	B2	6/2007	Settle	2006/0288391	A1	12/2006	Puthiyedath
7,240,105	B2	7/2007	Satran et al.	2006/0294259	A1	12/2006	Matefi et al.
7,304,951	B2	12/2007	Rhee	2007/0001869	A1	1/2007	Hunzinger
7,305,438	B2	12/2007	Christensen et al.	2007/0002832	A1	1/2007	Sylvain
7,313,593	B1	12/2007	Pulito et al.	2007/0006021	A1	1/2007	Nicholson et al.
7,349,871	B2	3/2008	Labrou et al.	2007/0081622	A1	4/2007	Bruder et al.
7,382,881	B2	6/2008	Uusitalo et al.	2007/0180032	A1	8/2007	Pearson
7,403,775	B2	7/2008	Patel et al.	2007/0182819	A1	8/2007	Monroe
7,415,291	B1*	8/2008	Kirkpatrick ..... 455/572	2007/0207785	A1	9/2007	Chatterjee et al.
7,626,951	B2	12/2009	Croy et al.	2007/0263575	A1	11/2007	Choe
7,634,652	B2	12/2009	McEnroe et al.	2007/0268887	A1	11/2007	Schwartz
7,719,975	B2	5/2010	Mallet et al.	2008/0000979	A1	1/2008	Poisner
2001/0000540	A1	4/2001	Cooper et al.	2008/0002621	A1	1/2008	Ginzburg et al.
2001/0025377	A1	9/2001	Hinderks	2008/0002691	A1	1/2008	Qi et al.
2002/0091848	A1	7/2002	Agresta et al.	2008/0031448	A1	2/2008	Dang et al.
2002/0128029	A1	9/2002	Nishikawa et al.	2008/0086700	A1	4/2008	Rodriguez et al.
2002/0150094	A1	10/2002	Cheng et al.	2008/0091839	A1	4/2008	Mitchell et al.
2002/0154745	A1	10/2002	Shtivelman	2008/0095173	A1	4/2008	Bughenagen
2002/0159600	A1	10/2002	Weiner	2008/0095338	A1	4/2008	Cosky
2002/0184368	A1	12/2002	Wang	2008/0115087	A1	5/2008	Rollin et al.
2003/0027566	A1	2/2003	Weiner	2008/0123623	A2	5/2008	Kurganov et al.
2003/0028632	A1	2/2003	Davis	2008/0134054	A1	6/2008	Clark et al.
2003/0099198	A1	5/2003	Kiremidjian et al.	2008/0147910	A1	6/2008	Hibbard et al.
2003/0126162	A1	7/2003	Yohe et al.	2008/0165707	A1	7/2008	Baird et al.
2003/0186722	A1	10/2003	Weiner	2008/0205444	A1	8/2008	Campbell et al.
2003/0210265	A1	11/2003	Haimberg	2009/0003340	A1	1/2009	Katis et al.
2004/0017905	A1	1/2004	Warrier et al.	2009/0003544	A1	1/2009	Katis et al.
2004/0019539	A1	1/2004	Raman et al.	2009/0003545	A1	1/2009	Katis et al.
2004/0045036	A1	3/2004	Terasaki	2009/0003547	A1	1/2009	Katis et al.
				2009/0003557	A1	1/2009	Katis et al.

2009/0003558 A1 1/2009 Katis et al.  
 2009/0003559 A1 1/2009 Katis et al.  
 2009/0003563 A1 1/2009 Katis et al.  
 2009/0063698 A1 3/2009 Xu et al.  
 2009/0175425 A1 7/2009 Lee  
 2010/0215158 A1 8/2010 Katis et al.  
 2010/0217822 A1 8/2010 Katis et al.

## FOREIGN PATENT DOCUMENTS

WO WO 2004/008336 1/2004  
 WO WO 2006/114673 11/2006  
 WO WO 2007/026320 3/2007

## OTHER PUBLICATIONS

Apple Inc., *“iPhone User’s Guide,”* [http://manuals.info.apple.com/en\\_US/iPhone\\_User\\_Guide.pdf](http://manuals.info.apple.com/en_US/iPhone_User_Guide.pdf), Downloaded on Oct. 3, 2008, 154 pages.

Brandx.net, *“Using Talk,”* <http://www.brandx.net/support/usingtelnet/talk.shtml>, Downloaded on Sep. 19, 2008, 2 pages.

Businesswire.com *“LignUp 4.0 Delivers Industry’s Most Comprehensive Suite of Communications Web Services,”* [http://www.businesswire.com/portal/site/google/index.jsp?ndmViewId=news\\_view&newsId=20070430005498&newsLang=en](http://www.businesswire.com/portal/site/google/index.jsp?ndmViewId=news_view&newsId=20070430005498&newsLang=en), Downloaded on Nov. 21, 2008, 10 pages.

Calore, Michael, *“SpinVox Moves Into VoIP, Brings Voice-to-Text to Skype Users,”* Monkey\_Bites, <http://blog.wired.com/monkeybites/2007/08/spinvox-moves-i.html>, Downloaded on Oct. 3, 2008, 4 pages.

Cardei et al., *“MAC Layer QoS Support for Wireless Networks of Unmanned Air Vehicles,”* Proceedings of the 37th Hawaii International Conference on System Sciences—2004, Jan. 5-8, 2004 p. 9 pp.  
 Charny, Ben, *“Nextel pushes new ‘push to talk’ features,”* URL: [http://news.zdnet.com/2100-9584\\_22-134945.html](http://news.zdnet.com/2100-9584_22-134945.html), Mar. 18, 2004, 3 pages.

Chen et al., *“An Adaptive Multimedia Transmission Protocol for Distributed Multimedia Applications,”* Proceedings of the 5th International Workshop on Multimedia Network Systems and Applications (MNSA ’2003), in conjunction with The 23rd International Conference on Distributed Computing Systems (ICDCS-2003), 6 pages.

Dannen, Chris, *“Technology: The Skype Mobile Phone Will Blow Your Mind,”* Dec. 18, 2007, URL: <http://www.fastcompany.com/blog/chris-dannen/lab/technology-skype-mobile-phone-will-blow-your-mind>, 2 pages.

Erwu et al., *“Packet-late indication based (PLIB): adaptive jitter buffer,”* ACM International Conference Proceeding Series; vol. 58, Proceedings of the winter international symposium on Information and communication technologies, Cancun, Mexico, Session: Performance, reliability, and quality of service, pp. 1-5 Year of Publication: 2004.

FAQS.org, *“RFC1644—T/TCP—TCP Extensions for Transactions Functional S,”* <http://www.faqs.org/rfcs/rfc1644.html>, Downloaded on Sep. 19, 2008, 26 pages.

FluidVoice *“Overview of FluidVoice,”* <http://viral.media.mit.edu/wiki/tiki-index.php?p.=FluidVoice>, Downloaded on Sep. 16, 2008, 2 pages.

GrandCentral.com, *“Call Record,”* [http://www.grandcentral.com/howitworks/call\\_record](http://www.grandcentral.com/howitworks/call_record), Downloaded on Sep. 26, 2008, 1 page.

GrandCentral.com, *“One Voicemail Box,”* [http://www.grandcentral.com/home/one\\_voicemail](http://www.grandcentral.com/home/one_voicemail), Downloaded on Sep. 26, 2008, 1 page.

GrandCentral.com, *“So Many Features, You Won’t Believe it,”* <http://www.grandcentral.com/support/howitworks/>, Downloaded on Sep. 26, 2008, 1 page.

GrandCentral.com, *“Voicemail forwarding,”* [http://www.grandcentral.com/howitworks/voicemail\\_forwarding](http://www.grandcentral.com/howitworks/voicemail_forwarding), Downloaded on Sep. 26, 2008, 1 page.

Henshall, Stuart, *“HotRecorder—Record Skype Calls,”* Skype Journal, URL: [http://skypejournal.com/blog/archives/2005/03/hotrecorder\\_rec.php](http://skypejournal.com/blog/archives/2005/03/hotrecorder_rec.php), Mar. 25, 2005, 11 pages.

IRCHelp.org, *“An IRC Tutorial,”* <http://www.irchelp.org/irchelp/irctutorial.html>, Downloaded on Sep. 26, 2008, 14 pages.

Kadoink.com, *“Get a Widget,”* <http://www.kadoink.com/index.cfm?action=getWidgets>, Downloaded on Sep. 19, 2008, 3 pages.

Krishnan et al., *“EVRC-Wideband: The New 3GPP2 Wideband Vocoder Standard,”* IEEE International Conference on Acoustics, Speech and Signal Processing, 2007. ICASSP 2007, Publication Date: Apr. 15-20, 2007, vol. 2, on pp. II-333-II-336, Honolulu, HI.  
 Layton, Julia, *“How Slingbox Works,”* Jan. 4, 2006, HowStuffWorks.com, <http://electronics.howstuffworks.com/slingbox.htm>, 9 pages.  
 LignUp.com, *“LignUp Communications Applications Server,”* <http://www.lignup.com/platform/index.html>, Downloaded on Sep. 19, 2008, 1 page.

Network Dictionary, *“Instant Message (IM) Technology Overview,”* <http://www.networkdictionary.com/networking/im.php>, Downloaded on Sep. 16, 2008, 2 pages.

Nikotalkie.com, *“Nikotalkie—Home,”* <http://www.nikotalkie.com/>, Downloaded on Sep. 19, 2008, 2 pages.

Nikotel.com, *“Click-Pop-Talk WebStart Phone,”* <http://www.nikotel.com/nikotel-click-pop-talk-java-phone.html>, Downloaded on Sep. 19, 2008, 1 page.

Notaras, George, *“dirproxy IRC Proxy,”* <http://www.g-loaded.eu/2007/02/01/dirproxy-irc-proxy/>, Downloaded on Sep. 26, 2008, 4 pages.

Pash, Adam, *“Consolidate Your Phones with GrandCentral,”* <http://techgroup.groups.vox.com/library/post/6a00cd978d0ef7f9cc00e398b8ff7a0002.html>, Downloaded on Sep. 19, 2008, 5 pages.

Patel, Nilay, *“Apple patent reveals data-to-voice translation system for cellphones,”* Jul 28, 2007, URL: <http://www.engadget.com/2007/07/28/apple-patent-reveals-data-to-voice-translation-system-for-cellph/>, 5 pages.

Piecuch et al., *“A Selective Retransmission Protocol for Multimedia on the Internet,”* In Proceedings of SPIE Multimedia Systems and Applications, Nov. 2000, Boston MA, USA, 12 pages.

Qiao et al., *“SCTP Performance Issue on Path Delay Differential,”* Lecture Notes in Computer Science, Springer Berlin / Heidelberg ISSN 0302-9743 (Print) 1611-3349 (Online) vol. 4517/2007, Wired/Wireless Internet Communications, pp. 43-54 Sunday, Jun. 24, 2007.

Ramo et al., *“On comparing speech quality of various narrow- and wideband speech codecs,”* Proceedings of the Eighth International Symposium on Signal Processing and Its Applications, 2005. Publication Date: Aug. 28-31, 2005, vol. 2, on pp. 603-606.

Rey et al., *“I-D ACTION: draft-ietf-avt-rtp-retransmission-09.txt,”* Aug. 5, 2003, <http://osdir.com/ml/ietf.avt/2003-08/msg00003.html>, Downloaded on Sep. 19, 2008, 2 pages.

Ribbit.com, *“Amphibian,”* <http://www.ribbit.com/everyday/>, Downloaded on Sep. 26, 2008, 1 page.

Ribbit.com, *“Enhanced Visual Voicemail,”* [http://www.ribbit.com/everyday/tour/enhanced\\_visual\\_voicemail.php](http://www.ribbit.com/everyday/tour/enhanced_visual_voicemail.php), Downloaded on Sep. 26, 2008, 2 pages.

Ribbit.com, *“What is Ribbit? Features,”* <http://www.ribbit.com/platform/features.php>, Downloaded on Sep. 26, 2008, 1 page.

Ribbit.com, *“What is Ribbit? Overview,”* <http://www.ribbit.com/platform/index.php>, Downloaded on Sep. 26, 2008, 1 page.

Ribbit.com, *“What is Ribbit? Voice Architecture,”* <http://www.ribbit.com/platform/architecture.php>, Downloaded on Sep. 26, 2008, 2 pages.

Saito et al., *“IP Packet Loss Compensation Scheme with Bicast and Forwarding for Handover in Mobile Communications,”* 2006 IEEE 17th International Symposium on Personal, Indoor and Mobile Radio Communications, Sep. 2006, pp. 1-5, Helsinki.

Skype.com, *“Making calls is just the start,”* URL: <http://www.skype.com/features/>, Downloaded on Sep. 16, 2008, 2 pages.

Spinvox.com, *“Home Page,”* <http://www.spinvox.com/>, Downloaded on Sep. 26, 2008, 3 pages.

Spinvox.com, *“How Does it Work?,”* [http://www.spinvox.com/how\\_it\\_works.html](http://www.spinvox.com/how_it_works.html), Downloaded on Sep. 19, 2008, 2 pages.

Swissvoice.net, *“PSTN,”* [http://www.swissvoice.net/ww/htm\\_ww/08\\_technology/content\\_pstn.html](http://www.swissvoice.net/ww/htm_ww/08_technology/content_pstn.html), Downloaded on Sep. 19, 2008, 3 pages.

Tektronix, *“VOIP Technology Overview; Protocols, Convergence, Testing,”* <http://www.tektronics.com/voip>, May 12, 2006.

The Jabber Extensible Communications Platform™, *“Products // Jabber XCP,”* URL: <http://www.jabber.com/CE/JabberXCP>, Downloaded on Sep. 16, 2008, 2 pages.

- ThunkDifferent.com, "YouMail vs. Google Grandcentral Voice Mail Service," <http://thunkdifferent.com/2007/10/11/youmail-vs-google-grandcentral-voice-mail-service/>, Downloaded on Oct. 3, 2008, 6 pages.
- VOIP-News.com, "Company Profile, LignUp," <http://www.voip-news.com/vendors/lignup/>, Downloaded on Dec. 5, 2008, 6 pages.
- WikiBooks, "Internet Technologies/IRC," [http://en.wikibooks.org/wiki/Internet\\_Technologies/IRC](http://en.wikibooks.org/wiki/Internet_Technologies/IRC), Downloaded on Sep. 19, 2008, 4 pages.
- Wikipedia—The Free Encyclopedia, "E-mail," <http://en.wikipedia.org/wiki/E-mail>, Downloaded on Sep. 19, 2008, 8 pages.
- Wikipedia—The Free Encyclopedia, "Internet Relay Chat," [http://en.wikipedia.org/wiki/Internet\\_Relay\\_Chat](http://en.wikipedia.org/wiki/Internet_Relay_Chat), Downloaded on Oct. 3, 2008, 11 pages.
- Wikipedia—The Free Encyclopedia, "Spinvox," <http://en.wikipedia.org/wiki/Spinvox>, Downloaded on Sep. 26, 2008, 1 page.
- Wikipedia—The Free Encyclopedia, "TiVo," <http://en.wikipedia.org/wiki/TiVo>, Downloaded on Sep. 16, 2008, 6 pages.
- Yavuz et al., "VoIP over cdma2000 1xEV-DO Revision A," IEEE Communications Magazine, Feb. 2006, pp. 88-95.
- HotRecorder.com, "Features," [http://www.hotrecorder.com/music\\_features.asp](http://www.hotrecorder.com/music_features.asp), downloaded on Sep. 26, 2008, 1 page.
- HotRecorder.com, "Help," [http://www.hotrecorder.com/music\\_help.asp](http://www.hotrecorder.com/music_help.asp), downloaded on Sep. 26, 2008, 3 pages.
- HotRecorder.com, "FAQs," [http://www.hotrecorder.com/music\\_support.asp](http://www.hotrecorder.com/music_support.asp), downloaded on Sep. 26, 2008, 1 page.
- Wikipedia—The Free Encyclopedia, "Skype," <http://en.wikipedia.org/wiki/Skype>, Downloaded on Sep. 26, 2008, 7 pages.
- Wikipedia—The Free Encyclopedia, "Skype Protocol," <http://en.wikipedia.org/wiki/Skype>, Downloaded on Sep. 26, 2008, 4 pages.
- Jabber.org, "Main page," [http://www.jabber.org/web/main\\_page](http://www.jabber.org/web/main_page), Sep. 2, 2008, downloaded on Sep. 26, 2008, 1 page.
- Jabber.org, "FAQ," <http://www.jabber.org/web/faq>, Sep. 4, 2008, downloaded on Sep. 26, 2008, 2 pages.
- Apple Inc., "iPhone: About Visual Voicemail," <http://www.support.apple.com/kb/HT1486>, Downloaded on Sep. 26, 2008, 3 pages.
- Jabber.org, "Products // Jabber XCP // Benefits," <http://www.jabber.com/CE/JabberXCPBenefits>, downloaded on Sep. 26, 2008, 1 page.
- Jabber.org, "Products // Jabber Clients," <http://www.jabber.com/CE/JabberClients>, downloaded on Sep. 26, 2008, 1 page.
- Jabber.org, "Products // JabberNow" <http://www.jabber.com/CE/JabberNow>, downloaded on Sep. 26, 2008, 1 page.
- KillerStartups.com, "Kadoink.com—Mobilizing your Socializing," <http://www.killerstartups.com/Web20/kadoink-com-moblizing-your-socializing>, Downloaded on Sep. 26, 2008, 3 pages.
- CNETNews.com, "Kadoink's phonecast lines officially open for texting," [http://news.cnet.com/8301-17939\\_109-9829877-2.html](http://news.cnet.com/8301-17939_109-9829877-2.html), downloaded on Sep. 26, 2008, 1 page.
- BusinessWire.com, "LignUp 4.0 Delivers Industry's Most Comprehensive Suite of Communications Web Services," Apr. 30, 2007, [http://www.businesswire.com/portal/site/google/?ndmViewId=news\\_view&newsId=20070430005498&newsLang=en](http://www.businesswire.com/portal/site/google/?ndmViewId=news_view&newsId=20070430005498&newsLang=en), Downloaded on Sep. 26, 2008, 6 pages.
- VOIP-News.com, "Company Profile—LignUp," <http://www.voip-news.com/vendors/lignup/>, Downloaded on Oct. 3, 2008, 6 pages.
- JustAnotheriPhoneBlog.com, "Nikotalkie—Just Talk, Don't Type," <http://justanotheriphoneblog.com/wordpress/2007/10/13/nikotalkie-just-talk-dont-type/>, Downloaded on Sep. 26, 2008, 10 pages.
- Wikipedia—The Free Encyclopedia, "Push to Talk" [http://en.wikipedia.org/wiki/Push\\_to\\_talk](http://en.wikipedia.org/wiki/Push_to_talk), Downloaded on Sep. 26, 2008, 3 pages.
- Wikipedia—The Free Encyclopedia, "Slingbox" <http://en.wikipedia.org/wiki/Slingbox>, Downloaded on Sep. 26, 2008, 4 pages.
- About.com, "Linux / Unix Command: talk," [http://linux.about.com/od/commands/l/blcmd11\\_talk.htm](http://linux.about.com/od/commands/l/blcmd11_talk.htm), Downloaded on Sep. 26, 2008, 2 pages.
- Fall, Kevin, "A Delay-Tolerant Network Architecture for Challenged Internets," Feb. 2003, <http://www.dtnrg.org/docs/papers/IRB-TR-03-003.pdf>, 15 pages.
- Chuah et al., "Store-and-Forward Performance in a DTN," Vehicular Technology Conference, 2006. VTC 2006-Spring. IEEE 63<sup>rd</sup>, Publication Date: May 7-10, 2006, vol. 1, on pp. 187-191.
- Krishnan, et al., "The SPINDLE Disruption-Tolerant Networking System," Military Communications Conference, 2007. MILCOM 2007. IEEE Volume , Issue , Oct. 29-31, 2007 pp. 1-7.
- Wikipedia—The Free Encyclopedia, "Visual Voicemail" [http://en.wikipedia.org/wiki/Visual\\_voicemail](http://en.wikipedia.org/wiki/Visual_voicemail), downloaded on Sep. 26, 2008, 1 page.
- Amir et al., "An Overlay Architecture for High Quality VoIP Streams," IEEE Transactions on Multimedia, Publication Date: Dec. 2006, vol. 8, Issue:6, On pp. 1250-1262.
- Rothermel et al., "An Adaptive Stream Synchronization Protocol," Lecture Notes in Computer Science; vol. 1018, Proceedings of the 5th International Workshop on Network and Operating System Support for Digital Audio and Video, pp. 178-189, Year of Publication: 1995.
- Baset et al., "An Analysis of the Skype Peer-to-Peer Internet Telephony Protocol," INFOCOM 2006. 25th IEEE International Conference on Computer Communications. Proceedings (2006), pp. 1-11.
- Cerf et al., "A Protocol for Packet Network Intercommunication," Communications, IEEE Transactions on, vol. 22, Issue 5, May 1974 pp. 637-648.
- International Search Report from PCT/US2008/061900 dated Aug. 20, 2008.
- Written Opinion from PCT/US2008/061900 dated Aug. 20, 2008.
- International Search Report from PCT/US2008/064902 dated Nov. 3, 2008.
- Written Opinion from PCT/US2008/064902 dated Nov. 3, 2008.
- Wikipedia—The Free Encyclopedia, "Eudora (email client)," [http://en.wikipedia.org/wiki/Eudora\\_\(e-mail\\_client\)](http://en.wikipedia.org/wiki/Eudora_(e-mail_client)), Downloaded on Aug. 20, 2009, 3 pages.
- "Eudora," Answers.com, <http://www.answers.com/topic/eudora-e-mail-client>, Downloaded on Aug. 20, 2009, 4 pages.
- "The Eudora Open Messaging Advantage," Qualcomm, 1997, Part No. 100-50030-1, 23 pages.
- "Aspera—Next Generation File Transport—Broadcasting & Entertainment Media," Asperasoft.com, [http://www.asperasoft.com/en/industries/digital\\_media\\_10/Broadcast\\_Entertainment\\_Media\\_5](http://www.asperasoft.com/en/industries/digital_media_10/Broadcast_Entertainment_Media_5), Downloaded on Sep. 22, 2009, 2 pages.
- "Aspera—Next Generation File Transport—fasp™transfer times," Asperasoft.com, [http://www.asperasoft.com/en/technology/fasp\\_transfer\\_times\\_14/fasp\\_transfer\\_times\\_14](http://www.asperasoft.com/en/technology/fasp_transfer_times_14/fasp_transfer_times_14), Downloaded on Sep. 22, 2009, 1 page.
- "Aspera—Next Generation File Transport—the fasp solution," Asperasoft.com, [http://www.asperasoft.com/en/technology/fasp\\_solution\\_3/the\\_fasp\\_solution\\_3](http://www.asperasoft.com/en/technology/fasp_solution_3/the_fasp_solution_3), Downloaded on Sep. 22, 2009, 3 pages.
- "Aspera—Next Generation File Transport—the shortcomings of TCP file transfer," Asperasoft.com, [http://www.asperasoft.com/en/technology/shortcomings\\_of\\_TCP\\_2/the\\_shortcomings\\_of\\_TCP\\_file\\_transfer\\_2](http://www.asperasoft.com/en/technology/shortcomings_of_TCP_2/the_shortcomings_of_TCP_file_transfer_2), Downloaded on Sep. 22, 2009, 2 pages.
- "Aspera—Next Generation File Transport—fasp technology overview" Asperasoft.com, [http://www.asperasoft.com/en/technology/fasp\\_overview\\_1/fasp\\_technology\\_overview\\_1](http://www.asperasoft.com/en/technology/fasp_overview_1/fasp_technology_overview_1), Downloaded on Sep. 22, 2009, 2 pages.
- "Aspera fasp™ High Speed Transport—A Critical Technology Comparison," White Paper, Asperasoft.com, [http://www.asperasoft.com/en/technology/white\\_papers\\_13/aspera\\_fasp\\_high\\_speed\\_transport\\_13](http://www.asperasoft.com/en/technology/white_papers_13/aspera_fasp_high_speed_transport_13), Downloaded on Sep. 22, 2009, 11 pages.
- "Palringo Brings First Push-to-Talk Application to the iPhone," RedOrbit.com, [http://www.redorbit.com/news/technology/1525545/palringo\\_brings\\_first\\_pushtotalk\\_application\\_to\\_the\\_iphone/index.html](http://www.redorbit.com/news/technology/1525545/palringo_brings_first_pushtotalk_application_to_the_iphone/index.html), Downloaded on Aug. 13, 2009, 2 pages.
- Palringo—Features, Palringo.com, <http://www.palringo.com/en/gb/features/>, Downloaded on Aug. 13, 2009, 1 page.
- Moren, Dan, "Palringo Brings Picture Messaging to Iphone," [http://www.pcworld.com/article/149108/palringo\\_brings\\_picture\\_messaging\\_to\\_iphone.html](http://www.pcworld.com/article/149108/palringo_brings_picture_messaging_to_iphone.html), Downloaded on Aug. 13, 2009, 3 pages.
- Paul, Ryan, "Gmail gets Google Talk integration," Arstechnica.com, <http://arstechnica.com/old/content/2006/02/6128.ars>, Downloaded on Aug. 20, 2009, 1 page.
- Sherman, Chris, "Google Integrates Chat with Gmail," Search Engine Watch, <http://searchenginewatch.com/3583121>, Feb. 7, 2006, Downloaded on Aug. 20, 2009, 2 pages.

“About Gmail,” <http://mail.google.com/mail/help/chat.html>, Downloaded on Aug. 20, 2009, 3 pages.

Wikipedia—The Free Encyclopedia, “Google Talk,” [http://en.wikipedia.org/wiki/Google\\_Talk](http://en.wikipedia.org/wiki/Google_Talk), Downloaded on Aug. 20, 2009, 8 pages.

Azuri, Calvin, “Palringo Gold Launched on BlackBerry Smartphone”, Apr. 20, 2009, <http://ivr.tmcnet.com/topics/ivr-voicexml/articles/54573-palringo-gold-launched-blackberry-smartphone.htm>, Downloaded on Aug. 13, 2009, 3 pages.

Liaw, Kim Poh, “Palringo launches its IM Software for Android Phones,” Slashphone.com, Mar. 24, 2009, <http://www.slashphone.com/palringo-launches-its-im-software-for-android-phones-245111>, Downloaded on Aug. 13, 2009, 8 pages.

Wikipedia—The Free Encyclopedia, “Palringo” <http://en.wikipedia.org/wiki/Palringo>, Downloaded on Aug. 13, 2009, 1 page.

U.S. Office Action in U.S Appl. No. 12/037,749 dated Nov. 24, 2010.

European Office Action in European Application No. 08756317.7 dated Nov. 11, 2010.

Office Action from corresponding European Application No. 08747114.0 dated Aug. 26, 2010.

Office Action in U.S. Appl. No. 12/028,400 dated Apr. 5, 2011.

Office Action in U.S. Appl. No. 12/122,586 dated May 17, 2011.

Final Office Action in U.S. Appl. No. 12/037,749, dated Jul. 8, 2011.

Office Action in U.S. Appl. No. 12/028,400 dated Oct. 14, 2011.

Final Office Action in U.S. Appl. No. 12/042,987, dated Jul. 13, 2011.

Final Office Action in U.S. Appl. No. 12/102,722, dated Jul. 13, 2011.

Final Office Action in U.S. Appl. 12/103,436, dated Jul. 13, 2011.

“Store and Forward,” Wikipedia, the free encyclopedia, URL: [http://en.wikipedia.org/wiki/Store\\_and\\_forward](http://en.wikipedia.org/wiki/Store_and_forward), Downloaded on Oct. 26, 2011, 2 pages.

Final Office Action in U.S. Appl. No. 12/110,221 mailed on Oct. 27, 2011.

Examination Report from Australian application No. 2008270956, dated Jan. 12, 2011.

Notice of Allowance in U.S. Appl. No. 12/110,221, dated Jan. 9, 2012.

Examination Report from Australian Application No. 2008270956, dated Feb. 7, 2012.

\* cited by examiner

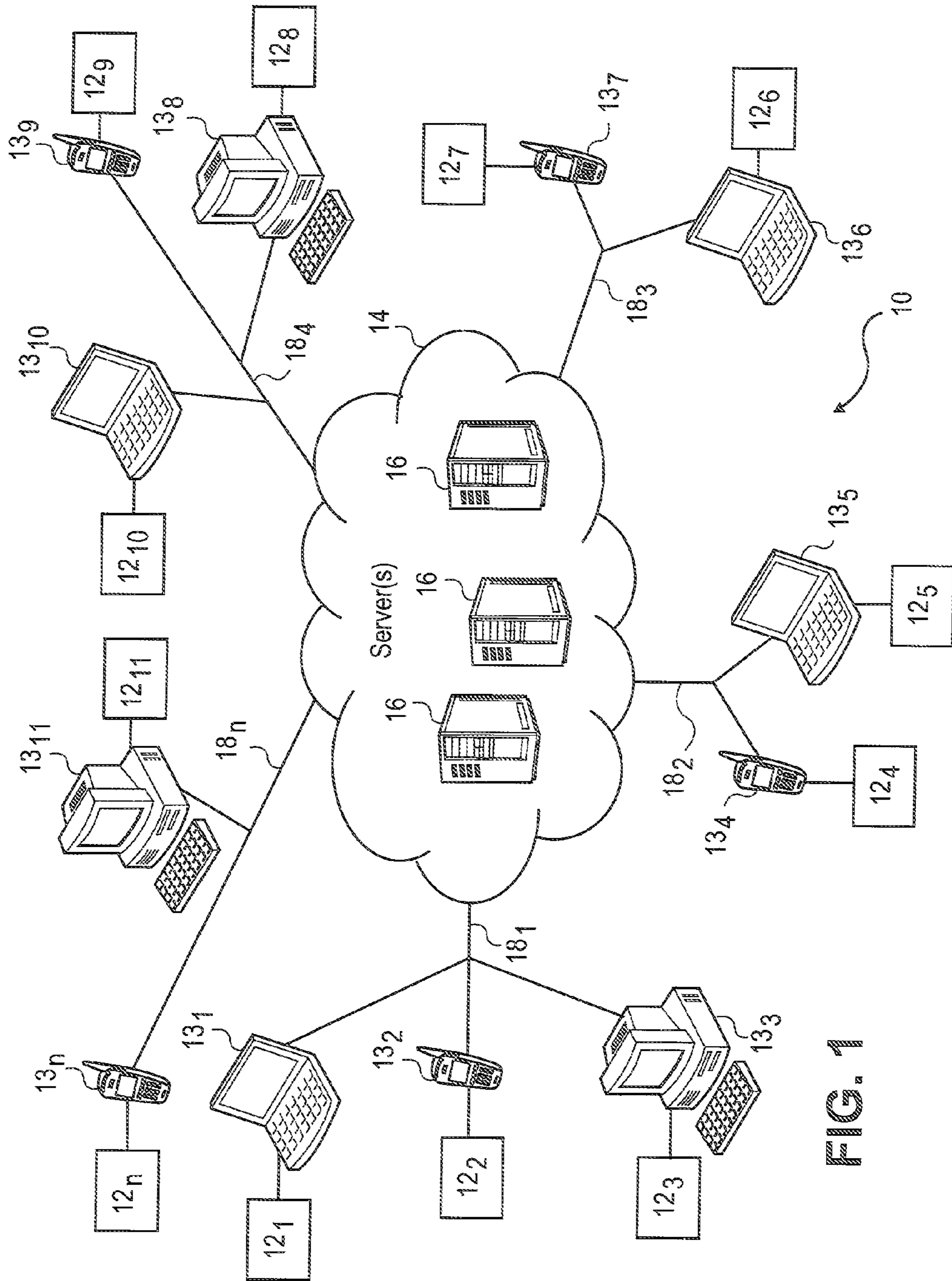


FIG. 1

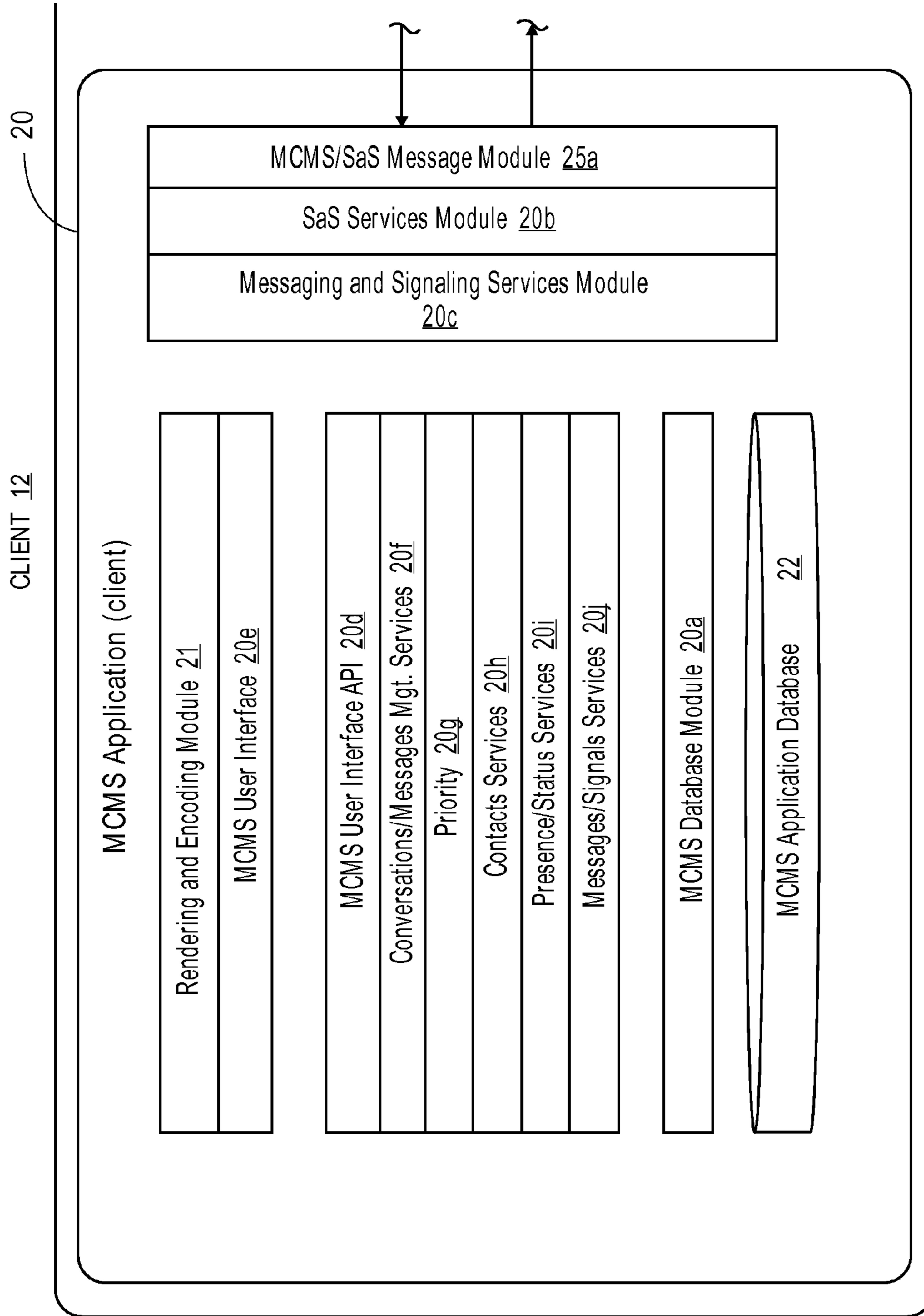


FIG. 2A

FIG. 2A FIG. 2B

CLIENT 12

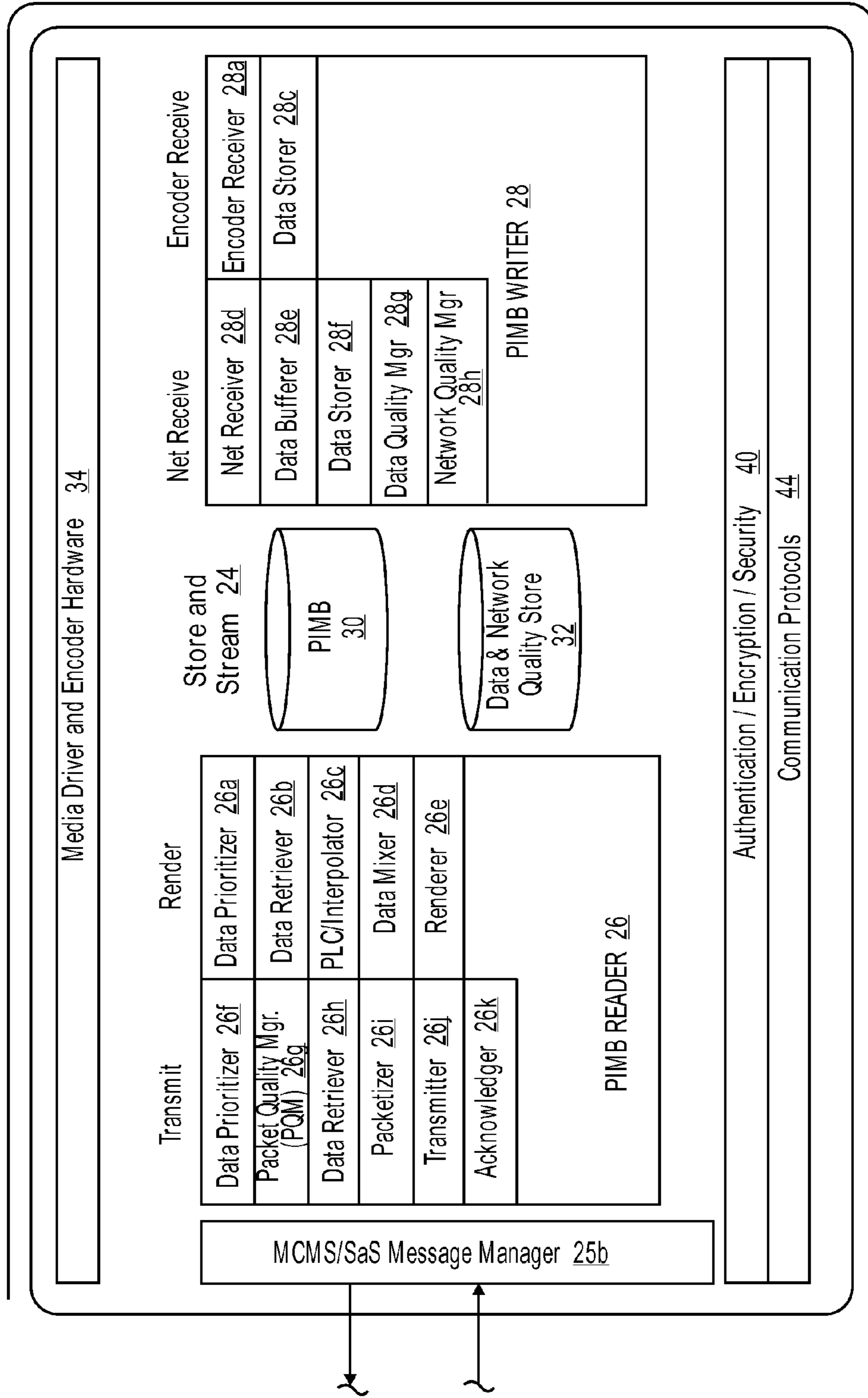
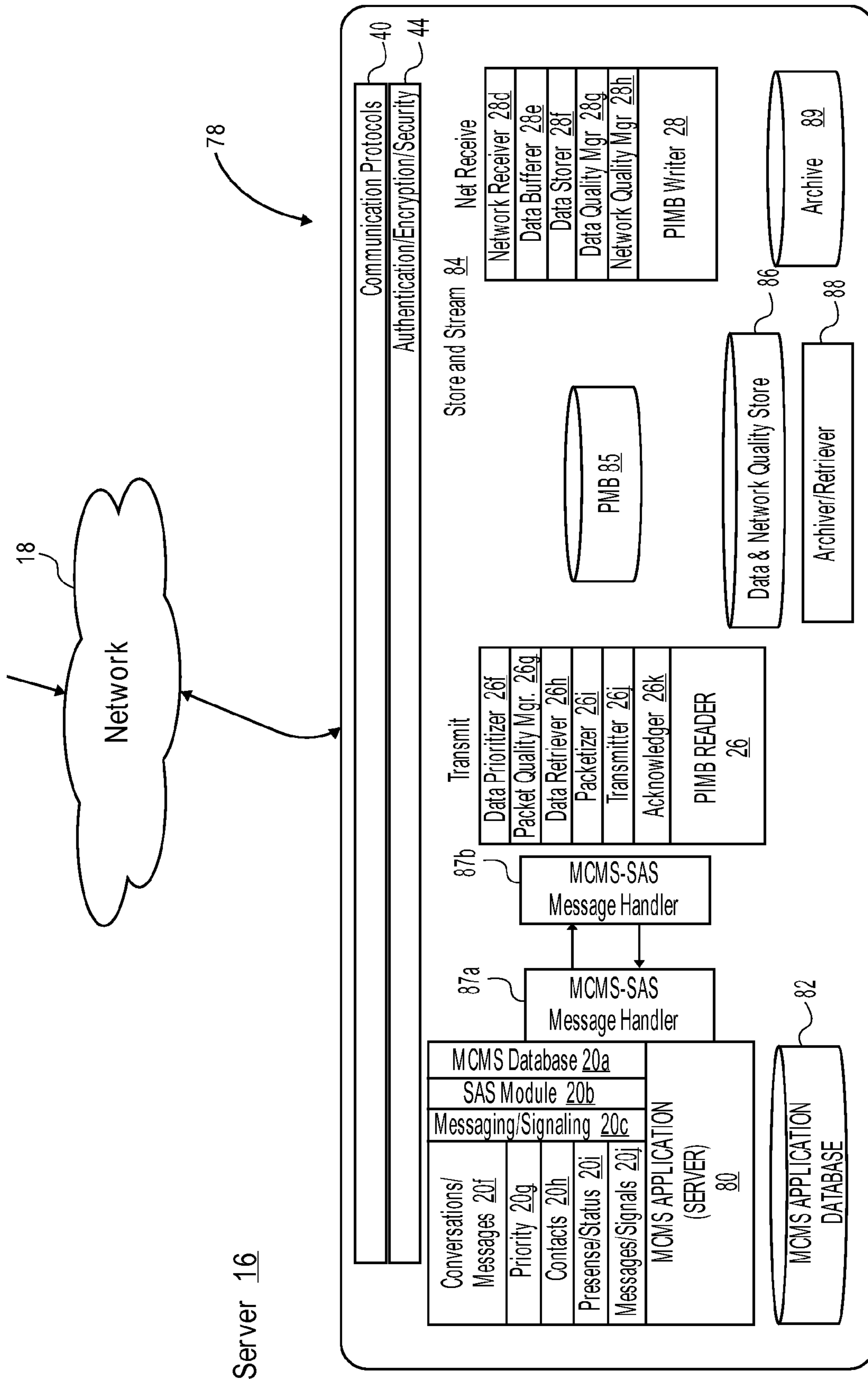


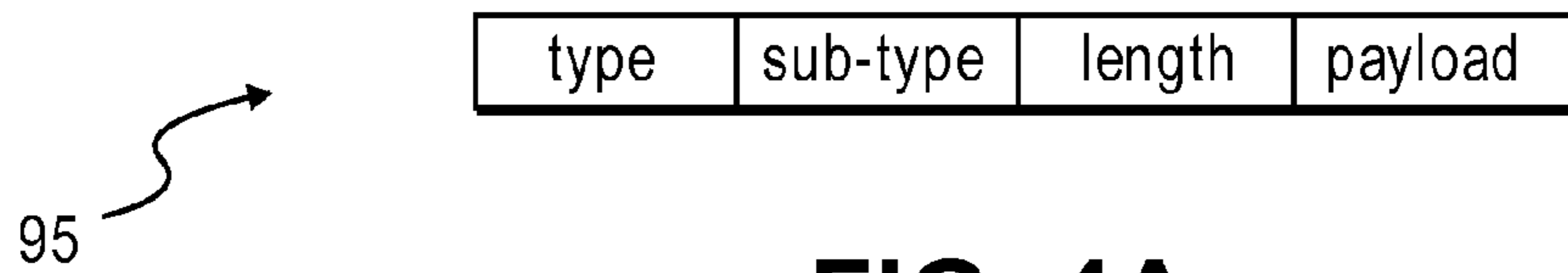
FIG. 2B

FIG. 2A FIG. 2B

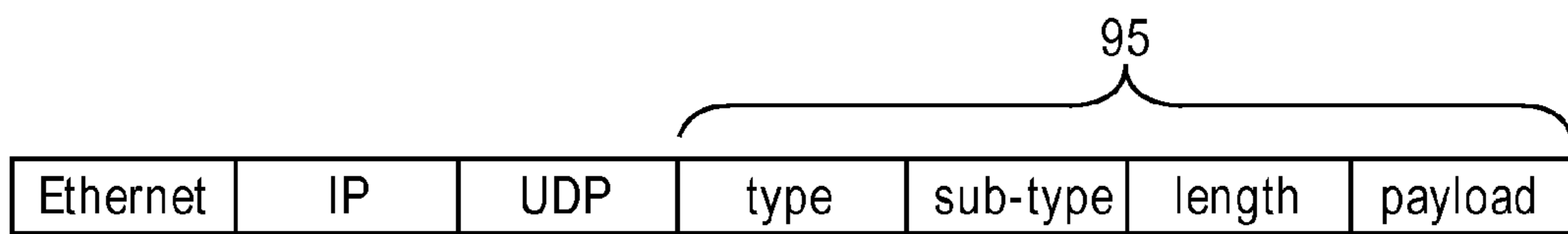




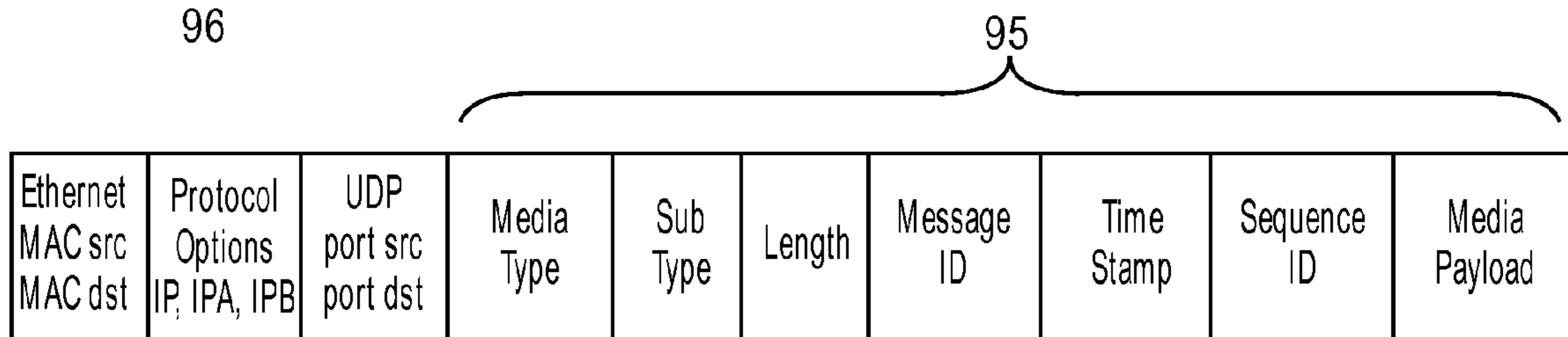
**FIG. 3**



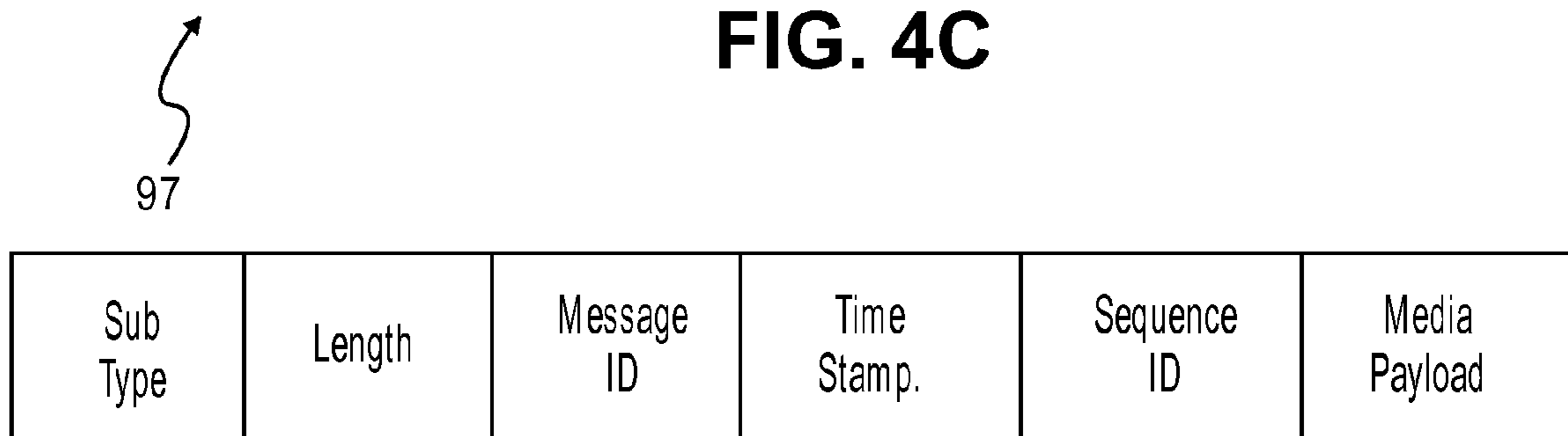
**FIG. 4A**



**FIG. 4B**



**FIG. 4C**



**FIG. 4D**



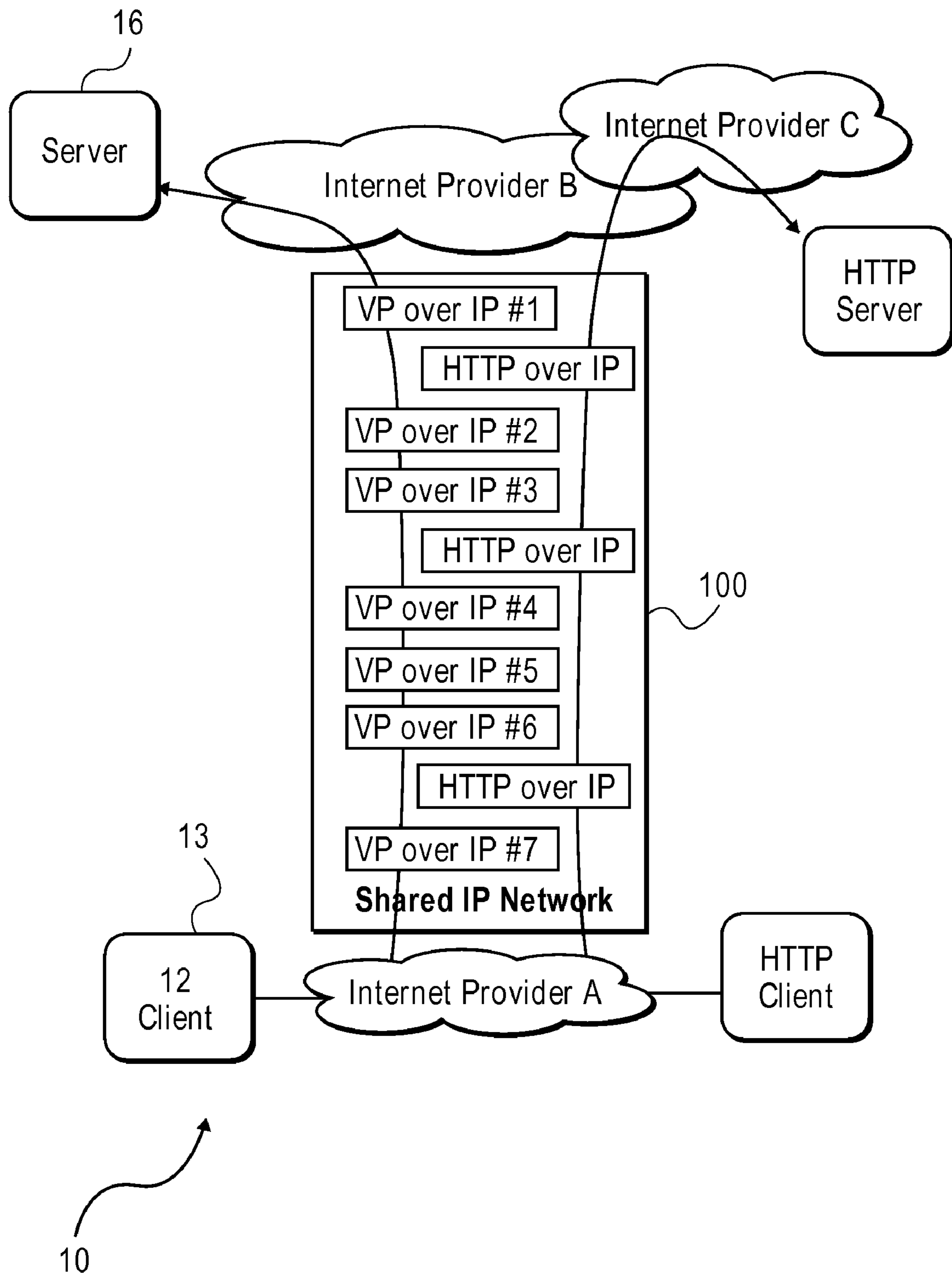
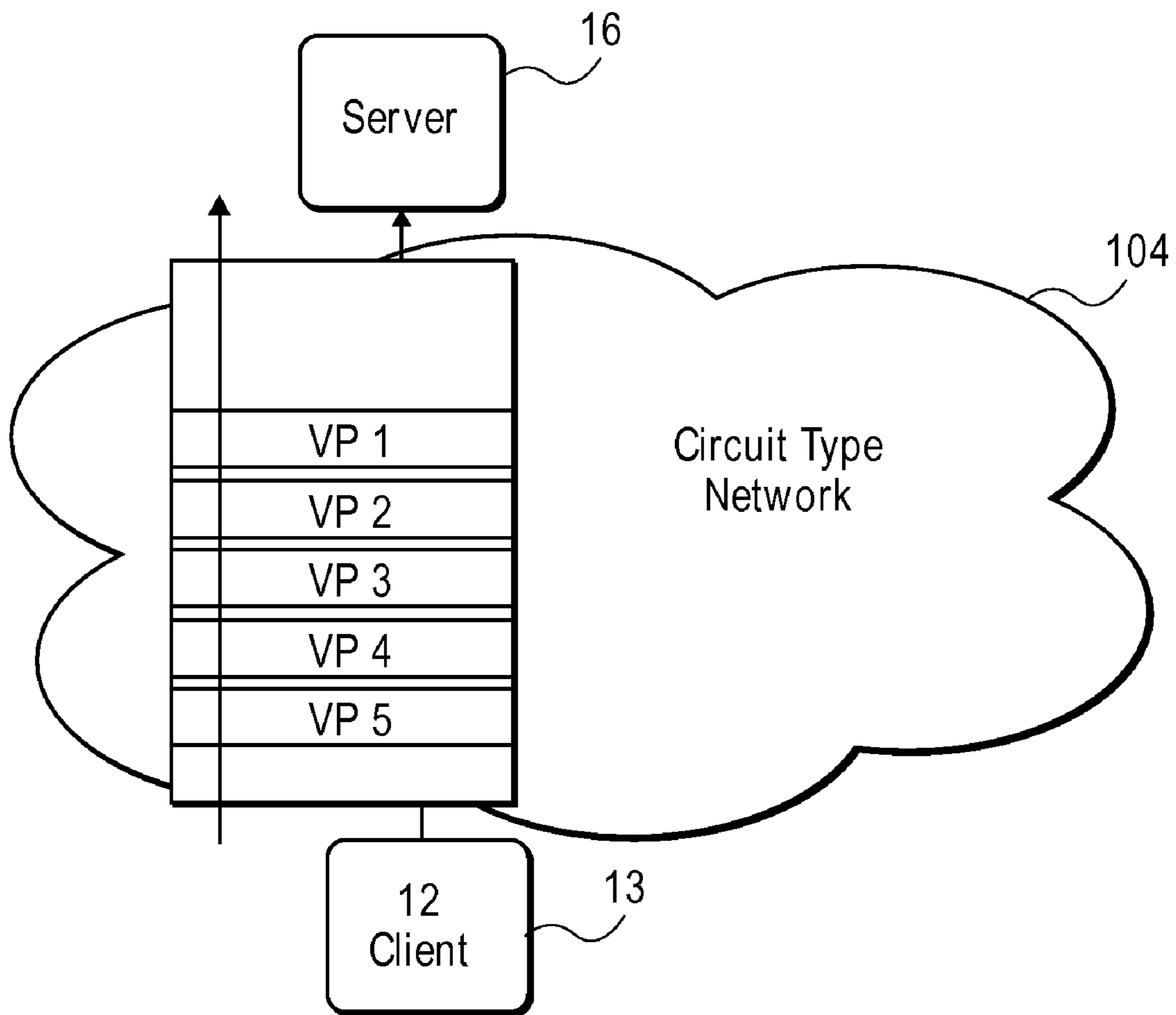
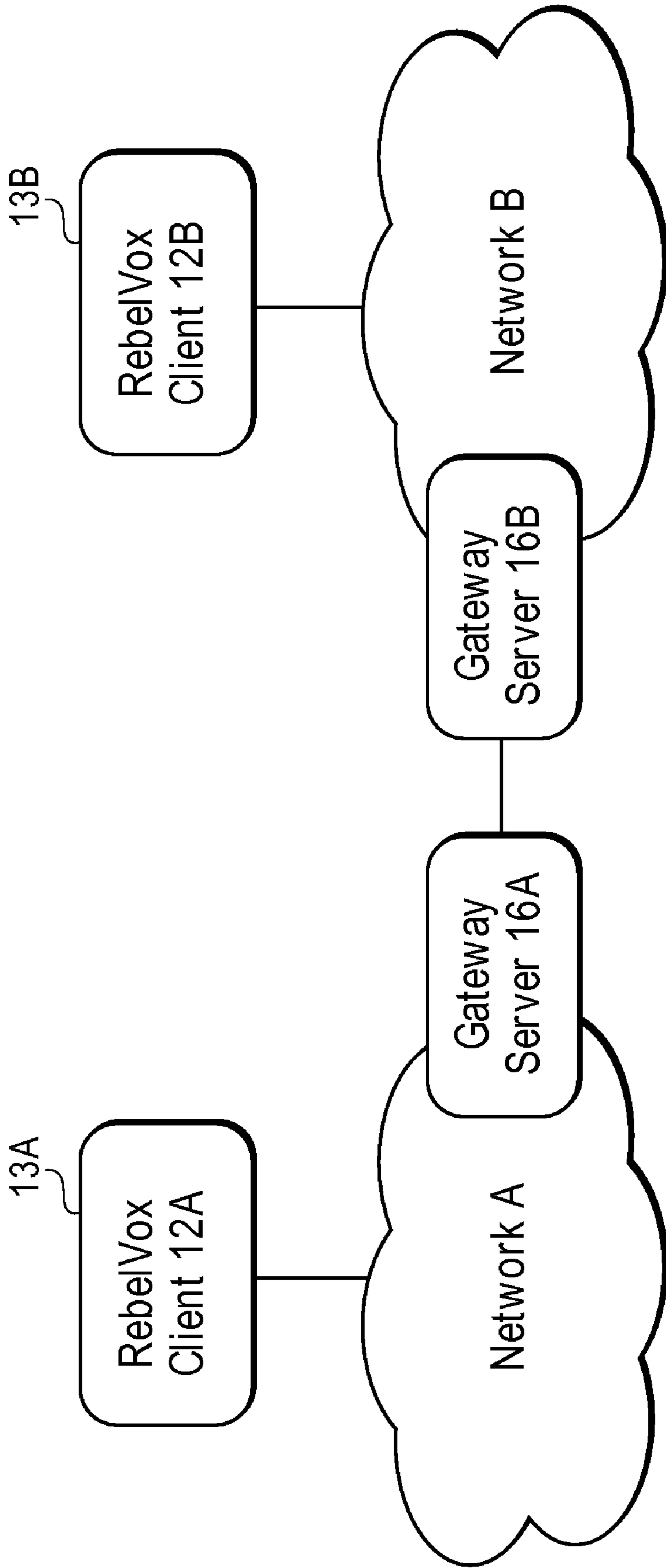


FIG. 5



**FIG. 6**



**FIG. 7**

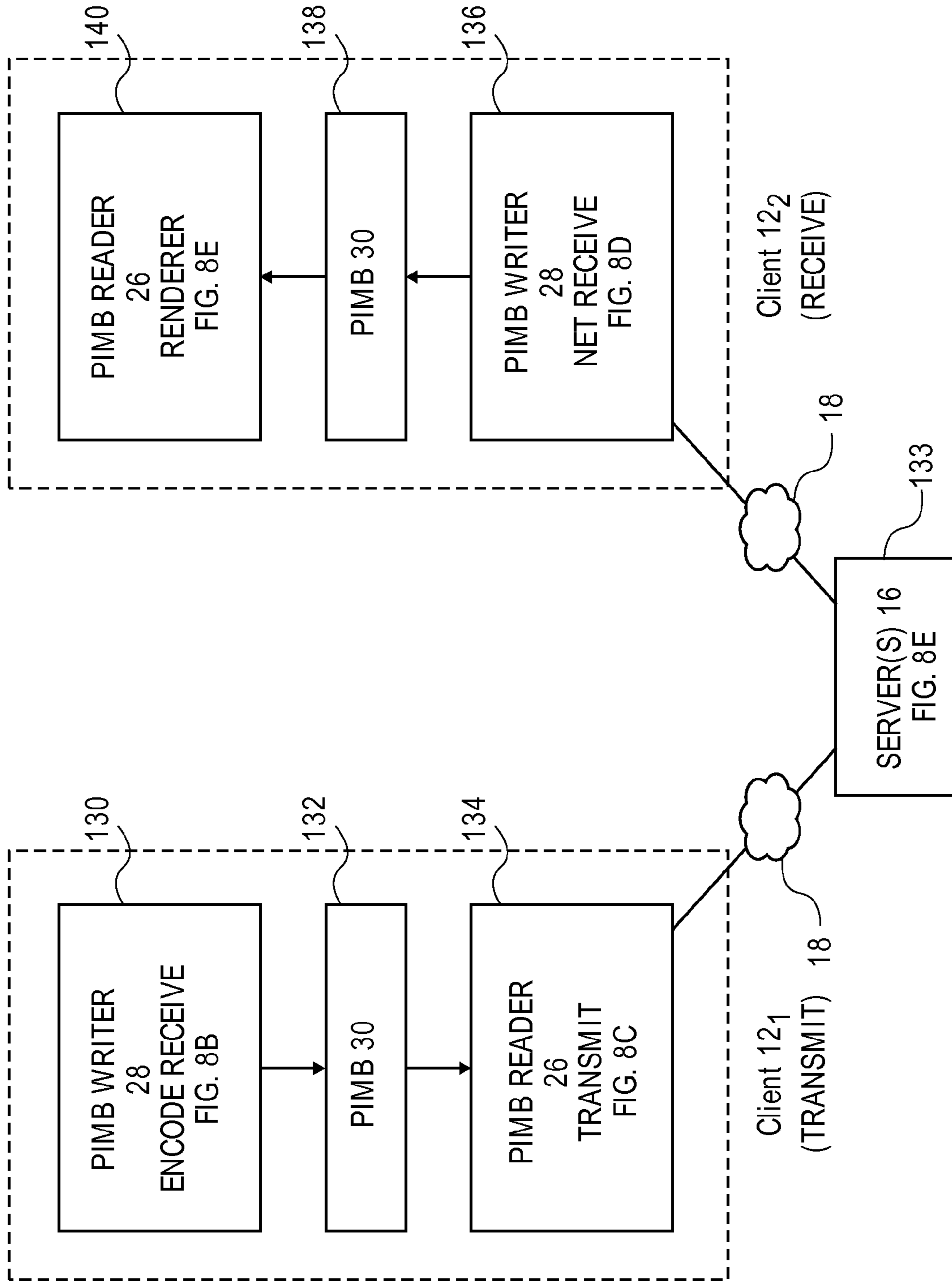
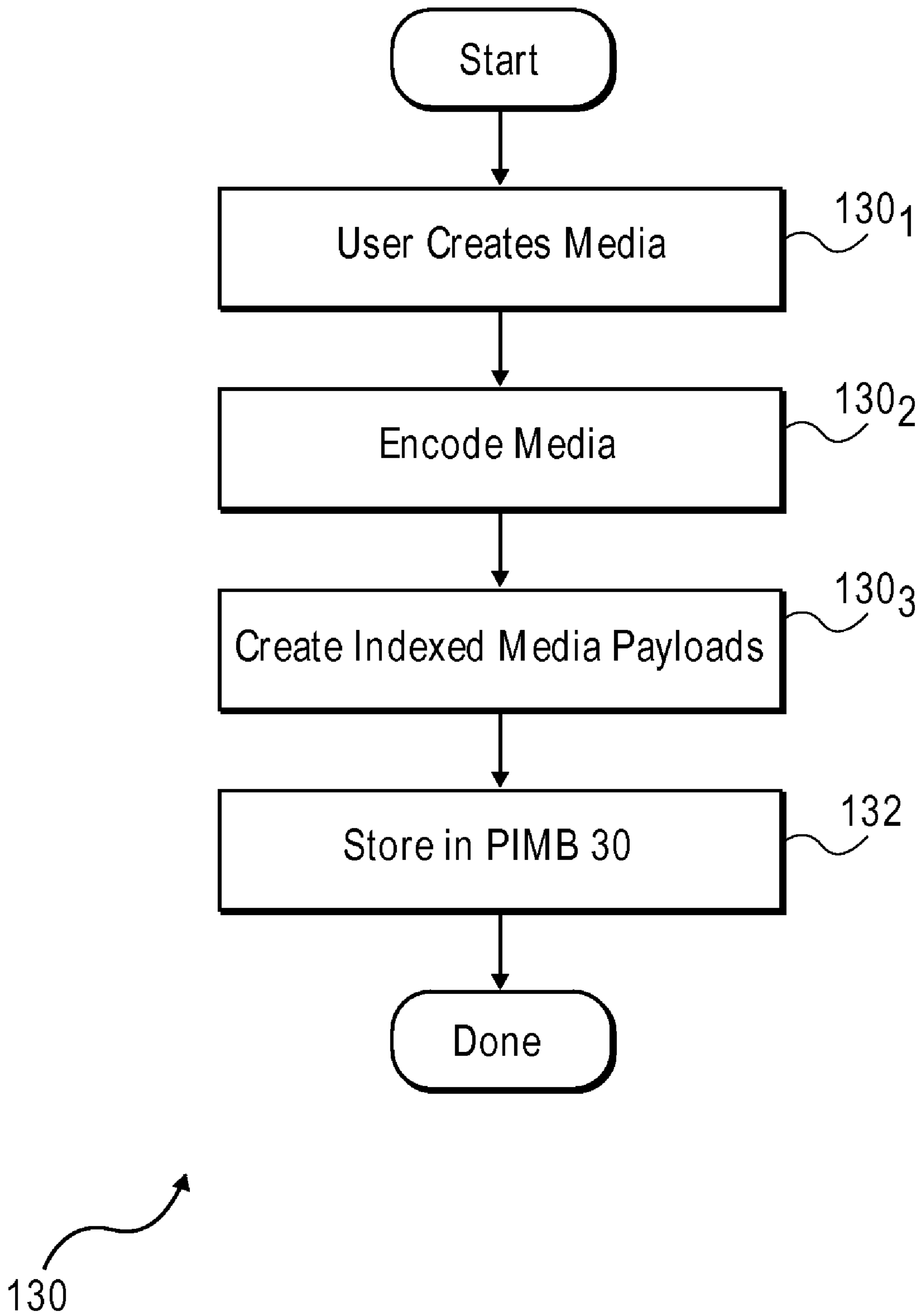
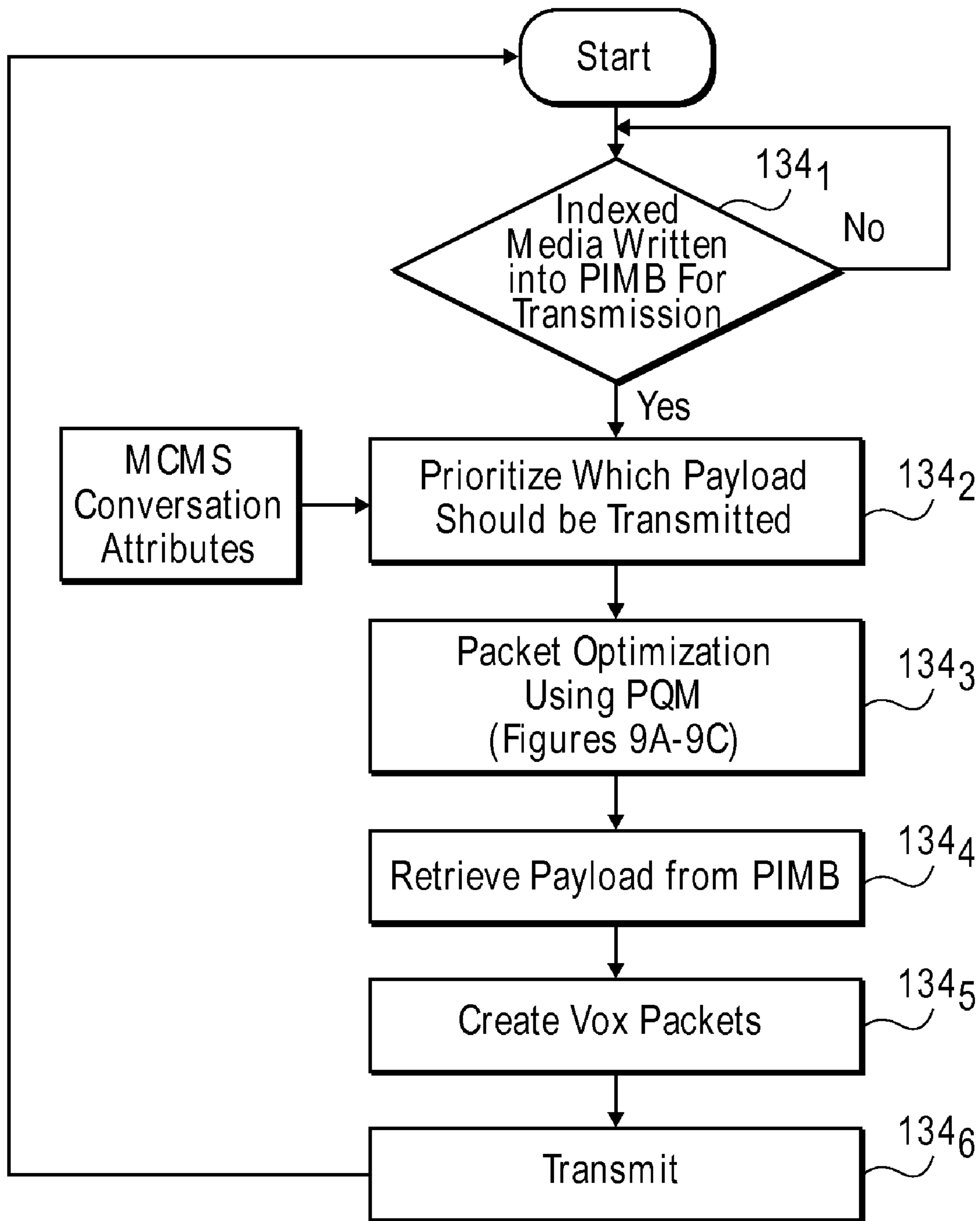


FIG. 8A

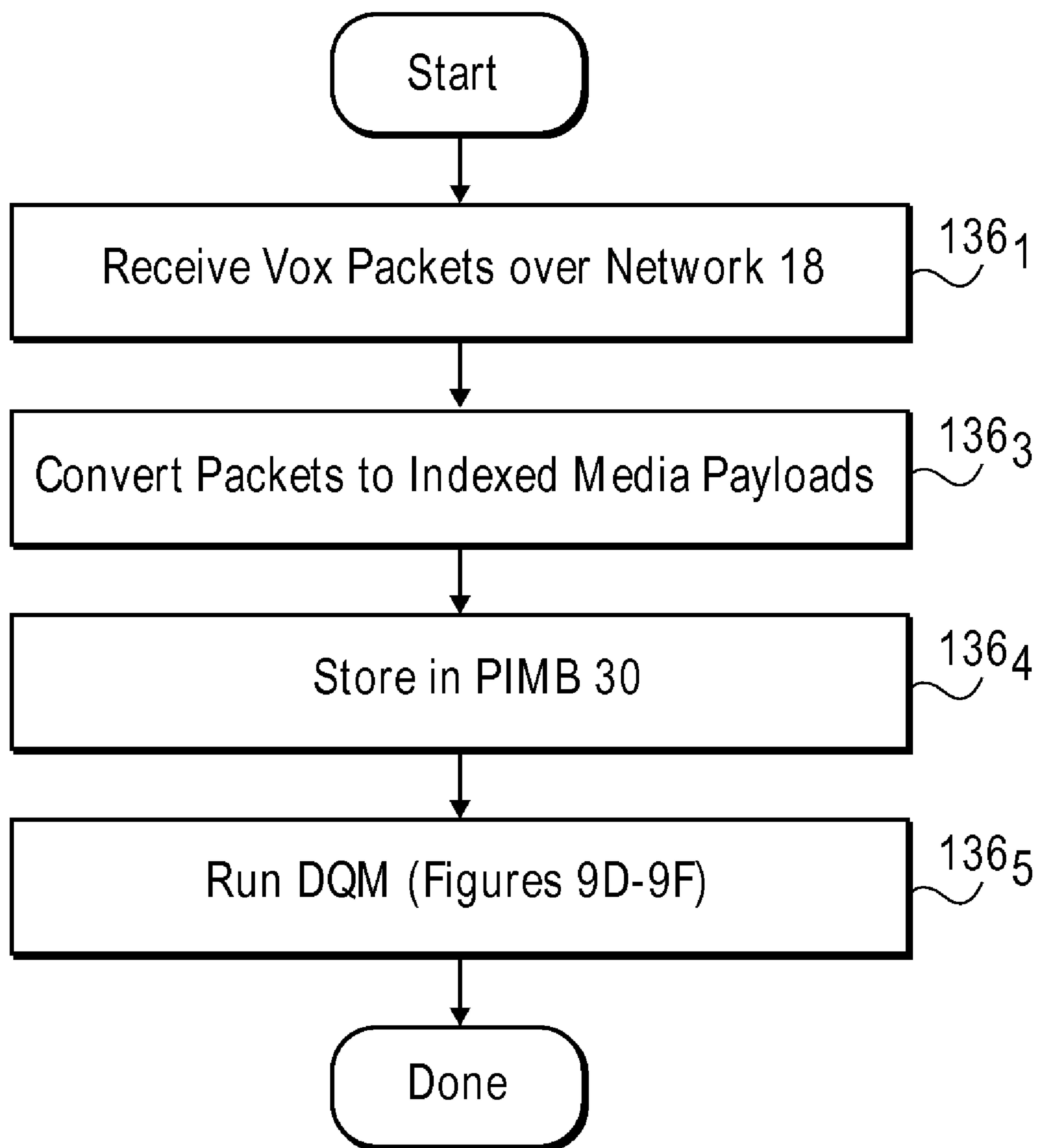


**FIG. 8B**



**FIG. 8C**





**FIG. 8D**

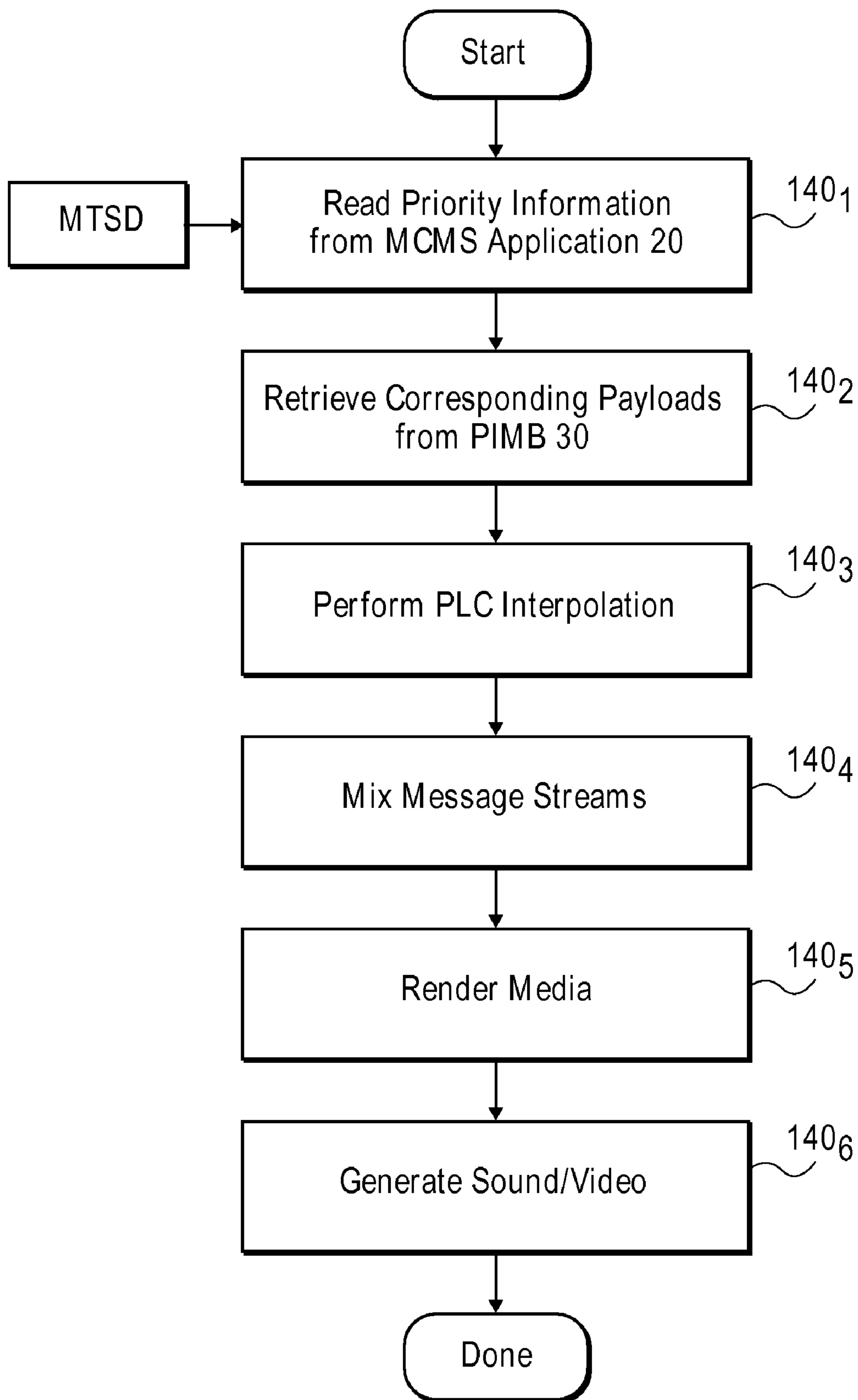
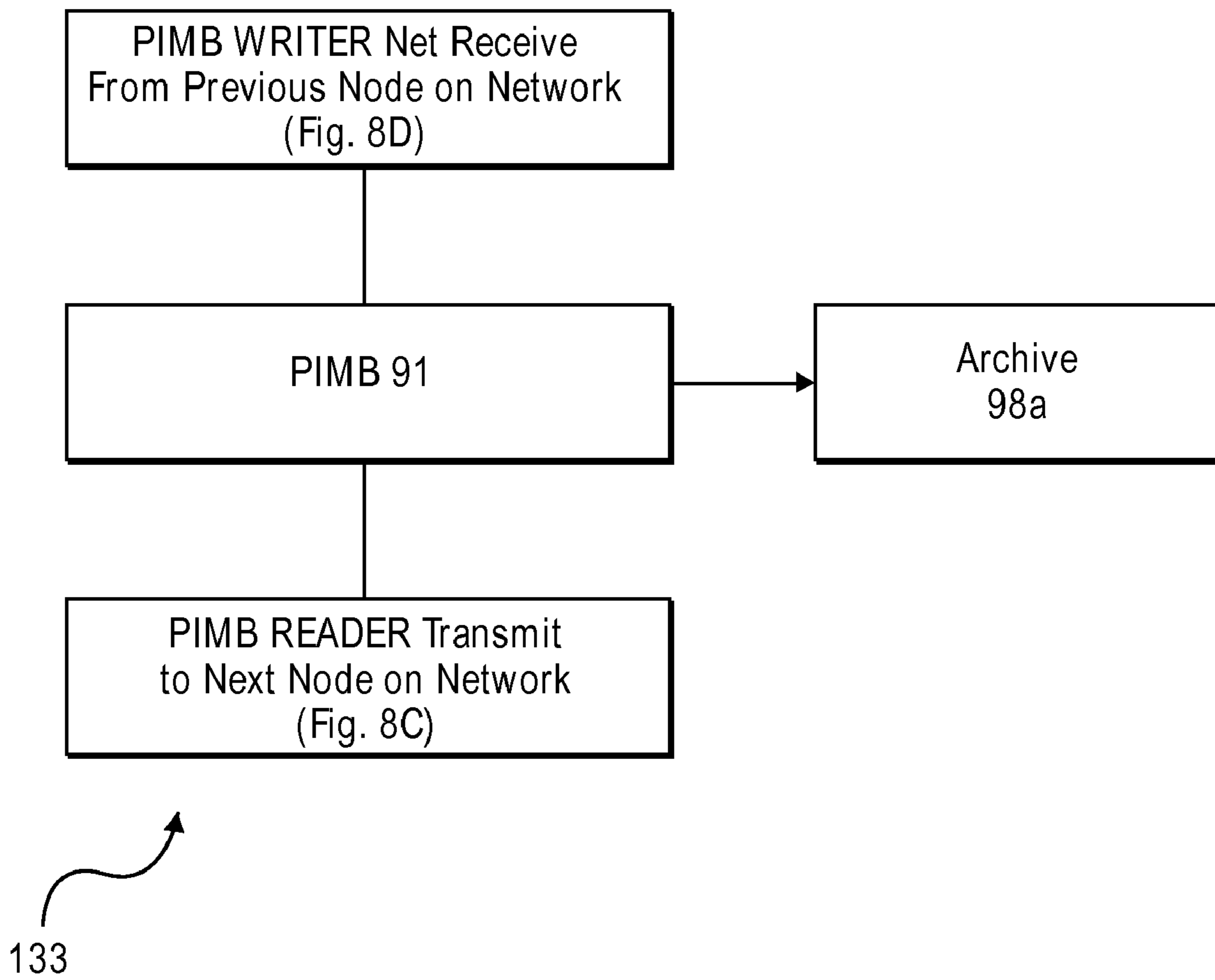
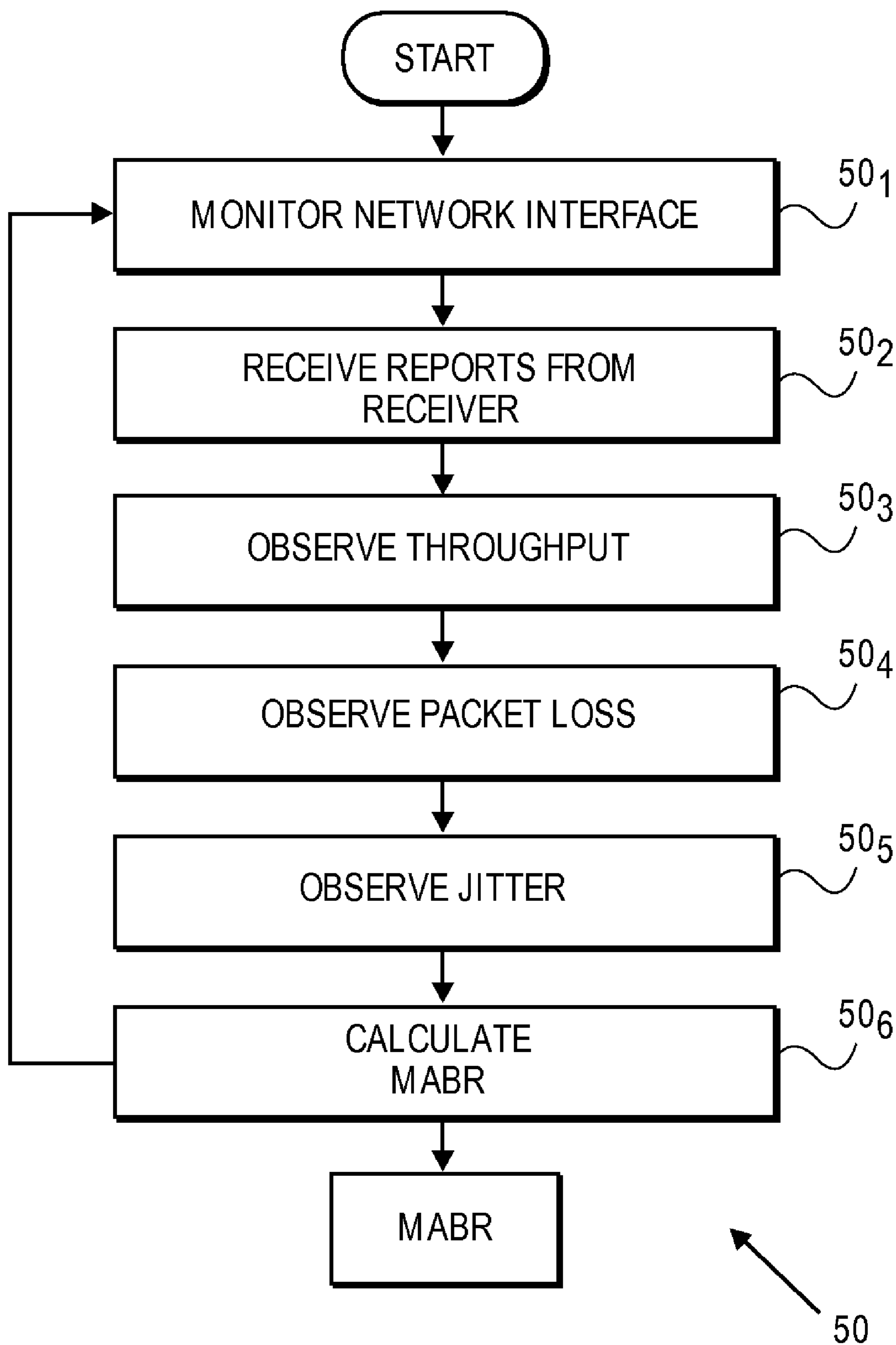


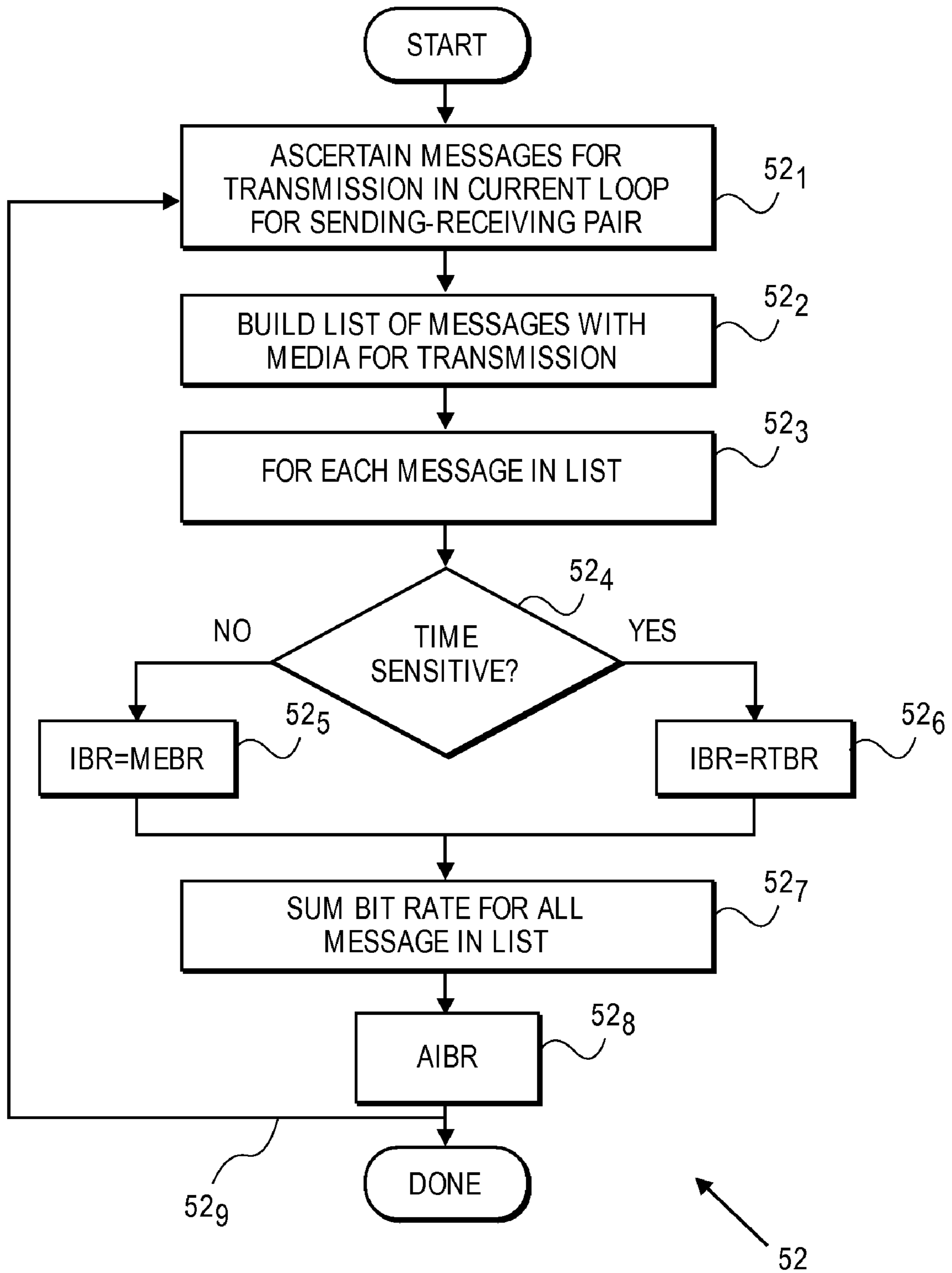
FIG. 8E



**FIG. 8F**



**FIG. 9A**



**FIG. 9B**

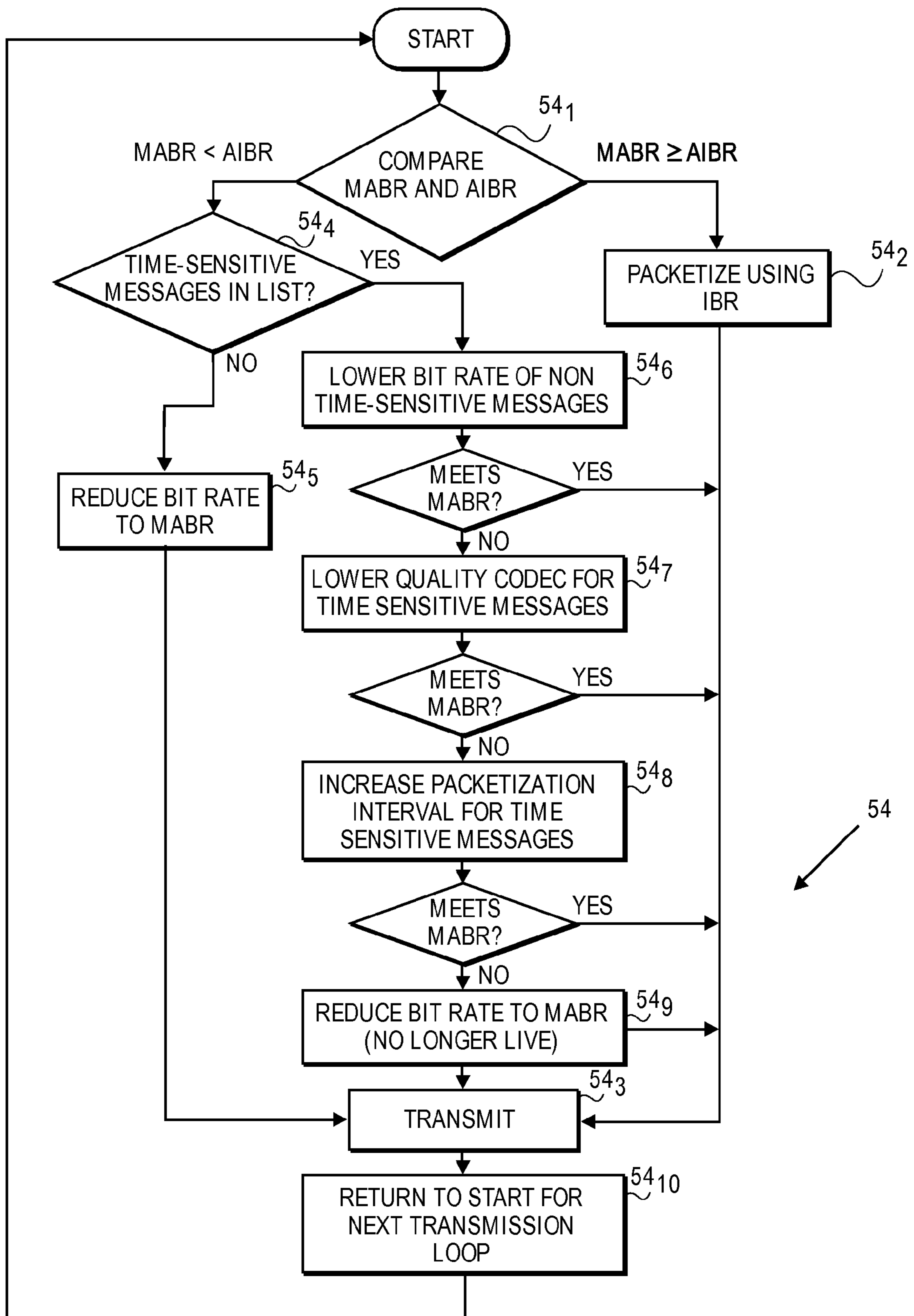


FIG. 9C

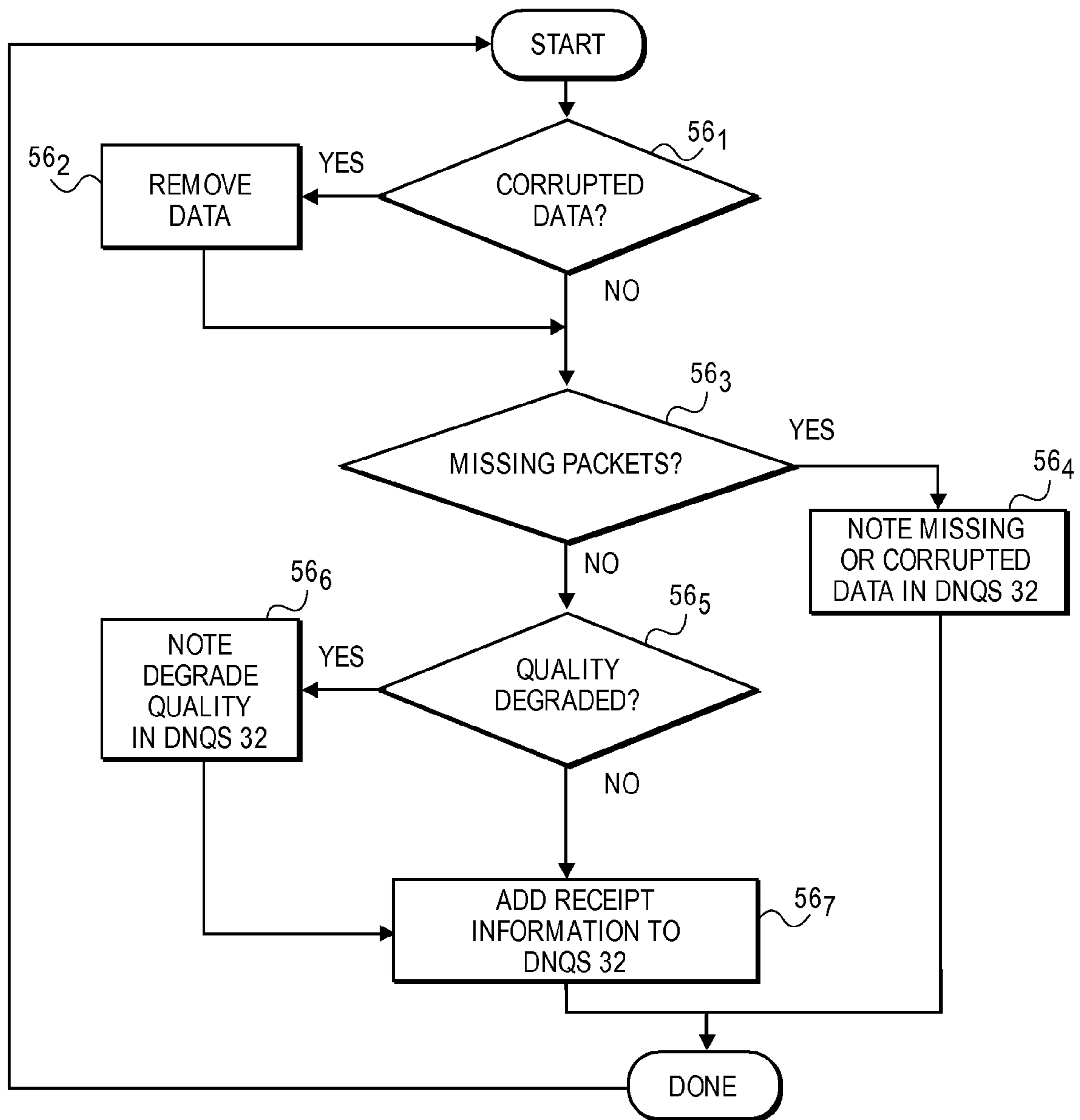


FIG. 9D

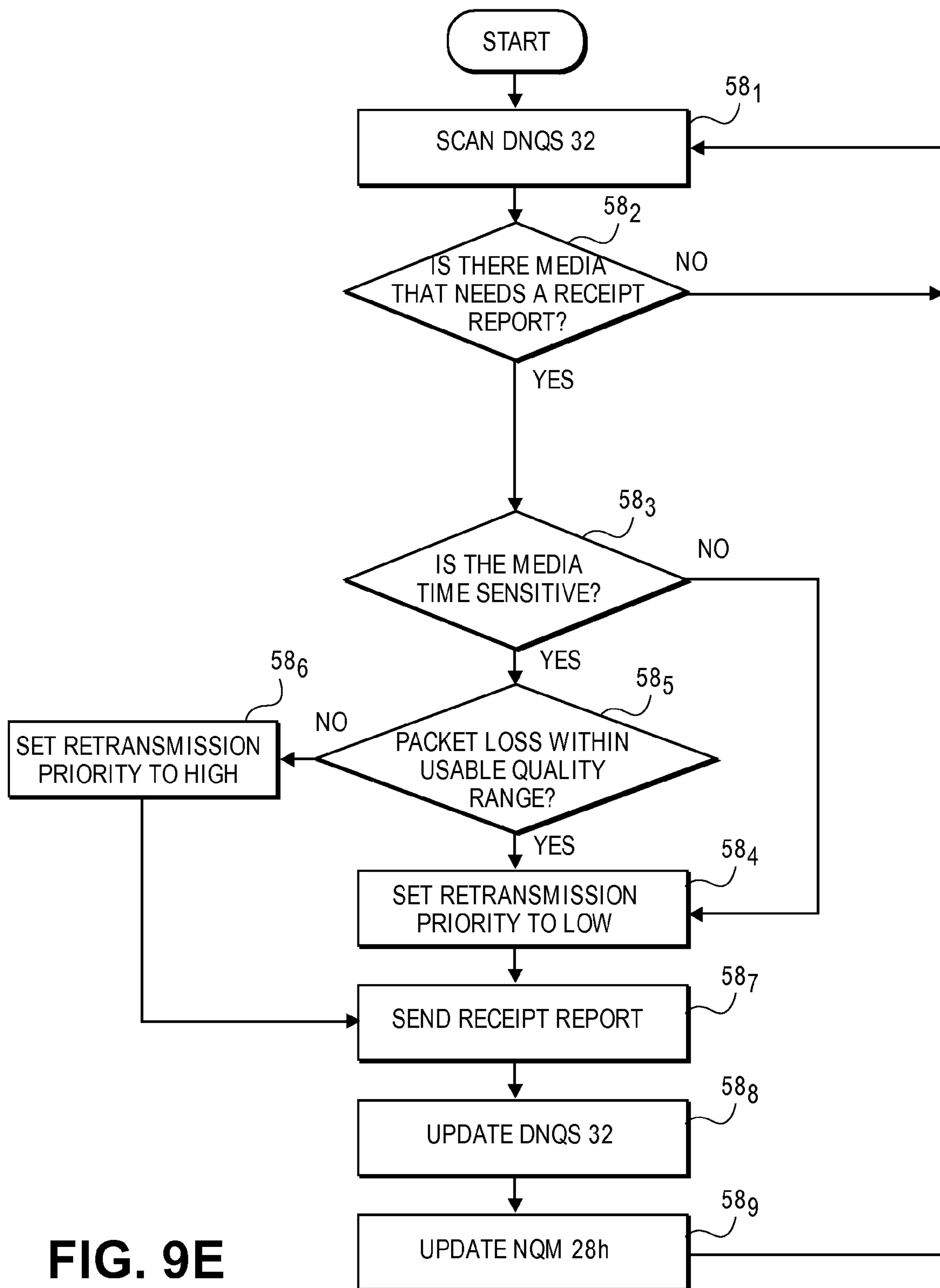


FIG. 9E



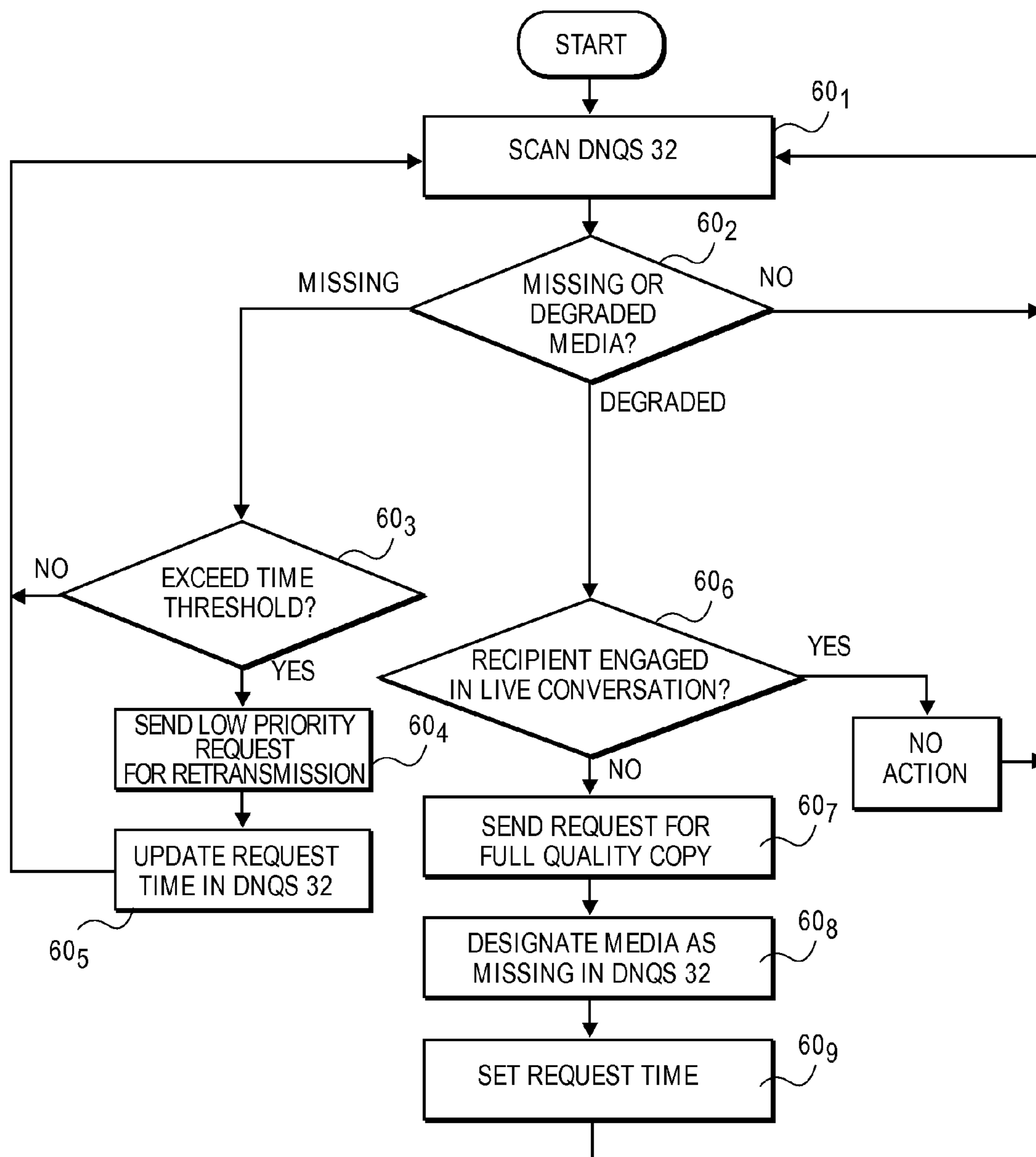
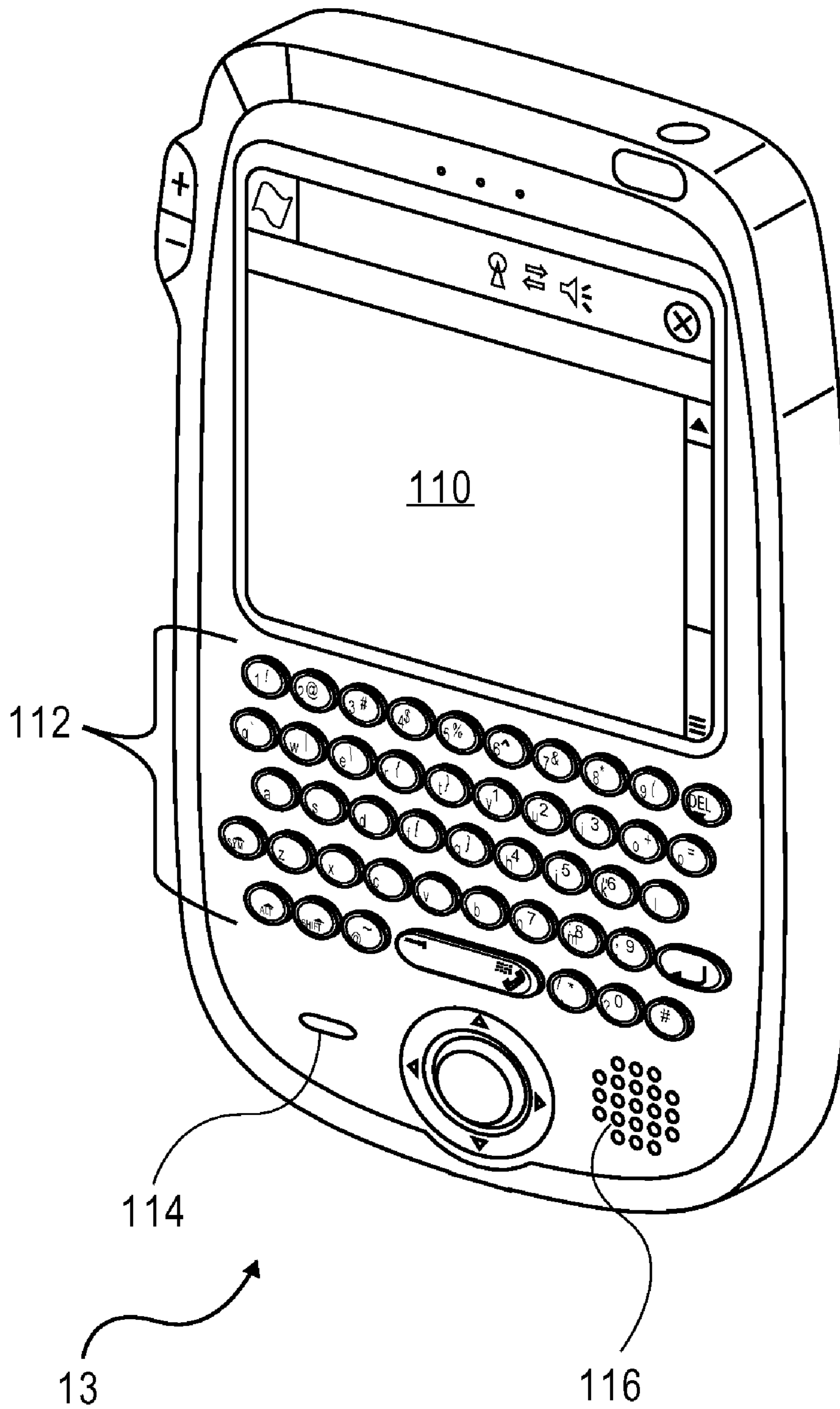
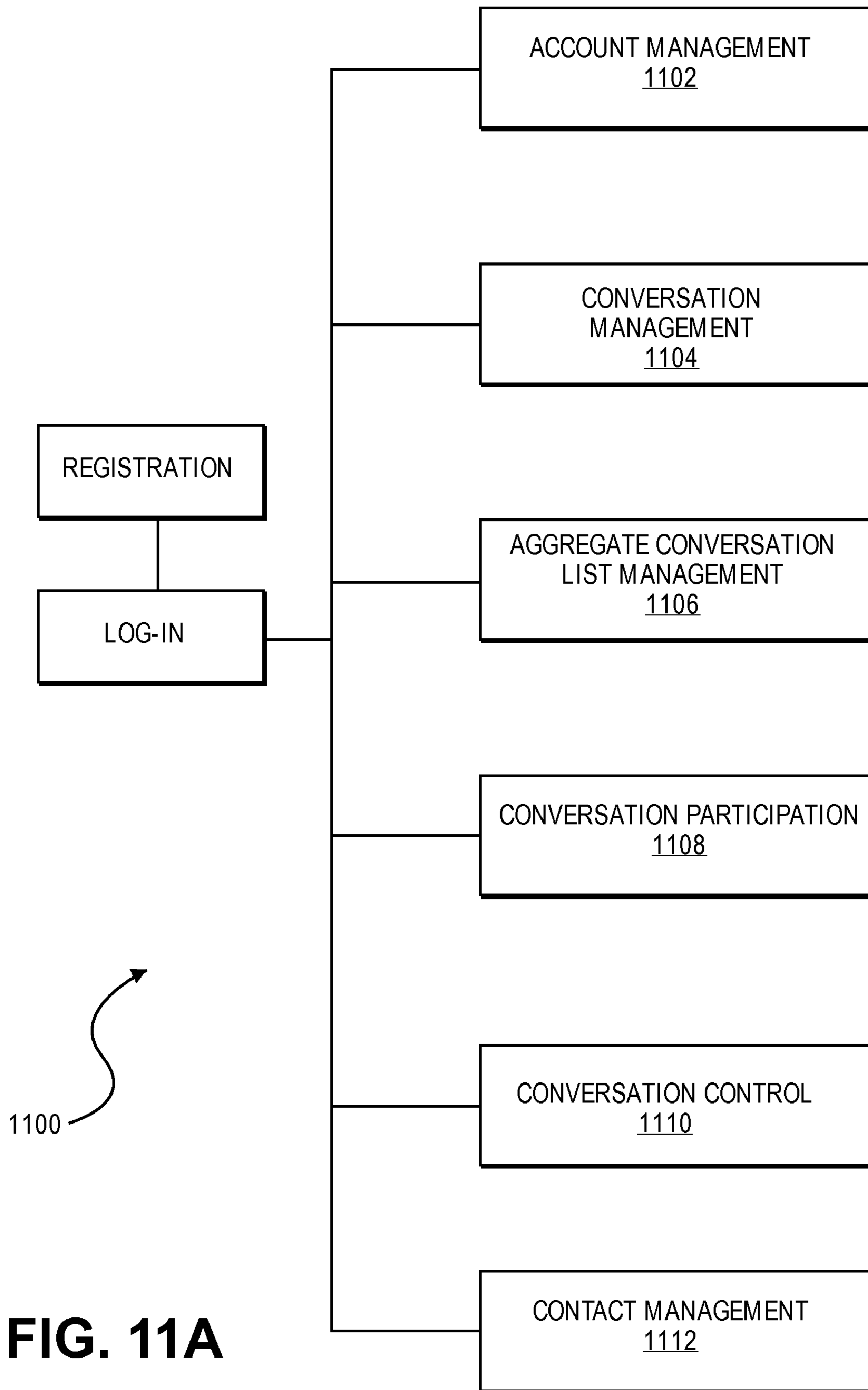


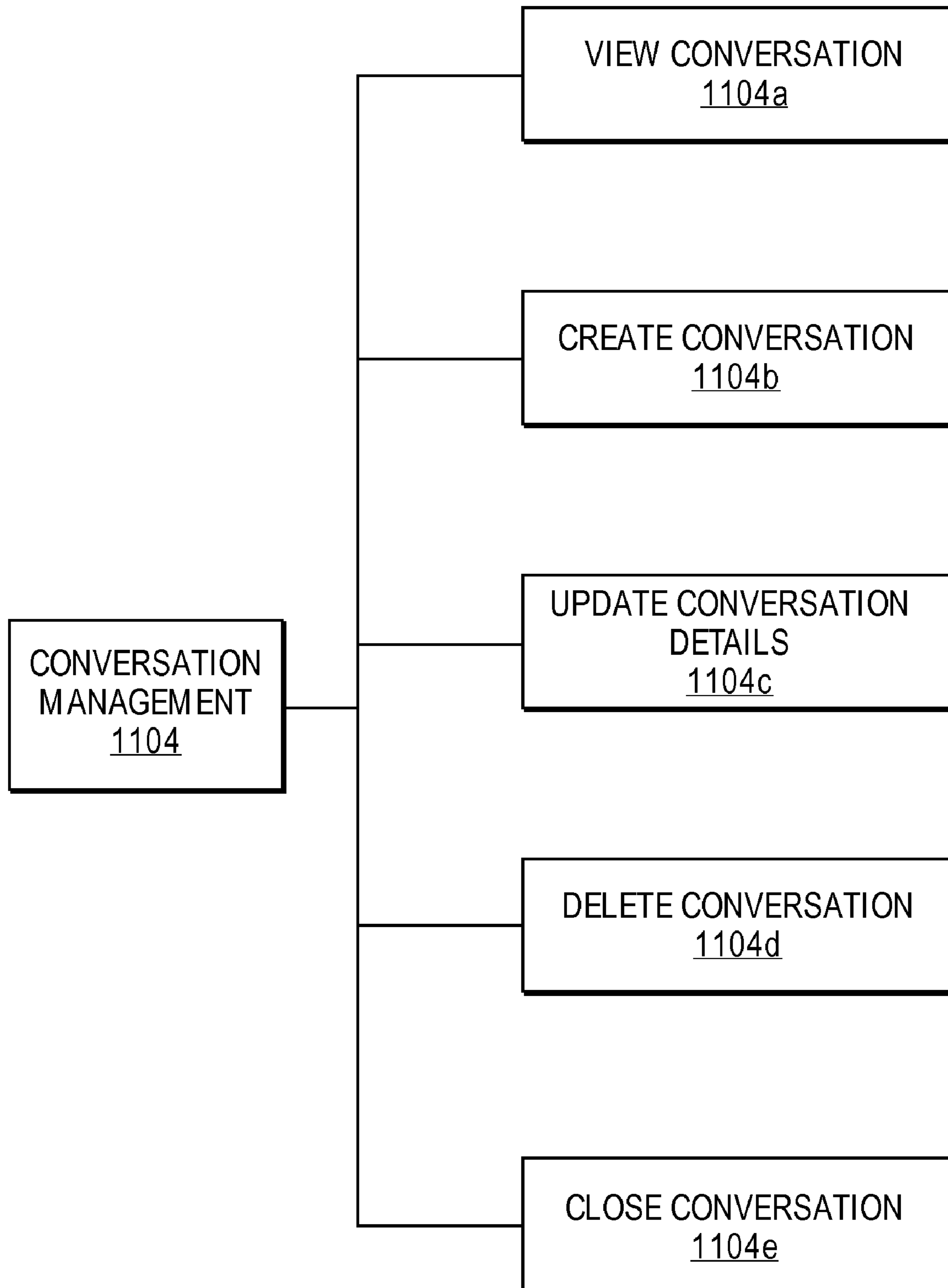
FIG. 9F



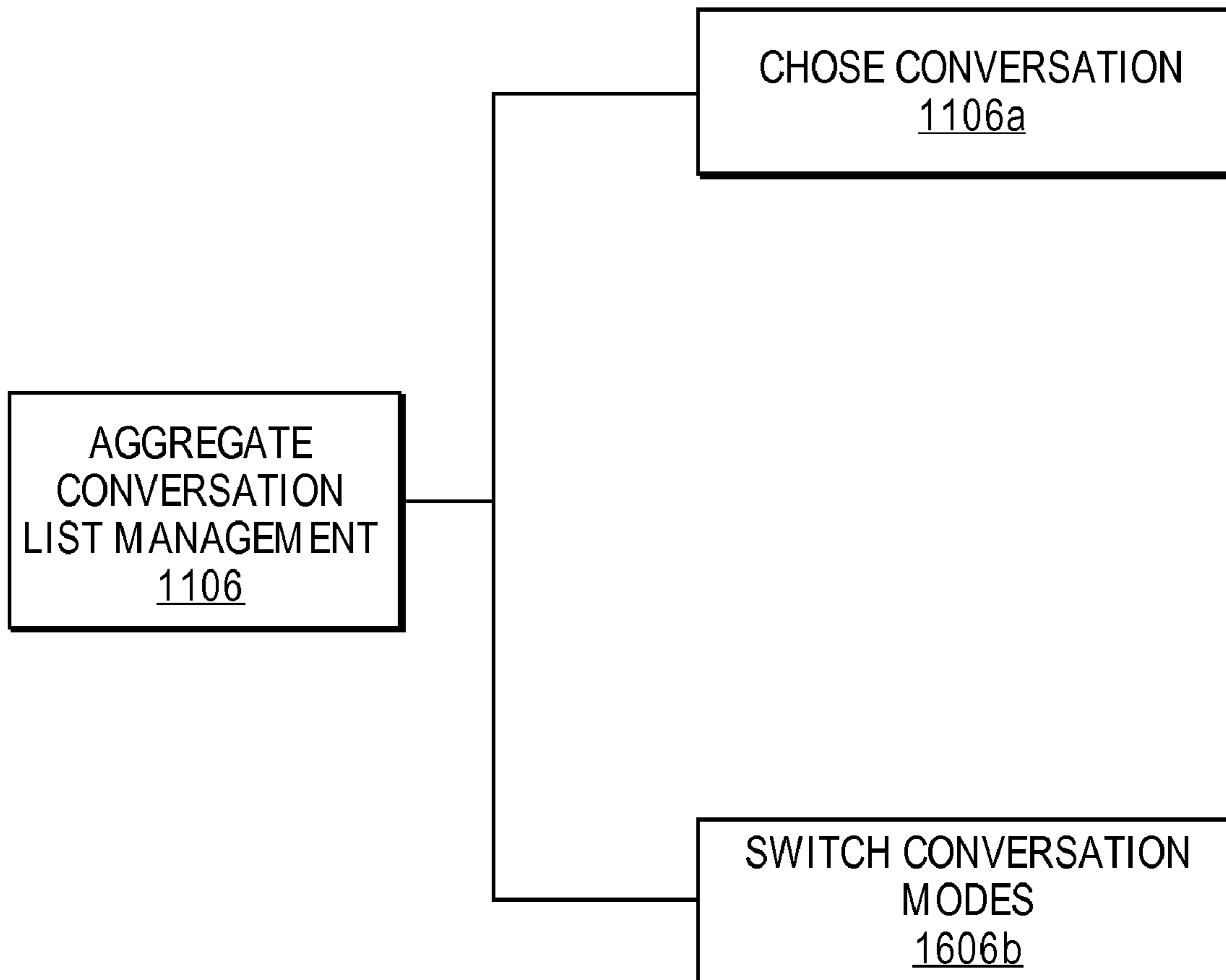
**FIG. 10**



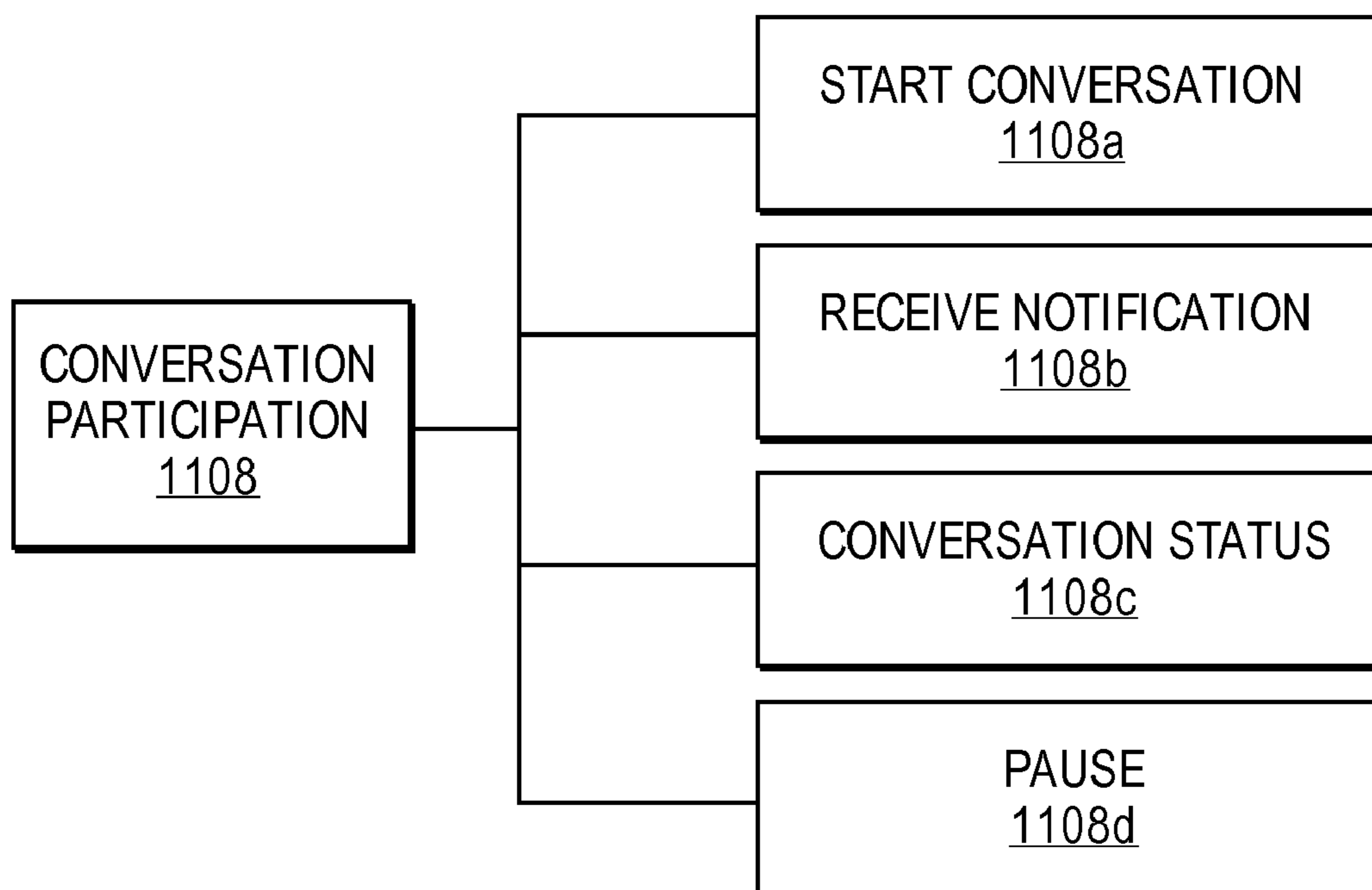
**FIG. 11A**



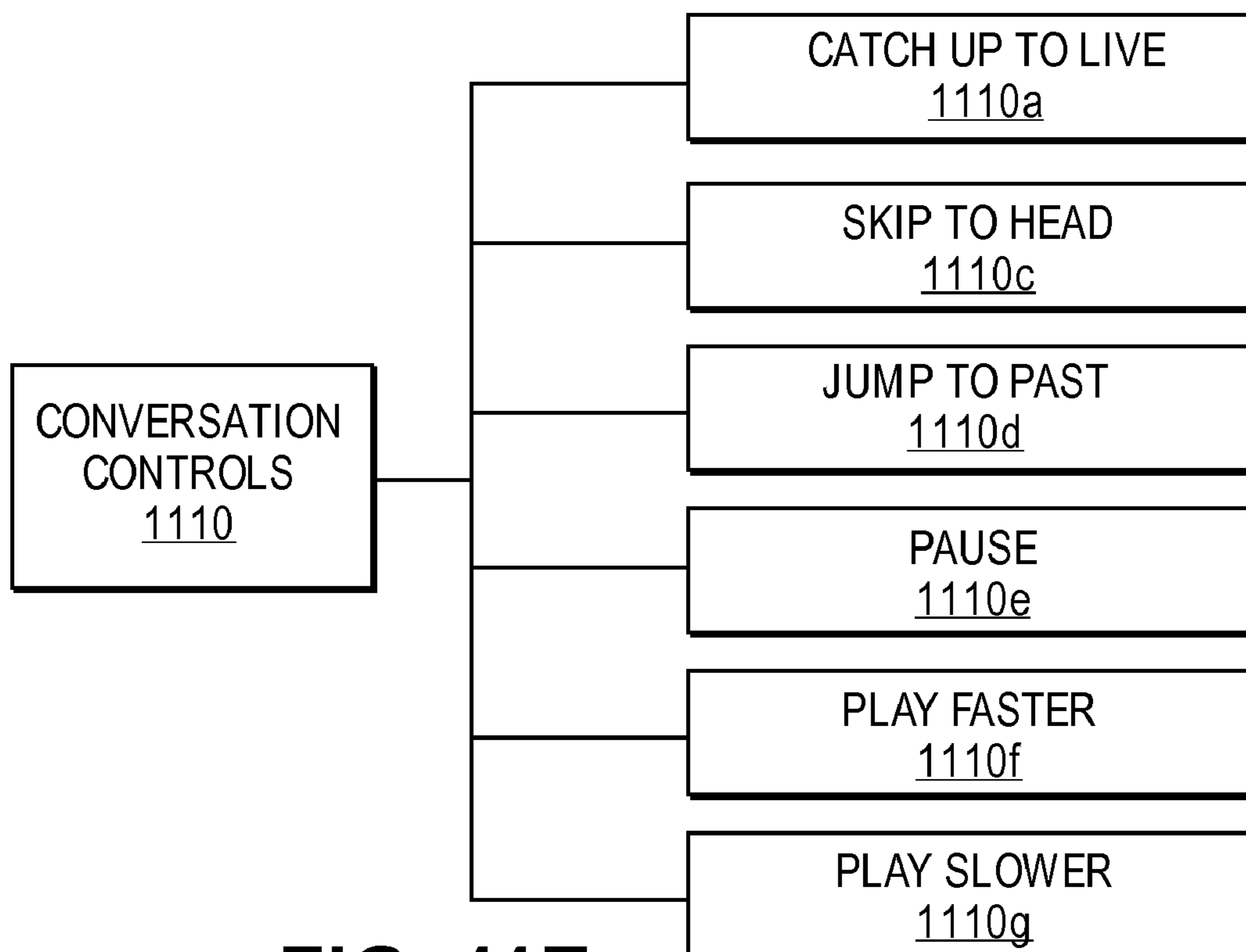
**FIG. 11B**



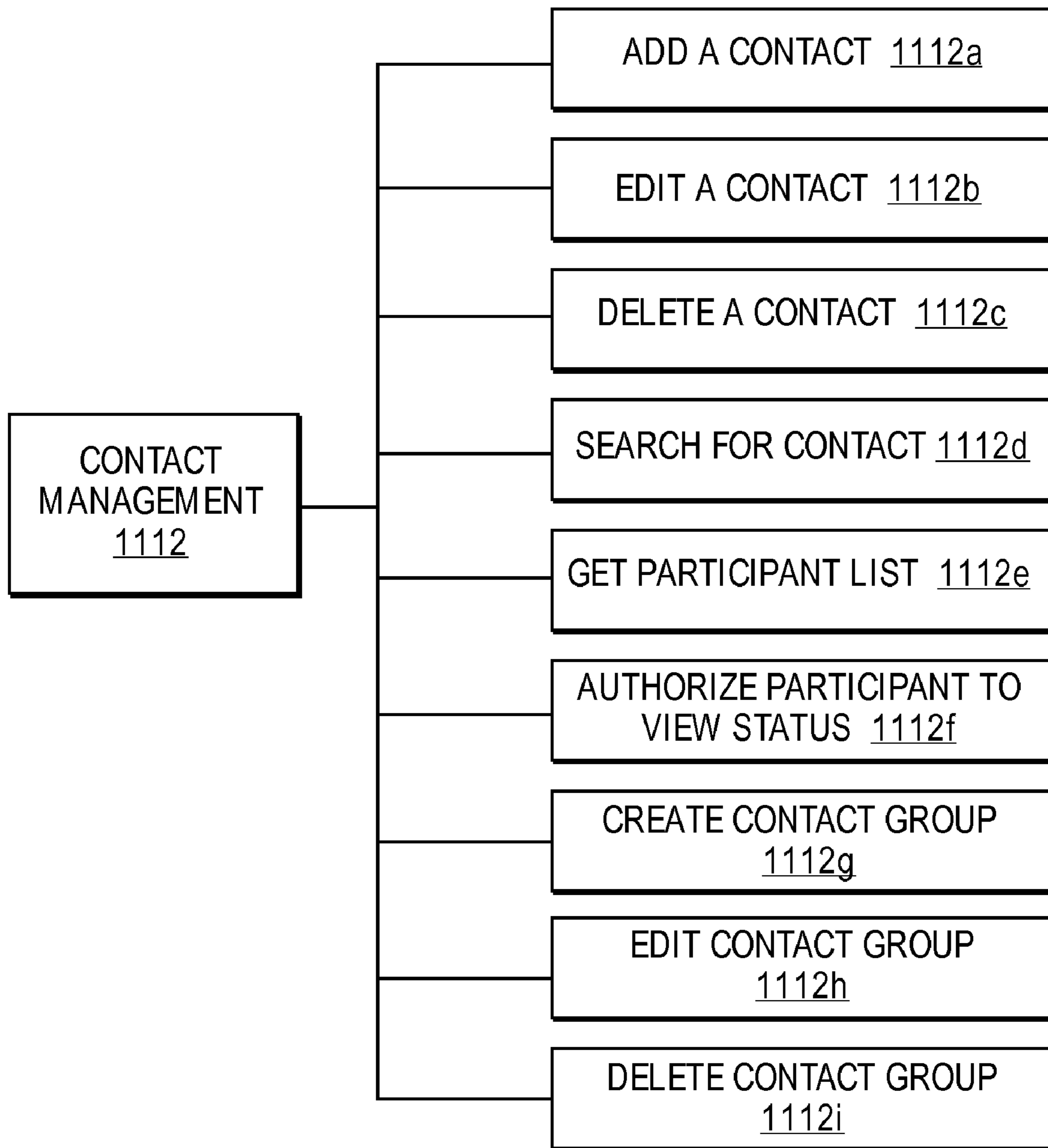
**FIG. 11C**



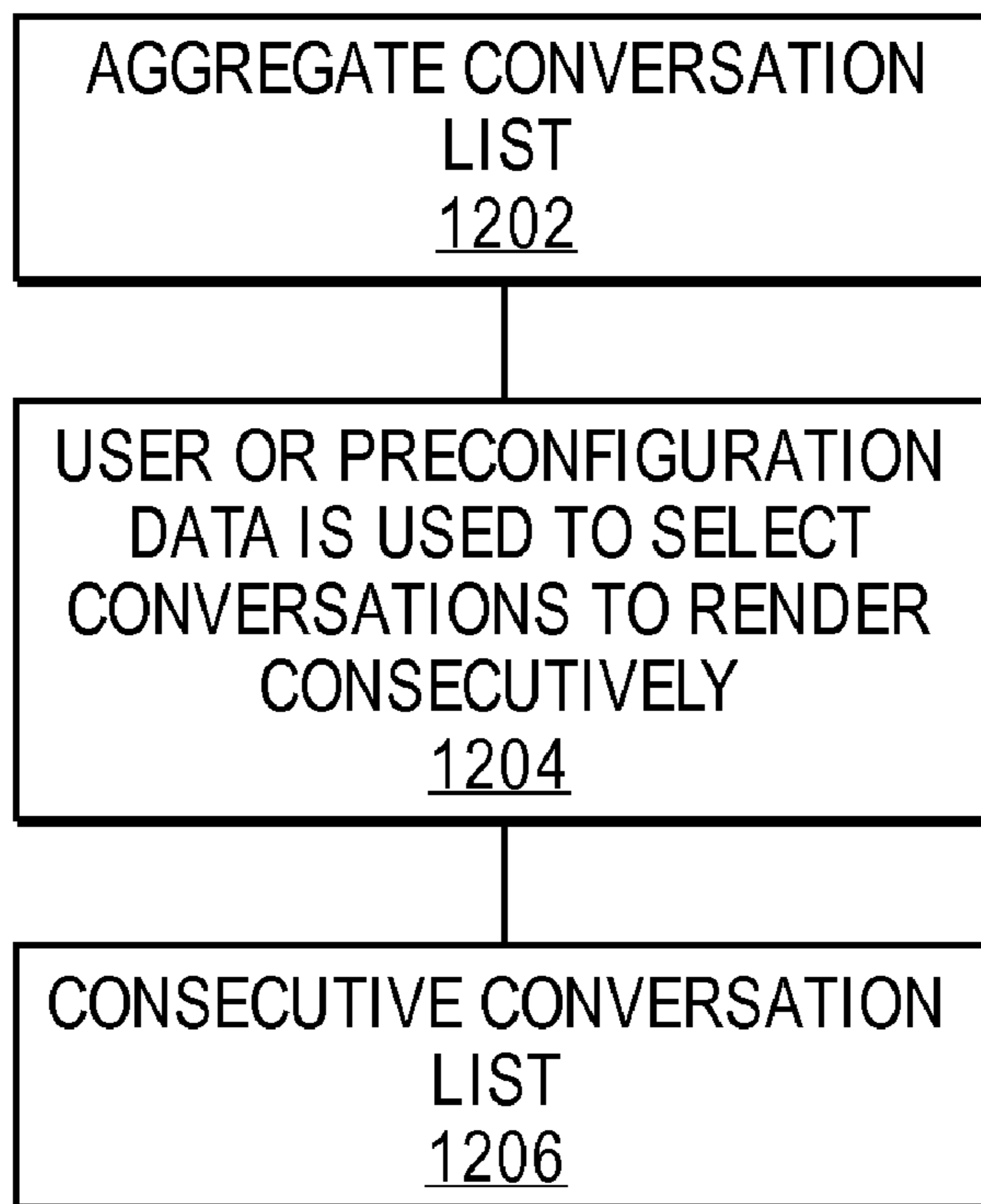
**FIG. 11D**



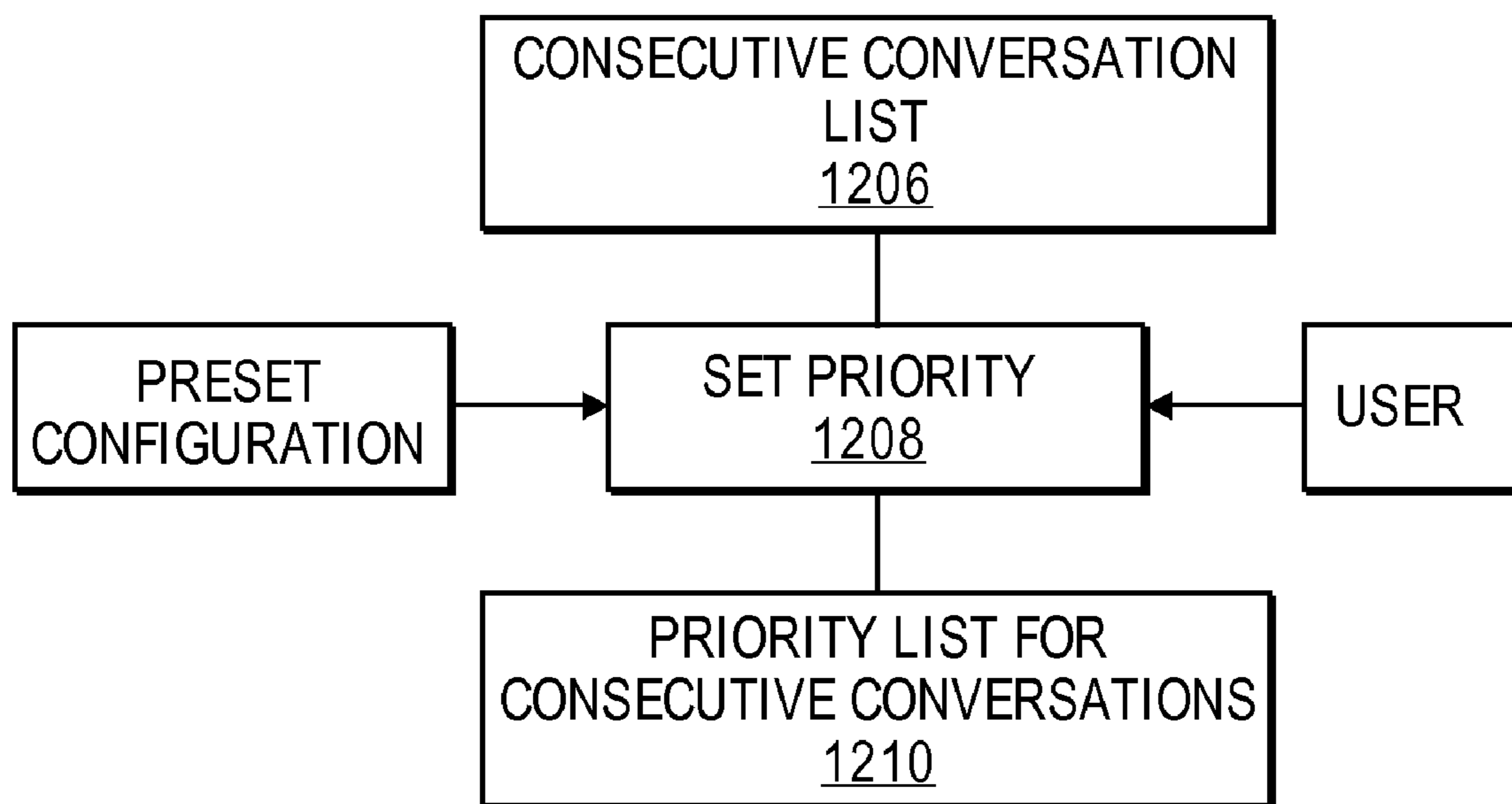
**FIG. 11E**



**FIG. 11F**



**FIG. 12A**



**FIG. 12B**



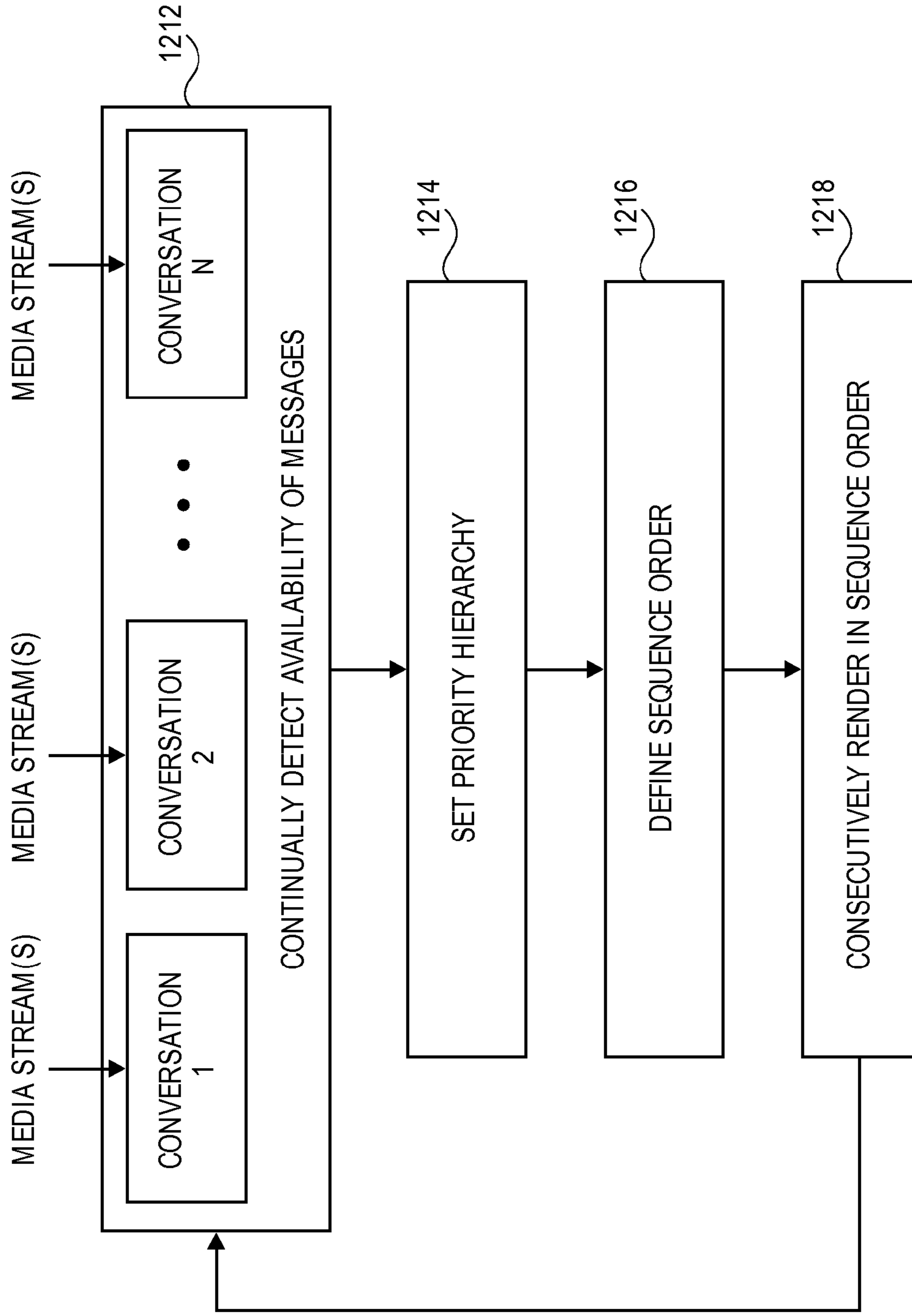
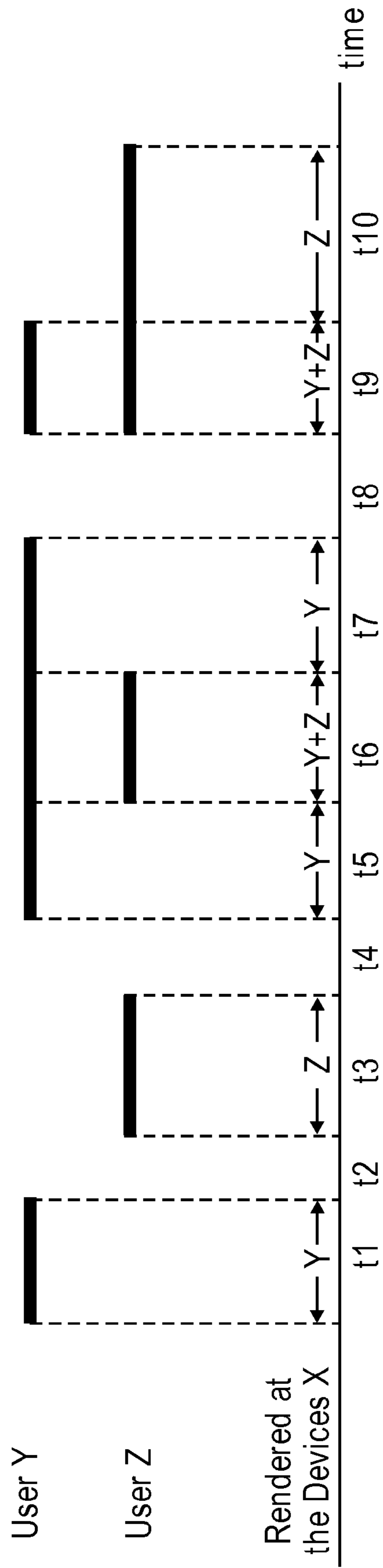


FIG. 12C

Conversation A



**FIG. 13A**

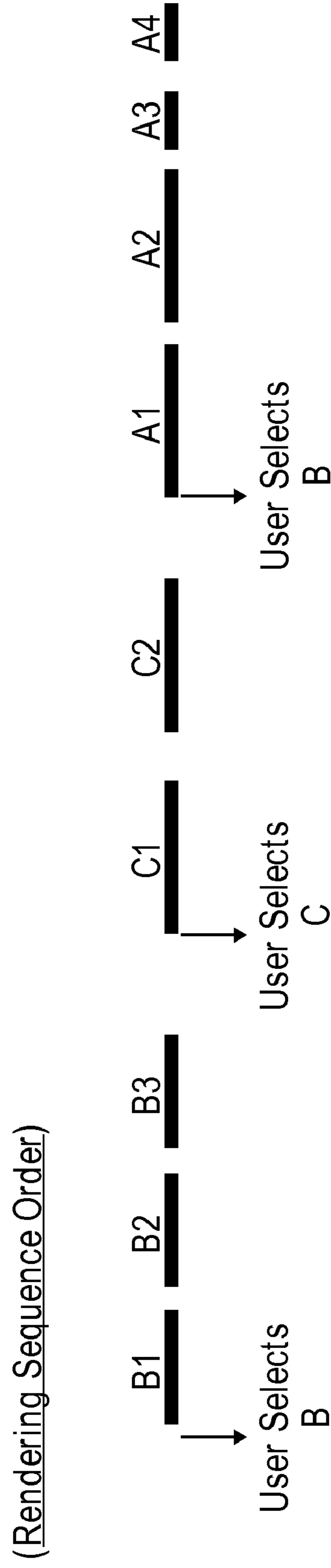
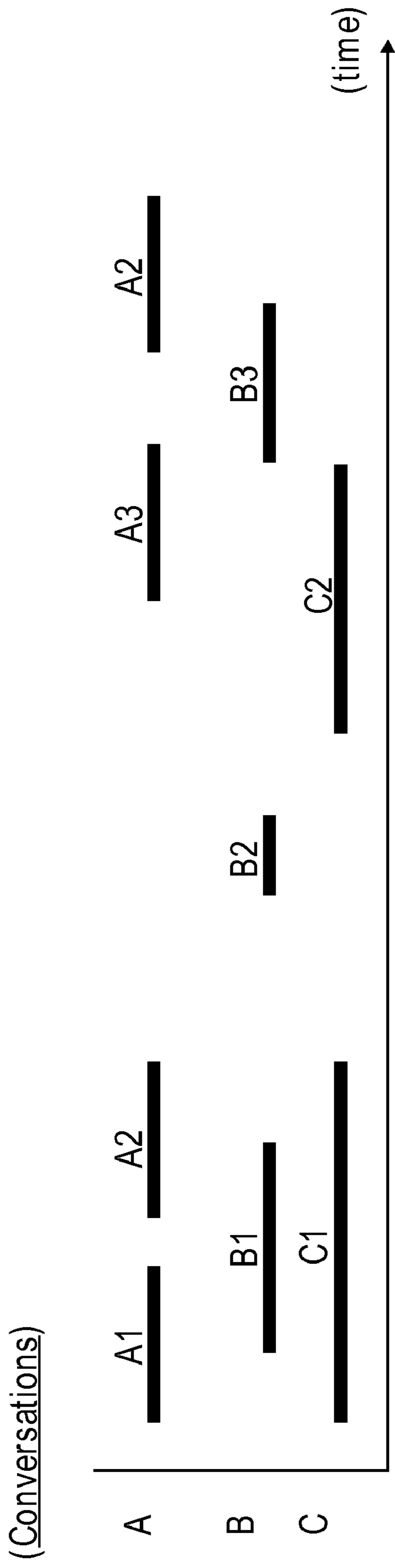
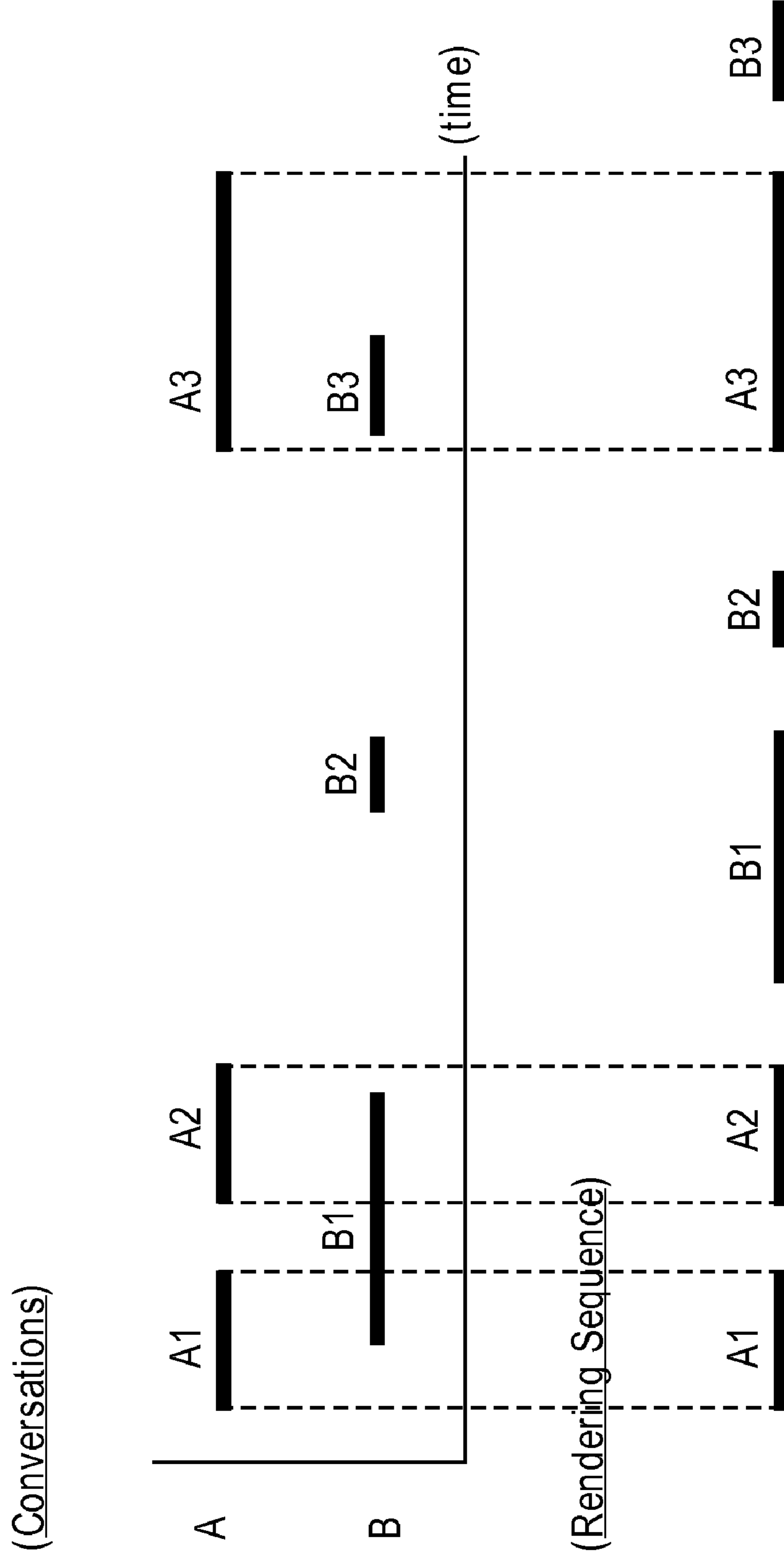


FIG. 13B

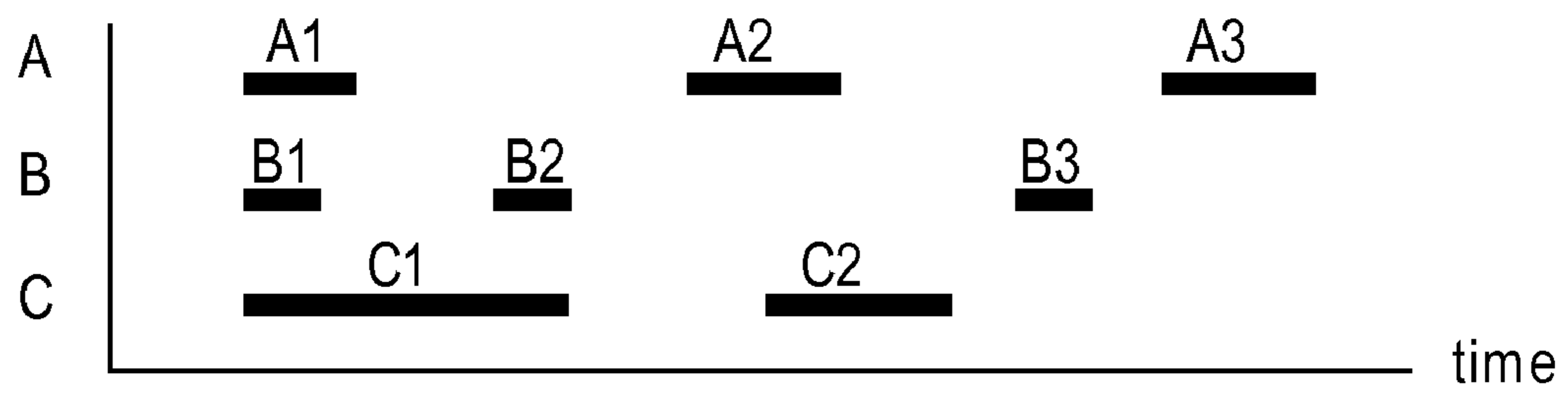
MCMS-C



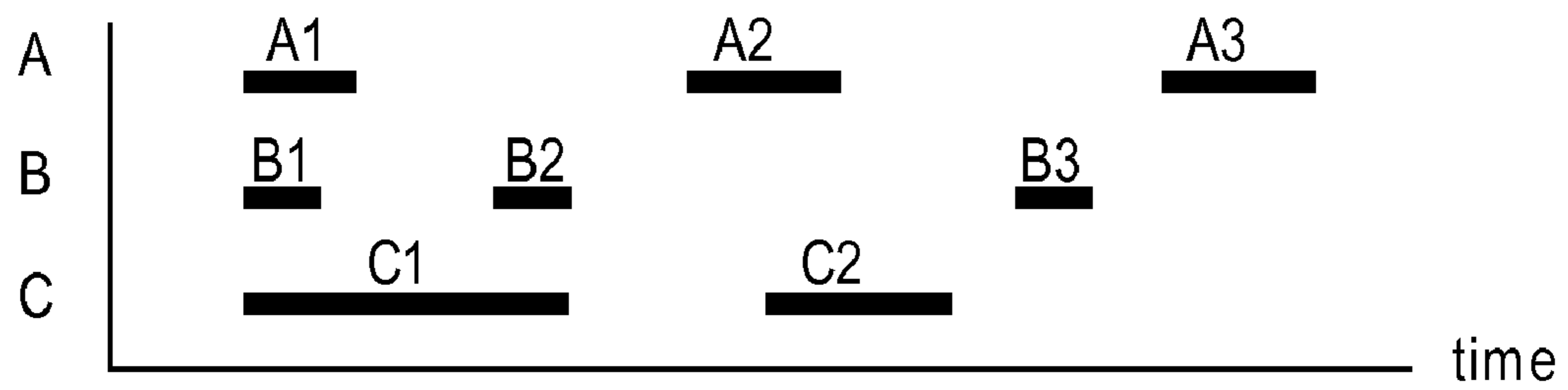
**FIG. 13C**

MCMS-S

Conversations

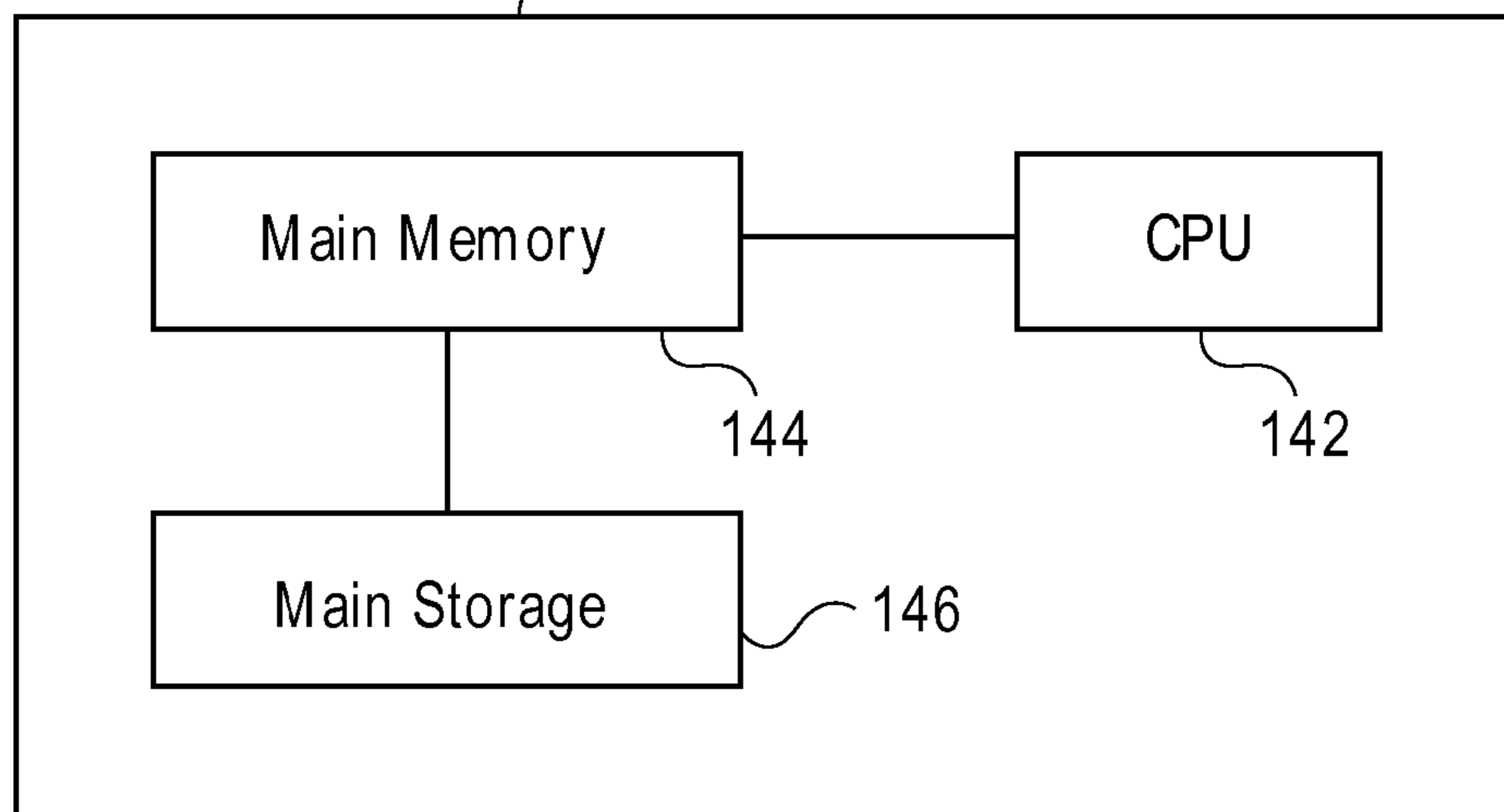


Rendering



**FIG. 13D**

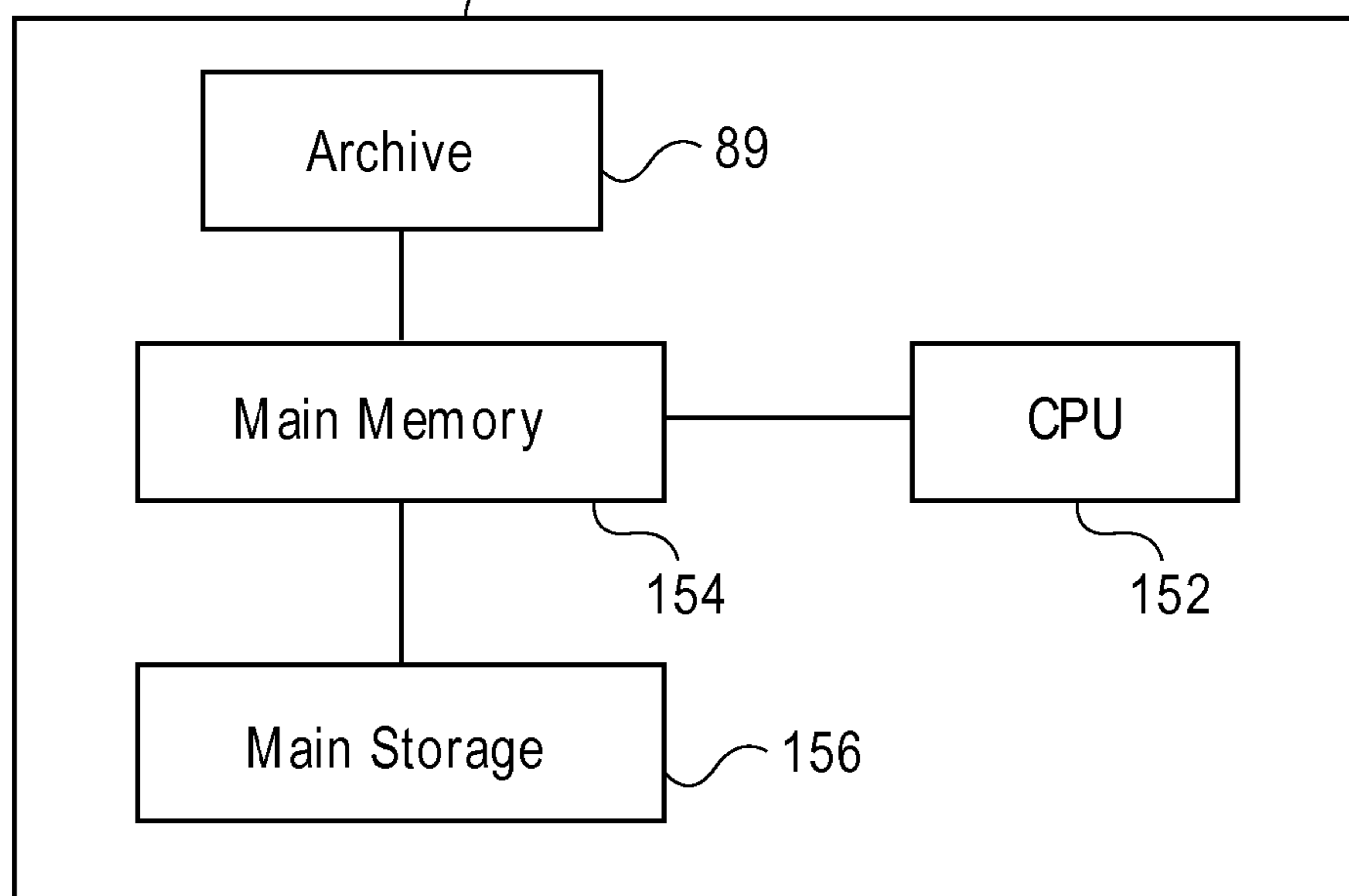
DEVICE 13 Running Client Application 12



140 ↗

**FIG. 14A**

SERVER 16 Running Server Application 78



150 ↗

**FIG. 14B**

## TELECOMMUNICATION AND MULTIMEDIA MANAGEMENT METHOD AND APPARATUS

### CROSS-REFERENCE TO RELATED APPLICATIONS

This application is a continuation of U.S. application Ser. No. 12/028,400, filed on Feb. 8, 2008 entitled “Telecommunication and Multimedia Management Method and Apparatus”, which claims the benefit of U.S. Provisional Patent Application No. 60/937,552, filed Jun. 28, 2007 entitled “Re-thinking Voice Communication” and U.S. Provisional Patent Application No. 60/999,619, filed on Oct. 19, 2007 entitled “Telecommunication and Multimedia Management System and Method”, all of which are incorporated herein by reference for all purposes.

### BACKGROUND

#### 1. Field of the Invention

This invention pertains to telecommunications, and more particularly, to a telecommunication and multimedia management method and apparatus that enables users to review the messages of conversations in either a live mode or a time-shifted mode and to transition the conversation back and forth between the two modes, participate in multiple conversations and to archive the messages of conversations for later review or processing.

#### 2. Description of Related Art

The current state of voice communications suffers from inertia. In spite of automated switching, high bandwidth networks and technologies such as satellites, fiber optics, Voice over IP (VoIP), wireless and cellular networks, there has been little change in how people use telephones. One is still required to pick up the phone, dial another party, wait for a connection to be made, and then engage in a full-duplex, synchronous conversation with the dialed party. If the recipient does not answer, no connection is made, and the conversation does not take place.

At best, a one-way asynchronous voice message may be left if the recipient has voice mail. The process of delivering the voice mail, however, is burdensome and time consuming. The caller is required to wait for the phone on the other end to stop ringing, transition into the voice mail system, listen to a voice message greeting, and then leave the message. Current voice mail systems are also inconvenient for the recipient. The recipient has to dial a code to access their voice mail, navigate through a series of prompts, listen to any earlier received voice messages in the queue, and then finally listen to the message of the sender.

Another drawback with typical voice mail systems is the inability to organize or permanently archive voice messages. With some voice mail systems, a user may save a message, but it is automatically deleted after a predetermined period of time and lost forever.

Yet another problem with current voice mail systems is that a connection must be made between the caller and the voice mail system before a message can be left. If no connection is made, there is no way for the caller to leave a message.

Current telephone systems are based on relatively simplistic usage patterns: real-time live calls or disjointed voice mail messages, which are typically deleted as they are heard. These forms of voice communications do not capture the real power that can be achieved with voice communication or take advantage of the advances of network speed and bandwidth that is now available. Also, if the phone network is down, or is inaccessible, (e.g., a cell phone user is in an area of no cov-

erage or the phone lines are down due to bad weather), no communication can take place.

In general, telephone based communications have not kept pace with the advances in text-based communications. Instant messaging, emailing, faxing, chat groups, and the ability to archive text messages, are all commonplace with text based communications. Other than voice mail, there are few existing tools available to manage and/or archive voice messages. In comparison, the tools currently available to manage telephone communications are primitive compared to text communications.

The corporate environment provides just one example of the weakness in current voice communication tools. There is currently no integrated way to manage voice communications across an organization as a corporate asset. Employees generally do not record or persistently store their phone conversations. Most business related voice communication assets are gone as quickly as the words are spoken, with no way to manage or store the content of those conversations in any manageable form.

As an illustrative example, consider a sales executive at a company. During the course of a busy day, the executive may make a number of calls, and close several sales, with customers over the phone. Without the ability to organize, store, and later retrieve these conversations, there is no way for the executive to resolve potential issues that may arise, such as recalling the terms of one deal versus another, or challenging a customer who disputes the terms of a previously agreed upon sale. If this executive had the ability to easily retrieve and review conversations, these types of issues could be easily and favorably resolved.

Current tactical radio systems, such as those used by the military, fire, police, paramedics, rescue teams, and first responders, also suffer from a number of deficiencies. Most tactical radio communication must occur through a “live” radio connection between the sender of a message and a recipient. If there is no radio connection between the two parties, there can be no communication. Urgent messages cannot be sent if either the sender or the receiver does not have access to their radio, or a radio circuit connection is not established. Tactical communications are therefore plagued with several basic problems. There is no way (i) to guarantee the delivery of messages, (ii) for a recipient to go back and listen to a message that was not heard in real time; (iii) to control the granularity of the participants in a conversation; (iv) for the system to cope when there is a lack of signal integrity for a live conversation. If a message is not heard live, it is missed. There are no tools for either the sender or a recipient to manage, prioritize, archive and later retrieve (i.e. time-shift) the messages of a conversation that were previously sent.

Yet another drawback with tactical radio communication systems is that only one message can be sent at a time per channel. Consider an example of a large building fire, where multiple teams of fire fighters, police and paramedics are simultaneously rescuing victims trapped in the building, fighting the fire, providing medical aid to victims, and controlling bystanders. If each of the teams is using the same channel, communications may become crowded and chaotic. Transmissions get “stepped on” when more than one person is transmitting at the same time. Also there is no way to differentiate between high and low priority messages. A team inside the burning building fighting the fire or rescuing trapped victims should have a higher priority over other teams, such as those controlling bystanders. If high priority messages are stepped on by lower priority messages, it could

not only hamper important communications, but could endanger the lives of the fire fighters and victims in the building.

One possible solution to the lack of ability to prioritize messages is to use multiple channels, where each team is assigned a different channel. This solution, however, creates its own set of problems. How does the fire chief determine which channel to listen too at any point in time? How do multiple teams communicate with one another if they are all on different channels? If one team calls for urgent help, how are other teams to know if they are listening to other channels? While multiple channels can alleviate some issues, it can also cause confusion, creating more problems than if a single channel is used.

The lack of management tools that effectively prioritize messages, that allow multiple conversations to take place at the same time, that enable the time-shifting of messages to guarantee delivery, or that support archiving and storing conversations for later retrieval and review, all contribute to the problems associated with tactical radios. In first responder situations, such as with the military, police, and fire, effective communication tools can literally mean the difference between life and death, or the success or failure of a mission. The above burning building example is useful in illustrating just some of the issues with current tactical radio communications. Similar problems exist with the military, police, first responders and others who use tactical communications.

With packet-based networks, commonly used protocols include Transmission Control Protocol (TCP) and User Datagram Protocol (UDP). UDP offers the advantage of fast delivery of data, but at the expense of completeness. Packets may be dropped in transit and not available when attempting to render the data as soon as possible at the destination. In spite of the shortcomings, UDP is the standard for Voice over Internet Protocol (VoIP) transmissions due to its speed attributes. On the other hand TCP does guarantee the delivery of perfect (i.e., an exact copy of the transmitted data) data, but at the expense of latency. All packets are delivered, regardless of how long it takes. This delay makes TCP impractical for use with “live” phone calls. Currently there are no known protocols that offer the performance advantages of both TCP and UDP, where “good enough” media can be transmitted for rendering as soon as possible, with the eventual delivery of a perfect copy of the media. Also there is no protocol that determines how much information should be sent over the network based on the presence of recipients on the network and their intentions to render the data either live or in a time-shifted mode. In addition, other factors commonly considered, such as network latency, network degradation, packet loss, packet damage, and general bandwidth conditions, are used in determining how much data to transmit. Prior art systems, however, do not consider the presence and intentions of recipients. As a result, the default assumption is that the data is rendered by the recipient in real time. When a recipient is not going to render data immediately, these prior art systems unnecessarily use bandwidth when it is not needed, degrading the overall performance of the network.

For the reasons recited above, telephone, voicemail and tactical voice communications systems are inadequate. An improved voice and media communication and management system and method, and improvements in delivering voice and other media over packet-based networks, is therefore needed.

#### SUMMARY OF THE INVENTION

The above-described problems are solved by a communication application, method and apparatus that supports new

modes of engaging in conversations and/or managing multiple conversations using a variety of media types, such as voice, video, text, location, sensor information, and other data. Users can engage in conversations by sending messages to designated recipients. Depending on preferences and priorities, the recipient(s) might participate in the conversation in real time, or they might simply be notified that the message is ready for retrieval. In the latter case, the recipient participates in the conversation in a time-shifted mode by reviewing and replying to the recorded message at their convenience.

Users are empowered to conduct communications in either: (i) a near-synchronous or “live” conversation, providing a user experience similar to a standard full duplex phone call; or (ii) in a series of back and forth time-delayed transmissions (i.e., time-shifted mode). Further, users engaged in a conversation can seamlessly transition from the live mode to the time-shifted mode and back again. This attribute also makes it possible for users to engage in multiple conversations, at the same time, by prioritizing and shifting between the two modes for each conversation. Two individuals using the system can therefore send recorded voice messages back and forth to each other and review the messages when convenient, or the messages can be sent at a rate where they essentially merge into a live, synchronous voice conversation. This new form of communication, for the purposes of the present application, is referred to as “Voxing”

When you “Vox” someone, the conversation consists of a series of discrete recorded messages, which are recorded in a number of locations, which may include the encoding device of the sender, (e.g. a phone or computer), servers on multiple transmission hops across the network, and the receiver’s rendering device. Unlike a standard phone call or voice mail, the system provides the following features and advantages: (i) the conversation can transition between live and time-shifted or vice versa; (ii) the discrete messages of the conversation are semantically threaded together and archived; (iii) since the messages are recorded and are available for later retrieval, attention can be temporarily diverted from the conversation and then the conversation can be later reviewed when convenient; (iv) the conversation can be paused for seconds, minutes, hours, or even days, and can be picked up again where left off; (v) one can rejoin a conversation in progress and rapidly review missed messages and catch up to the current message (i.e., the live message); (vi) no dedicated circuit is needed for the conversation to take place, as required with conventional phone calls; and (vii) lastly, to initiate a conversation, one can simply begin transmitting to an individual or a group. If the person or persons on the other end notice that they are receiving a message, they have the option of reviewing and conducting a conversation in real time, or reviewing at a later time of their choice.

The communication media management system also supports new modes of optimizing the transmission of data over a network. The system actively manages the delivery of payloads to a recipient engaged in a conversation in real time when network conditions are less than ideal. For example when network conditions are poor, the system intentionally reduces the quality of the data for transmission to the point where it is “good enough” to be rendered upon receipt by the recipient, allowing the real time participation of the conversation. The system also guarantees the eventual delivery of an “exact” copy of the messages over time. The system and method therefore provides the advantages of both speed and accuracy. The utilization of network bandwidth is optimized by making tradeoffs between timeliness and media quality, using the presence and intentions of whether or not recipient(s) intend to review to the message immediately in



real time, as well as measures of network latency, network degradation, packet loss or damage, and/or current bandwidth conditions.

It should be noted that the messages of conversations may contain voice only or voice, video and other data, such as sensor information. When the messages are reviewed, they are listened to or visually reviewed, or a combination thereof, depending on the type of media contained in the messages. Although as of the filing of the present application, most conversations are voice only, it is intended that the communication system and method described herein broadly includes conversations including multiple media types, such as voice and video for example.

#### BRIEF DESCRIPTION OF THE DRAWINGS

The invention may best be understood by reference to the following description taken in conjunction with the accompanying drawings, which illustrate specific embodiments of the invention.

FIG. 1 is a diagram of the architecture of the communication and media management system of the invention.

FIGS. 2A and 2B illustrate a block diagram of a Client running on a Device in the communication and management system of the invention.

FIG. 3 is a block diagram of a Server used in the communication and media management system of the invention.

FIGS. 4A through 4D illustrate various embodiments of data payloads used in the communication and management system of the invention.

FIG. 5 is a diagram illustrating data being transmitted over a shared IP network in accordance with the invention.

FIG. 6 is a diagram illustrating data being transmitted over a circuit based network in accordance with the invention.

FIG. 7 is a diagram illustrating data being transmitted across both a cellular network and the Internet in accordance with the invention.

FIGS. 8A through 8F are a series of flow diagrams illustrating a store and stream function of the communication and management system of the invention.

FIGS. 9A through 9C are flow diagrams illustrating the operation of a Payload Quality Manager (PQM) and FIGS. 9D through 9F are flow diagrams illustrating the Data Quality manager (DQM), both used by the Clients and Servers of the invention.

FIG. 10 is an exemplary device having a graphical user interface that may be used with the system of the invention.

FIGS. 11A through 11F are diagrams illustrating multiple conversation management (MCMS) features of the invention.

FIGS. 12A through 12C are diagrams illustrating the multiple conversation management system—consecutive (MCMS-C) features of the invention.

FIGS. 13A through 13D illustrate a series of diagrams detailing the operation of the invention.

FIGS. 14A and 14B are block diagrams that illustrate the hardware used for running the Client and Server applications of the invention.

It should be noted that like reference numbers refer to like elements in the figures.

#### DETAILED DESCRIPTION OF SPECIFIC EMBODIMENTS

The invention will now be described in detail with reference to various embodiments thereof as illustrated in the accompanying drawings. In the following description, specific details are set forth in order to provide a thorough under-

standing of the invention. It will be apparent, however, to one skilled in the art, that the invention may be practiced without using some of the implementation details set forth herein. It should also be understood that well known operations have not been described in detail in order to not unnecessarily obscure the invention.

#### A. Functional Overview

An improved voice and other media communication application, method and apparatus is disclosed which provides one or more of the following features and functions:

- i. enabling users to participate in multiple conversation types, including live phone calls, conference calls, voice messaging, consecutive or simultaneous communications;
- ii. enabling users to review the messages of conversations in either a live mode or a time-shifted mode (voice messaging);
- iii. enabling users to seamlessly transition a conversation between a synchronous “live” mode and a time shifted mode;
- iv. enabling users to participate in conversations without waiting for a connection to be established with another participant or the network. This attribute allows users to begin conversations, participate in conversations, and review previously received time-shifted messages of conversations even when there is no network available, when the network is of poor quality, or other participants are unavailable;
- v. enabling the system to save media payload data at the sender and, after network transmission, saving the media payload data at all receivers;
- vi. enabling the system to organize messages by threading them sequentially into semantically meaningful conversations in which each message can be identified and tied to a given participant in a given conversation;
- vii. enabling users to manage each conversation with a set of user controlled functions, such as reviewing “live”, pausing or time shifting the conversation until it is convenient to review, replaying in a variety of modes (e.g., playing faster, catching up to live, jump to the head of the conversation) and methods for managing conversations (archiving, tagging, searching, and retrieving from archives);
- viii. enabling the system to manage and share presence data with all conversation participants, including online status, intentions with respect to reviewing any given message in either the live or time-shifted mode, current attention to messages, rendering methods, and network conditions between the sender and receiver;
- ix. enabling users to manage multiple conversations at the same time, where either (a) one conversation is current and all others are paused; (b) multiple conversations are rendered consecutively, such as but not limited to tactical communications; or (c) multiple conversations are active and simultaneously rendered, such as in a stock exchange or trading floor environment.
- x. enabling users to store all conversations, and if desired, persistently archive them in a tangible medium, providing an asset that can be organized indexed, searched, transcribed, translated and/or reviewed as needed;
- xi. enabling the system to provide real time call functionality using a best-efforts mode of message delivery at a rate “good enough” for rendering as soon as possible (similar to UDP), and the guaranteed eventual delivery of exact copies of the messages as transmitted by

requesting retransmission of any missing or defective data from the originally saved perfect copy (similar to TCP); and

- xii. enabling the system to optimize the utilization of network bandwidth by making tradeoffs between timeliness and media quality, using the presence and intentions of the recipient(s) (i.e., to either review the media in real-time or in a time-shifted mode), as well as measures of network latency, network degradation, packet loss or damage, and/or current bandwidth conditions.

In various embodiments, some or all of the numerous features and functions listed above may be implemented. It should be understood, however, that different embodiments of the invention need not incorporate all of the above listed features and functions.

## B. Glossary

Prior to explaining the details of the invention, it is useful to define some of the terms and acronyms used throughout the written description. This glossary of terms is organized into groups of System Components, Media, Media Management, People and Conversation Management.

### B.1. System Components

**Client:** A Client is the user application in the communication system, which includes a user interface, persistent data storage, and “Voxing” functionality. Users interact with the Client application, and the Client application manages all communications (messages and signals) and payload (Media) transfers that are transmitted or received over a network. The Client supports encoding of media (e.g., the capturing of voice, video, or other data content) and the rendering of media and supports security, encryption and authentication as well as the optimization of the transmission of data across the network. A Client may be used by one or multiple Users (i.e., multi-tenant).

**Device:** A physical device that runs the Client application. A User may be actively logged into a single Device or multiple Devices at any given point of time. In various embodiments, a Device may be a general-purpose computer, a portable computing device, a programmable phone, a programmable radio, or any other programmable communication device.

**Servers:** A computer node on the communication network. Servers are responsible for routing Messages sent back and forth between Users over the network and the persistent storage and archiving of Media payloads. Servers provide routing, transcoding, security, encryption and authentication and the optimization of the transmission of data across the network.

### B.2. Media

**Message:** An individual unit of communication from one User to another. Each Message consists of some sort of Media, such as voice or video. Each Message is assigned certain attributes, including: (i) the User sending the message; (ii) the Conversation it belongs to; (iii) an optional or user created Importance Tag; (iv) a time stamp; and (v) the Media payload.

**Media:** Audio, video, text, position, sensor readings such as temperature, or other data.

**Conversation:** A thread of Messages (identified, persistently stored, grouped, and prioritized) between two or more Users on their Devices. Users generally participate in a Conversation using their Devices by either Reviewing Messages in real time or in a time-shifted mode, or creating and sending Messages of a Conversation as desired. When new Messages

are created, they either define a new Conversation, or they are added to an existing Conversation.

**Head of a Conversation:** The most recent Message of a conversation that has been encoded by the most recent speaker. It is where a User is positioned in a Conversation when reviewing “live” or where one jumps to if the “Jump To Live” feature is used.

**Multiple Conversation Management System or MCMS:** An application that runs as part of a Client application, which enables a User to engage in multiple Conversations using a variety of Media types. With the MCMS application, a User selects one Conversation among the multiple Conversations as current, where only the Messages of current conversation are rendered. For the selected current Conversation, the User may transition from a series of back and forth Messages in time-shifted mode to near-synchronous “live” mode, similar to a standard telephone conversation, and back again. The Messages of the non-selected Conversations are in a paused state. Messages associated with the non-selected Conversation will accumulate if others are still participating in those Conversations. The User may selectively transition the current Conversation among the multiple Conversations and Review the accumulated Messages of the selected current Conversation.

**Multiple Conversation Management System-Consecutive or MCMS-C:** Similar to MCMS, with the added feature of rendering and enabling Users to manage and participate in multiple Conversations consecutively through a hierarchical system of Priorities and time-shifting, which are automatically managed by the system. The MCMS-C application allows the Messages of consecutive Conversations to be rendered in a prioritized order, as opposed to MCMS where only the Messages of the currently selected Conversation are rendered. MCMS-C is particularly applicable in situations where it is important that the Messages of the consecutive Conversations are rendered, in the prioritized order, and/or the receipt of all Messages, even those belonging to lower priority Conversations, is more important than receiving the Messages in real-time. Examples of situations where MCMS-C may be suitable include, but are not limited to, hospitals, taxi fleet management, or tactical communications.

**Multiple Conversation Management System-Simultaneous or MCMS-S:** Similar to MCMS, with the added feature of enabling With MCMS-S, multiple Conversations are selected for simultaneous rendering, as opposed to MCMS where the Messages of only the selected current Conversation are rendered. The MCMS-S application is particularly applicable in situations where a User is listening to multiple Conversations at the same time, such as a trader listening to multiple brokers on different exchanges and periodically sending trading requests to one or multiple of them simultaneously. MCMS-S may also be suitable for tactical communications as well.

**Priority:** The mechanism through which the system determines which Message to render next when a User is participating in MCMS-C. Priority is automatically managed by the system. A User can set default Priorities, or a predetermined set of system Priorities may be used. In the event of a conflict, where more than one Message is ready to be rendered at the same time, the system resolves the conflict at least partly based on Priority, to determine what Message to render immediately and what Message to time shift.

**Tags:** a set of attributes a User or the system may assign to a Conversation or a message, such as a topic (a company name), a directive (“action items”), an indicator (“conversation summary”), or any other label by which one might want to search or organize the data.

Importance Tags: A special Message attribute that enables a sender to specify when a Message is to be rendered, regardless of other Priority settings. An “urgent” Importance tag will override other Priorities for example. This feature is critical for tactical systems, though any system can be configured to use or disable this feature.

Packet: Any unit of binary data capable of being routed through a computer network. Each packet consists of header (meta data) and payload (media data). Includes standard packet protocols such as, but not limited to, Internet Protocol (IP), EvDO, UMTS or any other packet-based network, either radio, fiber optic, or wired.

Header or Packet Header: The portion of a packet that describes the packet; the meta data concerning the payload, its encoding type and destination.

Vox packet: A proprietary packet that enables the system and method to further refine and optimize the delivery of Messages, Media and other signaling information.

Media Payload (or Payload): The actual Media portion of a Packet.

### B.3. Media Management

Time Shift Delay (TSD): The amount of time between the arrival of a Vox Packet and the rendering of the Packet on a Device. The TSD must exceed the Minimum Time Shift Delay. The TSD is typically determined by the User’s behavior in choosing to review the Messages of a Conversation some time after receipt.

Minimum Time Shift Delay (MTSD): The time shift delay enforced by the Client to allow for jitter processing using jitter buffer techniques. This causes the system to delay rendering until an adequate number of the packets have arrived to create a usable media stream. The system will typically adaptively adjust the MTSD over time to compensate for variable conditions in the network.

Rendering: Delivering a Media stream to a User in a form suitable for User consumption (e.g., voice, text, graphic display, video, or a combination thereof).

Mixing: The Rendering of one or more Media streams. For example, the Media stream from two Participants of a Conversation may be Mixed when Rendered, creating a User experience similar to a conversation where multiple people are speaking at the same time.

Encoding: The process of translating Media either created by a User (such as voice or video) or otherwise originating on a Device (such as GPS or other sensor data), and converting the media into digital data to be processed by a Client.

Adaptive Jitter Buffer: Jitter buffers or de-jitter buffers are used to counter jitter (i.e., either the arrival of out of sequence packets or the delayed arrival of packets) introduced by packet switched networks, so that the continuous rendering of audio (or video) signals transmitted over a network can be performed without disruption. The data is stored in a buffer before Rendering to allow a reasonably sized buffer of Media to arrive. The Media may be rendered before all the Packets are received, trading off quality for currency. An Adaptive Jitter Buffer is capable of dynamically changing its size to optimize the delay/quality tradeoff.

Persistent Infinite Message Buffer (PIMB): The PIMB is a storage management system for the storage of time-based Media that performs both the de-jittering of “live” data and the storage and retrieval of archive data. The PIMB further includes the additional attributes of potentially infinite and persistence storage of Media. The PIMB maintains “exact” or full copies of Vox Packets of a Message and Conversations at some or all Participant Devices and/or Servers.

Packet Loss Compensation or Concealment (PLC): During Rendering of a Media stream, the PLC component com-

pensates for missing Packets, interpolating the results to present the stream to a reviewer. Missing Packets may be rendered as silence, or information from adjacent Packets may be used to present an interpolated sound or image. The particular method to be used will be dependent on the media, Codecs in use, and other generally known parameters.

### B.4. People

User: A person who is authorized to use the system.

Contact: A record of either a User or non-user of the system. Users typically engage in Conversations with members on their list of Contacts. A non-user is a user that accesses or uses the system using a legacy phone, radio or other non-Client 12 enabled device.

Group: The association of multiple Contacts. Contacts may be selectively added or deleted from a Group. When a Conversation takes place among a Group, all the members of the Group may or may not participate.

Channel: Typically used for tactical communication systems. A Channel is similar to a Group in that it associates multiple Contacts with the Channel.

Participant: A person who is identified as a member of a Conversation. Could be a User or a non-User participant.

### B.5. Conversation Management

Time Shifting: Time shifting is the ability to play any Message at any time after it has been received as determined by the User-recipient. By Time-Shifting, a User may Review a Message: (i) immediately on demand by Rendering immediately after the MTSD; or (ii) time-shifted in a mode of reviewing the Message upon the discretion of the User; (iii) from the archive for searching, reconstructions, etc. of old Conversations; (iv) after a delayed period of time to accommodate the Reviewing of other higher Priority Messages (or Conversations) that need to reviewed first; (v) and/or repeatedly if necessary for the Message to be reheard and understood. In other words, Time Shifting is the ability of a user to render a Message at any time after the system imposed MTSD.

Reviewing: Listening, viewing, reading or otherwise observing the Media content in Messages. Reviewing may take place in either a near synchronous real-time “live mode” or the time-shifted mode.

Intention: Either (i) a User-defined attribute capturing whether the User wants to Review the Messages of a Conversation either as soon as possible or Review the Messages in a time-shifted mode; (ii) implied by a User’s behavior; or a combination of (i) and (ii).

Attention: A user attribute capturing whether the User is Reviewing the Messages of a given Conversation at the moment.

Catch Up To Live (CTL): A rendering mode that allows a User, who is not at the Head of a Conversation, to Review previous Messages more quickly to “Catch Up To Live” (i.e., the Head of the Conversation). The CTL feature may use any of a number of catch up techniques, such as the faster replay of Messages, the removal of gaps in the Media of the Messages, removal of hesitation particles, etc. When the User has caught up to live, the system seamlessly flows into the live Conversation. This is a very useful feature with conference calls, for example, in situations where a User needs to temporarily shift their attention away from the Conversation, but wishes to hear the entire Conversation upon their return.

Catch Up Mode: A user-configured or pre-configured mode that determines how the CTL process will catch-up (i.e., replay faster, remove silence, and hesitation particles, or a combination thereof).

Jump To Live (JTL): This feature allows a user to jump from their current position to the Head of a Conversation. A

## 11

user will typically use the JTL feature when they do not want to Review all of the Messages between their current position in the Conversation and the Head. When the JTL feature is implemented, the user skips over any intervening Messages and starts Rendering the “live” Messages at the head of the Conversation.

MCMS Participant Attributes: A set of attributes, either defined by a User, interpreted by the system from the User’s behaviors, assigned by an administrator, or a combination thereof, which define the Intention, Attention, Priority, and rendering preferences of a receiver for a given Conversation. The attributes include, but are not limited to: (i) the Intention of when a receiver would like to render to the Messages of the Conversation. Possible Intention values include: “now”, “time-shifted”, “Catch Up To Live” (CTL), “paused”, and “never”; (ii) Catch Up Mode, which is a configuration setting which determines how the CTL process should catch the receiver up to live (e.g., play faster, skip silence gaps or hesitations, or play at normal speed); (iii) Time Shift Delay (TSD), which defines how far the receiver’s current position in the conversation is from the Head of the Conversation, and (iv) the Priority of the Message with regard to the receiver’s other Conversations.

## C. System Architecture

Referring to FIG. 1, a block diagram of the telecommunication and media management system according to one embodiment of the invention is shown. The system 10 includes a plurality of Clients 12<sub>1</sub> through 12<sub>n</sub>, running on Devices 13<sub>1</sub> through 13<sub>n</sub>, respectively. The Devices 13 communicate with one another over a communication services network 14, including one or more Servers 16. One or more networks 18<sub>1</sub> through 18<sub>n</sub>, is provided to couple the plurality of Devices 13<sub>1</sub> through 13<sub>n</sub>, to the communication services network 14. In various embodiments, the networks 18 may be the Public Switched Telephone Network (PSTN), a cellular network based on CDMA or GSM for example, the Internet, a tactical radio network, or any other communication network, or a combination thereof. The communication services network 14 is a network layer on top of or otherwise in communication with the various networks 18<sub>1</sub> through 18<sub>n</sub>. In various embodiments, the network layer 14 is either heterogeneous or homogeneous. Clients 12<sub>1</sub> through 12<sub>n</sub> communicate with one another and with Servers 16 over the networks 18<sub>1</sub> through 18<sub>n</sub> and network 14 using individual message units referred to as “Vox packets”, which are described in detail below.

## D. Client Architecture

Referring to FIGS. 2A and 2B, a block diagram of a Client 12 running on a Device 13 is illustrated. As illustrated in FIG. 2A, the Client 12 includes Multiple Conversation Management System (MCMS) application 20, a rendering and encoding module 21, and an MCMS applications database 22. As illustrated in FIG. 2B, the Client 12 further includes a Store and Stream (SAS) module 24 with a Persistent Infinite Message Buffer (PIMB) reader 26, a PIMB writer 28, PIMB database 30, a data and network quality (DNQS) store 32, and Media driver and encoder hardware 34. The MCMS application 20 and the Store and Stream module 24 communicate with one another through message handling modules 25a and 25b respectively. The Client 12 further includes an authentication-encryption-security module 40 and a communication protocol module 44.

## 12

The module 40 provides authentication, encryption and security services during the transmission and receipt of “Vox” packets to and from the Client 12. The communication protocol module 44 encapsulates Vox packets into the native packets used by the underlying network 18 connected to the Device 13 running the Client 12 when transmitting data and de-encapsulating Vox packets from the native packets when receiving data. With the modules 40 and 44, multi-party end-to-end authentication, encryption and security is provided between Clients 12. Messages are authenticated, encrypted and secured across the networks 18<sub>1</sub> through 18<sub>n</sub>, and network 14, from a first sending Device 13 to second receiving Device 13.

## D.1.1. The MCMS Database

The database 22 stores and manages the persistent meta data for a number of entities in the system 10, including Contacts and Participants, Conversations and Messages (live and stored), and default Priorities, and information regarding the Servers 16. In addition, the MCMS database 22 stores the moment-to-moment operational data of a User’s Conversations, presence, and status, as well as that of all the Participants conversing with the User or on the User’s Contact list. For example, with regard to Conversations and Messages, the database 22 keeps track of status information, such as what Messages of a Conversation a User has or has not Reviewed, Priorities, and Catch Up To Live status for each Conversation in which the Client 12 is a Participant, the presence and status of all Participants, and other network and other system management data.

## D.1.2. The MCMS Application

MCMS application 20 supports the different Voxing modes of engaging in conversations and/or managing multiple conversations using a variety of media and data types (voice, video, text, location, data, etc.). Users engage in Conversations by sending Messages to designated recipients using their Client 12 enabled Devices 13. Depending on preferences and Priorities, the recipient might Review the Message in real time, or they might simply be notified that the Message is ready for Reviewing. Users can transition from a series of back and forth Messages, which are Reviewed in a time-shifted (or voice messaging) mode or in a near synchronous, full duplex conversation (similar to standard “live” phone calls) and then back to voice messaging again. The MCMS application 20 allows a User to control their interactions with their most important Conversations in real-time without missing any Messages in other ongoing Conversations. For example, the MCMS application 20 notifies a User of urgent or high priority communications from a Conversation that they are not currently Reviewing. MCMS application 20 also enables all Messages from all Conversations to be stored for later retrieval so they can be reviewed at any time.

In accordance with various embodiments, there are several different operational modes of the MCMS application 20, including MCMS-Consecutive (MCMS-C) and MCMS-Simultaneous (MCMS-S), which support the consecutive and simultaneous rendering of Messages respectively. Each of these embodiments is described in more detail below. Unless specifically specified, the term “MCMS” is intended to generally mean the MCMS application 20, which includes the aforementioned different modes.

The MCMS application 20 is a multi-tiered architecture that includes a number of modules and services. The modules and services include the MCMS Database Module 20a, the SAS Services Module 20b, the Messaging and Signaling Services Module 20c, the User Interface Application Programming Interface (API) 20d, the User Interface Module 20e, the Conversations/Messages Management Services 20f,

the Priorities Services **20g**, the Contacts Service **20h**, the Presence/Status Services **20i**, and the Messages/Signals Services **20j**.

#### D.1.2.1 The MCMS Database Module

The MCMS database module **20a** is a service module that manages all function calls necessary for the MCMS application **20** to access the MCMS database **22**.

#### D.1.2.2 The SAS Services Module

The SAS Services module **20b** includes a set of function calls that enable communication and coordination between the MCMS application **20** and the Store and Stream module **24**, and which are passed back and forth through the message handling modules **25a** and **25b** respectively. The set of function calls enable both the MCMS application **20** and the Store and Stream module **24** to operate as necessary to implement the various Voxing functions when invoked by Users and/or as dictated by network conditions. Some of the functionality performed by the SAS Services module **20b** includes maintaining and communicating the status of Message transmissions and Message acknowledgments, the instructions for rendering of Messages, and the status and presence of Users.

#### D.1.2.3 The Messaging and Signaling Services Module

The Messaging and Signaling Services module **20c** runs on both Clients **12** and Servers **16** and enables communication between the Client **12** and the Servers **16** of the system **10**. This communication, which includes messages, data and other signals, allows the Client **12** and the system **10** to track and administer communications, network status, Users, and User status. Types of messages and signals sent between the Message and Signaling Services modules **20c** running on the Clients **12** and the Servers **16** include, for example, network availability of Users, tracking of Messages that the Server **16** has sent to the Client **12** (possibly including a “high watermark”) to determine if an entire message or some portion of a message is missing, (e.g., a sequence number per Participant per Conversation created by the “generating” Client), whether a user is speaking or Reviewing Messages of a given Conversation, where a User is with respect to the Head of a Conversation, or when a Participant is no longer Reviewing a Conversation live. These are examples a few of the many types of messages and signals sent between the Message and Signaling Services modules on the Clients **12** and Servers **16** and in no way should be construed as limiting the invention.

#### D.1.2.4 The User Interface API

The User Interface API **20d** is a module that defines a set of function calls that define the programming interface between the User Interface module **20e** and the underlying services of the MCMS application **20**. The User Interface API **20d** supports general-purpose methods such as UI application support, and all function calls necessary for a User Interface to operate the MCMS Application **20**. In various embodiments, the User Interface API **20d** enables the Client **12** to support a wide variety of user interfaces and device types, such as Adobe Flash-based and/or Microsoft Windows applications, cellular or mobile phone devices, PSTN devices driven with tones, a voice user interface (VUI), and physical radio communication interfaces. In various embodiments, the User Interface API module **20d** enables the design of both highly flexible and highly constrained user interfaces to support the functionality of the MCMS application **20**.

#### D.1.2.5 The MCMS User Interface Module

The MCMS User Interface module **20e** supports the operation and functions of the audio and video user interface of the Client **12**. The User Interface module **20e** supports a host of user interactions and can be implemented with various interaction mediums, such as, an array of graphical user interface screens, an Audio/DTMF interface, or voice user interface on

the Device **13**, all of which enable a User to interface with the system **10**. A partial list of User interactions that are supported include, for example, functions to: log-in; manage, join, and monitor Conversations; control Conversation rendering; manage Priorities; and requests to review archived Conversations. It should be noted that this list is exemplary and in no way should be construed as limiting the invention.

#### D.1.2.6 Conversation/Message Management Services

The Conversation/Message management services **20f** is a module which defines a set of functions that manage the data structures and processes responsible for managing and retaining all information needed for the User to manage the receipt and Review of transmitted and received Media (e.g., voice or video content Messages) between the participants of a Conversation. The Messages are organized into Conversations. Media that is sent or received by the Device **13** running the application **12** is available for immediate Review while being received. The received Media is also recorded for Review in a time-shifted mode, Conversation management, and archival purposes. In an alternative embodiment, Messages or Conversations can be optionally marked for transience, specifying their desired retention requirements (e.g., some Messages will not be retained or stored beyond the requirements for immediate rendering). In yet another embodiment, Media can be optionally marked for review in a time-shifted mode only and cannot be reviewed immediately upon receipt.

The Conversation/Message management services **20f** further enables, for each current or ongoing Conversation of the User, the sending of Media to a receiving Client **12** at any time, and the receiving Client **12** seamlessly associates these Messages with the appropriate Conversation, regardless of the actions or inaction of the receiver.

With the Conversation/Message management services **20f**, all Conversations are essentially asynchronous. If two Users are actively engaged in a given Conversation and the User controlled delay between transmissions is minimal, the experience will be one of a synchronous full duplex conversation, as with current telephone or VoIP conversations. If either User delays their participation, for whatever reason, the Conversation drifts towards an asynchronous voice (or other Media) messaging experience. In alternative embodiments, Conversations can be optionally Tagged as asynchronous Messages only or synchronous Messages only. In either of these cases, the Conversation cannot drift between the two modes, unless the Tag is reset. After the Tag is reset, the Conversation again may flow between near synchronous (i.e. live or real-time) and asynchronous (i.e., time-shifted or voice messaging) modes.

The Conversation/Message management service **20f** processes the transmission and receipt of Messages in a progressive fashion. When transmitting, Media may be created while Messages are simultaneously encoded, stored and transmitted. In other words, the transmission of Messages may occur simultaneously with the generation of Media by the User (i.e., while speaking into their Device **13** or generating video). On the receiving side, the receipt, storage, and Rendering of Messages also all occur progressively. Messages do not need to be completely received before they can be Rendered. The Rendering of Messages may occur at the same time Messages are being delivered, right up to the MTSD. Further, the service **20f** is also capable of the simultaneous transmission of outgoing Messages and Rendering of incoming Messages. The progressive nature of the service **20f** allows a User to be engaged in a live Conversation while storing and streaming the media of the Conversation for later retrieval and review as well other functions described herein.

The time-shifting of Messages by the Conversation/Message management services **20f** allows a User to “Catch Up To Live” on a Conversation if they missed earlier Messages or were involved in another Conversation. This time-shifting process eliminates the need for Users to broadcast a request to their entire Group or Channel to have Messages repeated. Older Messages may be replayed at any time at potentially higher speeds to save time. Users may easily skip forward and backward through their Messages and within individual Messages. The Reviewing process may be configured on a Message-Priority basis to potentially skip lower priority Messages.

In one embodiment, the Conversation/Message management service **20f** also identifies Messages by a specific Participant (speaker) and, by default, mixes Messages of a Conversation that were delivered at the same time (MCMS-S). In an optional embodiment, a User could Review the transmissions of different Participant speakers of a Conversation separately.

The Conversation/Message management module **20f** further allows Conversation sharing among Participants, who can be added to an active or archived Conversation. In one embodiment, an added Participant to a Conversation is provided access to the Conversation and has the ability to retrieve the previous Messages of the Conversation for Review. In an alternative embodiment, the added Participant is provided access to the Messages of the Conversation only from the point where the new Participant joined, and not any previous Messages of the Conversation.

The Conversation/Message management module **20f** is also responsible for managing the functions used to control all rendering tasks performed by the Store and Stream module **24**. These tasks include rendering Media (i.e., voice, video, etc.) appropriately for the Device **13** running application **12**. These rendering tasks include, but are not limited to, the rendering of Mixed Messages (i.e., overlapping messages), as well as rendering according to user-defined criteria, such as playing faster, catching up to live, removing silence, removing hesitation particles, frequency shifting, and the ability to apply independent gain control to individual senders in a multi-party conversation.

#### D.1.2.7 Priority Services

The Priority service **20g** is a module that defines a set of functions that manage the data structures and processes responsible for managing and retaining all information needed for a User to manage the Priority of the consecutive Conversations (i.e., MCMS-C) in which the User is engaged. When a User participates in a number of consecutive live Conversations, the User is required to prioritize the Conversations. Issues arise when Messages of different Conversations are ready to be rendered at the same time. An algorithm is used to determine the order in which the Messages are rendered that considers the availability of Messages to be rendered and the Priorities set by the User. The algorithm determines that the available Messages with the highest priority are rendered first while any concurrently available Messages are time shifted automatically just enough to allow for the rendering of the higher priority Message. As rendering time becomes available, the system will automatically render the time-shifted messages according to the User’s Priorities.

#### D.1.2.8 Contacts Services

The Contacts services **20h** is a module that defines a set of functions that manage the data structures and processes responsible for managing and retaining all information needed for authenticating and associating one or more Contacts with Conversations. When sending a Message as part of

a Conversation that is associated with a number of Contacts, all of the Contacts receive the Message.

#### D.1.2.9 Presence/Status Services

The Presence/Status services **20i** is a module that defines a set of functions that maintain the data structures and processes responsible for managing and sharing presence and status information between certain Users and/or non-users of the system. In various embodiments, the presence and status information is maintained for all User and non-users engaged in the Conversations the User of the Client **12** is engaged in, all Users and non-users in the Contacts list, or Users within a predefined domain (e.g., the members of a corporation or other organization). These examples are merely illustrative and should not be construed as limiting. The Presence/Status services **20i** module may manage and share presence and status information on any defined set of Users and/or non-users.

The Presence/Status service **20i** enables Users to monitor the status of other User’s Intentions, Attention, and their Time Shift delay on any given Conversation (i.e., how far back they are from Reviewing the Messages of the Conversation live). In one embodiment, privacy controls are provided concerning availability of Presence and Status data. The Presence/Status module **20i** further controls the data that enables the system **10** to deliver Messages that match the behavior and Intentions of Users. For example, a User may indicate their Status by designating an Intention to either Review or not Review a Conversation live. In response, the Presence/Status services **20i** issues commands that cause the rendering of Messages either “live” or time-shifted, in accordance with the Intention of the User. In addition, the Intentions of Users are shared with the other Participants of the Conversation. The service **20i** is also capable of inferring other Status values from the User’s behaviors. The Presence and Status information is also used to optimize network traffic and bandwidth, as described in more detail below.

#### D.1.2.10 Messages/Signals Services

The Messages/Signals services **20j** is a module that defines a set of functions that manage the data structures and processes responsible for messaging and signaling Users of the system **10**, using special messages or audible tones. The special messages or tones may include for example an indication if a Message or Messages are live or time-shifted, whom the Message(s) are from, Priority, and other factors. The Message/Signal service **20j** further has the ability to (i) signal the presence or absence of Users on the network, as well as the ability to notify if one or more Users are no longer actively Reviewing the Messages of a Conversation; (ii) “ring” or otherwise notify another User to get their attention when they are paying attention to another Conversation or not paying attention to their Device **13** at all; (iii) leave a Message for Users currently not on the network **18** to immediately review the Message the next time the individual re-connects to the network **18**; (iv) generate an audible or visible feedback that alerts the sender that a sent Message was not received by recipient(s), generate a confirmation when the Message has been received by the recipient(s), and/or a confirmation indicating when the Message has been Listened to by the recipient(s); and (v) implement a Priority scheme where individuals on a Conference or tactical call may be notified that their attention is immediately needed on the call. This indication may convey multiple levels of urgency and an acknowledgement of some kind by the recipient.

#### D.1.2.11 Rendering and Encoding

The rendering and encoding module **21** is responsible for performing all rendering tasks for the MCMS application **20**.

These tasks include rendering Media appropriately for the device **13** running application **12**.

#### D.2 The Store and Stream Module

The Store and Stream module **24** supports a number of functions and performance attributes, which are described below.

With the Store and Stream module **24**, Message transmission is essentially “full-duplex”, enabling any party to send a Message at any time, even while another party is also sending a Message, or if the other party is unavailable or otherwise engaged. The Store and Stream module is able to render messages as in a live PSTN or VoIP call or deliver them for time shifted messaging modes. It is able to optimize transmission and control Rendering according to the desires of the User.

The Store and Stream module **24** maintains connectivity with all target recipients (e.g., Servers **16** or other Devices **13**) on the underlying network **18**, manages all message, signal, and media transmissions, and optimizes the delivery speed and bandwidth usage across the network **18** to meet a User’s immediate performance requirements, while managing network quality and capacity. The module **24** adapts and optimizes Media delivery commensurate with the quality and capacity of the underlying network **18**. When insufficient underlying network resources are available, the quality of the transmitted Media streams can be degraded. As bandwidth becomes available, the quality of the transmitted Media streams may be increased. In addition to tradeoffs of Media quality, the Store and Stream functionality can make tradeoffs in the amount of Media transmitted in each packet based on Users’ intentions to render data in real time as described below.

By dynamically controlling the delivery rate of Media based on the conditions of the underlying network **18**, the Store and Stream module **24** is optimized to deliver time-sensitive Media that is “good enough” to Render upon receipt, and the guarantee eventual delivery of exact or full copies of the Media for archival purposes through a background process of requesting retransmission of missing, low quality, or damaged packets. As long as sufficient network resources exist to meet minimum Media quality levels, this retransmission does not impede the Rendering of live call Media. The Clients **12** of the system **10** are thus designed to bridge the performance gap between the delivery of an exact or complete copy of the Media at the expense of substantial potential latency versus the quick delivery of Media, but with no guarantees of completeness. In the context of this application, the term “good enough” means that the quality of the Media is sufficient so that when it is rendered, it is intelligible. The notion of “good enough” is therefore subjective and should not be construed in absolute terms. For example, the quality level of certain Media to be good enough may vary depending on the type of Media, circumstances, and other factors.

The Store and Stream module **24** further persistently stores all Media created by or otherwise originating using a Device **13** or received over the network **18** from other Device **13** and/or users. There are several significant advantages of storing this Media on the Device **13** running the Client **12**: (i) it enables Users to leave a Message for another party, even when the sender and/or the recipient has either unavailable or poor network connectivity. In the case of insufficient bandwidth, the Message will be transmitted as fast as available bandwidth can be effectively used. In the case of no connectivity, the Message is queued for transmission as soon as network connectivity becomes available, resulting in a time-shifted delivery; (ii) the User has the ability to pause, replay, fast-forward, and Catch-Up-To-Live with an ongoing Conversation, as well

as retrieve and review the archived Messages of previous Conversations; and (iii) it enables the optimization of data payloads over the system **10** and improves system resilience against network bandwidth and connectivity problems that may occur from time to time.

The Store and Stream module **24** is also responsible for: Mixing Messages as appropriate to create overlapping Messages (generated by the normal overlap of speakers in a Conversation or background noise), simulating an actual Conversation where multiple parties are speaking; rendering transcriptions or translations of audio media; adjusting the rendering of Media according to a number of User-defined criteria including playing faster, removing silence gaps between spoken words, removing hesitation particles, and frequency shifting; and the ability to apply independent gain control to individual senders in a multi-party Conversation; as well as other potential Rendering options.

The Store and Stream module **24** manages control and informational messaging between itself and MCMS.

#### D.2.1 The Persistent Infinite Message Buffer (PIMB)

The Persistent Infinite Message Buffer or PIMB **30** is a set of indexed (i.e., time-stamped and sequentially numbered) Media payload data structures and a system for their storage and retrieval. In one embodiment, the data in the PIMB **30** is arbitrarily persistent, meaning it is available virtually forever or at least until the system runs out of storage. Various retention rates and strategies may be employed to make effective use of storage resources. Many possible implementations exist for the physical storage implementation of the PIMB **30**, including, but not limited to: RAM, Flash memory, hard drives, optical media, or some combination thereof. The PIMB **30** is also “infinite” in size, meaning the amount of data that can be stored in the PIMB **30** is not inherently limited. This lack of limit is in comparison to existing jitter buffer technology that discards data as soon as it is rendered. In one specific embodiment, the PIMB **30** may be implemented using a small and relatively fast RAM cache memory coupled with a hard drive for persistent storage. As the physical storage capacity of the PIMB **30** is exceeded, the data is maintained on the Server **16** (as described below) for later retrieval on demand. User criteria or a replacement algorithm, such as least-recently-used, or first-in-last-out, is used to control the actual data stored in the PIMB **30** and the data that is maintained on the Server **16** or archived at any point in time. The PIMB **30** further provides the attributes of file system storage and the random access attributes of a database. Any number of Conversations, regardless of their duration or the number of Messages in each, may be stored and later retrieved for Review. In addition, the meta data associated with the Messages of a Conversation, such as its originator and its length, may be also stored in the PIMB **30**. In alternative embodiments, the indexed Media payloads and other data can be stored for a designated period of time (e.g. 30 days). Once the age of the media exceeds the designated period, the payloads and data are discarded. In another embodiment, payloads can be discarded based on the sender and/or the recipient of the Message containing the payload, or the topic of the Conversation or Messages associated with the payload. In yet other embodiments, payloads and data may be marked for transience, meaning the Messages will not be stored in the PIMB **30** beyond the requirements for immediate Rendering.

#### D.2.2 The Data and Network Quality Store

The data and network quality store (DNQS) **32** is a data store for storing information regarding Media payloads and Vox packets that are either read from or written to the PIMB **30**.

### D.2.3 The PIMB Writer

The PIMB writer **28** writes data to the PIMB **30** for two basic purposes. The PIMB writer **28** writes data from a Media capturing device (e.g., a microphone or camera) on the Device **13** running the Client **12** (“Encode Receive”). The PIMB writer **28** also writes data received over the network **18** from other Clients **12** into the PIMB **30** (“Net Receive”).

#### D.2.3.1 Encode Receive

For capturing Media from the Device **13**, the PIMB writer **28** includes Encoder Receiver **28a** and a Data Storer **28c**. When a User speaks into the microphone or generates video images with the Device **13** for example, the hardware **34** receives the raw audio and/or video signals and provides them to the Encoder Receiver **28a**, which encodes the signals into indexed media payloads (hereafter sometimes simply referred to as “payload” or “payloads”). The Data Store **28c** stores the payloads into the PIMB **30**. Other types of Media, such as sensor data is converted into payloads in a similar manner.

#### D.2.3.2 Net Receive

For storing Media received over the network **18** into the PIMB **30**, the Net Receive function of PIMB writer **28** includes a Network Receiver **28d**, a Data Bufferer **28e**, a Data Storer **28f**, a Data Quality Manager **28g**, and a Network Quality Manager **28h**. The Network Receiver **28d** receives Vox packets over the network **18**. The Data Bufferer **28e** places the received Vox packets into their proper sequence and prevents the Rendering of the incoming Vox packets for at least the Minimum Time Shift Delay (MTSD) delay. The Data Storer **28f** transforms the packets into indexed media payloads and stores the indexed media payloads in the PIMB **30**. As the payloads are stored, the Data Quality Manager (DQM) **28g** notes any missing or defective packets. If packets are missing or defective, the DQM **28g** schedules a request for retransmission over the network **18**. The sending device replies by resending the missing or defective packets. Eventually these packets are converted into indexed media payloads and stored in the PIMB **30**. By retrieving the missing or defective packets, an “exact” copy of a sender’s Message is eventually stored in the PIMB **30**. The retransmission of missing and/or defective packets does not delay the rendering of Messages in real time, provided that the packets that have been delivered are of “good enough” quality and quantity. Retransmission requests may be delayed by the DQM **28g** if insufficient network resources are available to support both the new “live” data as well as the retransmission.

### D.2.4 The PIMB Reader

The PIMB reader **26** reads data from the PIMB **30** for two basic purposes. The PIMB reader **26** accesses the PIMB **30** when data is to be rendered (“Render”) for the local Client **12**. Data is also read from the PIMB **30** when data is to be transmitted (“Transmit”) by the Client **12** over the network **18**.

#### D.2.4.1 Render

For the rendering of messages on the Client **12**, the PIMB reader **26** includes a Data Prioritizer **26a**, a Data Retriever **26b**, a Packet Loss Compensation/Interpolator (“PLC/Interpolator”) **26c**, a Data Mixer **26d** and a Data Renderer **26e**. The Prioritizer **26a** prioritizes the data to be rendered by building an ordered queue of messages that could potentially be Rendered. It uses User configured Priority for the rendering of consecutive Conversations (MCMS-C). In addition, the Data Prioritizer uses the availability of media data to render within the limits imposed by the MTSD, the User’s current Attention, and the User’s defined and implied Intentions. The Data Retriever **26b** retrieves the prioritized indexed media payloads from the PIMB **30**. The PLC/Interpolator **26c** performs

packet loss compensation and interpolation on the retrieved payloads, using known packet loss compensation and interpolation algorithms. The particular method to be used is dependent on the media Codecs in use, and other well-known parameters. The Mixer **26d** is used to appropriately mix concurrent data streams from multiple Messages of a single Conversation together. For example, if two or more Participants of a Conversation are speaking at the same time, the Mixer **26d** mixes the Messages, creating the effect of both Participants speaking at the same time. In an alternative embodiment, the User has the option of Reviewing the multiple streams from one Participant at a time. If only one Participant in the Conversation is speaking, the Mixer **26d** may simply pass the single Message stream, without performing any mixing. The Renderer **26e** takes the data from the Mixer module **26d** and converts it into a form suitable for the hardware driver **34**. The hardware **34** then drives either the speaker or video display of the Device **13**, depending on the type of Media, creating voice, video or some other audible and/or visible notifier on the Device **13**.

#### D.2.4.2 Transmit

To prepare messages for transmission from the Client **12** over a network **18**, the PIMB reader **26** includes a Data Prioritizer **26f**, a Packet Quality Manager (PQM) **26g**, a Data Retriever **26h**, Packetizer **26i**, a Transmitter **26j** and an Acknowledger **26k**. The Data Prioritizer **26f** prioritizes the Messages for transmission over the network **18**. Priority is determined using the MCMS Participant Attributes related to payloads available for transmission, network connectivity and bandwidth conditions, and the Intentions of Users beyond the next hop to either Render live or time-shifted, and, in some embodiments, possible optimizations of transmission bundling where multiple packets to any given next network hop are available. The prioritized packets are then optimized, using the PQM **26g**, which assures the timely delivery of “good enough” data quality for live Messages, while minimizing real-time bandwidth, as described in more detail below. The Data Retriever **26h** retrieves the appropriate payloads from the PIMB **30**. The Packetizer **26i** assembles the payloads into Vox Packets, which are then transmitted by the Transmitter module **26j** over the network **18**. When the recipient receives the Vox packets, an acknowledgement is sent back to Acknowledger **26k** over the network **18** for notifying the sending User that a Message has arrived at its destination.

### D.2.5 The Packet Quality Manager

The PQM **26g** has several optimization goals: (i) the timely delivery of an adequate copy of time-sensitive Media (“as soon as possible to be good enough” for Rendering); (ii) the efficient use of available bandwidth, meaning using the optimal transmission frequency, payload quality, and packet size for the underlying network; and (iii) the ability to dynamically adjust or make changes in the transmission frequency, payload content, payload quality, packet size, etc. as network conditions change.

### D.2.6 The Network Quality Manager

On the receiving side of a network transmission is the Network Quality Manager **28h** (NQM). The NQM is responsible for observing specific properties of network performance for each sender that has sent media to the Client **12**, comparing expectations of jitter, loss, and throughput to their actual values. This is used to compute a Network Quality Rating (NQR) for every sender. This NQR is used to indicate sender availability and Conversation live-ness to the User of the receiving device.

### D.2.7 The Data Quality Manager

The Data Quality Manager **28g** measures the quality of the data being received over the network by observing packet



loss, jitter, and throughput. The DQM **28g** uses these measurements for three purposes: (i) to send receipt reports back to the sender; (ii) optionally using those receipt reports to request retransmission of certain data; and (iii) making these measurements available to the NQM **28h**.

#### E. Server Architecture

Referring to FIG. **3**, a block diagram of the application **78** that runs on the Server(s) **16**. The application **78** is similar to the Client application **12** in many regards and includes an MCMS server application **80**, an MCMS database **82**, a store and stream module **84**, a PIMB **85**, a data and network quality store (DNQS) **86**, MCMS-SAS message handling modules **87a** and **87b** which manage messages and signals back and forth between the MCMS server application **80** and Store and Stream module **84**, an archive/retriever **88**, and an archive **89**. The application **78** further includes an authentication-encryption-security module **40** and a communication protocol module **44**.

The MCMS server application **80** is a multi-tiered architecture including a MCMS Database Module **20a**, a Store and Stream (SAS) Module **20b**, a Messaging/Signaling Module **20c**, Conversations/Messages management services **20f**, Priority services **20g**, Contacts (including User and Authentication) services **20h**, Presence/Status service **20i**, and Messages/Signals services **20**. The aforementioned modules and services of the application **78** are similar or the same as the modules and services having like reference numerals as the Client **12**, and therefore are not described in detail herein, except for one notable exception. In various embodiments, the MCMS server application **80** and Store and Stream module **84**, including the MCMS database **82**, is configured to support many Users in one instance of the application. The one instance may be further configured to support multiple domains, where each domain is defined as a group of Users (i.e., a corporation or other group of Users belonging to a common organization). This architecture allows each application **78** on Server **16** to serve multiple users (or domains), where each user (or domain) is not visible to other Users. This partitioning is referred to as “multi-tenancy”.

The server Store and Stream **84** module performs the functions of Net Receive and Transmit. For the Net Receive function, the module **84** includes a Net Receiver **28d**, Data Bufferer **28e**, a Data Storer **28f**, a Data Quality Manager (DQM) **28g**, and a Network Quality Manager **28h**. For Transmit functions, the module **84** includes a Data Prioritizer **26f**, Packet Optimizer **26g**, Data Retriever **26h**, Packetizer **26i**, Transmitter **26j** and an Acknowledger **26k**. The aforementioned elements of the Store and Stream module **84** are similar or the same elements having like reference numerals as the Client **12**, and therefore are not described in detail herein.

Since the Server **16** does not directly interact with Users, the encoding and rendering functions provided in the Store and Stream module **24** of the Clients **12** need not be present. The MCMS application **80**, when running on Servers **16**, does not interact directly with Users. Consequently, the user interface and user interface API modules and services **20e** and **20d** are not needed.

The application **78** on each Server **16** potentially serves multiple tenants, meaning it serves multiple Users of the system **10**. The PIMB **85** of the server application **78** is therefore significantly larger and is used to store the media payloads of multiple Users, as opposed to the PIMB **30**, which is used to store just the generated or received payloads of only a single User. The main purpose of the Store and Stream module **84** is to receive Messages transmitted by the

Clients **12** and transmit Messages to other Clients **12**. As Messages are received, they are stored in the PIMB **85** and transmitted to the next Server **16** (i.e., the net “hop”) of the network layer **14** along the path to the intended recipient(s), or to the recipient(s) directly depending on the system configuration. The archive-retriever **88** is responsible for archiving the media payloads stored in the PIMB **85** in archive **89**. As the physical space in the PIMB **85** is exhausted, media payloads in the PIMB **85** are moved to the archive **89**, which is a mass storage device. In various embodiments, the payloads stored in the PIMB **85** may be archived in accordance with User defined criteria and/or any known replacement algorithm, such as first-in-first-out (FIFO) or least recently used (LRU). It should be noted that only a single Server **16** is illustrated in FIG. **1** for simplicity. It should be understood that in actual embodiments, multiple servers or a “server farm” may be used for a network with a large number of Users.

The terms “persistent” and “infinite” used to describe the PIMB **30** and the PIMB **85** should not be construed literally as absolute terms. A User may wish to indefinitely store some Messages that are considered important. In other situations, such as a casual chat between two friends, the Messages may be deleted after a certain period of time to save space. According to various embodiments of the invention, different retention policies may be used, either set by the system **10** or configured by the User. The use of the word “infinite” refers to the lack of any preset time boundaries enforced by the PIMB. This is contrasted with current jitter buffer systems, which discard media after it has been rendered. The terms persistent and infinite should therefore be broadly construed to mean that the PIMB **30** and PIMB **85** have no internal limitations on the time ranges and quantities of Messages that can be stored therein.

There are a number of advantages to archiving the Messages of Conversations in a persistent storage medium. Voice messages and other Media can be organized, indexed, searched, transcribed, translated, and Reviewed as needed. Voice, as well as other Media, therefore becomes an asset that can be managed both by Users and organizations. These Media assets have value to corporations, first responders, police and fire departments, as well as the military.

#### F. The Vox Protocol and Indexed Media Payloads

As noted above, the Vox protocol is used by the Store and Stream module **24** to support all facets of payload transmission, storage, and optimization. The Vox packet is a structured message format designed for encapsulation inside a transport packet or transport packets of the underlying technology of the network **18**. This arrangement significantly improves the flexibility of the system **10**. By embedding the Vox packets into existing transport packets, as opposed to defining a new transport layer for “Voxing” applications, the system **10** takes advantage of current packet based communication networks running over the existing telecommunications infrastructure. A new network infrastructure for handling the Vox packets therefore need not be created to take advantage of all the benefits of the system and method described herein.

Referring to FIG. **4A**, the general format structure of a Vox packet **95** is illustrated. The format of the Vox packet **95** includes fields for type, sub-type, length, and payload. The different types of Vox packets include authentication, signaling, media payload, media multiplex (one message), and media multiplex (multiple messages). The sub-type field is used to designate different types of authentication, signaling or media type messages. Possible sub-types for authentica-

tion Messages include those necessary for key exchanges and Authentication. Possible sub-types for signaling Messages include registration, routing, message set-up, and network management. Possible sub-types for Media messages include different Codec styles and different payload aggregation techniques. The length field defines the overall length or size of the payload. The payload field contains the actual payload or media of the packet **95**.

Referring to FIG. 4B, a diagram illustrating a Vox packet **95** encapsulated in an exemplary protocol used by the network **18** is shown. In this example, the Vox packet **95** is embedded in underlying UDP, IP and Ethernet transport packets **96** respectively. In this manner, the Vox packet **95** can be transported across underlying UDP, IP and Ethernet layers of the network **18**. This is a standard protocol encapsulation technique used by packet networks.

Referring to FIG. 4C, a diagram illustrating a media multiplex Vox packet **95** encapsulated in UDP, IP, and Ethernet **97** is illustrated. In this example, the Vox packet **95** includes a Media type field, a Media sub-type field, a length field, a message ID field, a time stamp field, a sequence ID field, and a Media payload field.

Referring to FIG. 4D, the format of an indexed media payload **98** is illustrated. The indexed media payload includes a sub-type field, a length field, a message identifier (ID) field, a time-stamp field, a sequence identifier (ID) field, and field for the Media payload.

The encapsulation of Vox packets **95** into the transport packets of the underlying network allows the Media, Messages and Conversations to each be defined by a number of attributes.

When Media is created or otherwise originated on a Device **13**, it is typically time-based, meaning it changes in some meaningful way over time. As a person engages in a Conversation for example, their spoken words are strung together into sentences or statements, which vary over time, and the resulting data (streams and packets) will maintain the same variance over time. Similarly video (as opposed to a still photo) as well as GPS or other sensor data will vary over time. Regardless of the type or how it is originated, the Media is segmented and placed into the payloads of a plurality of Vox packets **95**. The packets are then continually, stored, transmitted, received, stored and rendered in streams (i.e., streaming media) at the transmitting and receiving Devices **13** respectively. Since each packet **95** is indexed, time-stamped, and given a sequence identifier, the individual packets can be segmented into Messages. By sequentially threading the individual Messages together, Conversations may be constructed.

One further unique aspect of the system **10** is that the media payloads generated by a Client **12** are stored in multiple locations. Not only are the payloads stored in the PIMB **30** of the generating Device **13**, but also in the PIMB **85** of the Server(s) **16** and the PIMB **30** of the receiving Devices **13**. This basic feature enables or makes possible much of the Voxing functionality described above and provides the system **10** with both resilience and operability, even when network conditions are poor or when a Participant of a Conversation is not connected to the network.

#### G. Interoperability With Underlying Telecommunication Protocols

The system **10** is intended to run or be layered over a variety of existing communication networks **18**, such as the Internet, fixed PSTN type circuit networks, and mobile or cellular phone networks, or a combination thereof. The system **10** is designed around the concept of moving many small

units of information (i.e., the Vox packets) between different Clients **12** and Servers **16** in the system **10**. While Vox packets may vary in size, depending on their function and payload, they all appear to be the same kind of data to the underlying network layer. In one embodiment, the system **10** has been designed and optimized for IPv4 networks such as the Internet, but other types of networks may be supported as well. For the purposes of this document, the term “IP” should be taken to mean IPv4, IPv6 or any other current or future implementation of the Internet Protocol.

Referring to FIG. 5, a diagram of a Client **12** running on Device **13** and communicating with a Server **16** over a shared IP network **100** is shown. As illustrated, the Client **12** is coupled to the shared IP network **100** through a first Internet service provider A and the Server **16** is coupled to the shared IP network **100** by a second Internet service provider B. During communication, the Vox packets **95** (designed “VP” in the figure) are encapsulated within UDP/IP packets and then interleaved among other IP protocol packets as is well known in the art and transmitted across the shared IP network **100** from the Client **12** to Server **16**, or vice versa. As is well known, each lower packet layer encapsulates the entire packet of the layer immediately above it. Packets can also be sent in a similar manner between two Servers **16**. Messages are sent from one Client **12** enabled Device **13** to another over a shared IP network **100**. At each hop, the Vox packets **95** are embedded in the underlying IP protocol and transmitted, until they reach the target destination.

The diagram of FIG. 5 is merely exemplary, showing only a single Client **12** and Server **16** connected to the network **100** for the sake of illustration. In actual embodiments of the system **10**, a large number of Clients **12** and one or more Servers **16** are typically connected to the shared IP network **100**. It is also useful to note that the Client **12** and Server **16** do not have exclusive use of the IP network **100**. In the example shown, an HTTP client, which is coupled to the network **100** through Internet provider A, can send packets back and forth with an HTTP server, coupled to the network **100** through a third Internet provider C. The system **10** does not control the manner in which the VPs embedded in the IP packets traverse the network **100**. Rather, all packets that traverse and share the network **100** do so in accordance with the standard procedures of the underlying shared IP network **100**.

Referring to FIG. 6, a “circuit” based network **104** such as a GSM mobile phone network is illustrated. The circuit network **104** is coupled between Client **12** running on Device **13** and Server **16**. Once a circuit is established between the Client **12** and Server **16**, the system **10** layers Vox packets (VP1, VP2, VP3, VP4, VP5, etc.) onto the underlying packets used by the network **104** and transmits them across the network **104**, creating “virtual Vox” circuit. The Vox Packets sequentially traverse the circuit network **104**, typically with spacing or framing data as is well known in the art for transmitting data over a circuit network. In addition, packet construction parameters, such as the payload size and the number of header fields included may be used to exploit the lack of per-packet overhead and to increase speed and/or efficiency of data transfer across the network **104**. It should be noted again that for the sake of simplicity, only a single Client **12** and Server **16** are shown connected to the network **104**. It should be understood, however, that additional circuits between Clients **12** and Servers **16** as well as other components may be established concurrently through the network **104**. The network **104** is therefore not dedicated for the transmission of Vox Packets, but rather may be shared with other types of network traffic.

Referring to FIG. 7, a diagram illustrating communication between a first Client **12A** enabled Device **13A** associated with a first network A and a second Client **12B** enabled Device **13B** associated with a second network B is illustrated. The networks A and B further each include gateway Servers **16A** and **16B** respectively. The Gateway Server pair **16A** and **16B** facilitate communication between the two networks A and B, allowing the Devices **13A** and **13B** to communicate with each other. In various embodiments, the networks A and B could each be any type of network. For example, each network A and/or B could be an IP network, a circuit type network, or a wireless or cellular network (i.e., CDMA, GSM, TDMA, etc.). The Servers **16** that straddle the two networks A and B are considered gateway servers because they route traffic or serve as a “gate” between the two networks.

With the system **10**, there are a several basic network interaction considerations to optimize system performance. These considerations include factors such as resolving the underlying address to which the Vox packets **95** are to be sent, the integrity of any sent Vox packets, and the management of the Maximum Transmission Unit (MTU) of a single Message that may be sent across a given network or combination of networks.

The address of a target Client **12** needs to be known so that the underlying network delivers the Vox packet **95** to the correct location. With IPv4 networks, the address is typically an IPv4 Address, which is a 32-bit number that uniquely identifies a host within the network. For other networking technologies, the address could be some other type of identifier. IP networks use the Domain Name System (DNS) to resolve human-readable names into IP addresses, and the Address Resolution Protocol (ARP) to resolve IP addresses into physical addresses. Regardless of the underlying networking technology, the system **10** uses one of the above-mentioned or other known addressing schemes for delivery of Vox packets **95** to the correct location.

As with almost any packet-based communication system, transmitted Vox packets might not be delivered to their addressed location if the underlying network is unable to deliver the packets in which the Vox packets are encapsulated. Most packet networks do not inform transmitters when packets are dropped. Instead they rely on the transmitters and receivers to notice and compensate for any dropped packets. The system **10** is designed to use these receiver receipt report messages to coordinate this packet loss management. If the underlying network is able to inform the sender of lost or dropped packets, the system **10** utilizes this information in its retransmission protocol.

The management of MTU is the determination of the Maximum Transmission Unit (i.e., the maximum size of a single message) that may be sent across a network. For packet-based networks, the underlying network imposes the MTU. For circuit-switched networks, the MTU may be a tunable parameter for network efficiency and performance. Thus in most cases, the underlying network imposes or determines the maximum size of the Vox packet **95** that may be transmitted efficiently. For example with IP networks, packets may be fragmented if the payload exceeds the MTU, but at a substantial performance penalty. With IP over Ethernet networks, the transmitting device has an MTU of 1518 bytes, as enforced by Ethernet. The largest IP packet must leave room for the Ethernet headers. The largest UDP packet must leave room for both IP and Ethernet headers and the largest Vox protocol that may be generated on Ethernet for example is the Ethernet MTU (**1518**)–IP header (**20**)–UDP header (**8**)=1490 bytes. Since the Vox protocol will have a header of its own, the actual Vox media payload will be less than 1490

bytes on an Ethernet network. For Gigabit Ethernet, the MTU could be much larger, but would be determined using a similar formula.

In a purely packet-based network, there are two potential values for MTU, the local link MTU and the path MTU. Determining the local link MTU yields the maximum size for Vox packets to be efficiently sent out to the local network interface. The path MTU yields the maximum size of Vox packet that may be sent intact all the way to the remote node. If a sender is connected via Ethernet, the Vox packet might pass through various other systems with smaller MTUs enroute to the recipient. The smallest MTU on the path to the destination needs to be resolved and known by the sender. In the IP world, there is a standard procedure for discovering the smallest MTU called “Path MTU Discovery”. For other kinds of networks, an equivalent procedure may be used. Again, since the system **10** is layered on top of other networks, any of the above MTU algorithms may be used.

## H. Operation Flow Diagrams

### H.1 Store and Stream

Referring to FIGS. **8A** through **8F**, a series of flow diagrams are provided to illustrate the operation of the store and stream module **24** and **84** on Clients **12** and Servers **16** respectively. FIG. **8A** shows the sequence of operation for a first Client **12<sub>1</sub>** transmitting Messages to a second Client **12<sub>2</sub>**. FIGS. **8B** and **8C** illustrate the operation of the PIMB writer **28** and PIMB Reader **28** on the transmitting Client **12<sub>1</sub>**. FIGS. **8D** and **8E** illustrate the operation of the PIMB Writer **28** and PIMB Reader **26** on the receiving Client **12<sub>2</sub>**. FIG. **8F** illustrates a flow diagram of the Store and Steam module **84** on a server **16**.

In FIG. **8A**, the User of Client **12<sub>1</sub>** running on a Device **13<sub>1</sub>** originates Media to be transmitted. The Media can be originated at the Device **13** in a number of different ways such the User creating Media by speaking into a microphone or creating video content on their Device **13**. Media is also originated by a Device **13** by receiving sensor data, such a GPS information or a temperature reading. Regardless of how the Media is originated, the Media is encoded by the PIMB Writer **28** (box **130**), which converts the Media into indexed media payloads and stores them in the PIMB **30** (box **132**) on Client **12<sub>1</sub>**. The PIMB Reader **26** on the Client **12<sub>1</sub>** reads the payloads out of the PIMB **30**, creates Vox packets, and transmits the packets to the receiving Client **12<sub>2</sub>** (box **134**) over the network **18**. Each Server **16** along the path between the sending Client **12<sub>1</sub>** and the receiving Client **12<sub>2</sub>** stores the transmitted payloads in the PIMB **85** and transmits the Vox packets to the next hop (box **133**). At the receiving Client **12<sub>2</sub>**, the net receive function of the PIMB Writer **28** converts the Vox packets into indexed media payloads (box **136**) and stores the payloads into the PIMB **30** of Client **12<sub>2</sub>** (box **138**). The rendering module of the PIMB reader **26** on Client **12<sub>2</sub>** renders the payload information read from the PIMB **30** into a medium suitable for human consumption, such as voice or video (box **140**). Each of these steps are described in more detail below with respect to FIGS. **10B** through **10E**.

In FIG. **8B**, a sequence of the Encode Receive function performed by the PIMB Writer **28** (step **130** of FIG. **8A**) is provided in detail. In the initial step **130<sub>1</sub>**, the User of the Device **13** running the Client **12<sub>1</sub>** originates the Media to be transmitted. As noted above, the Media may be derived by speaking into a microphone, using a camera, receiving sensor data, or by some other Media generating component. In the next step **130<sub>2</sub>**, the Encode Receiver **28a** encodes the Media

and creates the indexed media payloads (step 130<sub>3</sub>), which are then stored in the PIMB 30 (step 132) by the Data storer 28c.

In FIG. 8C, the sequence of the Transmit function performed by the PIMB Reader 26 (step 134 of FIG. 8A) on the sending client 12<sub>1</sub> is provided in detail. In decision loop 134<sub>1</sub>, the transmit function of the PIMB Reader 26 continuously checks to see if indexed media payloads that are to be transmitted have been written into the PIMB 30 and are available for transmission. If such payloads are available in the PIMB 30, the Data Prioritizer 26f prioritizes the payloads that should be sent first, using the MCMS Participant Attributes information, as illustrated in step 134<sub>2</sub>. Information about the highest priority payloads are passed to the Packet Optimizer module 26g which runs the PQM (step 134<sub>3</sub>), as described in more detail below with respect to FIGS. 9A-9C. The appropriate payloads are then retrieved from the PIMB 30 (step 134<sub>4</sub>) by the Data Retriever 26h and converted into Vox packets 95 by the Packetizer 26i (step 134<sub>5</sub>). The Vox packets 95 are then transmitted (step 134<sub>6</sub>) by the Transmitter 26j over the network 18 to the receive Client 12<sub>2</sub>, which sends back receipt reports reflecting the properties (loss, jitter, throughput) of the packets that have been received. These receipt reports provide the information necessary for the PQM to calculate the MABR for a given receiver. The aforementioned process is repeated for each transmission loop as indicated by the return arrow from the transmit step to the top of the flow chart.

In the embodiment described above, the media is encoded, stored in the PIMB 30 and then transmitted over the network in a serial fashion. In an alternative embodiment, the encoded media can be stored in the PIMB 30 and transmitted over the network in parallel, meaning the two functions occur substantially at the same time.

In FIG. 8D, the sequence for the Net Receive function (step 136 of FIG. 8A) of the PIMB Writer 28 on the receiving Client 12<sub>2</sub> is illustrated. In the initial step 136<sub>1</sub>, the network receiver 28d receives the Vox packets 95 over the network 18. The Data Storer 28f converts the packets into indexed media payloads (step 136<sub>3</sub>), which are stored in the PIMB 30 (step 136<sub>4</sub>). As the payloads are stored, the Data Quality Manager (DQM) 28g is run. The DQM 28g checks for missing or corrupted packets, ensures the eventual storage of an exact copy of the transmitted data, and the sends receipt reports regarding the conditions of the network to the transmitter. Each of these functions of the DQM 28g are described in more detail below with regard to FIGS. 9D through 9F.

In FIG. 8E, the sequence for the Render function of the PIMB Reader 26 (box 140 of FIG. 8A) on the receive Client 12<sub>2</sub> is illustrated. In the initial step 140<sub>1</sub>, the Data Prioritizer 26a prioritizes the indexed media payloads to be rendered as determined by the MCMS application 20 using the MTSD information as well as User status and presence information, including the User's Intentions and Attention status. The prioritized payloads are then read from the PIMB 30 (step 140<sub>2</sub>) by the Data Retriever 26b. The PLC/Interpolator 26c performs packet loss compensation and interpolation (step 140<sub>3</sub>) on the retrieved payloads, using known packet loss compensation and interpolation algorithms depending on which Codecs are used. In the next step, the Mixer 26d mixes (step 140<sub>4</sub>) multiple Messages of a Conversation if two or more Participants have generated Media at the same time within the same Conversation (e.g., both are speaking at the same time). The Renderer 26e renders (step 140<sub>5</sub>) the data stream from the Mixer 26d, generating sound, video, or other Media (step 140<sub>6</sub>) for the recipient User.

In FIG. 8F, the sequence for a Server 16 to receive Vox packets from the previous hop on the network 18, store, archive and transmit the Vox packets to the next hop is illustrated. In the initial step, the Server 16 performs the Net Receive function of the PIMB writer (similar to FIG. 8D) to store the indexed media payloads of the received data in the PIMB 85 and archive 89 or the Server 16. The server 16 also performs the Transmit function of the PIMB writer (similar to FIG. 8C) to forward the received packets onto the next hop on the network 18. In this manner, a copy of the media generated by the transmit Client 12<sub>1</sub> is received, stored and transmitted at each hop along the path to the receive Client 12<sub>2</sub>.

In the aforementioned embodiment, the writing of received indexed media is stored in the PIMB 91 of the Server 16 and transmitted to the next hop in a serial fashion. In an alternative embodiment, the received indexed media payloads can be stored in the PIMB 91 and transmitted to the next hop substantially at the same time. The storage of Media on the PIMB 30 of both transmitting and receiving Devices 13 allows for the progressive transmission and rendering of Media. On the transmit side, the Media originating on the transmitting device may be progressively transmitted over the network as it is being received. In various embodiments, the encoded Media (regardless of how it is originated) may be progressively transmitted before, after, or at substantially the same time it is stored in the PIMB 30. On the receive side, the incoming Media may also be progressively rendered as it is received over the network, provided the User has opted to Review the Media in the near real-time mode. In various embodiments, the incoming Media may be progressively rendered before, after or substantially at the same time as it is stored in the PIMB 30 of the receiving Device 13. If the received Media is to be Reviewed in the time-shifted mode, then the Media is retrieved from the PIMB 30 (or possibly a PIMB 85 on a Server 16 if replaced on the local PIMB 30) for later Review at a time designated by the User.

In the context of the present application, the term progressive or progressively is intended to be broadly construed and generally mean the continuous processing of a data stream based on availability of the data. For example, as Media is created or otherwise originated on a Device 13, the progressive encoding, storage, packetization and transmitting of that media is continuous, so long as the Media is available. As a person speaks, that Media is progressive or continuously encoded, stored, packetized and transmitted for the duration of the persons speech. When the person pauses or stops speaking, there is no media to progressively process. When the person resumes speaking again, the progressive processing of the Media resumes. On the receive side, the Media is also progressive processed as the Media is being received (i.e., available). As Media the Media is received it is continuously stored. It will also be continually rendered as the Media is being received when in the near real-time mode or from storage when in the time-shifted mode. Although the above explanation was provided in the context of voice, it should be understood that all types of Media can be progressively processed in a similar manner. Also the progressive processing of Media does not necessarily have to be progressively processed in time-indexed order. Rather the Media is processed in the order in which it is received. If Media is received out of index order, in one embodiment, the Media is progressively processed in the order it was received and then organized into the indexed sequence in the PIMB 30. In an alternative embodiment, the received Media can be organized into its indexed sequence and then progressively rendered.

## H-2 PQM Operation Flow Diagrams

The PQM **26g** relies on a metric called the Maximum Available Bit Rate (MABR), which is a continually computed approximation of actual transmission capacity or bandwidth (i.e., a measure of the capability of the network at a given point in time) between a sending and receiving node pair. As instantaneous network conditions change, the MABR is updated. Regular measurements of network throughput, packet loss, and jitter are considered in computing the MABR. In an alternative embodiment, the MABR may also be manually set or limited based on time of day, type of network, other conditions or parameters.

The PQM also considers the Intention of the recipient(s) to optimize transmission for time-sensitivity. A transmission is considered time-sensitive if either (i) the Intention of the recipient(s) is to Review the transmission “live” or in the near real-time mode, or (ii) the recipient would like to immediately Review a Message that for some reason is not currently stored on their Device **13** (e.g., the Message was previously stored in the archive **89**). The Intention of the recipient can be either inferred by the behavior of the recipient or the recipient may set or otherwise designate their Intention. On the other hand, a transmission is considered to be not time-sensitive if the Intention of the recipient is to Review the Message in the time-shifted mode. The Intention of the recipient to Review the transmission in either the live or time-shifted mode at least partially defines the “timeliness requirements” of the transmission. In various other embodiments, factors such as the urgency or priority of transmissions may also be considered in defining the timeliness requirement of the transmission.

The nodes in the network path between a sender and a receiving pair also need to be consistent regarding the status of intentions of the recipients. If one target recipient indicates timeliness, meaning they wish to Review the transmission immediately or live, then all the intermediate nodes on the network along the sender-receiver path need to have the same timeliness requirement, regardless of the requirements of other recipients. The timeliness requirement of each of the intermediate nodes is therefore dependent on the receiving nodes the transmission is being sent to. This dependency is sometimes referred to as a “union of requirements” for target nodes in the network transmission path.

The PQM further considers an Ideal Bit Rate or “IBR” for each scheduled Message payload transmission. For time-sensitive transmissions, the IBR is computed based on the packetization rate needed for substantially real time or live communication (referred to herein as the Real Time Bit Rate or RTBR). With voice for example, a packetization rate of a packet every 20 milliseconds containing 20 milliseconds of audio data is considered an acceptable IBR for conducting live conversations. The RTBR for such a system in kilobits per second would be the size of 1 second of audio payload data plus the size of all network headers that would be generated for the transmission. For video media or a combination of voice and video, the RTBR will likely be substantially higher than simply voice. For other types of media such as sensor or GPS positioning data, the RTBR will likely be lower than that of voice. For non time-sensitive transmissions, the IBR is set to a Maximum Efficiency Bit Rate (MEBR) to optimize the usage or efficiency of transmissions over the network. The MEBR is calculated by adjusting the packetization rate to its largest possible value for the underlying network. If multiple messages or payloads are to be sent between a sending and receiving pair, then an Aggregate IBR (AIBR) is considered for the transmission.

The PQM operates by sending data in a series of transmission loops for each sending and receiving pair. The transmis-

sion loops for each sending and receiving pair are independent. Any transmission on the network may affect the MABR of other sending-receiving pairs. Accordingly, the MABR is preferably continually computed for all recipients.

Referring to FIGS. **9A** through **9C**, flow charts illustrating the sequence of operation of the PQM for a single sending and receiving pair is illustrated. In FIG. **9A**, the steps in determining the MABR between the single sending and receiving pair are illustrated. In FIG. **9B**, a flow chart illustrating the steps for calculating the AIBR for each transmission loop for the single sending and receiving pair are illustrated. In FIG. **9C**, a sequence for determining the amount of data to transmit between the sending and receiving pair per loop is illustrated. The processes illustrated in the three diagrams run simultaneously and interact with one another, as described in more detail below.

In FIG. **9A**, a flow chart **50** for calculating the MABR for the network interface between the sending and receiving pair is shown. In the initial step **50<sub>1</sub>**, the network interface between the sending and receiving pair is monitored. The sender periodically receives reports, which contain information regarding the status of the network connection at the receiver in step **50<sub>2</sub>**. The reports include information regarding the current status of data throughput **50<sub>3</sub>**, packet loss **50<sub>4</sub>**, and jitter **50<sub>5</sub>** as observed by the receiver at the network interface. In step **50<sub>6</sub>**, the MABR is calculated at the sender based on these observations contained in the reports. By monitoring or observing the data in these reports, the MABR value is continually adjusted based on current network capabilities or conditions between the sending and receiving pair. As network capabilities become more favorable for data transmission, the MABR will increase. If the network capabilities become less favorable for transmission, the MABR will decrease, potentially all the way to zero for an unusable network. The reports are similar to the packet loss reports generated by nodes in TCP networks, but additionally include throughput and jitter information as well.

If there are several network interfaces between the sending and receiving pair, an MABR is calculated for each interface for which a receipt report is received. If no traffic has been recently sent on the network, or no receipt reports have been received, the MABR may not reflect current network conditions. However, since receipt reports are generated continually by receivers while data is transmitted, the sender’s MABR metrics will quickly converge to a more accurate value.

Referring to FIG. **9B**, a flow chart **52** illustrating the steps for calculating the AIBR for a transmission loop is illustrated. In the initial step **52<sub>1</sub>**, the Messages with Media (by which we mean portions of the time indexed media that belongs to this Message) ready to be transmitted between the sending and receiving pair in the current loop are ascertained. A list of Messages with Media is then built **52<sub>2</sub>**. For each Message in the list **52<sub>3</sub>**, the time-sensitivity or timeliness requirement of each Message is considered **52<sub>4</sub>**. If a particular Message is not time-sensitive, then the IBR is set to the Maximum Efficiency Bit Rate (MEBR) **52<sub>5</sub>**. On the other hand, if a Message is time-sensitive, then the IBR is set to the Real Time Bit Rate (RTBR) **52<sub>6</sub>**. In the next step **52<sub>7</sub>**, the previously computed IBRs for each of the Messages in the list are summed together, resulting in the Aggregate Ideal Bit Rate (AIBR) **52<sub>8</sub>** for the transmission loop. As signified by the return arrow **52<sub>9</sub>**, the above-described process is repeated for each transmission loop between the sending and receiving pair.

Referring to FIG. **9C**, a flow chart **54** illustrating the sequence for determining the rate of data to transmit between the sending and receiving pair per transmission loop is illus-

trated. In the initial step **54<sub>1</sub>**, the MABR (as calculated in FIG. **9A**) is compared to the AIBR (as determined in FIG. **9B**) for the next transmission.

If the MABR is greater than or equal to the AIBR, then all the Messages identified as ready for transmission in the loop are packetized at the IBR rate **54<sub>2</sub>** and transmitted **54<sub>3</sub>**.

On the other hand, if the MABR is less than the AIBR, then a series of procedures are applied to so that the PQM meets its goals of the timely delivery of an adequate copy of the data, the efficient use of available bandwidth, and/or adjustments to the payload content and quality, packet size, and transmission rate to meet current network conditions.

In the initial step, the Messages in the list are reviewed for time sensitivity **54<sub>4</sub>**. If there are no time sensitive Messages, then the bit rate is reduced to the MABR **54<sub>5</sub>**, and the Messages are transmitted **54<sub>3</sub>**.

If the list includes time-sensitive Messages, the bit rate allocated for the non time-sensitive Messages is reduced **54<sub>6</sub>** until it meets the MABR limits. If reducing the bit rate all the way to zero is insufficient to meet the MABR, then these non time-sensitive Messages are removed from the list of Messages to be transmitted in the loop. If the bit rate has been reduced so that it is less than or equal to the MABR, then the remaining Messages are Packetized and transmitted **54<sub>3</sub>**.

If the removal of non time-sensitive Messages was not sufficient to meet MABR, then another procedure involving the use of a lower quality Codec (or Codecs) for the remaining time-sensitive Messages **54<sub>7</sub>** is used. An attempt is made to transmit the payload data as fast as possible by sending fewer bits during the transmission loop. In other words, by reducing the quality of the payload, the transmission sends fewer bits in a given period of time. In various embodiments, different Codec or Codecs, each having a different bit rate versus quality tradeoff, may be used. If the use of the lower quality Codec or Codecs is sufficient, meaning the MABR limit is met, then the Messages are transmitted **54<sub>3</sub>**.

If the use of lower quality Codec(s) still does not meet the MABR, then the packetization interval of the time-sensitive Messages is increased **54<sub>8</sub>**. With this procedure, the header-to-payload ratio is increased, which lowers the overall bit rate but introduces latency (i.e., a delay in the delivery of the transmission to the recipient). If this procedure results in the reduction of the AIBR to less than or equal to the MABR, then the transmission **54<sub>3</sub>** occurs.

If after changing the packetization interval the MABR is still not met, then the bit rate may be progressively lowered **54<sub>9</sub>** to be within the MABR limit. When the bit rate is lowered in this manner, time-sensitive messages are sent at a rate that is not sufficient to maintain a live conversation. Therefore, the Conversation is forced out of "live". If the network is down or conditions are very poor, it is possible that no data transmission may occur. Again, the aforementioned sequence is repeated for each transmission loop **54<sub>10</sub>** between the sending and receiving pair.

If there are multiple network interfaces between the sending and receiving pair, the sequence described in relation to FIG. **9C** is performed for each interface for which receipt reports are available. In various embodiments, the sender may contain logic to distribute the transmission load among the multiple interfaces. In different examples, the payloads can be sent only on one interface, while in other embodiments, some or all of the interfaces may be used.

The aforementioned description pertains to any sending and receiving pair in the system **10**. In most situations, the sending and receiving pair will include a Client **12**, enabled Device **13** and Server **16**, two Servers **16**, a Server **16** and Client **12** enabled Device **13**, or even possibly two Clients **12**

respectively. If a sending node is transmitting to two (or more) receiving nodes at the same time, the above mentioned sequence as described in relation to FIGS. **9A-9C** occurs concurrently for each receiving-sending pair.

#### H-3 DQM Operation Flow Diagrams

The DQM **28g** determines if data received at the Client **12** is either corrupted or if there are missing packets. In addition, the DQM **28g** of a receiving Client **12** generates of the receipt reports, which are sent back to the transmitting node on the network. The DQM **28g** also runs a background process to ensure that an exact copy of transmitted data is eventually received and stored. These functions are described below in FIGS. **9D** through **9F** respectively.

Referring to FIG. **9D**, a flow diagram illustrating the operation of the DQM **28g** for checking for missing and/or corrupted data is illustrated. In the initial step **56<sub>1</sub>**, the DQM **28g** checks for corrupted packets using well-known techniques, such as CRC or similar integrity checking mechanisms. If a packet is corrupted, that packet is treated as missing **56<sub>2</sub>**. The DQM **28g** next ascertains if any packets are missing **56<sub>3</sub>**. If an out of sequence packet is not received after a predetermined period of time, it is assumed to be missing. The DQM **28g** notes any missing or corrupted packets **56<sub>4</sub>** in the DNQS **32**. On the other hand if no corrupted or missing packets are detected, the DQM **28g** determines if the quality of the received data was intentionally degraded by the sender **56<sub>5</sub>** for the purpose of saving bandwidth. The degraded quality is noted in the DNQS **32** **56<sub>6</sub>**. Regardless if the quality of the received data is degraded or not, receipt information (e.g., a packet sequence number, time stamp, and the network address of the next node in the network the packet is to be sent) of the data is stored **56<sub>7</sub>** in the DNQS **32**. The aforementioned process is continually repeated, as signified by the return arrow to the start of the flow diagram.

As a result of the process detailed in FIG. **9D**, information regarding the receipt of non-degraded packets, the deficiency of degraded quality packets, and missing packets, are all stored in the DNQS **32**. As Media is received, the DNQS **32** maintains up-to-date information regarding the status of the Media.

Referring to FIG. **9E**, a flow diagram illustrating the operation of the receipt report generator function of the DQM **28g** is illustrated. In the initial step, the DNQS **32** is periodically scanned **58<sub>1</sub>** to determine if there is any Media for which a receipt report needs to be generated **58<sub>2</sub>**. If the answer is no, then the above scanning process is repeated. On the other hand if Media is identified, then the process determines if the Media is time-sensitive **58<sub>3</sub>**, meaning either the User intends to Review the Media live or the user would like to immediately Review Media that is not stored on their Device **13**.

If not time-sensitive, then the recipient informs the sender to set the retransmission priority (as defined below) to low **58<sub>4</sub>**. If time-sensitive, then the amount of packet loss is considered **58<sub>5</sub>**. If the amount of packet loss is outside a usable quality range, the retransmission priority is set to high **58<sub>6</sub>**. As noted above, if the amount of packet loss is too large, the recipient may not be enabled to Review the Media upon receipt. If the quality is within an acceptable range, meaning the quality of the transmission is sufficient that it can be understood when rendered, then the priority for the sending of the receipt report is set to low **58<sub>4</sub>**. Regardless if the recipient is Reviewing upon receipt or not, a receipt report is sent **58<sub>7</sub>**, the DNQS **32** is updated **58<sub>8</sub>** and the Network Quality Manager (NQM) **28h** is updated **58<sub>9</sub>**. The retransmission requests defined in step **58<sub>4</sub>** is therefore conditional based on time-sensitivity. The transmission request defined in step **58<sub>6</sub>** is conditional on both time-sensitivity and quality.

The retransmission priority informs the PQM 26g of the sender to properly prioritize the transmission rate for the Media that requires retransmission. For example when the retransmission priority is set to high, then the sending PQM 26g of the sender should send any retransmissions before any new Media. If the priority is low, the PQM 26g should send the retransmitted Media after any new Media.

The aforementioned process is continuously repeated so that receipt reports are generated as Media is received. If the sender does not receive receipt reports in a timely manner, the PQM 26g of the sender will reduce the transmission rate, eventually stopping the transmission if no receipt reports are received.

Referring to FIG. 9F, a flow diagram illustrating the sequence for requesting of missing or degraded Media is illustrated. In the initial step 60<sub>1</sub>, the DNQS 32 is periodically scanned for missing or degraded Media 60<sub>2</sub>. If there is no missing or degraded Media, then the above defined scan is periodically repeated.

Media is considered missing if an out of sequence packet does not arrive after a predetermined threshold period of time 60<sub>3</sub>. If the packet arrives before the threshold, then it is no longer considered missing. On the other hand if the packet does not arrive after the threshold is exceeded, then it is deemed missing. With missing packets, a low priority request for retransmission is made 60<sub>4</sub> and the time of the request is noted 60<sub>5</sub> in the DNQS 32. This process is repeated until the missing packet is received. When the missing packet arrives and the corresponding Media is available in the PIMB 30, the missing status of the Media is removed from the DNQS 32. The retransmission request defined in step 60<sub>4</sub> is therefore conditional based on whether the Media is determined to be missing.

If degraded, the DQM 32 determines if the Media is part of a live Conversation 60<sub>6</sub>. If not, a request for a full quality copy of the degraded Media is made 60<sub>7</sub>, the full quality Media is designated as missing 60<sub>8</sub> and the request time is noted 60<sub>9</sub>, in the DNQS 32. If the Media is part of a live Conversation, then no action is immediately taken in order to preserve network bandwidth. When the Conversation transitions out of the live mode, then the steps 60<sub>7</sub> through 60<sub>9</sub> are performed to ensure that a full quality (i.e. an exact or perfect) copy of the degraded Media is eventually received. When the data becomes available in the PIMB 30 of the recipient Client 12, the degraded status of the associated Media is removed from the DNQS 32. The transmission request defined in step 60<sub>7</sub> is conditional on whether the Media is both degraded and not part of a live conversation.

The aforementioned process is continually repeated, as signified by the return arrows from 60<sub>5</sub> and 60<sub>9</sub> to the top of the flow diagram at 60<sub>1</sub>. By repeating the process outlined in FIG. 9F, exact copies of all transmitted Media is eventually stored in the PIMB 30 of the receiving Device 13. In this manner, the storage of exact copies of transmitted Media is guaranteed at the recipient Device 13.

### I. Graphical User Interface

Referring to FIG. 10, an exemplary Device 13 running Client application 12 is illustrated. The Device 13 includes a graphical user interface display 110, data entry buttons, keys, or keyboard 112, a microphone 114, and a transducer 116 for converting electrical signals into sound, such as a speaker. The display 110 may also accept input as a touch screen. Further, the display 110 and keyboard 112 may be combined using a touch screen interface. As noted above, the Device 13 may be a variety of different communication tools, such as a

desktop computer, laptop or other mobile computers, personal digital assistants, a programmable land-line or cellular phone, or programmable radios, or just about any other type of programmable communication device. The exemplary Device 13 illustrated in the figure is intended to be “generic”, in the sense that it is supposed to represent or encompass all of the communication devices listed above. In addition, the term “graphical” user interface should not be construed as limiting. Other types of user interfaces which can be implemented on a Device 13 as well including Audio/DTMF interfaces, Voice User Interfaces (VUI), radio switch interfaces, or a combination thereof, can all be used to implement the various functions described below. For the sake of simplicity, each of these types of methods by which a User may interact with their Device 13 are generically referred to as a “user interface”.

All Devices 13, regardless of their type, preferably have a user interface that enables the user to operate the Device 13 and communicate with other User’s in the system 10. Although the user interface can be designed to have virtually an infinite number of different look and feel implementations, there are certain functions and features that all Devices 13 should have in common. These functions and features are listed below.

The user interface preferably includes one or more of the following status indicators or flags: (i) battery indicator; (ii) connectivity indicator; (iii) clock; (iv) transmitter status; (v) transmission sync status; (vi) Reviewing status; (vii) Priority Messages needing attention; and (viii) missed Messages.

The user interface preferably includes the following functions, flags and components to conduct and manage a single Conversation: (i) name of a Conversation and/or list of Participants; (ii) Conversation status; (iii) Conversation type; (iv) Conversation duration; (v) time behind the Head of the Conversation; (vi) outstanding Messages; (vii) presence/status of Participants; (viii) meta data with navigation; (ix) Conversation attributes or designators; (x) Conversation set-up including title, scheduling, Participants, Conversation summary; and (v) indicators showing which Participants have contributed Messages and which have Listened to or Reviewed messages.

The user interface also preferably includes, in addition to those listed immediately above, the following functions, flags and components to conduct and manage multiple Conversations: (i) a name/identifier for each Conversation; (ii) live/active or standing/inactive indicator; (iii) Review position, either at Head or Time shifted; (iv) Priority and other attributes; and (v) indicators of what portions of Conversations were missed.

The user interface also preferably includes, a number of navigation features, such as: (i) DVR style fast back/forward per conversation; (ii) instant messaging style personal message navigation; (iii) Conversation Time indicators; (iv) time scale shifting (i.e. zooming backward and forward through a Message or the Messages of a Conversation); (v) changing Priority of Conversations; (vi) hanging up; and (vii) home.

The aforementioned functions and features may be implemented in a variety of ways, for example using a touch-screen graphical user interface 110, or other input devices, such as the data entry buttons, keys, or keyboard 112, a mouse, by voice-activated commands, or a combination thereof. Again the functions and features listed above and how they are implemented is not intended to be exhaustive. The various methods and technologies that could be used is so comprehensive, that it is not practical to list or discuss them all herein.

### J. Conversations

The MCMS application 20 supports a number of different types of Conversations, such as a near real time or “live” calls

where the delay from when a Participant speaks and the other Participant(s) hear the first Participant is very small, Conversations where Participants exchange voice Messages back and forth with a longer delay between Messages, “live” conference calls involving multiple Users, standing Conference calls at a regularly scheduled times, or configurable structured call types such as a simultaneous briefing, where Participants each leave a Message briefing beforehand for others to Review to before everyone joins the live conference call. Yet another unique attribute of the MCMS application **20** is the ability for Users to transition between the different types of Conversations. For example, the Participants can seamlessly transition from a voice-messaging mode to a live call and back again. Or the Participants of a live conference call can transition to a voice-messaging mode and send updates or action items to each other after the conference call. While several examples have been noted, it should be understood that the system **10** is extremely flexible and provides numerous options to transition between different types of calls or Conversations and between multiple conversations. By varying the delay between Messages, the Participants effectively flows between the type of Conversation that best suits their needs. The above examples should therefore not be construed as limiting.

As noted above, Conversations consist of Messages maintained in their original context and sequence. A sent Message either belongs to an existing Conversation or begins a new Conversation. A typical Conversation includes a set of Messages that are organized around a defined subject matter, topic, time, Group or Channel. For example, Conversations may involve a common Group of people such as the members of a club, a company may have a standing Conversation at a fixed time, such as a weekly sales meeting, or friends may have ad-hoc Conversations on various topics, such as making dinner plans.

Each Conversation is defined by a set of attributes, including a name, a list of Participants, begin and end time, and state including at least pending, active, or terminated. Other Conversation states are possible in other embodiments. A User interacts with the MCMS application **20** on their Devices **13**. In preferred embodiments, the interface allows a User to organize Conversations by any of the various attributes.

The relationship between a Participant and a Conversation also has attributes. These attributes include, but are not limited to, Priority, Status (states of participation in a Conversation). The values of Participant status include active, participation in more than one Conversation at a time, Reviewing a Conversation in a time-shifted mode, Catching Up To Live, passively participating (i.e., not actively Reviewing, but receiving high Priority Messages), standby, or ignoring a Conversation (i.e., declined to participate or record the Conversation).

From a recipient’s perspective, a User may select or define the relative priority of Messages. For example, Messages from a person’s boss would typically be given a higher Priority than a social acquaintance. In some embodiments, a recipient has the ability to set their own Priorities. In the implementation of MCMS-C the User selects a subset of their Conversations to be rendered consecutively. The User then sets ordered Priorities for these Conversations. The system uses the priorities set by the user to order the Messages to be rendered. The aforementioned algorithm queues the Messages to be rendered using User Priorities and information concerning Message data available (beyond MTSD).

In other embodiments, such as tactical communications, the recipient may have no or limited ability to set Priorities. For example, a fire fighter may have no ability to lower the

Priority of Messages from the fire chief. A sending-User, however, has the ability to send urgent or highly important Messages. By Tagging a Message as urgent or an emergency, the Message is rendered as soon as possible at the recipient(s), overriding any Priority settings of the recipient. Any conflicts among multiple emergency messages are resolved based on a predetermined priority scheme.

#### K. MCMS Operation

Referring to FIG. **11A**, an organizational diagram **1100** grouping the major functions of the MCMS application **20** is illustrated. The major functions include account management **1102**, conversation management **1104**, aggregate conversation list management **1106**, conversation participation **1108**, call controls **1110**, and contact management **1112**. After registering and logging into the system **10**, the User may navigate through the user interface of their Device **13** implementing the various management functions, described in detail below. In some embodiments, this functionality will provide a great deal of flexibility. In other embodiments, such as tactical or communication radios, the implementation of the user interface may be constrained with many of the user functionality and options preconfigured to meet the utility of the device. The discussion here is exemplary and is not intended to be an exhaustive explanation of the MCMS functionality, but rather is intended to provide just an overview of some of the MCMS attributes.

##### K.1 Account Management

Under the account management function **1102**, a registered User may change certain settings and preferences. A User may change their email address, password, name, phone number, phone password, call-in number, default and/or User defined rendering speeds, Tags, gain or volume levels for Reviewing Messages, Catch Up to Live mode, etc. To make these changes, the User enters the appropriate information through the interface **110** of their Device **13**. The MCMS application **20** responds by writing the updated preferences into the MCMS database **22**.

##### K.2 Conversation Management

As illustrated in FIG. **11B**, conversation management **1104** is a set of functions that allow a User to view their aggregate Conversation lists, create a new Conversation, update the details of a Conversation, delete a Conversation, and close a Conversation. Each of these functions are described below.

**View Conversations 1104a**—For each Conversation, the MCMS application **20** may provide the User the one or more of the following attributes: the name of the Conversation, the actual start time, the last activity, Tags, duration, and the list of Participants. For each Participant, the name and/or phone number, status (live, other call, in past, catch-up-mode, offline-reachable, offline-unavailable.)

**Create a Conversation 1104b**—A User creates a Conversation through the interface **110** by inputting a Conversation name, a list of Contacts, and an optional scheduled start time. If no start time is designated, it is assumed the start time is immediate. In response, the MCMS application **20** creates a new Conversation in the database **22**, associating records for each Participant on the Contacts list. The MCMS application **20** also creates in the database **22** Participant records for each User on the Contact list, allowing the caller to receive the presence information of the others on the Contact list. If the Conversation is scheduled, the MCMS application **20** starts the Conversation at the designated time. Otherwise, the Conversation starts right away.

**Update Conversation Details 1104c**—The User may make changes to a Conversation through the user interface **110**. For



example, Participants may be added or removed. Any change in status of the participants is updated in the MCMS database 22.

Delete a Conversation 1104*d*—A User may delete a specific Conversation from their list of Conversations through the interface 110. In response, the MCMS application 20 notes the change in the database 22, and designates the Conversation as deleted.

Close a Conversation 1104*e*—A User may elect to terminate or close a Conversation. In one embodiment, only the User that creates a Conversation can elect to terminate that Conversation.

#### K.3 Aggregate Conversation List Management

As illustrated in FIG. 11C, the aggregate conversation list management 1106 is a set of functions that allow a User to engage in multiple Conversations (i.e., the User's aggregate conversation list). The aggregate conversation list management functions allow a User, through the interface 110 on their device, to participate in one Conversation "live", while participating in other Conversations in a time-shifted mode.

Chose Conversation 1106*a*—Through the interface 110, a User may select one Conversation among the User's aggregate conversation list as current. The Messages of the current Conversation may be rendered in either the "live" or time-shifted modes. The User may switch the current conversation among the aggregate conversation list from time-to-time.

Switch Conversations Modes 1106*b*—In an optional embodiment, a User may be able to switch from the MCMS, MCMS-C and MCMS-S modes of operation.

#### K.4 Conversation Participation

As illustrated in FIG. 11D, conversation participation 1108 is a set of functions that allow a User to start a Conversation, receive a notification to join a Conversation, obtain Conversation status information, and hang up on a Conversation.

Start a Conversation 1108*a*—After a Conversation has been created, either by the User through the interface 110 or the scheduler in the MCMS application, the status of each Participant is checked. If a Participant is offline, then an effort is made to contact that person. If a Participant is online but engaged in another Conversation, then the MCMS application 20 notifies that Participant. The presence status of all online Participants is updated in the database 22.

Receive a Notification 1108*b*—The system may notify a User that their attention has been requested on a Conversation through a graphic display and/or audible notification via the user interface 110.

Conversation Status 1108*c*—A user may request the status of a Conversation through the interface 110 of their Device 13. In response, the MCMS application 20 assembles the status information stored in the database 22 and presents the information to the User.

Conversation Pause 1108*d*—Through user interface 110, a User may hang up or switch away from an active Conversation. In response, the MCMS application 20 updates the User's participant status for active Conversations in the database 22 and directs the Store and Stream module 24 to remove the User from the Conversation.

#### K.5 Conversation Controls

As illustrated in FIG. 11E, conversation control 1110 is a set of functions that allow a User to control their participation in a Conversation. These functions allow a User to catch-up-to live, skip to the Head, jump to a past location, pause, play faster and play slower when Reviewing the Messages of a Conversation. Each of these functions is triggered by the User through the interface 110 on the Device 13.

Catch-up-to-live 1110*a*—A User may Catch Up To Live in an ongoing Conversation using the "CTL" function. When

this function is activated, the MCMS application 20 checks the last point in the Conversation the User has reviewed and directs the Store and Stream module 24 to render the Messages not previously heard, using a faster than normal rendering option designated by the User, and to seamlessly transition to live mode when it reaches the head.

Jump to Head 1110*c*—This function enables a User to jump to the Head of a Conversation, skipping over any intervening Messages between the current point of the User in the Conversation and the Head. When implemented, the MCMS application 20 instructs the Store and Stream module to immediately render the Messages at the Head of the Conversation. (If the Head of the Conversation is currently live this is called Jump to Live (JTL).

Jump to past 1110*d*—This function enables a User to jump back to a previous Message or point in the Conversation, similar to a rewind or replay function. When implemented, the MCMS application 20 instructs the Store and Stream module 24 to render Media starting from the rewind point.

Pause 1110*e*—This function enables the User to pause the Reviewing of the Messages of a Conversation. In response, the Store and Stream module 24 stops the rendering of Messages until another command is issued.

Play faster 1110*f*—This function enables a User to render Messages more quickly. In response, the Store and Stream module 24 renders the Messages at a faster rate than normal. The rendering rate may be either specified by the User or the User may select from a number of preset options.

Play slower 1110*g*—This function enables a User to render Messages more slowly. In response, the Store and Stream module 24 renders the Messages at a slower rate than normal. The rendering rate may be either specified by the User or the User may select from a number of preset options.

#### K.6 Contact Management

As illustrated in FIG. 11F, the system 10 provides the User with a host of functions for managing Contact lists and user Groups. These functions include the adding, editing, deleting Contacts and user Groups. Each of these functions are implemented by a User through the interface of their Device 13. Any revisions or deletions in a User's Contact list or Group list is stored in the MCMS database 22.

Add a Contact 1112*a*—This function enables a User to add a new Contact to their contact list. The new Contact can be either a registered User or an external contact. Typically the name, phone number(s), type of number (cell, office, home, computer, etc.), email address and other personal information are provided for each contact record.

Edit a Contact 1112*b*—This function enables a User to edit or update an existing contact record.

Delete a Contact 1112*c*—This function enables a User to remove or delete an existing contact record.

Search for a Contact 1112*d*—This function enables a User to search for a specific Contact in their contact list. The search may be conducted using a number of criteria, such as name, phone number, most recently called, most frequently called, Group, etc.

Get a Participant list 1112*e*—This function enables a User to search and retrieve a list of Participants of a Conversation by a number of different search criteria, including for example by name, most recent outgoing calls, most recent incoming calls, most frequently called, etc.

Authorize a caller to review status 1112*f*—This function enables a first User to authorize other Users to view the first User's status. Non-authorized Users may not view the status of the first User.

Create a Group of Contacts 1112*g*—This function enables a User to associate a number of Contacts into a Group. When

a User defines a Group, the list of Contacts in that Group are stored in the MCMS database **22**.

Edit a Contact Group **1112h**—This function enables a User to edit a Group, or update the contact information for a member of the Group.

Delete a Contact Group **1112i**—This function enables a User to delete a Group.

## L. MCMS Operation

### L.1 MCMS-C

As noted above, the MCMS-C operation is similar to MCMS, with the added feature of enabling Users to manage and participate in multiple conversations consecutively through a hierarchical system of Priorities and the time-shifting of Messages, which are automatically managed by the system. Implementing the MCMS-C functionality includes three basic processes. As illustrated in FIG. **12A**, the first process involves defining a set of Conversations for consecutive rendering. Once the list is defined, a hierarchical set of Priorities and other factors are applied to the indexed media payloads associated with the set of Conversations. The indexed media payloads are then sequenced into a sequencing order. By rendering the media in the sequence order, the Messages of the set of Conversations are consecutively rendered.

Referring to FIG. **12A**, a flow chart illustrating the steps for defining the list of Conversations to render consecutively is shown. In the initial step **1202**, the User's aggregate list of Conversations is defined. Either the User or pre-configuration data (step **1204**) is next used to select the Conversations among the aggregate list for consecutive rendering (step **1206**). With a tactical communication system for example, typically pre-configuration data is used to impose the Conversations to be consecutively rendered. With non-tactical applications, the User is typically given a higher degree of flexibility to select the Conversations for consecutive rendering.

Referring to FIG. **12B**, a flow chart illustrating the steps for defining hierarchical set of priorities for rendering the Messages of consecutive Conversations is illustrated. In the initial step (**1208**), a set of priority rules are defined and applied to the list of Conversations to be rendered consecutively (**1206**). In various embodiments, the set of priority rules may range from a rigid, hierarchical communication protocol to a highly flexible communication protocol. For example in a tactical communication system where a rigid hierarchy is often desirable, the set of priority rules will preferably impose a specific order in which concurrent Messages are rendered. For example with a first-responder tactical system, Messages from a fire chief may be given the highest priority. The next level of priority may be given to fire fighters inside a burning building. At the next level, priority may be given to fire fighters outside the building, etc. By defining a rigid priority, the current Messages of those supervising the efforts to fight the fire, or those in harms way, are rendered ahead of those performing a less critical role. With non-tactical communications, a User may be given a great deal of flexibility to define their own priority scheme to meet personal needs. A sales executive may for example define a priority scheme listing consecutive Conversations with clients from the most important to the least important. Or a User may prioritize consecutive Messages among family and friends. Regardless of the scheme used, a priority list for consecutive Conversations is defined (step **1210**) in this process.

Referring to FIG. **12C**, a flow diagram illustrating the construction of a queue of Messages received from the vari-

ous consecutive Conversations is illustrated. In the initial step, the availability of non-rendered indexed media payloads of Messages (i.e., media streams) is continually detected (step **1212**) for each of the Conversations to be consecutively rendered. The priority hierarchy is applied to the available indexed media payload streams (step **1214**). Based at least partially on the priority hierarchy, and possible other parameters as mentioned below, the available indexed media payloads are arranged into a sequence order (step **1216**). The indexed media payloads are then continuously rendered in the sequence order (step **1218**). By continuously repeating the above-described process, the Messages of multiple Conversations are consecutively rendered.

In one embodiment, the sequencing order is based either partly or fully on the priority hierarchy. In alternative embodiments, other parameters in addition to the hierarchy and availability may be considered as well. For example, the sequence order may be defined using one or more parameters such as the switching costs associated with interrupting a currently rendered stream of indexed media payloads with the indexed media payloads of a higher priority Conversation, the quality of the available streams of indexed media payloads, the relative time the indexed media payloads were received, a shuffling order, or from input of a controller of the system.

Typically when conflicts between the Messages of different Conversations occur, the indexed media payloads first in sequence order are rendered while the rendering of other available indexed media payloads are paused or delayed. When there no conflicts, indexed media payloads are immediately rendered as they become available.

In yet another embodiment, the Messages of the consecutively rendered Conversations may be optionally reviewed in a time-shifted mode. If the User of the first communication device generated any Media associated with the consecutively rendered Conversations, that media is indexed and stored in the PIMB **30** of the Device as well as the PIMB(s) **85** of the Servers **16** on the network. Thus when a Conversation is reviewed in the time shifted mode, the User has the option of reviewing just the incoming Messages associated with the Conversation, or both the incoming Messages as well as the Media created by the first User associated with the Conversation in time index order.

### L.2 MCMS-S Operation

In the MCMS-S or simultaneous mode, a User of a Client **12** enabled Device **13** may define a set of Conversations for simultaneous rendering. Once the set of Conversations is defined, the indexed media payload streams associated with the set of Conversations are simultaneously rendered on the Device **13**, regardless if they overlap or not. In alternative embodiments, the User may optionally render the received indexed media payloads from the set of media streams separately. The indexed media payloads of the simultaneous Conversations may also be optionally rendered in near real-time or in the time-shifted mode.

### L.3 MCMS, MCMS-C and MCMS-S Examples

In FIGS. **13A** through **13D**, a series of diagrams illustrating the attributes of a Conversation and the operation of MCMS, MCMS-C and MSMS-S is illustrated.

In FIG. **13A**, a time diagram illustrating the sequence of rendering the indexed media payloads of the Messages of a Conversation labeled "A" between a User "X" and two other users, designated "Y" and "Z". In this example, Media is generated by user Y during the time intervals designated by **t1**, **t5**, **56**, **t7** and **t9**. Media is generated by user Z during the time intervals designated **t3**, **t6** and **t9** through **t10**.

The rendering sequence at the Device **13** of User X is illustrated at the bottom of the figure. During intervals **t1**, **t5**,

and t7, Media derived only from Y is rendered. During intervals t3 and t10, only Media derived from Z is rendered. In intervals t6 and t9, Media from both Y and Z is rendered. In intervals t2, t4 and t8, nothing is being rendered because neither users Y or Z are generating Media during these periods. It should be noted that intervals t1 through t10 are not intended to mean fixed time intervals, but rather, just periods of time when Media is being generated.

The diagram of FIG. 13A is useful in illustrating the attributes of Conversations. When one user is generating Media (either Y or Z), that Media is received at the Device 13 of X and is available for rendering. When both users X and Y are generating Media, both Media streams are received at Device 13 of X and is available for Mixing. When neither user X or Y is generating Media, no Media is received at Device 13 of X. As noted above, User X has the option of Reviewing the Media generated during Conversation A in either the near real-time or time-shifted modes. Also the User X has the option of Reviewing the Media in the Mixed format as illustrated, or to separately Reviewing the Media from Y and Z in the time-shifted mode.

FIG. 13B illustrates the operation of MCMS. In this example, the User is Participating in three Conversations, designated A, B and C. For Conversations A, B, and C, the User either generates or receives Messages designated (A1, A2, A3, and A4), (B1, B2 and B3) and (C1 and C2) respectively. The timing and duration of each Message is indicated by the starting point along the time-line. It is useful to note that in this example, all of the Messages overlap in time to some degree, except Message B2.

With the MCMS application, the User selects one Conversation as current. For the selected Conversation, the User may Review incoming Messages and generate Messages which are transmitted to the other Participants of the Conversation. In this example, the User selects in order Conversation B, C and A as current respectively. The Message sequence is therefore initially B1, B2, and B3, followed by C1 and C2, and then finally A1 through A4. Again, while a particular Conversation is selected as current, the User may transition between the near real-time and the time-shifted modes and back again. The final rendering as illustrated in the diagram is not intended to correspond in timing of the received Messages as illustrated in the top portion of the diagram. Rather the lower portion of the diagram is intended to show only the rendering order of the Messages, based on Conversation order selected by the User.

The example of FIG. 13B is thus useful in illustrating the attributes of the MCMS application. A User selects one Conversation as current. The other Conversations are paused. The User may also transition the current Conversation among all the Conversations at any time.

Referring to FIG. 13C, a diagram illustrating the operation of MCMS-C is illustrated. In this example, the User is Participating in two consecutive Conversations, A and B. With Conversation A, three Messages are received A1, A2, and A3. With Conversation B, three Messages are received B1, B2 and B3. It is useful to note that with this example, Message B1 conflicts with Messages A1. Also Conversation A has a higher priority than Conversation B.

During the consecutive rendering of the two Conversations, the higher priority Messages A1 and A2 are first rendered in near real-time, as represented by the vertical dashed lines in the figure. Since there is a relatively large time gap between Messages A2 and A3, this space is filled by time shifting and rendering Messages B1 and B2. When A3 arrives, it is rendered in near real-time, while Message B3 is rendered only after the higher priority Message A3 is ren-

dered. By time-shifting rendering of the lower priority Messages between the higher Priority Messages, consecutive multiple conversations can be managed. It should be noted that in this simple example, priority is the only parameter used to determine the consecutive order for rendering. As noted above, a number of other parameters may be used as well.

Referring to FIG. 13D, a diagram illustrating MCMS-S is illustrated. In this example, a User is engaged in three simultaneous Conversations, A, B and C. The Messages A1, A2 and A3, B1, B2 and B3, and C1 and C2 are received for each Conversation A, B and C are shown in the diagram respectively. With the MCMS-S, the incoming Messages are rendered at a recipients Device 13 as they are received. The rendering sequence of the Messages of the three Conversations A, B and C, as illustrated in the lower portion of the diagram, are therefore the same as when the Messages were received. In this manner, multiple Conversations may be simultaneously rendered.

In the aforementioned examples, several variations of the MCMS application were described, including MSMS-C and MCMS-S. Regardless of the specific type of MCMS application used, they all share several common characteristics. In each case, the Conversations are defined by a threaded sequence or organization of Messages. The Messages are segmented from a stream of Media, with each Message given a sequence identifier and indexed by the time the Media was created. Depending on the variation of the MCMS application, Messages can be rendered in accordance with one or more rendering options. The rendering options include, in one form or another, the filtering, grouping overlapping and/or serialization of Messages, using anywhere from zero to a plurality of different attributes. In this manner, multiple Conversations, each including a string of Messages, can be conducted on a single Client 12 enabled Device 13. Lastly, each of the variations of MCMS may handle the receipt of interrupt Messages in the same way. When an interrupt Message is received, it typically takes precedent over and is rendered before other Messages belonging to other Conversations.

#### M. Client and Server Hardware

Referring to FIG. 14A, a block diagram 140 illustrating the hardware of a Device 13 used for storing and executing the Client application 12 is shown. The hardware includes a CPU 142, main memory 144 and mass storage 146. As is well known in the art, the Client application 12 is loaded and stored in main memory 144 and mass storage 146 and executed by the CPU 142.

Referring to FIG. 14B, a block diagram 150 illustrating the hardware of a Server 16 used for storing and executing the server application 78 is shown. The hardware includes a CPU 152, main memory 154, mass storage 156, and the archive 89. As is well known in the art, the server application 78 is loaded and stored in main memory 154 and mass storage 156 and executed by the CPU 152. As noted above, indexed media payloads of one or more Users are stored in the archive 89.

Although many of the components and processes are described above in the singular for convenience, it will be appreciated by one of skill in the art that multiple components and repeated processes can also be used to practice the techniques of the system and method described herein. Further, while the invention has been particularly shown and described with reference to specific embodiments thereof, it will be understood by those skilled in the art that changes in the form and details of the disclosed embodiments may be made without departing from the spirit or scope of the inven-

tion. For example, embodiments of the invention may be employed with a variety of components and should not be restricted to the ones mentioned above. It is therefore intended that the invention be interpreted to include all variations and equivalents that fall within the true spirit and scope of the invention.

What is claimed is:

**1.** A computer readable application embedded in a non-transitory computer readable medium and intended to run on a communication device, the application comprising:

a storage module configured to progressively and persistently store streaming media created using the communication device as the streaming media is created;

a transmission module configured to progressively transmit the streaming media over a network as the streaming media is created and persistently stored;

a network receive module cooperating with the storage module to progressively and persistently store streaming media received over the network from a remote communication device as the streaming media is received; and

a rendering module configured to provide rendering options to selectively render the received streaming media, for the first time, in both a real-time mode as the streaming media is received over the network and in a time-shifted mode by retrieving and rendering the retrieved streaming media from persistent storage.

**2.** The application of claim **1**, wherein the transmission module and the rendering module further cooperate to transmit the created media streams and render the received media streams synchronously with respect to one another.

**3.** The application of claim **1**, wherein the transmission module and the rendering module further cooperate to transmit the created media streams and render the received media streams asynchronously with respect to one another.

**4.** The application of claim **1**, wherein the transmission module, the network receive module, and the rendering module further cooperate to enable the communication device to participate in both synchronous and asynchronous communication with the remote communication device.

**5.** The application of claim **1**, further comprising an encoder module configured to progressively encode the streaming media into indexed media payloads as the streaming media is created.

**6.** The application of claim **1**, wherein the storage module is further configured to persistently store the streaming media in the form of indexed media payloads as the streaming media is created.

**7.** The application of claim **1**, wherein the transmission module is further configured to progressively transmit the streaming media in the form of indexed media payloads as the streaming media is created.

**8.** The application of claim **1**, wherein the storage module is further configured to persistently store both the transmitted and received streaming media in the form of indexed media payloads.

**9.** The application of claim **1**, further comprising a messaging module configured to (i) segment the transmitted streaming media into messages and (ii) receive the streaming media in the form of messages.

**10.** The application of claim **9**, wherein the messaging module is further configured to thread together the transmitted and received messages sharing a common attribute.

**11.** The application of claim **9**, wherein the messaging module threads together the messages sharing the common attribute in the time order in which the messages were created.

**12.** The application of claim **1**, wherein the transmission module and the storage module further cooperate to transmit

the created streaming media out of persistent storage in the event the streaming media is created when the communication device is disconnected from the network.

**13.** The application of claim **12**, wherein the transmission module is further configured to:

(i) ascertain if the communication device is disconnected from the network when the streaming media is created, wherein disconnected from the network is defined as the inability to transmit the streaming media; and

(ii) transmit the streaming media out of persistent storage when the communication device re-connects to the network, wherein connected is defined as the ability to transmit the streaming media.

**14.** The application of claim **1**, wherein the rendering module is further configured to selectively render the received streaming media, after the first time, one or more subsequent times out of persistent storage.

**15.** The application of claim **1**, wherein the rendering module is further configured to selectively render the transmitted streaming media out of persistent storage.

**16.** The application of claim **1**, wherein the rendering module is further configured to transition the rendering of the received media streams from (i) the real-time mode to the time-shifted mode and (ii) from the time-shifted mode to the real-time mode.

**17.** A communication device, comprising:

a storage element configured to progressively and persistently store streaming media created using the communication device as the streaming media is created;

a transmission element configured to progressively transmit the streaming media over a network as the streaming media is created and persistently stored;

a network receive element cooperating with the storage element to progressively and persistently store streaming media received over the network from a remote communication device as the streaming media is received; and

a rendering element configured to provide rendering options to selectively render the received streaming media, for the first time, in both a real-time mode as the streaming media is received over the network and in a time-shifted mode by retrieving and rendering the retrieved streaming media from persistent storage.

**18.** The device of claim **17**, wherein the transmission element and the rendering element further cooperate to transmit the created media streams and render the received media streams synchronously with respect to one another.

**19.** The device of claim **17**, wherein the transmission element and the rendering element further cooperate to transmit the created media streams and render the received media streams asynchronously with respect to one another.

**20.** The device of claim **17**, wherein the transmission element, the network receive element, and the rendering element further cooperate to enable the communication device to participate in both synchronous and asynchronous communication with the remote communication device.

**21.** The device of claim **17**, further comprising an encoder element configured to progressively encode the streaming media into indexed media payloads as the streaming media is created.

**22.** The device of claim **17**, wherein the storage element is further configured to persistently store the streaming media in the form of indexed media payloads as the streaming media is created.

45

23. The device of claim 17, wherein the transmission element is further configured to progressively transmit the streaming media in the form of indexed media payloads as the streaming media is created.

24. The device of claim 17, wherein the storage element is further configured to persistently store both the transmitted and received streaming media in the form of indexed media payloads.

25. The device of claim 17, further comprising a messaging element configured to (i) segment the transmitted streaming media into messages and (ii) receive the streaming media in the form of messages.

26. The device of claim 25, wherein the messaging element is further configured to thread together transmitted and received messages sharing a common attribute.

27. The device of claim 25, wherein the messaging element threads together the messages sharing the common attribute in the time order in which the messages were created.

28. The device of claim 17, wherein the transmission element and the storage element further cooperate to transmit the created streaming media out of persistent storage in the event the streaming media is created when the communication device is disconnected from the network.

29. The device of claim 28, wherein the transmission element is further configured to:

- (i) ascertain if the communication device is disconnected from the network when the streaming media is created, wherein disconnected from the network is defined as the inability to transmit the streaming media; and
- (ii) transmit the streaming media out of persistent storage when the communication device re-connects to the network, wherein connected is defined as the ability to transmit the streaming media.

30. The device of claim 17, wherein the rendering element is further configured to selectively render the received streaming media, after the first time, one or more subsequent times out of persistent storage.

31. The device of claim 17, wherein the rendering element is further configured to selectively render the transmitted streaming media out of persistent storage.

32. The device of claim 17, wherein the rendering element is further configured to transition the rendering of the received media streams from (i) the real-time mode to the time-shifted mode and (ii) from the time-shifted mode to the real-time mode.

33. A communication method for communicating using a communication device, comprising:

- progressively and persistently storing streaming media created using the communication device as the streaming media is created;
- progressively transmitting the streaming media over a network as the streaming media is created and persistently stored;
- progressively and persistently storing streaming media received over the network from a remote communication device as the streaming media is received; and
- selectively rendering, for the first time, the received streaming media using one of two rendering options, the two rendering options including both (i) a real-time mode as the streaming media is received over the network and (ii) a time-shifted mode by retrieving and rendering the retrieved streaming media from persistent storage.

46

34. The method of claim 33, further comprising transmitting the created media streams and rendering the received media streams synchronously with respect to one another.

35. The method of claim 33, further comprising transmitting the created media streams and the rendering of the received media streams asynchronously with respect to one another.

36. The method of claim 33, further comprising transitioning communication with the remote communication device between synchronous and asynchronous communication.

37. The method of claim 33, further comprising progressively encoding the streaming media into indexed media payloads and progressively and persistently storing the indexed media payloads as the streaming media is created.

38. The method of claim 33, wherein progressively transmitting the streaming media further comprises progressively transmitting indexed media payloads as the streaming media is created, encoded, and persistently stored.

39. The method of claim 33, wherein progressively and persistently storing streaming media received over the network further comprises progressively and persistently storing indexed media payloads received over the network.

40. The method of claim 33, further comprising: segmenting the transmitted streaming media into messages; and receiving the streaming media in the form of messages.

41. The method of claim 40, further comprising threading together the transmitted and received messages sharing a common attribute.

42. The method of claim 41, further comprising sequencing the threaded messages together in the time order in which they were created.

43. The method of claim 33, further comprising transmitting the created streaming media out of persistent storage in the event the streaming media is created when the communication device is disconnected from the network.

44. The method of claim 43, wherein transmitting the created streaming media out of persistent storage further comprises:

- (i) ascertaining if the communication device is disconnected from the network when the streaming media is created, wherein disconnected from the network is defined as the inability to transmit the streaming media; and
- (ii) transmitting the streaming media out of persistent storage when the communication device re-connects to the network, wherein connected is defined as the ability to transmit the streaming media.

45. The method of claim 33, further comprising selectively rendering the received media streams, after the first time, one or more subsequent times from persistent storage.

46. The method of claim 33, further comprising selectively rendering the transmitted media streams, after transmission, one or more subsequent times from persistent storage.

47. The method of claim 33, wherein selectively rendering the received media streams further comprises transitioning the rendering of the received media streams from the real-time mode to the time-shifted mode.

48. The method of claim 33, wherein selectively rendering the received media streams further comprises transitioning the rendering of the received media streams from the time-shifted mode to the real-time mode.