



US008154450B2

(12) **United States Patent**
Polisetty et al.

(10) **Patent No.:** **US 8,154,450 B2**
(45) **Date of Patent:** **Apr. 10, 2012**

(54) **OPTIMIZATION FOR FINDING DIRECTION OF ARRIVAL IN SMART ANTENNAS**

FOREIGN PATENT DOCUMENTS

EP 1233543 8/2002

(75) Inventors: **Chandra Mouli Polisetty**, Parvathi Puram (IN); **Venu Gopal Rao Mullu**, Hyderabad (IN)

OTHER PUBLICATIONS

(73) Assignee: **QUALCOMM Incorporated**, San Diego, CA (US)

Di Claudio et al., "WAVES: Weighted Average of Signal Subspaces for Robust Wideband Direction Finding", IEEE Transactions on Signal Processing, vol. 49, No. 10, Oct. 2001.*

(*) Notice: Subject to any disclaimer, the term of this patent is extended or adjusted under 35 U.S.C. 154(b) by 191 days.

International Search Report and Written Opinion—PCT/US2010/037552, International Search Authority—European Patent Office—Sep. 1, 2010.

(21) Appl. No.: **12/478,991**

Schmidt R 0: "Multiple Emitter Location and Signal Parameter Estimation" IEEE Transactions on Antennas and Propagation, IEEE Service Center, Piscataway, NJ, US LNKDD01: 10.1109/TAP.1986.1143830, vol. AP-34, No. 3, Mar. 1, 1986, pp. 276-280.

(22) Filed: **Jun. 5, 2009**

* cited by examiner

(65) **Prior Publication Data**

US 2010/0309048 A1 Dec. 9, 2010

Primary Examiner — Thomas Tarcza

Assistant Examiner — Frank McGue

(51) **Int. Cl.**

H01Q 3/00 (2006.01)

G01S 19/51 (2010.01)

(74) *Attorney, Agent, or Firm* — Kenyon S. Jenckes; Espartaco Diaz Hidalgo

(52) **U.S. Cl.** **342/359**; 342/357.34

(58) **Field of Classification Search** 342/359, 342/357.34

See application file for complete search history.

(57) **ABSTRACT**

A smart antenna system may exploit space diversity by employing an array of antennas whose radiation pattern can be aligned in a direction of arrival (DoA) of a specific signal to be decoded. Smart antennas can be installed on a base station side and/or on a user terminal side. Certain embodiments of the present disclosure provide methods for computationally efficient and accurate searching of the DoA of a specific transmitted signal. The proposed methods utilize Assisted Global Positioning System (A-GPS) coordinates to determine the DoA.

(56) **References Cited**

U.S. PATENT DOCUMENTS

5,943,013 A * 8/1999 Ohashi 342/417
6,512,481 B1 * 1/2003 Velazquez et al. 342/367
2002/0111174 A1 8/2002 Judson et al.
2004/0104839 A1 6/2004 Velazquez et al.

24 Claims, 5 Drawing Sheets

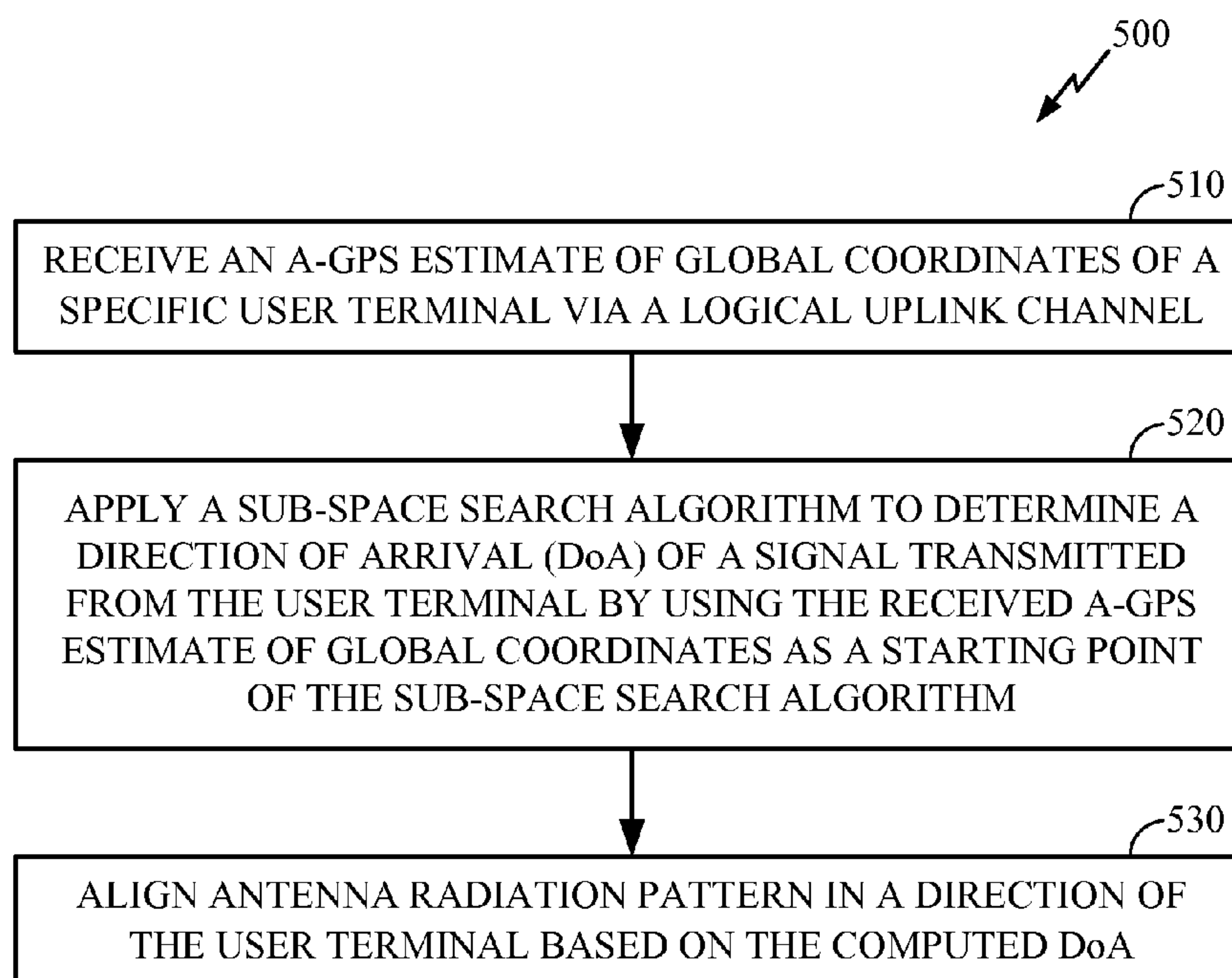

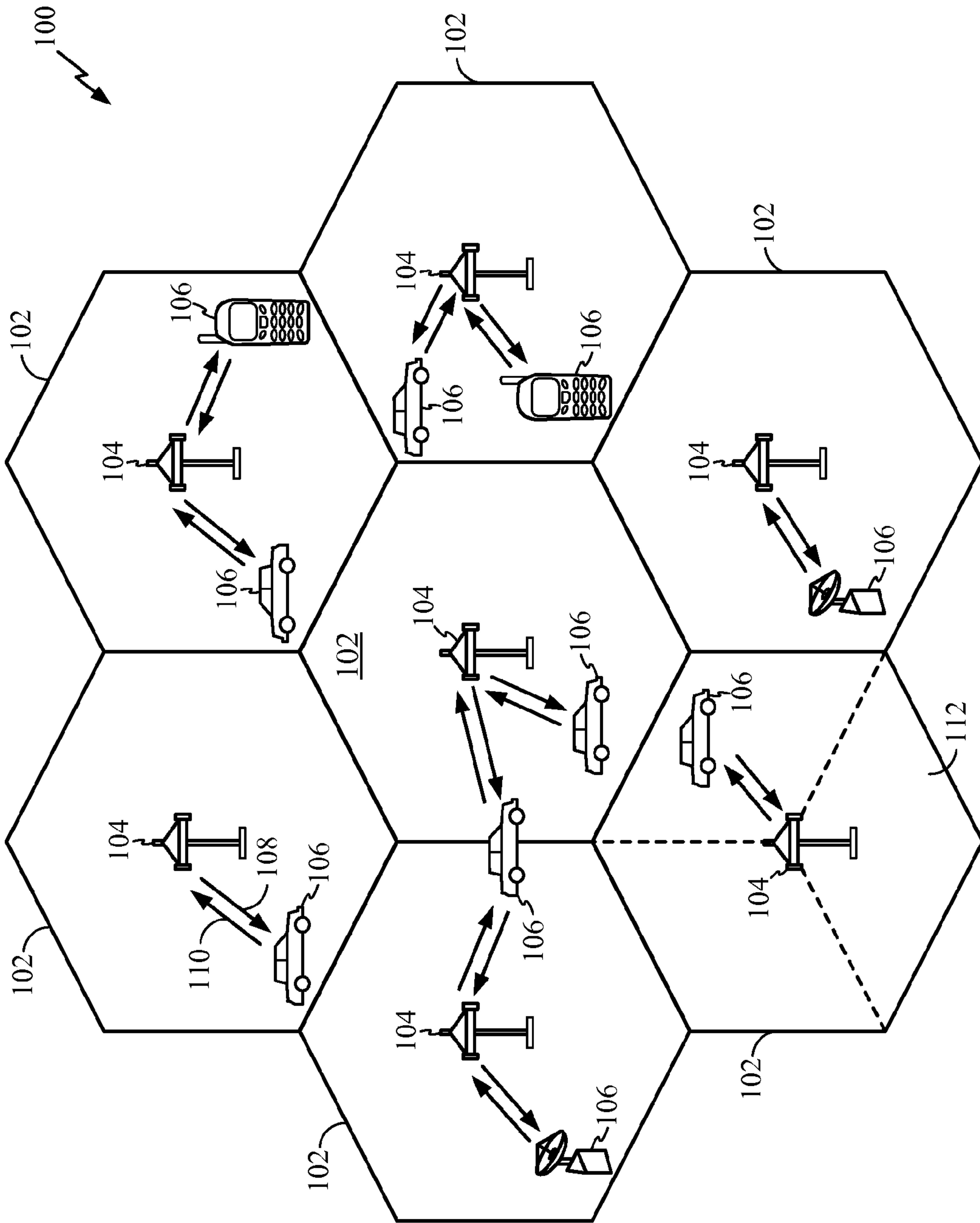

FIG. 1

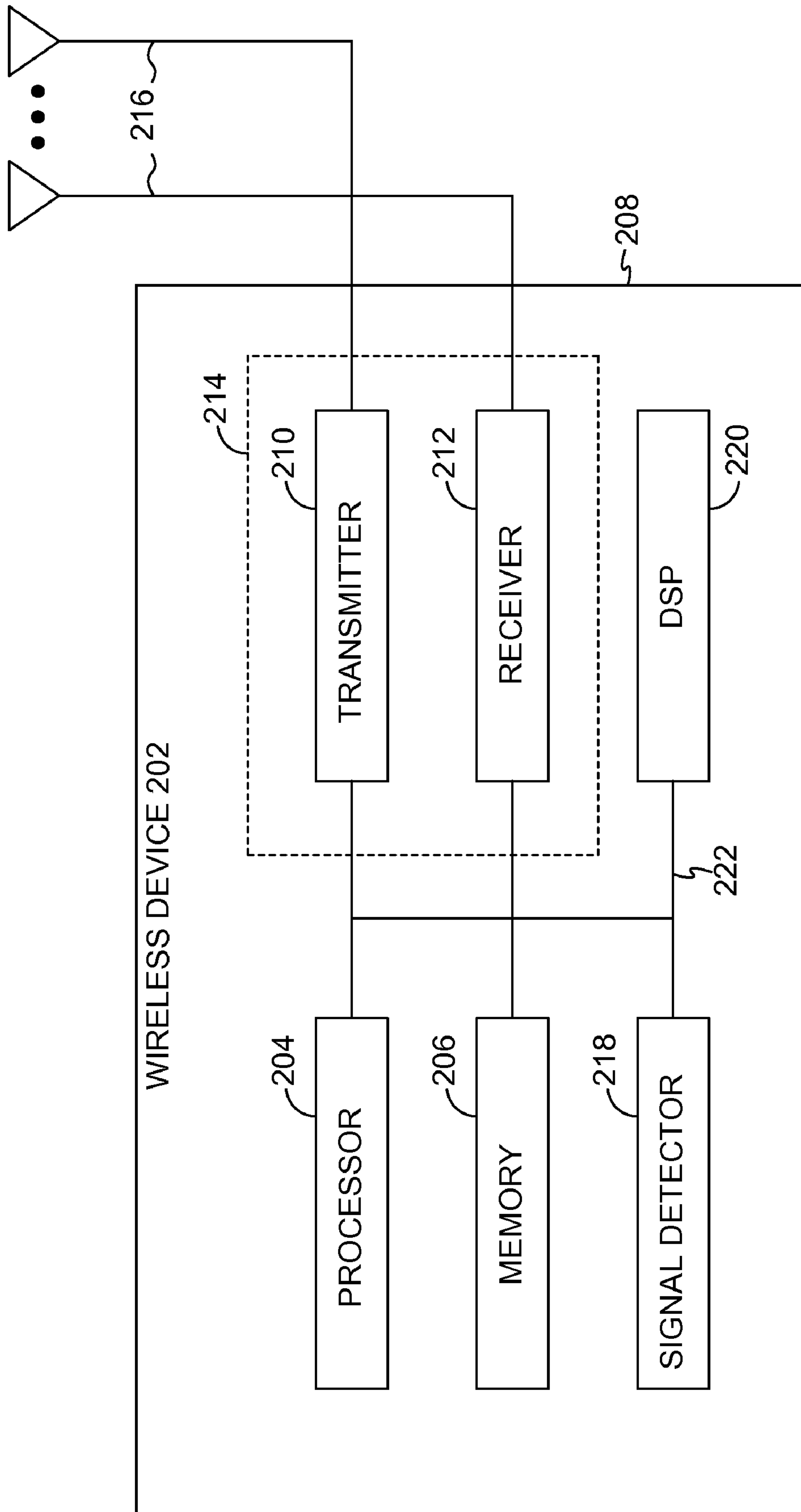

FIG. 2

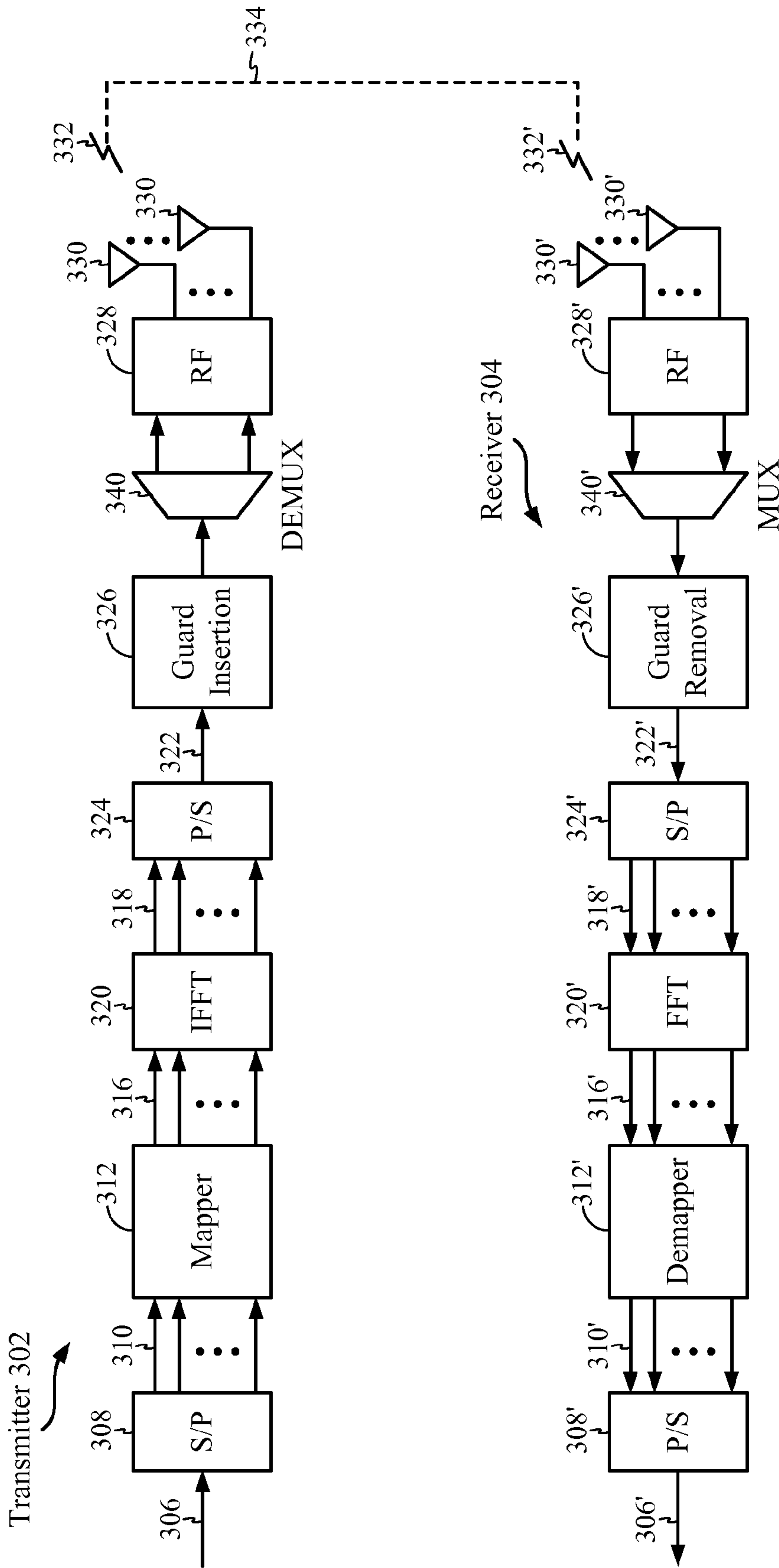

FIG. 3

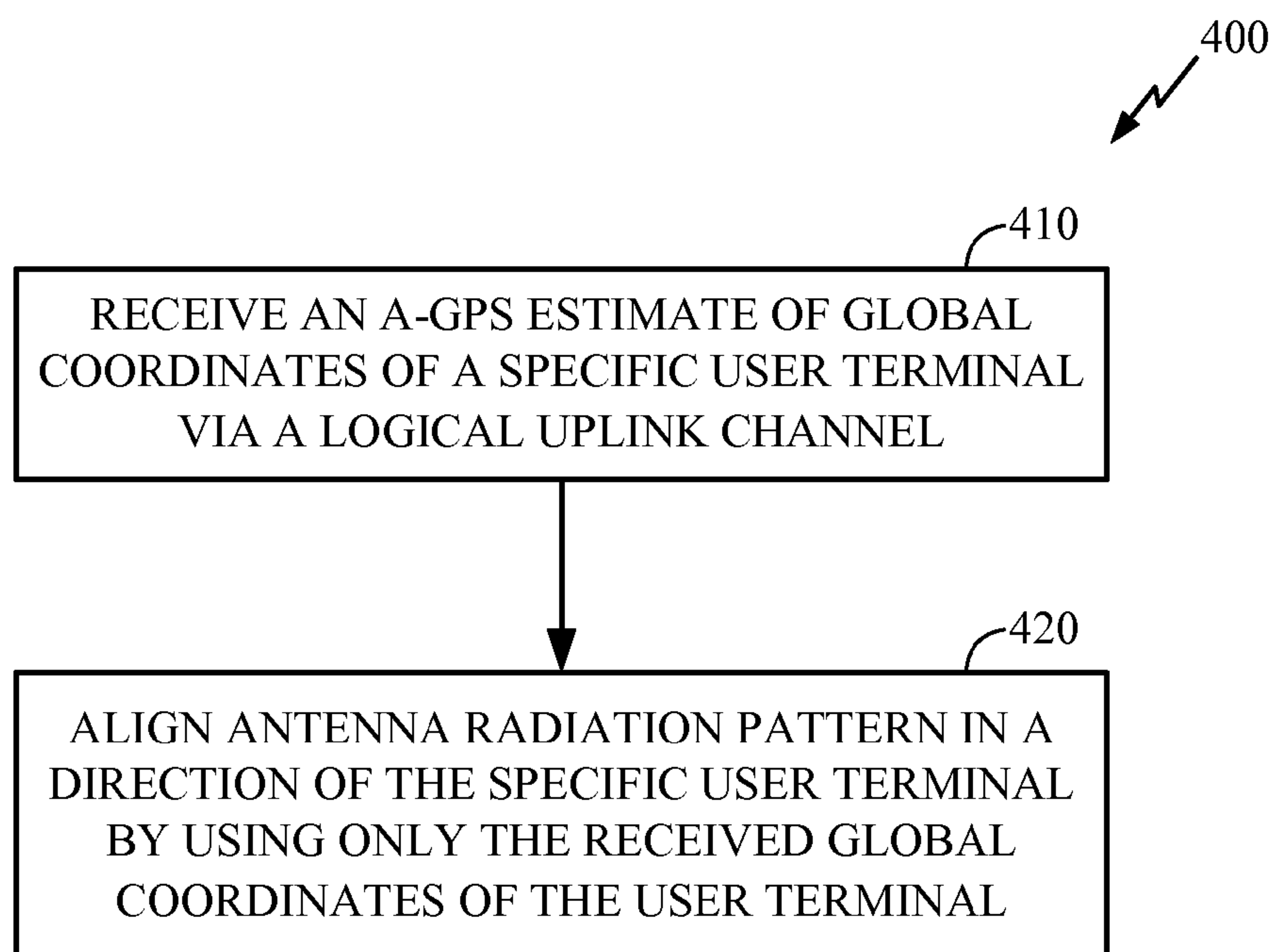

FIG. 4

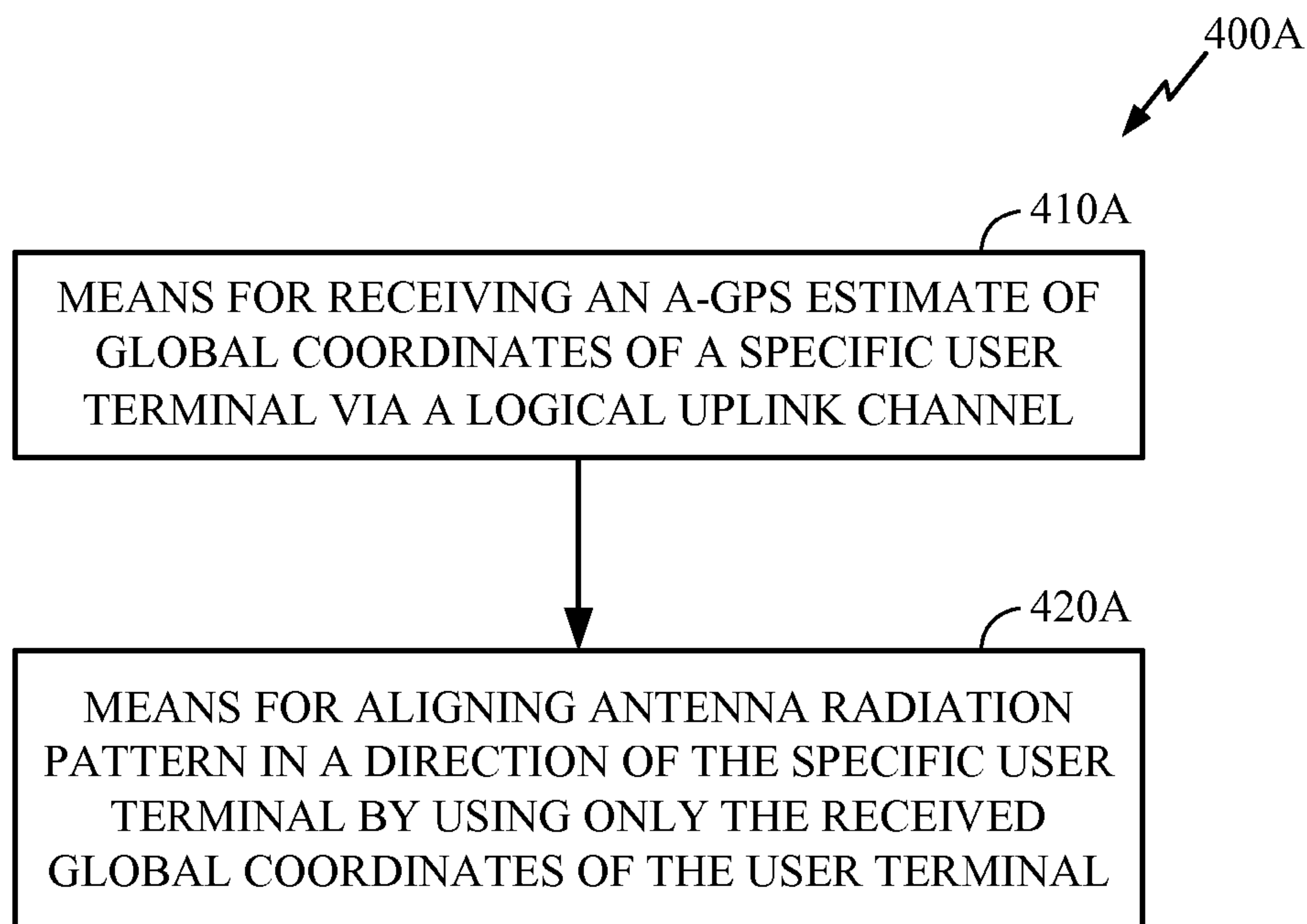

FIG. 4A

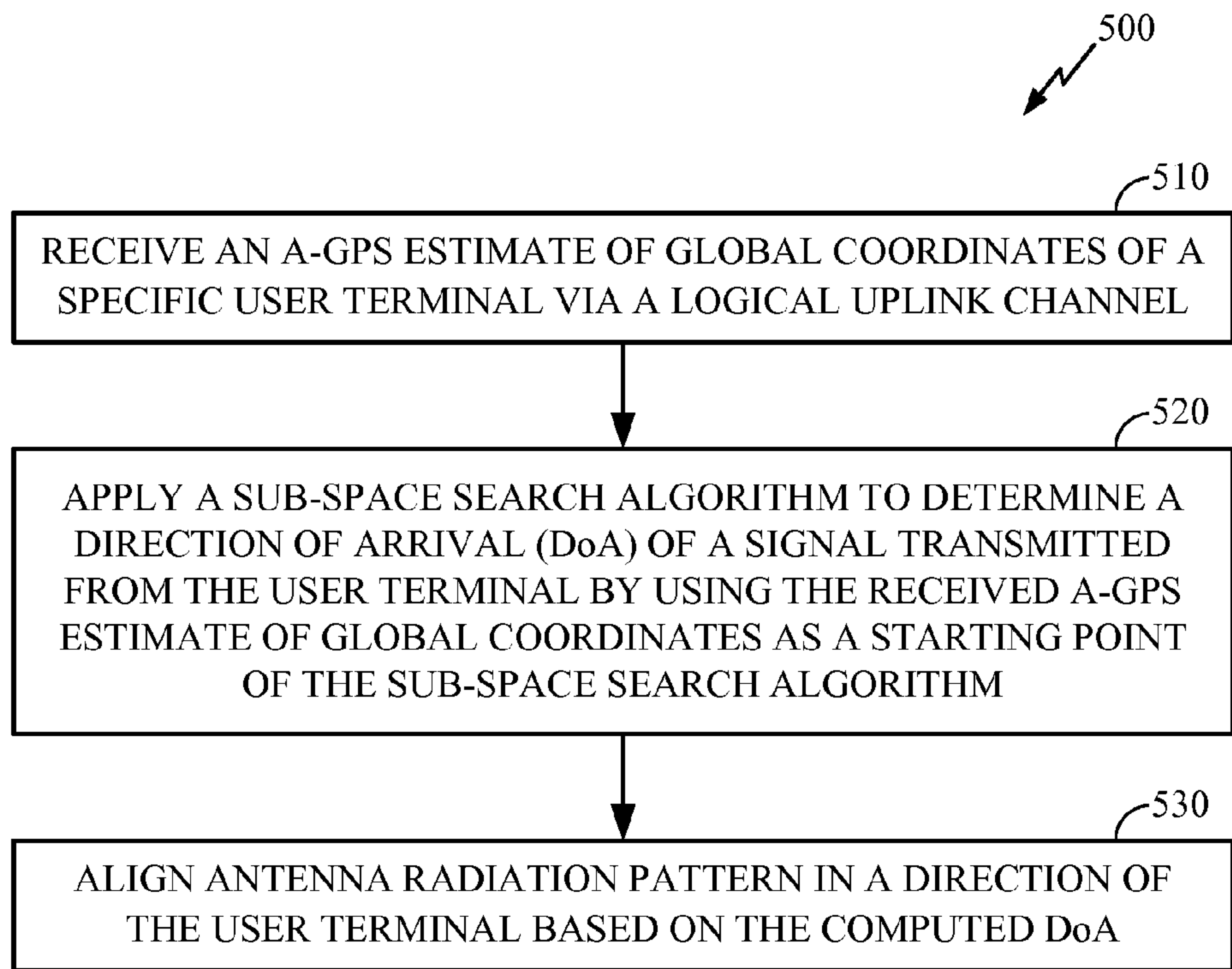

FIG. 5

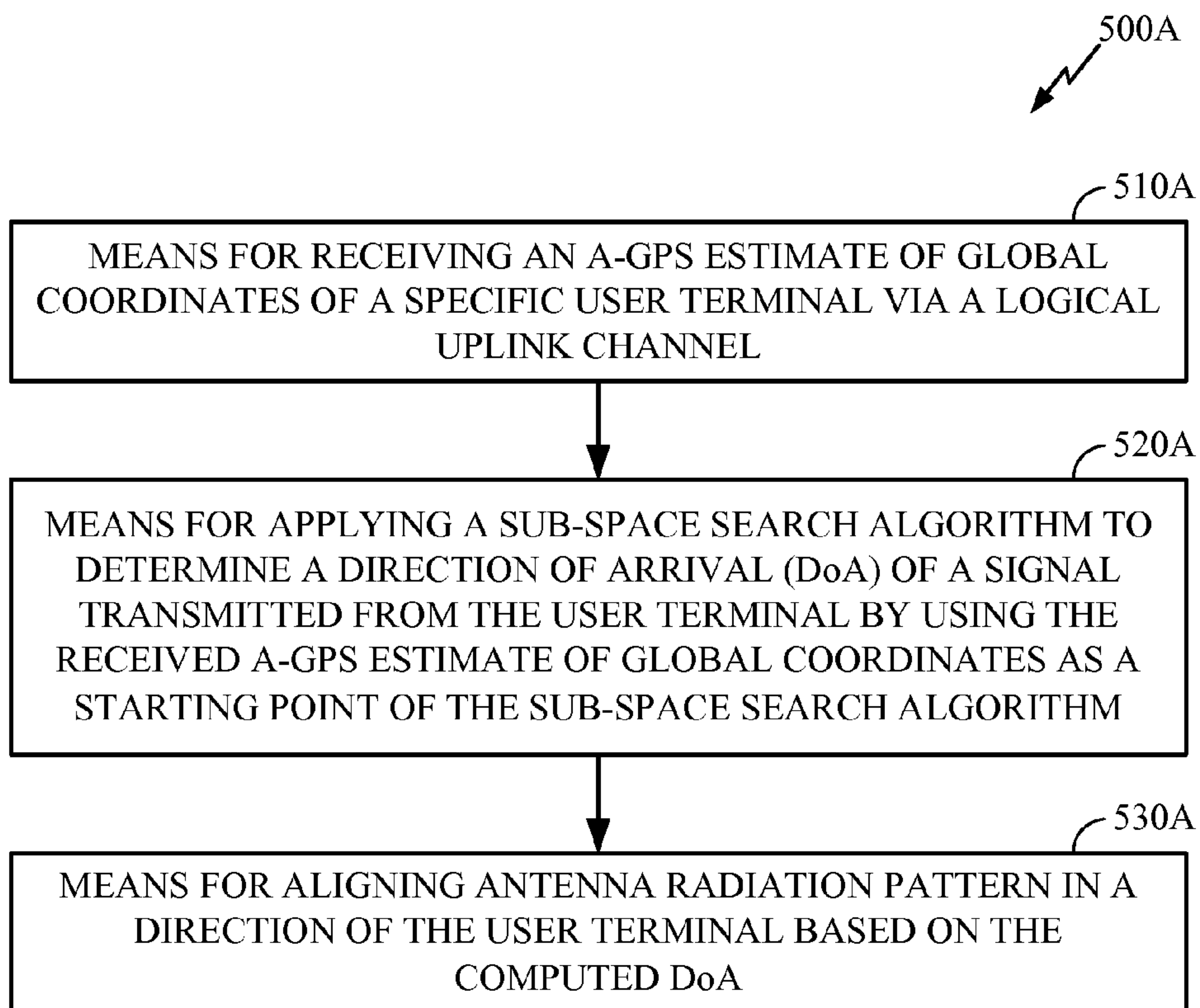

FIG. 5A

OPTIMIZATION FOR FINDING DIRECTION OF ARRIVAL IN SMART ANTENNAS

TECHNICAL FIELD

The present disclosure generally relates to wireless communication systems, and more specifically to a method for searching of a direction of arrival of a transmitted signal.

BACKGROUND

A smart antenna system exploits space diversity by employing an array of antennas whose radiation pattern can be aligned in a direction of arrival (DoA) of a specific signal to be detected. As a result, a Quality of Service (QoS) can be improved, co-channel interference can be reduced, and a capacity of the system can be increased.

Smart antennas can be installed on a base station side or on a user terminal side. When smart antennas are employed at the base station, a DoA of a desired signal transmitted from a source of interest (i.e., user terminal) needs to be determined. Once the DoA is computed, then a radiation pattern (beam) of smart antennas can be oriented in the desired direction using some beam forming technique instead of utilizing uniform radiation pattern. As the user terminal moves around the cell, the smart antenna system updates the DoA and aligns the radiation beam at the base station in the direction of the user terminal. On the other hand, when smart antennas are employed at the user terminal, it is required to determine a DoA of a signal transmitted from a serving base station.

In an exemplary case when smart antennas are implemented at the base station, a sub-space analysis algorithm can be applied at the base station in order to find the DoA of a signal transmitted from a specific user terminal, such as Multiple Signal Classification (MUSIC) algorithm or Estimation of Signal Parameters via Rotational Invariance Techniques (ESPRIT) algorithm. Both of these algorithms start searching from one point in space and search the entire space of interest. Computational complexity of these algorithms increases exponentially as the number of active user terminals in the system increases. Because of high computational complexity of sub-space searching algorithms, a special dedicated digital signal processor (DSP) can be required to be implemented at the base station for computing directions of arrivals of all served user terminals in the system. Moreover, these searching algorithms can have limited accuracy, especially if a large space needs to be examined.

Therefore, there is a need in the art for a method that simplifies search for a direction of arrival of a specific signal while providing sufficient accuracy.

SUMMARY

Certain embodiments of the present disclosure provide a method for a wireless device. The method generally includes receiving an Assisted Global Positioning System (A-GPS) estimate of global coordinates of an another wireless device, using the received A-GPS estimate of global coordinates to determine a direction of arrival (DoA) of a signal transmitted from the other wireless device, aligning an antenna radiation pattern at the wireless device based on the determined DoA, and communicating with the other wireless device using the aligned antenna radiation pattern.

Certain embodiments of the present disclosure provide an apparatus for a wireless device. The apparatus generally includes logic for receiving an Assisted Global Positioning System (A-GPS) estimate of global coordinates of an another

wireless device, logic for using the received A-GPS estimate of global coordinates to determine a direction of arrival (DoA) of a signal transmitted from the other wireless device, logic for aligning an antenna radiation pattern at the wireless device based on the determined DoA, and logic for communicating with the other wireless device using the aligned antenna radiation pattern.

Certain embodiments of the present disclosure provide an apparatus for a wireless device. The apparatus generally includes means for receiving an Assisted Global Positioning System (A-GPS) estimate of global coordinates of an another wireless device, means for using the received A-GPS estimate of global coordinates to determine a direction of arrival (DoA) of a signal transmitted from the other wireless device, means for aligning an antenna radiation pattern at the wireless device based on the determined DoA, and means for communicating with the other wireless device using the aligned antenna radiation pattern.

Certain embodiments of the present disclosure provide a computer-program product for a wireless device, comprising a computer readable medium having instructions stored thereon, the instructions being executable by one or more processors. The instructions generally include instructions for receiving an Assisted Global Positioning System (A-GPS) estimate of global coordinates of an another wireless device, instructions for using the received A-GPS estimate of global coordinates to determine a direction of arrival (DoA) of a signal transmitted from the other wireless device, instructions for aligning an antenna radiation pattern at the wireless device based on the determined DoA, and instructions for communicating with the other wireless device using the aligned antenna radiation pattern.

BRIEF DESCRIPTION OF THE DRAWINGS

So that the manner in which the above-recited features of the present disclosure can be understood in detail, a more particular description, briefly summarized above, may be had by reference to embodiments, some of which are illustrated in the appended drawings. It is to be noted, however, that the appended drawings illustrate only certain typical embodiments of this disclosure and are therefore not to be considered limiting of its scope, for the description may admit to other equally effective embodiments.

FIG. 1 illustrates an example wireless communication system, in accordance with certain embodiments of the present disclosure.

FIG. 2 illustrates various components that may be utilized in a wireless device in accordance with certain embodiments of the present disclosure.

FIG. 3 illustrates an example transmitter and an example receiver that may be used within a wireless communication system in accordance with certain embodiments of the present disclosure.

FIG. 4 illustrates example operations for determining a direction of arrival of a specific transmitted signal using only an Assisted Global Positioning System (A-GPS) estimate of global coordinates in accordance with certain embodiments of the present disclosure.

FIG. 4A illustrates example components capable of performing the operations illustrated in FIG. 4.

FIG. 5 illustrates example operations for determining a direction of arrival of a specific transmitted signal by using an A-GPS estimate of global coordinates as a starting point of a sub-space search algorithm in accordance with certain embodiments of the present disclosure.

FIG. 5A illustrates example components capable of performing the operations illustrated in FIG. 5.

DETAILED DESCRIPTION

The word “exemplary” is used herein to mean “serving as an example, instance, or illustration.” Any embodiment described herein as “exemplary” is not necessarily to be construed as preferred or advantageous over other embodiments.

An Example Wireless Communication System

The techniques described herein may be used for various broadband wireless communication systems, including communication systems that are based on an orthogonal multiplexing scheme. Examples of such communication systems include Orthogonal Frequency Division Multiple Access (OFDMA) systems, Single-Carrier Frequency Division Multiple Access (SC-FDMA) systems, and so forth. An OFDMA system utilizes orthogonal frequency division multiplexing (OFDM), which is a modulation technique that partitions the overall system bandwidth into multiple orthogonal sub-carriers. These sub-carriers may also be called tones, bins, etc. With OFDM, each sub-carrier may be independently modulated with data. An SC-FDMA system may utilize interleaved FDMA (IFDMA) to transmit on sub-carriers that are distributed across the system bandwidth, localized FDMA (LFDMA) to transmit on a block of adjacent sub-carriers, or enhanced FDMA (EFDMA) to transmit on multiple blocks of adjacent sub-carriers. In general, modulation symbols are sent in the frequency domain with OFDM and in the time domain with SC-FDMA.

One specific example of a communication system based on an orthogonal multiplexing scheme is a WiMAX system. WiMAX, which stands for the Worldwide Interoperability for Microwave Access, is a standards-based broadband wireless technology that provides high-throughput broadband connections over long distances. There are two main applications of WiMAX today: fixed WiMAX and mobile WiMAX. Fixed WiMAX applications are point-to-multipoint, enabling broadband access to homes and businesses, for example. Mobile WiMAX offers the full mobility of cellular networks at broadband speeds.

IEEE 802.16x is an emerging standard organization to define an air interface for fixed and mobile broadband wireless access (BWA) systems. IEEE 802.16x approved “IEEE P802.16d/D5-2004” in May 2004 for fixed BWA systems and published “IEEE P802.16e/D12 October 2005” in October 2005 for mobile BWA systems. The latest revision of the IEEE 802.16-2004, “IEEE P802.16Rev2/D8 December 2008”, a draft standard, now consolidates materials from IEEE 802.16e and corrigendum. The standards define four different physical layers (PHYs) and one medium access control (MAC) layer. The OFDM and OFDMA physical layer of the four physical layers are the most popular in the fixed and mobile BWA areas respectively.

FIG. 1 depicts various user terminals **106** dispersed throughout the system **100**. The user terminals **106** may be fixed (i.e., stationary) or mobile. The user terminals **106** may alternatively be referred to as remote stations, access terminals, terminals, subscriber units, mobile stations, stations, user equipment, etc. The user terminals **106** may be wireless devices, such as cellular phones, personal digital assistants (PDAs), handheld devices, wireless modems, laptop computers, personal computers, etc.

A variety of algorithms and methods may be used for transmissions in the wireless communication system **100**

between the base stations **104** and the user terminals **106**. For example, signals may be sent and received between the base stations **104** and the user terminals **106** in accordance with OFDM/OFDMA techniques. If this is the case, the wireless communication system **100** may be referred to as an OFDM/OFDMA system.

A communication link that facilitates transmission from a base station **104** to a user terminal **106** may be referred to as a downlink (DL) **108**, and a communication link that facilitates transmission from a user terminal **106** to a base station **104** may be referred to as an uplink (UL) **110**. Alternatively, a downlink **108** may be referred to as a forward link or a forward channel, and an uplink **110** may be referred to as a reverse link or a reverse channel.

A cell **102** may be divided into multiple sectors **112**. A sector **112** is a physical coverage area within a cell **102**. Base stations **104** within a wireless communication system **100** may utilize antennas that concentrate the flow of power within a particular sector **112** of the cell **102**. Such antennas may be referred to as directional antennas.

FIG. 2 illustrates various components that may be utilized in a wireless device **202** that may be employed within the wireless communication system **100**. The wireless device **202** is an example of a device that may be configured to implement the various methods described herein. The wireless device **202** may be a base station **104** or a user terminal **106**.

The wireless device **202** may include a processor **204** which controls operation of the wireless device **202**. The processor **204** may also be referred to as a central processing unit (CPU). Memory **206**, which may include both read-only memory (ROM) and random access memory (RAM), provides instructions and data to the processor **204**. A portion of the memory **206** may also include non-volatile random access memory (NVRAM). The processor **204** typically performs logical and arithmetic operations based on program instructions stored within the memory **206**. The instructions in the memory **206** may be executable to implement the methods described herein.

The wireless device **202** may also include a housing **208** that may include a transmitter **210** and a receiver **212** to allow transmission and reception of data between the wireless device **202** and a remote location. The transmitter **210** and receiver **212** may be combined into a transceiver **214**. A single or a plurality of transmit antennas **216** may be attached to the housing **208** and electrically coupled to the transceiver **214**. The wireless device **202** may also include (not shown) multiple transmitters, multiple receivers, and multiple transceivers.

The wireless device **202** may also include a signal detector **218** that may be used in an effort to detect and quantify the level of signals received by the transceiver **214**. The signal detector **218** may detect such signals as total energy, energy per subcarrier per symbol, power spectral density and other signals. The wireless device **202** may also include a digital signal processor (DSP) **220** for use in processing signals.

The various components of the wireless device **202** may be coupled together by a bus system **222**, which may include a power bus, a control signal bus, and a status signal bus in addition to a data bus.

FIG. 3 illustrates an example of a transmitter **302** that may be used within a wireless communication system **100** that utilizes OFDM/OFDMA. Portions of the transmitter **302** may be implemented in the transmitter **210** of a wireless device **202**. The transmitter **302** may be implemented in a base station **104** for transmitting data **306** to a user terminal **106** on a downlink **108**. The transmitter **302** may also be imple-

mented in a user terminal **106** for transmitting data **306** to a base station **104** on an uplink **110**.

Data **306** to be transmitted is shown being provided as input to a serial-to-parallel (S/P) converter **308**. The S/P converter **308** may split the transmission data into M parallel data streams **310**.

The M parallel data streams **310** may then be provided as input to a mapper **312**. The mapper **312** may map the M parallel data streams **310** onto M constellation points. The mapping may be done using some modulation constellation, such as binary phase-shift keying (BPSK), quadrature phase-shift keying (QPSK), 8 phase-shift keying (8PSK), quadrature amplitude modulation (QAM), etc. Thus, the mapper **312** may output M parallel symbol streams **316**, each symbol stream **316** corresponding to one of the M orthogonal subcarriers of the inverse fast Fourier transform (IFFT) **320**. These M parallel symbol streams **316** are represented in the frequency domain and may be converted into M parallel time domain sample streams **318** by an IFFT component **320**.

A brief note about terminology will now be provided. M parallel modulations in the frequency domain are equal to M modulation symbols in the frequency domain, which are equal to M mapping and M-point IFFT in the frequency domain, which is equal to one (useful) OFDM symbol in the time domain, which is equal to M samples in the time domain. One OFDM symbol in the time domain, N_{gs} , is equal to N_{CP} (the number of guard samples per OFDM symbol)+M (the number of useful samples per OFDM symbol).

The M parallel time domain sample streams **318** may be converted into an OFDM/OFDMA symbol stream **322** by a parallel-to-serial (P/S) converter **324**. A guard insertion component **326** may insert a guard interval between successive OFDM/OFDMA symbols in the OFDM/OFDMA symbol stream **322**. The signal from the guard insertion component **326** may then be input into demultiplexer **340** to generate different data streams for a plurality of transmit antennas (or equivalently, spatial subchannels). After that, the base-band data stream for each antenna can be upconverted to a desired transmit frequency band by a radio frequency (RF) front end **328**, and the antenna array **330** may then transmit the resulting signal **332** across multiple spatial subchannels **334**.

FIG. 3 also illustrates an example of a receiver **304** that may be used within a wireless device **202** that utilizes OFDM/OFDMA. Portions of the receiver **304** may be implemented in the receiver **212** of a wireless device **202**. The receiver **304** may be implemented in a user terminal **106** for receiving data **306** from a base station **104** on a downlink **108**. The receiver **304** may also be implemented in a base station **104** for receiving data **306** from a user terminal **106** on an uplink **110**.

The transmitted signal **332** is shown traveling over a plurality of spatial subchannels **334**. When a signal **332'** is received by the antenna array **330'**, the received signal **332'** may be downconverted to a baseband signal by an RF front end **328'** and converted into a single stream by multiplexer **340'**. A guard removal component **326'** may then remove the guard interval that was inserted between OFDM/OFDMA symbols by the guard insertion component **326**.

The output of the guard removal component **326'** may be provided to an S/P converter **324'**. The S/P converter **324'** may divide the OFDM/OFDMA symbol stream **322'** into the M parallel time-domain symbol streams **318'**, each of which corresponds to one of the M orthogonal subcarriers. A fast Fourier transform (FFT) component **320'** may convert the M parallel time-domain symbol streams **318'** into the frequency domain and output M parallel frequency-domain symbol streams **316'**.

A demapper **312'** may perform the inverse of the symbol mapping operation that was performed by the mapper **312** thereby outputting M parallel data streams **310'**. A P/S converter **308'** may combine the M parallel data streams **310'** into a single data stream **306'**. Ideally, this data stream **306'** corresponds to the data **306** that was provided as input to the transmitter **302**. Note that elements **308'**, **310'**, **312'**, **316'**, **320'**, **318'** and **324'** may all be found in a baseband processor **350'**.

For certain embodiments of the present disclosure, the wireless system **100** can be considered to be a smart antenna system. The smart antenna system employs an array of antennas whose radiation pattern can be aligned in a direction of arrival (DoA) of a receiving signal to be decoded. Smart antennas can be installed on the base station **104** and/or on the user terminal **106**. In order to properly align radiation pattern of smart antennas for maximizing strength of a specific receive signal, it is required to determine the DoA of this signal. The present disclosure proposes methods for computationally efficient and accurate searching for the DoA. The proposed methods utilize Assisted Global Positioning System (A-GPS) estimates of global coordinates that may be available at any wireless device. The A-GPS estimate may be even available inside a house or in a deep tunnel.

Efficient Methods for Finding Direction of Arrival

FIG. 4 illustrates example operations **400** that may be applied at a base station to determine a DoA of a signal transmitted from a specific user terminal using only an A-GPS estimate of user terminal's global coordinates. At **410**, the base station may receive the A-GPS estimate of global coordinates of the specific user terminal via a logical uplink channel. After receiving the A-GPS estimate of global coordinates, the base station may directly use these coordinates in order to align its antenna radiation pattern in the direction of the user terminal (i.e. to beam-form in the direction of the user terminal), at **420**.

For certain embodiments of the present disclosure, smart antennas can be also installed at a user terminal. In this case, a serving base station may send its A-GPS estimate of global coordinates to the served user terminal, and then, based on these global coordinates, the user terminal can align its antenna radiation pattern in the direction of the base station.

By applying the proposed method, installation at the base station and/or user terminal of any special DoA computation processor may not be required. Furthermore, errors in determining DoA using known sub-space search algorithms can be avoided.

The accuracy of locating the specific user terminal may be further improved at the base station if the A-GPS estimate of user terminal's global coordinates is utilized as a starting point of the search in the sub-space search algorithms, such as MUSIC and ESPRIT algorithms. As a result, the DoA search algorithms may determine a location of the specific user terminal with smaller computational complexity and with improved accuracy.

FIG. 5 illustrates example operations **500** that may be applied at the base station to determine a DoA of a signal transmitted from the specific user terminal by employing A-GPS estimate of user terminal's global coordinates as a starting point of a sub-space search algorithm. At **510**, the base station may receive the A-GPS estimate of global coordinates of the specific user terminal via a logical uplink channel. At **520**, the base station may apply the sub-space search algorithm to determine the DoA of the signal transmitted from the specific user terminal by using the received A-GPS

estimate of user terminal's global coordinates as a starting point of the DoA search algorithm. Once the location of the specific user terminal is determined, the base station may align its antenna radiation pattern in the direction of the specific user terminal (i.e. to beam-form in the direction of the specific user terminal), at **530**.

Certain embodiments of the present disclosure support installation of smart antennas at a user terminal. In this case, a serving base station may send its A-GPS estimate of global coordinates to the served user terminal. The user terminal may use the received A-GPS estimate as a starting point of a sub-space search algorithm. Once the location of the serving base station is determined, the user terminal may align its antenna radiation pattern in the direction of the base station.

The various operations of methods described above may be performed by various hardware and/or software component (s) and/or module(s) corresponding to means-plus-function blocks illustrated in the Figures. For example, blocks **410-420** illustrated in FIG. **4** correspond to means-plus-function blocks **410A-420A** illustrated in FIG. **4A**. Similarly, blocks **510-530** illustrated in FIG. **5** correspond to means-plus-function blocks **510A-530A** illustrated in FIG. **5A**. More generally, where there are methods illustrated in Figures having corresponding counterpart means-plus-function Figures, the operation blocks correspond to means-plus-function blocks with similar numbering.

The various illustrative logical blocks, modules and circuits described in connection with the present disclosure may be implemented or performed with a general purpose processor, a digital signal processor (DSP), an application specific integrated circuit (ASIC), a field programmable gate array signal (FPGA) or other programmable logic device (PLD), discrete gate or transistor logic, discrete hardware components or any combination thereof designed to perform the functions described herein. A general purpose processor may be a microprocessor, but in the alternative, the processor may be any commercially available processor, controller, microcontroller or state machine. A processor may also be implemented as a combination of computing devices, e.g., a combination of a DSP and a microprocessor, a plurality of microprocessors, one or more microprocessors in conjunction with a DSP core, or any other such configuration.

The steps of a method or algorithm described in connection with the present disclosure may be embodied directly in hardware, in a software module executed by a processor, or in a combination of the two. A software module may reside in any form of storage medium that is known in the art. Some examples of storage media that may be used include random access memory (RAM), read only memory (ROM), flash memory, EPROM memory, EEPROM memory, registers, a hard disk, a removable disk, a CD-ROM and so forth. A software module may comprise a single instruction, or many instructions, and may be distributed over several different code segments, among different programs, and across multiple storage media. A storage medium may be coupled to a processor such that the processor can read information from, and write information to, the storage medium. In the alternative, the storage medium may be integral to the processor.

The methods disclosed herein comprise one or more steps or actions for achieving the described method. The method steps and/or actions may be interchanged with one another without departing from the scope of the claims. In other words, unless a specific order of steps or actions is specified, the order and/or use of specific steps and/or actions may be modified without departing from the scope of the claims.

The functions described may be implemented in hardware, software, firmware or any combination thereof. If imple-

mented in software, the functions may be stored as one or more instructions on a computer-readable medium. A storage media may be any available media that can be accessed by a computer. By way of example, and not limitation, such computer-readable media can comprise RAM, ROM, EEPROM, CD-ROM or other optical disk storage, magnetic disk storage or other magnetic storage devices, or any other medium that can be used to carry or store desired program code in the form of instructions or data structures and that can be accessed by a computer. Disk and disc, as used herein, include compact disc (CD), laser disc, optical disc, digital versatile disc (DVD), floppy disk, and Blu-ray® disc where disks usually reproduce data magnetically, while discs reproduce data optically with lasers.

Software or instructions may also be transmitted over a transmission medium. For example, if the software is transmitted from a website, server, or other remote source using a coaxial cable, fiber optic cable, twisted pair, digital subscriber line (DSL), or wireless technologies such as infrared, radio, and microwave, then the coaxial cable, fiber optic cable, twisted pair, DSL, or wireless technologies such as infrared, radio, and microwave are included in the definition of transmission medium.

Further, it should be appreciated that modules and/or other appropriate means for performing the methods and techniques described herein can be downloaded and/or otherwise obtained by a user terminal and/or base station as applicable. For example, such a device can be coupled to a server to facilitate the transfer of means for performing the methods described herein. Alternatively, various methods described herein can be provided via storage means (e.g., RAM, ROM, a physical storage medium such as a compact disc (CD) or floppy disk, etc.), such that a user terminal and/or base station can obtain the various methods upon coupling or providing the storage means to the device. Moreover, any other suitable technique for providing the methods and techniques described herein to a device can be utilized.

It is to be understood that the claims are not limited to the precise configuration and components illustrated above. Various modifications, changes and variations may be made in the arrangement, operation and details of the methods and apparatus described above without departing from the scope of the claims.

The invention claimed is:

1. A method for a wireless device, comprising:
 - receiving an Assisted Global Positioning System (A-GPS) estimate of global coordinates of an another wireless device;
 - using the received A-GPS estimate of global coordinates to determine a direction of arrival (DoA) of a signal transmitted from the other wireless device, wherein the received A-GPS estimate of global coordinates is used as a starting point of a sub-space search algorithm to determine the DoA of the signal transmitted from the other wireless device;
 - aligning an antenna radiation pattern at the wireless device based on the determined DoA; and
 - communicating with the other wireless device using the aligned antenna radiation pattern.
2. The method of claim 1, wherein receiving the A-GPS estimate of global coordinates of the other wireless device comprises receiving the A-GPS estimate of global coordinates via a logical channel.
3. The method of claim 1, wherein the wireless device is a base station, and wherein the other wireless device is a user terminal.

4. The method of claim 1, wherein the wireless device is a user terminal and the other wireless device is a base station.

5. The method of claim 1, wherein a plurality of antennas is used at the wireless device and at the other wireless device.

6. The method of claim 1, wherein the antenna radiation pattern is a beam pattern.

7. An apparatus for a wireless device, comprising:
logic for receiving an Assisted Global Positioning System (A-GPS) estimate of global coordinates of another wireless device;

logic for using the received A-GPS estimate of global coordinates to determine a direction of arrival (DoA) of a signal transmitted from the other wireless device, wherein the received A-GPS estimate of global coordinates is used as a starting point of a sub-space search algorithm to determine the DoA of the signal transmitted from the other wireless device;

logic for aligning an antenna radiation pattern at the wireless device based on the determined DoA; and

logic for communicating with the other wireless device using the aligned antenna radiation pattern.

8. The apparatus of claim 7, wherein the logic for receiving the A-GPS estimate of global coordinates of the other wireless device comprises logic for receiving the A-GPS estimate of global coordinates via a logical channel.

9. The apparatus of claim 7, wherein the wireless device is a base station, and wherein the other wireless device is a user terminal.

10. The apparatus of claim 7, wherein the wireless device is a user terminal and the other wireless device is a base station.

11. The apparatus of claim 7, wherein a plurality of antennas is used at the wireless device and at the other wireless device.

12. The apparatus of claim 7, wherein the antenna radiation pattern is a beam pattern.

13. An apparatus for a wireless device, comprising:
means for receiving an Assisted Global Positioning System (A-GPS) estimate of global coordinates of another wireless device;

means for using the received A-GPS estimate of global coordinates to determine a direction of arrival (DoA) of a signal transmitted from the other wireless device, wherein the received A-GPS estimate of global coordinates is used as a starting point of a sub-space search algorithm to determine the DoA of the signal transmitted from the other wireless device;

means for aligning an antenna radiation pattern at the wireless device based on the determined DoA; and

means for communicating with the other wireless device using the aligned antenna radiation pattern.

14. The apparatus of claim 13, wherein the means for receiving the A-GPS estimate of global coordinates of the other wireless device comprises means for receiving the A-GPS estimate of global coordinates via a logical channel.

15. The apparatus of claim 13, wherein the wireless device is a base station, and wherein the other wireless device is a user terminal.

16. The apparatus of claim 13, wherein the wireless device is a user terminal and the other wireless device is a base station.

17. The apparatus of claim 13, wherein a plurality of antennas is used at the wireless device and at the other wireless device.

18. The apparatus of claim 13, wherein the antenna radiation pattern is a beam pattern.

19. A computer-program product for a wireless device, comprising a computer readable medium having instructions stored thereon, the instructions being executable by one or more processors and the instructions comprising:

instructions for receiving an Assisted Global Positioning System (A-GPS) estimate of global coordinates of another wireless device;

instructions for using the received A-GPS estimate of global coordinates to determine a direction of arrival (DoA) of a signal transmitted from the other wireless device, wherein the received A-GPS estimate of global coordinates is used as a starting point of a sub-space search algorithm to determine the DoA of the signal transmitted from the other wireless device;

instructions for aligning an antenna radiation pattern at the wireless device based on the determined DoA; and
instructions for communicating with the other wireless device using the aligned antenna radiation pattern.

20. The computer-program product of claim 19, wherein the instructions for receiving the A-GPS estimate of global coordinates of the other wireless device comprise instructions for receiving the A-GPS estimate of global coordinates via a logical channel.

21. The computer-program product of claim 19, wherein the wireless device is a base station, and wherein the other wireless device is a user terminal.

22. The computer-program product of claim 19, wherein the wireless device is a user terminal and the other wireless device is a base station.

23. The computer-program product of claim 19, wherein a plurality of antennas is used at the wireless device and at the other wireless device.

24. The computer-program product of claim 19, wherein the antenna radiation pattern is a beam pattern.