



US008025112B2

(12) **United States Patent**
Mirchandani et al.

(10) **Patent No.:** **US 8,025,112 B2**
(45) **Date of Patent:** **Sep. 27, 2011**

(54) **EARTH-BORING BITS AND OTHER PARTS INCLUDING CEMENTED CARBIDE**

(75) Inventors: **Prakash K. Mirchandani**, Houston, TX (US); **Morris E. Chandler**, Santa Fe, TX (US); **Michale E. Waller**, Huntsville, AL (US); **Heath C. Coleman**, Union Grove, AL (US)

(73) Assignee: **TDY Industries, Inc.**, Pittsburgh, PA (US)

2,093,742 A	9/1937	Staples
2,093,986 A	9/1937	Staples
2,246,237 A	6/1941	Benninghoff
2,283,280 A	5/1942	Nell
2,299,207 A	10/1942	Bevillard
2,422,994 A	6/1947	Taylor
2,819,958 A	1/1958	Abkowitz et al.
2,819,959 A	1/1958	Abkowitz et al.
2,906,654 A	9/1959	Abkowitz
2,954,570 A	10/1960	Couch
3,041,641 A	7/1962	Hradek et al.
3,093,850 A	6/1963	Kelso

(Continued)

(*) Notice: Subject to any disclaimer, the term of this patent is extended or adjusted under 35 U.S.C. 154(b) by 270 days.

FOREIGN PATENT DOCUMENTS

AU 695583 2/1998

(Continued)

(21) Appl. No.: **12/196,815**

(22) Filed: **Aug. 22, 2008**

OTHER PUBLICATIONS

Advisory Action mailed Jun. 29, 2009 in U.S. Appl. No. 10/903,198.

(65) **Prior Publication Data**

US 2010/0044114 A1 Feb. 25, 2010

(Continued)

(51) **Int. Cl.**
E21B 10/46 (2006.01)

(52) **U.S. Cl.** **175/374**; 175/425; 428/614; 428/698

(58) **Field of Classification Search** 175/374,
175/425; 428/614, 698

See application file for complete search history.

Primary Examiner — Giovanna C Wright

(74) *Attorney, Agent, or Firm* — K & L Gates LLP; Patrick J. Viccaro; John E. Grosselin, III

(56) **References Cited**

U.S. PATENT DOCUMENTS

1,509,438 A	9/1924	Miller
1,530,293 A	3/1925	Breitenstein
1,808,138 A	6/1931	Hogg et al.
1,811,802 A	6/1931	Newman
1,912,298 A	5/1933	Newman
2,054,028 A	9/1936	Benninghoff
2,093,507 A	9/1937	Bartek

(57) **ABSTRACT**

An article of manufacture includes a cemented carbide piece and a joining phase that binds the cemented carbide piece into the article. The joining phase includes inorganic particles and a matrix material. The matrix material is a metal and a metallic alloy. The melting temperature of the inorganic particles is higher than the melting temperature of the matrix material. A method includes infiltrating the space between the inorganic particles and the cemented carbide piece with a molten metal or metal alloy followed by solidification of the metal or metal alloy to form an article of manufacture.

70 Claims, 13 Drawing Sheets

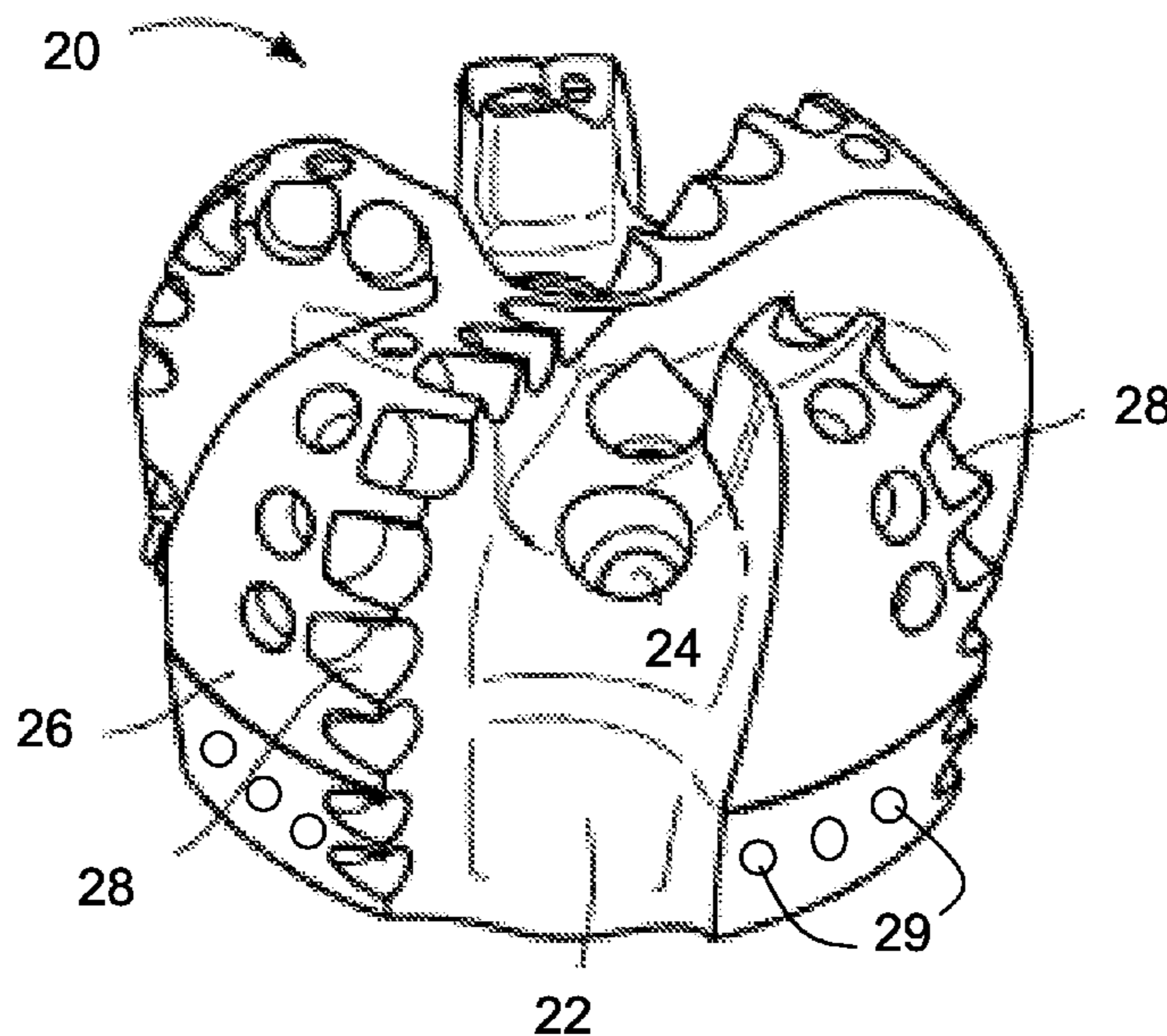

US 8,025,112 B2

U.S. PATENT DOCUMENTS							
3,368,881	A	2/1968	Abkowitz et al.	4,861,350	A	8/1989	Phaal et al.
3,471,921	A	10/1969	Feenstra	4,871,377	A	10/1989	Frushour
3,490,901	A	1/1970	Hachisuka et al.	4,884,477	A	12/1989	Smith et al.
3,581,835	A	6/1971	Stebley	4,889,017	A	12/1989	Fuller et al.
3,629,887	A	12/1971	Urbanic	4,899,838	A	2/1990	Sullivan et al.
3,660,050	A	5/1972	Iler et al.	4,919,013	A	4/1990	Smith et al.
3,757,879	A	9/1973	Wilder et al.	4,923,512	A	5/1990	Timm et al.
3,776,655	A	12/1973	Urbanic	4,956,012	A	9/1990	Jacobs et al.
3,782,848	A	1/1974	Pfeifer	4,968,348	A	11/1990	Abkowitz et al.
3,806,270	A	4/1974	Tanner et al.	4,991,670	A	2/1991	Fuller et al.
3,812,548	A	5/1974	Theuerkaue	5,000,273	A	3/1991	Horton et al.
RE28,645	E	12/1975	Aoki et al.	5,030,598	A	7/1991	Hsieh
3,942,954	A	3/1976	Frehn	5,032,352	A	7/1991	Meeks et al.
3,987,859	A	10/1976	Lichte	5,041,261	A	8/1991	Buljan et al.
4,009,027	A	2/1977	Naidich et al.	5,049,450	A	9/1991	Dorfman et al.
4,017,480	A	4/1977	Baum	RE33,753	E	11/1991	Vacchiano et al.
4,047,828	A	9/1977	Makely	5,067,860	A	11/1991	Kobayashi et al.
4,094,709	A	6/1978	Rozmus	5,090,491	A	2/1992	Tibbitts et al.
4,097,180	A	6/1978	Kwieraga	5,092,412	A	3/1992	Walk
4,097,275	A	6/1978	Horvath	5,110,687	A	5/1992	Abe et al.
4,106,382	A	8/1978	Salje et al.	5,112,162	A	5/1992	Hartford et al.
4,126,652	A	11/1978	Oohara et al.	5,112,168	A	5/1992	Glimpel
4,128,136	A	12/1978	Generoux	5,116,659	A	5/1992	Glatzle et al.
4,170,499	A	10/1979	Thomas et al.	5,127,776	A	7/1992	Glimpel
4,198,233	A	4/1980	Frehn	5,161,898	A	11/1992	Drake
4,221,270	A	9/1980	Vezirian	5,174,700	A	12/1992	Sgarbi et al.
4,229,638	A	10/1980	Lichte	5,179,772	A	1/1993	Braun et al.
4,233,720	A	11/1980	Rozmus	5,186,739	A	2/1993	Isobe et al.
4,255,165	A	3/1981	Dennis et al.	5,203,513	A	4/1993	Keller et al.
4,270,952	A	6/1981	Kobayashi	5,203,932	A	4/1993	Kato et al.
4,277,106	A	7/1981	Sahley	5,232,522	A	8/1993	Doktycz et al.
4,306,139	A	12/1981	Shinozaki et al.	5,266,415	A	11/1993	Newkirk et al.
4,311,490	A	1/1982	Bovenkerk et al.	5,273,380	A	12/1993	Musacchia
4,325,994	A	4/1982	Kitashima et al.	5,281,260	A	1/1994	Kumar et al.
4,327,156	A	4/1982	Dillon et al.	5,286,685	A	2/1994	Schoennahl et al.
4,341,557	A	7/1982	Lizenby	5,305,840	A	4/1994	Liang et al. 175/426
4,389,952	A	6/1983	Dreier et al.	5,311,958	A	5/1994	Isbell et al.
4,396,321	A	8/1983	Holmes	5,326,196	A	7/1994	Noll
4,398,952	A	8/1983	Drake	5,333,520	A	8/1994	Fischer et al.
4,478,297	A	10/1984	Radtke	5,348,806	A	9/1994	Kojo et al.
4,499,048	A	2/1985	Hanejko	5,359,772	A	11/1994	Carlsson et al.
4,499,795	A	2/1985	Radtke	5,373,907	A	12/1994	Weaver
4,526,748	A	7/1985	Rozmus	5,376,329	A	12/1994	Morgan et al.
4,547,104	A	10/1985	Holmes	5,423,899	A	6/1995	Krall et al.
4,547,337	A	10/1985	Rozmus	5,433,280	A	7/1995	Smith
4,550,532	A	11/1985	Fletcher, Jr. et al.	5,443,337	A	8/1995	Katayama
4,552,232	A	11/1985	Frear	5,452,771	A	9/1995	Blackman et al.
4,553,615	A	11/1985	Grainger	5,467,669	A	11/1995	Stroud
4,554,130	A	11/1985	Ecer	5,479,997	A	1/1996	Scott et al.
4,562,990	A	1/1986	Rose	5,480,272	A	1/1996	Jorgensen et al.
4,574,011	A	3/1986	Bonjour et al.	5,482,670	A	1/1996	Hong
4,587,174	A	5/1986	Yoshimura et al.	5,484,468	A	1/1996	Östlund et al.
4,592,685	A	6/1986	Beere	5,487,626	A	1/1996	Von Holst et al.
4,596,694	A	6/1986	Rozmus	5,496,137	A	3/1996	Ochayon et al.
4,597,730	A	7/1986	Rozmus	5,505,748	A	4/1996	Tank et al.
4,604,106	A	8/1986	Hall 51/293	5,506,055	A	4/1996	Dorfman et al.
4,605,343	A	8/1986	Hibbs, Jr. et al.	5,518,077	A	5/1996	Blackman et al.
4,609,577	A	9/1986	Long	5,525,134	A	6/1996	Mehrotra et al.
4,630,693	A	12/1986	Goodfellow	5,541,006	A	7/1996	Conley
4,642,003	A	2/1987	Yoshimura	5,543,235	A	8/1996	Mirchandani et al.
4,649,086	A	3/1987	Johnson	5,544,550	A	8/1996	Smith
4,656,002	A	4/1987	Lizenby et al.	5,560,440	A	10/1996	Tibbitts
4,662,461	A	5/1987	Garrett	5,570,978	A	11/1996	Rees et al.
4,667,756	A	5/1987	King et al.	5,580,666	A	12/1996	Dubensky et al.
4,686,080	A	8/1987	Hara et al.	5,586,612	A	12/1996	Isbell et al.
4,686,156	A	8/1987	Baldoni, II et al.	5,590,729	A	1/1997	Cooley et al.
4,694,919	A	9/1987	Barr	5,593,474	A	1/1997	Keshavan et al.
4,708,542	A	11/1987	Emanuelli	5,601,857	A	2/1997	Friedrichs
4,722,405	A	2/1988	Langford	5,603,075	A	2/1997	Stoll et al.
4,729,789	A	3/1988	Ide et al.	5,609,447	A	3/1997	Britzke et al.
4,743,515	A	5/1988	Fischer et al.	5,611,251	A	3/1997	Katayama
4,744,943	A	5/1988	Timm	5,612,264	A	3/1997	Nilsson et al.
4,749,053	A	6/1988	Hollingshead	5,628,837	A	5/1997	Britzke et al.
4,752,159	A	6/1988	Howlett	RE35,538	E	6/1997	Akesson et al.
4,752,164	A	6/1988	Leonard, Jr.	5,635,247	A	6/1997	Ruppi
4,779,440	A	10/1988	Cleve et al.	5,641,251	A	6/1997	Leins et al.
4,809,903	A	3/1989	Eylon et al.	5,641,921	A	6/1997	Dennis et al.
4,838,366	A	6/1989	Jones	5,662,183	A	9/1997	Fang
				5,665,431	A	9/1997	Narasimhan

US 8,025,112 B2

5,666,864 A	9/1997	Tibbitts	6,499,920 B2	12/2002	Sawabe
5,677,042 A	10/1997	Massa et al.	6,500,226 B1	12/2002	Dennis
5,679,445 A	10/1997	Massa et al.	6,502,623 B1	1/2003	Schmitt
5,686,119 A	11/1997	McNaughton, Jr.	6,511,265 B1	1/2003	Mirchandani et al.
5,697,042 A	12/1997	Massa et al.	6,544,308 B2	4/2003	Griffin et al.
5,697,046 A	12/1997	Conley	6,562,462 B2	5/2003	Griffin et al.
5,697,462 A	12/1997	Grimes et al.	6,576,182 B1	6/2003	Ravagni et al.
5,718,948 A	2/1998	Ederyd et al.	6,585,064 B2	7/2003	Griffin et al.
5,732,783 A	3/1998	Truax et al.	6,589,640 B2	7/2003	Griffin et al.
5,733,649 A	3/1998	Kelley et al.	6,599,467 B1	7/2003	Yamaguchi et al.
5,733,664 A	3/1998	Kelley et al.	6,607,693 B1	8/2003	Saito et al.
5,750,247 A	5/1998	Bryant et al.	6,620,375 B1	9/2003	Tank et al.
5,753,160 A	5/1998	Takeuchi et al.	6,638,609 B2	10/2003	Nordgren et al.
5,755,033 A	5/1998	Günter et al.	6,655,481 B2	12/2003	Findley et al.
5,762,843 A	6/1998	Massa et al.	6,685,880 B2	2/2004	Engström et al.
5,765,095 A	6/1998	Flak et al.	6,688,988 B2	2/2004	McClure
5,776,593 A	7/1998	Massa et al.	6,695,551 B2	2/2004	Silver
5,778,301 A	7/1998	Hong	6,706,327 B2	3/2004	Blomstedt et al.
5,789,686 A	8/1998	Massa et al.	6,719,074 B2	4/2004	Tsuda et al.
5,792,403 A	8/1998	Massa et al.	6,737,178 B2	5/2004	Ota et al.
5,806,934 A	9/1998	Massa et al.	6,742,608 B2	6/2004	Murdoch
5,830,256 A	11/1998	Northrop et al.	6,742,611 B1	6/2004	Illerhaus et al.
5,851,094 A	12/1998	Strand et al.	6,756,009 B2	6/2004	Sim et al.
5,856,626 A	1/1999	Fischer et al.	6,764,555 B2	7/2004	Hiramatsu et al.
5,863,640 A	1/1999	Ljungberg et al.	6,766,870 B2	7/2004	Overstreet
5,865,571 A	2/1999	Tankala et al.	6,808,821 B2	10/2004	Fujita et al.
5,873,684 A	2/1999	Flolo	6,844,085 B2	1/2005	Takayama et al.
5,880,382 A	3/1999	Fang et al.	6,848,521 B2	2/2005	Lockstedt et al.
5,890,852 A	4/1999	Gress	6,849,231 B2	2/2005	Kojima et al.
5,897,830 A	4/1999	Abkowitz et al.	6,899,495 B2	5/2005	Hansson et al.
5,947,660 A	9/1999	Karlsson et al.	6,918,942 B2	7/2005	Hatta et al.
5,957,006 A	9/1999	Smith	6,948,890 B2	9/2005	Svensson et al.
5,963,775 A	10/1999	Fang	6,949,148 B2	9/2005	Sugiyama et al.
5,964,555 A	10/1999	Strand	6,955,233 B2	10/2005	Crowe et al.
5,967,249 A	10/1999	Butcher	6,958,099 B2	10/2005	Nakamura et al.
5,971,670 A	10/1999	Pantzar et al.	7,014,719 B2	3/2006	Suzuki et al.
5,988,953 A	11/1999	Berglund et al.	7,014,720 B2	3/2006	Iseda
6,007,909 A	12/1999	Rolander et al.	7,125,207 B2	3/2006	Blomstedt et al.
6,022,175 A	2/2000	Heinrich et al.	7,044,243 B2	5/2006	Kembaiyan et al.
6,029,544 A	2/2000	Katayama	7,048,081 B2	5/2006	Smith et al.
6,051,171 A	4/2000	Takeuchi et al.	7,070,666 B2	7/2006	Druschitz et al.
6,063,333 A	5/2000	Dennis	7,090,731 B2	8/2006	Kashima et al.
6,068,070 A	5/2000	Scott	7,101,128 B2	9/2006	Hansson
6,073,518 A	6/2000	Chow et al.	7,101,446 B2	9/2006	Takeda et al.
6,086,003 A	7/2000	Günter et al.	7,112,143 B2	9/2006	Muller
6,086,980 A	7/2000	Foster et al.	7,128,773 B2	10/2006	Liang et al.
6,089,123 A	7/2000	Chow et al.	7,147,413 B2	12/2006	Henderer et al.
6,148,936 A	11/2000	Evans et al.	7,238,414 B2	7/2007	Benitsch et al.
6,200,514 B1	3/2001	Meister	7,244,519 B2	7/2007	Festeau et al.
6,209,420 B1	4/2001	Butcher et al.	7,250,069 B2	7/2007	Kembaiyan et al.
6,214,134 B1	4/2001	Eylon et al.	7,261,782 B2	8/2007	Hwang et al.
6,214,287 B1	4/2001	Waldenstrom	7,270,679 B2	9/2007	Istephanous et al.
6,217,992 B1	4/2001	Grab	7,381,283 B2	6/2008	Lee et al.
6,220,117 B1	4/2001	Butcher	7,384,413 B2	6/2008	Gross et al.
6,227,188 B1	5/2001	Tankala et al.	7,384,443 B2	6/2008	Mirchandani
6,228,139 B1	5/2001	Oskarsson	7,410,610 B2	8/2008	Woodfield et al.
6,241,036 B1	6/2001	Lovato et al.	7,497,396 B2	3/2009	Splinter et al.
6,248,277 B1	6/2001	Friedrichs	7,513,320 B2	4/2009	Mirchandani et al.
6,254,658 B1	7/2001	Taniuchi et al.	7,625,157 B2	12/2009	Prichard et al.
6,287,360 B1	9/2001	Kembaiyan et al.	2002/0004105 A1	1/2002	Kunze et al.
6,290,438 B1	9/2001	Papajewski	2003/0010409 A1	1/2003	Kunze et al.
6,293,986 B1	9/2001	Rödiger et al.	2003/0041922 A1	3/2003	Hirose et al.
6,299,658 B1	10/2001	Moriguchi et al.	2003/0219605 A1	11/2003	Molian et al.
6,353,771 B1	3/2002	Southland	2004/0013558 A1	1/2004	Kondoh et al.
6,372,346 B1	4/2002	Toth	2004/0105730 A1	6/2004	Nakajima
6,374,932 B1	4/2002	Brady	2004/0129403 A1	7/2004	Liu et al.
6,375,706 B2	4/2002	Kembaiyan et al.	2004/0228695 A1	11/2004	Clauson
6,386,954 B2	5/2002	Sawabe et al.	2004/0234820 A1*	11/2004	Majagi 428/698
6,395,108 B2	5/2002	Eberle et al.	2004/0245022 A1	12/2004	Izaguirre et al.
6,425,716 B1	7/2002	Cook	2004/0245024 A1	12/2004	Kembaiyan
6,450,739 B1	9/2002	Puide et al.	2005/0008524 A1	1/2005	Testani
6,453,899 B1	9/2002	Tselesin	2005/0025928 A1	2/2005	Annanolli et al.
6,454,025 B1	9/2002	Runquist et al.	2005/0084407 A1	4/2005	Myrick
6,454,028 B1	9/2002	Evans	2005/0103404 A1	5/2005	Hsieh et al.
6,454,030 B1	9/2002	Findley et al.	2005/0117984 A1	6/2005	Eason et al.
6,458,471 B2	10/2002	Lovato et al.	2005/0126334 A1*	6/2005	Mirchandani 75/240
6,461,401 B1	10/2002	Kembaiyan et al.	2005/0194073 A1	9/2005	Hamano et al.
6,474,425 B1	11/2002	Truax et al.	2005/0211475 A1	9/2005	Mirchandani et al.
6,499,917 B1	12/2002	Parker et al.	2005/0247491 A1	11/2005	Mirchandani et al.

2005/0268746 A1 12/2005 Abkowitz et al.
 2006/0016521 A1 1/2006 Hanusiak et al.
 2006/0032677 A1 2/2006 Azar et al.
 2006/0043648 A1 3/2006 Takeuchi et al.
 2006/0060392 A1 3/2006 Eyre
 2006/0286410 A1 12/2006 Ahlgren et al.
 2006/0288820 A1 12/2006 Mirchandani et al.
 2007/0042217 A1 2/2007 Fang et al.
 2007/0082229 A1 4/2007 Mirchandani et al.
 2007/0102198 A1 5/2007 Oxford et al.
 2007/0102199 A1 5/2007 Smith et al.
 2007/0102200 A1 5/2007 Choe et al.
 2007/0102202 A1 5/2007 Choe et al.
 2007/0108650 A1 5/2007 Mirchandani et al.
 2007/0163679 A1 7/2007 Fujisawa et al.
 2007/0193782 A1 8/2007 Fang et al.
 2007/0251732 A1 11/2007 Mirchandani et al.
 2008/0011519 A1 1/2008 Smith et al.
 2008/0101977 A1 5/2008 Eason et al.
 2008/0145686 A1 6/2008 Mirchandani et al.
 2008/0163723 A1 7/2008 Mirchandani et al.
 2008/0226943 A1 9/2008 Fang et al.
 2008/0302576 A1 12/2008 Michandani et al.
 2009/0041612 A1 2/2009 Fang et al.
 2009/0136308 A1 5/2009 Newitt
 2009/0180915 A1 7/2009 Michandani et al.
 2009/0293672 A1 12/2009 Mirchandani et al.
 2010/0044115 A1 2/2010 Mirchandani et al.
 2010/0290849 A1 11/2010 Michandani et al.
 2010/0303566 A1 12/2010 Fang et al.

FOREIGN PATENT DOCUMENTS

CA 2212197 C 10/2000
 EP 0157625 A2 10/1985
 EP 0264674 A2 4/1988
 EP 0453428 A1 10/1991
 EP 0641620 B1 2/1998
 EP 0995876 A2 4/2000
 EP 1065021 A1 1/2001
 EP 1077783 B1 2/2001
 EP 1106706 A1 6/2001
 EP 1244531 B1 10/2004
 EP 1686193 A2 8/2006
 FR 2627541 A2 8/1989
 GB 622041 4/1949
 GB 945227 12/1963
 GB 1082568 9/1967
 GB 1309634 3/1973
 GB 1420906 1/1976
 GB 1491044 11/1977
 GB 2158744 A 11/1985
 GB 2218931 A 11/1989
 GB 2324752 A 11/1998
 GB 2385350 A 8/2003
 GB 2393449 A 3/2004
 GB 2397832 A 8/2004
 JP 51-124876 A 10/1976
 JP 59-175912 A 10/1984
 JP 60-172403 A 9/1985
 JP 62-063005 A 3/1987
 JP 2-269515 A 11/1990
 JP 5-50314 A 3/1993
 JP 8-120308 A 5/1996
 JP 10219385 A 8/1998
 JP 11-300516 A 11/1999
 JP 02254144 A 9/2002
 JP 2003-306739 A 10/2003
 JP 2004-181604 7/2004
 JP 2005-111581 A 4/2005
 RU 2135328 C1 8/1999
 WO WO 92/05009 A1 4/1992
 WO WO 92/22390 A1 12/1992
 WO WO 98/28455 A1 7/1998
 WO WO 99/13121 A1 3/1999
 WO WO 00/43628 A2 7/2000
 WO WO 00/52217 A1 9/2000
 WO WO 01/43899 A1 6/2001
 WO WO 03/011508 A2 2/2003
 WO WO 03/049889 A2 6/2003

WO WO 2004/053197 A2 6/2004
 WO WO 2005/045082 A1 5/2005
 WO WO 2005/061746 A1 7/2005
 WO WO 2005/106183 A1 11/2005
 WO WO 2006/071192 A1 7/2006
 WO WO 2007/001870 A2 1/2007
 WO WO 2007/022336 A2 2/2007
 WO WO 2007/127680 A1 11/2007
 WO WO 2011/008439 A2 1/2011

OTHER PUBLICATIONS

ASM Materials Engineering Dictionary, J. R. Davis, Ed., ASM International, Fifth printing (Jan. 2006), p. 98.
 Notice of Allowance issued on Nov. 30, 2009 in U.S. Appl. No. 11/206,368.
 Notice of Allowance issued on Jan. 26, 2010 in U.S. Appl. No. 11/116,752.
 Office Action mailed Apr. 30, 2009 in U.S. Appl. No. 11/206,368.
 Office Action mailed Oct. 31, 2008 in U.S. Appl. No. 10/903,198.
 Office Action mailed Apr. 17, 2009 in U.S. Appl. No. 10/903,198.
 U.S. Appl. No. 12/464,607, filed May 12, 2009.
 U.S. Appl. No. 12/502,277, filed Jul. 14, 2009.
 U.S. Appl. No. 12/616,300, filed Nov. 11, 2009.
 Coyle, T.W. and A. Bahrami, "Structure and Adhesion of Ni and Ni-WC Plasma Spray Coatings," Thermal Spray, Surface Engineering via Applied Research, Proceedings of the 1st International Thermal Spray Conference, May 8-11, 2000, Montreal, Quebec, Canada, 2000, pp. 251-254.
 Deng, X. et al., "Mechanical Properties of a Hybrid Cemented Carbide Composite," International Journal of Refractory Metals and Hard Materials, Elsevier Science Ltd., vol. 19, 2001, pp. 547-552.
 Gurland, J., *Quantitative Microscopy*, R.T. DeHoff and F.N. Rhines, eds., McGraw-Hill Book Company, New York, 1968, pp. 279-290.
 Gurland, Joseph, "Application of Quantitative Microscopy to Cemented Carbides," Practical Applications of Quantitative Metallography, ASTM Special Technical Publication 839, ASTM 1984, pp. 65-84.
 Hayden, Matthew and Lyndon Scott Stephens, "Experimental Results for a Heat-Sink Mechanical Seal," Tribology Transactions, 48, 2005, pp. 352-361.
 Metals Handbook, vol. 16 Machining, "Cemented Carbides" (ASM International 1989), pp. 71-89.
 Metals Handbook, vol. 16 Machining, "Tapping" (ASM International 1989), pp. 255-267.
 Notice of Allowance issued on Jan. 27, 2009 in U.S. Appl. No. 11/116,752.
 Notice of Allowance issued Oct. 21, 2002 in U.S. Appl. No. 09/460,540.
 Notice of Allowance issued May 21, 2007 for U.S. Appl. No. 10/922,750.
 Notice of Allowance issued on Nov. 13, 2008 in U.S. Appl. No. 11/206,368.
 Notice of Allowance issued on Nov. 26, 2008 in U.S. Appl. No. 11/013,842.
 Office Action (Advisory Action) issued Mar. 15, 2002 in U.S. Appl. No. 09/460,540.
 Office Action issued Dec. 1, 2001 in U.S. Appl. No. 09/460,540.
 Office Action issued Jun. 1, 2001 in U.S. Appl. No. 09/460,540.
 Office Action issued Jun. 18, 2002 in U.S. Appl. No. 09/460,540.
 Office Action issued Mar. 12, 2009 in U.S. Appl. No. 11/585,408.
 Office Action issued on Aug. 12, 2008 in U.S. Appl. No. 11/116,752.
 Office Action issued on Aug. 31, 2007 in U.S. Appl. No. 11/206,368.
 Office Action issued on Feb. 28, 2008 in U.S. Appl. No. 11/206,368.
 Office Action issued on Jan. 15, 2008 in U.S. Appl. No. 11/116,752.
 Office Action issued on Jan. 16, 2007 in U.S. Appl. No. 11/013,842.
 Office Action issued on Jan. 24, 2008 in U.S. Appl. No. 10/848,437.
 Office Action issued on Jul. 16, 2008 in U.S. Appl. No. 11/013,842.
 Office Action issued on Jul. 30, 2007 in U.S. Appl. No. 11/013,842.
 Office Action issued on Mar. 12, 2009 in U.S. Appl. No. 11/585,408.
 Office Action issued on May 29, 2007 in U.S. Appl. No. 11/116,752.
 Office Action issued on May 7, 2007 in U.S. Appl. No. 10/848,437.
 Office Action issued on Oct. 21, 2008 in U.S. Appl. No. 11/167,811.
 Office Action issued on Oct. 13, 2006 in U.S. Appl. No. 10/922,750.

- Office Action (Restriction Requirement) issued on Jul. 24, 2008 in U.S. Appl. No. 11/167,811.
- Peterman, Walter, "Heat-Sink Compound Protects the Unprotected," *Welding Design and Fabrication*, Sep. 2003, pp. 20-22.
- Pre-Appeal Brief Conference Decision issued on May 14, 2008 in U.S. Appl. No. 10/848,437.
- Pre-Appeal Conference Decision issued on Jun. 19, 2008 in U.S. Appl. No. 11/206,368.
- Restriction Requirement issued on Sep. 8, 2006 in U.S. Appl. No. 10/848,437.
- Sriram, et al., "Effect of Cerium Addition on Microstructures of Carbon-Alloyed Iron Aluminides," *Bull. Mater. Sci.*, vol. 28, No. 6, Oct. 2005, pp. 547-554.
- Supplemental Notice of Allowability issued on Jul. 3, 2007 for U.S. Appl. No. 10/922,750.
- Tracey et al., "Development of Tungsten Carbide-Cobalt-Ruthenium Cutting Tools for Machining Steels" *Proceedings Annual Microprogramming Workshop*, vol. 14, 1981, pp. 281-292.
- Underwood, *Quantitative Stereology*, pp. 23-108 (1970).
- Office Action issued on Jul. 9, 2009 in U.S. Appl. No. 11/116,752.
- Final Office Action issued on Jun. 12, 2009 in U.S. Appl. No. 11/167,811.
- Office Action issued on Aug. 28, 2009 in U.S. Appl. No. 11/167,811.
- Office Action mailed Sep. 22, 2009 in U.S. Appl. No. 11/585,408.
- Office Action mailed Sep. 7, 2010 in U.S. Appl. No. 11/585,408.
- Office Action mailed Feb. 16, 2011 in U.S. Appl. No. 11/585,408.
- Office Action mailed Mar. 2, 2010 in U.S. Appl. No. 11/167,811.
- Office Action mailed Aug. 19, 2010 in U.S. Appl. No. 11/167,811.
- Advisory Action Before the Filing of an Appeal Brief mailed May 12, 2010 in U.S. Appl. No. 11/167,811.
- Office Action mailed Feb. 3, 2011 in U.S. Appl. No. 11/167,811.
- Office Action mailed Mar. 19, 2009 in U.S. Appl. No. 11/737,993.
- Office Action mailed Jun. 3, 2009 in U.S. Appl. No. 11/737,993.
- Office Action mailed Dec. 9, 2009 in U.S. Appl. No. 11/737,993.
- Office Action mailed Feb. 24, 2010 in U.S. Appl. No. 11/737,993.
- Office Action mailed Jun. 29, 2010 in U.S. Appl. No. 11/737,993.
- Advisory Action Before the Filing of an Appeal Brief mailed Sep. 9, 2010 in U.S. Appl. No. 11/737,993.
- Pre-Brief Appeal Conference Decision mailed Nov. 22, 2010 in U.S. Appl. No. 11/737,993.
- Office Action mailed Apr. 20, 2011 in U.S. Appl. No. 11/737,993.
- Restriction Requirement mailed Sep. 17, 2010 in U.S. Appl. No. 12/397,597.
- Office Action mailed Nov. 15, 2010 in U.S. Appl. No. 12/397,597.
- Office Action mailed May 3, 2010 in U.S. Appl. No. 11/924,273.
- Office Action mailed Oct. 14, 2010 in U.S. Appl. No. 11/924,273.
- Office Action mailed Feb. 2, 2011 in U.S. Appl. No. 11/924,273.
- Office Action mailed May 14, 2009 in U.S. Appl. No. 11/687,343.
- Office Action mailed Jan. 21, 2010 in U.S. Appl. No. 11/687,343.
- Notice of Allowance mailed May 18, 2010 in U.S. Appl. No. 11/687,343.
- Office Action mailed Dec. 29, 2005 in U.S. Appl. No. 10/903,198.
- Office Action mailed Sep. 29, 2006 in U.S. Appl. No. 10/903,198.
- Office Action mailed Mar. 27, 2007 in U.S. Appl. No. 10/903,198.
- Office Action mailed Sep. 26, 2007 in U.S. Appl. No. 10/903,198.
- Office Action mailed Jan. 16, 2008 in U.S. Appl. No. 10/903,198.
- Advisory Action before mailing of Appeal Brief mailed Jun. 29, 2009 in U.S. Appl. No. 10/903,198.
- Examiner's Answer mailed Aug. 17, 2010 in U.S. Appl. No. 10/903,198.
- Office Action mailed Apr. 22, 2010 in U.S. Appl. No. 12/196,951.
- Office Action mailed Oct. 29, 2010 in U.S. Appl. No. 12/196,951.
- Office Action mailed Apr. 12, 2011 in U.S. Appl. No. 12/196,951.
- Shi et al., "Composite Ductility—The Role of Reinforcement and Matrix", TMS Meeting, Las Vegas, NV, Feb. 12-16, 1995, 10 pages.
- Vander Vort, "Introduction to Quantitative Metallography", *Tech Notes*, vol. 1, Issue 5, published by Buehler, Ltd. 1997, 6 pages.
- You Tube, "The Story Behind Kennametal's Beyond Blast", dated Sep. 14, 2010, http://www.youtube.com/watch?v=8_A-bYVwmU8 (3 pages) accessed on Oct. 14, 2010.
- Kennametal press release on Jun. 10, 2010, <http://news.thomasnet.com/companystory/Kennametal-Launches-Beyond-BLAST-TM-at-IMTS-2010-Booth-W-1522-833445> (2 pages) accessed on Oct. 14, 2010.
- Pages from Kennametal site, https://www.kennametal.com/en-US/promotions/Beyond_Blast.jhtml (7 pages) accessed on Oct. 14, 2010.
- ASM Materials Engineering Dictionary, J.R. Davis, Ed., ASM International, Fifth printing, Jan. 2006, p. 98.
- Childs et al., "Metal Machining", 2000, Elsevier, p. 111.
- Brookes, Kenneth J. A., "World Directory and Handbook of Hardmetals and Hard Materials", *International Carbide Data*, U.K. 1996, Sixth Edition, p. 42.
- Firth Sterling grade chart, Allegheny Technologies, attached to Declaration of Prakash Mirchandani, Ph.D. as filed in U.S. Appl. No. 11/737,993 on Sep. 9, 2009.
- Metals Handbook Desk Edition, 2nd Ed., J.R. Davis, Editor, ASM International 1998, p. 62.
- McGraw-Hill Dictionary of Scientific and Technical Terms, 5th Edition, Sybil P. Parker, Editor in Chief, 1993, pp. 799, 800, 1933, and 2047.
- US 4,966,627, 10/1990, Keshavan et al. (withdrawn)

* cited by examiner

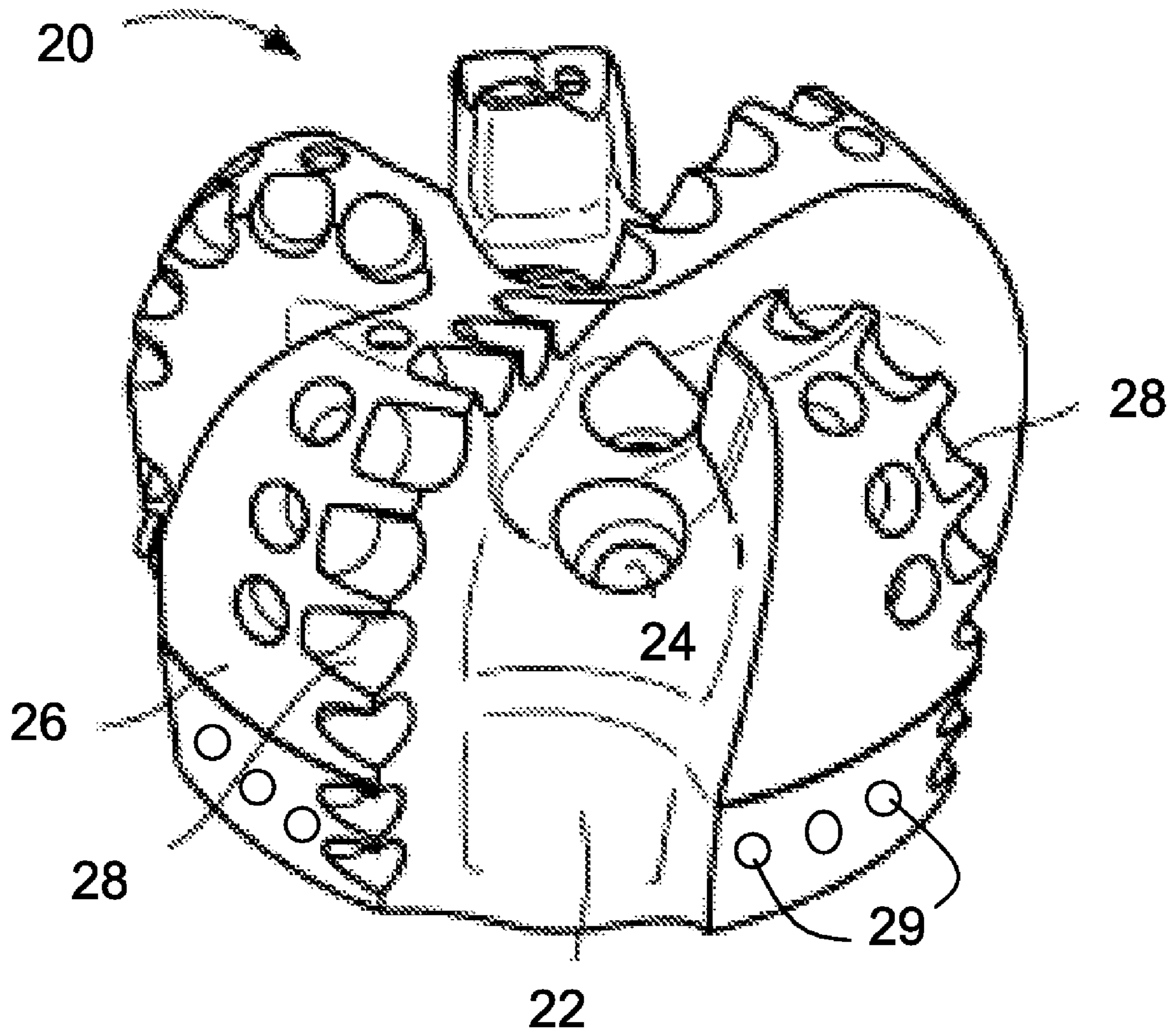

FIG. 1

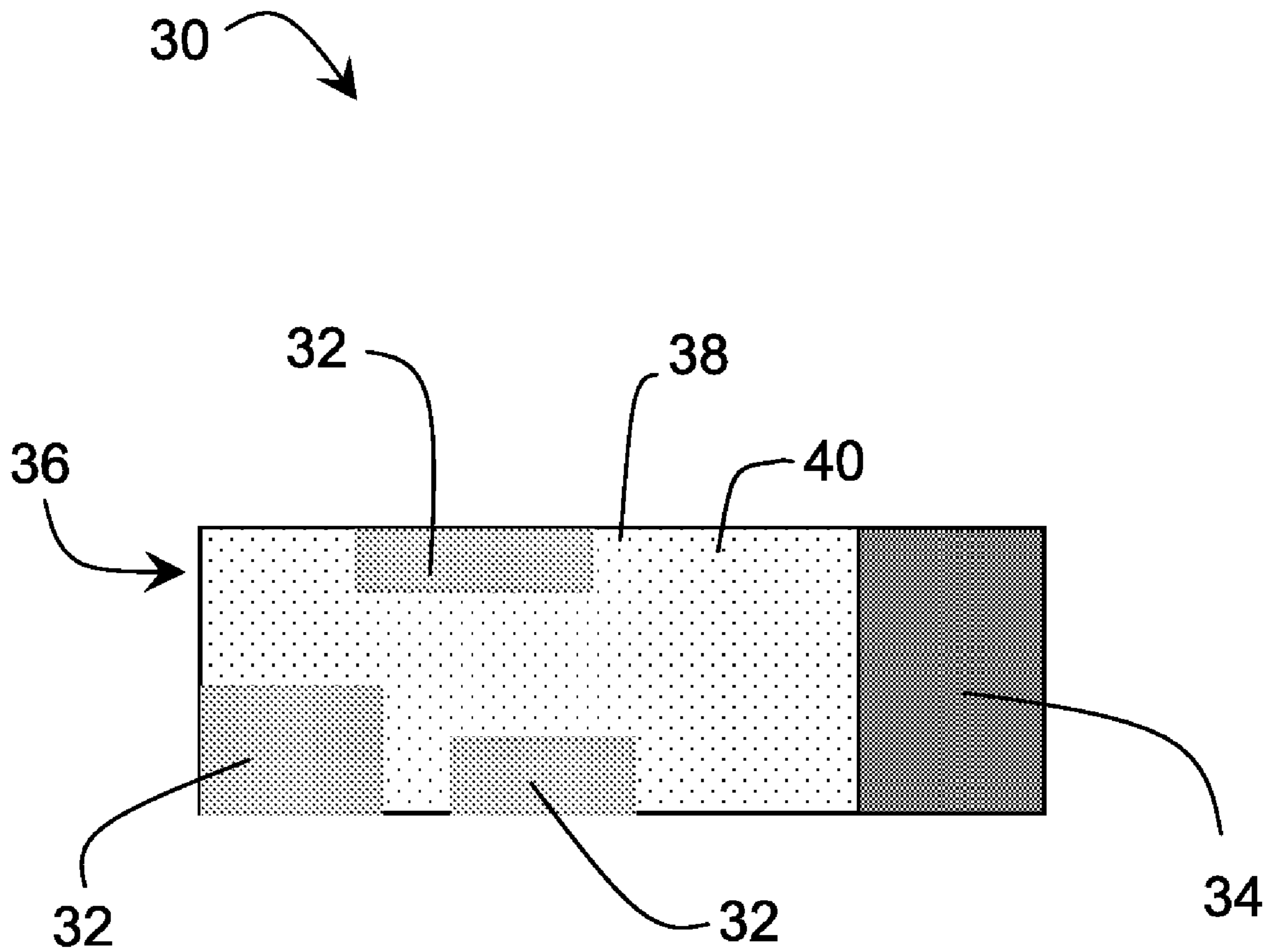

FIG. 2

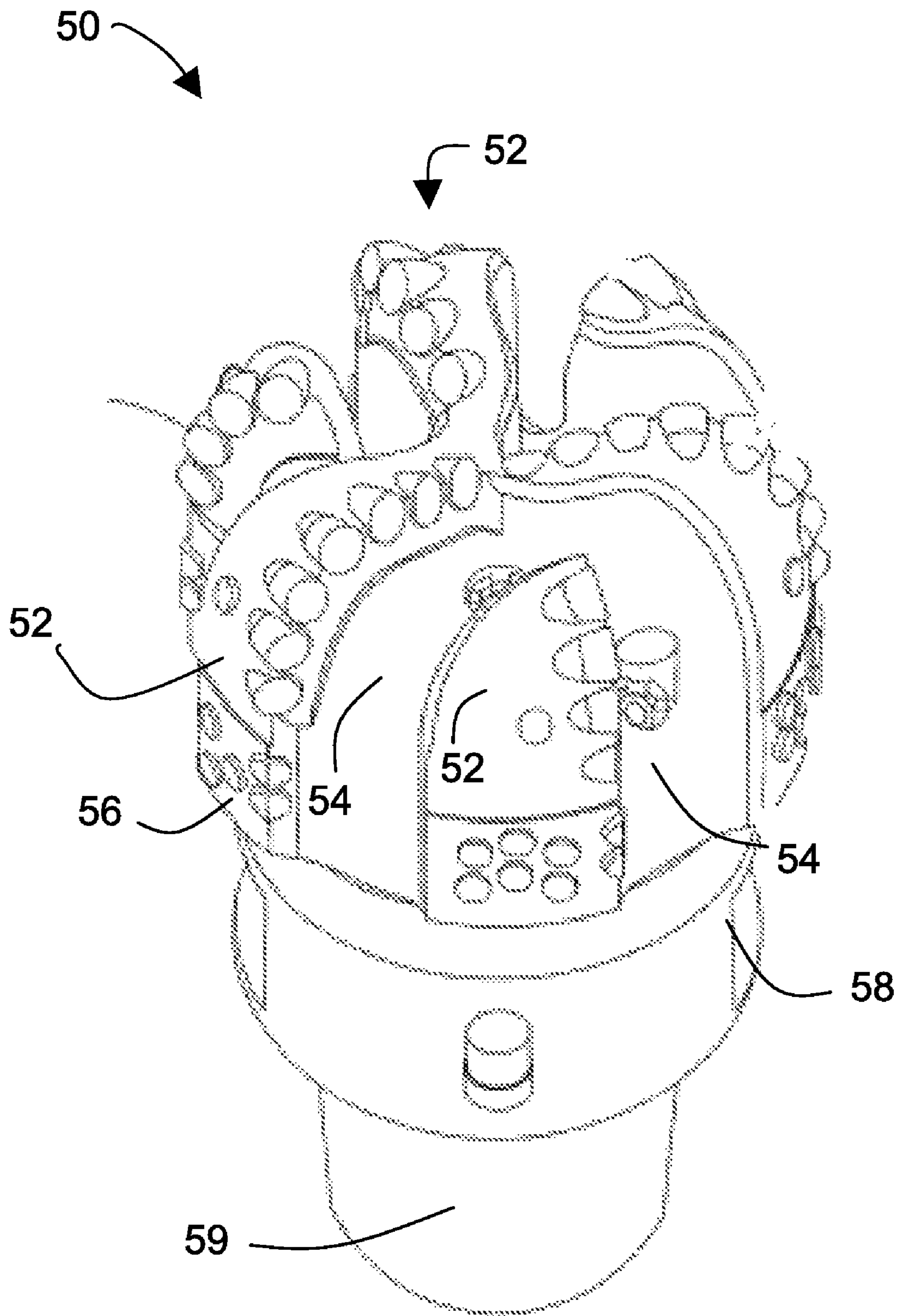

FIG. 3

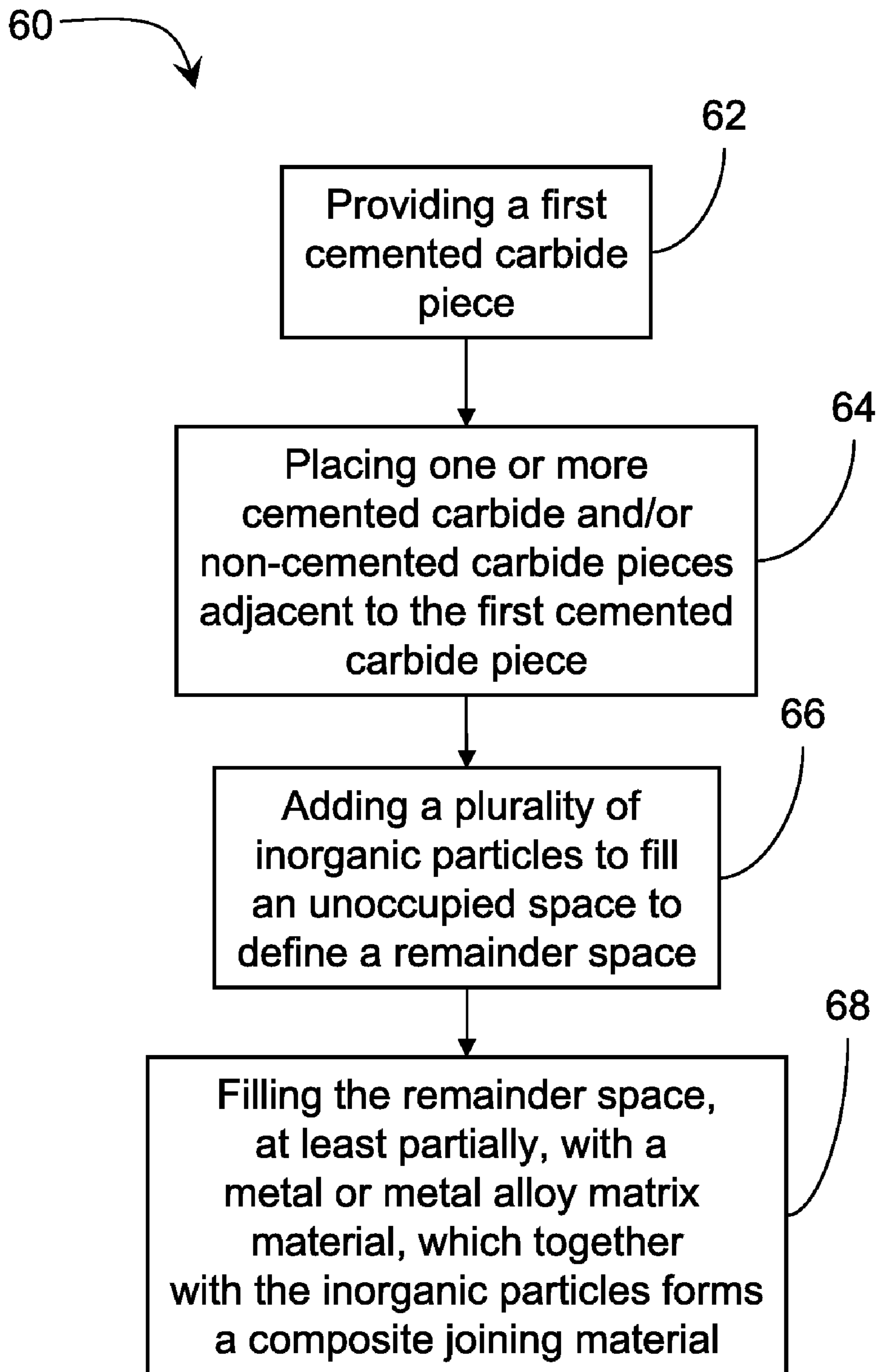

FIG. 4

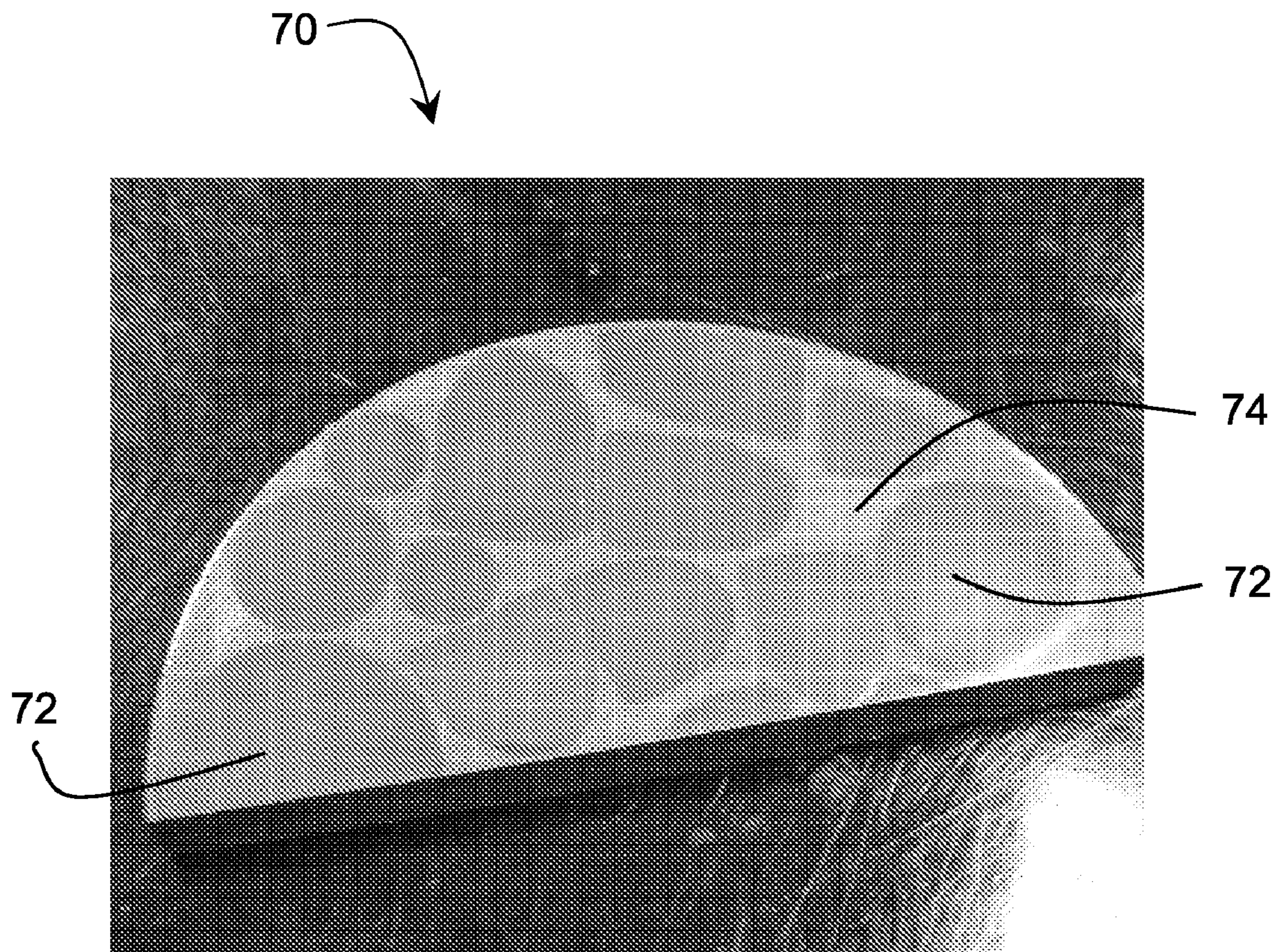

FIG. 5

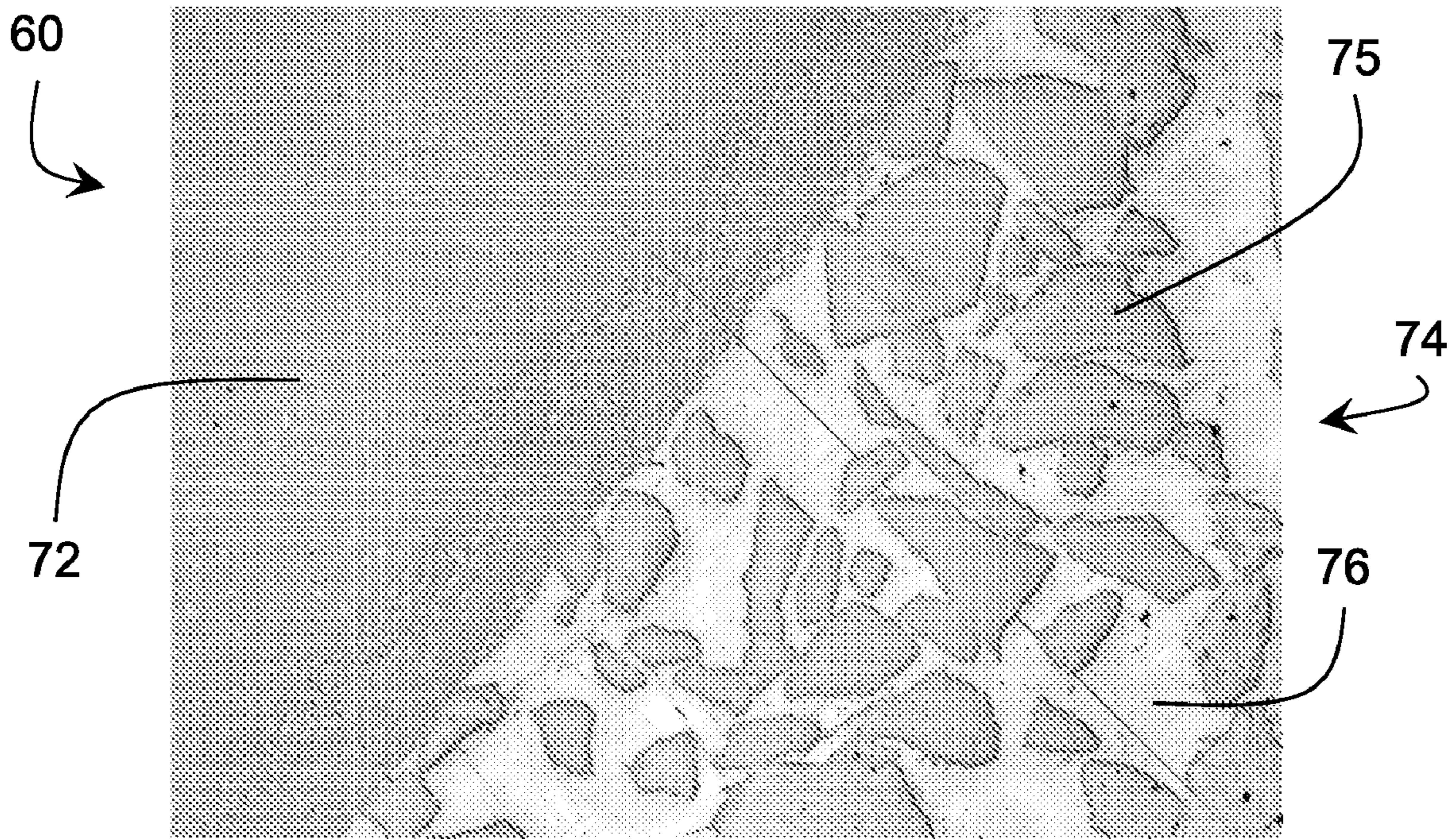

FIG. 6A

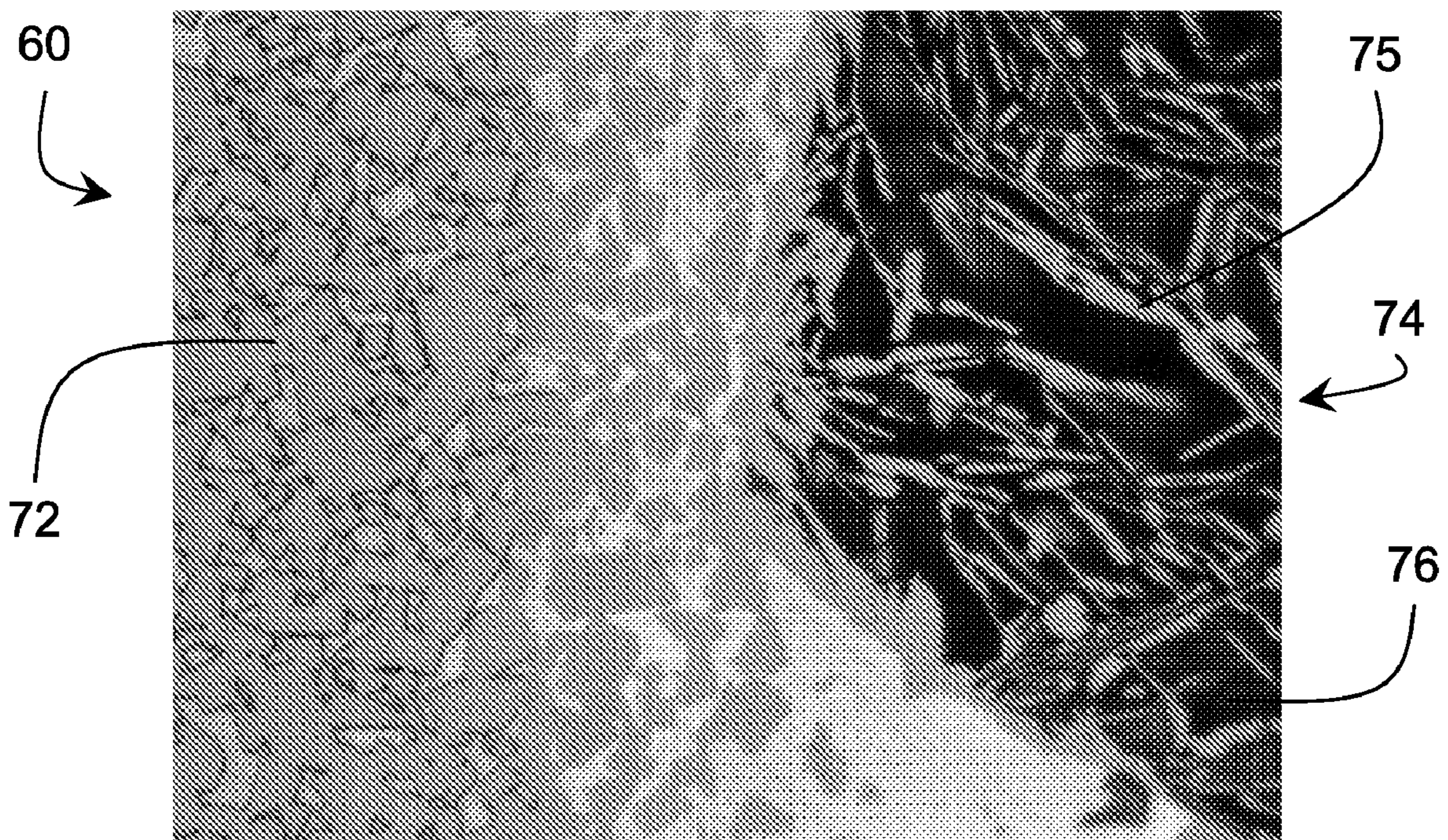
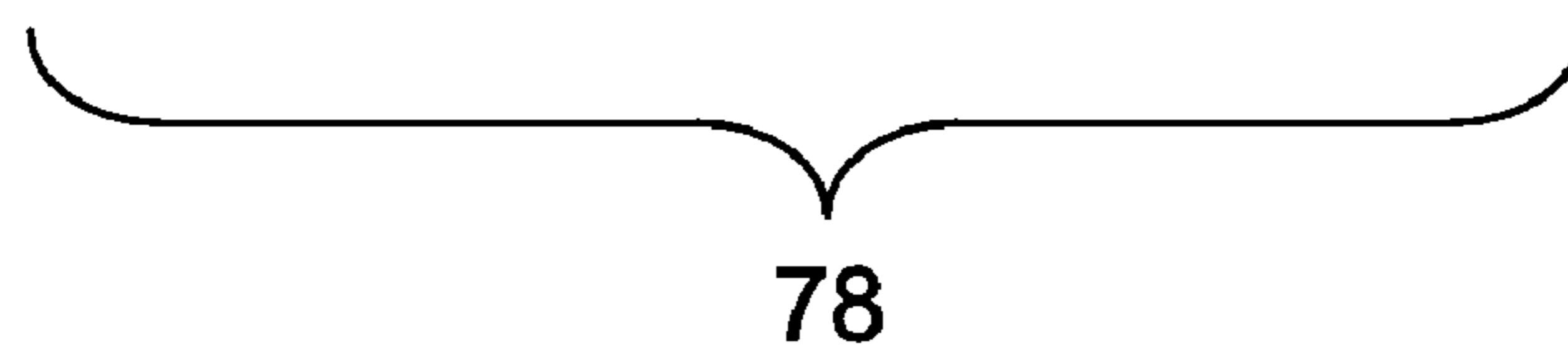

FIG. 6B



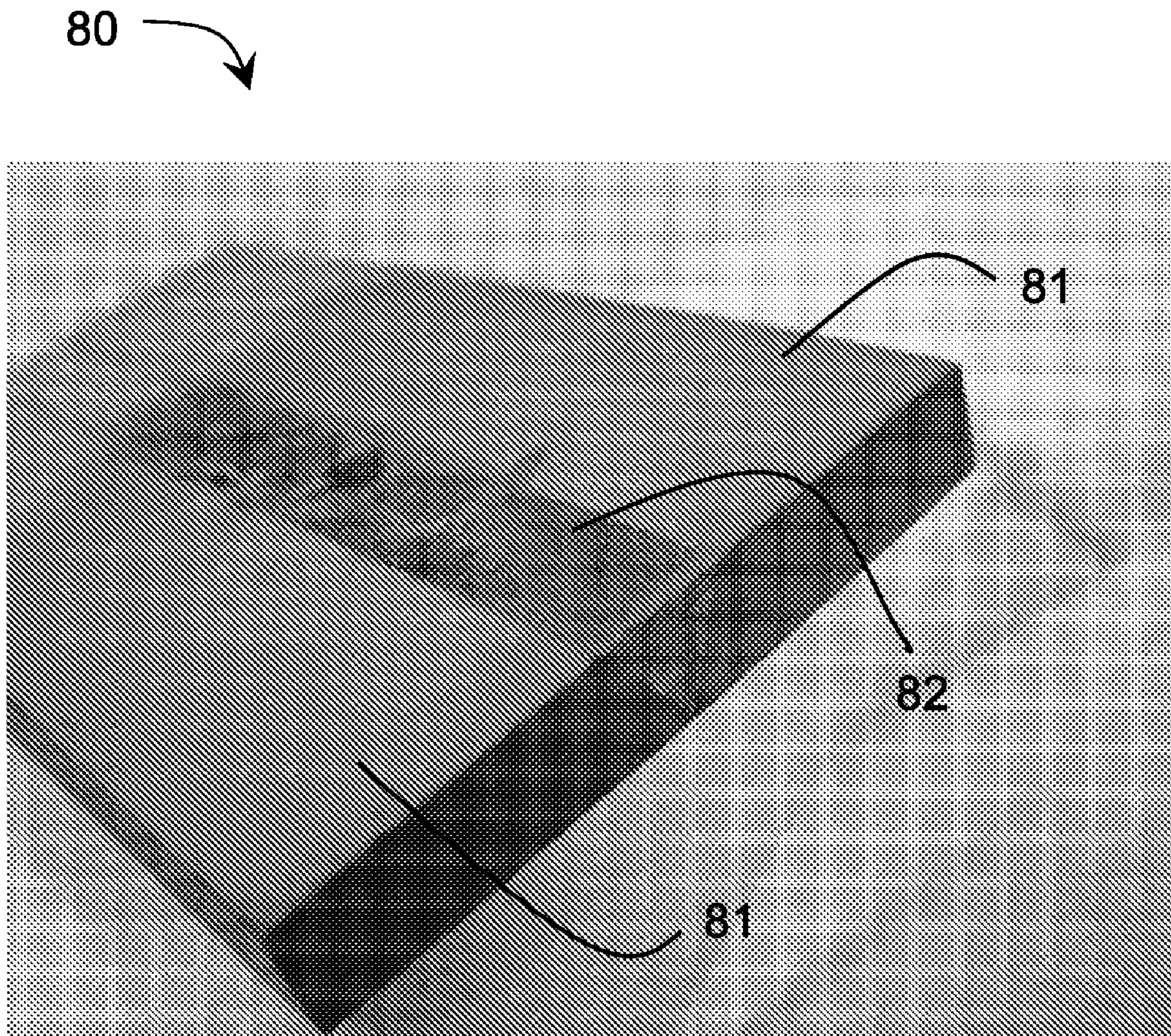
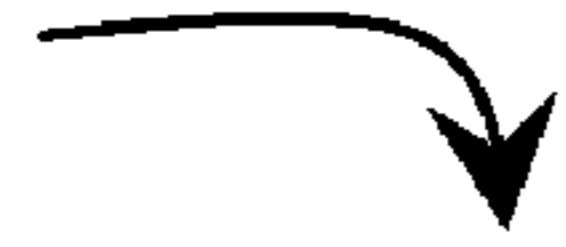

FIG. 7

84 

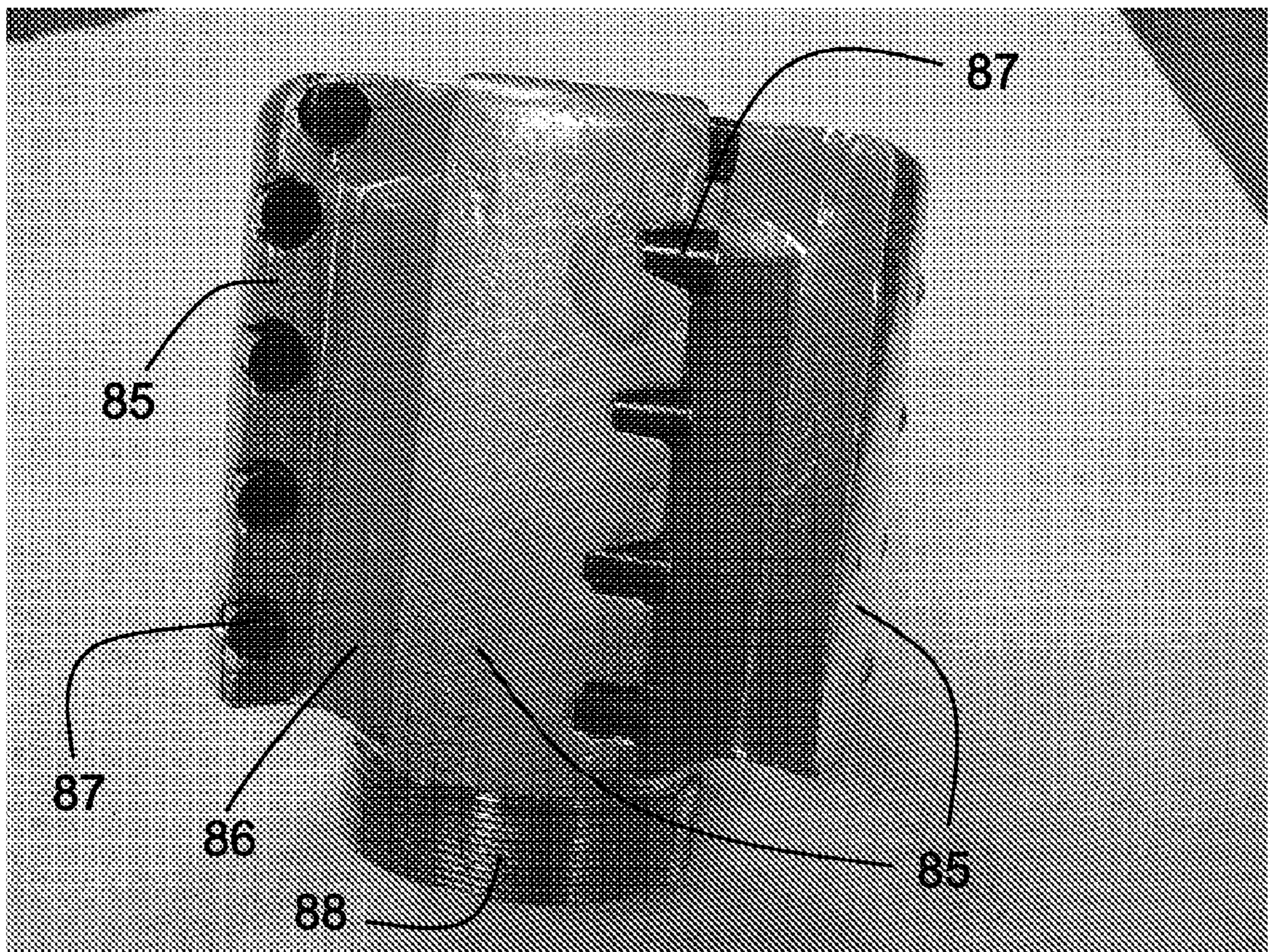

FIG. 8

90

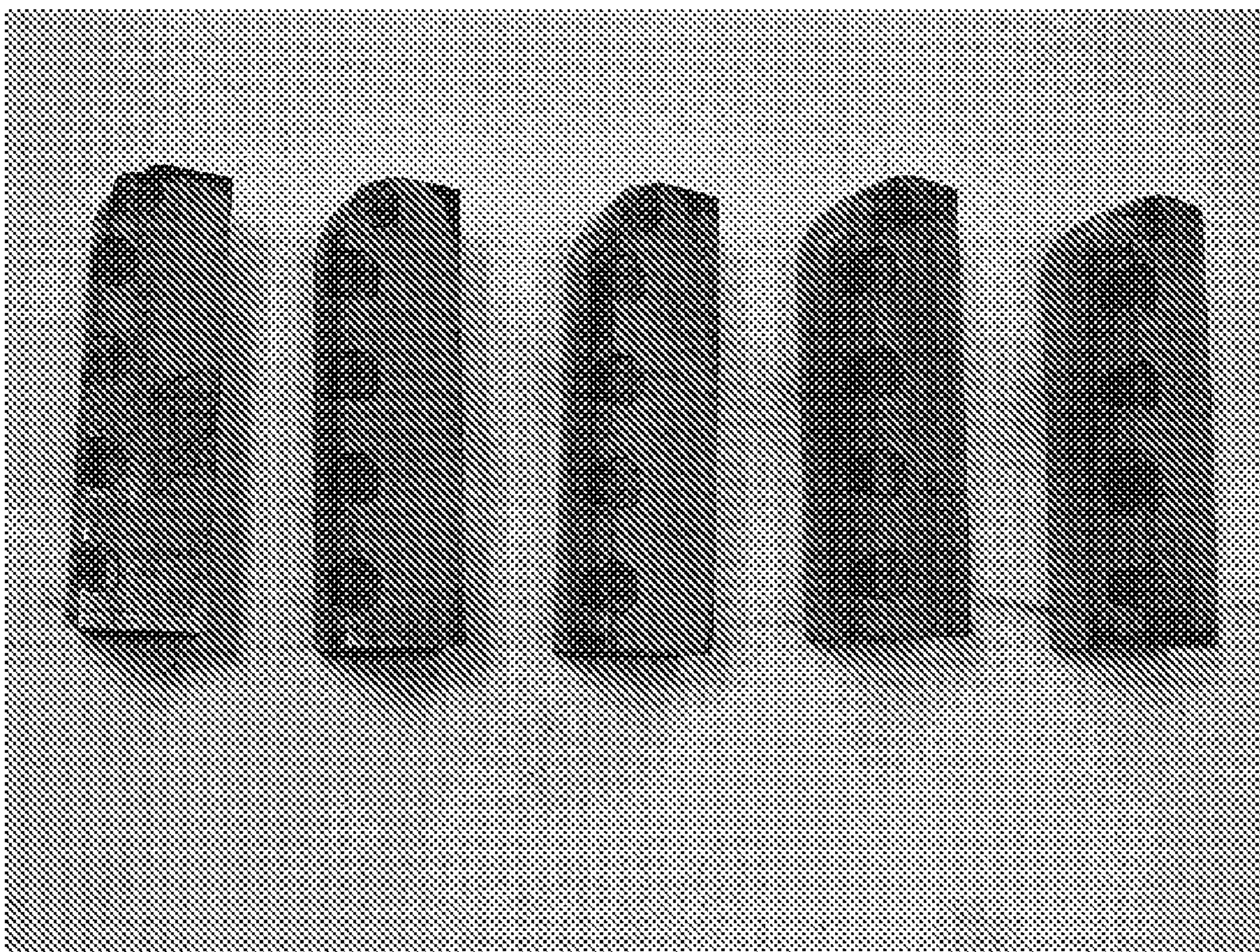

FIG. 9

100

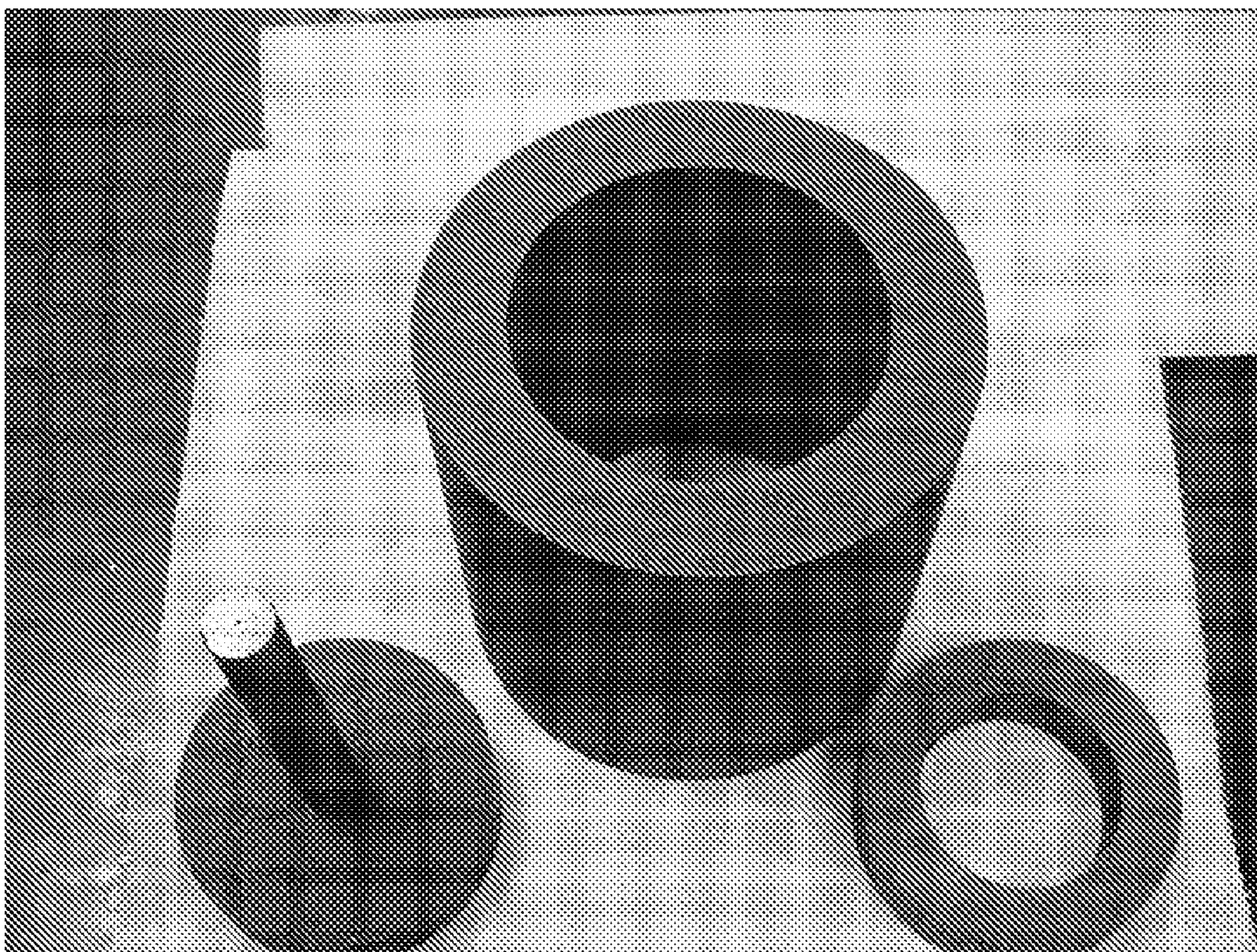

FIG. 10

110

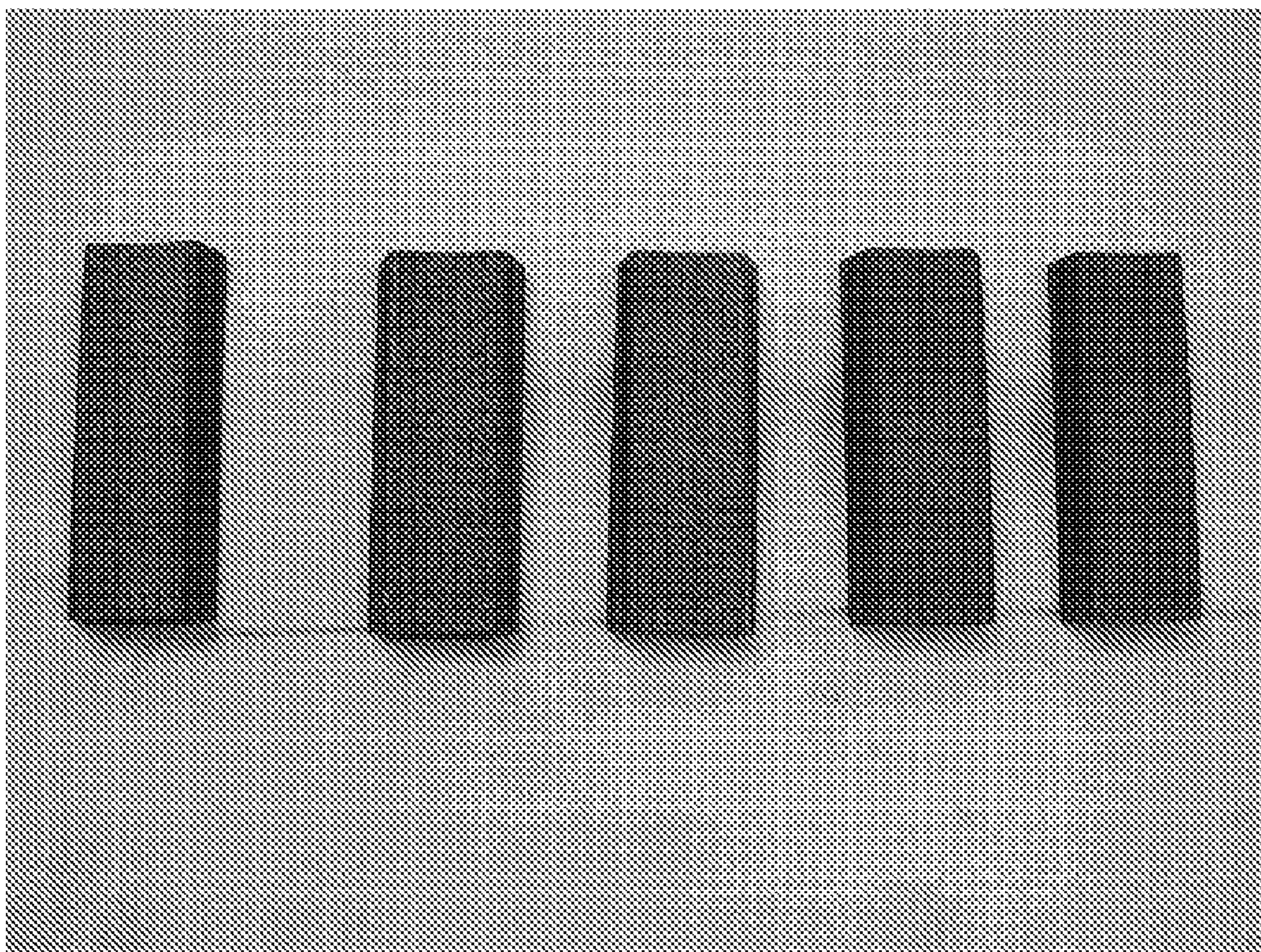

FIG. 11

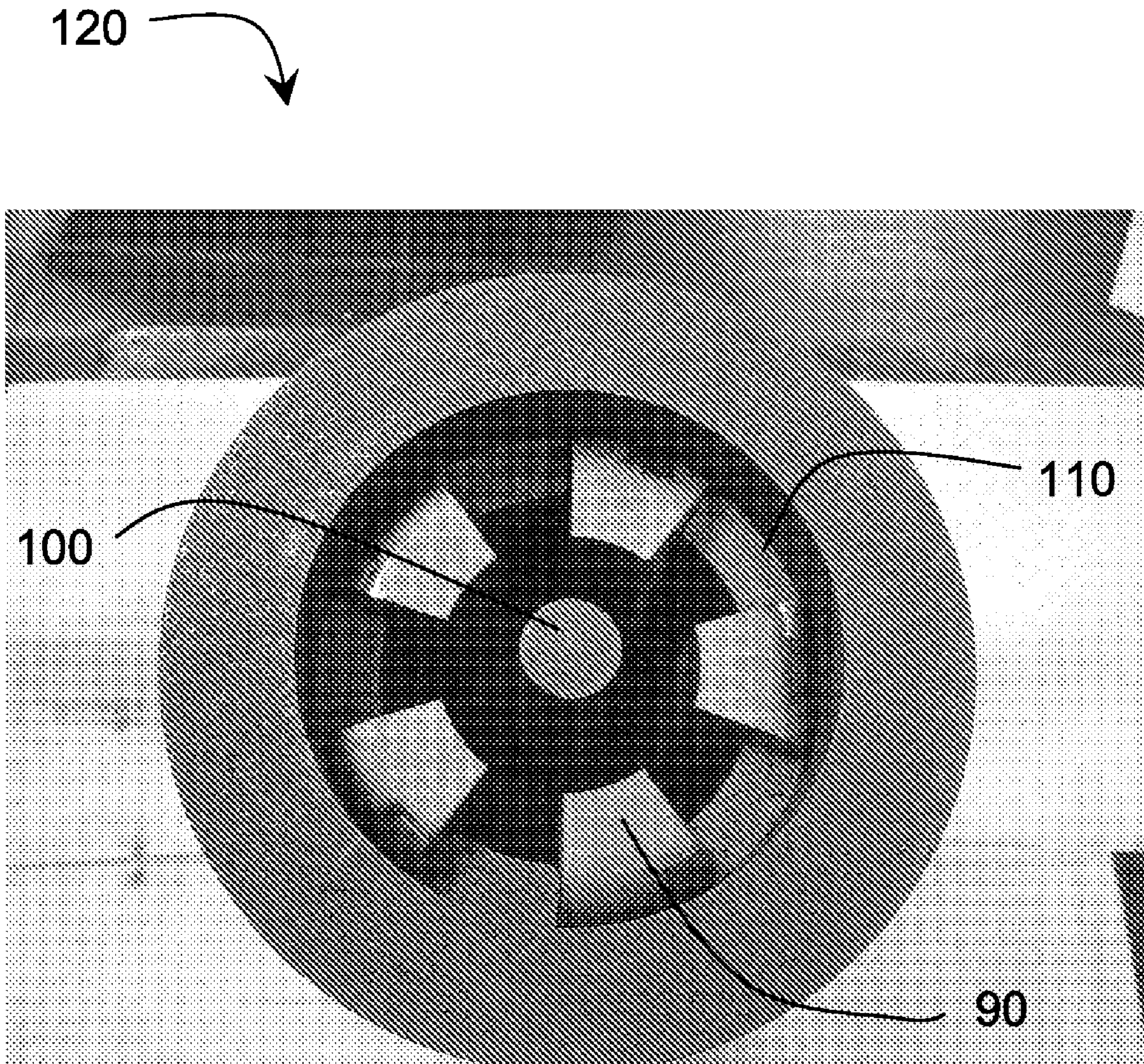

FIG. 12

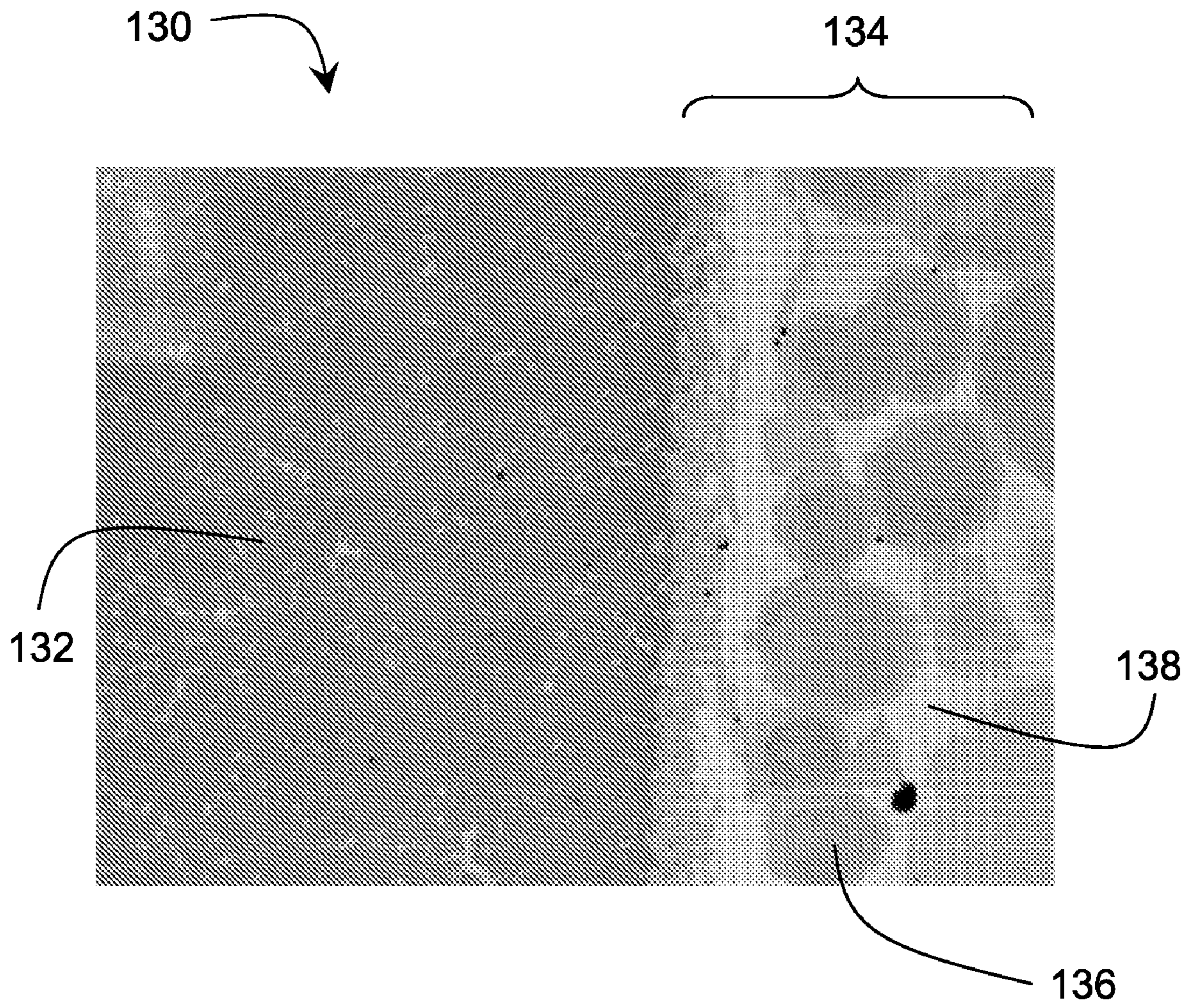

FIG. 13

EARTH-BORING BITS AND OTHER PARTS INCLUDING CEMENTED CARBIDE

BACKGROUND OF THE TECHNOLOGY

1. Field of the Technology

The present disclosure relates to earth-boring articles and other articles of manufacture comprising sintered cemented carbide and to their methods of manufacture. Examples of earth-boring articles encompassed by the present disclosure include, for example, earth-boring bits and earth-boring bit parts such as, for example, fixed-cutter earth-boring bit bodies and roller cones for rotary cone earth-boring bits. The present disclosure further relates to earth-boring bit bodies, roller cones, and other articles of manufacture made using the methods disclosed herein.

2. Description of the Background of the Technology

Cemented carbides are composites of a discontinuous hard metal carbide phase dispersed in a continuous relatively soft binder phase. The dispersed phase, typically, comprises grains of a carbide comprising one or more of the transition metals selected from, for example, titanium, vanadium, chromium, zirconium, hafnium, molybdenum, niobium, tantalum, and tungsten. The binder phase typically comprises at least one of cobalt, a cobalt alloy, nickel, a nickel alloy, iron, and an iron alloy. Alloying elements such as, for example, chromium, molybdenum, ruthenium, boron, tungsten, tantalum, titanium, and niobium may be added to the binder to enhance certain properties of the composite. The binder phase binds or "cements" the metal carbide regions together, and the composite exhibits an advantageous combination of the physical properties of the discontinuous and continuous phases.

Numerous cemented carbide types or "grades" are produced by varying parameters that may include the composition of the materials in the dispersed and/or continuous phases, the grain size of the dispersed phase, and the volume fractions of the phases. Cemented carbides including a dispersed tungsten carbide phase and a cobalt binder phase are the most commercially important of the commonly available cemented carbide grades. The various grades are available as powder blends (referred to herein as a "cemented carbide powder") which may be processed using conventional press-and-sinter techniques to form the cemented carbide composites.

Cemented carbide grades including a discontinuous tungsten carbide phase and a continuous cobalt binder phase exhibit advantageous combinations of strength, fracture toughness, and wear resistance. As is known in the art, "strength" is the stress at which a material ruptures or fails. "Fracture toughness" refers to the ability of a material to absorb energy and deform plastically before fracturing. "Toughness" is proportional to the area under the stress-strain curve from the origin to the breaking point. See McGRAW-HILL DICTIONARY OF SCIENTIFIC AND TECHNICAL TERMS (5th ed. 1994). "Wear resistance" refers to the ability of a material to withstand damage to its surface. Wear generally involves progressive loss of material, due to a relative motion between a material and a contacting surface or substance. See METALS HANDBOOK DESK EDITION (2d ed. 1998). Cemented carbides find extensive use in applications requiring substantial strength, toughness, and high wear resistance, such as, for example, in metal cutting and metal forming applications, in earth-boring and rock cutting applications, and as wear parts in machinery.

The strength, toughness, and wear resistance of a cemented carbide are related to the average grain size of the dispersed

hard phase and the volume (or weight) fraction of the binder phase present in the composite. Generally, an increase in the average grain size of the carbide particles and/or an increase in the volume fraction of the binder in a conventional cemented carbide powder grade increases the fracture toughness of the formed composite. However, this increase in toughness is generally accompanied by decreased wear resistance. Metallurgists formulating cemented carbides, therefore, are continually challenged to develop grades exhibiting both high wear resistance and high fracture toughness and which are suitable for use in demanding applications.

In general, cemented carbide parts are produced as individual parts using conventional powder metallurgy press-and-sinter techniques. The manufacturing process typically involves consolidating or pressing a portion of a cemented carbide powder in a mold to provide an unsintered, or "green", compact of defined shape and size. If additional shape features are required in the cemented carbide part that cannot be readily achieved by pressing or otherwise consolidating the powder, the consolidation or pressing operation is followed by machining the green compact, which is also referred to as "green shaping". If additional compact strength is needed for the green shaping process, the green compact can be presintered before green shaping. Presintering occurs at a temperature lower than the final sintering temperature and provides a "brown" compact. The green shaping operation is followed by a high temperature treatment, commonly referred to as "sintering". Sintering densifies the material to near theoretical full density to produce a cemented carbide composite and optimize the strength and hardness of the material.

A significant limitation of press-and-sinter fabrication techniques is that the range of compact shapes that can be formed is rather limited, and the techniques cannot effectively be used to produce complex part shapes. Pressing or consolidation of powders is usually accomplished using mechanical or hydraulic presses and rigid tooling or, alternatively, isostatic pressing. In the isostatic pressing technique shaping forces may be applied from different directions to a flexible mold. A "wet bag" isostatic pressing technique utilizes a portable mold disposed in a pressure medium. A "dry bag" isostatic pressing technique involves a mold having symmetry in the radial direction. Whether rigid tooling or flexible tooling is used, however, the consolidated compact must be extracted from the tool, and this limitation limits the compact shapes that can be formed. In addition, compacts larger than about 4 to 6 inches in diameter and about 4 to 6 inches in length must be consolidated in isostatic presses. Since isostatic presses use flexible tooling, however, pressed compacts with precise shapes cannot be formed.

As indicated above, additional shape features can be incorporated into a compact for a cemented carbide part by green shaping a brown compact after presintering. However, the range of shapes that are possible from green shaping is limited. The possible shapes are limited by the availability and capabilities of the machine tools. Machine tools that may be used in green machining must be highly wear resistant and are generally expensive. Also, green machining of compacts used to form cemented carbide parts produces highly abrasive dust. In addition, consideration must be given to the design of the component in that the shape features to be formed on the compacts cannot intersect the path of the cutting tool.

Cemented carbide parts having complex shapes may be fabricated by attaching together two or more cemented carbide pieces using conventional metallurgical joining techniques such as, for example, brazing, welding, and diffusion bonding, or using mechanical attachment techniques such as,

for example, shrink fitting, press fitting, or the use of mechanical fasteners. However, both metallurgical and mechanical joining techniques are deficient because of the inherent properties of cemented carbide and/or the mechanical properties of the joint. Because typical brazing or welding alloys have strength levels much lower than cemented carbides, brazed and welded joints are likely to be much weaker than the attached cemented carbide pieces. Also, since the brazing and welding deposits do not include carbides, nitrides, silicides, oxides, borides, or other hard phases, the braze or weld joint also is much less wear resistant than the cemented carbide materials. Mechanical attachment techniques generally require the presence of features such as keyways, slots, holes, or threads on the components being joined together. Providing such features on cemented carbide parts results in regions at which stress concentrates. Because cemented carbides are relatively brittle materials, they are extremely notch-sensitive, and the stress concentrations associated with mechanical joining features may readily result in premature fracture of the cemented carbide.

A method of making cemented carbide parts having complex shapes, for example, earth-boring bits and bit bodies, exhibiting suitable strength, wear resistance, and fracture toughness for demanding applications and which lack the drawbacks of parts made by the conventional methods discussed above would be highly desirable.

In addition, a method of making cemented carbide parts including regions of non-cemented carbide material, such as a readily machinable metal or metallic (i.e., metal-containing) alloy, without significantly compromising the strength, wear resistance, or fracture toughness of the bonding region or the part overall likewise would be highly desirable. A particular example of a part that would benefit from manufacture by such a method is a cemented carbide-based fixed-cutter earth-boring bit. Fixed-cutter earth-boring bits basically include several inserts secured to a bit body in predetermined positions to optimize cutting. The cutting inserts typically include a layer of synthetic diamond sintered on a cemented carbide substrate. Such inserts are often referred to as polycrystalline diamond compacts (PDC).

Conventional bit bodies for fixed-cutter earth-boring bits have been made by machining the complex features of the bits from steel, or by infiltrating a bed of hard carbide particles with a binder alloy, such as, for example a copper-base alloy. Recently, it has been disclosed that fixed-cutter bit bodies may be fabricated from cemented carbides employing standard powder metallurgy practices (powder consolidation, followed by shaping or machining the green or presintered powder compact, and high temperature sintering). Co-pending U.S. patent application Ser. Nos. 10/848,437 and 11/116,752, disclose the use of cemented carbide composites in bit bodies for earth-boring bits, and each such application is hereby incorporated herein by reference in its entirety. Cemented carbide-based bit bodies provide substantial advantages over machined steel or infiltrated carbide bit bodies since cemented carbides exhibit particularly advantageous combinations of high strength, toughness, and abrasion and erosion resistance relative to machined steel or infiltrated carbides.

FIG. 1 is a schematic illustration of a fixed-cutter earth-boring bit body on which PDC cutting inserts may be mounted. Referring to FIG. 1, the bit body 20 includes a central portion 22 including holes 24 through which mud is pumped, and arms or "blades" 26 including pockets 28 in which the PDC cutters are attached. The bit body 20 may further include gage pads 29 formed of hard, wear-resistant material. The gage pads 29 are provided to inhibit bit wear that would reduce the effective diameter of the bit to an

unacceptable degree. Bit body 20 may consist of cemented carbide formed by powder metallurgy techniques or by infiltrating hard carbide particles with a molten metal or metallic alloy. The powder metallurgy process includes filling a void of a mold with a blend of binder metal and carbide powders, and then compacting the powders to form a green compact. Due to the high strength and hardness of sintered cemented carbides, which makes machining the material difficult, the green compact typically is machined to include the features of the bit body, and then the machined compact is sintered. The infiltration process entails filling a void of a mold with hard particles, such as tungsten carbide particles, and infiltrating the hard particles in the mold with a molten metal or metal alloy, such as a copper alloy. In certain bit bodies manufactured by infiltration, small pieces of sintered cemented carbide are positioned around one or more of the gage pads to further inhibit bit wear. In such cases, the total volume of the sintered cemented carbide pieces is less than 1% of the bit body's total volume.

The overall durability and service life of fixed-cutter earth-boring bits depends not only on the durability of the cutting elements, but also on the durability of the bit bodies. Thus, earth-boring bits including solid cemented carbide bit bodies may exhibit significantly longer service lifetimes than bits including machined steel or infiltrated hard particle bit bodies. However, solid cemented carbide earth-boring bits still suffer from some limitations. For example, it can be difficult to accurately and precisely position the individual PDC cutters on solid cemented carbide bit bodies since the bit bodies experience some size and shape distortion during the high temperature sintering process. If the PDC cutters are not located precisely at predetermined positions on the bit body blades, the earth-boring bit may not perform satisfactorily due to, for example, premature breakage of the cutters and/or the blades, excessive vibration, and/or drilling holes that are not round ("out-of-round holes").

Also, because solid, one-piece, cemented carbide bit bodies have complex shapes (see FIG. 1), the green compacts commonly are machined using sophisticated machine tools, such as five-axis computer controlled milling machines. However, as discussed hereinabove, even the most sophisticated machine tools can provide only a limited range of shapes and designs. For example, the number and shape of cutting blades and the PDC cutters mounting positions that may be machined is limited because shape features cannot interfere with the path of the cutting tool during the machining process.

Thus, there is a need for improved methods of making cemented carbide-based earth-boring bit bodies and other parts and that do not suffer from the limitations of known manufacturing methods, including those discussed above.

SUMMARY

One aspect of the present disclosure is directed to an article of manufacture including at least one cemented carbide piece, wherein the total volume of cemented carbide pieces is at least 5% of a total volume of the article of manufacture, and a joining phase binding the at least one cemented carbide piece into the article of manufacture. The joining phase includes inorganic particles and a matrix material including at least one of a metal and a metallic alloy. The melting temperature of the inorganic particles is higher than a melting temperature of the matrix material.

Another aspect of the present disclosure is directed to an article of manufacture that is an earth-boring article. The earth-boring article includes at least one cemented carbide

5

piece. The cemented carbide piece has a cemented carbide volume that is at least 5% of the total volume of the earth-boring article. A metal matrix composite binds the cemented carbide piece into the earth-boring article. The metal matrix composite comprises hard particles dispersed in a matrix comprising a metal or a metallic alloy.

Yet another aspect of the present disclosure is directed to a method of making an article of manufacture including a cemented carbide region, wherein the method includes positioning at least one cemented carbide piece and, optionally, a non-cemented carbide piece in a void of a mold in predetermined positions to partially fill the void and define an unoccupied space in the void. The volume of the at least one cemented carbide piece is at least 5% of a total volume of the article of manufacture. A plurality of inorganic particles are added to partially fill the unoccupied space. The space between the inorganic particles is a remainder space. The cemented carbide piece, the non-cemented carbide piece if present, and the plurality of hard particles are heated. A molten metal or a molten metal alloy is infiltrated into the remainder space. The melting temperature of the molten metal or the molten metal alloy is less than the melting temperature of the plurality of inorganic particles. The molten metal or the molten metal alloy in the remainder space is cooled, and the solidified molten metal or molten metal alloy binds the cemented carbide piece, the non-cemented carbide piece if present, and the inorganic particles to form the article of manufacture.

An additional aspect according to the present disclosure is directed to a method of making a fixed-cutter earth-boring bit, wherein the method includes positioning at least one sintered cemented carbide piece and, optionally, at least one non-cemented carbide piece in a void of a mold, thereby defining an unoccupied portion of the void. The total volume of the cemented carbide pieces positioned in the void of the mold is at least 5% of the total volume of the fixed-cutter earth-boring bit. Hard particles are disposed in the void to occupy a portion of the unoccupied portion of the void and define an unoccupied remainder portion in the void of the mold. The mold is heated to a casting temperature, and a molten metallic casting material is added to the mold. The melting temperature of the molten metallic casting material is less than the melting temperature of the inorganic particles. The molten metallic casting material infiltrates the remainder portion in the mold. The mold is cooled to solidify the molten metallic casting material and bind the at least one sintered cemented carbide and, if present, the at least one non-cemented carbide piece, and the hard particles into the fixed-cutter earth-boring bit. The cemented carbide piece is positioned within the void to form at least part of a blade region of the fixed-cutter earth-boring bit, and the non-cemented carbide piece, if present, forms at least a part of an attachment region of the fixed-cutter earth-boring bit.

According to one non-limiting aspect of the present disclosure, an article of manufacture disclosure includes at least one cemented carbide piece, and a joining phase binding the at least one cemented carbide piece into the article of manufacture, wherein the joining phase is composed of a eutectic alloy material.

A further non-limiting aspect according to the present disclosure is directed to a method of making an article of manufacture comprising a cemented carbide portion, wherein the method includes placing a sintered cemented carbide piece next to at least one adjacent piece. The sintered cemented carbide piece and the adjacent piece define a filler space. A blended powder composed of a metal alloy eutectic composition is added to the filler space. The cemented carbide piece,

6

the adjacent piece, and the powder are heated to at least a eutectic melting point of the metal alloy eutectic composition. The cemented carbide piece, the adjacent piece, and the metal alloy eutectic composition are cooled, and the solidified metal alloy eutectic material joins the cemented carbide component and the adjacent component.

BRIEF DESCRIPTION OF THE DRAWINGS

The features and advantages of methods and articles of manufacture described herein may be better understood by reference to the accompanying drawings in which:

FIG. 1 is a schematic perspective view of a fixed-cutter earth-boring bit body fabricated from either solid cemented carbide or infiltrated hard particles;

FIG. 2 is a schematic side view of one non-limiting embodiment of an article of manufacture including cemented carbide according to the present disclosure;

FIG. 3 is a schematic perspective view of a non-limiting embodiment of a fixed-cutter earth-boring bit according to the present disclosure;

FIG. 4 is a flow chart summarizing one non-limiting embodiment of a method of making complex articles of manufacture including cemented carbide according to the present disclosure;

FIG. 5 is a photograph of a section through an article of manufacture including cemented carbide made by a non-limiting embodiment of a method according to the present disclosure;

FIGS. 6A and 6B are low magnification and high magnification photomicrographs, respectively, of an interfacial region between a sintered cemented carbide piece and a composite matrix including cast tungsten carbide particles embedded in a continuous bronze phase in an article of manufacture made by a non-limiting embodiment of a method according to the present disclosure;

FIG. 7 is a photograph of a non-limiting embodiment of an article of manufacture including cemented carbide pieces joined together by a eutectic alloy of nickel and tungsten carbide according to the present disclosure;

FIG. 8 is a photograph of a non-limiting embodiment of a fixed-cutter earth-boring bit according to the present disclosure;

FIG. 9 is a photograph of sintered cemented carbide blade pieces incorporated in the fixed-cutter earth-boring bit shown in FIG. 8;

FIG. 10 is a photograph of the graphite mold and mold components used to fabricate the earth-boring bit depicted in FIG. 8 using the cemented carbide blade pieces shown in FIG. 9 and the graphite spacers shown in FIG. 11;

FIG. 11 is a photograph of graphite spacers used to fabricate the earth-boring bit depicted in FIG. 8;

FIG. 12 is a photograph depicting a top view of the assembled mold assembly that was used to make the fixed-cutter earth-boring bit depicted in FIG. 8; and

FIG. 13 is a photomicrograph of an interfacial region of a cemented carbide blade piece and machinable non-cemented carbide, metallic piece incorporated in the fixed-cutter earth-boring bit depicted in FIG. 8.

The reader will appreciate the foregoing details, as well as others, upon considering the following detailed description of certain non-limiting embodiments according to the present disclosure.

DETAILED DESCRIPTION OF CERTAIN NON-LIMITING EMBODIMENTS

In the present description of non-limiting embodiments, other than in the operating examples or where otherwise

indicated, all numbers expressing quantities or characteristics are to be understood as being modified in all instances by the term “about”. Accordingly, unless indicated to the contrary, any numerical parameters set forth in the following description are approximations that may vary depending on the desired properties one seeks to obtain by the methods and in the articles according to the present disclosure. At the very least, and not as an attempt to limit the application of the doctrine of equivalents to the scope of the claims, each such numerical parameter should at least be construed in light of the number of reported significant digits and by applying ordinary rounding techniques.

Any patent, publication, or other disclosure material, in whole or in part, that is said to be incorporated by reference herein is incorporated herein only to the extent that the incorporated material does not conflict with existing definitions, statements, or other disclosure material set forth in this disclosure. As such, and to the extent necessary, the disclosure as set forth herein supersedes any conflicting material incorporated herein by reference. Any material, or portion thereof, that is said to be incorporated by reference herein, but which conflicts with existing definitions, statements, or other disclosure material set forth herein is only incorporated to the extent that no conflict arises between that incorporated material and the existing disclosure material.

According to an aspect of the present disclosure, an article of manufacture such as, for example, but not limited to, an earth-boring bit body, includes at least one cemented carbide piece and a joining phase that binds the cemented carbide piece into the article. The cemented carbide piece is a sintered material and forms a portion of the final article. The joining phase may include inorganic particles and a continuous metallic matrix including at least one of a metal and a metallic alloy. It is recognized in this disclosure that unless specified otherwise hereinbelow, the terms “cemented carbide”, “cemented carbide material”, and “cemented carbide composite” refer to a sintered cemented carbide. Also, unless specified otherwise hereinbelow, the term “non-cemented carbide” as used herein refers to a material that either does not include cemented carbide material or, in other embodiments, includes less than 2% by volume cemented carbide material.

FIG. 2 is a schematic side view representation of one non-limiting embodiment of a complex cemented carbide-containing article 30 according to the present disclosure. Article 30 includes three sintered cemented carbide pieces 32 disposed at predetermined positions within the article 30. In certain non-limiting embodiments, the combined volume of one or more sintered cemented carbide pieces in an article according to the present disclosure is at least 5% of the article’s total volume, or in other embodiments may be at least 10% of the article’s total volume. According to a possible further aspect of the present disclosure, article 30 also includes a non-cemented carbide piece 34 disposed at a predetermined position in the article 30. The cemented carbide pieces 32 and the non-cemented carbide piece 34 are bound into the article 30 by a joining phase 36 that includes a plurality of inorganic particles 38 in a continuous metallic matrix 40 that includes at least one of a metal and a metallic alloy. While FIG. 1 depicts three cemented carbide pieces 32 and a single non-cemented carbide piece 34 bonded into the article 30 by the joining phase 36, any number of cemented carbide pieces and, if present, non-cemented carbide pieces may be included in articles according to the present disclosure. It also will be understood that certain non-limiting articles according to the present disclosure may lack non-cemented carbide pieces.

While not meant to be limiting, in certain embodiments the one or more cemented carbide pieces included in articles according to the present disclosure may be prepared by conventional techniques used to make cemented carbide. One such conventional technique involves pressing precursor powders to form compacts, followed by sintering to densify the compacts and metallurgically bind the powder components together, as generally discussed above. The details of pressing-and-sinter techniques applied to the fabrication of cemented carbides are well known to persons having ordinary skill in the art, and further description of such details need not be provided herein.

In certain non-limiting embodiments of articles including cemented carbide according to the present disclosure, the one or more cemented carbide pieces bonded into the article by the joining phase include a discontinuous, dispersed phase of at least one carbide of a metal selected from Groups IVB, a Group VB, or a Group VIB of the Periodic Table, and a continuous binder phase comprising one or more of cobalt, a cobalt alloy, nickel, a nickel alloy, iron, and an iron alloy. In still other non-limiting embodiments, the binder phase of a cemented carbide piece includes at least one additive selected from chromium, silicon, boron, aluminum, copper, ruthenium, and manganese. In certain non-limiting embodiments, the binder phase of a cemented carbide piece may include up to 20 weight percent of the additive. In other non-limiting embodiments, the binder phase of a cemented carbide piece may include up to 15 weight percent, up to 10 weight percent, or up to 5 weight percent of the additives.

All or some of the cemented carbide pieces in certain non-limiting embodiments of articles according to the present disclosure may have the same composition or are of the same cemented carbide grade. Such grades include, for example, cemented carbide grades including a tungsten carbide discontinuous phase and a cobalt-containing continuous binder phase. The various commercially available powder blends used to produce various cemented carbide grades are well known to those of ordinary skill in the art. The various cemented carbide grades typically differ in one or more of carbide particle composition, carbide particle grain size, binder phase volume fraction, and binder phase composition, and these variations influence the final properties of the composite material. In certain embodiments, the grade of cemented carbide from which two or more of the carbide pieces included in the article varies. The grades of cemented carbide in the cemented carbide pieces included in articles according to the present disclosure may be varied throughout the article to provide desired combinations of properties such as, for example, toughness, hardness, and wear resistance, at different regions of the article. Also, the size and shape of cemented carbide pieces and, if present, non-cemented carbide pieces included in articles of the present disclosure may be varied as desired depending on the properties desired at different regions of the article. In addition, the total volume of cemented carbide pieces and, if present, non-cemented carbide pieces may be varied to provide properties required of the article, although the total volume of cemented carbide pieces is at least 5%, or in other cases is at least 10%, of the article’s total volume.

In non-limiting embodiments of the article, one or more cemented carbide pieces included in the article are composed of hybrid cemented carbide. As known to those having ordinary skill, cemented carbide is a composite material that typically includes a discontinuous phase of hard metal carbide particles dispersed throughout and embedded in a continuous metallic binder phase. As also known to those having ordinary skill, a hybrid cemented carbide comprises a discon-

tinuous phase of hard particles of a first cemented carbide dispersed throughout and embedded in a continuous binder phase of a second cemented carbide grade. As such, a hybrid cemented carbide may be thought of as a composite of different cemented carbides.

The hard discontinuous phase of each cemented carbide included in a hybrid cemented carbide typically comprises a carbide of at least one of the transition metals, which are the elements found in Groups IVB, VB, and VIB of the Periodic Table. Transition metal carbides commonly included in hybrid cemented carbides include carbides of titanium, vanadium, chromium, zirconium, hafnium, molybdenum, niobium, tantalum, and tungsten. The continuous binder phase, which binds or "cements" together the metal carbide grains, typically is selected from cobalt, a cobalt alloy, nickel, a nickel alloy, iron, and an iron alloy. Additionally, one or more alloying elements such as, for example, tungsten, titanium, tantalum, niobium, aluminum, chromium, copper, manganese, molybdenum, boron, carbon, silicon, and ruthenium, may be included in the continuous phase to enhance certain properties of the composites. In one non-limiting embodiment of an article according to the present disclosure, the article includes one or more pieces of a hybrid cemented carbide in which the binder concentration of the dispersed phase of the hybrid cemented carbide is 2 to 15 weight percent of the dispersed phase, and the binder concentration of the continuous binder phase of the hybrid cemented carbide is 6 to 30 weight percent of the continuous binder phase. Such an article optionally also includes one or more pieces of conventional cemented carbide material and one or more pieces of non-cemented carbide material. The one or more hybrid cemented carbide pieces, along with any conventional cemented carbide pieces and non-cemented carbide pieces are contacted by and bound within the article by a continuous joining phase that includes at least one of a metal and a metallic alloy. Each particular piece of cemented carbide or non-cemented carbide material may have a size and shape and is positioned at a desired predetermined position to provide various regions of the final article with desired properties.

The hybrid cemented carbides of certain non-limiting embodiments of articles according to the present disclosure may have relatively low contiguity ratios, thereby improving certain properties of the hybrid cemented carbides relative to other cemented carbides. Non-limiting examples of hybrid cemented carbides that may be used in embodiments of articles according to the present disclosure are found in U.S. Pat. No. 7,384,443, which is hereby incorporated by reference herein in its entirety. Certain embodiments of hybrid cemented carbide composites that may be included in articles herein have a contiguity ratio of the dispersed phase that is no greater than 0.48. In some embodiments, the contiguity ratio of the dispersed phase of the hybrid cemented carbide may be less than 0.4, or less than 0.2. Methods of forming hybrid cemented carbides having relatively low contiguity ratios and a metallographic technique for measuring contiguity ratios are detailed in the incorporated U.S. Pat. No. 7,384,443.

According to another aspect of the present disclosure, the article made according to the present disclosure includes one or more non-cemented carbide pieces bound in the article by the joining phase of the article. In certain embodiments, a non-cemented carbide piece included in the article is a solid metallic component consisting of a metallic material selected from iron, iron alloys, nickel, nickel alloys, cobalt, cobalt alloys, copper, copper alloys, aluminum, aluminum alloys, titanium, titanium alloys, tungsten, and tungsten alloys. In other non-limiting embodiments, a non-cemented carbide piece included in the article is a composite material including

metal or metallic alloy grains, particles, and/or powder dispersed in a continuous metal or metal alloy matrix. In an embodiment, the continuous metal or metallic alloy matrix of the composite material of the non-cemented carbide piece is the matrix material of the joining phase. In certain non-limiting embodiments, a non-cemented carbide piece is a composite material including particles or grains of a metallic material selected from tungsten, a tungsten alloy, tantalum, a tantalum alloy, molybdenum, a molybdenum alloy, niobium, and a niobium alloy. In one particular embodiment, a non-cemented carbide piece included in an article according to the present disclosure comprises tungsten grains dispersed in a matrix of a metal or a metallic alloy. In certain embodiments, a non-cemented carbide piece included in an article herein may be machined to include threads or other features so that the article may be mechanically attached to another article.

According to one specific non-limiting embodiment of an article according to the present disclosure, the article is one of a fixed-cutter earth-boring bit and a roller cone earth-boring bit including a machinable non-cemented carbide piece bonded to the article by the joining phase, and wherein the non-cemented carbide piece is or may be machined to include threads or other features adapted to connect the bit to an earth-boring drill string. In certain specific embodiments, the machinable non-cemented carbide piece is made of a composite material including a discontinuous phase of tungsten particles dispersed and embedded within a matrix of bronze.

According to a non-limiting embodiment, the joining phase of an article according to the present disclosure, which binds the one or more cemented carbide pieces and, if present, the one or more non-cemented carbide pieces in the article, includes inorganic particles. The inorganic particles of the joining phase include, but are not limited to, hard particles that are at least one of a carbide, a boride, an oxide, a nitride, a silicide, a sintered cemented carbide, a synthetic diamond, and a natural diamond. In another non-limiting embodiment, the hard particles include at least one carbide of a metal selected from Groups IVB, VB, and VIB of the Periodic Table. In yet other non-limiting embodiments, the hard particles of the joining phase are tungsten carbide particles and/or cast tungsten carbide particles. As known to those having ordinary skill in the art, cast tungsten carbide particles are particles composed of a mixture of WC and W_2C , which may be a eutectic composition.

According to another non-limiting embodiment, the joining phase of an article according to the present disclosure, which binds the one or more cemented carbide pieces and, if present, the one or more non-cemented carbide pieces in the article includes inorganic particles that are one or more of metallic particles, metallic grains, and/or metallic powder. In certain non-limiting embodiments, the inorganic particles of the joining phase include particles or grains of a metallic material selected from tungsten, a tungsten alloy, tantalum, a tantalum alloy, molybdenum, a molybdenum alloy, niobium, and a niobium alloy. In one particular embodiment, inorganic particles in a joining phase according to the present disclosure comprise one or more of tungsten grains, particles, and/or powders dispersed in a matrix of a metal or a metallic alloy. In certain embodiments, the inorganic particles of the joining phase of an article herein are metallic particles, and the joining phase of an article is machinable and may be machined to include threads, bolt or screw holes, or other features so that the article may be mechanically attached to another article. In one embodiment according to the present disclosure, the article is an earth boring bit body and is machined or machinable to include threads, bolt and/or screw holes, or other

attachment features so as to be attachable to an earth-boring drill string or other article of manufacture.

In another non-limiting embodiment, the joining phase of an article according to the present disclosure, which binds the one or more cemented carbide pieces and, if present, the one or more non-cemented carbide pieces in the article, includes inorganic particles that are a mixture of metallic particles and ceramic or other hard inorganic particles.

According to an aspect of this disclosure, in certain embodiments, the melting temperature of the inorganic particles of the joining phase is higher than the melting temperature of a matrix material of the joining phase, which binds together the inorganic particles in the joining phase. In a non-limiting embodiment, the inorganic hard particles of the joining phase have a higher melting temperature than the matrix material of the joining phase. In still another non-limiting embodiment, the inorganic metallic particles of the joining phase have a higher melting temperature than the matrix material of the joining phase.

The metallic matrix of the joining phase in some non-limiting embodiments of an article according to the present disclosure includes at least one of nickel, a nickel alloy, cobalt, a cobalt alloy, iron, an iron alloy, copper, a copper alloy, aluminum, an aluminum alloy, titanium, and a titanium alloy. In one embodiment, the metallic matrix is brass. In another embodiment, the metallic matrix is bronze. In one embodiment, the metallic matrix is a bronze comprising about 78 weight percent copper, about 10 weight percent nickel, about 6 weight percent manganese, about 6 weight percent tin, and incidental impurities.

According to certain non-limiting embodiments encompassed by the present disclosure, the article is one of a fixed-cutter earth-boring bit, a fixed-cutter earth-boring bit body, a roller cone for a rotary cone bit, or another part for an earth-boring bit.

One non-limiting aspect of the present disclosure is embodied in a fixed-cutter earth-boring bit **50** shown in FIG. **3**. The fixed-cutter earth-boring bit **50** includes a plurality of blade regions **52** which are at least partially formed from sintered cemented carbide disposed in the void of the mold used to form the bit **50**. In certain non-limiting embodiments, the total volume of sintered carbide pieces is at least about 5%, or may be at least about 10% of the total volume of the fixed-cutter earth-boring bit **50**. Bit **50** further includes a metal matrix composite region **54**. The metal matrix composite comprises hard particles dispersed in a metal or metallic alloy and joins to the cemented carbide pieces of the blade regions **52**. The bit **50** is formed by methods according to the present disclosure. Although the non-limiting example depicted in FIG. **3** includes six blade regions **52** including six individual cemented carbide pieces, it will be understood that the number of blade regions and individual cemented carbide pieces included in the bit can be of any number. Bit **50** also includes a machinable attachment region **59** that is at least partially formed from a non-cemented carbide piece that was disposed in the void of the mold used to form the bit **50**, and which is bonded in the bit by the metal matrix composite. According to one non-limiting embodiment, the non-cemented carbide piece included in the machinable attachment region includes a discontinuous phase of tungsten particles dispersed and embedded within a matrix of bronze.

It is known that some regions of an earth-boring bit are subjected to a greater degree of stress and/or abrasion than other regions on the earth-boring bit. For example, the blade regions of certain fixed-cutter earth-boring bit onto which polycrystalline diamond compact (PDC) inserts are attached are typically subject to high shear forces, and shear fracture of

the blade regions is a common mode of failure in PDC-based fixed-cutter earth-boring bits. Forming the bit bodies of solid cemented carbide provides strength to the blade regions, but the blade regions may distort during sintering. Distortions of this type can result in incorrect positioning of the PDC cutting inserts on the blade regions, which can cause premature failure of the earth-boring bit. Certain embodiments of earth-boring bit bodies embodied within the present disclosure do not suffer from the risks for distortion suffered by certain cemented carbide bit bodies. Certain embodiments of bit bodies according to the present disclosure also do not suffer from the difficulties presented by the need to machine solid cemented carbide compacts to form bits of complex shapes from the compacts. In addition, in certain known solid cemented carbide bit bodies, expensive cemented carbide material is included in regions of the bit body that do not require the strength and abrasion resistance of the blade regions.

In fixed-cutter earth-boring bit **50** of FIG. **3**, the blade regions **52**, which are highly stressed and subject to substantial abrasive forces, are composed entirely or principally of strong and highly abrasion resistant cemented carbide, while regions of the bit **50** separating the blade regions **54**, which are regions in which strength and abrasion resistance are less critical, may be constructed from conventional infiltrated metal matrix composite materials. The metal matrix composite regions **54** are bonded directly to the cemented carbide within the blade regions **52**. In certain non-limiting embodiments, gage pads **56** and mud nozzle regions **58** also may be constructed of cemented carbide pieces that are disposed in the mold void used to form the bit **50**. More generally, any region of the bit **50** that requires substantial strength, hardness, and/or wear resistance may include at least portions composed of cemented carbide pieces positioned within the mold and which are bonded into the bit **50** by the infiltrated metal matrix composite.

In non-limiting embodiments of an earth-boring bit or bit part according to the present disclosure, the at least one cemented carbide piece or region comprises at least one carbide of a metal selected from Groups IVB, VB, and VIB of the Periodic Table, and a binder comprising one or more of cobalt, a cobalt alloy, nickel, a nickel alloy, iron, and an iron alloy. In other embodiments, the binder of the cemented carbide region includes at least one additive selected from chromium, silicon, boron, aluminum, copper, ruthenium, and manganese.

The cemented carbide portions of an earth-boring bit according to the present disclosure may include hybrid cemented carbide. In certain non-limiting embodiments, the hybrid cemented carbide composite has a contiguity ratio of a dispersed phase that is less than or equal to 0.48, less than 0.4, or less than 0.2.

In an additional embodiment, an earth-boring bit may include at least one non-cemented carbide region. The non-cemented carbide region may be a solid metallic region composed of at least one of iron, an iron alloy, nickel, a nickel alloy, cobalt, a cobalt alloy, copper, a copper alloy, aluminum, an aluminum alloy, titanium, a titanium alloy, tungsten, and a tungsten alloy. In other embodiments of an earth-boring bit according to the present disclosure, the at least one metallic region includes metallic grains dispersed in a metallic matrix, thereby providing a metal matrix composite. In a non-limiting embodiment, the metal grains may be selected from tungsten, a tungsten alloy, tantalum, a tantalum alloy, molybdenum, a molybdenum alloy, niobium, and a niobium alloy. In another non-limiting embodiment of a fixed-cutter earth-boring bit having a non-cemented carbide region that is a metal matrix

composite including metallic grains embedded in a metal or a metallic alloy, the metal or metallic alloy of the metallic matrix region also is the same as that of the matrix material of the joining phase binding the at least one cemented carbide piece into the article.

According to certain embodiments, an earth-boring bit includes a machinable metallic region, which is machined to include threads or other features to thereby provide an attachment region for attaching the bit to a drill string or other structure.

In another non-limiting embodiment, the hard particles in the metallic matrix composite from which the non-cemented carbide region is formed includes hard particles of at least one of a carbide, a boride, an oxide, a nitride, a silicide, a sintered cemented carbide, a synthetic diamond, and a natural diamond. For examples, the hard particles include at least one carbide of a metal selected from Groups IVB, VB, and VIB of the Periodic Table. In certain embodiments, the hard particles are tungsten carbide and/or cast tungsten carbide.

The metallic matrix of the metal matrix composite may include, for example, at least one of nickel, a nickel alloy, cobalt, a cobalt alloy, iron, an iron alloy, copper, a copper alloy, aluminum, an aluminum alloy, titanium, and a titanium alloy. In embodiments, the matrix is a brass alloy or a bronze alloy. In one embodiment, the matrix is a bronze alloy that consists essentially of about 78 weight percent copper, about 10 weight percent nickel, about 6 weight percent manganese, about 6 weight percent tin, and incidental impurities.

Referring now to the flow diagram of FIG. 4, according to one aspect of this disclosure, a method for forming an article 60 comprises providing a cemented carbide piece (step 62), and placing one or more cemented carbide pieces and/or non-cemented carbide pieces adjacent to the first cemented carbide (step 64). In non-limiting embodiments, the total volume of the cemented carbide pieces placed in the mold is at least 5%, or may be at least 10%, of the total volume of the article made in the mold. The pieces may be positioned within the void of a mold, if desired. The space between the various pieces defines an unoccupied space. A plurality of inorganic particles are added at least a portion of the unoccupied space (step 66). The remaining void space between the plurality of inorganic particles and the various cemented carbide and non-cemented carbide pieces define a remainder space. The remainder space is at least partially filled with a metal or metal alloy matrix material (step 68) which, together with the inorganic particles, forms a composite joining material. The joining material bonds together the inorganic particles and the one or more cemented carbide and, if present, non-cemented carbide pieces.

According to one non-limiting aspect of this disclosure, the remainder space is filled by infiltrating the remainder space with a molten metal or metal alloy. Upon cooling and solidification, the metal or metal alloy binds the cemented carbide piece, the non-cemented carbide piece, if present, and the inorganic particles to form the article of manufacture. In a non-limiting embodiment, a mold containing the pieces and the inorganic particles is heated to or above the melting temperature of the metal or metal alloy infiltrant. In a non-limiting embodiment, infiltration occurs by pouring or casting the molten metal or metal alloy into the heated mold until at least a portion of the remainder space is filled with the molten metal or metal alloy.

An aspect of a method of this disclosure is to use a mold to manufacture the article. The mold may consist of graphite or any other chemically inert and temperature resistant material known to a person having ordinary skill in the art. In a non-limiting embodiment, at least two cemented carbide pieces

are positioned in the void at predetermined positions. Spacers may be placed in the mold to position at least one of the cemented carbide pieces and, if present, the non-cemented carbide pieces in the predetermined positions. The cemented carbide pieces may be positioned in a critical area, such as, but not limited to, a blade portion of an earth-boring bit requiring high strength, wear resistance, hardness, or the like.

In a non-limiting embodiment, the cemented carbide piece is composed of at least one carbide of a Group IVB, a Group VB, or a Group VIB metal of the Periodic Table; and a binder composed of one or more of cobalt, cobalt alloys, nickel, nickel alloys, iron, and iron alloys. In some embodiments, the binder of the cemented carbide piece contains an additive selected from the group consisting of chromium, silicon, boron, aluminum, copper ruthenium, manganese, and mixtures thereof. The additive may include up to 20 weight percent of the binder.

In other non-limiting embodiments, the cemented carbide piece comprises a hybrid cemented carbide composite. In some embodiments, a dispersed phase of the hybrid cemented carbide composite has a contiguity ratio of 0.48 or less, less than 0.4, or less than 0.2.

Without limitation, a non-cemented carbide piece may be positioned in the mold at a predetermined position. In non-limiting embodiments, the non-cemented carbide piece is a metallic material composed of at least one of a metal and a metallic alloy. In further non-limiting embodiments, the metal includes at least one of iron, an iron alloy, nickel, a nickel alloy, cobalt, a cobalt alloy, copper, a copper alloy, aluminum, an aluminum alloy, titanium, a titanium alloy, tungsten and a tungsten alloy.

In another non-limiting embodiment, a plurality of metal grains, particles, and/or powders are added to a portion of the mold. The plurality of metal grains contribute, together with the plurality of inorganic particles, to define the remainder space, which is subsequently infiltrated by the molten metal or metal alloy. In some non-limiting embodiments, the metal grains include at least one of tungsten, a tungsten alloy, tantalum, a tantalum alloy, molybdenum, a molybdenum alloy, niobium, and a niobium alloy. In a specific embodiment, the metal grains are composed of tungsten.

In a non-limiting embodiment, the inorganic particles partially filling the unoccupied space are hard particles. In embodiments, hard particles include one or more of a carbide, a boride, an oxide, a nitride, a silicide, a sintered cemented carbide, a synthetic diamond, or a natural diamond. In another non-limiting embodiment, the hard particles comprise at least one carbide of a metal selected from Groups IVB, VB, and VIB of the Periodic Table. In other specific embodiments, the hard particles are selected to be composed of tungsten carbide and/or cast tungsten carbide.

In another non-limiting embodiment, the inorganic particles partially filling the unoccupied space are metallic grains, particles and/or powders. The metal grains define the remainder space, which is subsequently infiltrated by the molten metal or metal alloy. In some non-limiting embodiments, the metal grains include at least one of tungsten, a tungsten alloy, tantalum, a tantalum alloy, molybdenum, a molybdenum alloy, niobium, and a niobium alloy. In a specific embodiment, the metal grains are composed of tungsten.

The molten metal or metal alloy used to infiltrate the remainder space include, but are not limited to, one or more of nickel, a nickel alloy, cobalt, a cobalt alloy, iron, an iron alloy, copper, a copper alloy, aluminum, an aluminum alloy, titanium, a titanium alloy, a bronze, and a brass. It is often useful from a process standpoint to use an infiltrating molten metal or metal alloy that has a relatively low melting temperature.

Thus, alloys of brass or bronze are employed in non-limiting embodiments of the molten metal or metal alloy used to infiltrate the remainder space. In a specific embodiment, a bronze alloy composed of 78 weight percent copper, 10 weight percent nickel, 6 weight percent manganese, 6 weight percent tin, and incidental impurities is selected as the infiltrating molten metal or metal alloy.

According to aspects of embodiments of methods for manufacturing an article of manufacture containing cemented carbides, disclosed herein, an article of manufacture may include, but is not limited to, a fixed-cutter earth-boring bit body and a roller cone of a rotary cone bit.

According to another aspect of this disclosure, a method of manufacturing a fixed-cutter earth-boring bit is disclosed. A method for manufacturing a fixed-cutter earth-boring bit includes positioning at least one sintered cemented carbide piece and, optionally, at least one non-cemented carbide piece into a mold, thereby defining an unoccupied portion of a void in the mold. In non-limiting embodiments, the total volume of the cemented carbide pieces placed in the mold is 5% or greater, or 10% or greater, than the total volume of the fixed-cutter earth-boring bit. Hard particles are disposed in the unoccupied portion of the mold to occupy a portion of the unoccupied portion of the void, and to define an unoccupied remainder portion of the void of the mold. The unoccupied remainder portion of the void is, generally the space between the hard particles, and the space between the hard particles and the individual pieces in the mold. The mold is heated to a casting temperature. A molten metallic casting material is added to the mold. The casting temperature is a temperature at or above the melting temperature of the metallic casting material. Typically, the metallic casting temperature is at or near the melting temperature of the metallic casting material. The molten metallic casting material infiltrates the unoccupied remainder portion. The mold is cooled to solidify the metallic casting material and bind the at least one sintered cemented carbide piece, the non-cemented carbide piece, if present, and the hard particles, thus forming a fixed-cutter earth-boring bit. In a non-limiting embodiment, the cemented carbide piece is positioned within the void of the mold to form at least a part of a blade region of the fixed-cutter earth-boring bit. In another non-limiting embodiment, the non-cemented carbide piece, when present, forms at least a part of an attachment region of the fixed-cutter earth-boring bit.

In an embodiment, at least one graphite spacer, or a spacer made from another inert material, is positioned in the void of the mold. The void of the mold and the at least one graphite spacer, if present, define an overall shape of the fixed-cutter earth-boring bit.

In some embodiments, when a non-cemented carbide piece composed of a metallic material is disposed in the void, the non-cemented carbide metallic piece forms a machinable region of the fixed-cutter earth-boring bit. The machinable region typically is threaded to facilitate attaching the fixed-cutter earth-boring bit to the distal end of a drill string. In other embodiments, other types of mechanical fasteners, such as but not limited to grooves, tongues, hooks and the like, may be machined into the machinable region to facilitate fastening of the earth-boring bit to a tool, tool holder, drill string or the like. In non-limiting embodiments, the machinable region includes at least one of iron, an iron alloy, nickel, a nickel alloy, cobalt, a cobalt alloy, copper, a copper alloy, aluminum, an aluminum alloy, titanium, a titanium alloy, tungsten and a tungsten alloy.

Another process for incorporating a machinable region into the earth-boring bit is by disposing hard inorganic particles into the void in the form of metallic grains. In a non-

limiting embodiment, the metallic grains are added only to a portion of the void of the mold. The metallic grains define an empty space in between the metallic grains. When the molten metallic casting material is added to the mold, the molten metallic casting material infiltrates the empty space between the metal grains to form metal grains in a matrix of solidified metallic casting material, thus forming a machinable region on the earth-boring bit. In non-limiting embodiments, the metal grains include at least one or more of tungsten, a tungsten alloy, tantalum, a tantalum alloy, molybdenum, a molybdenum alloy, niobium, and a niobium alloy. In a specific embodiment, the metal grains are tungsten. Another non-limiting embodiment includes threading the machinable region.

Typically, but not necessarily, the at least one sintered cemented carbide piece is composed of at least one carbide of a metal selected from Groups IVB, VB, and VIB of the Periodic Table, and a binder that includes at least one of cobalt, a cobalt alloy, nickel, a nickel alloy, iron, and an iron alloys. The binder can include up to 20 weight percent of an additive selected from the group consisting of chromium, silicon, boron, aluminum, copper ruthenium, manganese, and mixtures thereof. In another non-limiting embodiment, the at least one sintered cemented carbide makes up a minimum of 10 percent by volume of the earth-boring bit. In yet another embodiment, the at least one sintered cemented carbide includes a sintered hybrid cemented carbide composite. In embodiments, the hybrid cemented carbide composite has a contiguity ratio of a dispersed phase that is less than or equal to 0.48, or less than 0.4, or less than 0.2.

It may be desirable to have other areas of increased strength and wear resistance on an earth-boring bit, for example, but not limited to, in areas of a gage plate or a nozzle or an area around a nozzle. A non-limiting embodiment includes positioning at least one cemented carbide gage plate into the mold. Another non-limiting embodiment includes positioning at least one cemented carbide nozzle or nozzle region into the mold.

According to embodiments, hard inorganic particles typically include at least one of a carbide, a boride, and oxide, a nitride, a silicide, a sintered cemented carbide, a synthetic diamond, and a natural diamond. In other non-limiting embodiments, the hard inorganic particles include at least one of a carbide of a metal selected from Groups IVB, VB, and VIB of the Periodic Table; tungsten carbide; and cast tungsten carbide.

The metallic casting material may include at least one of nickel, a nickel alloy, cobalt, a cobalt alloy, iron, an iron alloy, copper, a copper alloy, aluminum, an aluminum alloy, titanium, a titanium alloy, a brass and a bronze. In other embodiments the metallic casting material comprises a bronze. In a specific embodiment, the bronze consists essentially of 78 weight percent copper, 10 weight percent nickel, 6 weight percent manganese, 6 weight percent tin, and incidental impurities.

After all of the sintered cemented carbide pieces, the non-cemented carbide pieces, if present, metallic hard inorganic particles, if present, and spacers are added to the mold, hard inorganic particles are added into the mold to a predetermined level. The predetermined level is determined by the particular engineering design of the earth-boring bit. The predetermined level for a particular engineering design is known to a person having ordinary skill in the art. In a non-limiting embodiment, the hard particles are added to just below the height of the cemented carbide pieces positioned in the area of a blade in the mold. In other non-limiting embodiments, the hard par-

ticles are added to be level with, or to be above, the height of the cemented carbide pieces in the mold.

As defined above, a casting temperature is typically a temperature at or above the melting temperature of the metallic casting material that is added to the mold. In a specific embodiment where the metallic casting material is a bronze alloy composed of 78 weight percent copper, 10 weight percent nickel, 6 weight percent manganese, 6 weight percent tin, and incidental impurities, the casting temperature is 1180° C.

The mold and the contents of the mold are cooled. Upon cooling, the metallic casting material solidifies and bonds together the sintered cemented carbide pieces; any non-cemented carbide pieces; and the hard particles into a composite fixed-cutter earth-boring bit. After removal from the mold, the fixed-cutter earth-boring bit can be finished by adding PDC inserts, machining the surfaces to remove excess metal matrix joining material, and any other finishing practice known to one having ordinary skill in the art to finish the molded product into a finished earth-boring bit.

According to another aspect of this disclosure, an article of manufacture includes at least one cemented carbide piece, and a joining phase composed of a eutectic alloy material binding the at least one cemented carbide piece into the article of manufacture. In some embodiments, the at least one cemented carbide piece has a cemented carbide volume that is at least 5%, or at least 10%, of a total volume of the article of manufacture. In non-limiting embodiments, at least one non-cemented carbide piece is bound into the article of manufacture by the joining phase.

According to certain embodiments, the at least one cemented carbide piece joined with the eutectic alloy material may comprise hard inorganic particles of at least one carbide of a metal selected from Groups IVB, VB, and VIB of the Periodic Table, dispersed in a binder comprising at least one of cobalt, a cobalt alloy, nickel, a nickel alloy, iron, and an iron alloy. In non-limiting embodiments, the binder of the cemented carbide piece includes at least one additive selected from chromium, silicon, boron, aluminum, copper, ruthenium, and manganese.

In an embodiment, the at least one cemented carbide piece includes a hybrid cemented carbide, and in another embodiment, the dispersed phase of the hybrid cemented carbide has a contiguity ratio no greater than 0.48.

In certain embodiments, the at least one cemented carbide piece is joined within the article by a eutectic alloy material, and the article includes at least one non-cemented carbide piece that is a metallic component. The metallic component may comprise, for example, at least one of iron, an iron alloy, nickel, a nickel alloy, cobalt, a cobalt alloy, copper, a copper alloy, aluminum, an aluminum alloy, titanium, a titanium alloy, tungsten, and a tungsten alloy.

In a specific embodiment, the eutectic alloy material is composed of 55 weight percent nickel and 45 weight percent tungsten carbide. In another specific embodiment, the eutectic alloy material is composed of 55 weight percent cobalt and 45 weight percent tungsten carbide. In other embodiments, the eutectic alloy component may be any eutectic composition, known now or hereafter to one having ordinary skill in the art, which upon solidification phase separates into a solid material composed of metallic grains interspersed with hard phase grains.

In non-limiting embodiments, the article of manufacture is one of a fixed-cutter earth-boring bit body, a roller cone, and a part for an earth-boring bit.

Another method of making an article of manufacture that includes cemented carbide pieces consists of placing a

cemented carbide piece next to at least one adjacent piece. A space between the cemented carbide piece and the adjacent piece defines a filler space. In a non-limiting embodiment, the cemented carbide piece and the adjacent piece are chamfered and the chamfers define the filler space. A powder that consists of a metal alloy eutectic composition is added to the filler space. The cemented carbide piece, the adjacent piece, and the powder are heated to at least the eutectic melting point of the metal alloy eutectic composition where the powder melts. After cooling the solidified metal alloy eutectic composition joins the cemented carbide component and the adjacent component.

In a non-limiting embodiment, placing the cemented carbide piece next to at least one adjacent piece includes placing the sintered cemented carbide piece next to another sintered cemented carbide piece.

In another non-limiting embodiment, placing the cemented carbide piece next to at least one adjacent piece includes placing the sintered cemented carbide piece next to a non-cemented carbide piece. The non-cemented carbide piece may include, but is not limited to, a metallic piece.

In a specific embodiment, adding a blended powder includes adding a blended powder comprising about 55 weight percent nickel and about 45 weight percent tungsten carbide. In another specific embodiment, adding a blended powder includes adding a blended powder comprising about 55 weight percent cobalt and about 45 weight percent tungsten carbide. In other embodiments, adding a blended powder includes adding any eutectic composition, known now or hereafter to one having ordinary skill in the art, which upon solidification forms a material comprising metallic grains interspersed with hard phase grains.

In embodiments wherein the blended powder comprises about 55 weight percent nickel and about 45 weight percent tungsten carbide, heating the cemented carbide piece, the adjacent piece, and the powder to at least a eutectic melting point of the metal alloy eutectic composition includes heating to a temperature of 1350° C. or greater. In non-limiting embodiments, heating the cemented carbide piece, the adjacent piece, and the powder to at least a eutectic melting point of the metallic alloy eutectic composition includes heating in an inert atmosphere or a vacuum.

Example 1

FIG. 5 is a photograph of a composite article 70 made according to embodiments of a method of the present disclosure. The article 70 includes several individual sintered cemented carbide pieces 72 bonded together by a joining phase 74 comprising hard inorganic particles dispersed in a metallic matrix. The individual sintered cemented carbide pieces 72 were fabricated by conventional techniques. The cemented carbide pieces 72 were positioned in a cylindrical graphite mold, and an unoccupied space was defined between the pieces 72. Cast tungsten carbide particles were placed in the unoccupied space, a remainder space existed between the individual tungsten carbide particles. The mold containing the cemented carbide pieces 72 and the cast tungsten carbide particles was heated to a temperature of 1180° C. A molten bronze was introduced into the void of the mold and infiltrated the remainder space, binding together the cemented carbide pieces and the cast tungsten carbide particles. The composition of the bronze was 78% (w/w) copper, 10% (w/w) nickel, 6% (w/w) manganese, and 6% (w/w) tin. The bronze was cooled and solidified, forming a metal matrix composite of the cast tungsten carbide particles embedded in solid bronze.

Photomicrographs of the interfacial region between a cemented carbide piece **72** and the metal matrix composite **74**, comprising the cast tungsten carbide particles **75** in the bronze matrix **76**, of the article **60** are shown in FIG. **6A** (low magnification) and FIG. **6B** (higher magnification). Referring to FIG. **6B**, the infiltration process resulted in a distinct interfacial zone **78** that appears to include bronze casting material dissolved in an outer layer of the cemented carbide piece **62**, where the bronze mixed with the binder phase of the cemented carbide piece **62**. In general, it is believed that interfacial zones exhibiting the form of diffusion bonding shown in FIG. **6B** exhibit strong bond strengths.

Example 2

FIG. **7** is a photograph of an additional composite article **80** made according to embodiments of a method of the present disclosure. Article **80** comprises two sintered cemented carbide pieces **81** bonded in the article **80** by a Ni—WC alloy **82** having a eutectic composition. The article **80** was made by disposing a powder blend consisting of 55% (w/w) nickel powder and 45% (w/w) tungsten carbide powder in a chamfered region between the two cemented carbide pieces **81**. The assembly was heated in a vacuum furnace at a temperature of 1350° C. which was above the melting point of the powder blend. The molten material was cooled and solidified in the chamfered region as the Ni—WC alloy **82**, bonding together the cemented carbide pieces **81** to form the article **80**.

Example 3

FIG. **8** is a photograph of a fixed-cutter earth-boring bit **84** according to a non-limiting embodiment according of the present disclosure. The fixed-cutter earth-boring bit **84** includes sintered cemented carbide pieces forming blade regions **85** bound into the bit **84** by a first metallic joining material **86** including cast tungsten carbide particles dispersed in a bronze matrix. Polycrystalline diamond compacts **87** were mounted in insert pockets defined within the sintered cemented carbide pieces forming the blade regions **85**. A non-cemented carbide piece also was bonded into the bit **84** by a second metallic joining material and formed a machinable attachment region **88** of the bit **84**. The second joining material was a metallic composite including tungsten powder (or grains) dispersed in a bronze casting alloy.

Referring now to FIGS. **8-12**, the fixed-cutter earth-boring bit **84** illustrated in FIG. **8** was fabricated as follows. FIG. **9** is a photograph of sintered cemented carbide pieces **90** included in the bit **84**, which formed the blade regions **85**. The sintered cemented carbide pieces **90** were made using conventional powder metallurgy techniques including steps of powder compaction, machining the compact in a green and/or brown (i.e. presintered) condition, and high temperature sintering.

The graphite mold and mold components **100** used to fabricate the earth-boring bit **84** of FIG. **8** are shown in FIG. **10**. Graphite spacers **110** that were placed in the mold are shown in FIG. **11**. The sintered cemented carbide blades **90**, graphite spacers **110**, and other graphite mold components **100** were positioned in the mold. FIG. **12** is a view looking into the void of the mold and showing the positioning of the various components to provide the final mold assembly **120**. Crystalline tungsten powder was first introduced into a region of the void space in the mold assembly **120** to form a discontinuous phase of the machinable attachment region **88** of the bit **84**. Cast tungsten carbide particles were then poured into the unoccupied void space of the mold assembly **120** to a level just below the height of the cemented carbide pieces **90**. A graphite

funnel (not shown) was disposed on top of the mold assembly **120** and bronze pellets were placed in the funnel. The entire assembly **120** was placed in a preheated furnace with an air atmosphere at a temperature of 1180° C. and heated for 60 minutes. The bronze pellets melted and the molten bronze infiltrated the crystalline tungsten powder to form the machinable region of metal grains in the casting metal matrix, and infiltrated the tungsten carbide particles to form the metallic composite joining material. The resulting earth-boring bit **84** was cleaned and excess material was removed by machining. Threads were machined into the attachment region **88**.

FIG. **13** is a photomicrograph of an interfacial region **130** between a cemented carbide piece **132** forming a blade region **82** of the bit **80**, and the machinable attachment region **134** of the bit **80** which includes tungsten particles **136** dispersed in the continuous bronze matrix **138**.

It will be understood that the present description illustrates those aspects of the invention relevant to a clear understanding of the invention. Certain aspects that would be apparent to those of ordinary skill in the art and that, therefore, would not facilitate a better understanding of the invention have not been presented in order to simplify the present description. Although only a limited number of embodiments of the present invention are necessarily described herein, one of ordinary skill in the art will, upon considering the foregoing description, recognize that many modifications and variations of the invention may be employed. All such variations and modifications of the invention are intended to be covered by the foregoing description and the following claims.

We claim:

1. An article of manufacture comprising:
 - at least one cemented carbide piece, wherein a total volume of the at least one cemented carbide piece is at least 5% of a total volume of the article of manufacture; and
 - a joining phase binding the at least one cemented carbide piece into the article of manufacture, the joining phase comprising inorganic particles and a matrix material including at least one of a metal and a metallic alloy; wherein the matrix material of the joining phase comprises a bronze consisting essentially of about 78 weight percent copper, about 10 weight percent nickel, about 6 weight percent manganese, about 6 weight percent tin, and incidental impurities; and
 - wherein a melting temperature of the inorganic particles is higher than a melting temperature of the matrix material.
2. The article of manufacture of claim 1, wherein the total volume of the at least one cemented carbide piece is at least 10% of the total volume of the article of manufacture.
3. The article of manufacture of claim 1, comprising at least two cemented carbide pieces bound into the article of manufacture by the joining phase, the at least two cemented carbide pieces comprising a cemented carbide volume that is at least 10% of a total volume of the article of manufacture.
4. The article of manufacture of claim 1, further comprising a non-cemented carbide piece bound into the article of manufacture by the joining phase.
5. The article of manufacture of claim 4, wherein the non-cemented carbide piece comprises a metallic component.
6. The article of manufacture of claim 4, wherein the non-cemented carbide piece comprises at least one of iron, an iron alloy, nickel, a nickel alloy, cobalt, a cobalt alloy, copper, a copper alloy, aluminum, an aluminum alloy, titanium, a titanium alloy, tungsten, and a tungsten alloy.
7. The article of manufacture of claim 4, wherein the non-cemented carbide piece comprises grains of at least one of tungsten, a tungsten alloy, tantalum, a tantalum alloy, molyb-

21

denum, a molybdenum alloy, niobium, and a niobium alloy, dispersed in a continuous matrix of one of a metal and a metal alloy.

8. The article of manufacture of claim 7, wherein the non-cemented carbide piece comprises tungsten.

9. The article of manufacture of claim 7, wherein the continuous matrix comprises the matrix material of the joining phase.

10. The article of manufacture of claim 4, wherein the article of manufacture is one of a fixed-cutter earth-boring bit, a fixed-cutter earth-boring bit body, a roller cone bit, a roller cone, and a part for an earth-boring bit.

11. The article of manufacture of claim 1, comprising at least two non-cemented carbide pieces bound into the article of manufacture by the joining phase.

12. The article of manufacture of claim 1, wherein the at least one cemented carbide piece comprises particles of at least one carbide of a metal selected from Groups IVB, VB, and VIB of the Periodic Table, dispersed in a binder comprising at least one of cobalt, a cobalt alloy, nickel, a nickel alloy, iron, and an iron alloy.

13. The article of manufacture of claim 12, wherein the binder of the at least one cemented carbide piece further comprises at least one additive selected from chromium, silicon, boron, aluminum, copper, ruthenium, and manganese.

14. The article of manufacture of claim 1, wherein the at least one cemented carbide piece comprises a hybrid cemented carbide.

15. The article of manufacture of claim 14, wherein a dispersed phase of the hybrid cemented carbide has a contiguity ratio no greater than 0.48.

16. The article of manufacture of claim 1, wherein the inorganic particles of the joining phase comprise at least one of a carbide, a boride, an oxide, a nitride, a silicide, a cemented carbide, a synthetic diamond, a natural diamond, tungsten carbide, and cast tungsten carbide.

17. The article of manufacture of claim 1, wherein the inorganic particles of the joining phase comprise at least one carbide of a metal selected from Groups IVB, VB, and VIB of the Periodic Table.

18. The article of manufacture of claim 1, wherein the inorganic particles of the joining phase comprise metal or metal alloy grains.

19. The article of manufacture of claim 18, wherein the inorganic particles of the joining phase comprises grains of at least one of tungsten, a tungsten alloy, tantalum, a tantalum alloy, molybdenum, a molybdenum alloy, niobium, and a niobium alloy.

20. The article of manufacture of claim 18, wherein the inorganic particles of the joining phase comprise tungsten.

21. The article of manufacture of claim 18, wherein the joining phase is machinable.

22. The article of manufacture of claim 1, wherein the matrix material of the joining phase comprises at least one of nickel, a nickel alloy, cobalt, a cobalt alloy, iron, an iron alloy, copper, a copper alloy, aluminum, an aluminum alloy, titanium, a titanium alloy, and a bronze.

23. The article of manufacture of claim 1, wherein the article of manufacture is one of a fixed-cutter earth-boring bit, a fixed-cutter earth-boring bit body, a roller cone bit, a roller cone, and a part for an earth-boring bit.

24. An earth-boring article, comprising:

at least one cemented carbide piece comprising a cemented carbide volume that is at least 5% of a total volume of the earth-boring article;

a metal matrix composite binding the at least one cemented carbide piece into the earth-boring article, wherein the

22

metal matrix composite comprises hard particles dispersed in a matrix comprising at least one of a metal and a metallic alloy; and

a non-cemented carbide piece comprising at least one of iron, an iron alloy, nickel, a nickel alloy, cobalt, a cobalt alloy, copper, a copper alloy, aluminum, an aluminum alloy, titanium, a titanium alloy, tungsten, and a tungsten alloy;

wherein the non-cemented carbide piece comprises threads adapted to attach the earth-boring article to a drill string.

25. The earth boring article of claim 24, wherein the total volume of the at least one cemented carbide piece is at least 10% of a total volume of the earth-boring article.

26. The earth-boring article of claim 24, comprising at least two of the cemented carbide pieces, wherein the metal matrix composite binds each of the cemented carbide pieces into the earth-boring article.

27. The earth-boring article of claim 24 wherein the at least one cemented carbide piece comprises at least one carbide of a metal selected from Groups IVB, VB, and VIB of the Periodic Table dispersed in a binder comprising at least one of cobalt, a cobalt alloy, nickel, a nickel alloy, iron, and an iron alloy.

28. The earth-boring article of claim 27, wherein the binder of the at least one cemented carbide piece further comprises at least one additive selected from chromium, silicon, boron, aluminum, copper, ruthenium, and manganese.

29. The earth-boring article of claim 24, wherein the earth-boring article is a fixed-cutter earth-boring bit comprising a blade region, and wherein the at least one cemented carbide piece is at least a portion of the blade region.

30. The earth-boring article of claim 24, wherein the at least one cemented carbide piece comprises a hybrid cemented carbide.

31. The earth-boring article of claim 30, wherein a dispersed phase of the at least one hybrid cemented carbide has a contiguity ratio no greater than 0.48.

32. The earth-boring article of claim 24 wherein the hard particles of the metal matrix composite comprise at least one of a carbide, a boride, an oxide, a nitride, a silicide, a sintered cemented carbide, a synthetic diamond, and a natural diamond.

33. The earth-boring article of claim 24, wherein the hard particles of the metal matrix composite comprise at least one of: a carbide of a metal selected from Groups IVB, VB, and VIB of the Periodic Table; tungsten carbide; and cast tungsten carbide.

34. The earth-boring article of claim 24, wherein the matrix of the metal matrix composite comprises at least one of nickel, a nickel alloy, cobalt, a cobalt alloy, iron, an iron alloy, copper, a copper alloy, aluminum, an aluminum alloy, titanium, a titanium alloy, and a bronze.

35. The earth-boring article of claim 24, wherein the matrix of the metal matrix composite comprises a bronze consisting essentially of 78 weight percent copper, 10 weight percent nickel, 6 weight percent manganese, 6 weight percent tin, and incidental impurities.

36. The earth-boring article of claim 24, wherein the article is selected from a fixed-cutter earth-boring bit, a fixed-cutter earth-boring bit body, a roller cone bit, and a roller cone.

37. An earth-boring article, comprising:

at least one cemented carbide piece, the at least one cemented carbide piece comprising a cemented carbide volume that is at least 5% of a total volume of the earth-boring article;

a metal matrix composite binding the at least one cemented carbide piece into the earth-boring article, wherein the

metal matrix composite comprises hard particles dispersed in a matrix comprising at least one of a metal and a metallic alloy; and

a non-cemented carbide piece comprising metallic grains dispersed in the matrix comprising at least one of a metal and a metal alloy;

wherein the non-cemented carbide piece comprises threads adapted to attach the earth-boring article to a drill string.

38. The earth boring article of claim **37**, wherein the total volume of the at least one cemented carbide piece is at least 10% of a total volume of the earth-boring article.

39. The earth-boring article of claim **37**, comprising at least two of the cemented carbide pieces, wherein the metal matrix composite binds each of the cemented carbide pieces into the earth-boring article.

40. The earth-boring article of claim **37** wherein the at least one cemented carbide piece comprises at least one carbide of a metal selected from Groups IVB, VB, and VIB of the Periodic Table dispersed in a binder comprising at least one of cobalt, a cobalt alloy, nickel, a nickel alloy, iron, and an iron alloy.

41. The earth-boring article of claim **40**, wherein the binder of the at least one cemented carbide piece further comprises at least one additive selected from chromium, silicon, boron, aluminum, copper, ruthenium, and manganese.

42. The earth-boring article of claim **37**, wherein the earth-boring article is a fixed-cutter earth-boring bit comprising a blade region, and wherein the at least one cemented carbide piece is at least a portion of the blade region.

43. The earth-boring article of claim **37**, wherein the at least one cemented carbide piece comprises a hybrid cemented carbide.

44. The earth-boring article of claim **43**, wherein a dispersed phase of the hybrid cemented carbide has a contiguity ratio no greater than 0.48.

45. The earth-boring article of claim **37**, wherein the metallic grains are selected from the group consisting of tungsten, a tungsten alloy, tantalum, a tantalum alloy, molybdenum, a molybdenum alloy, niobium, and a niobium alloy.

46. The earth-boring article of claim **37**, wherein the metallic grains comprise tungsten.

47. The earth-boring article of claim **37**, wherein the hard particles of the metal matrix composite comprise at least one of a carbide, a boride, an oxide, a nitride, a silicide, a sintered cemented carbide, a synthetic diamond, and a natural diamond.

48. The earth-boring article of claim **37**, wherein the hard particles of the metal matrix composite comprise at least one of: a carbide of a metal selected from Groups IVB, VB, and VIB of the Periodic Table; tungsten carbide; and cast tungsten carbide.

49. The earth-boring article of claim **37**, wherein the matrix of the metal matrix composite comprises at least one of nickel, a nickel alloy, cobalt, a cobalt alloy, iron, an iron alloy, copper, a copper alloy, aluminum, an aluminum alloy, titanium, a titanium alloy, and a bronze.

50. The earth-boring article of claim **37**, wherein the matrix of the metal matrix composite comprises a bronze consisting essentially of 78 weight percent copper, 10 weight percent nickel, 6 weight percent manganese, 6 weight percent tin, and incidental impurities.

51. The earth-boring article of claim **37**, wherein the article is selected from a fixed-cutter earth-boring bit, a fixed-cutter earth-boring bit body, a roller cone bit, and a roller cone.

52. An earth-boring article, comprising:

at least one cemented carbide piece comprising a cemented carbide volume that is at least 5% of a total volume of the earth-boring article; and

a metal matrix composite binding the at least one cemented carbide piece into the earth-boring article;

wherein the metal matrix composite comprises hard particles dispersed in a matrix comprising a bronze consisting essentially of 78 weight percent copper, 10 weight percent nickel, 6 weight percent manganese, 6 weight percent tin, and incidental impurities.

53. The earth boring article of claim **52**, wherein the total volume of the at least one cemented carbide piece is at least 10% of a total volume of the earth-boring article.

54. The earth-boring article of claim **52**, comprising at least two of the cemented carbide pieces, wherein the metal matrix composite binds each of the cemented carbide pieces into the earth-boring article.

55. The earth-boring article of claim **52** wherein the at least one cemented carbide piece comprises at least one carbide of a metal selected from Groups IVB, VB, and VIB of the Periodic Table dispersed in a binder comprising at least one of cobalt, a cobalt alloy, nickel, a nickel alloy, iron, and an iron alloy.

56. The earth-boring article of claim **55**, wherein the binder of the at least one cemented carbide piece further comprises at least one additive selected from chromium, silicon, boron, aluminum, copper, ruthenium, and manganese.

57. The earth-boring article of claim **52**, wherein the earth-boring article is a fixed-cutter earth-boring bit comprising a blade region, and wherein the at least one cemented carbide piece is at least a portion of the blade region.

58. The earth-boring article of claim **52**, wherein the at least one cemented carbide piece comprises a hybrid cemented carbide.

59. The earth-boring article of claim **58**, wherein a dispersed phase of the hybrid cemented carbide has a contiguity ratio no greater than 0.48.

60. The earth-boring article of claim **52**, further comprising a non-cemented carbide piece comprising at least one of a metal and a metallic alloy.

61. The earth-boring article of claim **60**, wherein the non-cemented carbide piece comprises at least one of iron, an iron alloy, nickel, a nickel alloy, cobalt, a cobalt alloy, copper, a copper alloy, aluminum, an aluminum alloy, titanium, a titanium alloy, tungsten, and a tungsten alloy.

62. The earth-boring article of claim **61**, wherein the non-cemented carbide piece comprises threads adapted to attach the earth-boring article to a drill string.

63. The earth-boring article of claim **60**, wherein the non-cemented carbide piece comprises metallic grains dispersed in the matrix comprising at least one of a metal and a metal alloy.

64. The earth-boring article of claim **63**, wherein the metallic grains are selected from the group consisting of tungsten, a tungsten alloy, tantalum, a tantalum alloy, molybdenum, a molybdenum alloy, niobium, and a niobium alloy.

65. The earth-boring article of claim **63**, wherein the metallic grains comprise tungsten.

66. The earth-boring article of claim **63**, wherein the non-cemented carbide piece comprises threads adapted to attach the earth-boring article to a drill string.

67. The earth-boring article of claim **52** wherein the hard particles of the metal matrix composite comprise at least one of a carbide, a boride, an oxide, a nitride, a silicide, a sintered cemented carbide, a synthetic diamond, and a natural diamond.

25

68. The earth-boring article of claim **52**, wherein the hard particles of the metal matrix composite comprise at least one of: a carbide of a metal selected from Groups IVB, VB, and VIB of the Periodic Table; tungsten carbide; and cast tungsten carbide.

69. The earth-boring article of claim **52**, wherein the matrix of the metal matrix composite comprises at least one of nickel, a nickel alloy, cobalt, a cobalt alloy, iron, an iron alloy,

26

copper, a copper alloy, aluminum, an aluminum alloy, titanium, a titanium alloy, and a bronze.

70. The earth-boring article of claim **52**, wherein the article is selected from a fixed-cutter earth-boring bit, a fixed-cutter earth-boring bit body, a roller cone bit, and a roller cone.

* * * * *