



US007947258B2

(12) **United States Patent**
Terada

(10) **Patent No.:** **US 7,947,258 B2**
(45) **Date of Patent:** **May 24, 2011**

(54) **AQUEOUS HAIR CLEANSING AGENT**

(75) Inventor: **Eiji Terada**, Sumida-ku (JP)

(73) Assignee: **Kao Corporation**, Tokyo (JP)

(*) Notice: Subject to any disclaimer, the term of this patent is extended or adjusted under 35 U.S.C. 154(b) by 343 days.

(21) Appl. No.: **11/751,256**

(22) Filed: **May 21, 2007**

(65) **Prior Publication Data**

US 2007/0269398 A1 Nov. 22, 2007

(30) **Foreign Application Priority Data**

May 22, 2006 (JP) 2006-141430

(51) **Int. Cl.**
A61K 8/89 (2006.01)
A61K 8/73 (2006.01)

(52) **U.S. Cl.** **424/70.122**; 424/70.13

(58) **Field of Classification Search** 424/70.212
See application file for complete search history.

(56) **References Cited**

U.S. PATENT DOCUMENTS

5,085,857 A 2/1992 Reid et al.
2003/0147822 A1* 8/2003 Doi et al. 424/70.1

2005/0075497 A1* 4/2005 Utz et al. 536/114
2005/0255074 A1* 11/2005 Hanada et al. 424/70.122
2006/0051308 A1 3/2006 Terada
2006/0154835 A1 7/2006 Terada

FOREIGN PATENT DOCUMENTS

EP 1 226 814 A1 7/2002
EP 1 428 499 A2 6/2004
EP 1 739 095 A1 1/2007
JP 2003-327603 11/2003
JP 2004-67640 3/2004
JP 2004-203801 7/2004
JP 2005-272658 10/2005
WO WO/2004/014326 * 8/2003
WO WO 2006/052580 5/2006

OTHER PUBLICATIONS

U.S. Appl. No. 11/751,217, filed May 21, 2007, Terada.
U.S. Appl. No. 11/313,740, filed Dec. 22, 2005, Terada.

* cited by examiner

Primary Examiner — Shanon A Foley
Assistant Examiner — Sarah Al-Awadi

(74) *Attorney, Agent, or Firm* — Oblon, Spivak, McClelland, Maier & Neustadt, L.L.P.

(57) **ABSTRACT**

An aqueous hair cleansing agent containing the following components (A), (B) and (C):

- (A): an anionic surfactant;
- (B): a cationized tara gum; and
- (C): an amino-modified silicone represented by a specific formula.

13 Claims, 2 Drawing Sheets

Fig. 1

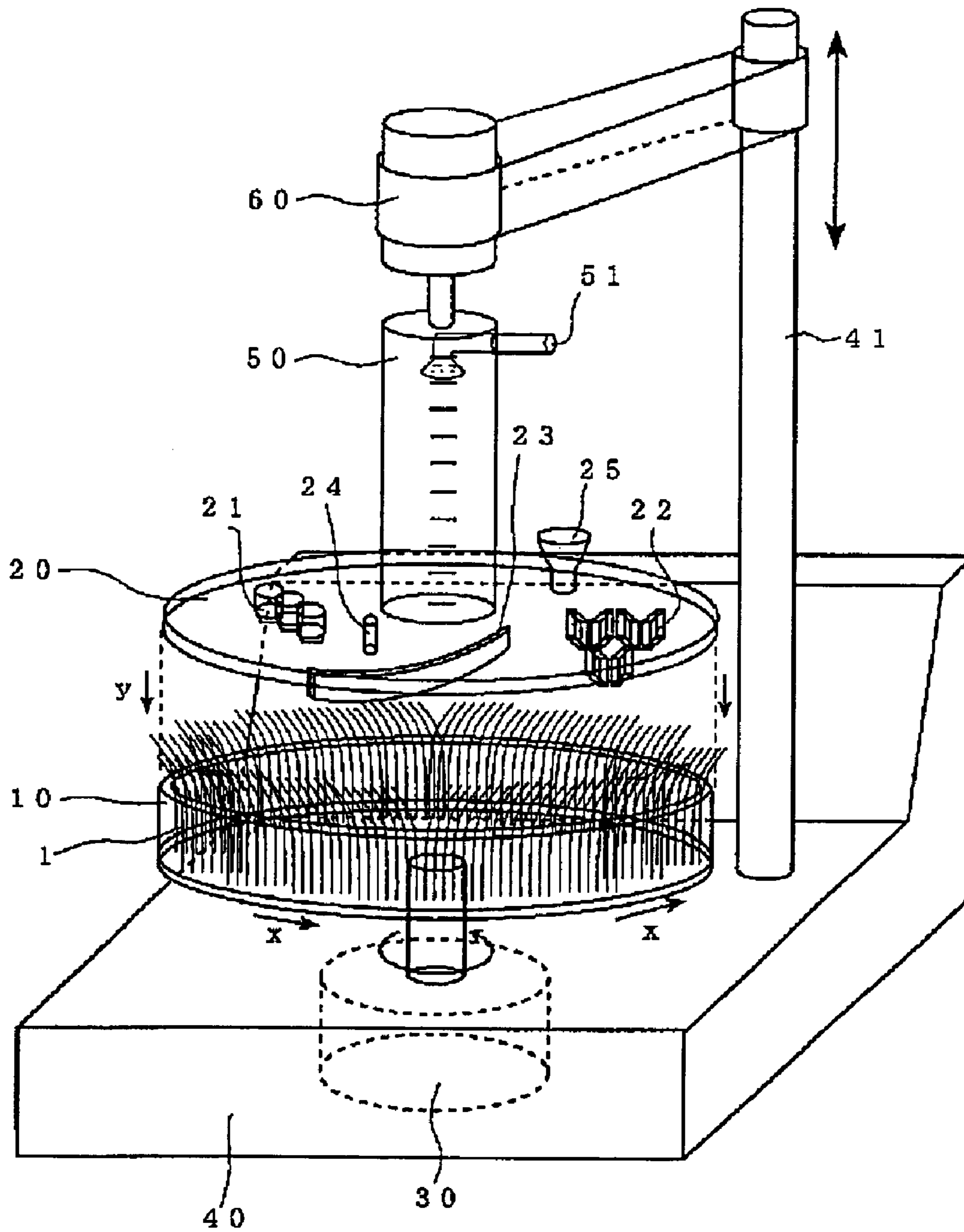
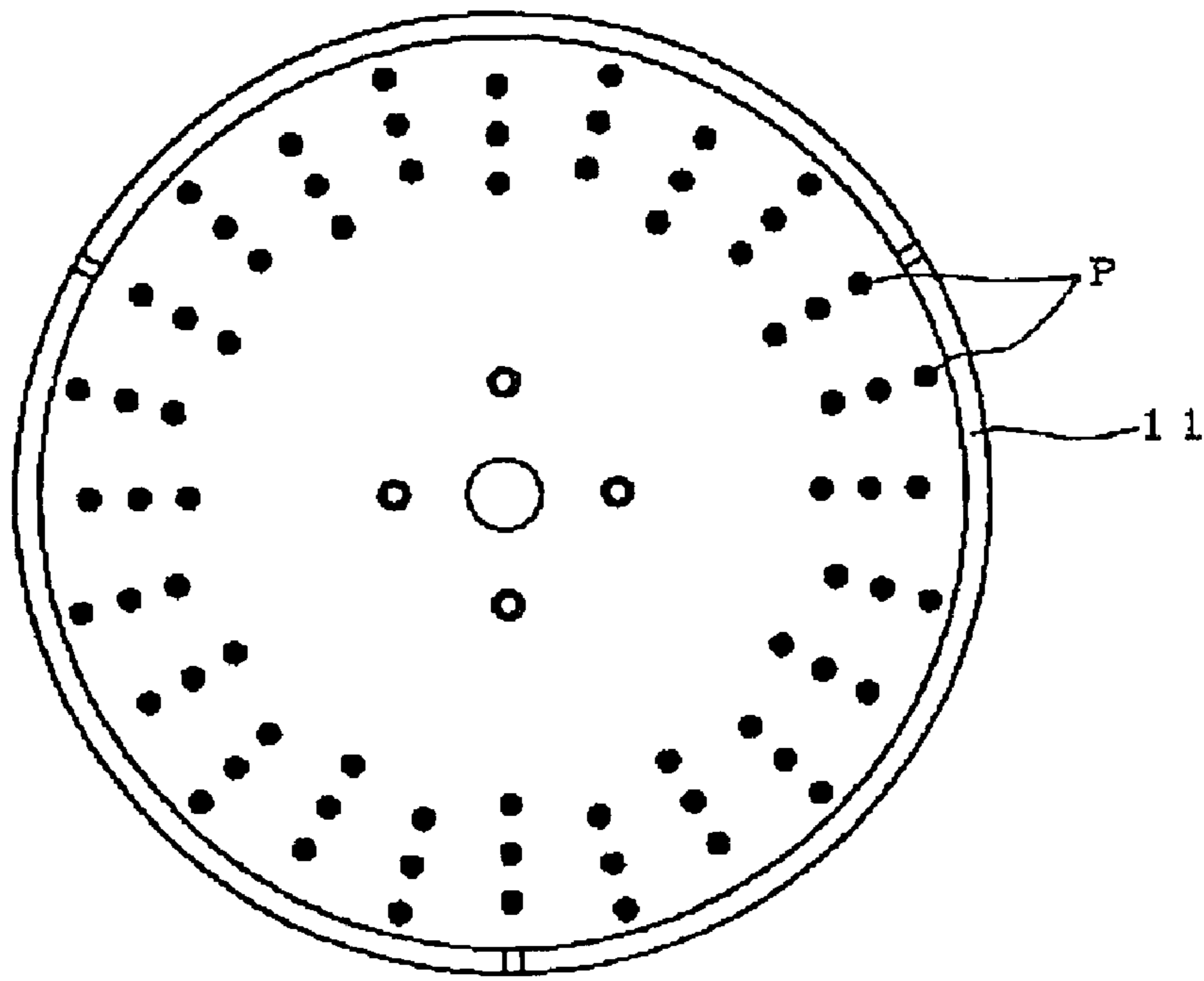
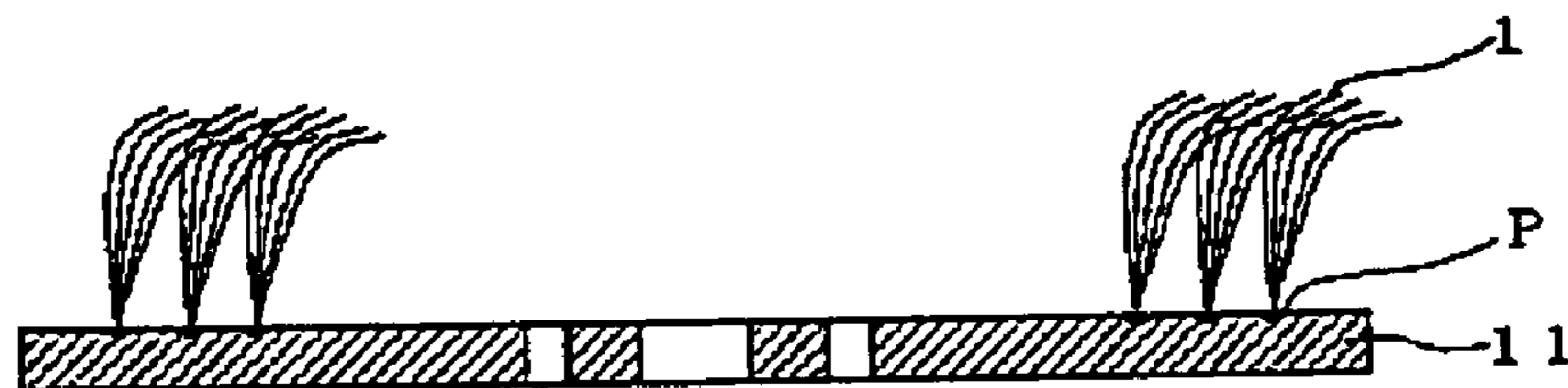

Fig. 2

(a)



(b)



1

AQUEOUS HAIR CLEANSING AGENT

FIELD OF THE INVENTION

The present invention relates to an aqueous hair cleansing agent.

BACKGROUND OF THE INVENTION

Water soluble cationized polymers such as cationized cellulose and cationized guar gum have been conventionally used for hair cleansing agents in order to provide the hair with conditioning effects. Cationized polymers in hair cleansing agents are thought to provide the hair with conditioning effects by easily remaining on the hair surface as a water insoluble complex formed with an anionic surfactant when they are diluted with water. They are however not so effective for the hair damaged by chemical treatment with a hair coloring agent, permanent wave agent or the like, and a phenomenon of tangling or friction between individual hairs still occurs while the agent is rinsed off.

In order to improve the conditioning effects, proposed is the use of a cationized tara gum obtained by cationizing a polysaccharide available from the endosperm of the seeds of tara (scientific name: *Caesal pinia Spinosa*) that is a leguminous plant (JP-A-2004-203801). It is also proposed to use a cationized tara gum in combination with cationized guar gum in a hair cleansing agent (JP-A-2005-272658). However, the conditioning effects on the damaged hair are still insufficient.

Amino-modified silicones are sometimes added to hair cleansing agents in order to improve the conditioning effects. A hair cleansing agent containing an amino-modified or ammonium-modified silicone having a high molecular weight is described in JP-A-5-85918. The amino-modified silicone or the like described therein has, in a side chain of the polysiloxane backbone thereof, an alkylene amine or alkylene ammonium salt so that the agent has a high hydrophobic property and as a result, has problems in the stability because of poor solubility or dispersibility in the hair cleansing agent. In addition, it reduces the foaming of the hair cleansing agent and the hair becomes tough or greasy at the time of rinsing off of the agent.

SUMMARY OF THE INVENTION

The present invention provides an aqueous hair cleansing agent comprising the following components (A), (B) and (C):

- (A) an anionic surfactant,
 (B) a cationized tara gum, and
 (C) an amino-modified silicone represented by the formula (1) or (4):

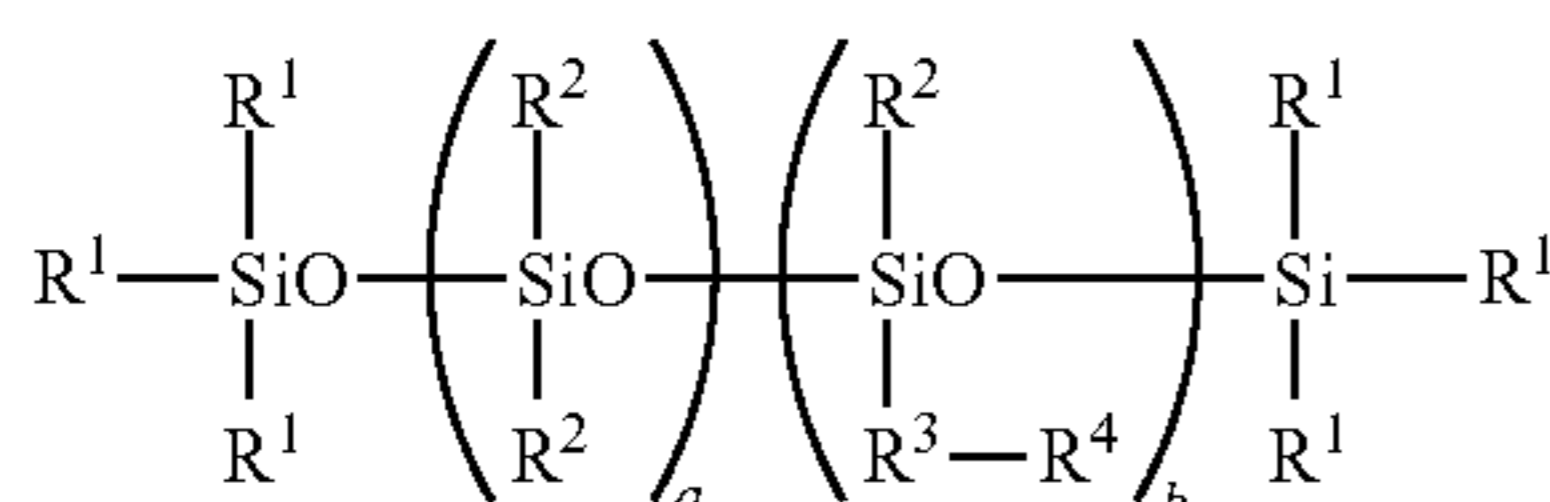

wherein,

R^1 each independently represents a monovalent hydrocarbon group, a hydroxy group or an alkoxy group,

R^2 each independently represents a monovalent hydrocarbon group,

R^3 represents a divalent C_{1-10} hydrocarbon group,

R^4 represents a group represented by the formula (2) or (3):

2

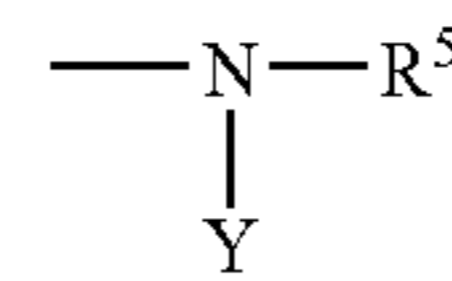
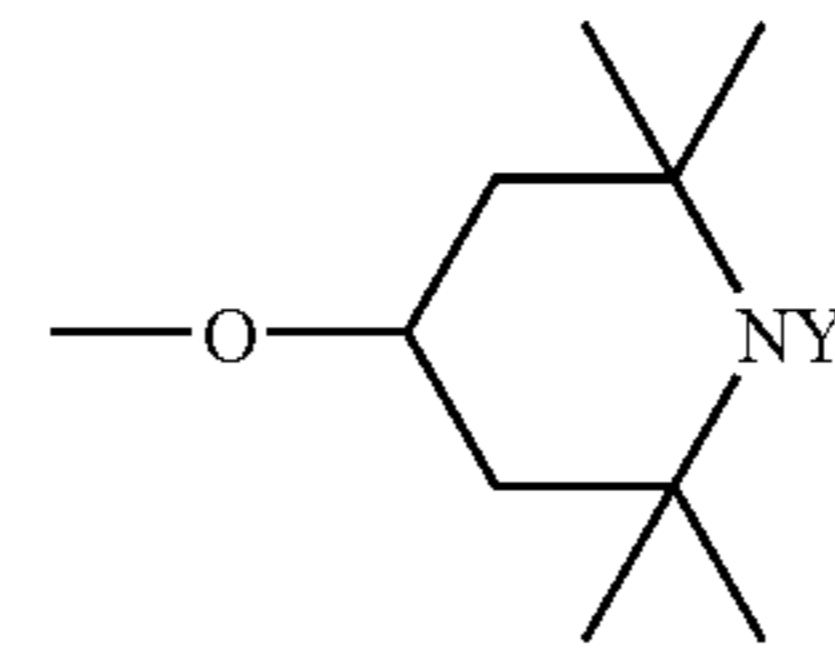

wherein Y represents a hydrogen atom or a group $\text{---CH}_2\text{---CH(OH)---R}^3\text{---OH}$, R^3 having the same meaning as described above, R^5 represents a hydrogen atom or a group $\text{---R}^3\text{NY}_2$, Y and R^3 having the same meanings as described above, with the proviso that all the Ys do not represent a hydrogen atom at the same time, a in formula (1) stands for a number from 25 to 1000, and b stands for a number from 1 to 200;

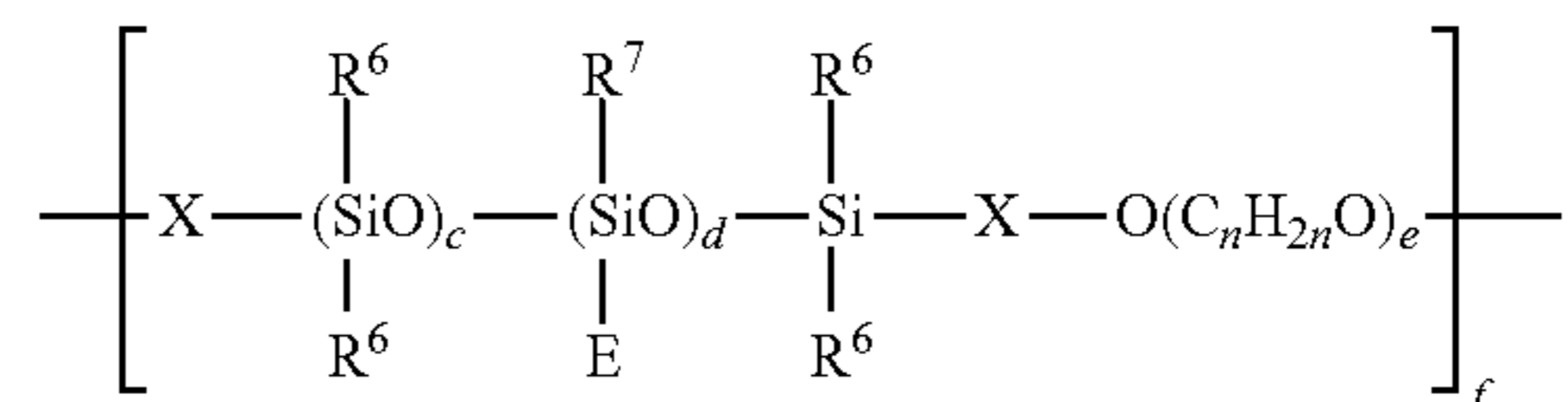

wherein, R^6 each independently represents a hydrogen atom or a monovalent C_{1-6} hydrocarbon atom, R^7 represents either R^6 or E, E represents a group represented by $\text{---R}^8\text{---Z}$, wherein R^8 represents a direct bond or a divalent C_{1-20} hydrocarbon group, and Z represents a primary, secondary or tertiary amino-containing group or ammonium-containing group, X represents a divalent group, c stands for a number of 2 or greater, d stands for a number of 1 or greater, n stands for a number from 2 to 10, e stands for a number of 4 or greater and f stands for a number of 2 or greater.

BRIEF DESCRIPTION OF THE DRAWINGS

FIG. 1 is an overall view of an apparatus employed for the evaluation of foaming speed; and

FIG. 2(a) is a top view of a disk to which hairs are to be implanted and FIG. 2(b) is a cross-sectional view of a disk to which the hairs have been implanted.

- 1: Hair
 10: Container
 11: Disk
 20: Lid
 21: First protrusion
 22: Second protrusion
 23: Foam inducing wall
 24: Hair-entrapping-prevention pin
 25: Inlet
 30: Motor
 40: Control unit
 41: Support
 50: Metering instrument
 51: Water inlet
 60: Torque detector
 P: Implant hole

DETAILED DESCRIPTION OF THE INVENTION

The present invention relates to an aqueous hair cleansing agent which provides, even if used for the hair damaged by

3

chemical treatment, rapid foaming and smooth feeling of foam during shampooing, provides smooth feel to the hair during rinsing, provides the finished hair with luster and manageability, and has excellent storage stability.

The present inventor has found out an aqueous hair cleansing agent which is excellent in the performance and feel of foam, and finish, even if it is applied to the damaged hair, and also is excellent in storage stability by using, in combination, an anionic surfactant, a cationized tara gum and an amino-modified silicone having a specific structure.

As the anionic surfactant (A), sulfate-, sulfonate- and carboxylate-based surfactants are usable. Specific examples include alkyl sulfates, alkenyl sulfates, polyoxyalkylene alkyl ether sulfates, polyoxyalkylene alkenyl ether sulfates, alkyl sulfosuccinates, polyoxyalkylene alkyl sulfosuccinates, alkane sulfonates, higher fatty acid salts, and alkyl ether carboxylates. Of these, polyoxyalkylene alkyl ether sulfates, polyoxyalkylene alkenyl ether sulfates, alkyl sulfates, and alkenyl sulfates are preferred, with those represented by the following formula (5) or (6) being more preferred:



wherein, R^9 represents a C_{10-18} alkyl or alkenyl group, M represents an alkali metal, alkaline earth metal, ammonium, a cation derived from alkanolamine or basic amino acid, and m stands for an average number by weight of from 1 to 5.

Of these, polyoxyethylene alkyl ether sulfates of the formula (5) in which R^9 represents a C_{12-14} alkyl group, m stands for a number of 1 on weight average and M represents ammonium or sodium are preferred because they can satisfy both speedy foaming and good feel of foam.

As Component (A), the above-described anionic surfactants may be used either singly or in combination of two or more. The content of it in the aqueous hair cleansing agent of the present invention preferably ranges from 1 to 30 weight %, more preferably from 5 to 25 weight %, still more preferably from 8 to 20 weight % from the viewpoints of foaming property, liquid state during use and cleansing property.

Component (B) of the present invention is a cationized tara gum. Tara gum which is an origin of the cationized tara gum is obtained from the endosperm of the seeds of tara (scientific name: *Caesal pinia Spinosa*) belonging to leguminous plants and is a galactomannan polysaccharide composed of a main chain of mannose units and a side chain of galactose attached thereto. The ratio of mannose to galactose in tara gum is 3:1.

In the cationized tara gum to be used in the present invention, some hydroxyl groups contained in the galactomannan structure in the tara gum have been substituted with a quaternary nitrogen-containing group. More in detail, it can be prepared by reacting tara gum with a compound having a quaternary nitrogen-containing group such as glycidyl trialkylammonium salt or 3-halogeno-2-hydroxypropyltrialkylammonium salt. This reaction is effected in the presence of an alkali in a proper solvent, preferably a hydrous alcohol. The quaternary nitrogen-containing group can be introduced into the tara gum in accordance with the conventionally known process.

Although no particular limitation is imposed on the cationization degree of cationized tara gum, that is the average number of moles of the quaternary nitrogen-containing group to be added per monosaccharide unit, it is preferably from 0.1 to 0.5. When the cationization degree is less than 0.1, satisfactory conditioning effects cannot be recognized owing to an insufficient adsorption amount to the hair. The cationization

4

degree exceeding 0.5, on the other hand, causes a sticky feel during use and at the same time, worsens the foaming property.

Examples of commercially available products include "Catinal CTR-100" and "Catinal CTR-200" (each, product of Toho Chemical Industry).

As Component (B), these cationized tara gums can be used either singly or in combination of two or more. The content of Component (B) in the aqueous hair cleansing agent of the present invention is preferably from 0.01 to 10 weight %, more preferably from 0.02 to 5 weight %, even more preferably from 0.03 to 2 weight % from the standpoints of decreasing the friction between individual hairs during rinsing.

Component (C) is an amino-modified silicone represented by the formula (1) or (4):

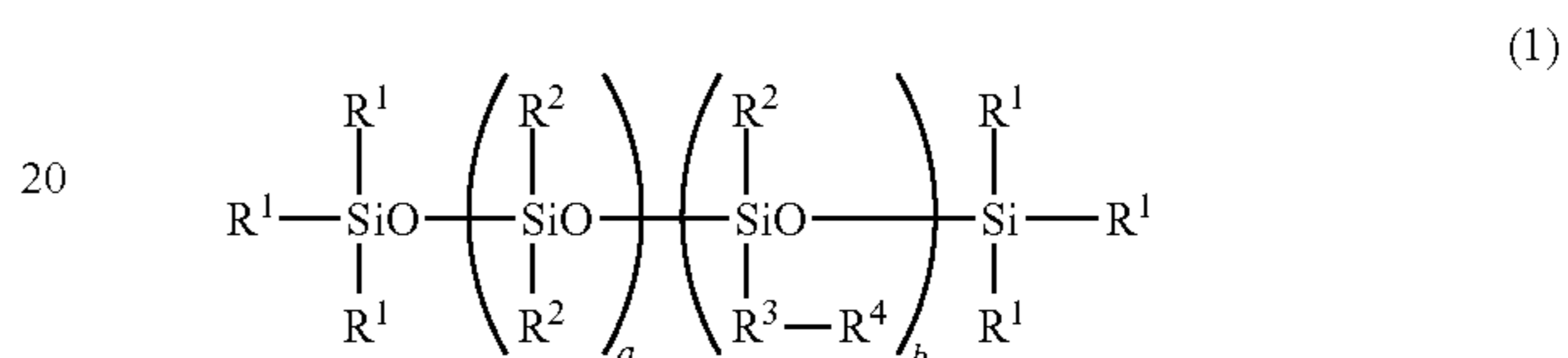

wherein,

R^1 each independently represents a monovalent hydrocarbon group, a hydroxy group or an alkoxy group,

R^2 each independently represents a monovalent hydrocarbon group,

R^3 represents a divalent C_{1-10} hydrocarbon group,

R^4 represents a group represented by the formula (2) or (3):

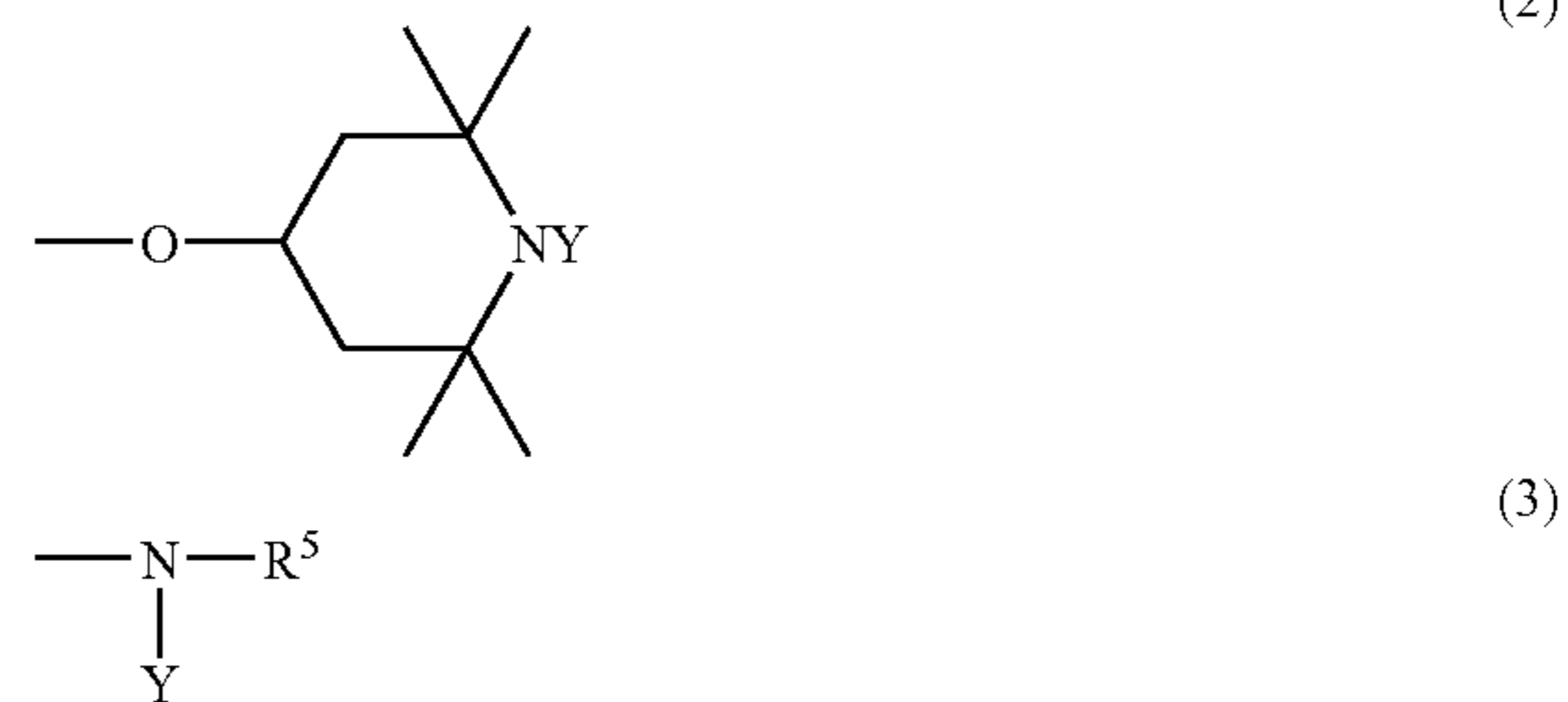

wherein Y represents a hydrogen atom or a group $-\text{CH}_2-\text{CH}(\text{OH})-\text{R}^3-\text{OH}$, R^3 having the same meaning as described above, R^5 represents a hydrogen atom or a group $-\text{R}^3\text{NY}_2$, Y and R^3 having the same meanings as described above, with the proviso that all the Ys do not represent a hydrogen atom at the same time, a in the formula (1) stands for a number from 25 to 1000, and b stands for a number from 1 to 200;

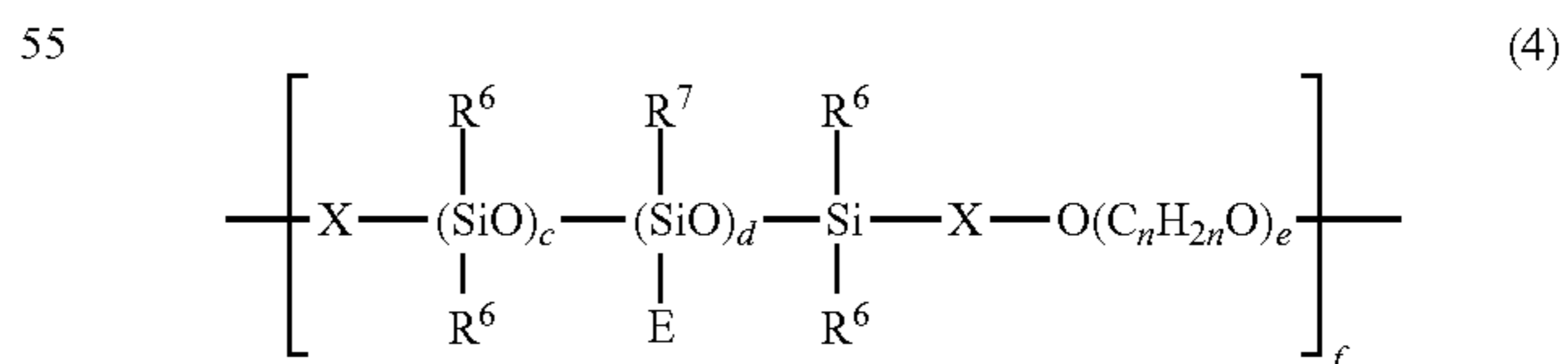

wherein, R^6 each independently represents a hydrogen atom or a monovalent C_{1-6} hydrocarbon group, R^7 represents either R^6 or E, E represents a group represented by $-\text{R}^8-\text{Z}$, wherein R^8 represents a direct bond or a divalent C_{1-20} hydrocarbon group, and Z represents a primary, secondary or tertiary amino-containing group or ammonium-containing

7

because the block copolymer (4) shows high solubility or dispersibility in an aqueous hair cleansing agent and in addition, remains well on the hair.

Of the amino-modified silicones represented by the formula (4), amino-modified polysiloxane-polyoxyalkylene block copolymers having a polymerization unit represented by the formula (9) are more preferred:

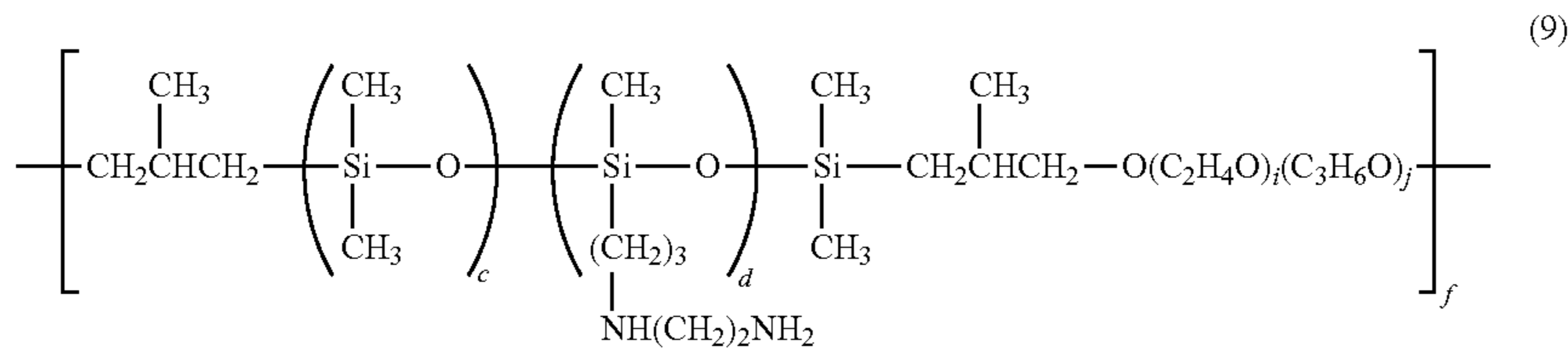

wherein, c, d and f have the same meanings as described above, i stands for a number of 4 or greater and j stands for a number from 0 to 30.

In the formula (9), c, d, i and f stand for preferably a number from 2 to 1000, a number from 1 to 50, a number from 4 to 200 and a number from 2 to 100, respectively. In the above formula, —O(C₂H₄O)_i(C₃H₆O)_j unit may be either block or random.

Examples include "FZ-3789", "DOW CORNING TORAY SS-3588", and "DOW CORNING TORAY SILSTYLE104", each product of Dow Corning Toray.

These amino-modified silicones as Component (C) may be used either singly or in combination of two or more. The content of Component (C) in the aqueous hair cleansing agent of the present invention is preferably from 0.01 to 10 weight %, more preferably from 0.02 to 5 weight %, even more preferably from 0.03 to 2 weight % from the standpoint of decreasing friction between individual hairs during rinsing.

A weight ratio of the Components (B)/(C) is preferably from 1/10 to 10/1, more preferably from 1/5 to 5/1 from the standpoint of smoothness during foaming and rinsing.

The aqueous hair cleansing agent of the present invention may contain a nonionic surfactant or amphoteric surfactant in order to improve the cleansing performance further.

Examples of the nonionic surfactant include polyoxyalkylene sorbitan fatty acid esters, polyoxyalkylene sorbitol fatty acid esters, polyoxyalkylene glycerol fatty acid esters, polyoxyalkylene fatty acid esters, polyoxyalkylene alkyl ethers, polyoxyalkylene alkyl phenyl ethers, polyoxyalkylene (hydrogenated) castor oils, sucrose fatty acid esters, polyglyceryl alkyl ethers, polyglyceryl fatty acid esters, fatty acid alkanolamides, alkyl glycosides, monoalkyl glyceryl ethers, and monoalkenyl glyceryl ethers.

Of these, polyoxyalkylene sorbitan fatty acid esters such as polyoxyethylene sorbitan fatty acid esters, polyoxyalkylene fatty acid esters such as polyoxyalkylene (C₈-C₂₀) fatty acid esters, polyoxyalkylene (hydrogenated) castor oils such as polyoxyethylene hydrogenated castor oil, and alkyl glycosides are preferred.

The fatty acid alkanolamides are also preferred. They may be either monoalkanolamides or dialkanolamides. They have preferably a C₈₋₁₈, more preferably C₁₀₋₁₆ acyl group. Those having a C₂₋₃ hydroxyalkyl group are also preferred. Examples include oleic acid diethanolamide, palm kernel oil fatty acid diethanolamide, coconut oil fatty acid diethanolamide, lauric acid diethanolamide, polyoxyethylene coconut oil fatty acid monoethanolamide, coconut oil fatty acid monoethanolamide, lauric acid isopropanolamide, and lauric acid monoethanolamide.

8

As Component (D), monoalkyl glyceryl ethers and monoalkenyl glyceryl ethers are also preferred. As the alkyl or alkenyl group of them, C₄₋₁₀ alkyl or alkenyl groups are preferred, with linear or branched C₈₋₁₀ alkyl or alkenyl groups being more preferred. Specific examples include n-butyl, isobutyl, n-pentyl, 2-methylbutyl, isopentyl, n-hexyl,

isohexyl, n-heptyl, n-octyl, 2-ethylhexyl, n-decyl and isodecyl groups. Of these, 2-ethylhexyl and isodecyl groups are more preferred.

Examples of the amphoteric surfactant include betaine surfactants. Of these, alkyldimethylaminoacetic acid betaines, fatty acid amidopropylbetaines and alkylhydroxysulfobetaines are more preferred, of which fatty acid amidopropylbetaines are even more preferred. The fatty acid amidopropylbetaines have preferably a C₈₋₁₈, more preferably C₁₀₋₁₆ acyl group. Lauric acid amidopropylbetaine, palm kernel oil fatty acid amidopropylbetaine and coconut oil fatty acid amidopropylbetaine are even more preferred.

In the aqueous hair cleansing agent, these nonionic or amphoteric surfactants may be used either singly or in combination of two or more. In order to provide a preferred aqueous hair cleansing agent of the present invention in the form of an aqueous liquid cleansing agent, use of a fatty acid amidopropylbetaine, fatty acid alkanolamide or monoalkyl glyceryl ether in combination with Component (A) is desired because combined use of them not only improves the foaming power but also gives the agent with adequate liquid properties.

The content of the nonionic or amphoteric surfactant in the aqueous hair cleansing agent of the present invention is preferably from 0.1 to 15 weight %, because it is effective for desirably increasing the foam volume. From this viewpoint, it is more preferably from 0.5 to 8 weight %, even more preferably from 1 to 6 weight %.

Furthermore, the aqueous hair cleansing agent of the present invention may contain a cationic surfactant, a cationized polymer other than Component (B) and a silicone other than Component (C) in order to improve the finish after drying.

Examples of the cationic surfactant include alkyltrimethylammonium salts, alkoxytrimethylammonium salts, dialkyldimethylammonium salts, alkyldimethylamines and salts thereof, alkyldimethylamines and salts thereof, and alkylamidodimethylamines and salts thereof.

(i) As the alkyltrimethylammonium salts, those represented by the following formula can be used:

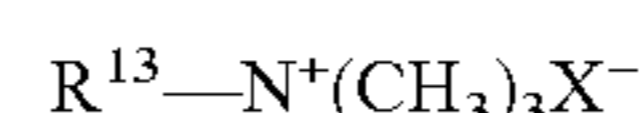

wherein, R¹³ represents a C₁₂₋₂₂ alkyl group, and X⁻ represents a halide ion such as chloride ion or bromide ion.

Specific examples include cetyltrimethylammonium chloride, stearyltrimethylammonium chloride and behenyltrimethylammonium chloride.

(ii) As the alkoxytrimethylammonium salts, those represented by the following formula can be used:

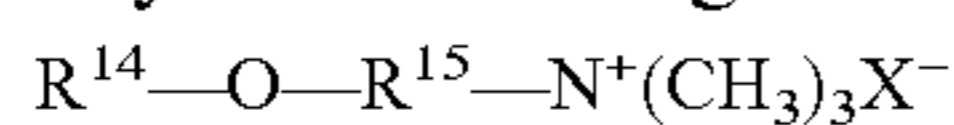

wherein, R^{14} represents a C_{12-22} alkyl group, R^{15} represents an ethylene or propylene group which may be substituted with a hydroxy group, and X^- has the same meaning as described above.

Specific examples include stearoxypropyltrimethylammonium chloride, stearoxyethyltrimethylammonium chloride and stearoxyhydroxypropyltrimethylammonium chloride.

(iii) As the dialkyldimethylammonium salts, those represented by the following formula can be used:

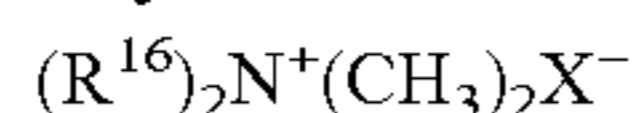

wherein, R^{16} each independently represents a C_{12-22} alkyl group or a benzyl group, and X^- has the same meaning as described above.

Specific examples include distearyldimethylammonium chloride.

(iv) As the alkyldimethylamines and salts thereof, those represented by the following formula can be used:

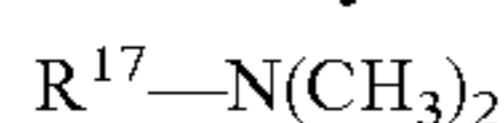

wherein, R^{17} represents a C_{12-22} alkyl group.

Specific examples include behenyldimethylamine and stearyldimethylamine, and organic acid salts thereof.

(v) As the alkoxydimethylamines and salts thereof, those represented by the following formula and salts thereof can be used:

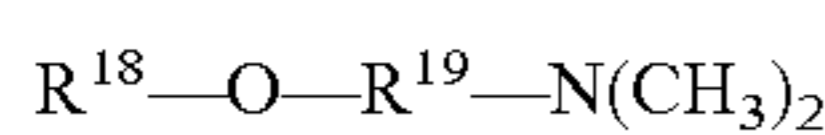

wherein, R^{18} represents a C_{12-22} alkyl group, and R^{19} represents an ethylene or propylene group.

(vi) As the alkylamidodimethylamines and salts thereof, those represented by the following formula and salts thereof can be used:

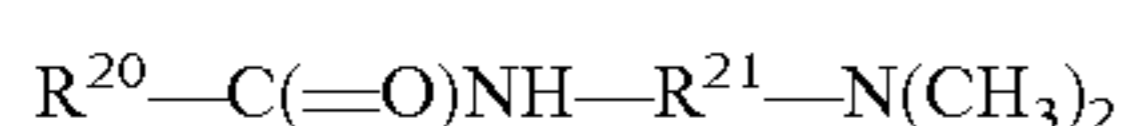

wherein, R^{20} represents a C_{11-21} alkyl group, and R^{21} represents an ethylene or propylene group.

Examples of the cationic surfactant other than those described in (i) to (vi) include lanolin fatty acid aminopropylethyldimethylammonium ethyl sulfate, lanolin fatty acid aminoethyltriethylammonium ethyl sulfate, lanolin fatty acid aminopropyltriethylammonium ethyl sulfate, lanolin fatty acid aminoethyltrimethylammonium methyl sulfate, lanolin fatty acid aminopropylethyldimethylammonium methyl sulfate, isoalkanoic acid ($C_{14}-C_{20}$)aminopropylethyldimethylammonium ethyl sulfate, isoalkanoic acid ($C_{18}-C_{22}$)aminopropylethyldimethylammonium ethyl sulfate, isostearic acid aminopropylethyldimethylammonium ethyl sulfate, isononanoic acid aminopropylethyldimethylammonium ethyl sulfate, and alkyltrimethylammonium saccharins.

These cationic surfactants may be used in combination of two or more. The content thereof in the aqueous hair cleansing agent of the present invention is preferably from 0.01 to 10 weight %, more preferably from 0.05 to 6 weight %, even more preferably from 0.3 to 3 weight %, even more preferably from 0.5 to 2 weight % from the viewpoint of smoothness during shampooing and rinsing.

Examples of the cationized polymer other than Component (B) include cationized cellulose, cationized starch, cationized guar gum, cationized locust bean gum, diallyldialkylammonium salt/acrylamide copolymers, vinylimidazolium chloride/vinylpyrrolidone copolymers, hydroxyethyl cellulose/dimethyldialkylammonium chloride copolymers, vinylpyrrolidone/quaternized dimethylaminoethyl methacrylate copolymers, vinylpyrrolidone/alkylamino acrylate copolymers, vinylpyrrolidone/alkylamino acrylate/vinylca-

prolactam copolymers, vinylpyrrolidone/methacrylamidopropyl trimethylammonium chloride copolymers, alkylacrylamide/alkyl acrylate/alkylaminoalkylacrylamide/polyethylene glycol methacrylate copolymers, adipic acid/dimethylaminohydroxypropylethylenetriamine copolymer ("Cartaretin", product of Sandoz/USA), and cationic polymers as described in JP-A-53-139734 and JP-A-60-36407. Of these, cationized cellulose and cationized guar gum, and diallyldialkylammonium salt/acrylamide copolymers are preferred.

Usable are, for example, commercially available products such as "Merquat 550" (copolymer of acrylamide and diallyldimethylammonium salt; CTF name: Polyquaternium-7; product of ONDEO-NALCO), "Luviquat FC370" (copolymer of 1-vinyl-2-pyrrolidone and 1-vinyl-3-methylimidazolium salt; CTF name: polyquaternium-16; product of BASF), "Gafquat 755N" (copolymer of 1-vinyl-2-pyrrolidone and dimethylaminoethyl methacrylate; CTF name: polyquaternium-11; product of ISP), "Ucare Polymer JR series" and "Ucare Polymer LR series" (salt of a reaction product of trimethylammonium substituted epoxide with hydroxyethyl cellulose; CTF name: polyquaternium-10; product of Amerchol), "Poiz C-60H", "Poiz C-80M" and "Poiz C-150L" (salt of a reaction product of trimethylammonium substituted epoxide with hydroxyethyl cellulose; CTF name: polyquaternium-10; product of Kao); "Jaguar series" (guar hydroxypropyltrimethylammonium chloride; product of Rhodia); and "Catinal CLB-100" (locust bean hydroxypropyltrimonium chloride, product of Toho Chemical Industry).

These cationized polymers other than Component (B) may be used in combination of two or more. From the viewpoint of the smoothness during shampooing and rinsing, the content thereof in the aqueous hair cleansing agent of the present invention preferably ranges from 0.01 to 3 weight %, more preferably from 0.05 to 2 weight %, even more preferably from 0.1 to 0.5 weight %.

The aqueous hair cleansing agent of the present invention preferably contains, as Component (E), a dimethylpolysiloxane represented by the following formula:

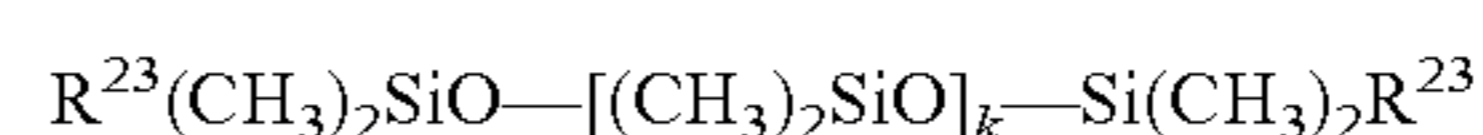

wherein, R^{23} represents a methyl or hydroxyl group and k stands for a number from 1 to 20,000.

The dimethylpolysiloxane (silicone oil) is dispersed in the aqueous hair cleansing agent of the present invention. The average particle size of the dispersed particles of a dimethylpolysiloxane is preferably less than 100 μm , more preferably 50 μm or less, even more preferably 4 μm or less, even more preferably 2 μm or less. The average particle size is preferably 0.1 μm or greater in view of the feeling upon use and conditioning effects.

As such a dimethylpolysiloxane, usable are, for example, "Silicone CF2450" of Dow Corning Toray containing 60 weight % of a dimethylpolysiloxane oil of the above-described formula in which k stands for 300 to 6500 and having an average particle size of 0.8 μm and "Silicone CF2460" containing 50 weight % of a dimethylpolysiloxane oil of the above formula in which k stands for 300 to 6,500 and having an average particle size of 20 μm .

In addition, silicones other than Components (C) and (E) may be incorporated. Examples of such silicones include amino-modified silicones other than Component (C), polyether-modified silicones, methylphenylpolysiloxane, fatty acid-modified silicones, alcohol-modified silicones, alkoxy-modified silicones, epoxy-modified silicones, fluorine-modified silicones, cyclic silicone and alkyl-modified silicones.

11

Two or more of these silicones other than Components (C) and (E) may be used in combination. The content thereof in the aqueous hair cleansing agent of the present invention is preferably from 0.01 to 10 weight %, more preferably from 0.05 to 5 weight %, even more preferably from 0.1 to 2 weight % from the viewpoint of the smoothness during shampooing and rinsing.

The aqueous hair cleansing agent of the present invention may further contain, as a pearling agent, an ethylene glycol monofatty acid ester, ethylene glycol difatty acid ester, ethylene glycol monoalkyl ether or ethylene glycol dialkyl ether.

Examples of the ethylene glycol monofatty acid ester include ethylene glycol monostearate and ethylene glycol monobehenate; and those of the ethylene glycol difatty acid ester include ethylene glycol distearate and ethylene glycol dibehenate. Examples of the ethylene glycol monoalkyl ether include ethylene glycol monostearyl ether, while those of the ethylene glycol dialkyl ether include ethylene glycol distearyl ether.

Two or more of these pearling agents may be used in combination and the content thereof in the aqueous hair cleansing agent of the present invention is preferably from 0.1 to 10 weight %, more preferably from 0.5 to 5 weight %, even more preferably from 1 to 4 weight % in order to improve the storage stability of the aqueous hair cleansing agent and improving its smoothness during foaming and rinsing.

The aqueous hair cleansing agent of the present invention may contain an oil as another conditioning agent. Examples of the oil include hydrocarbons such as squalene, squalane, liquid paraffin, liquid isoparaffin, and cycloparaffin; oils or fats such as castor oil, cacao oil, mink oil, avocado oil, olive oil, sunflower oil and camellia oil; waxes such as beeswax, spermaceti, lanolin, and carnauba wax; higher alcohols such as cetyl alcohol, oleyl alcohol, stearyl alcohol, isostearyl alcohol, 2-octyldodecanol, myristyl alcohol, behenyl alcohol and cetostearyl alcohol; esters such as isopropyl palmitate, isopropyl myristate, octyldodecyl myristate, hexyl laurate, cetyl lactate, propylene glycol monostearate, oleyl oleate, hexadecyl 2-ethylhexanoate, isononyl isononanoate and tridecyl isononanoate; higher fatty acids such as capric acid, lauric acid, myristic acid, palmitic acid, stearic acid, behenic acid, oleic acid, coconut oil fatty acid, isostearic acid, and isopalmitic acid; and other oils such as isostearyl glyceryl ether and polyoxypropylene butyl ether. Of these, higher alcohols and oils or fats are preferred, with myristyl alcohol, cetyl alcohol, stearyl alcohol, sunflower oil and camellia oil are more preferred. These oils may be use either singly or in combination of two or more. The content thereof in the aqueous hair cleansing agent of the present invention is preferably from 0.1 to 2 weight %, more preferably from 0.2 to 1.5 weight %, even more preferably from 0.3 to 1 weight %.

The aqueous hair cleansing agent of the present invention may contain a viscosity regulator. Examples of the viscosity regulator include hydroxyethyl cellulose, methyl cellulose, polyethylene glycol, polypropylene glycol, ethylene glycol, propylene glycol, isoprene glycol, ethanol, benzyl alcohol, benzyl oxyethanol, phenoxyethanol, clay minerals, and salts such as sodium chloride, ammonium chloride, sodium citrate and the like. Of these, benzyl alcohol, ethanol, polypropylene glycol, sodium chloride and sodium citrate are preferred. Two or more of these viscosity regulators may be used in combination. The amount used thereof in the aqueous hair cleansing agent of the present invention is preferably from 0.01 to 5 weight %, more preferably from 0.05 to 4 weight %, even more preferably from 0.1 to 3 weight % from the standpoints of the volume and quality of foam.

12

In addition to the above-described components, components which are employed in ordinary aqueous hair cleansing agents can be incorporated in the aqueous hair cleansing agent of the present invention as needed depending on the purpose of use. Such components include, for example, anti-dandruff agents; vitamin preparations; bactericides; anti-inflammatories; antiseptics; chelating agents; humectants such as glycerin, sorbitol and panthenol; colorants such as dyes and pigments; extracts such as extracts of eucalyptus in a polar solvent, proteins available from shells having a pearl layer or pearls or hydrolysates thereof, honey, royal jelly, proteins available from silk or hydrolysates thereof, protein-containing extracts available from seeds of leguminous plants, Asian ginseng extract, rice bran extract, *Fucus vesiculosus* extract, aloe extract, Alpinia Leaf extract, and chlorella extract; pearling agents such as titanium oxide; perfumes; ultraviolet absorbers; antioxidants; and other components listed in ENCYCLOPEDIA OF SHAMPOO INGREDIENTS (MICELLE PRESS).

The aqueous hair cleansing agent of the present invention has preferably a pH (25° C., diluted 20-fold with water) of from 2 to 6, more preferably from 3 to 5, even more preferably from 3.5 to 4.5 when it is applied to the hair, from the viewpoint of improving the luster and manageability of the hair. As a pH regulator, organic acids are preferred, with α -hydroxy acids being more preferred. Specific preferred examples include malic acid, citric acid, lactic acid and glycolic acid. As the pH regulator, two or more of these organic acids may be used in combination. The amount used thereof is preferably from 0.01 to 5 weight %, more preferably from 0.1 to 3 weight %, even more preferably from 0.3 to 2 weight % in the aqueous hair cleansing agent of the present invention from the viewpoints of improvement in foam quality and flexibility of hair during shampooing. As another pH regulator, a base such as sodium hydroxide, potassium hydroxide or ammonium chloride may be used in combination with the above-described organic acid.

Although the form of the aqueous hair cleansing agent of the present invention can be chosen as desired from a liquid form, a gel form and the like, a liquid form in a solvent such as water or a lower alcohol is preferred, with water being more preferred.

The following examples further describe and demonstrate embodiments of the present invention. The examples are given solely for the purpose of illustration and are not to be construed as limitations of the present invention.

EXAMPLES

Examples 1 to 4 and Comparative Examples 1 to 4

Hair cleansing agents shown in Table 1 were prepared and they were evaluated by the below-described evaluation method. The results are also shown in Table 1. The pH is a value of the agent measured at 25° C. after it is diluted 20-fold with water.

(1) Foaming Speed

The foaming speed was measured using an apparatus shown in FIG. 1.

The apparatus of FIG. 1 is equipped with an open-topped cylindrical container 10 (diameter: 160 mm, height: 55 mm) made of transparent plastic and having a drain outlet (not illustrated) at the bottom of the container, a lid 20 made of transparent plastic, a control unit 40 having a motor 30 loaded therein, a metering instrument 50 and a torque detector 60. A disk 11 (diameter: about 160 mm) having a plurality of implant holes P into which hairs 1 (90 mm, 30 g in total) have

TABLE 1-continued

(weight %)	Examples				Comparative Examples			
	1	2	3	4	1	2	3	4
Sodium chloride	0.2	0.2	0.2	0.2	0.2	0.2	0.2	0.2
Malic acid	0.7	0.7	0.7	0.7	0.7	0.7	0.7	0.7
Purified water	Balance	Balance	Balance	Balance	Balance	Balance	Balance	Balance
Total	100	100	100	100	100	100	100	100
pH	3.9	3.9	3.9	3.9	3.9	3.9	3.9	3.9
Evaluation Foaming speed	A	B	A	A	B	D	C	C
Smoothness during foaming	19	19	18	17	17	10	13	14
Smoothness during rinsing	19	18	20	17	10	14	12	14
Luster and manageability after drying	19	20	18	14	9	14	15	13
Stability	A	A	A	A	C	A	B	A

*¹Ammonium polyoxyethylene (1) lauryl ether sulfate; the average number of moles of ethylene oxide: 1

*²Cationized tara gum: "Catinal CTR-100" (product of Toho Chemical Industry)

*³Cationized hydroxyethyl cellulose; "Poiz C-80M" (product of Kao)

*⁴Cationized guar gum; "Jaquar C-13S" (product of Rhodia)

*⁵Amino-modified silicone: "8500 Conditioning Agent" (product of Dow Corning Toray)

*⁶Amino-modified silicone: "DOW CORNING TORAY SS-3588" (product of Dow Corning Toray)

*⁷Amino-modified silicone: "Silicone KT-1989" (product of GE Toshiba Silicone)

*⁸Isodecyl glyceryl ether: which is derived from an alcohol obtained by the conversion of a trimer of propylene by the oxo process (which will equally apply hereinafter)

*⁹Dimethylpolysiloxane emulsion: viscosity (10000 mm²/s)/(10 mm²/s) = 95/5 mixture, an average particle size: 4.0 μm, a dimethylpolysiloxane content: 60 weight %.

Example 5

25

Conditioning Shampoo

Example 6

Conditioning Shampoo

30

(weight %)		(weight %)	
Ammonium polyoxyethylene (1) lauryl ether sulfate (average number of moles of ethylene oxide: 1)	13.0	Sodium polyoxyethylene (2) lauryl ether sulfate (average number of moles of ethylene oxide: 2)	13.0
Cationized tara gum ("Catinal "CTR-100", product of Toho Chemical Industry)	0.2	Cationized tara gum ("Catinal CTR-200", product of Toho Chemical Industry)	0.5
Amino-modified silicone ("8500 Conditioning Agent", Product of Dow Corning Toray)	0.3	Amino-modified silicone ("SS-3588", product of Dow Corning Toray)	0.1
Cationized cellulose ("Poiz C-80M", product of Kao)	0.3	Cationized guar gum ("Jaguar C-17", product of Rhodia)	0.1
Diallyldimethylammonium chloride/acrylamide copolymer ("Merquat 550", product of Ondeo Nalco, effective content: 8.5 weight %)	1.7	Diallyldimethylammonium chloride homopolymer ("Merquat 100", product of Ondeo Nalco, effective content: 40 weight %)	0.8
Dimethylpolysiloxane emulsion (silicone viscosity: 10,000 mm ² /s, average particle size: 4 μm, effective content: 60 weight %)	1.7	Highly polymerized dimethylpolysiloxane emulsion ("Silicone CF2450", product of Dow Corning Toray, particle size: 0.2 to 0.8 μm, effective content: 60 weight %)	2.0
Ethylene glycol distearate	2.0	Ethylene glycol distearate	3.0
Isodecyl glyceryl ether	0.5	Isodecyl glyceryl ether	0.7
Lauroyl amidopropylbetaine	1.0	Lauroyl amidopropylbetaine	2.0
Myristyl alcohol	0.4	Cocoyl monoethanolamide	0.5
Cetyl alcohol	0.1	Myristyl alcohol	0.5
Cocoyl monoethanolamide	0.5	Cetyl alcohol	0.5
Polyoxyethylene (16) lauryl ether	0.7	Polyoxyethylene (16) lauryl ether	1.0
Polypropylene glycol (weight average molecular weight: 400)	0.5	Benzyl alcohol	1.0
Benzyl alcohol	0.3	Propylene glycol (weight average molecular weight: 400)	0.2
Ethanol	3.0	Sodium chloride	1.0
Camellia oil	0.01	Hydrolyzed conchiolin solution (dry content: 3 weight %)	0.05
Panthenol	0.05	Asian ginseng extract (dry content: 3 weight %)	0.05
Royal jelly	0.01	Soybean extract (dry content: 0.4 weight %)	0.05
Purified honey	0.01	Eucalyptus extract (dry content: 0.2 weight %)	0.05
Silk extract	0.05	Rice bran oil	0.05
Sodium chloride	0.2	Glycolic acid	1.0
Perfume	q.s.	Perfume	q.s.
Malic acid	0.5	pH regulator (sodium hydroxide)	Amount to adjust pH to 3.9
pH regulator (lactic acid)	An amount to adjust pH to 3.9	Ion exchange water	Balance
Ion exchange water	Balance		

17

Example 7

Conditioning Shampoo

	(weight %)
Sodium polyoxyethylene (1) lauryl ether sulfate (average number of moles of ethylene oxide: 1)	16.0
Cationized tara gum ("Catinal "CTR-100", product of Toho Chemical Industry)	0.7
Amino-modified silicone ("8500 Conditioning agent", Product of Dow Corning Toray)	0.5
Highly polymerized dimethylpolysiloxane emulsion ("Silicone CF2460", product of Dow Corning Toray, particle size: 20 μm , effective content: 75 weight %)	3.0
Ethylene glycol distearate	3.0
2-Ethylhexyl glyceryl ether	0.3
Cocoyl monoethanolamide	0.5
Stearyl alcohol	1.0
Glycerin	1.0
Sodium chloride	0.2
Benzylxyethanol	0.5
Malic acid	0.7
Perfume	q.s.
Lactic acid	0.1
pH regulator (citric acid)	Amount to adjust pH to 5.5
Ion exchange water	Balance

Example 8

Conditioning Shampoo

	(weight %)
Sodium polyoxyethylene (2.5) lauryl ether sulfate (average number of moles of ethylene oxide: 2.5)	15.0
Cationized tara gum ("Catinal CTR-200", product of Toho Chemical Industry)	0.2
Amino-modified silicone ("SILSTYLE 104", product of Dow Corning Toray)	1.0
Cationized locust bean gum ("Catinal CLB-100", Product of Toho Chemical Industry)	0.2
Methylpolysiloxane emulsion (silicone viscosity: 5,000 mm^2/s , particle size: 0.2 to 0.8 μm , effective content: 65 weight %)	2.0
Ethylene glycol distearate	2.0
Lauroyl amidopropylbetaine	3.0
Cocoyl monoethanolamide	0.8
Polyoxyethylene (16) lauryl ether	2.0
Sodium Cocoamphoacetate	1.0
Stearoxypropyl dimethylamine•malate salt	0.5
Polypropylene glycol (weight average molecular weight: 400)	0.5
Sodium chloride	1.0
Malic acid	0.8
Citric acid	0.75
pH regulator (sodium hydroxide)	Amount to adjust pH to 3.5
Ion exchange water	Balance

Hair cleansing agents obtained in Examples 5 to 8 lathered quickly, were excellent in the smoothness of the hair during foaming and rinsing, provided excellent luster and manageability to the finished hair, and had excellent storage stability.

The invention claimed is:

1. An aqueous hair cleansing agent comprising components (A), (B) and (C):

18

(A) an anionic surfactant represented by the formula (5) or (6):



wherein, R^9 represents a C10-18 alkyl or alkenyl group, M represents an alkali metal, alkaline earth metal, ammonium, or a cation derived from alkanolamine or basic amino acid, and m stands for an average number by weight of from 1 to 5;

(B) a galactomannan polysaccharide consisting of a cationized tara gum; and

(C) an amino-modified silicone represented by formula (1) or (4):

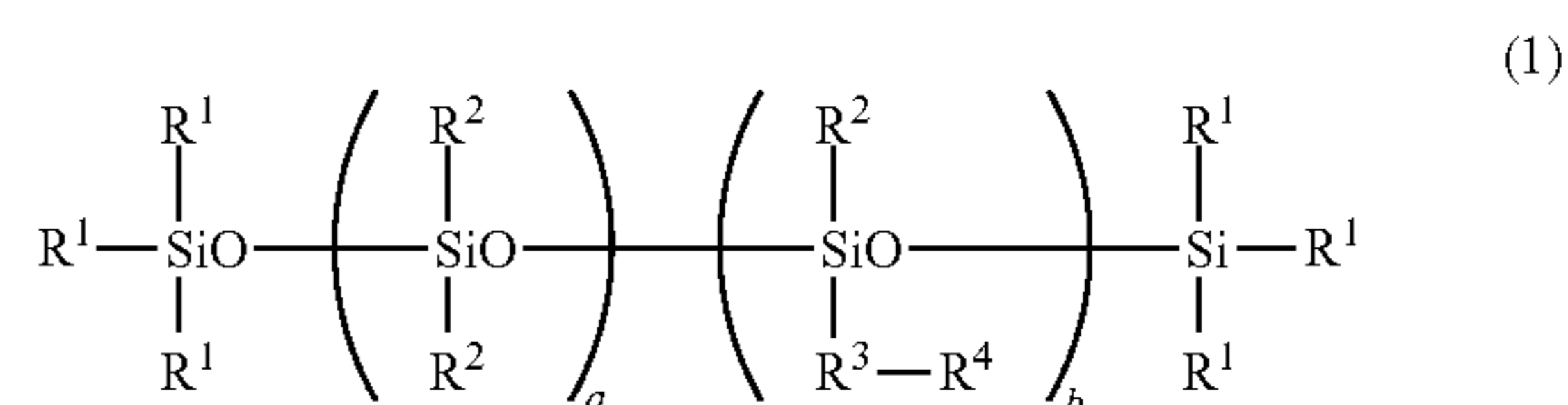

wherein,

R^1 each independently represents a monovalent hydrocarbon group, a hydroxy group or an alkoxy group,

R^2 each independently represents a monovalent hydrocarbon group,

R^3 represents a divalent C_{1-10} hydrocarbon group,

R^4 represents a group represented by the formula (2) or (3):

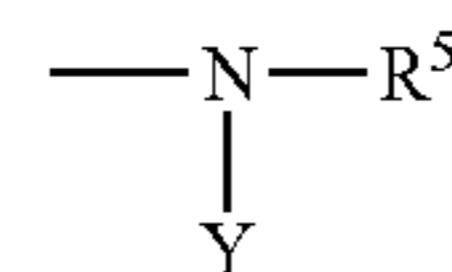
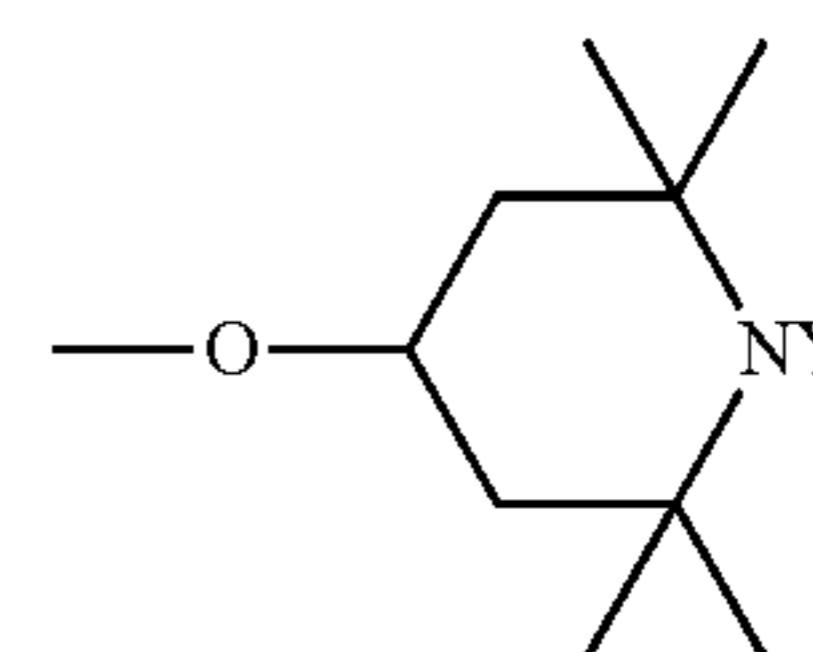

wherein Y represents a hydrogen atom or a group $\text{---CH}_2\text{---CH}(\text{OH})\text{---R}^3\text{---OH}$, R^3 has the same meaning as defined above, R^5 represents a hydrogen atom or a group $\text{---R}^3\text{NY}_2$, Y and R^3 have the same meanings as defined, above, with the proviso that all the Ys do not represent a hydrogen atom at the same time, a in the formula (1) stands for a number from 25 to 1000, and b stands for a number from 1 to 200;

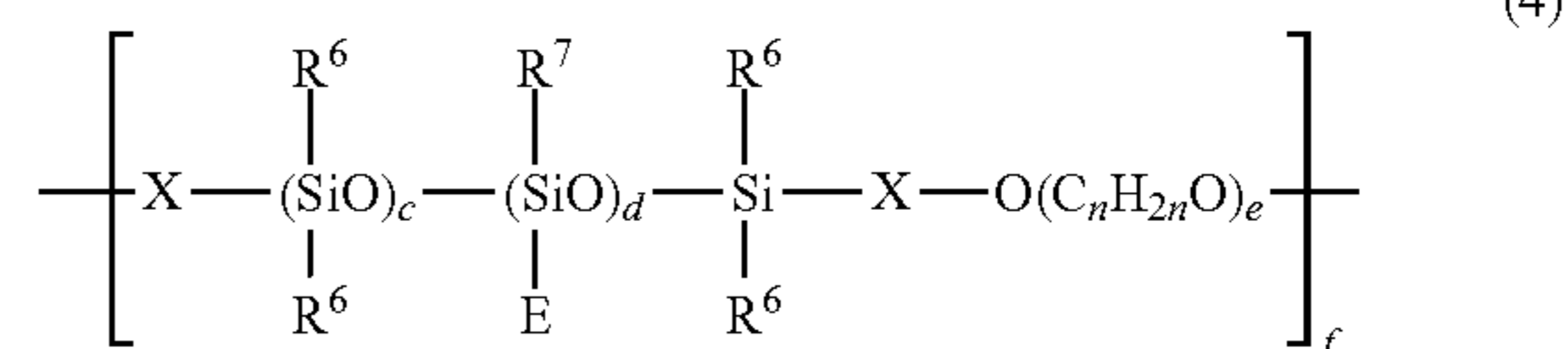

wherein, R^6 each independently represents a hydrogen atom or a monovalent C_{1-6} hydrocarbon group, R^7 represents either R^6 or E, E represents a group represented by $\text{---R}^8\text{---Z}$, wherein R^8 represents a direct bond or a divalent C_{1-20} hydrocarbon group, and Z represents a

19

primary, secondary or tertiary amino-containing group or ammonium-containing group, X represents a divalent group, c stands for a number of 2 or greater, d stands for a number of 1 or greater, n stands for a number from 2 to 10, e stands for a number of 4 or greater and stands for a number of 2 or greater.

2. The aqueous hair cleansing agent according to claim 1, comprising from 1 to 30 weight % of Component (A), from 0.01 to 10 weight % of Component (B) and from 0.01 to 10 weight % of Component (C).

3. The aqueous hair cleansing agent according to claim 1, wherein a ratio by weight of Components (B)/(C) falls within a range of from 1/10 to 10/1.

4. The aqueous hair cleansing agent according to claim 1, which further comprises, as Component (D), a glyceryl ether selected from the group consisting of a monoalkyl glyceryl ether having a C₄₋₁₀ alkyl group and a monoalkenyl glyceryl ether having a C₄₋₁₀ alkenyl group.

5. The aqueous hair cleansing agent according to claim 1, further comprising dimethylpolysiloxane as Component (E).

6. The aqueous hair cleansing agent according to claim 1, which has a pH of from 2 to 6 at 25° C. when diluted 20-fold with water.

20

7. The aqueous hair cleansing agent according to claim 1, wherein (A) the anionic surfactant is ammonium lauryl ether sulfate.

8. The aqueous hair cleansing agent according to claim 1, wherein (A) the anionic surfactant is present in an amount of 8 to 20 weight %.

9. The aqueous hair cleansing agent according to claim 1, wherein (B) the cationized tara gum is present in an amount of 0.03 to 2 weight %.

10. The aqueous hair cleansing agent according to claim 1, wherein (C) the amino-modified silicone is present in an amount of 0.03 to 2 weight %.

11. The aqueous hair cleansing agent according to claim 1, wherein (C) the amino-modified silicone is represented by formula (4).

12. The aqueous hair cleansing agent according to claim 1, wherein (C) the amino-modified silicone is represented by formula (1).

13. The aqueous hair cleansing agent according to claim 1, wherein R⁴ of formula (1) of component (C) represents a group of formula (3).

* * * * *