



US007902074B2

(12) **United States Patent**  
**Niroomand et al.**

(10) **Patent No.:** **US 7,902,074 B2**  
(45) **Date of Patent:** **Mar. 8, 2011**

(54) **SIMPLIFIED PITCH DOUBLING PROCESS FLOW**

(75) Inventors: **Ardavan Niroomand**, Boise, ID (US);  
**Baosuo Zhou**, Boise, ID (US);  
**Ramakanth Alapati**, Boise, ID (US)

(73) Assignee: **Micron Technology, Inc.**, Boise, ID (US)

(\* ) Notice: Subject to any disclaimer, the term of this patent is extended or adjusted under 35 U.S.C. 154(b) by 180 days.

(21) Appl. No.: **11/400,603**

(22) Filed: **Apr. 7, 2006**

(65) **Prior Publication Data**

US 2007/0238308 A1 Oct. 11, 2007

(51) **Int. Cl.**  
**H01L 21/311** (2006.01)

(52) **U.S. Cl.** ..... **438/702**; 438/694; 438/695; 438/699;  
438/703

(58) **Field of Classification Search** ..... 438/689-757  
See application file for complete search history.

(56) **References Cited**

**U.S. PATENT DOCUMENTS**

4,234,362 A	11/1980	Riseman
4,246,822 A	1/1981	Deutsch
4,419,809 A	12/1983	Riseman et al.
4,432,132 A	2/1984	Kinsbron et al.
4,452,442 A	6/1984	Geschwindner
4,502,914 A	3/1985	Trumpf et al.
4,508,579 A	4/1985	Goth et al.
4,570,325 A	2/1986	Higuchi
4,648,937 A	3/1987	Ogura et al.
4,713,756 A	12/1987	Mackiewicz
4,716,131 A	12/1987	Okazawa et al.
4,751,645 A	6/1988	Abrams

4,776,922 A	10/1988	Bhattacharyya et al.
4,838,991 A	6/1989	Cote et al.
5,013,680 A	5/1991	Lowrey et al.
5,047,117 A	9/1991	Roberts
5,053,105 A	10/1991	Fox, III
5,117,027 A	5/1992	Bernhardt et al.
5,328,810 A	7/1994	Lowrey et al.
5,330,879 A	7/1994	Dennison

(Continued)

**FOREIGN PATENT DOCUMENTS**

DE 280851 7/1990

(Continued)

**OTHER PUBLICATIONS**

Bergeron, et al., "Resolution Enhancement Techniques for the 90nm Technology Node and Beyond", Future Fab International, Issue 15, Jul. 11, 2003, 4 pages.

(Continued)

*Primary Examiner* — N Drew Richards

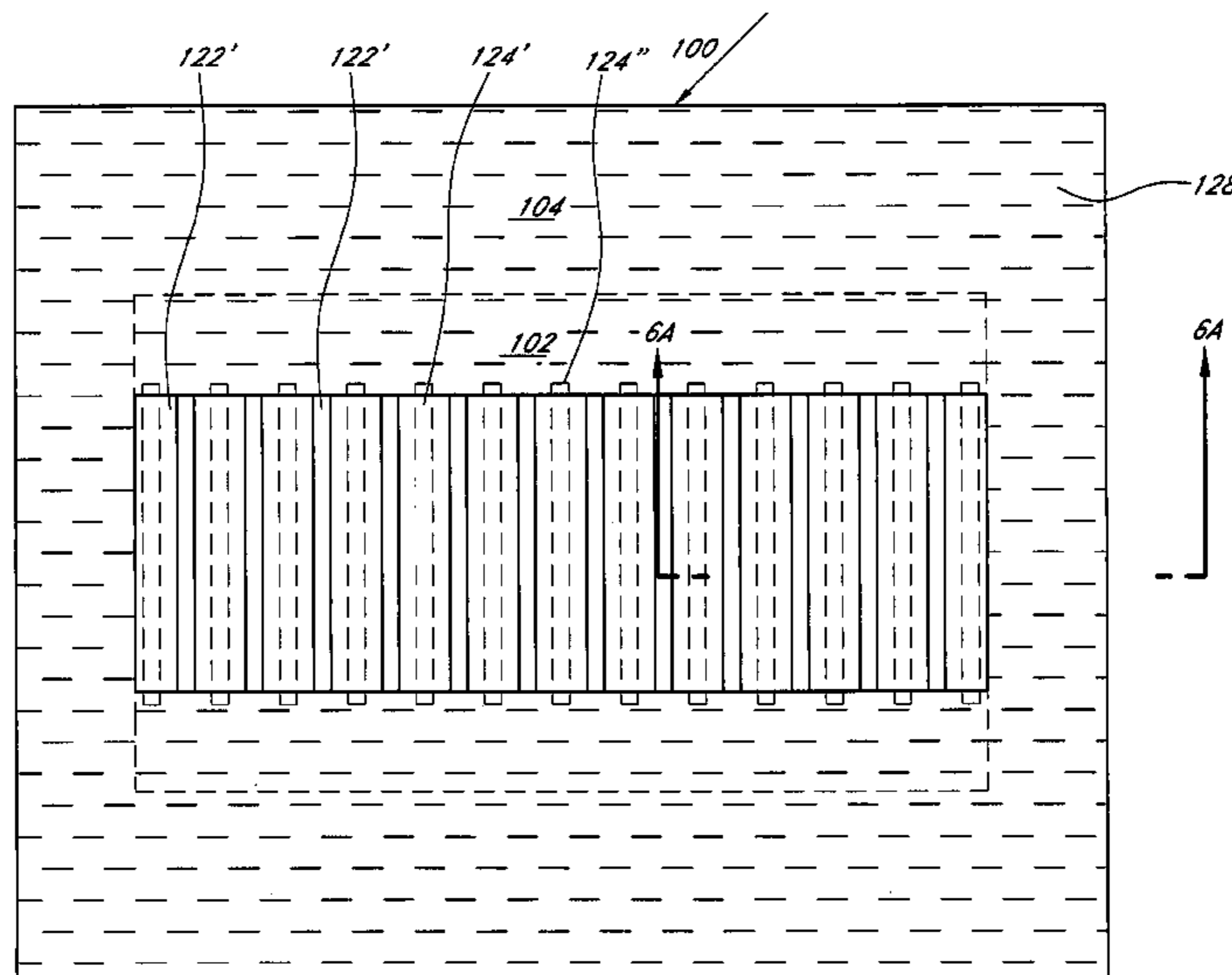
*Assistant Examiner* — Jae Lee

(74) *Attorney, Agent, or Firm* — Knobbe, Martens, Olson & Bear, LLP

(57) **ABSTRACT**

A method for fabricating a semiconductor device comprises patterning a layer of photoresist material to form a plurality of mandrels in a device array region. The method further comprises depositing an oxide material over the plurality of mandrels and over a device peripheral region. The method further comprises forming a pattern of photoresist material over the oxide material in the device peripheral region. The method further comprises anisotropically etching the oxide material from exposed horizontal surfaces in the device array region. The method further comprises selectively etching photoresist material from the device array region and from the device peripheral region.

**19 Claims, 24 Drawing Sheets**



# US 7,902,074 B2

U.S. PATENT DOCUMENTS							
5,470,661	A	11/1995	Bailey et al.	2002/0042198	A1	4/2002	Bjarnason et al.
5,502,320	A	3/1996	Yamada	2002/0045308	A1	4/2002	Juengling
5,514,885	A	5/1996	Myrick	2002/0063110	A1	5/2002	Cantell et al.
5,593,813	A	1/1997	Kim	2002/0068243	A1	6/2002	Hwang et al.
5,670,794	A	9/1997	Manning	2002/0094688	A1	7/2002	Mitsuiki
5,753,546	A	5/1998	Koh et al.	2002/0125536	A1	9/2002	Iwasa et al.
5,789,320	A	8/1998	Andricacos et al.	2002/0127810	A1	9/2002	Nakamura et al.
5,795,830	A	8/1998	Cronin et al.	2002/0130348	A1	9/2002	Tran
5,830,332	A	11/1998	Babich et al.	2002/0130686	A1	9/2002	Forbes
5,899,746	A	5/1999	Mukai	2002/0135029	A1	9/2002	Ping et al.
5,905,285	A	5/1999	Gardner et al.	2002/0158273	A1	10/2002	Satoh et al.
5,998,256	A	12/1999	Juengling	2003/0006410	A1	1/2003	Doyle
6,004,862	A	12/1999	Kim et al.	2003/0008461	A1	1/2003	Forbes et al.
6,042,998	A	3/2000	Brueck et al.	2003/0040186	A1	2/2003	Juengling et al.
6,057,573	A	5/2000	Kirsch et al.	2003/0042542	A1	3/2003	Maegawa et al.
6,063,688	A *	5/2000	Doyle et al. .... 438/424	2003/0044722	A1	3/2003	Hsu et al.
6,071,789	A	6/2000	Yang et al.	2003/0073044	A1	4/2003	Reynolds
6,110,837	A	8/2000	Linliu et al.	2003/0109102	A1	6/2003	Kujirai et al.
6,143,476	A	11/2000	Ye et al.	2003/0119307	A1	6/2003	Bekiaris et al.
6,207,490	B1	3/2001	Lee	2003/0127426	A1	7/2003	Chang et al.
6,211,044	B1	4/2001	Xiang et al.	2003/0157436	A1	8/2003	Manger et al.
6,282,113	B1	8/2001	Debrosse	2003/0207207	A1	11/2003	Li
6,288,454	B1	9/2001	Allman et al.	2003/0207584	A1	11/2003	Sivakumar et al.
6,291,334	B1	9/2001	Somekh	2003/0215978	A1	11/2003	Maimon et al.
6,297,554	B1	10/2001	Lin	2003/0216050	A1	11/2003	Golz et al.
6,335,257	B1	1/2002	Tseng	2003/0218199	A1	11/2003	Forbes et al.
6,348,380	B1	2/2002	Weimer et al.	2003/0230234	A1 *	12/2003	Nam et al. .... 117/97
6,383,907	B1	5/2002	Hasegawa et al.	2004/0000534	A1	1/2004	Lipinski
6,395,613	B1	5/2002	Juengling	2004/0017989	A1	1/2004	So
6,404,056	B1	6/2002	Kuge et al.	2004/0018738	A1	1/2004	Liu
6,423,474	B1	7/2002	Holscher	2004/0023475	A1	2/2004	Bronser et al.
6,455,372	B1	8/2002	Weimer	2004/0023502	A1	2/2004	Tzou et al.
6,475,867	B1	11/2002	Hui et al.	2004/0036095	A1	2/2004	Brown et al.
6,500,756	B1	12/2002	Bell et al.	2004/0041189	A1	3/2004	Voshell et al.
6,514,884	B2	2/2003	Maeda	2004/0043623	A1	3/2004	Liu et al.
6,522,584	B1	2/2003	Chen et al.	2004/0053475	A1	3/2004	Sharma
6,534,243	B1	3/2003	Templeton	2004/0079988	A1	4/2004	Harari
6,548,396	B2	4/2003	Naik et al.	2004/0106257	A1	6/2004	Okamura et al.
6,559,017	B1	5/2003	Brown et al.	2004/0113171	A1 *	6/2004	Chiu et al. .... 257/119
6,566,280	B1	5/2003	Meagley et al.	2004/0157455	A1 *	8/2004	Johansson et al. .... 438/691
6,573,030	B1	6/2003	Fairbairn et al.	2004/0191997	A1 *	9/2004	Kawahara et al. .... 438/287
6,602,779	B1	8/2003	Li et al.	2004/0235255	A1	11/2004	Tanaka
6,627,933	B2	9/2003	Juengling	2005/0042879	A1	2/2005	Yin
6,632,741	B1	10/2003	Clevenger	2005/0074949	A1	4/2005	Jung et al.
6,638,441	B2	10/2003	Chang et al.	2005/0112886	A1	5/2005	Asakawa et al.
6,667,237	B1	12/2003	Metzler	2005/0142497	A1 *	6/2005	Ryou et al. .... 430/311
6,673,684	B1	1/2004	Huang et al.	2005/0153562	A1	7/2005	Furukawa et al.
6,686,245	B1	2/2004	Mathew et al.	2005/0164454	A1	7/2005	Leslie
6,689,695	B1	2/2004	Lui et al.	2005/0167394	A1	8/2005	Liu et al.
6,707,092	B2	3/2004	Sasaki	2005/0186705	A1	8/2005	Jackson et al.
6,709,807	B2	3/2004	Hallock et al.	2005/0272259	A1	12/2005	Hong
6,734,063	B2	5/2004	Willer et al.	2005/0277249	A1	12/2005	Juengling
6,734,107	B2	5/2004	Lai et al.	2006/0003182	A1	1/2006	Lane et al.
6,744,094	B2	6/2004	Forbes	2006/0024940	A1	2/2006	Furukawa et al.
6,768,663	B2	7/2004	Ogata	2006/0024945	A1	2/2006	Kim et al.
6,773,998	B1	8/2004	Fisher et al.	2006/0028859	A1	2/2006	Forbes
6,777,725	B2	8/2004	Willer et al.	2006/0046161	A1	3/2006	Yin et al.
6,794,699	B2	9/2004	Bissey et al.	2006/0046200	A1	3/2006	Abatchev et al.
6,800,930	B2	10/2004	Jackson et al.	2006/0046201	A1	3/2006	Sandhu et al.
6,835,662	B1	12/2004	Erhardt et al.	2006/0046407	A1	3/2006	Juengling
6,867,116	B1	3/2005	Chung	2006/0046422	A1	3/2006	Tran et al.
6,875,703	B1	4/2005	Furukawa et al.	2006/0046484	A1	3/2006	Abatchev et al.
6,924,191	B2	8/2005	Liu et al.	2006/0083996	A1	4/2006	Kim
6,936,507	B2	8/2005	Tang et al.	2006/0134909	A1 *	6/2006	Nagase et al. .... 438/637
6,955,961	B1	10/2005	Chung	2006/0172540	A1	8/2006	Marks et al.
6,962,867	B2	11/2005	Jackson et al.	2006/0189150	A1 *	8/2006	Jung ..... 438/758
7,015,124	B1	3/2006	Fisher et al.	2006/0211260	A1	9/2006	Tran
7,074,668	B1	7/2006	Park et al.	2006/0216293	A1	9/2006	Couto
7,084,076	B2	8/2006	Park et al.	2006/0216923	A1	9/2006	Tran et al.
7,098,105	B2	8/2006	Juengling	2006/0231900	A1	10/2006	Lee et al.
7,115,525	B2	10/2006	Abatchev	2006/0234138	A1	10/2006	Fehlhaber et al.
7,183,205	B2	2/2007	Hong	2006/0263699	A1	11/2006	Abatchev
7,183,597	B2	2/2007	Doyle	2006/0267075	A1	11/2006	Sandhu et al.
7,208,379	B2	4/2007	Venugopal et al.	2006/0273456	A1	12/2006	Sant
7,271,107	B2	9/2007	Marks et al.	2006/0276018	A1 *	12/2006	Nam et al. .... 438/585
7,288,445	B2	10/2007	Bryant et al.	2006/0278911	A1	12/2006	Eppich
7,291,560	B2	11/2007	Parascandola et al.	2006/0281266	A1	12/2006	Wells
2001/0005631	A1	6/2001	Kim et al.	2007/0018345	A1 *	1/2007	Chao et al. .... 264/1.1
				2007/0026672	A1	2/2007	Tang et al.

2007/0042605	A1 *	2/2007	Abatchev et al. ....	438/696
2007/0045712	A1	3/2007	Haller et al.	
2007/0048674	A1	3/2007	Wells	
2007/0049011	A1	3/2007	Tran	
2007/0049030	A1	3/2007	Sandhu et al.	
2007/0049032	A1	3/2007	Abatchev et al.	
2007/0049035	A1	3/2007	Tran	
2007/0049040	A1	3/2007	Bai et al.	
2007/0050748	A1	3/2007	Juengling	
2007/0145450	A1	6/2007	Wang et al.	
2007/0210449	A1 *	9/2007	Caspary et al. ....	257/734
2007/0215874	A1 *	9/2007	Furukawa et al. ....	257/48
2007/0215960	A1	9/2007	Zhu et al.	
2007/0275309	A1	11/2007	Liu	
2008/0054350	A1	3/2008	Breitwisch et al.	

## FOREIGN PATENT DOCUMENTS

DE	42 36 609	A1	5/1994
DE	44 08 764	A1	9/1994
DE	199 28 781	C1	7/2000
EP	0227303		7/1987
EP	0491408		6/1992
EP	1357433		10/2003
JP	57-048237		3/1982
JP	05343370		12/1993
JP	H8-55908		2/1996
JP	H8-55920		2/1996
JP	2004-152784		5/2004
KR	1999-0001440		1/1999
KR	1999-027887		4/1999
WO	WO 94/15261		7/1994
WO	WO 01/01489	A1	1/2001
WO	WO 02/099864	A1	12/2002
WO	WO 04/001799	A2	12/2003
WO	WO 2004/003977		1/2004
WO	WO 2004/073044	A2	8/2004
WO	WO 2005/010973		2/2005
WO	WO 2005/034215	A1	4/2005
WO	WO 2006/026699	A2	3/2006
WO	WO 2006/127586	A2	11/2006

## OTHER PUBLICATIONS

Bhave et al., "Developer-soluble Gap fill materials for patterning metal trenches in Via-first Dual Damascene process", preprint of Proceedings of SPIE: Advances in Resist Technology and Processing XXI, vol. 5376, John L. Sturtevant, editor, 2004, 8 pages.

Chung et al., "Pattern multiplication method and the uniformity of nanoscale multiple lines\*", *J. Vac. Sci. Technol. B*21(4), Jul./Aug. 2003, pp. 1491-95, Jul./Aug. 2003.

Chung et al., "Nanoscale Multi-Line Patterning Using Sidewall Structure", *Jpn., J.App. Phys.* vol. 41 (2002) Pt. 1, No. 6B, pp. 4410-4414, 2002.

Joubert et al., "Nanometer scale linewidth control during etching of polysilicon gates in high-density plasmas", *Microelectronic Engineering* 69 (2003), pp. 350-357.

Lim et al., "Atomic layer deposition of transition metals", *Nature Materials*, vol. 2, Nov. 2003, pp. 749-754, 6 pages.

Oehrlein et al., "Pattern transfer into low dielectric materials by high-density plasma etching", *Solid State Tech.*, May 2000, 8 pages.

Sakao et al., "A Straight-Line-Trench Isolation and Trench-Gate Transistor (SLIT) Cell for Giga-bit DRAMs", Proceedings of IEEE VLSI Technology Symposium May 17-19, 1993 Kyoto, Japan, May 17, 1993, pp. 19-20.

Schloesser et al., "Highly Scalable Sub-50nm Vertical Double Gate Trench DRAM Cell", Memory Development Center, Infineon Tech., 2004, 4 pages.

Yan et al., "Scaling the Si MOSFET: From Bulk to SOI to Bulk", *IEEE Transactions on Electron Devices USA*; vol. 39, No. 7, Jul. 1992, pp. 1704-1710.

U.S. Appl. No. 11/192,828, filed Jul. 29, 2005.

U.S. Appl. No. 11/213,486, filed Aug. 25, 2005.

U.S. Appl. No. 11/215,982, filed Aug. 31, 2005.

U.S. Appl. No. 11/216,613, filed Aug. 30, 2005.

U.S. Appl. No. 11/217,270, filed Sep. 1, 2005.

U.S. Appl. No. 11/219,067, filed Sep. 1, 2005.

U.S. Appl. No. 11/219,346, filed Sep. 1, 2005.

U.S. Appl. No. 11/219,349, filed Sep. 1, 2005.

U.S. Appl. No. 11/219,604, filed Sep. 1, 2005.

U.S. Appl. No. 11/329,755, filed Jan. 11, 2006.

U.S. Appl. No. 11/366,212, filed Mar. 2, 2006.

U.S. Appl. No. 11/367,020, filed Mar. 2, 2006.

"U.S. Appl. No. 11/543,515, filed Oct. 24, 2006, MICRON Ref. No. 2005-1173.00/US".

"Ex parte Cantell, unpublished decision of the Board of Patent Appeals and Interferences, Mar. 4, 2005".

Choi et al., "Sublithographic nanofabrication technology for nanocatalysts and DNA chips," *J. Vac. Sci. Technol.*, Nov./Dec. 2003; pp. 2951-2955.

Bruek, S.R.J., "Optical and interferometric lithography—Nanotechnology enablers," *Proceedings of the IEEE*, vol. 93, No. 10, Oct. 2005, pp. 1704-1721.

Sheats et al., "Microlithography: Science and Technology," *Marcel Dekker, Inc.*, pp. 104-105 (1998).

U.S. Office Action issued Jun. 2, 2008 in U.S. Appl. No. 11/219,067, filed Sep. 1, 2005.

U.S. Office Action issued Jun. 5, 2008 in U.S. Appl. No. 11/514,117, filed Aug. 30, 2006.

U.S. Office Action issued Jul. 11, 2008 in U.S. Appl. No. 11/367,020, filed Mar. 2, 2006.

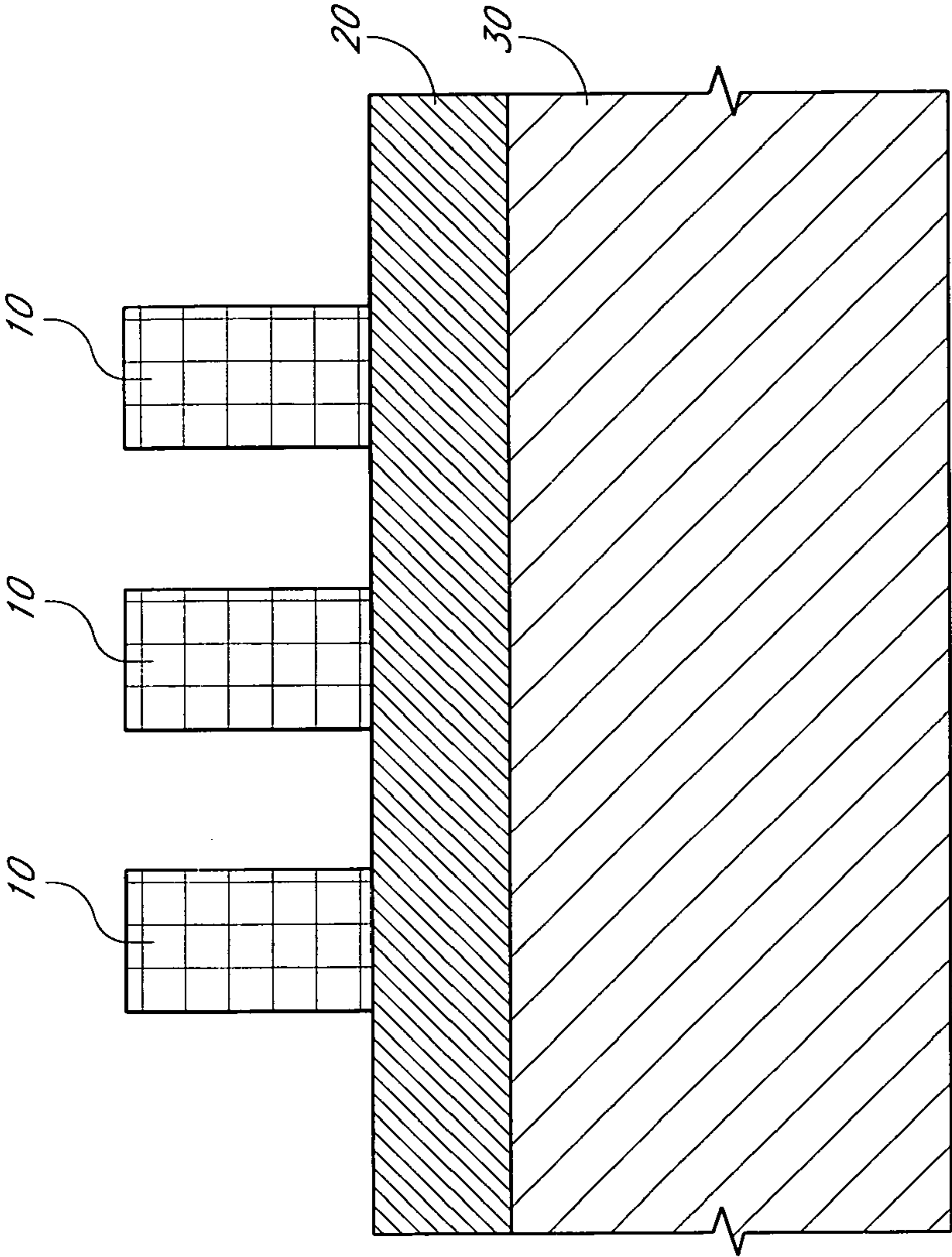
International Preliminary Report on Patentability of Oct. 16, 2008 for International Application No. PCT/US2007/011525, filed May 14, 2007.

Office Action of Mar. 25, 2009 in U.S. Appl. No. 11/744,074, filed May 3, 2009.

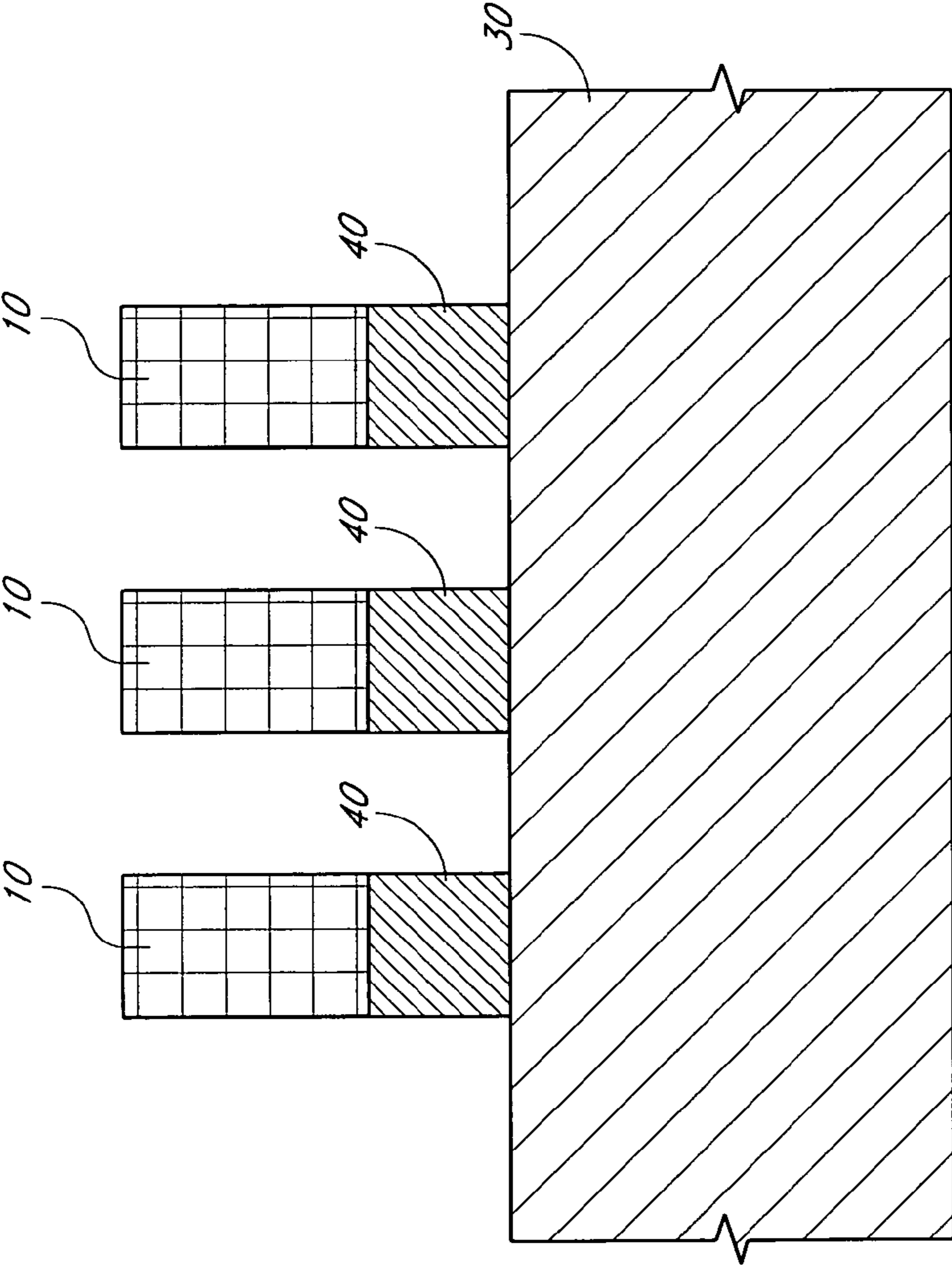
Park et al., "Mass-productive ultra-low temperature ALD SiO<sub>2</sub> process promising for sub-90nm memory and logic devices", *Electron Devices Meeting, IEDM '02 Digest. International pp. 229-232 (2002).*

Search Report and Written Opinion dated Mar. 15, 2010 in corresponding Singapore Patent Application No. 200807334-8.

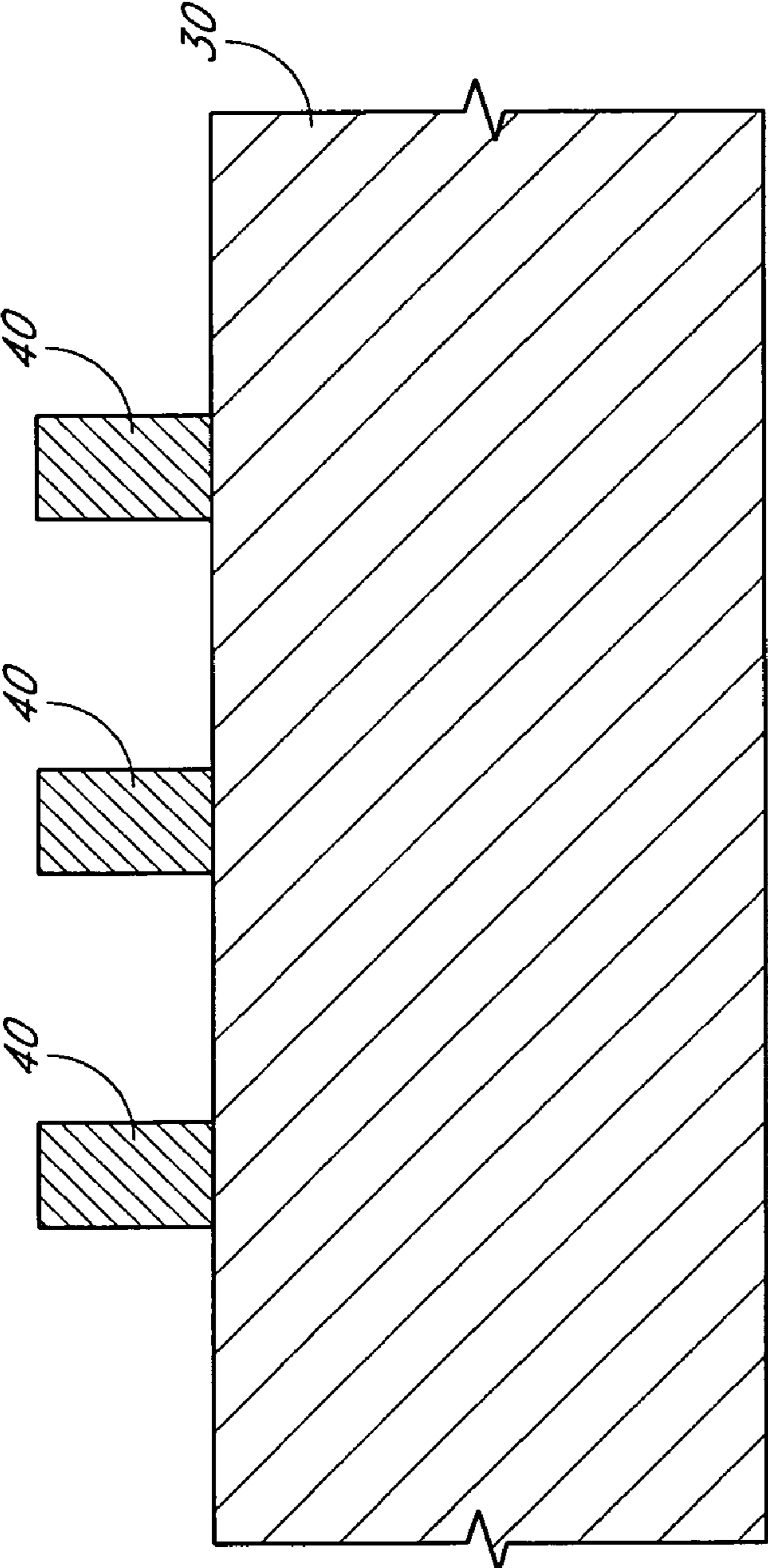
\* cited by examiner



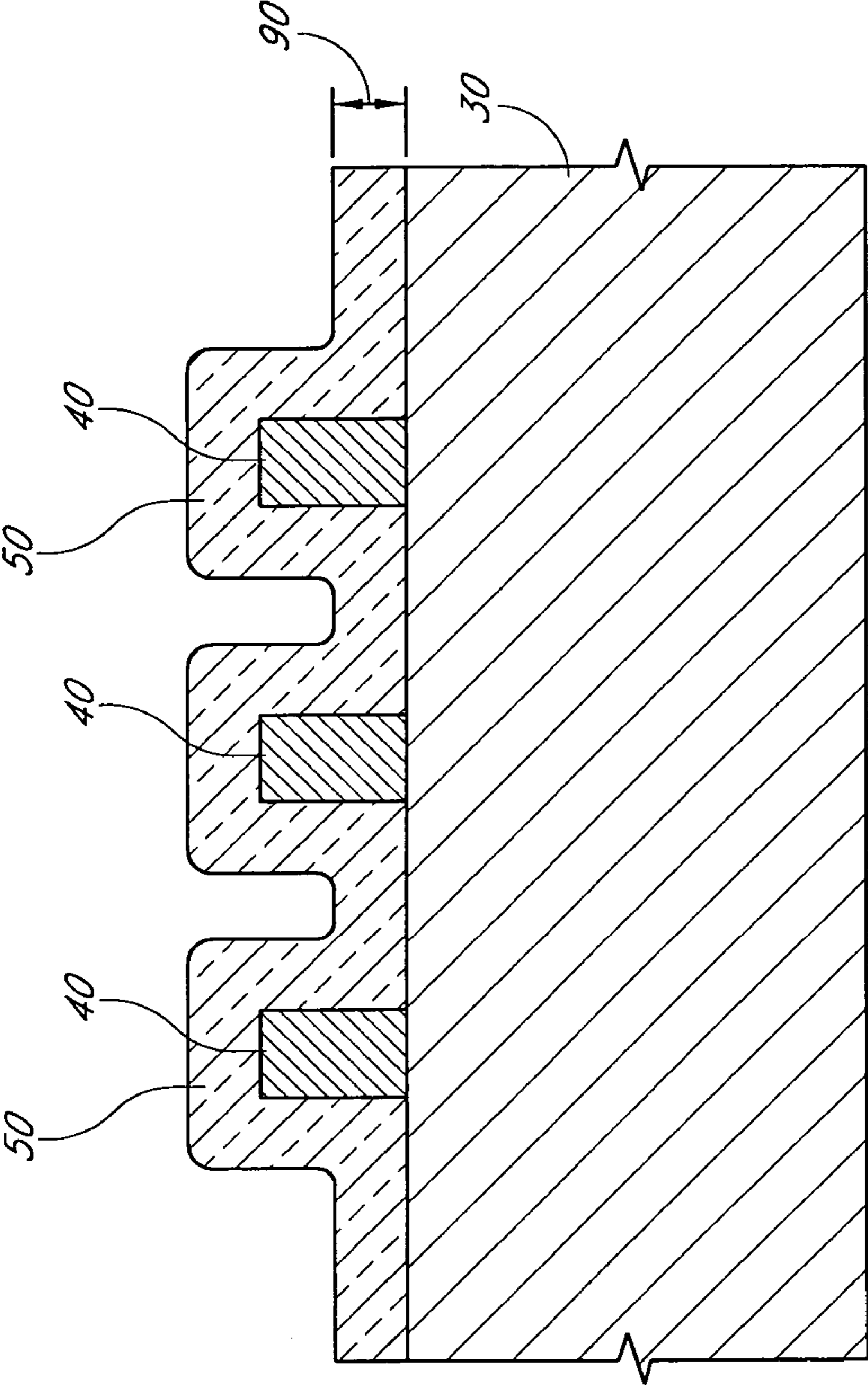
*FIG. 1A*  
*(PRIOR ART)*



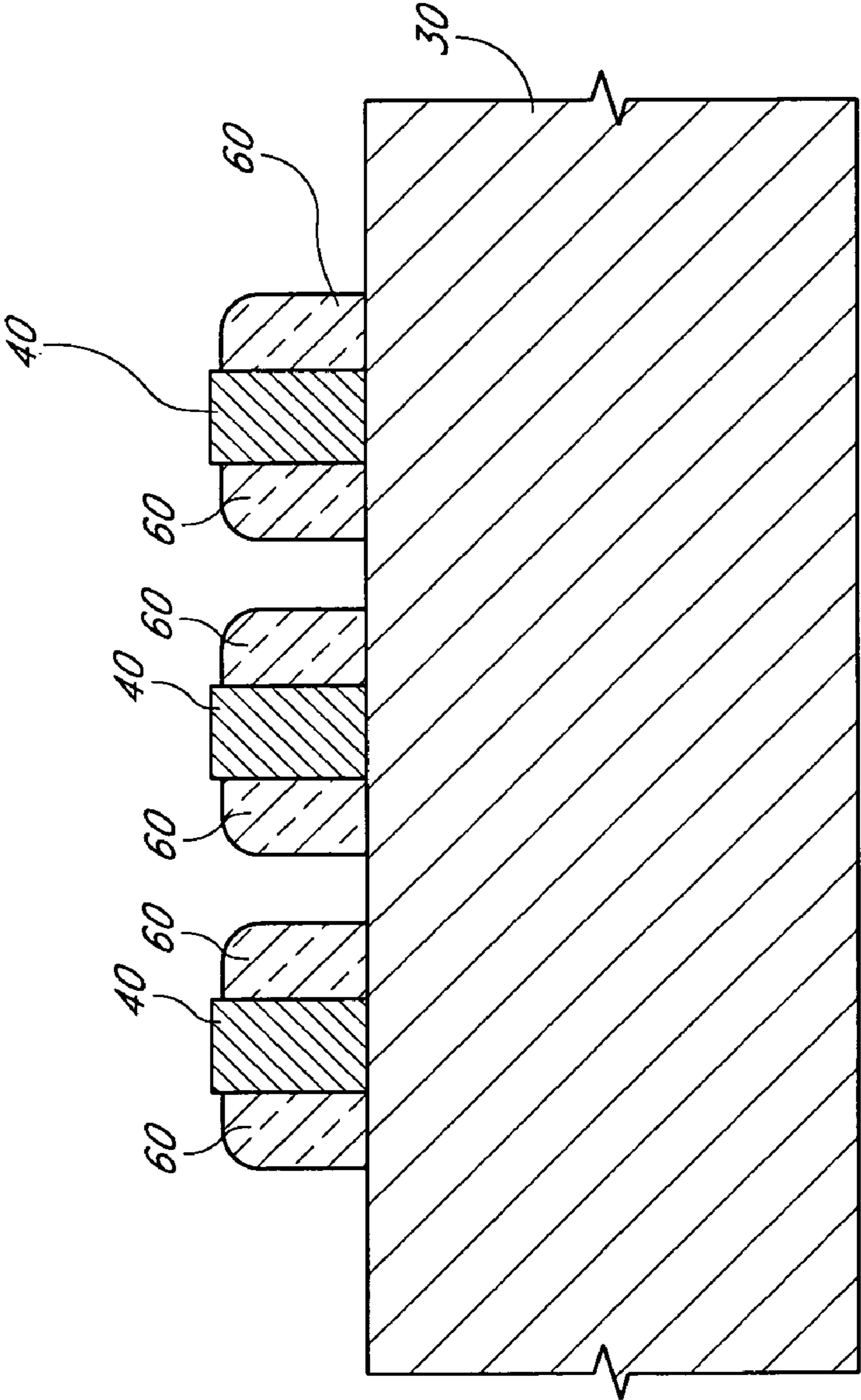
*FIG. 1B*  
*(PRIOR ART)*



*FIG. 1C*  
*(PRIOR ART)*

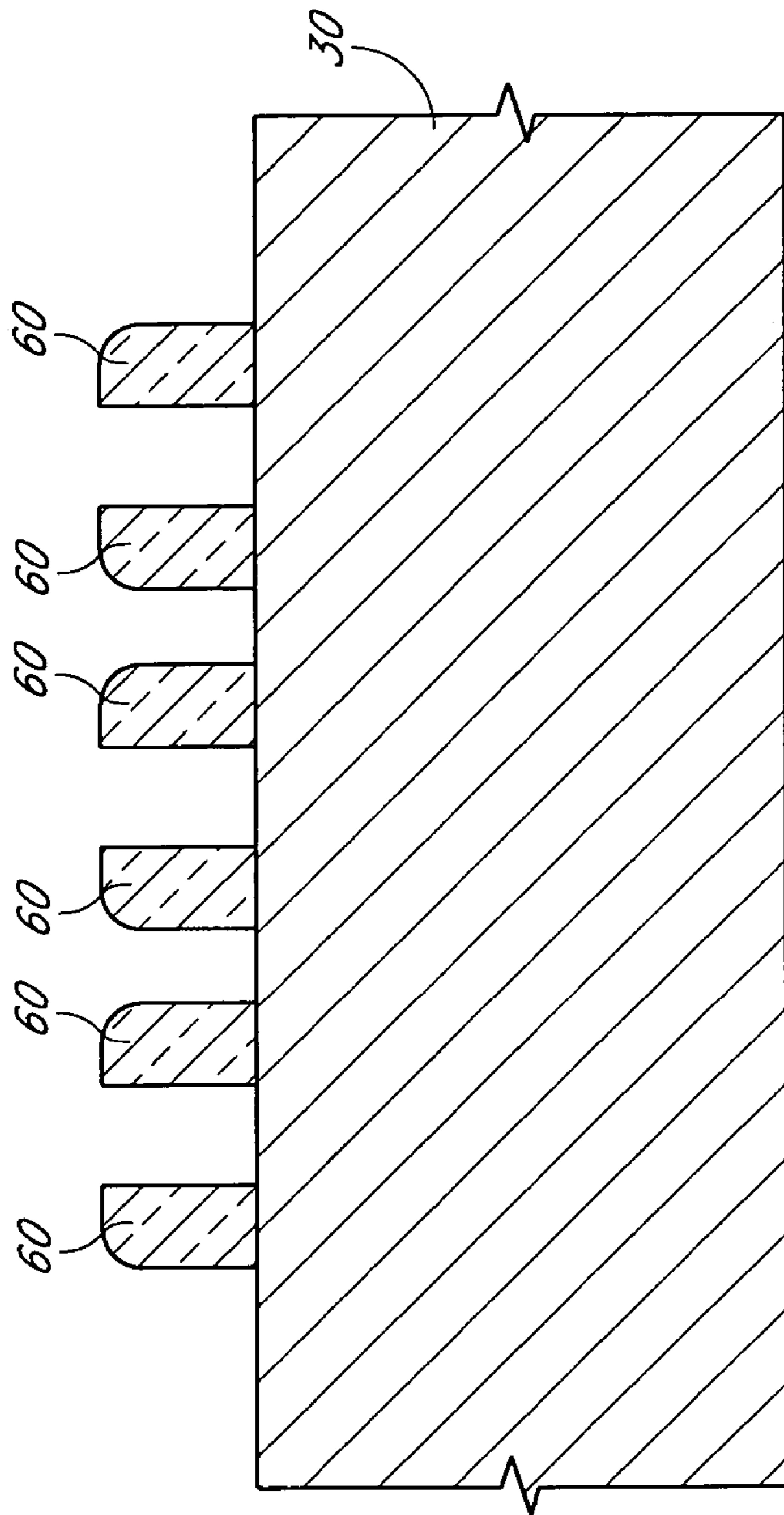


*FIG. 1D*  
*(PRIOR ART)*



*FIG. 1E*  
*(PRIOR ART)*





*FIG. 1F*  
*(PRIOR ART)*

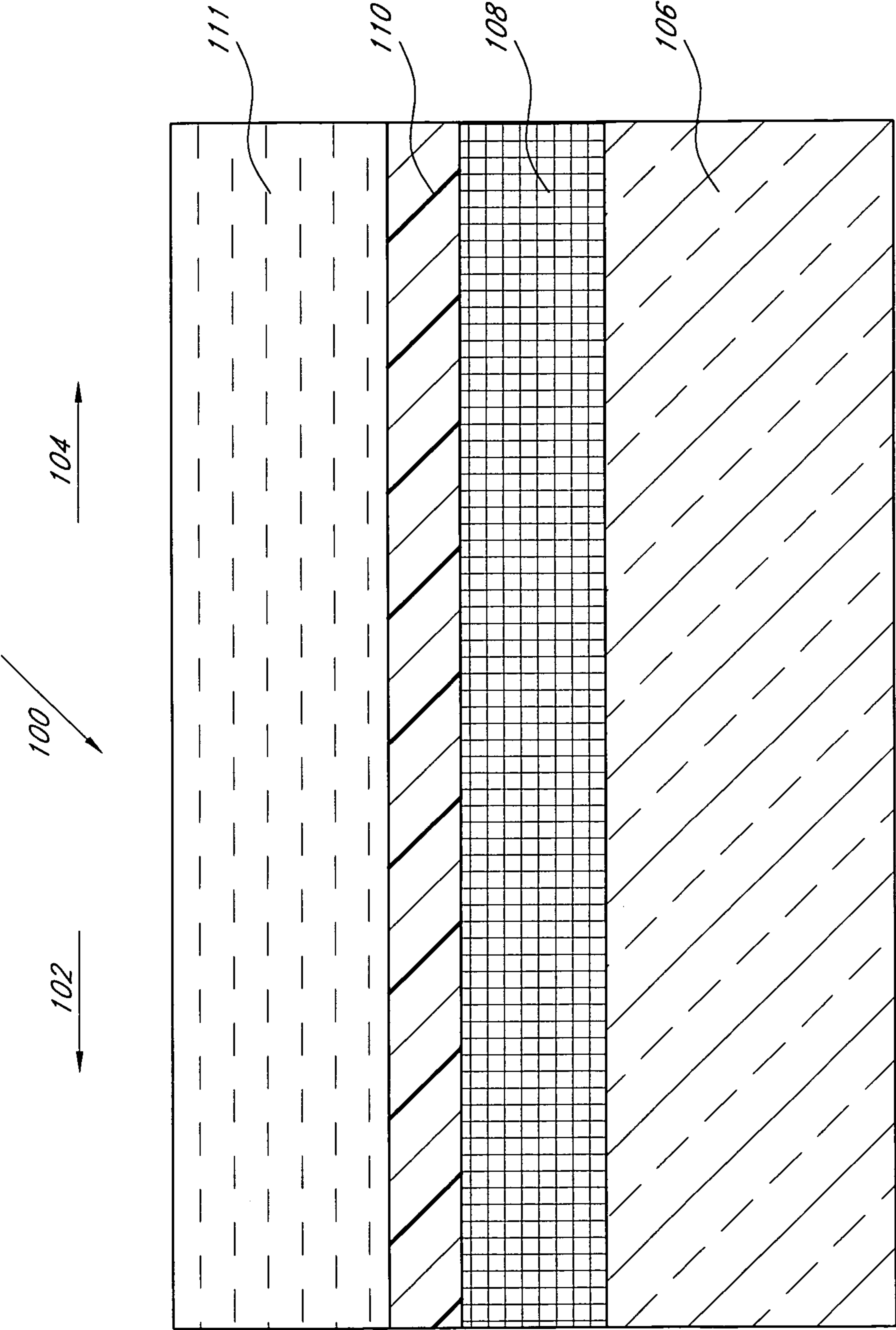


FIG. 2A

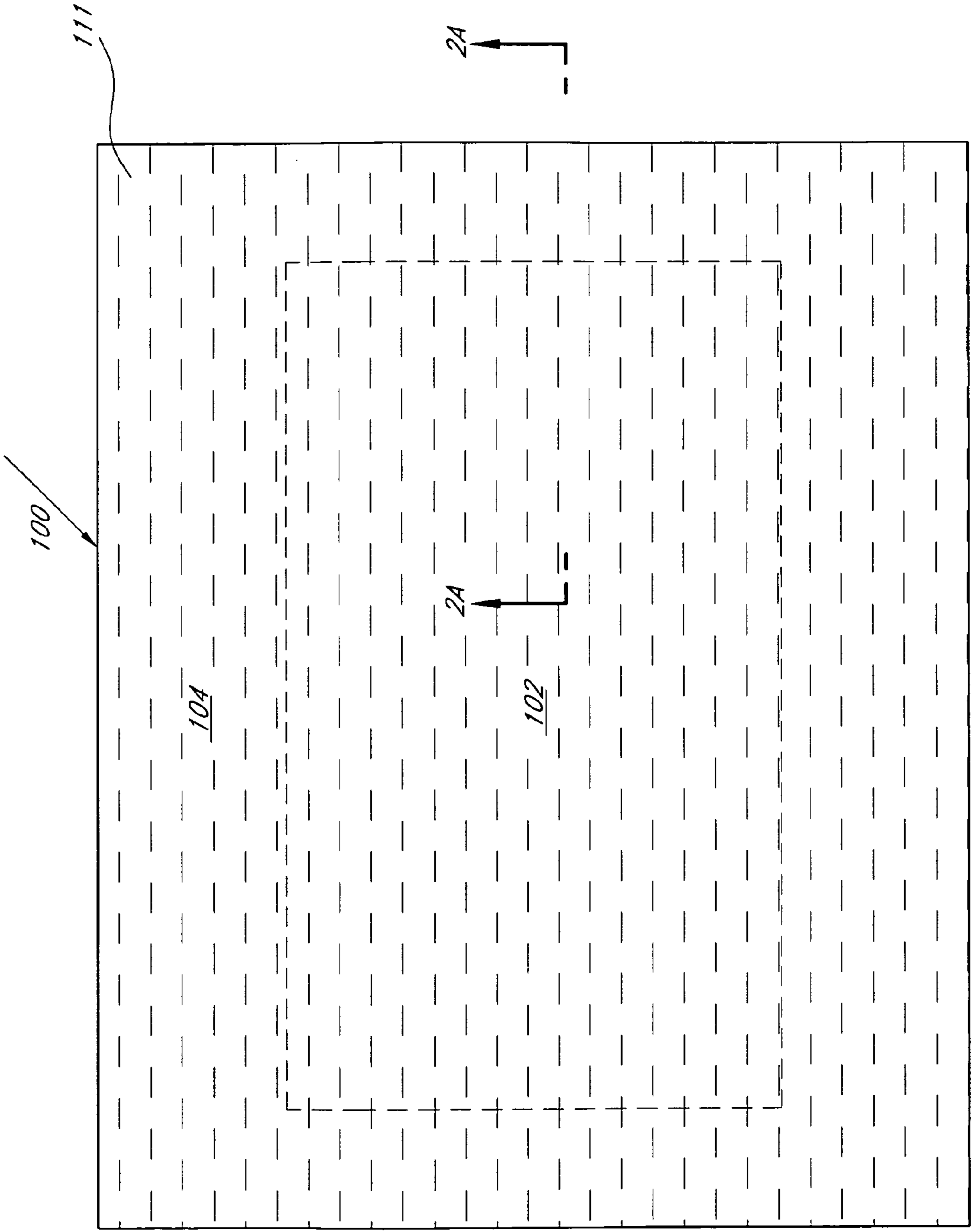


FIG. 2B

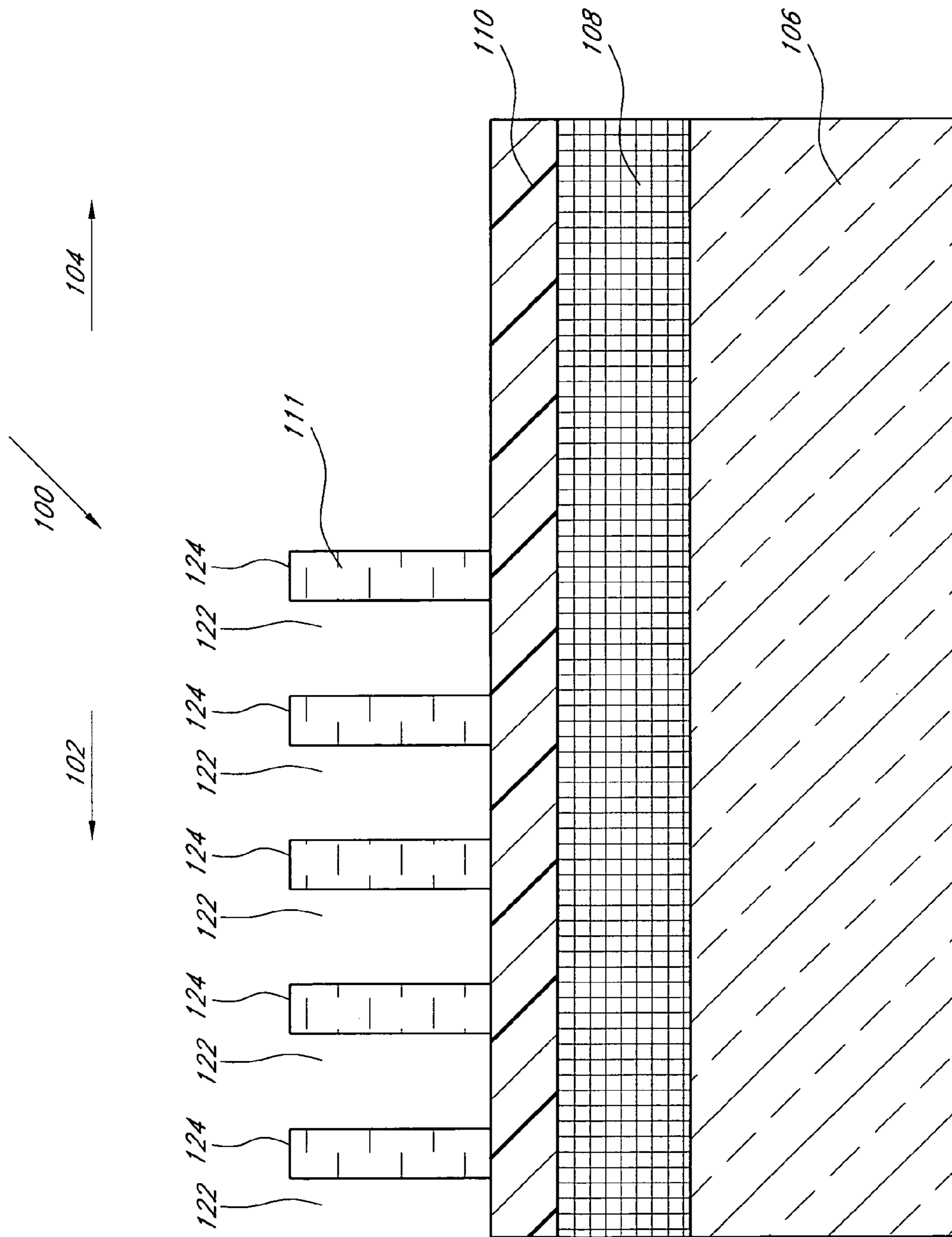


FIG. 3A

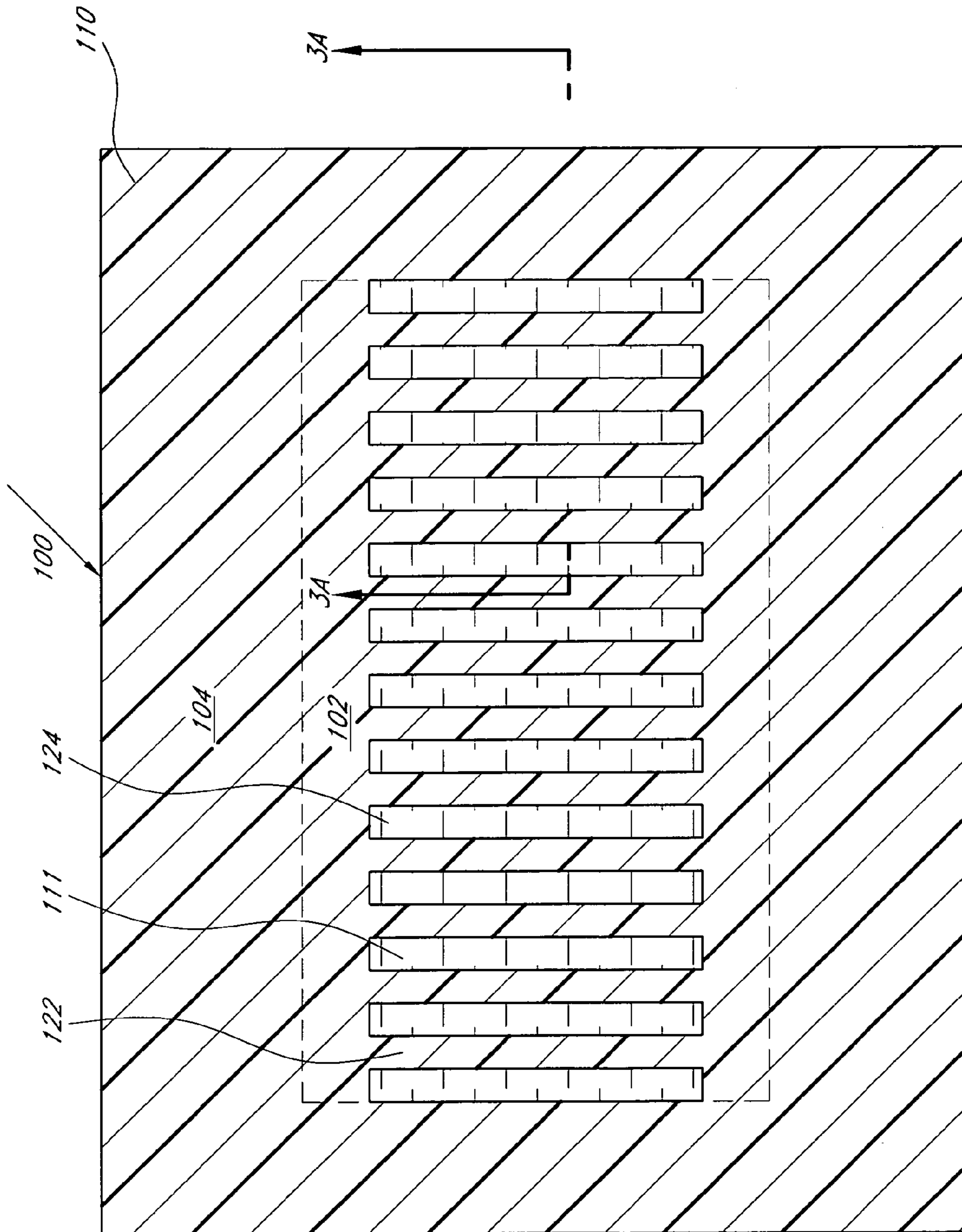


FIG. 3B

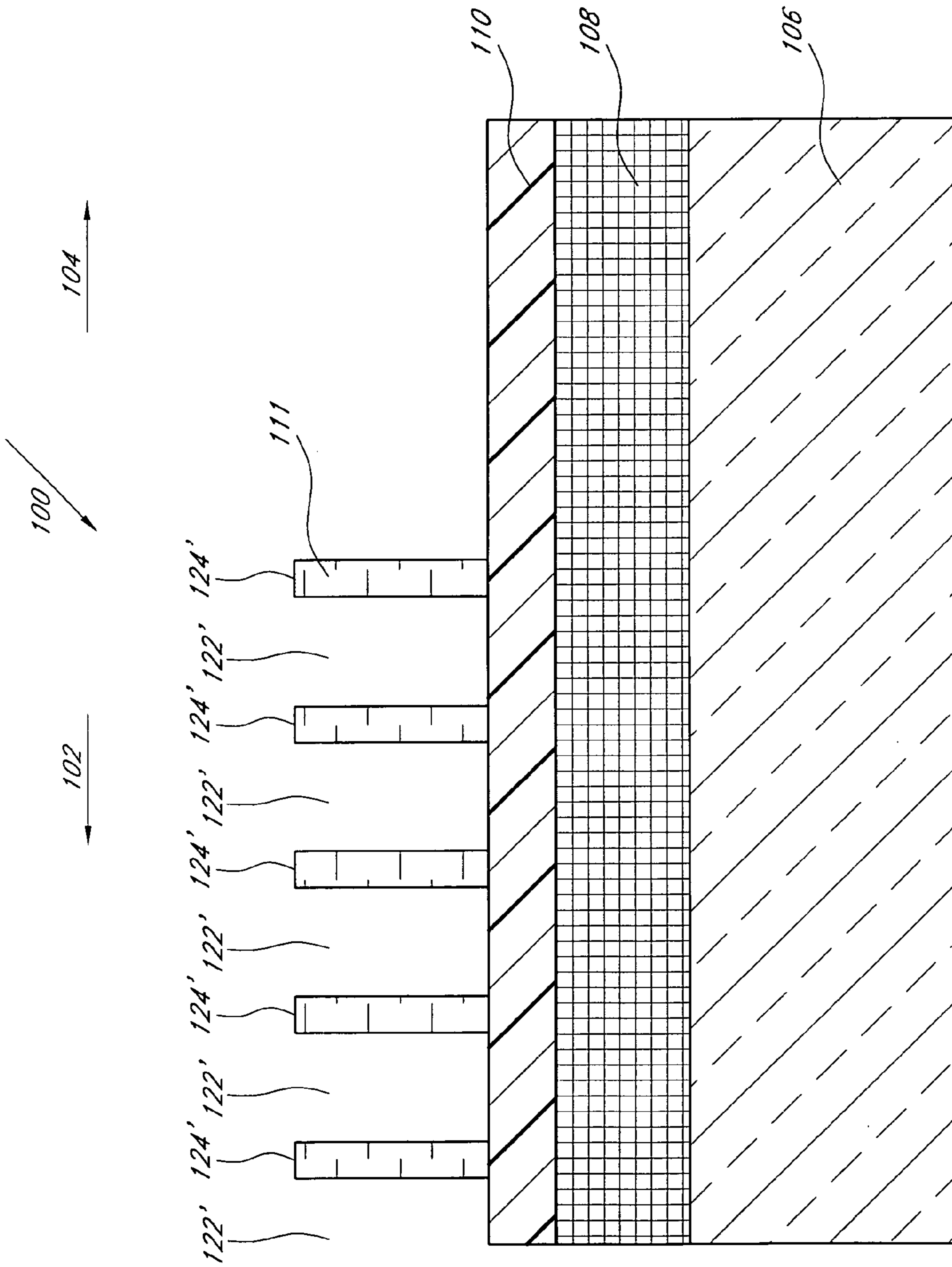


FIG. 4A

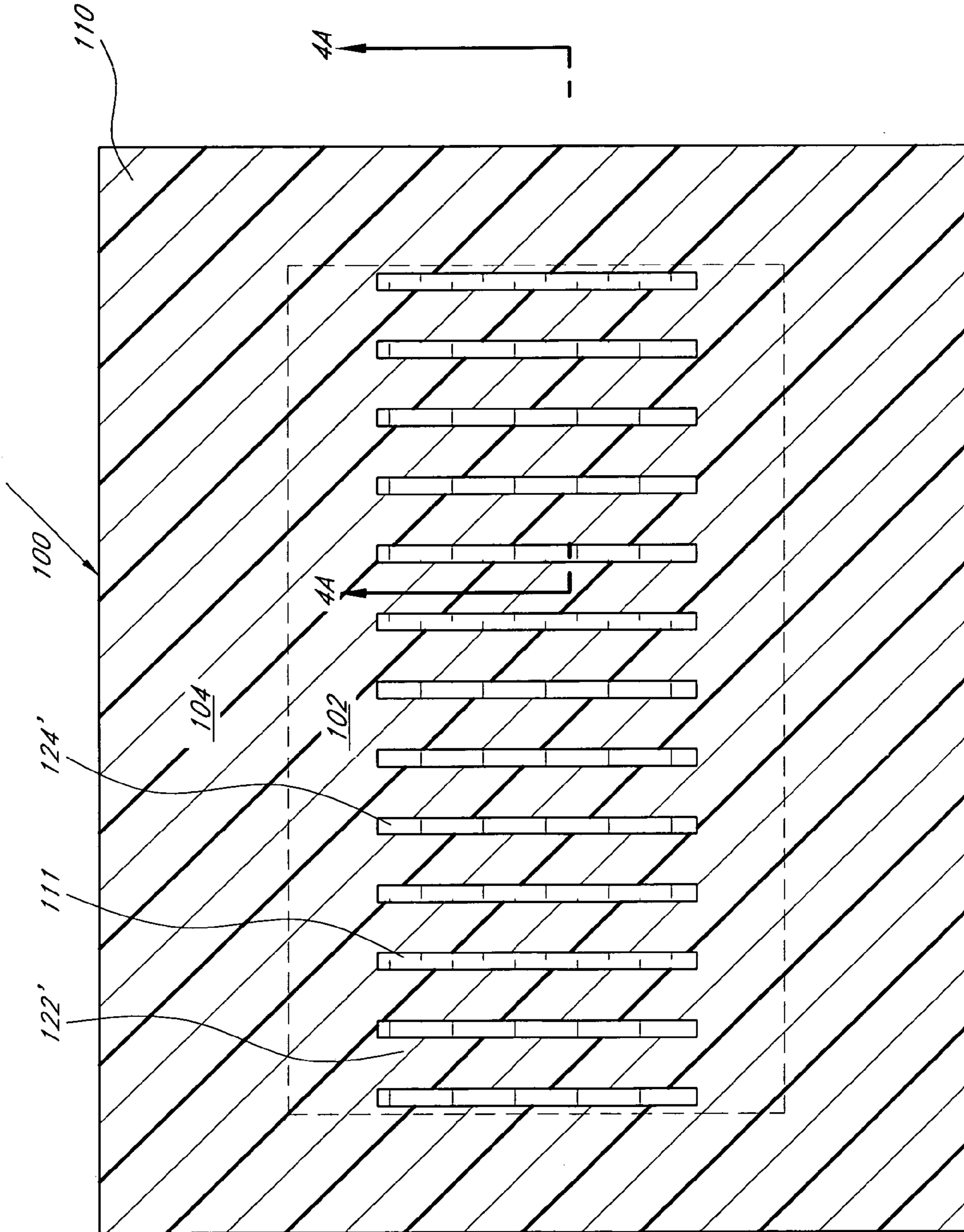


FIG. 4B

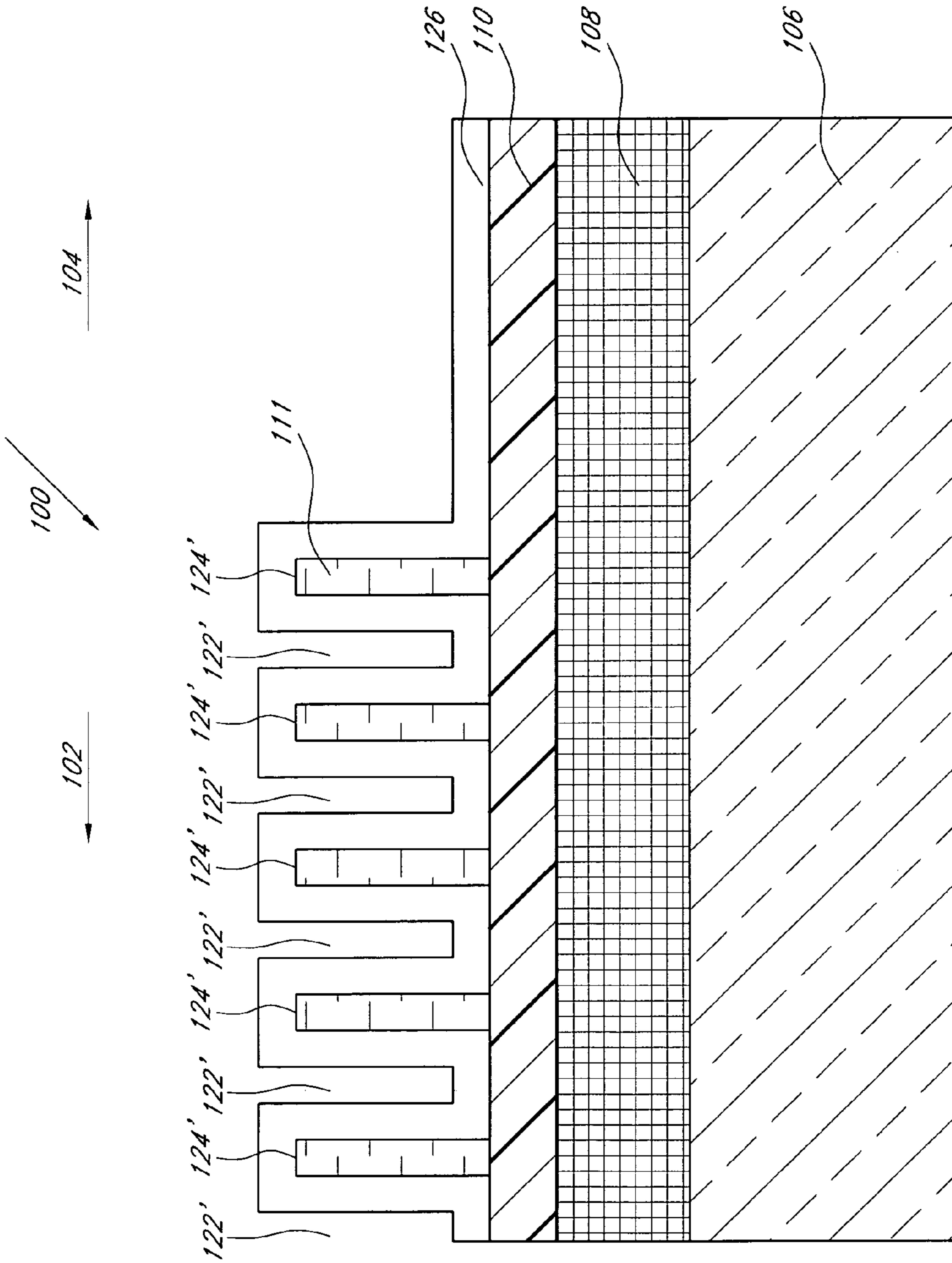


FIG. 5A



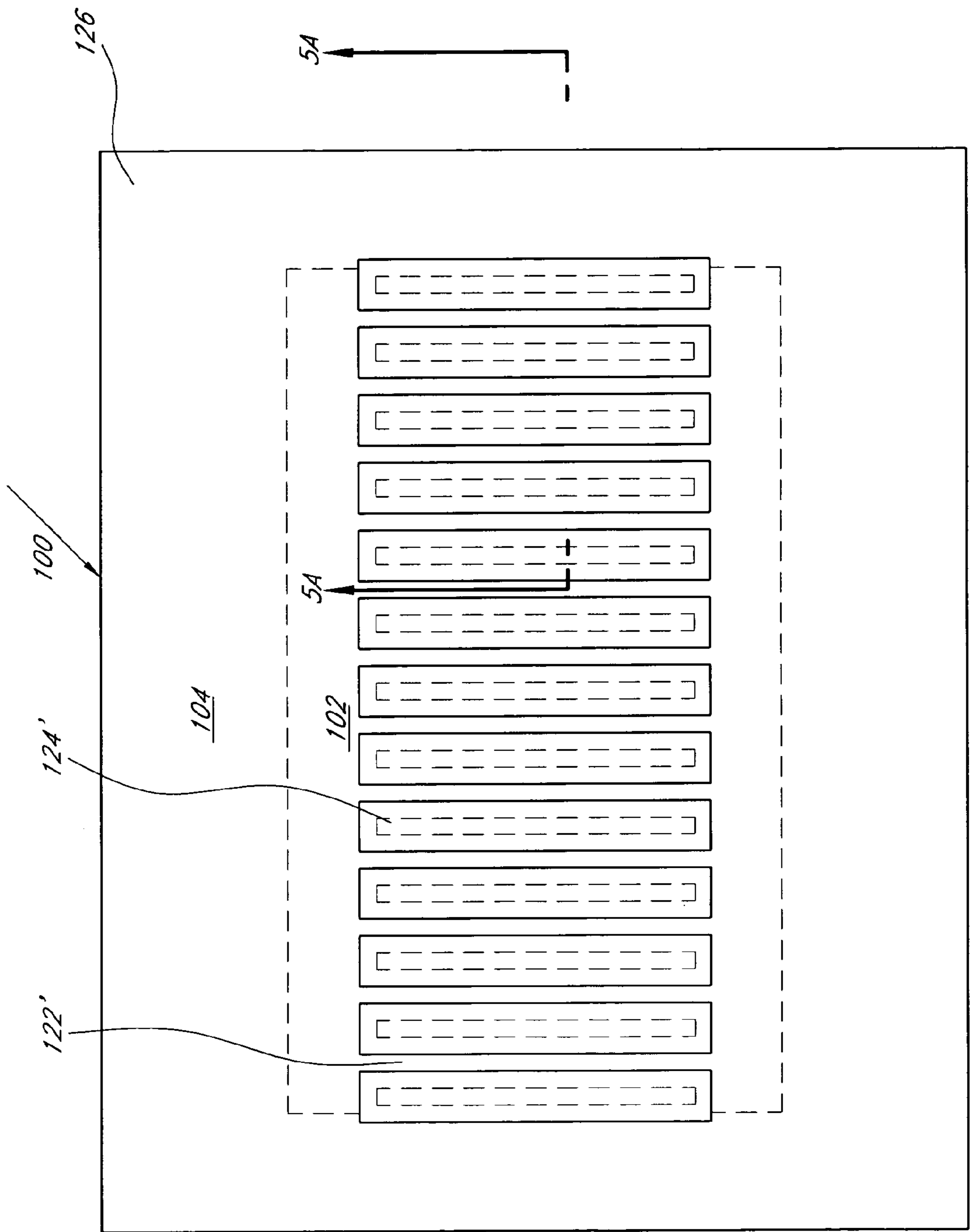


FIG. 5B

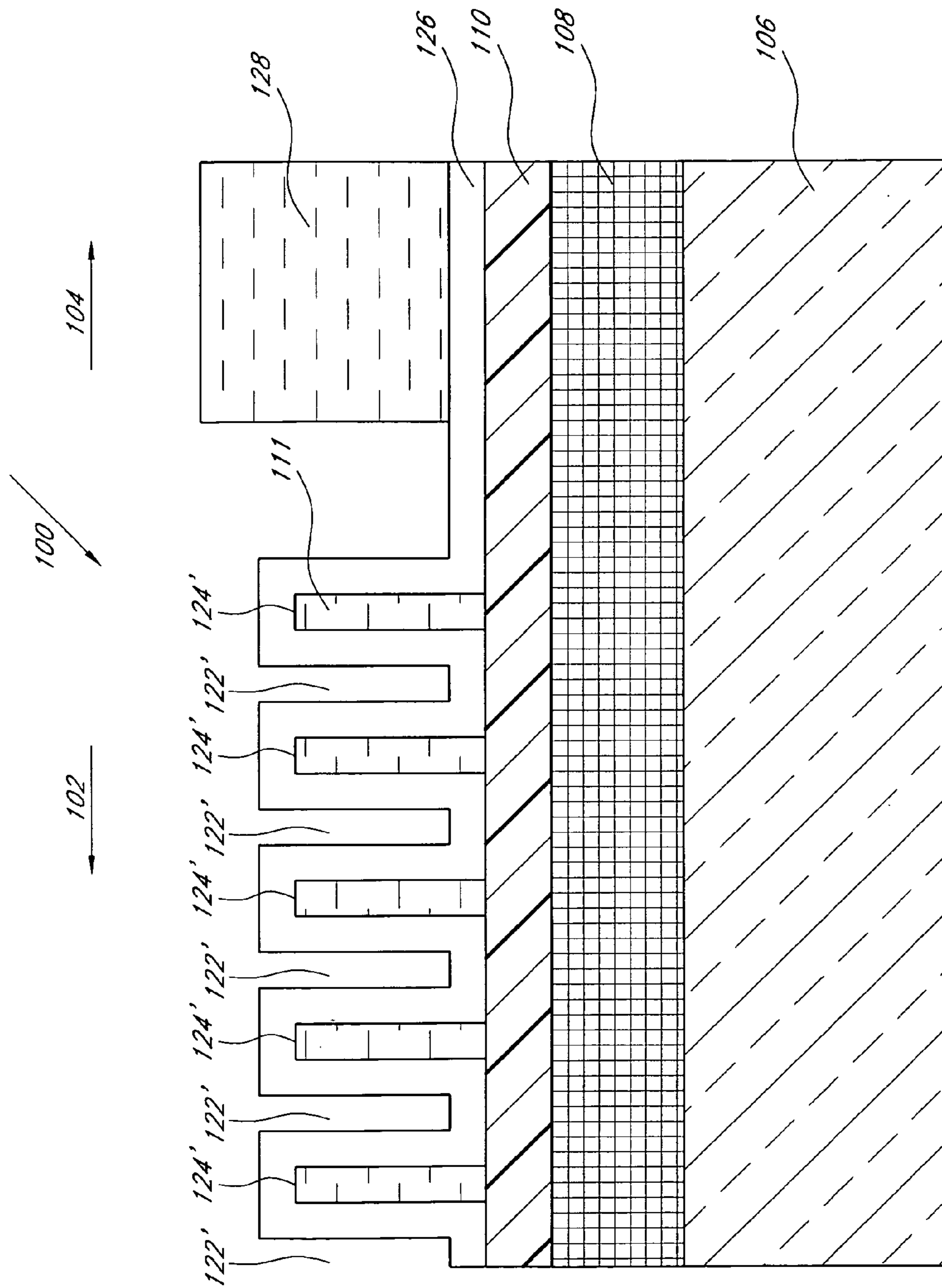


FIG. 6A

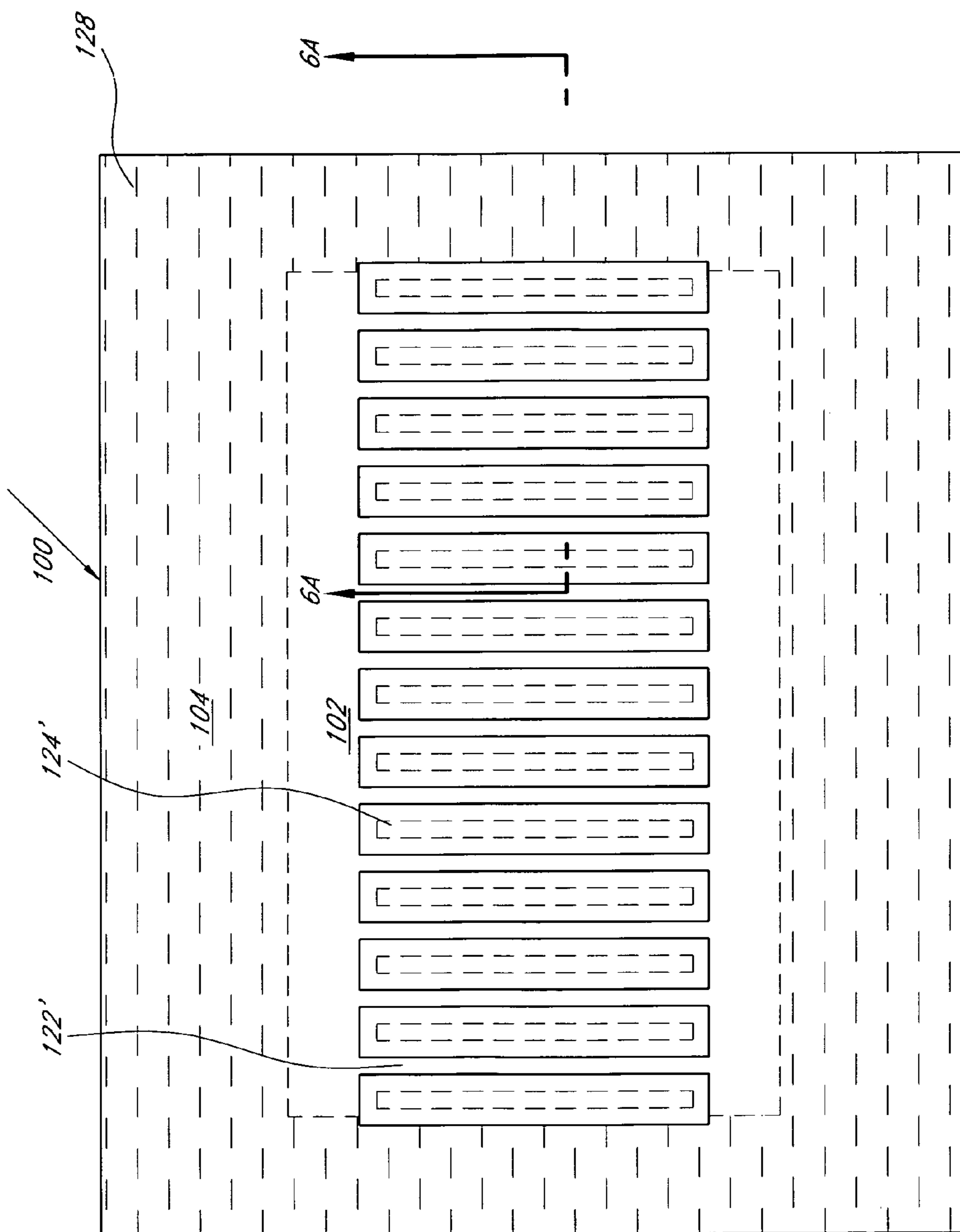


FIG. 6B

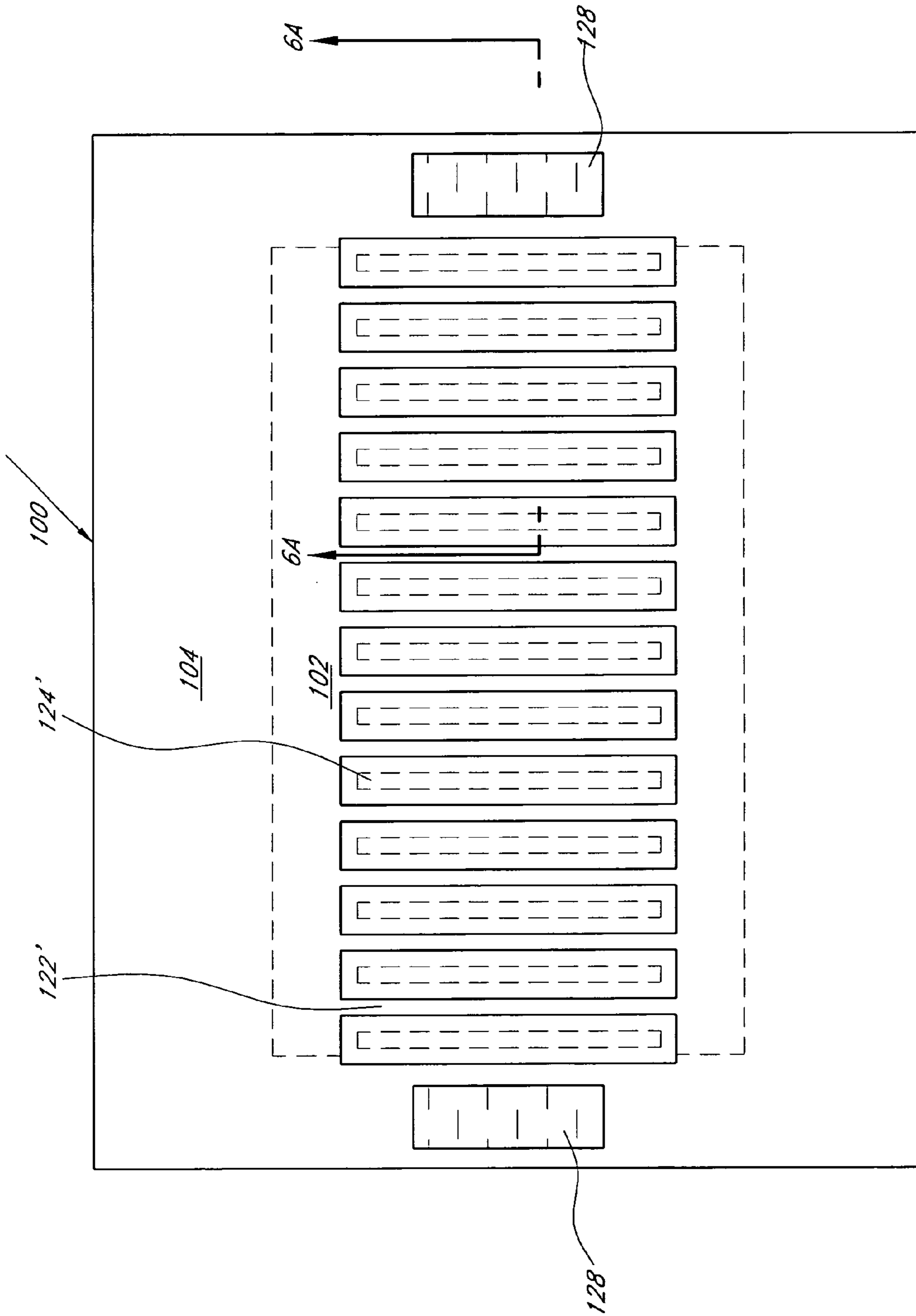


FIG. 6C

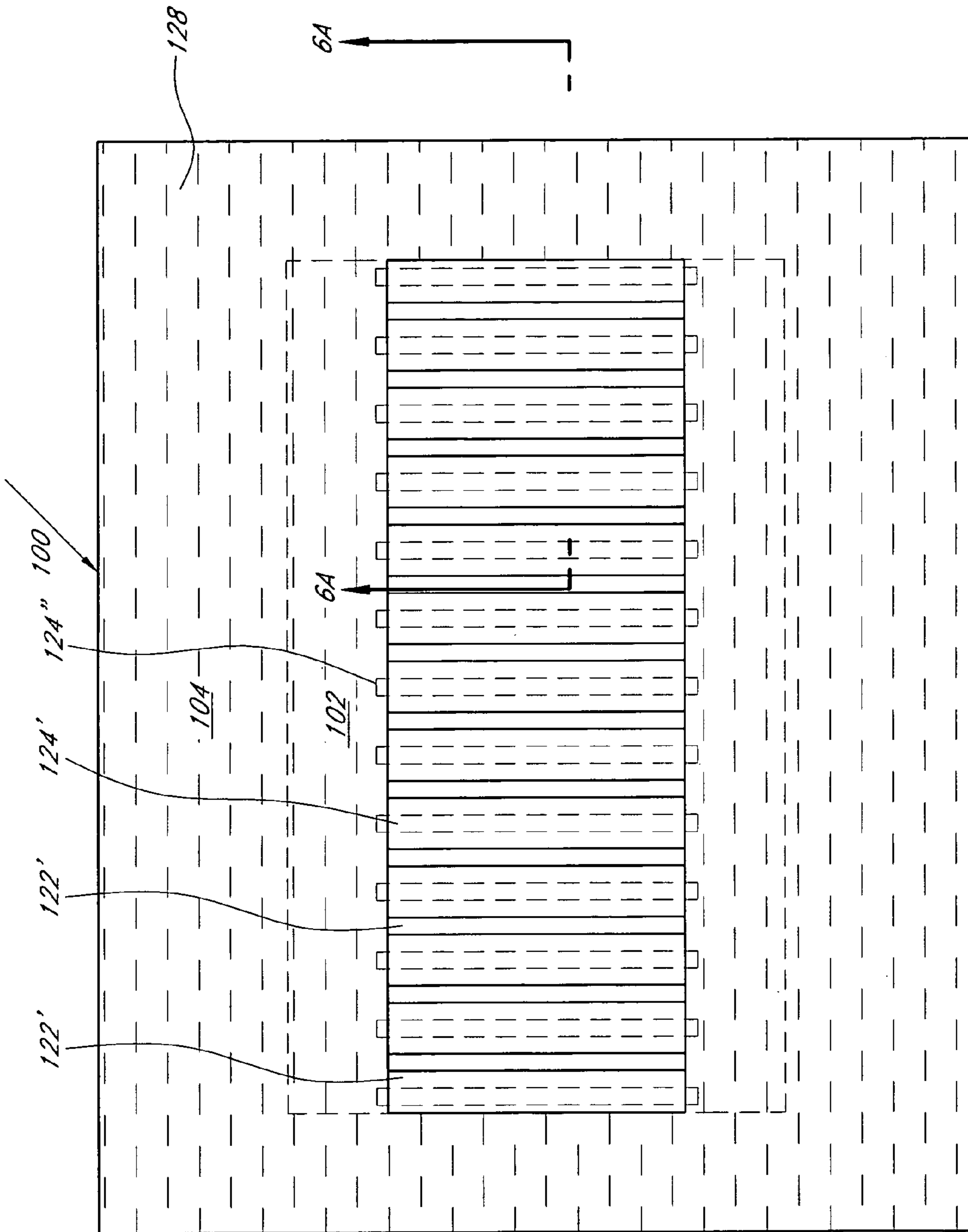


FIG. 6D

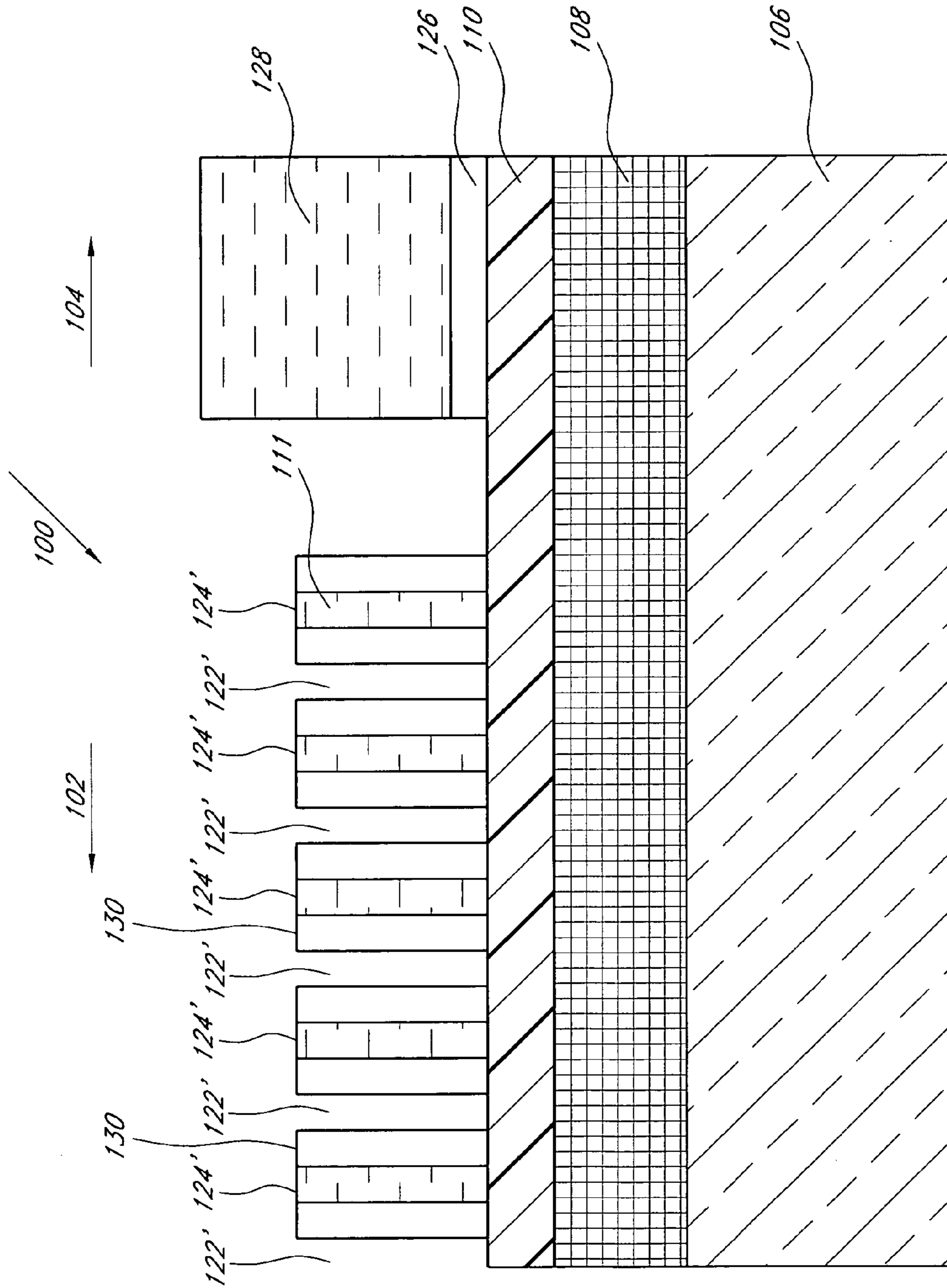


FIG. 7A

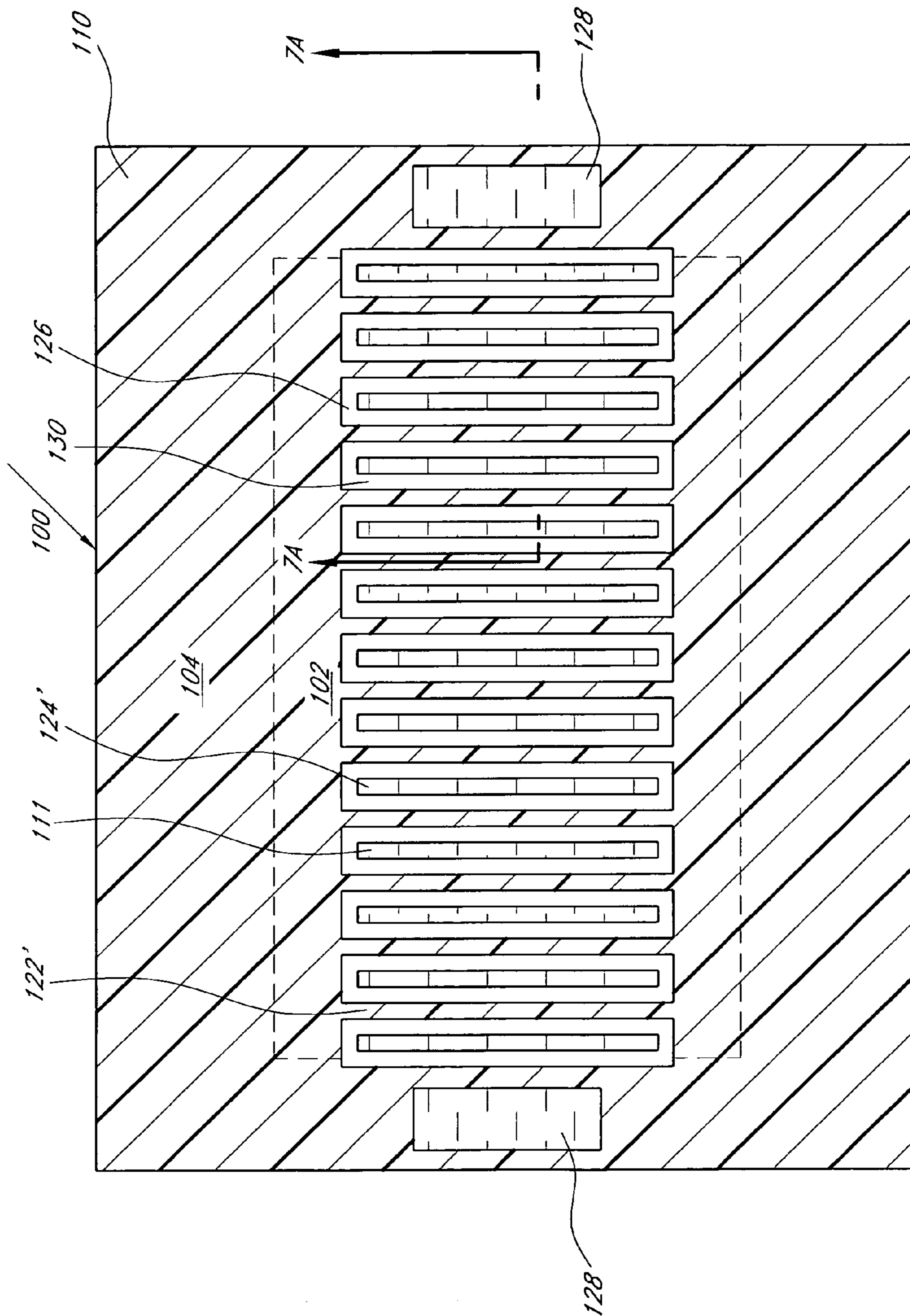


FIG. 7B

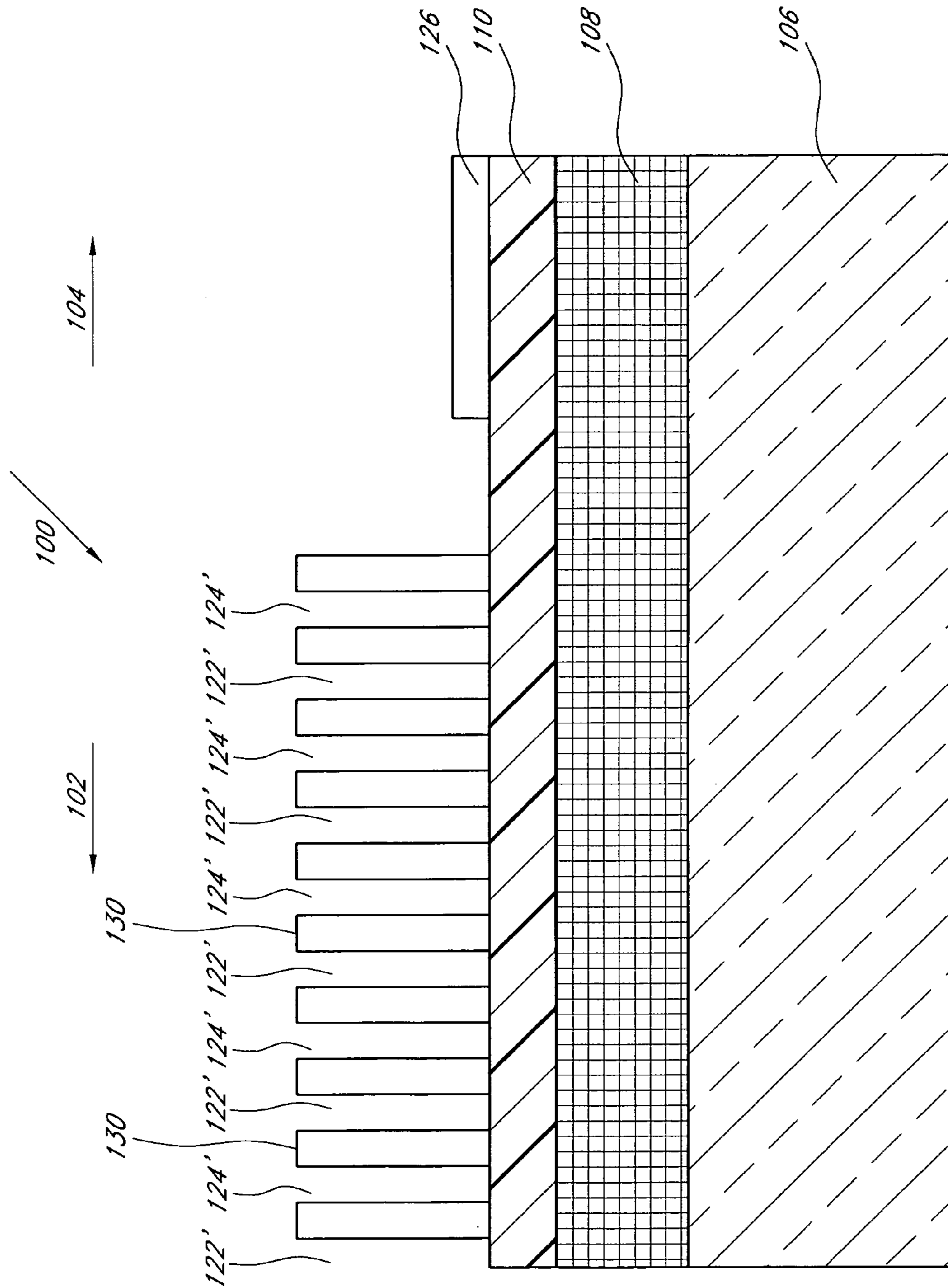


FIG. 8A



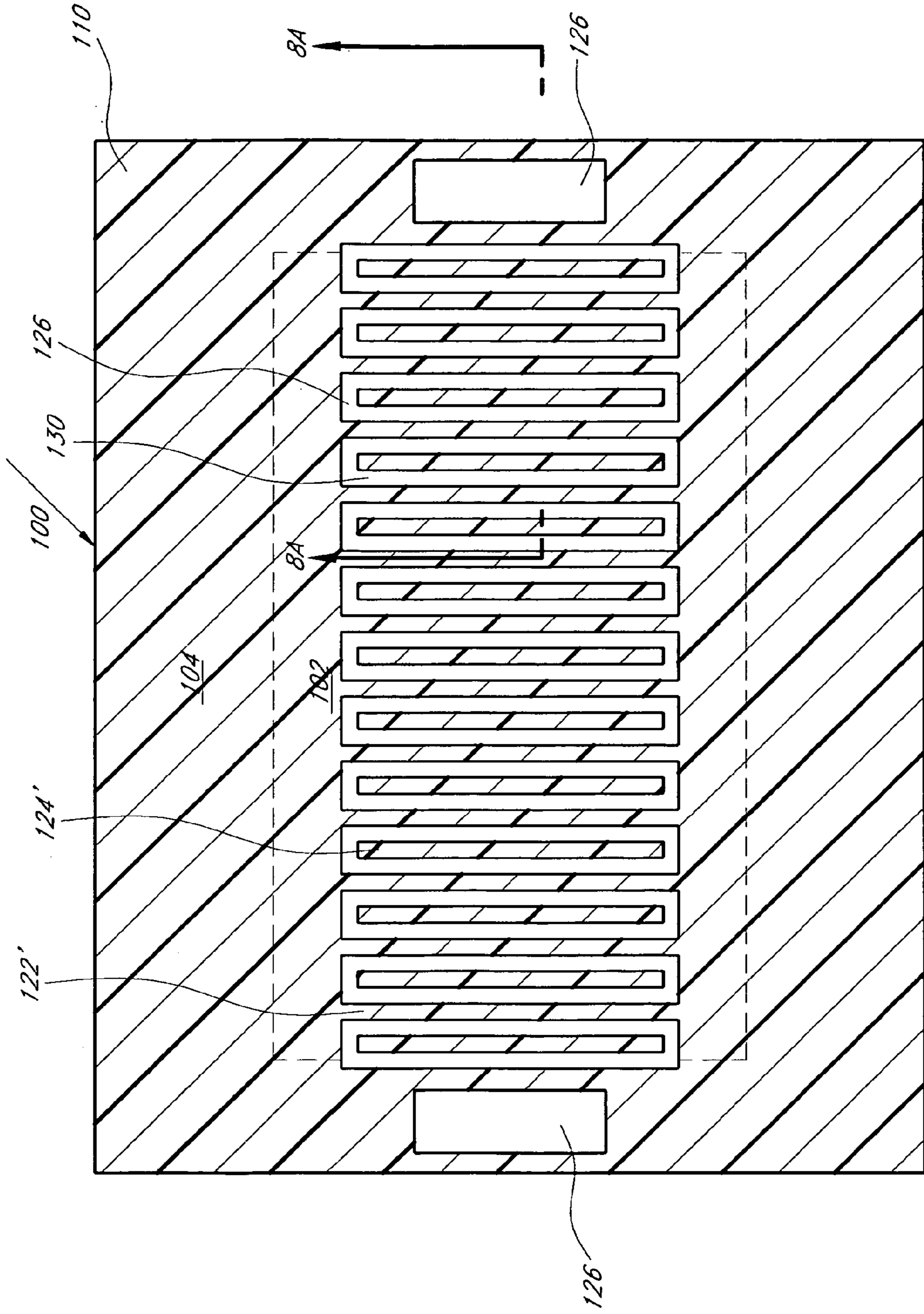


FIG. 8B

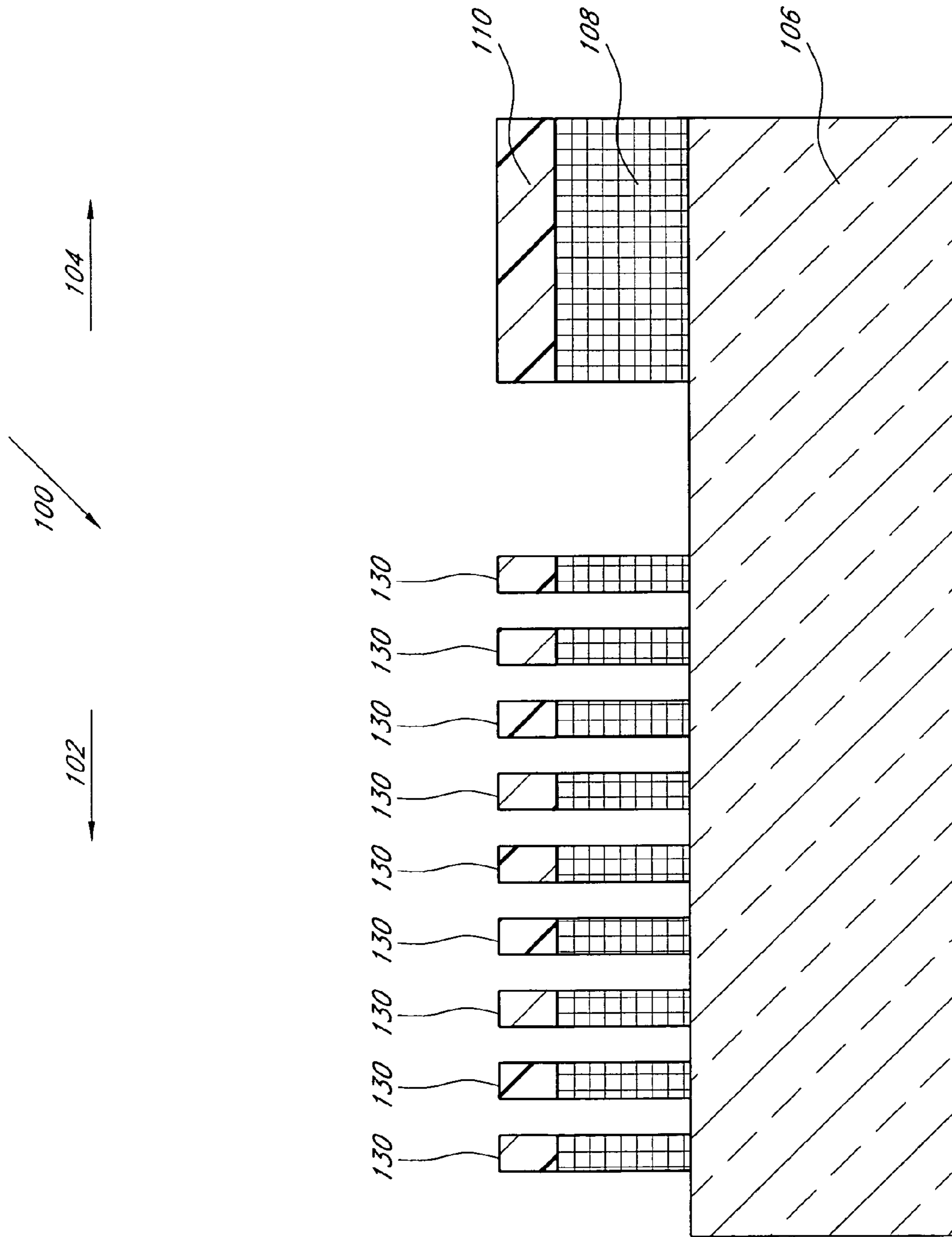


FIG. 9A

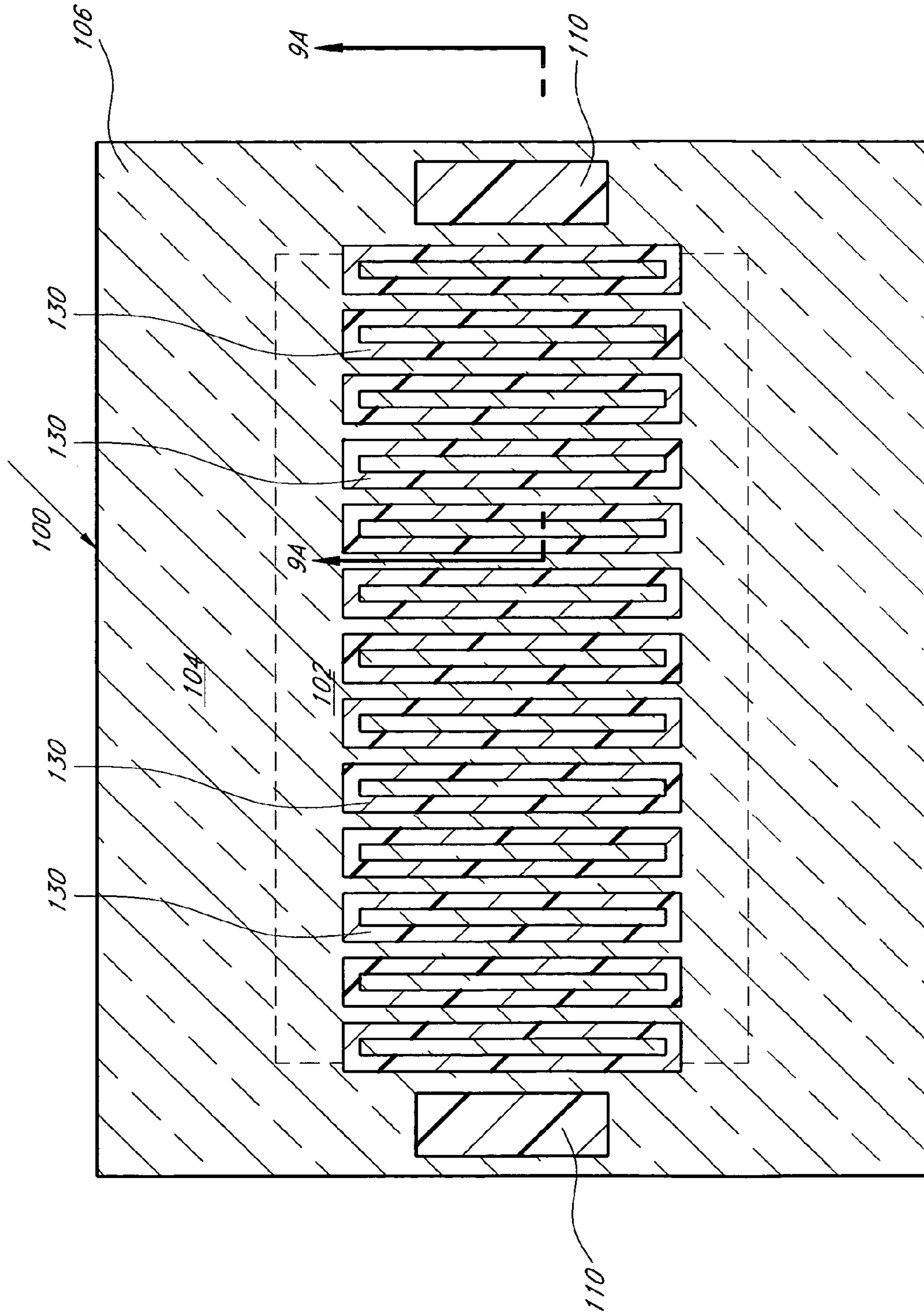


FIG. 9B

## SIMPLIFIED PITCH DOUBLING PROCESS FLOW

### CROSS-REFERENCE TO RELATED APPLICATIONS

This application is related to, and incorporates by reference the entire disclosure of the following: U.S. patent application Ser. No. 11/214,544 (filed 29 Aug. 2005); U.S. patent application Ser. No. 11/219,067 (filed 1 Sep. 2005); U.S. patent application Ser. No. 11/366,212 (filed 2 Mar. 2006); and U.S. patent application Ser. No. 11/367,020 (filed 2 Mar. 2006).

### FIELD OF THE INVENTION

The present invention relates generally to integrated circuit fabrication, and more specifically to simplified processes for forming pitch doubled integrated circuit features.

### BACKGROUND OF THE INVENTION

Integrated circuits are continuously being made smaller as demand for portability, computing power, memory capacity and energy efficiency in modern electronics grows. Therefore, the size of the integrated circuit constituent features, such as electrical devices and interconnect line widths, is also decreasing continuously. The trend of decreasing feature size is evident in memory circuits or devices such as dynamic random access memory ("DRAM"), flash memory, nonvolatile memory, static random access memory ("SRAM"), ferroelectric ("FE") memory, logic gate arrays and so forth.

For example, DRAM typically comprises millions of identical circuit elements, known as memory cells. A typical memory cell consists of two electrical devices: a storage capacitor and an access field effect transistor. Each memory cell is an addressable location that can store one binary digit ("bit") of data. A bit can be written to a memory cell through the transistor and read by sensing charge on the reference electrode of the storage capacitor. By decreasing the sizes of these constituent electrical devices and the conducting lines that interconnect them, the sizes of the memory devices incorporating memory cells can likewise be decreased. In similar fashion, the storage capacities of these devices can be increased by fitting more memory cells into the memory devices.

As another example, flash memory (for example, electrically erasable programmable read only memory or "EEPROM") is a type of memory that is typically erased and reprogrammed in blocks instead of one byte at a time. A typical flash memory comprises a memory array, which includes a large number of memory cells. The memory cells include a floating gate field effect transistor capable of holding a charge. The data in a memory cell is determined by the presence or absence of charge on the floating gate. The cells are usually grouped into sections called "erase blocks." The memory cells of a flash memory array are typically arranged into a "NOR" architecture (in which each memory cell is directly coupled to a bit line) or a "NAND" architecture (in which memory cells are coupled into "strings" of cells, such that each cell is coupled indirectly to a bit line and requires activating the other cells of the string for access). The memory cells within an erase block can be electrically programmed on a random basis by charging the floating gate. The charge can be removed from the floating gate by a block erase operation, wherein all floating gate memory cells in the erase block are erased in a single operation.

As is evident from the examples provided here, memory devices typically include large patterns or arrays of electrical devices and conductors that are used to interconnect the electrical devices. The "pitch" of such a pattern is defined as the distance between an identical point in two neighboring features in the pattern. These features are typically defined by openings in, and are spaced apart from each other by, a material such as an insulator or conductor. Thus, pitch can be understood as the sum of the width of a feature and the width of the space separating that feature from a neighboring feature.

### BRIEF SUMMARY OF THE INVENTION

In one embodiment of the present invention, a method for fabricating a semiconductor device comprises patterning a layer of photoresist material to form a plurality of mandrels in a device array region. The method further comprises depositing an oxide material over the plurality of mandrels and over a device peripheral region. The method further comprises anisotropically etching the oxide material from exposed horizontal surfaces in the device array region. The method further comprises forming a pattern of photoresist material over the oxide material in the device peripheral region. The method further comprises selectively etching photoresist material from the device array region and from the device peripheral region.

In another embodiment of the present invention, a method of forming a memory device comprises forming a plurality of mandrels over a substrate in an array region of the memory device. The mandrels optionally comprise a photoresist material. The mandrels are separated by exposed portions the substrate. The method further comprises depositing a spacer material over the mandrels, over the exposed portions of the substrate, and over a peripheral region of the memory device. The method further comprises depositing a peripheral mask over the spacer material in the peripheral region of the memory device. The method further comprises anisotropically etching the spacer material from exposed horizontal surfaces. Spacer material is left remaining (a) on vertical sidewalls of the mandrels in the array region, and (b) between the substrate and the peripheral mask in the peripheral region.

In another embodiment of the present invention, a method of forming an integrated circuit comprises forming a plurality of mandrels on a hard mask layer in an array region. The mandrels comprise a photoresist material. The method further comprises depositing an oxide material over the array region and over a peripheral region that surrounds the array region. The oxide material covers the plurality of mandrels. The method further comprises forming a pattern of photoresist material over the oxide material in the peripheral region. The method further comprises anisotropically etching the oxide material from horizontal surfaces in the array region. The method further comprises removing exposed photoresist material from the array region and the peripheral region after anisotropically etching the oxide material.

In another embodiment of the present invention, a method of integrated circuit fabrication comprises using a lithographic technique to define a plurality of elongate mandrels over a hard mask layer in an integrated circuit array region. The mandrels comprise a photoresist material. The method further comprises forming a pattern of spacers around the plurality of elongate mandrels. The pattern of spacers have a pitch that is smaller than a minimum resolvable pitch of the lithographic technique. The spacers are formed from an oxide material that is deposited at a temperature less than about 100° C.

In another embodiment of the present invention, a partially formed integrated circuit comprises a substrate. The partially formed integrated circuit further comprises a hard mask layer positioned over the substrate. The partially formed integrated circuit further comprises a plurality of spacer loops that are formed directly over the hard mask layer, and that are at least partially positioned in an array region of the partially formed integrated circuit. The partially formed integrated circuit further comprises a mask at least partially defined in a peripheral region of the partially formed integrated circuit, wherein the mask is also directly formed over the hard mask layer.

#### BRIEF DESCRIPTION OF THE DRAWINGS

Exemplary embodiments of the integrated circuits and integrated circuit fabrication techniques disclosed herein are illustrated in the accompanying drawings, which are for illustrative purposes only, and which are not necessarily drawn to scale. The drawings comprise the following figures, in which like numerals indicate like parts.

FIG. 1A is a schematic cross-sectional view of a substrate having a plurality of mask lines formed thereon.

FIG. 1B is a schematic cross-sectional view of the substrate of FIG. 1A after performing an anisotropic etch process that transfers the mask pattern into a temporary layer.

FIG. 1C is a schematic cross-sectional view of the substrate of FIG. 1B after removing the mask lines and performing an isotropic “shrink” etch.

FIG. 1D is a schematic cross-sectional view of the substrate of FIG. 1C after blanket depositing a spacer material over mandrels left in the temporary layer.

FIG. 1E is a schematic cross-sectional view of the substrate of FIG. 1D after performing a directional spacer etch to leave pitch-multiplied features or spacers.

FIG. 1F is a schematic cross-sectional view of the substrate of FIG. 1E after removing the mandrels.

FIG. 2A is a schematic cross-sectional view of an example partially formed integrated circuit.

FIG. 2B is a schematic top view of the partially formed integrated circuit of FIG. 2A.

FIG. 3A is a schematic cross-sectional view of the example partially formed integrated circuit of FIG. 2A after forming lines in an array region in a photoresist layer.

FIG. 3B is a schematic top view of the partially formed integrated circuit of FIG. 3A.

FIG. 4A is a schematic cross-sectional view of the example partially formed integrated circuit of FIG. 3A after performing a trim etch.

FIG. 4B is a schematic top view of the partially formed integrated circuit of FIG. 4A.

FIG. 5A is a schematic cross-sectional view of the example partially formed integrated circuit of FIG. 4A after blanket depositing a low temperature spacer material over photoresist mandrels.

FIG. 5B is a schematic top view of the partially formed integrated circuit of FIG. 5A.

FIG. 6A is a schematic cross-sectional view of the example partially formed integrated circuit of FIG. 5A after defining features in the peripheral region.

FIG. 6B is a schematic top view of the partially formed integrated circuit of FIG. 6A, wherein a periphery photoresist layer is blanket deposited over substantially the entire peripheral region.

FIG. 6C is a schematic top view of the partially formed integrated circuit of FIG. 6A, wherein a periphery photoresist layer is patterned to define periphery features.

FIG. 6D is a schematic top view of the partially formed integrated circuit of FIG. 6A, wherein a periphery photoresist layer partially overlaps the low temperature spacer material.

FIG. 7A is a schematic cross-sectional view of the example partially formed integrated circuit of FIG. 6A after performing an anisotropic etch of the low temperature spacer material.

FIG. 7B is a schematic top view of the partially formed integrated circuit of FIG. 7A.

FIG. 8A is a schematic cross-sectional view of the example partially formed integrated circuit of FIG. 7A after removing exposed photoresist material.

FIG. 8B is a schematic top view of the partially formed integrated circuit of FIG. 8A.

FIG. 9A is a schematic cross-sectional view of the example partially formed integrated circuit of FIG. 8A after transferring the pattern of spacers into underlying hard mask layers.

FIG. 9B is a schematic top view of the partially formed integrated circuit of FIG. 9A.

#### DETAILED DESCRIPTION OF THE INVENTION

As the size of the electrical devices and the conductors that comprise a memory device are made smaller and smaller, ever greater demands are placed on the techniques used to form these features. For example, photolithography is commonly used to pattern device features, such as conductive lines, on a substrate. The concept of pitch can be used to describe the size of these features. Due to optical factors such as light or radiation wavelength, however, photolithography techniques have a minimum pitch below which features cannot be formed reliably. Thus, the minimum pitch of a photolithographic technique can limit feature size reduction.

One technique proposed for extending the capabilities of photolithographic techniques beyond their minimum pitch is the “pitch doubling” technique. This technique is illustrated in FIGS. 1A-1F, and is described in U.S. Pat. No. 5,328,810 (issued 12 Jul. 1994), the entire disclosure of which is incorporated herein by reference. With reference to FIG. 1A, photolithography is first used to form a pattern of lines **10** in a photoresist layer overlying a layer of a temporary or expendable material **20** and a substrate **30**. Common wavelengths which are used in performing the photolithography include, but are not limited to, 157 nm, 193 nm, 248 nm or 365 nm. Before performing subsequent processing steps, the lines **10** are optionally shrunk using an isotropic etch. As shown in FIG. 1B, the pattern is then transferred by an etch step, such as an anisotropic etch step, to the layer of expendable material **20**, thereby forming placeholders or mandrels **40**. The photoresist lines **10** can be stripped and the mandrels **40** can be isotropically etched to increase the distance between neighboring mandrels **40**, as shown in FIG. 1C. A layer of spacer material **50** is subsequently deposited over the mandrels **40**, as shown in FIG. 1D. Spacers **60** are then formed on the sides of the mandrels **40** by preferentially etching the spacer material from the horizontal surfaces in a directional spacer etch, as shown in FIG. 1E. The remaining mandrels **40** are then removed, leaving behind only the spacers **60**, which together act as a mask for patterning, as shown in FIG. 1F. Thus, where a given pattern area formerly defined one feature and one space (each having a width  $F$ , for a pitch of  $2F$ ), the same pattern area now includes two features and two spaces, as defined by spacers **60** (each having a width  $\frac{1}{2}F$ , for a pitch of  $F$ ). Consequently, the smallest feature size possible with a photolithographic technique is effectively decreased by using the pitch doubling technique.

While pitch is actually reduced using these techniques, this reduction in pitch is conventionally referred to as “pitch doubling”, or more generally, “pitch multiplication”. This is because these techniques allow the number of features in a given region of the substrate to be doubled, or more generally, multiplied. Thus, using the conventional terminology, “multiplication” of pitch by a certain factor actually involves reducing the pitch by that factor. The conventional terminology is retained herein. By forming multiple layers of spacers upon each other, the definable feature size can be made even smaller. Thus, the terms “pitch multiplication” and “pitch doubling” refer to the process generally, regardless of the number of times the spacer formation process is employed.

Some proposed methods for forming patterns in the periphery and in the array of a memory device involve use of two separate carbon layers. For example, in one such method, the mandrels used to define spacer loops are formed in an upper carbon layer. After pitch doubling and periphery patterning processes are performed, the array pattern is transferred to a lower carbon layer. While this process does allow features of different sizes to be formed in the array and periphery regions, use of a low temperature oxide material to define the spacer loops allows mandrels to be formed from the existing photoresist layer. This advantageously allows the top carbon layer to be omitted, thereby simplifying production.

In accordance with the foregoing, simplified and improved techniques have been developed for forming arrays of features in different regions of a memory device.

In certain embodiments, the feature pattern to be transferred to a substrate has a pitch below the minimum pitch of the photolithographic technique used for processing the substrate. Additionally, certain embodiments can be used to form arrays of features, including logic or gate arrays and volatile and non-volatile memory devices such as DRAM, phase change memory (“PCM”), programmable conductor random access memory (“PCRAM”), read only memory (“ROM”), flash memory. In such devices, pitch multiplication is usable to form, for example, transistor gate electrodes and conductive lines in the array region of the devices. Optionally, conventional photolithography is usable to form larger features, such as local interconnects and complementary metal oxide semiconductor (“CMOS”) circuits, in the peripheral region of the devices. For example, the logic array can be a field programmable gate array (“FPGA”) having a core array similar to a memory array and a periphery with supporting logic circuits. Exemplary masking steps in the course of fabricating a memory device are illustrated in the figures and are described herein.

FIGS. 2A and 2B illustrate schematic cross-sectional and top views, respectively, of an example partially fabricated integrated circuit 100, such as a memory device. FIG. 2B illustrates that the integrated circuit 100 comprises a central array region 102 that is surrounded by a peripheral region 104. It will be appreciated that, after the integrated circuit 100 is fabricated, the array region 102 will typically be densely populated with conducting lines and electrical devices such as transistors and capacitors. Pitch multiplication can be used to form features in the array region 102, as discussed herein.

On the other hand, the peripheral region 104 optionally includes features larger than those in the array region 102. Conventional photolithography, rather than pitch multiplication, is typically used to pattern these larger features, examples of which include various types of logic circuitry. The geometric complexity of the logic circuits located in the peripheral region 104 makes using pitch multiplication difficult in this region of the integrated circuit 100. In contrast, the regular grid typical of array patterns is conducive to pitch

multiplication. Additionally, some devices in the peripheral region 104 may require larger geometries due to electrical constraints, thereby making pitch multiplication less advantageous than conventional photolithography for such devices.

In addition to possible differences in relative scale, the relative positions, and the number of peripheral regions 104 and array regions 102 in the integrated circuit 100 can vary in other embodiments. In embodiments wherein different processing techniques are separately used to form features in the array region 102 and the peripheral region 104, the peripheral region 104 can be masked during processing of the array region.

FIG. 2A illustrates that the partially formed integrated circuit 100 includes a substrate 106 having a first hard mask layer 108 formed thereover. In an example embodiment, the first hard mask layer 108 comprises a material such as silicon nitride, silicon oxide, or an organic material, such as an amorphous carbon material, a polymer material, or a spin on dielectric material. In a preferred embodiment, the first hard mask layer 108 comprises a form of amorphous carbon that is highly transparent to light and that offers further improvements for photo alignment by being transparent to the wavelengths of light used for such alignment. In other modified embodiments, the first hard mask layer 108 is omitted.

An optional second hard mask layer 110 is formed over the first hard mask layer 108. The second hard mask layer 110 preferably comprises an inorganic material. Example materials for the second hard mask layer 110 include silicon nitride, polycrystalline silicon, or a dielectric antireflective coating (“DARC”), such as silicon-rich silicon oxynitride. Preferably, the material comprising the second hard mask layer 110 can be selectively etched with respect to subsequently-deposited spacer materials. Use of a DARC for the second hard mask layer 110 can be particularly advantageous for forming patterns having pitches near the resolution limits of a photolithographic technique. In particular, a DARC can enhance resolution by reducing light reflections, thus increasing the precision with which photolithography can define the edges of a pattern. The second hard mask layer 110 is omitted in embodiments wherein the first hard mask layer 108 can be etched selectively with respect to subsequently deposited spacer materials. In still other embodiments, the second hard mask layer 110 is replaced with an organic spin on antireflective coating (“ARC”) positioned between the first hard mask layer 108 and the subsequently described overlying array photoresist layer.

An array photoresist layer 111, also referred to herein as a mandrel layer, is formed over the second hard mask layer 110. The array photoresist layer 111 preferably comprises a photoresist material that is compatible with 157 nm, 193 nm, 248 nm or 365 nm wavelength systems, 193 nm wavelength immersion systems, extreme ultraviolet systems such as 13.7 nm wavelength systems, or electron beam lithographic systems. Examples of preferred photoresist materials include argon fluoride sensitive photoresist (that is, photoresist suitable for use with an argon fluoride light source) and krypton fluoride sensitive photoresist (that is, photoresist suitable for use with a krypton fluoride light source). Argon fluoride photoresists are preferably used with shorter wavelength photolithography systems, such as 193 nm wavelength systems. Krypton fluoride photoresists are preferably used with longer wavelength photolithography systems, such as 248 nm wavelength systems. In a modified embodiment, the array photoresist layer 111 comprises a photoresist material that can be patterned by nano-imprint lithography, such as by using a mold or a mechanical force to pattern the photoresist material.

In general, the materials for the first hard mask layer **108**, the second hard mask layer **110**, and the array photoresist layer **111** are chosen based on the chemistry and the process conditions for the various pattern forming and transfer steps disclosed herein. For instance, in an example embodiment, the first hard mask layer **108**, the second hard mask layer **110**, and the array photoresist layer **111** can each be selectively etched with respect to each other. As used herein, a material is considered “selectively etched” (or “preferentially etched”) when the etch rate for that material is at least about 2 times greater, preferably at least about 10 times greater, more preferably at least about 20 times greater, and most preferably at least about 40 times greater than that for a neighboring material. In modified embodiments other layers are added if suitable other materials, chemistries and/or processes conditions are used.

The first hard mask layer **108**, the second hard mask layer **110**, and the array photoresist layer **111** can be formed using deposition processes such as spin-on coating, sputtering, chemical vapor deposition (“CVD”), or atomic layer deposition. For example, a low temperature CVD process (preferably less than about 550° C., more preferably less than about 450° C., and most preferably less than about 400° C.) advantageously reduces chemical and/or physical disruption of an amorphous carbon layer, and thus is useful for deposition of materials over an existing amorphous carbon layer, such as the first hard mask layer **108**. Additional information regarding the formation of amorphous carbon layers, including doped amorphous carbon layers, is provided in U.S. Pat. No. 6,573,030 (issued 3 Jun. 2003) and U.S. Patent Application Publication 2005/0042879 (published 24 Feb. 2005). The entire disclosure of this patent and patent application publication is hereby incorporated by reference herein.

The thicknesses of the first hard mask layer **108**, the second hard mask layer **110**, and the array photoresist layer **111** are also chosen depending upon compatibility with the etch chemistries and process conditions disclosed herein. For example, when etching a material through a mask of another material, such as when transferring a pattern from an overlying layer to an underlying layer by selectively etching the underlying layer, materials from both layers are removed to some degree. Thus, the upper layer is preferably sufficiently thick such that it is not completely worn away over the course of the pattern transfer. In an example embodiment, the second hard mask layer **110** is preferably between about 10 nm and about 40 nm thick, and is more preferably between about 15 nm and about 30 nm thick.

The thickness of the array photoresist layer **111** depends on the wavelength of light used to pattern the array photoresist layer **111**. In an example embodiment wherein 248 nm light is used to perform photolithography, the array photoresist layer **111** is preferably between about 50 nm and about 300 nm thick, and is more preferably between about 200 nm and 250 nm thick. This height can vary depending upon the wavelength of light used to pattern the photoresist layer. Because lines are subsequently formed in the array photoresist layer **111**, in certain embodiments the height of the array photoresist layer **111** is limited by the structural integrity and the aspect ratio of the lines to be formed, since tall spacer lines may collapse or otherwise deform.

As illustrated in FIGS. 3A and 3B, a pattern is defined in the array photoresist layer **111** that comprises trenches **122** delimited by lines **124**. The trenches **122** can be formed by, for example, photolithography with 248 nm or 193 nm light, in which the array photoresist layer **111** is exposed to radiation through a reticle and then developed. After being developed, the remaining photodefinable material, which is pho-

toresist in the illustrated embodiment, forms mask features such as the illustrated lines **124**. In other embodiments, maskless lithography, or maskless photolithography can also be used to define the lines **124**.

The pitch of the resulting lines **124** is equal to the sum of the width of a line **124** and the width of a neighboring trench **122**. To reduce the dimensions of features formed using this pattern of lines **124** and trenches **122**, the pitch can be at or near the limits of the photolithographic technique used to pattern the array photoresist layer **111**. For example, for photolithography using 248 nm light, the pitch of the lines **124** is preferably between about 80 nm and about 150 nm, and is more preferably between about 90 nm and about 120 nm. Thus, in an example embodiment the pitch is the minimum pitch of the photolithographic technique and the subsequently-formed pitch multiplied spacer pattern advantageously has a pitch below the minimum pitch of the photolithographic technique. In alternative embodiments, because the margin of error for position and feature size typically increases as the limits of a photolithographic technique are approached, the lines **124** are formed having larger feature sizes, such as 200 nm, to reduce errors in the positions and sizes of the lines **124**.

As illustrated in FIGS. 4A and 4B, the trenches **122** are preferably widened by etching the lines **124**, to form modified trenches **122'** and modified lines **124'**. The lines **124** are preferably etched using an isotropic etch to “shrink” these features. Suitable etches include etches using an oxygen-containing plasma, such as a SO<sub>2</sub>/O<sub>2</sub>/N<sub>2</sub>/Ar plasma, a Cl<sub>2</sub>/O<sub>2</sub>/He plasma, or a HBr/O<sub>2</sub>/N<sub>2</sub> plasma. The extent of the etch is preferably selected so that the width of the modified lines **124'** is substantially equal to the desired spacing between subsequently-formed pitch doubled features. For example, in an example embodiment the width of the lines **124** is reduced from between about 80 nm and about 120 nm to between about 35 nm and about 70 nm, and more preferably to between about 40 nm and about 50 nm. Advantageously, the width-reducing etch allows the modified lines **124'** to be narrower than would otherwise be possible using the photolithographic technique used to form the lines **124**. Additionally, the etch can provide the modified lines **124'** with smoothed edges, thus improving the uniformity of the modified lines **124'**. While the critical dimensions of the modified lines **124'** can be etched below the resolution limits of the photolithographic technique, this etch does not alter the pitch of the modified trenches **122'** and the modified lines **124'**, since the distance between identical points in these features remains the same.

As illustrated in FIGS. 5A and 5B, a blanket layer of low temperature spacer material **126** is deposited over the modified lines **124'**. In an example embodiment, the low temperature spacer material **126** comprises a layer of oxide material deposited using an atomic layer deposition (“ALD”) technique. Generally, photoresist materials are not as tolerant of high temperatures as inorganic or carbon materials. Therefore, forming the spacers from a low temperature oxide material advantageously allows a separate mandrel layer deposition, pattern and transfer to be eliminated, with the patterned array photoresist layer **111** serving the same function. The low temperature spacer material is preferably deposited at less than about 200° C., more preferably at less than about 150° C., more preferably less than about 125° C., more preferably less than about 100° C., more preferably less than about 80° C., more preferably less than about 75° C., and most preferably at less than about 30° C.

In an example embodiment, the low temperature spacer material **126** is deposited in an ALD process using Si<sub>2</sub>Cl<sub>6</sub>, H<sub>2</sub>O and C<sub>5</sub>H<sub>5</sub>N precursors. In such embodiments the spacer

material **126** is deposited to a thickness that is preferably between about 20 nm and about 65 nm, more preferably between about 25 nm and about 60 nm, and most preferably between about 30 nm and about 55 nm. In one embodiment, the spacer material thickness is between about 30 nm and about 40 nm, and in another embodiment, the spacer material thickness is between about 43 nm and about 55 nm. The spacer material deposition rate is preferably between about 1 Å per cycle and about 4 Å per cycle, and more preferably about 2 Å per cycle.

As illustrated in FIGS. 6A through 6D, a periphery photoresist layer **128** is deposited in the peripheral region **104**, while at least a portion of the array region **102** is left open. In a preferred embodiment, illustrated in FIG. 6B, the periphery photoresist layer **128** is blanket deposited over substantially the entire peripheral region **104**. In an alternative embodiment, illustrated in FIG. 6C, the periphery photoresist layer **128** is patterned to define periphery features. Example periphery features include landing pads, transistors, local interconnects, and the like. In another alternative embodiment, illustrated in FIG. 6D, the periphery photoresist layer **128** is deposited over the looped ends of the low temperature spacer material **126** and the tips **124'** of the modified lines **124'**, thereby blocking the tips **124'** of the modified lines **124'**. The embodiment illustrated in FIG. 6D is particularly advantageous for forming damascene structures because this configuration prevents the looped ends over the low temperature spacer material **126** from being operational during subsequent etching processes.

In modified embodiments, the periphery photoresist layer **128** is deposited in the same deposition step in which the array photoresist layer **111** is deposited. In such embodiments, the mask used to pattern the array photoresist layer **111** is configured so as to leave a photoresist pattern or blanket layer in the peripheral region **104**. This process results in photoresist being deposited directly on the second hard mask layer **110** in the peripheral region **104**, without the intervening spacer material **126**.

As illustrated in FIGS. 7A and 7B, the low temperature spacer material **126** is then subjected to an anisotropic etch to remove spacer material from horizontal surfaces of the partially formed integrated circuit **100**. Such an etch, also known as a spacer etch, can be performed using, for example a HBr/Cl<sub>2</sub>-containing plasma. Thus, pitch multiplication has been accomplished to form spacers **130**. In the illustrated embodiment, the pitch of the spacers **130** is roughly half that of the photoresist lines **124** and trenches **122** (see FIGS. 3A and 3B) originally formed by photolithography. Where the photoresist lines **124** had a pitch of about 200 nm, spacers **130** having a pitch of about 100 nm or less (for a width of about 50 nm) can be formed. Because the spacers **130** are formed on the sidewalls of the modified lines **124'**, the spacers **130** generally follow the outline of the pattern of modified lines **124'** in the array photoresist layer **111**, and thus typically form a closed loop as illustrated in FIG. 7B.

As illustrated in FIGS. 8A and 8B, the remaining exposed photoresist material is selectively etched from the partially formed integrated circuit **100**. This includes the array photoresist layer **111**, as well as the periphery photoresist material **128**. This results in the formation of freestanding spacers **130** separated by modified trenches **122'**. The periphery features are now defined by the remaining low temperature spacer material **126** in the peripheral region **104**. Thus, the array photoresist layer **111** is used as a mandrel to form the spacers **130**. The photoresist material is selectively removed using an organic strip process. Preferred etch chemistries include an oxygen-containing plasma etch, such as an etch using SO<sub>2</sub>. In

embodiments wherein the peripheral photoresist layer **128** is deposited directly on the second hard mask layer **110**, the photoresist material is selectively etched from only the array region **102** of the integrated circuit **100**. Alternatively, in such embodiments the photoresist material is etched from both the array region **102** and the peripheral region **104**, followed by a subsequent deposition of photoresist material in the peripheral region **104**.

After the freestanding spacers **130** are formed, subsequent processing steps can be conducted, such as a dry develop step and an in situ etch step. The subsequent processing steps can be used to transfer the pattern of spacers **130** and periphery features to the underlying first hard mask layer **108** and/or the second hard mask layer **110**, as illustrated in FIGS. 9A and 9B. Specifically, FIGS. 9A and 9B illustrate the pattern of spacers **130** defined in the first hard mask layer **108** and the second hard mask layer **110**. The second hard mask layer **110** is optionally etched from the structure illustrated in FIGS. 9A and 9B. This pattern can then be transferred into the underlying substrate **106** by etching of the underlying substrate **106**. The structure can also be otherwise processed (such as by doping, oxidizing, nitridizing, or selectively depositing) through the pattern defined in the first hard mask layer **108** and/or the second hard mask layer **110**. As noted herein, the substrate **106** can include previously deposited layers, such as insulating layers for damascene metallization, or metal layers for conventional metallization.

Certain of the techniques disclosed herein advantageously enable the formation of a pitch doubled pattern of spacers to be formed in the array region without the use of additional layers to define the array features, such as a top carbon layer and an amorphous silicon layer. Specifically, by forming low temperature oxide spacers directly on the array photoresist layer **111** as disclosed herein, the photoresist material itself can be used to define mandrels which are used in a subsequent pitch multiplication technique. This advantageously eliminates the need to pattern additional masking layers to define mandrels. Such techniques advantageously allow process steps associated with such additional masking layers to be eliminated, such as additional dry develop steps and hard mask etch steps. Furthermore, such techniques also advantageously allow the periphery photoresist layer **128** to be defined using the same low temperature spacer material that is used to form the spacers in the array region. Certain of the embodiments disclosed herein also advantageously allow a hard mask material—as compared to a more vulnerable photoresist material—to be used to block and define features in the peripheral region **104** without requiring the use of a separate hard mask layer.

#### SCOPE OF THE INVENTION

While the foregoing detailed description discloses several embodiments of the present invention, it should be understood that this disclosure is illustrative only and is not limiting of the present invention. It should be appreciated that the specific configurations and operations disclosed can differ from those described above, and that the methods described herein can be used in contexts other than integrated circuit fabrication.

We claim:

1. A method for fabricating a semiconductor device, the method comprising:
  - 65 patterning a layer of photoresist material to form a plurality of mandrels formed of photoresist in a device array region;



## 11

- depositing an oxide material on the plurality of mandrels and over a device peripheral region at a deposition temperature of about 200° C. or less;
- forming a pattern of photoresist material over the oxide material in the device peripheral region;
- anisotropically etching the oxide material from exposed horizontal surfaces in the device array region, thereby forming spacers from the oxide material, wherein the pattern of the photoresist material extends over the ends of the spacers;
- transferring a pattern defined by the spacers to an underlying material, wherein the pattern of the photoresist material blocks transfer of the ends of the spacers to the underlying material; and
- selectively etching photoresist material from the device array region and from the device peripheral region.
2. The method of claim 1, further comprising isotropically etching the plurality of mandrels to form a plurality of modified mandrels before depositing the oxide material.
3. The method of claim 2, wherein isotropically etching the plurality of mandrels comprises using an oxygen-containing plasma selected from the group consisting of a SO<sub>2</sub>/O<sub>2</sub>/N<sub>2</sub>/Ar plasma, a Cl<sub>2</sub>/O<sub>2</sub>/He plasma, and a HBr/O<sub>2</sub>/N<sub>2</sub> plasma.
4. The method of claim 1, further comprising anisotropically etching the oxide material from exposed horizontal surfaces in the device peripheral region.
5. The method of claim 1, wherein patterning the layer of photoresist comprises using light having a wavelength selected from the group consisting of 157 nm, 193 nm, 248 nm, and 365 nm.
6. The method of claim 1, wherein patterning the layer of photoresist comprises using nano-imprint lithography.

## 12

7. The method of claim 1, wherein the layer of photoresist material patterned in the device array region and the pattern of photoresist material formed in the device peripheral region comprise the same material.
8. The method of claim 1, wherein anisotropically etching the oxide material comprises using a HBr/Cl<sub>2</sub>-containing plasma.
9. The method of claim 1, wherein the modified mandrels have a width between about 35 nm and about 70 nm.
10. The method of claim 1, wherein the modified mandrels have a width between about 40 nm and about 50 nm.
11. The method of claim 1, wherein the oxide material is deposited using an atomic layer deposition technique.
12. The method of claim 1, wherein the oxide material is deposited at a temperature less than about 150° C.
13. The method of claim 1, wherein the oxide material is deposited at a temperature less than about 125° C.
14. The method of claim 1, wherein the pattern of photoresist material in the device peripheral region forms a feature selected from the group consisting of a landing pad, a transistor, and an interconnect.
15. The method of claim 1, wherein the layer of photoresist material is patterned over a hard mask layer.
16. The method of claim 1, wherein the layer of photoresist material is patterned over a silicon oxynitride layer that is positioned over a carbon layer.
17. The method of claim 1, wherein the plurality of mandrels have a height between about 50 nm and about 300 nm.
18. The method of claim 1, wherein the mandrels have a width between about 80 nm and about 120 nm.
19. The method of claim 1, wherein the layer of photoresist material comprises a material selected from the group consisting of amorphous carbon, argon fluoride photoresist, and krypton fluoride photoresist.

\* \* \* \* \*