

US007850521B2

(12) **United States Patent**
Rodgers et al.

(10) **Patent No.:** **US 7,850,521 B2**
(45) **Date of Patent:** ***Dec. 14, 2010**

(54) **GAMING DEVICE INCLUDING A GAME HAVING A WILD SYMBOL RELATED AWARD**

4,838,552 A 6/1989 Hagiwara
4,991,848 A 2/1991 Greenwood et al.

(75) Inventors: **Paulina Rodgers**, Reno, NV (US);
Erick T. Ching, Reno, NV (US);
Jansonlee Kisse Hohman, Sparks, NV (US)

(Continued)

FOREIGN PATENT DOCUMENTS

(73) Assignee: **IGT**, Reno, NV (US)

AU B-7152287 1/1987

(*) Notice: Subject to any disclaimer, the term of this patent is extended or adjusted under 35 U.S.C. 154(b) by 327 days.

(Continued)

OTHER PUBLICATIONS

This patent is subject to a terminal disclaimer.

Black Swan Paytable Display written by IGT, published prior to 2001.

(21) Appl. No.: **11/464,347**

(Continued)

(22) Filed: **Aug. 14, 2006**

Primary Examiner—Kim T Nguyen
(74) *Attorney, Agent, or Firm*—K&L Gates LLP

(65) **Prior Publication Data**

(57) **ABSTRACT**

US 2007/0021188 A1 Jan. 25, 2007

Related U.S. Application Data

(63) Continuation of application No. 10/633,391, filed on Jul. 31, 2003, now Pat. No. 7,090,580, which is a continuation-in-part of application No. 10/241,255, filed on Sep. 11, 2002, now Pat. No. 7,056,213.

(51) **Int. Cl.**
A63F 13/00 (2006.01)

(52) **U.S. Cl.** **463/20**

(58) **Field of Classification Search** 463/16–22,
463/25, 252; 273/143 R

See application file for complete search history.

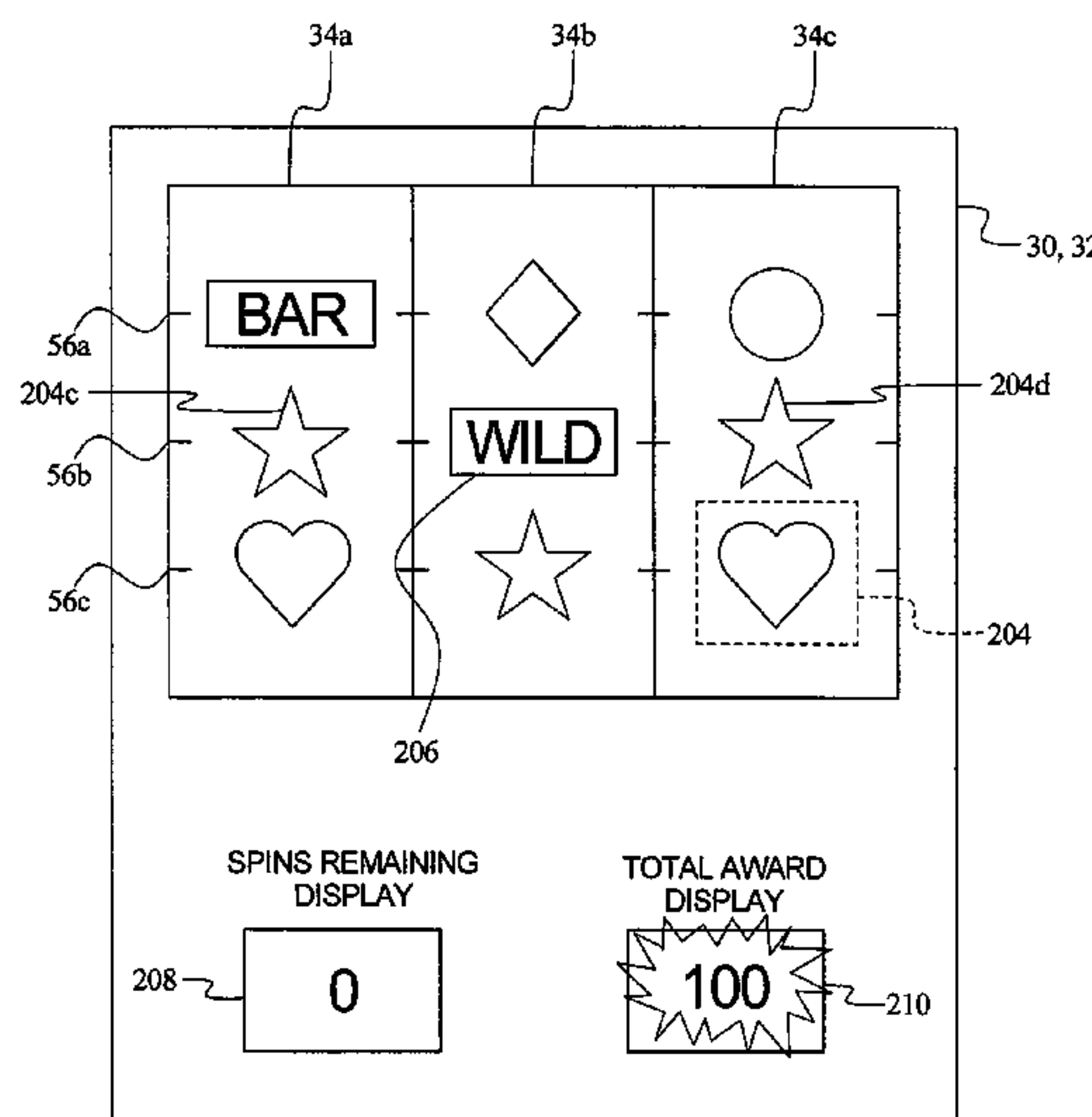
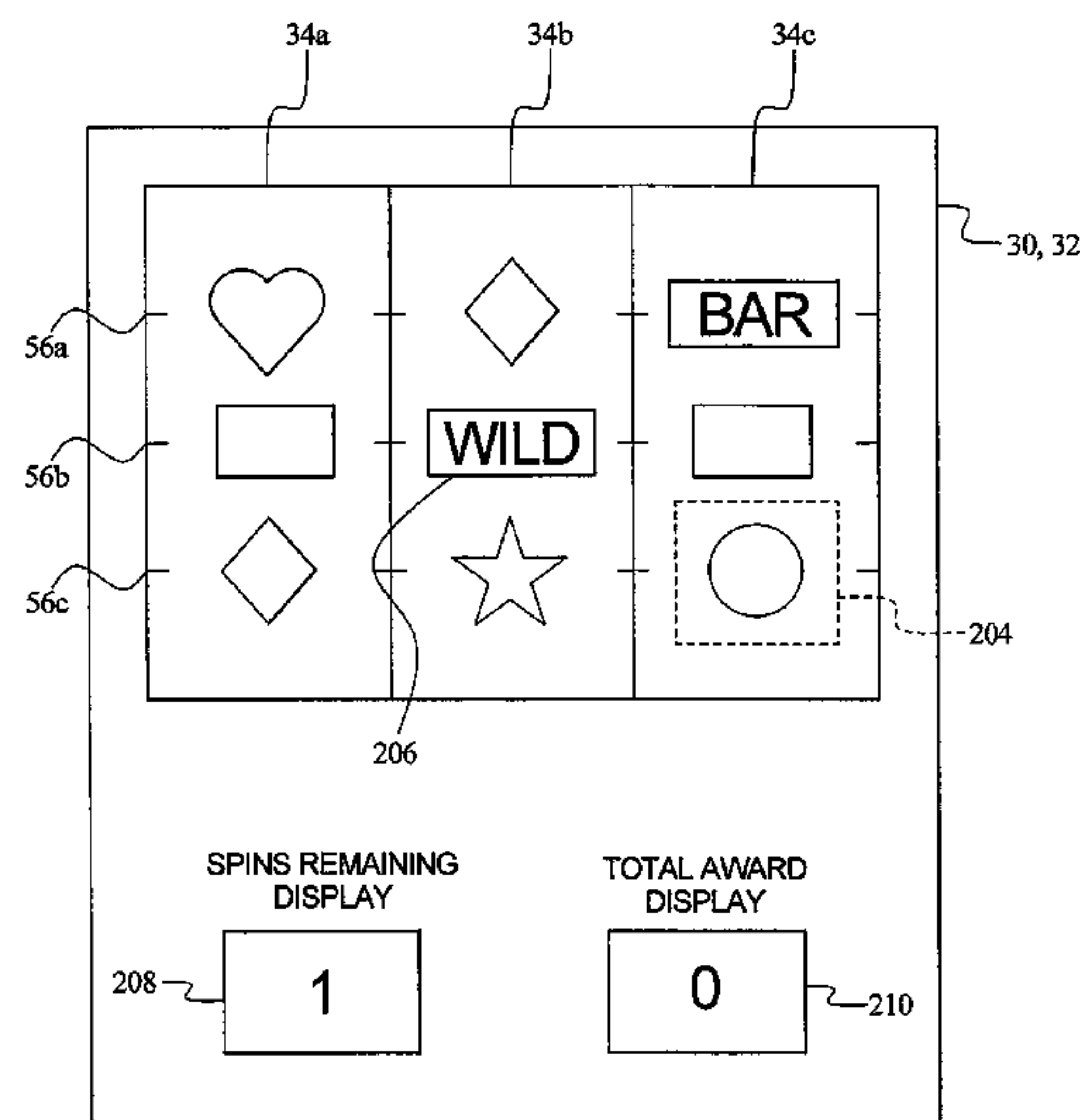
(56) **References Cited**

U.S. PATENT DOCUMENTS

4,198,052 A 4/1980 Gauselmann
4,448,419 A 5/1984 Telnaes

A gaming device including a plurality of reels having several symbols with at least one wild symbol. In one embodiment, the gaming device spins the reels for at one spin. If a wild symbol is indicated on a payline associated with the reels and no winning symbol combinations are indicated on the payline, the gaming device holds the reel including the wild symbol, stationary. The gaming device then re-spins the other reels for a designated number of spins, not including the reel having the wild symbol, in the game. The gaming device provides an award associated with any winning symbol combinations on the payline. In another embodiment, the gaming device holds one of the reels stationary when a wild symbol is indicated on a payline associated with the reels the award amounts associated with any indicated winning symbol combinations on the payline are less than a designated award value.

67 Claims, 31 Drawing Sheets



WO WO 01/26019 A1 4/2001
 WO WO 2004/025584 A2 3/2004

OTHER PUBLICATIONS

Boot Scootin Article written by Strictly Slots/Aristocrat Leisure Industries, PTY Ltd., published date unknown.
 Break the Spell Advertisement written by Atronic Casino Technology, Ltd., published in 1999.
 Break the Spell Article written by Strictly Slots/Atronic Casino Technology, Ltd., published in Sep. 2000.
 Break the Spell Atronic Web Page, published in Jan. 2001.
 Break the Spell Brochure, published in 1999.
 Cash Chameleon Article written by Strictly Slots/Aristocrat Leisure Industries, PTY Ltd., published in Apr. 2001.
 Catch A Wave Advertisement written by IGT, published in Dec. 2000.
 Cossack Dance Advertisement written by Olympic Video Gaming, published prior to 2002.
 Description of Symbol Feature in Australian UFO Gaming Machine written by Barcrest Ltd., published in 1995.
 Dolphin Treasure Advertisement written by Aristocrat Leisure Industries Pty., Ltd., published in 1996.
 Double Diamond Line Advertisement written by Bally Gaming Systems, published in 2000.
 Enchanted Forest™ Gaming Description from Aristocrat, available in 1994.
 Enchanted Unicorn Advertisement written by IGT, published in 2001.
 Family Feud Bullseye advertisement, printed from www.igtonline.com/megajackpots/new_games/family_feud_bullseye_slots.html on Mar. 2, 2005 and available in 2003.
 Field Testing New Slots Article, written by Strictly Slots, published in Jul. 2000.
 Fishin' Buddies Article published in Strictly Slots/Anchor Games, published in Apr. 2001.

Happy Camper Advertisement written by IGT, published in 2001.
 Introducing the "Smiling Ape" Machine Advertisement (including Joker's Wild Poker description) written by IGT, published prior to 2001.
 Jackpot Party Brochure and Articles written by WMS Gaming, Inc, published in 1988.
 Joker's Wild Advertisement written by IGT, published prior to 2001.
 Little Green Men, Jr. Advertisement written by A.C. Coin and Slot Services Company, published prior to 2002.
 Loco Loot Article written by Strictly Slots/Aristocrat Leisure Industries, PTY Ltd., published in May 2002.
 Mountain Money Article written by Strictly Slots/Aristocrat Leisure Industries, PTY Ltd., published in Jun. 2002.
 On the House Advertisement written by Olympic Video Gaming, published prior to 2002.
 Penguin Pays Advertisement written by Aristocrat Incorporated, published in 1998.
 Reel Magic™ Gaming Machine Description written by IGT, available in 1986.
 Spin Til You Win Game Description written by IGT, published in 1996.
 The Basics of Winning Video Poker (Chapter VI Deuces Wild & Chapter VII Jokers Wild) written by J. Edward Allen, published in 1990.
 The Latest Buzz Article written by Bally Gaming Systems, published in Fall 2000.
 Wild Bear Salmon Run Advertisement written by IGT, published in 2003.
 Wild Streak Advertisement written by WMS Gaming, Inc., published in 2001.
 Your Real Key to Gaming Success Advertisement (including Roll Over Beethoven and Wild Fortune) written by Olympic Video Gaming, published dated unknown.

* cited by examiner

FIG. 1A

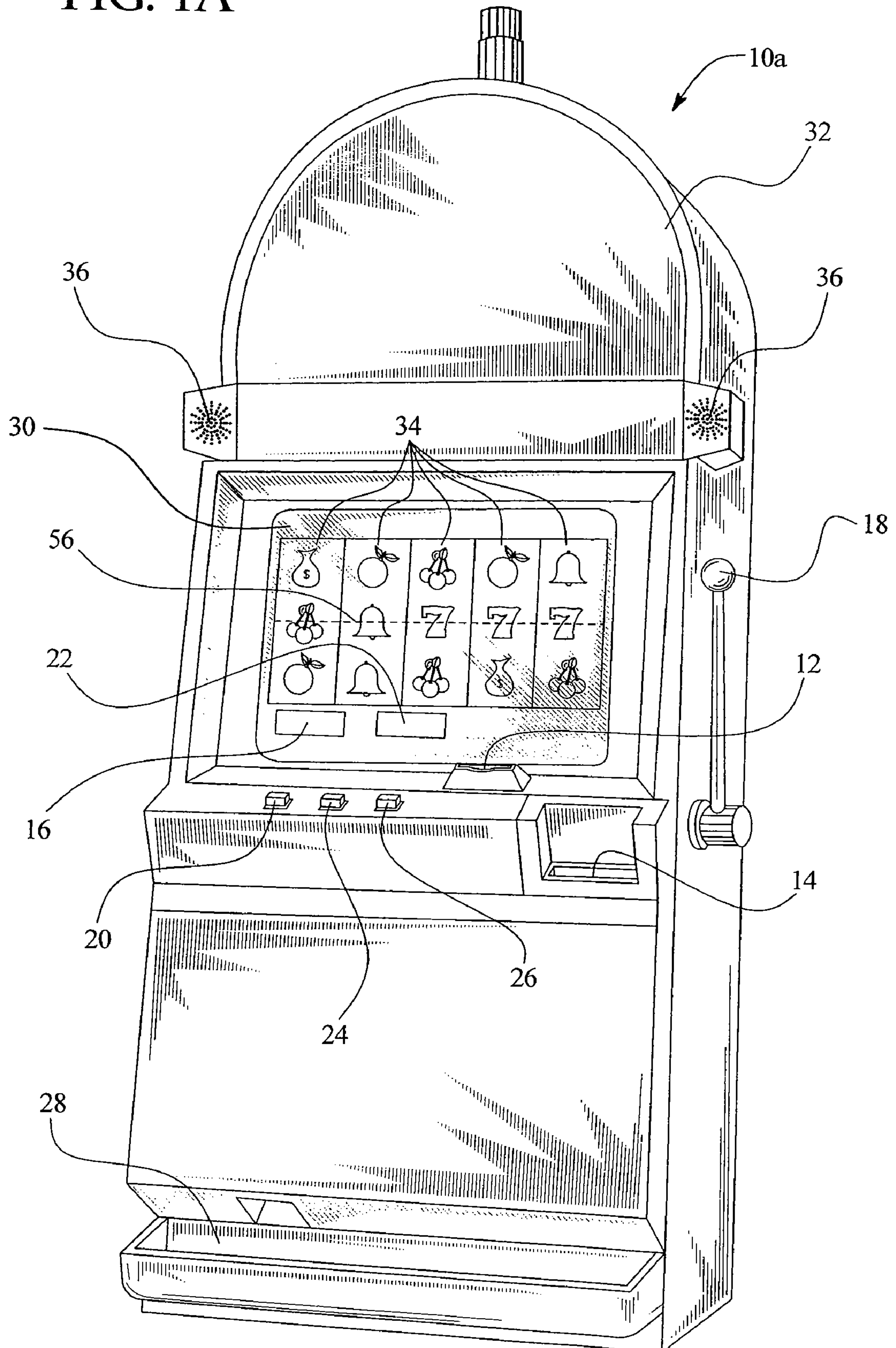


FIG. 1B

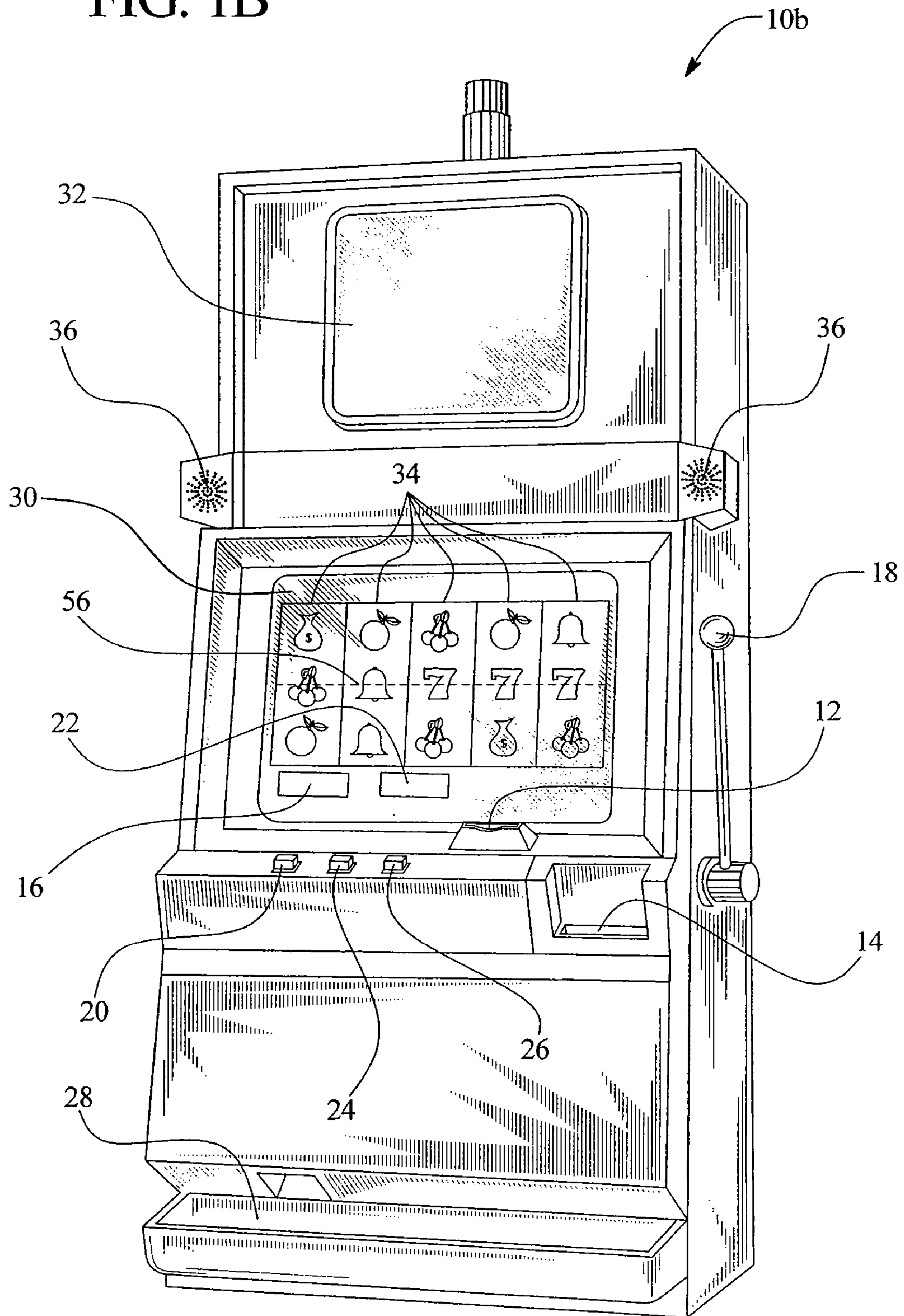


FIG. 1C

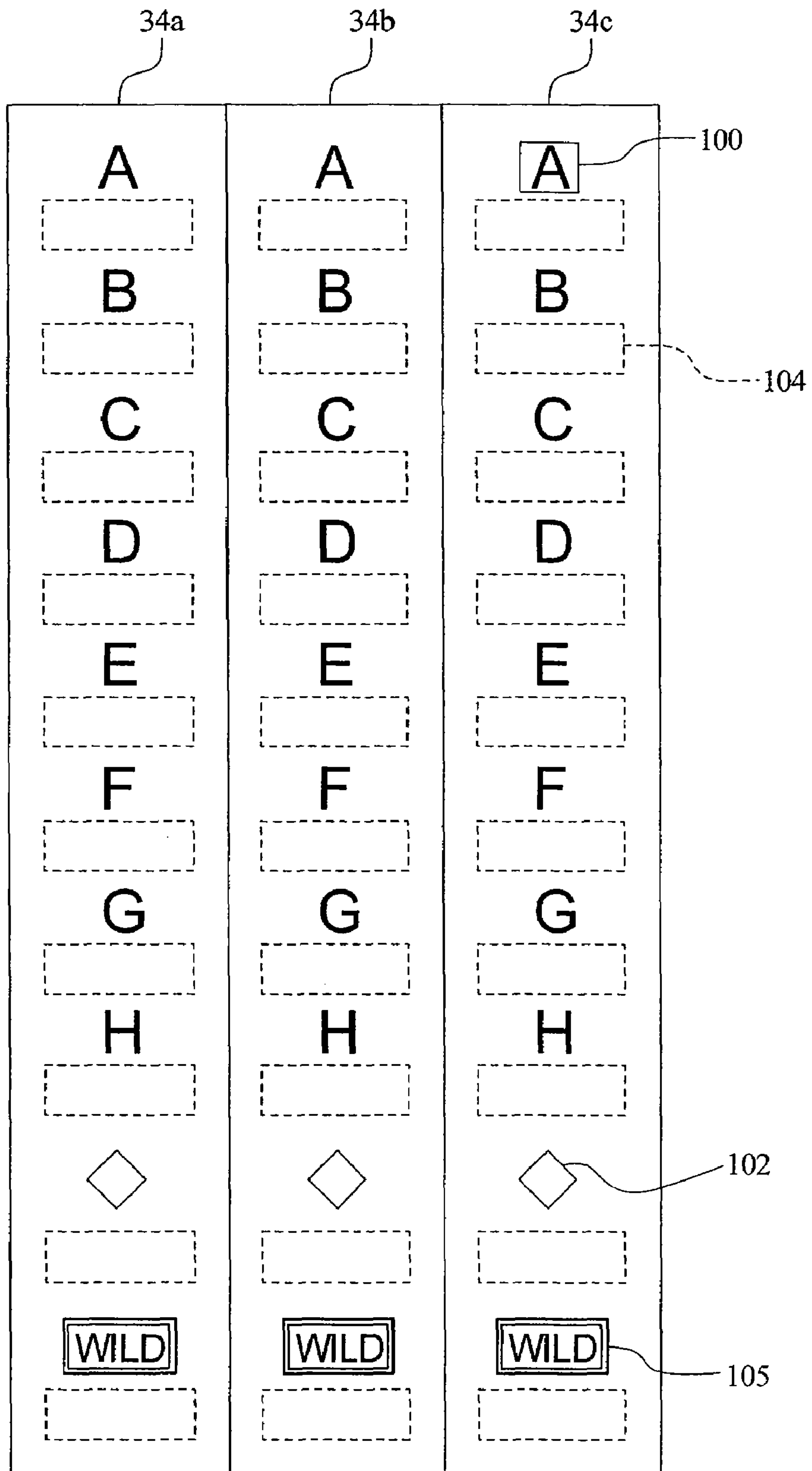


FIG. 2

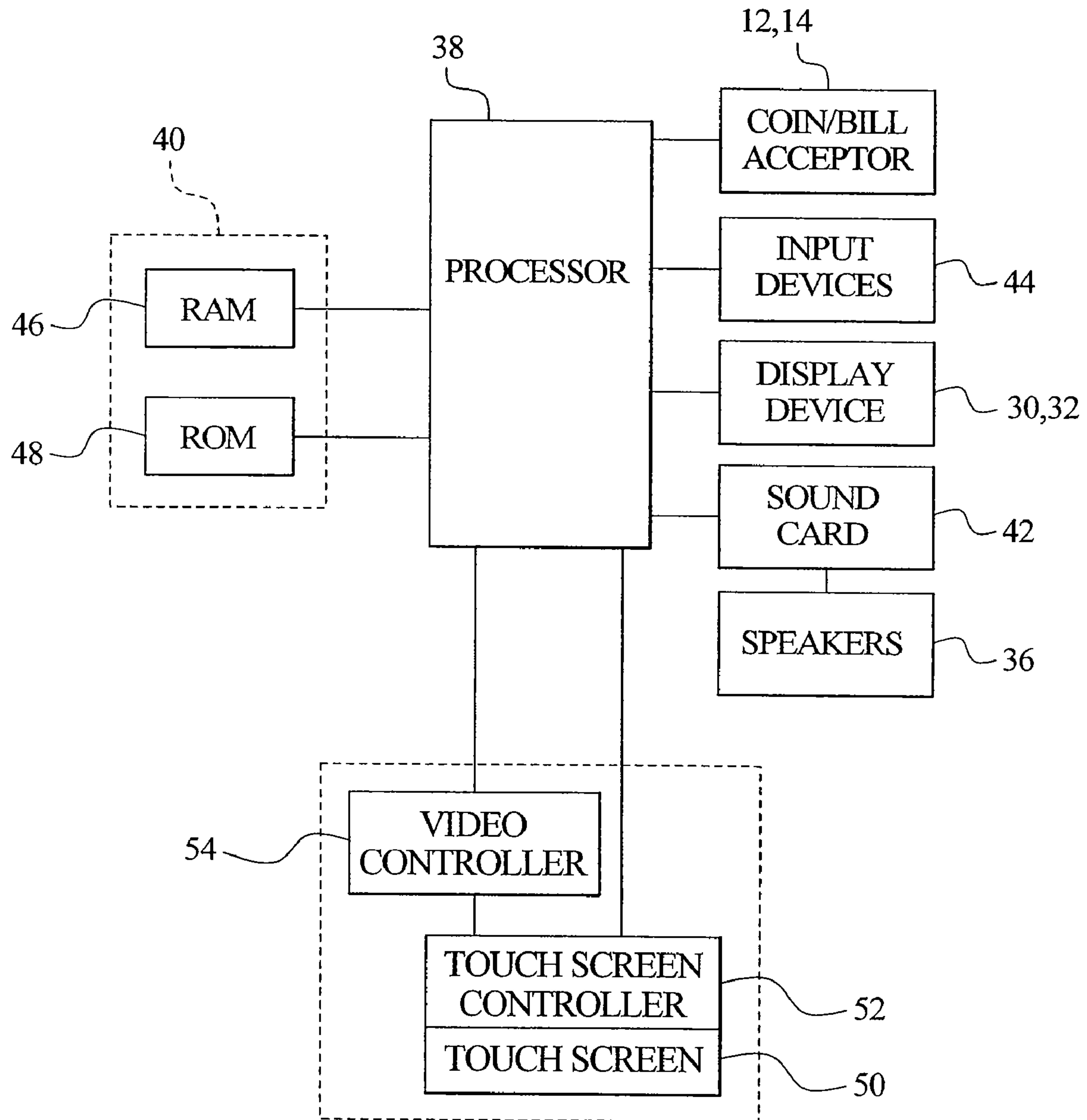


FIG. 3A

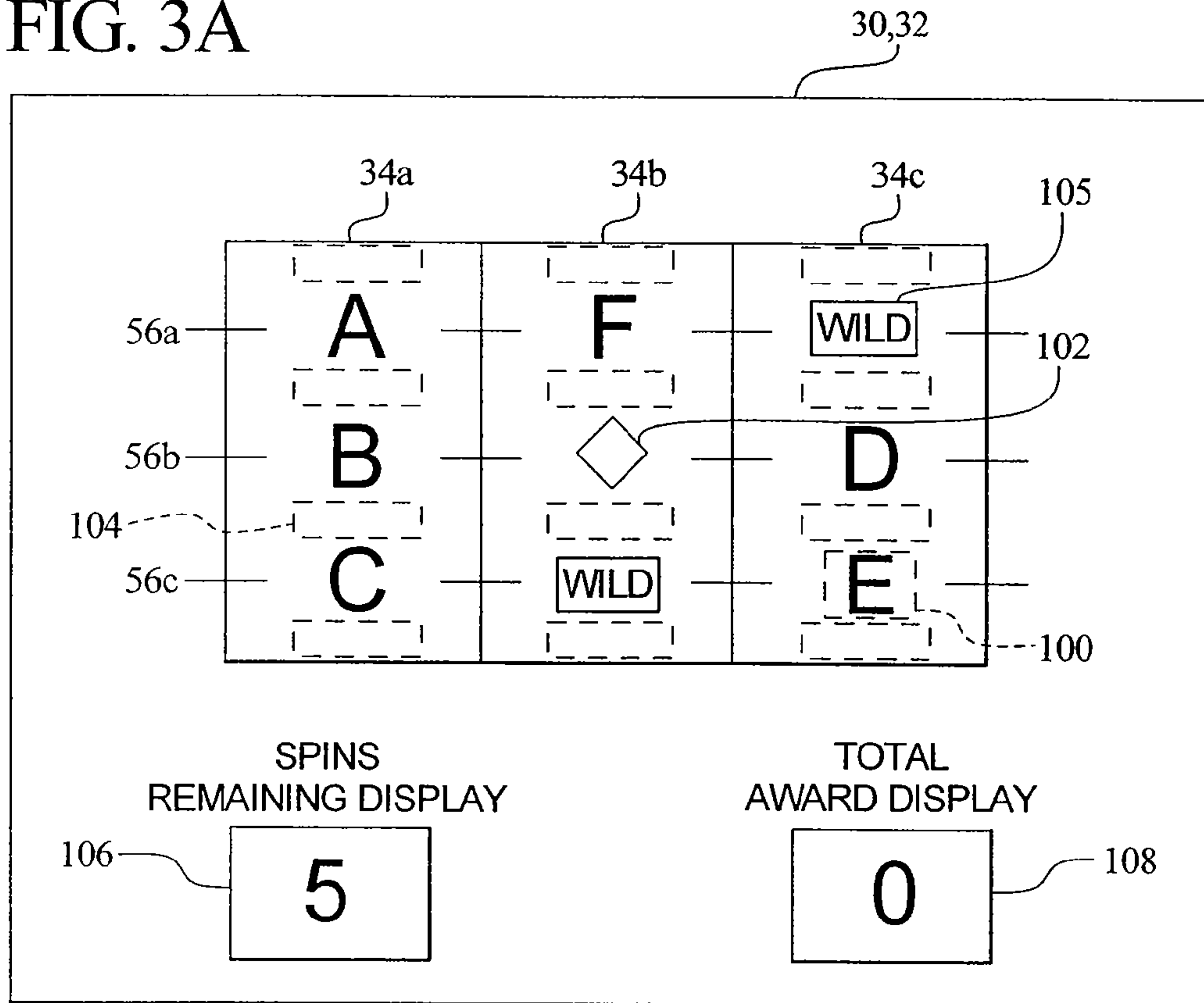


FIG. 3B

SYMBOL COMBINATION	AWARD
AAA	10,000
BBB	1000
CCC	500
DDD	100
EEE	75
FFF	50
GGG	25
HHH	10
WILD WILD WILD	10
◇ ◇ ◇	5

FIG. 4A

SYMBOL COMBINATION	PROBABILITY OF A SYMBOL ON	PROBABILITY OF A SYMBOL ON	PROBABILITY OF A SYMBOL ON	PROBABILITY
	REEL 1	REEL 2	REEL 3	TOTAL
AAA	1/20	1/20	1/20	1/8000
BBB	1/20	1/20	1/20	1/8000
CCC	1/20	1/20	1/20	1/8000
DDD	1/20	1/20	1/20	1/8000
EEE	1/20	1/20	1/20	1/8000
FFF	1/20	1/20	1/20	1/8000
GGG	1/20	1/20	1/20	1/8000
HHH	1/20	1/20	1/20	1/8000
WILD WILD WILD	1/20	1/20	1/20	1/8000
◇ ◇ ◇	1/20	1/20	1/20	1/8000
□ □ □	10/20	10/20	10/20	1/8

FIG. 4B

SYMBOL	PROBABILITY OF THE TRIGGER SYMBOL	PROBABILITY OF A SYMBOL ON	PROBABILITY OF A SYMBOL ON	PROBABILITY OF A SYMBOL ON	PROBABILITY
		REEL 1	REEL 2	REEL 3	TOTAL
A	1/20	X	1/9	X	1/180
B	1/20		1/9		1/180
C	1/20		1/9		1/180
D	1/20		1/9		1/180
E	1/20		1/9		1/180
F	1/20		1/9		1/180
G	1/20		1/9		1/180
H	1/20		1/9		1/180
WILD	1/20		1/9		1/180

FIG. 5A

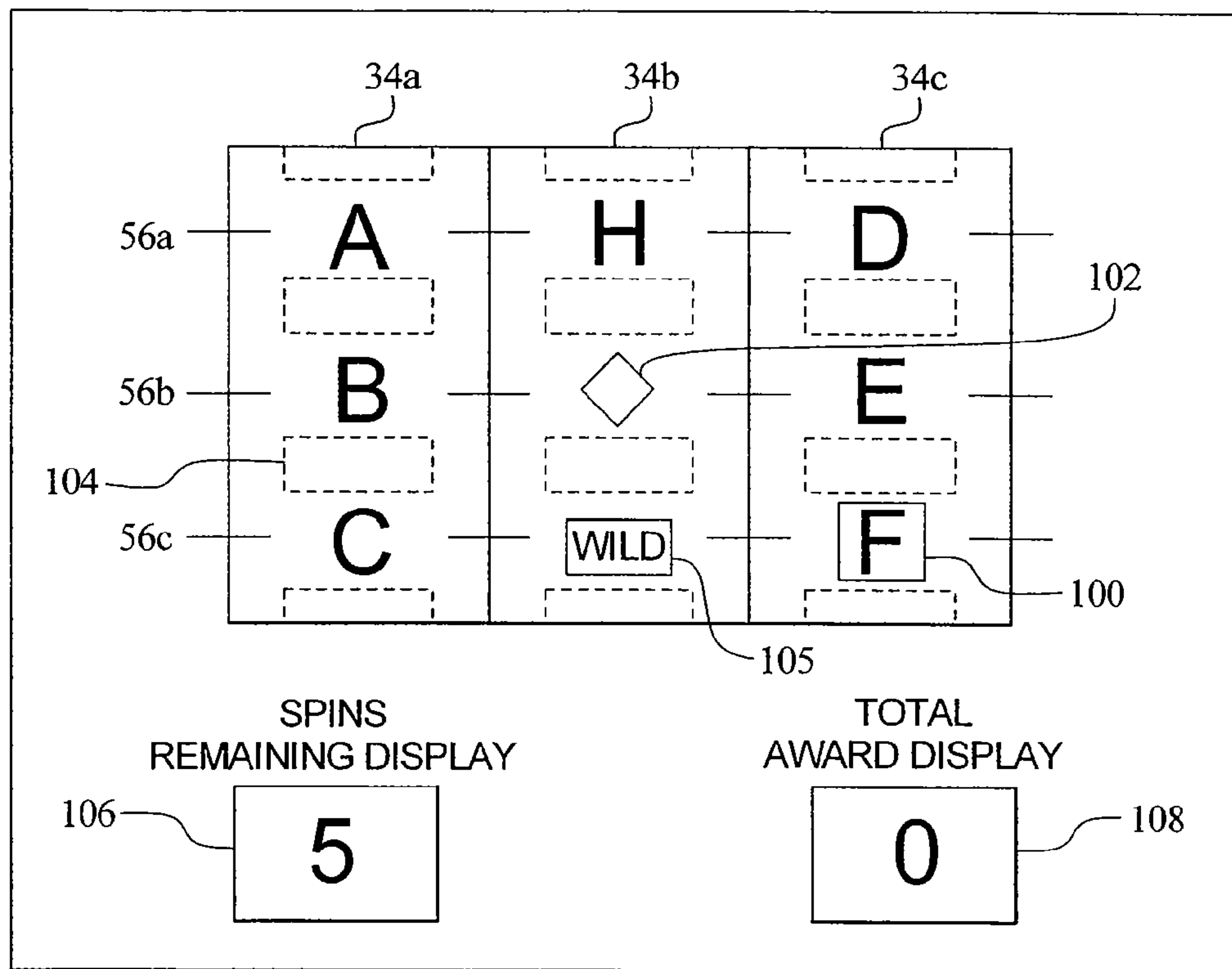


FIG. 5B

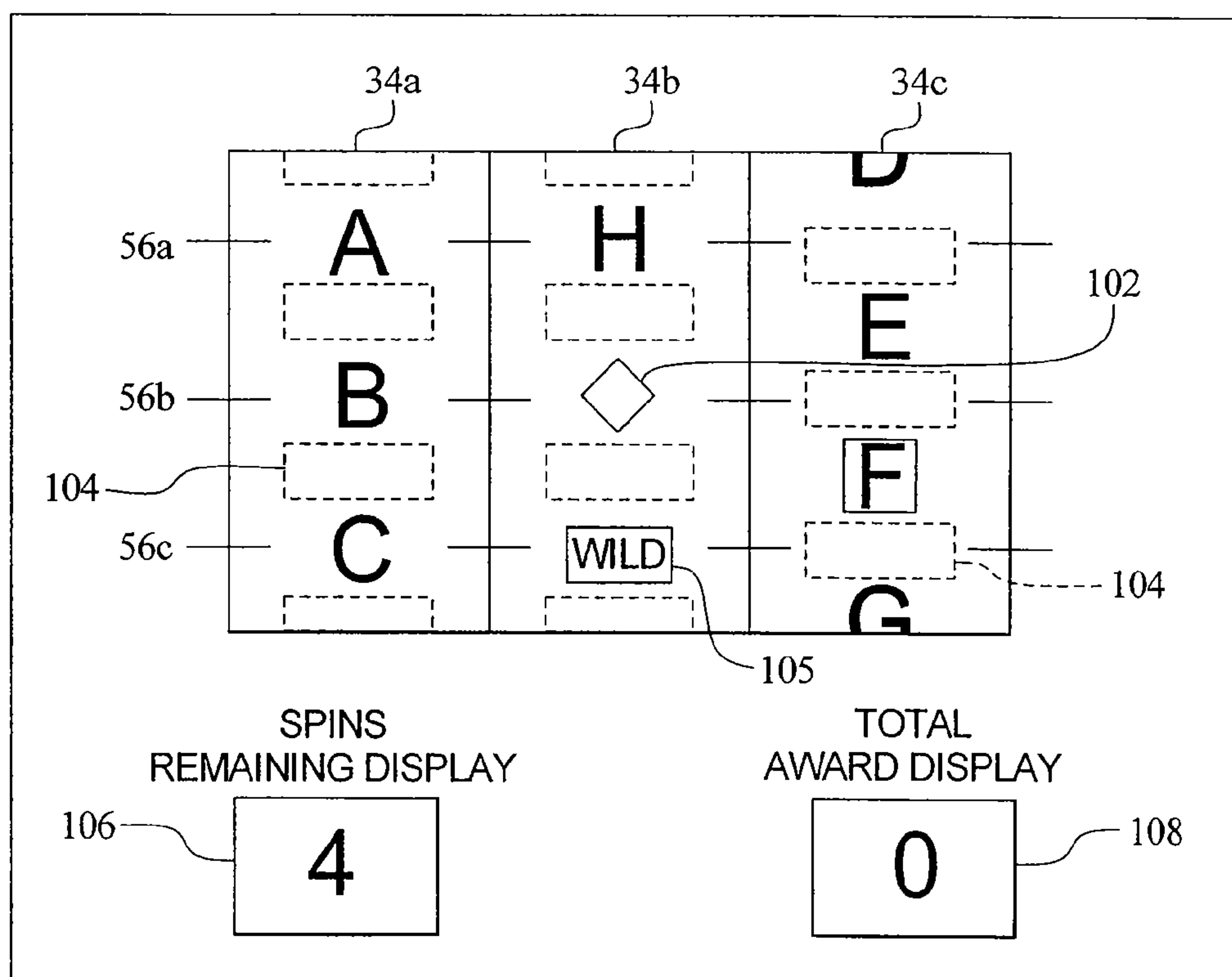


FIG. 5E

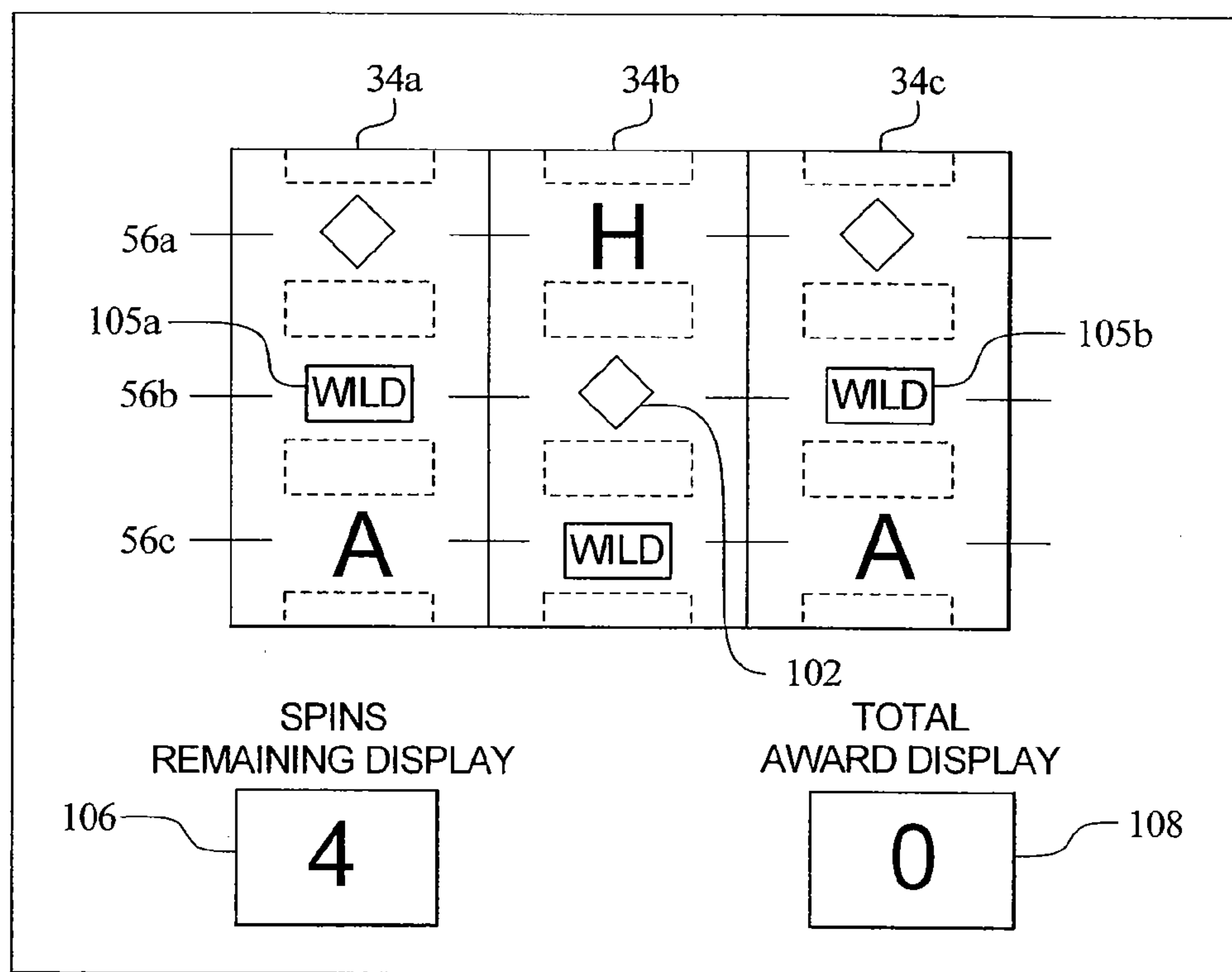


FIG. 5F

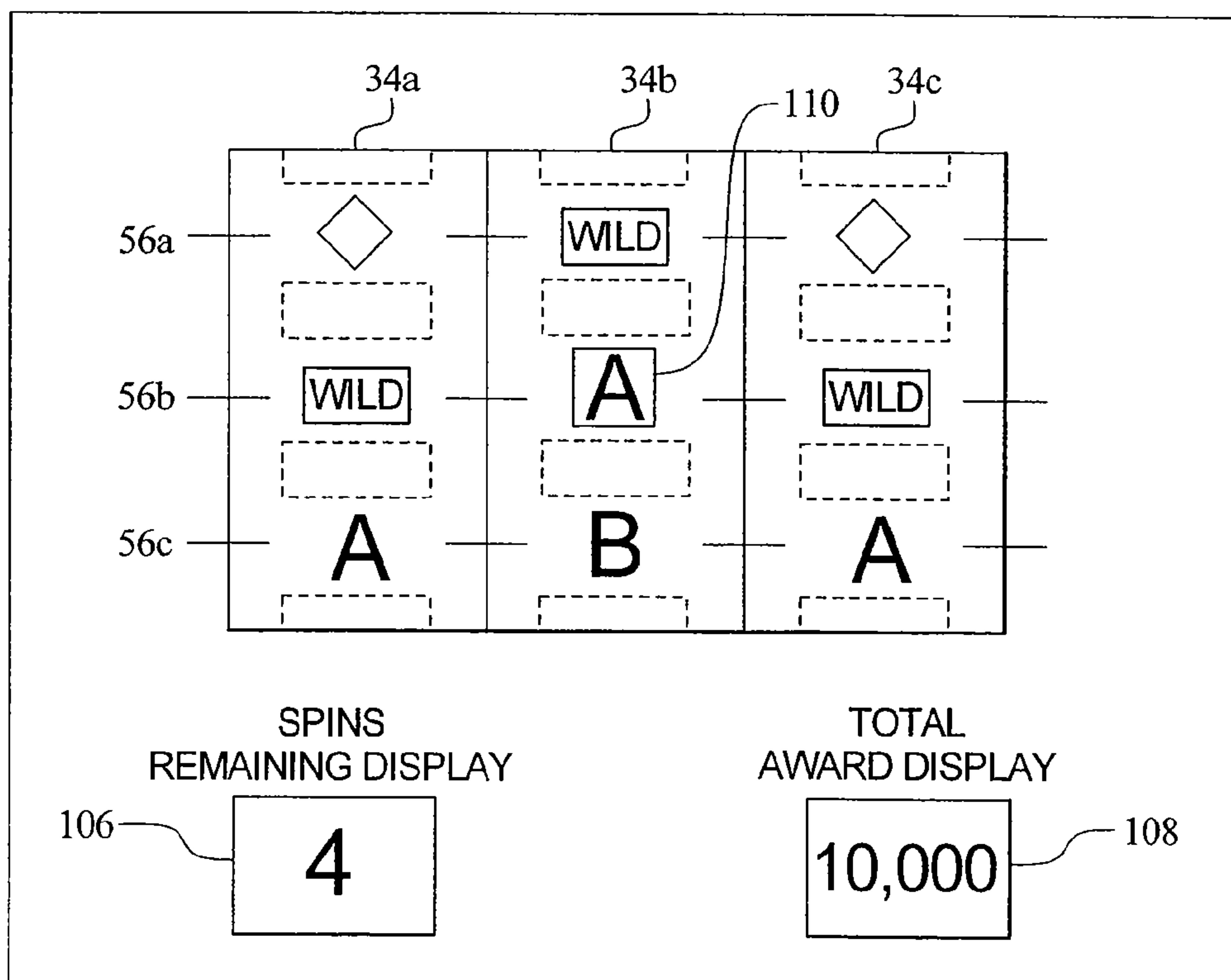


FIG. 6

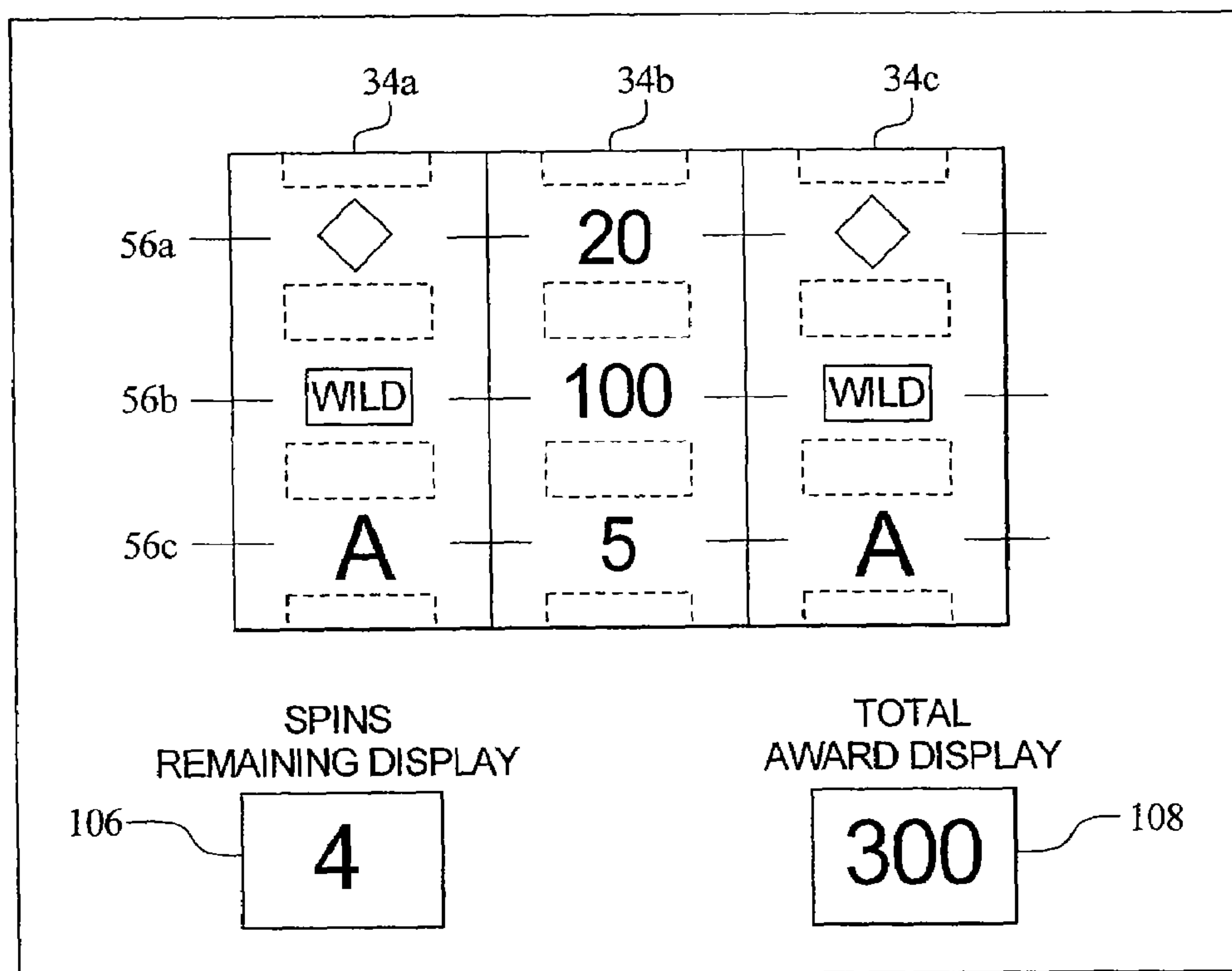


FIG. 7

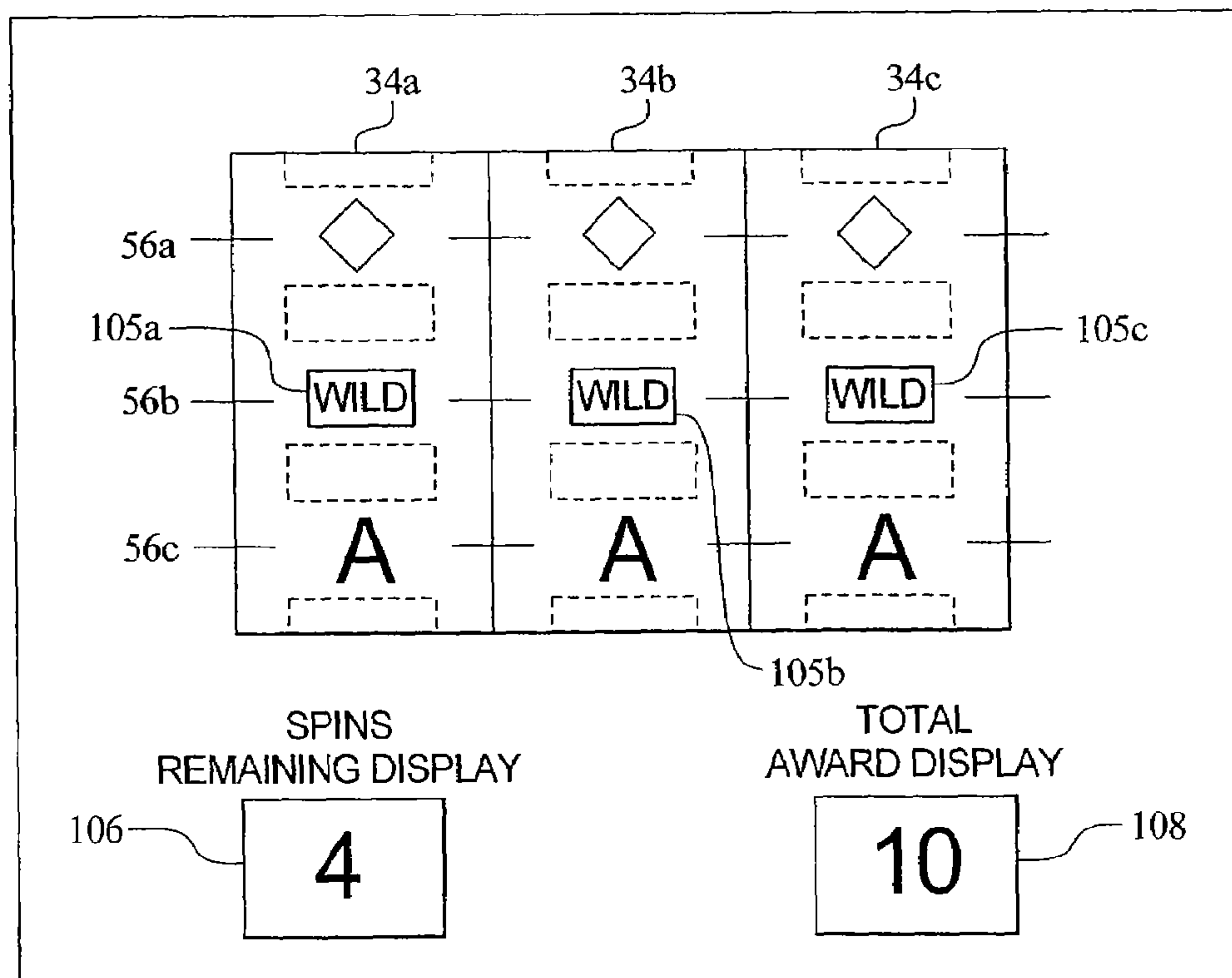


FIG. 8
(PRIOR ART)

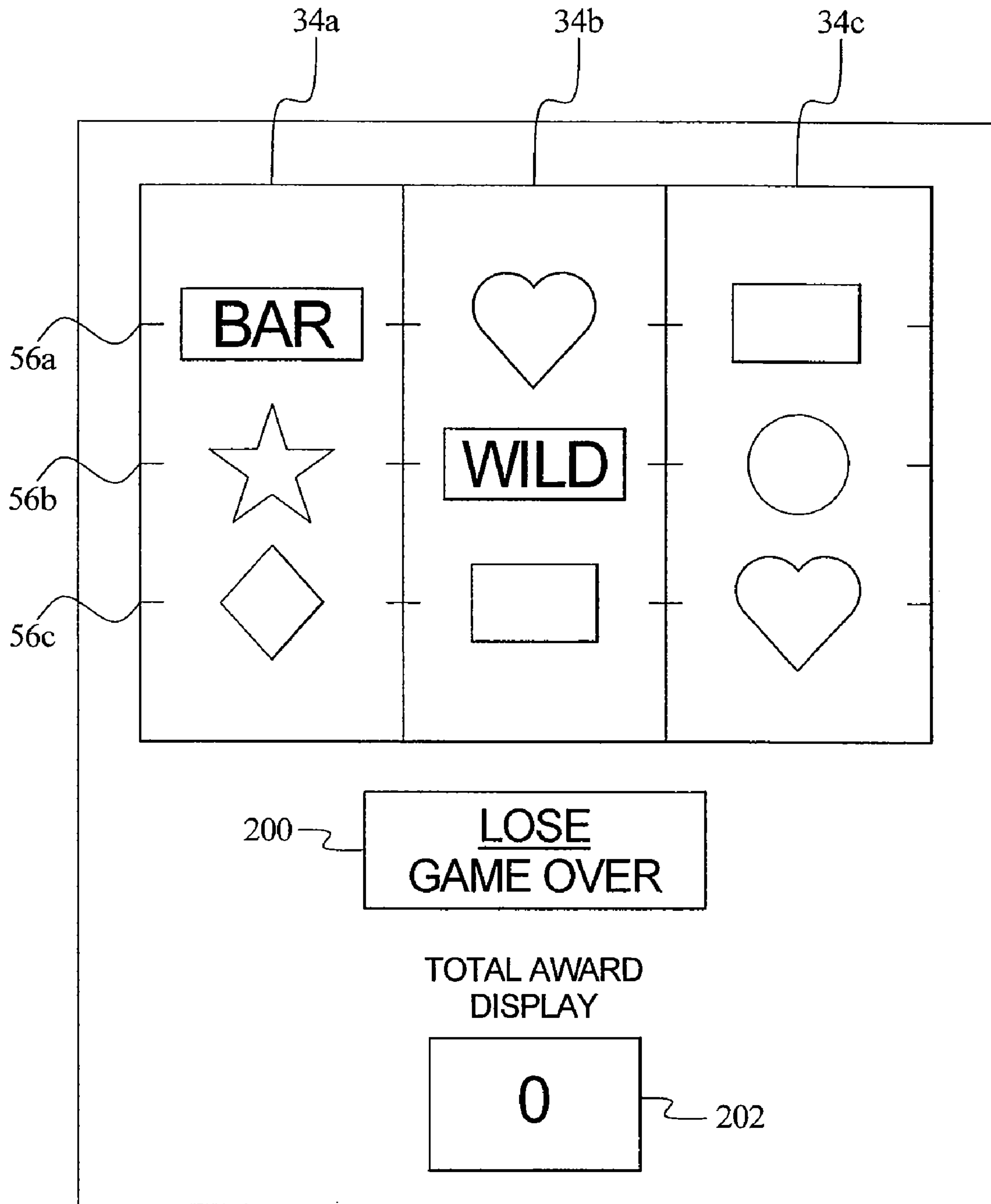


FIG. 9

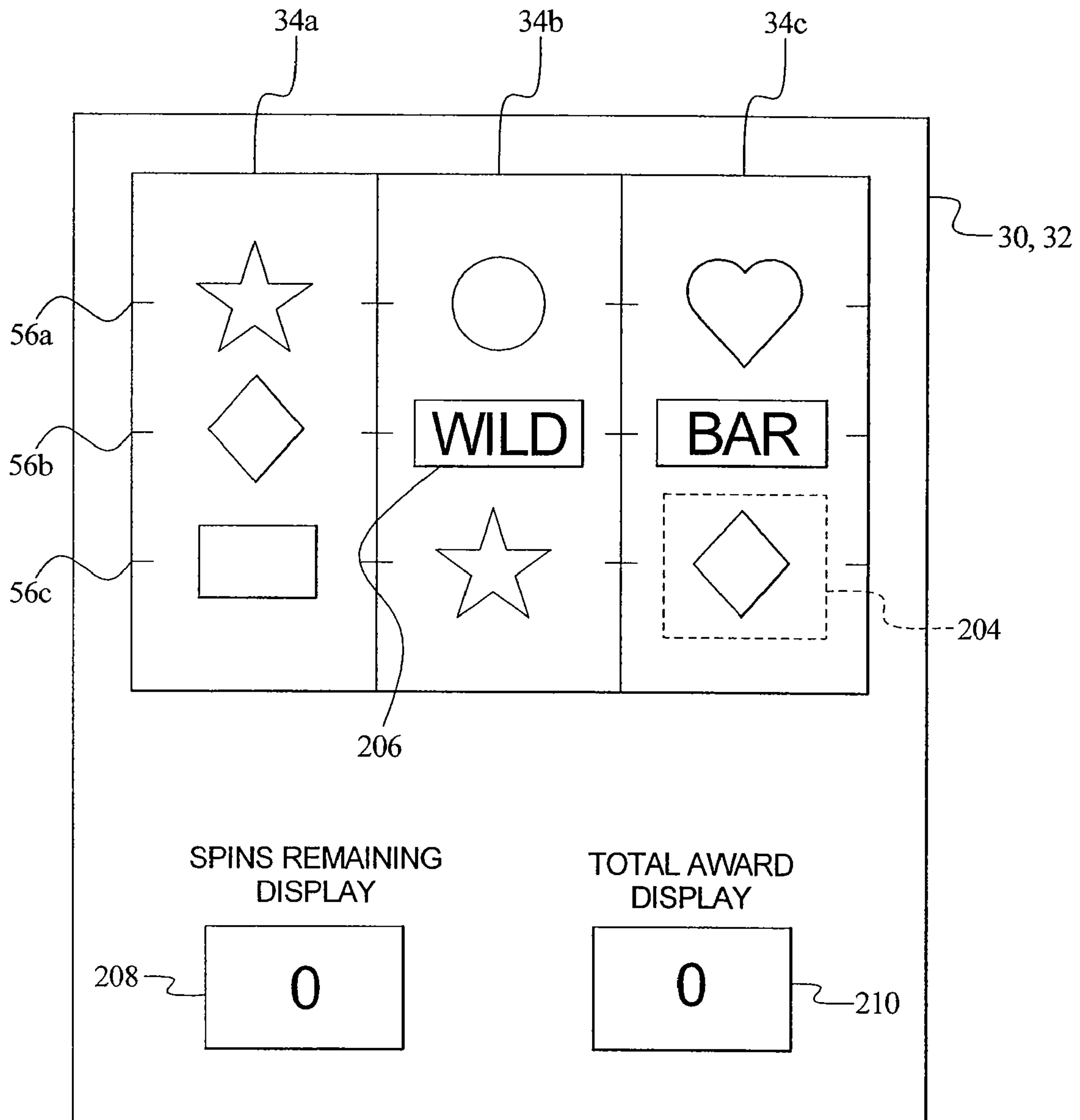


FIG. 10A

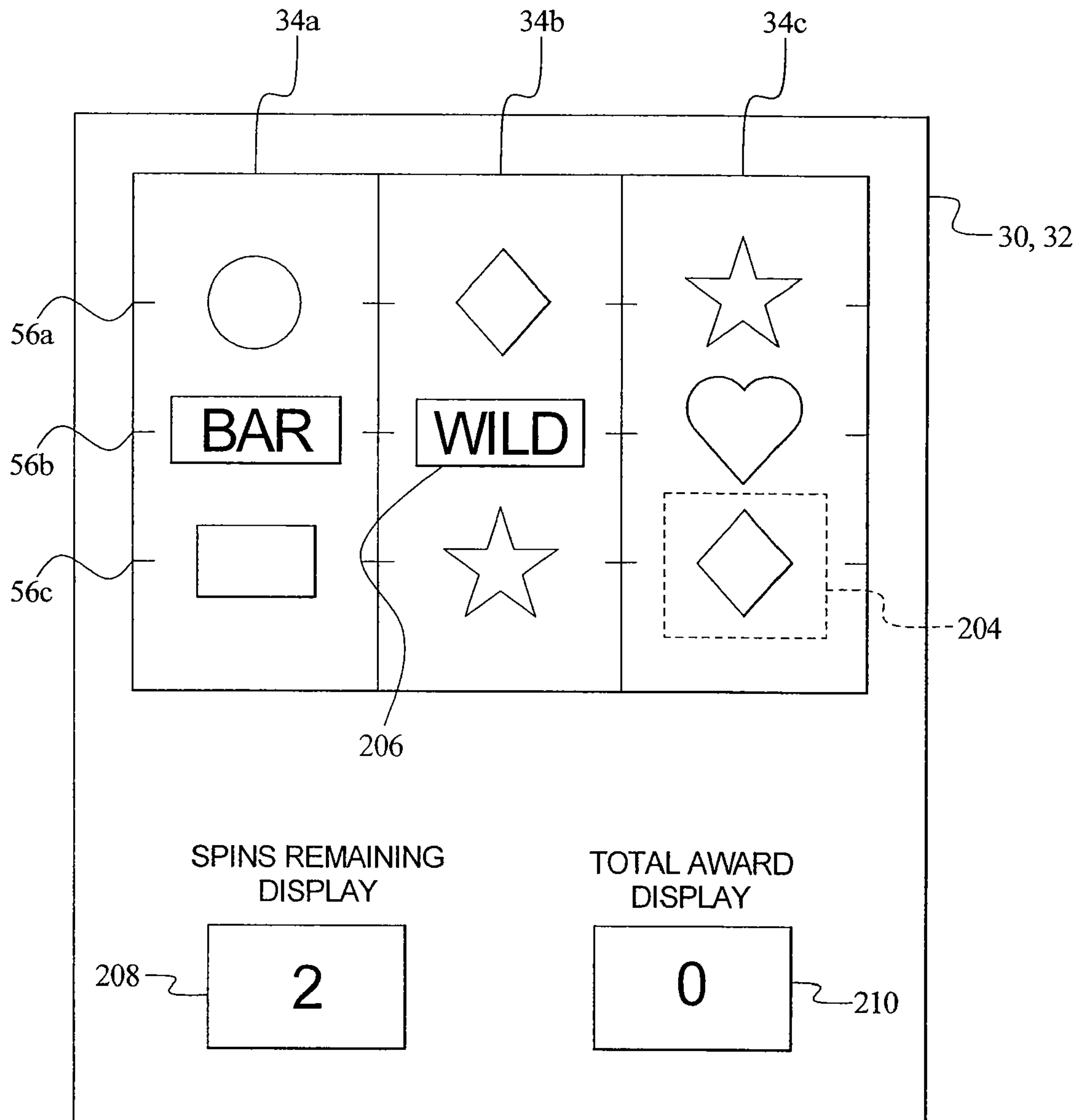


FIG. 10B

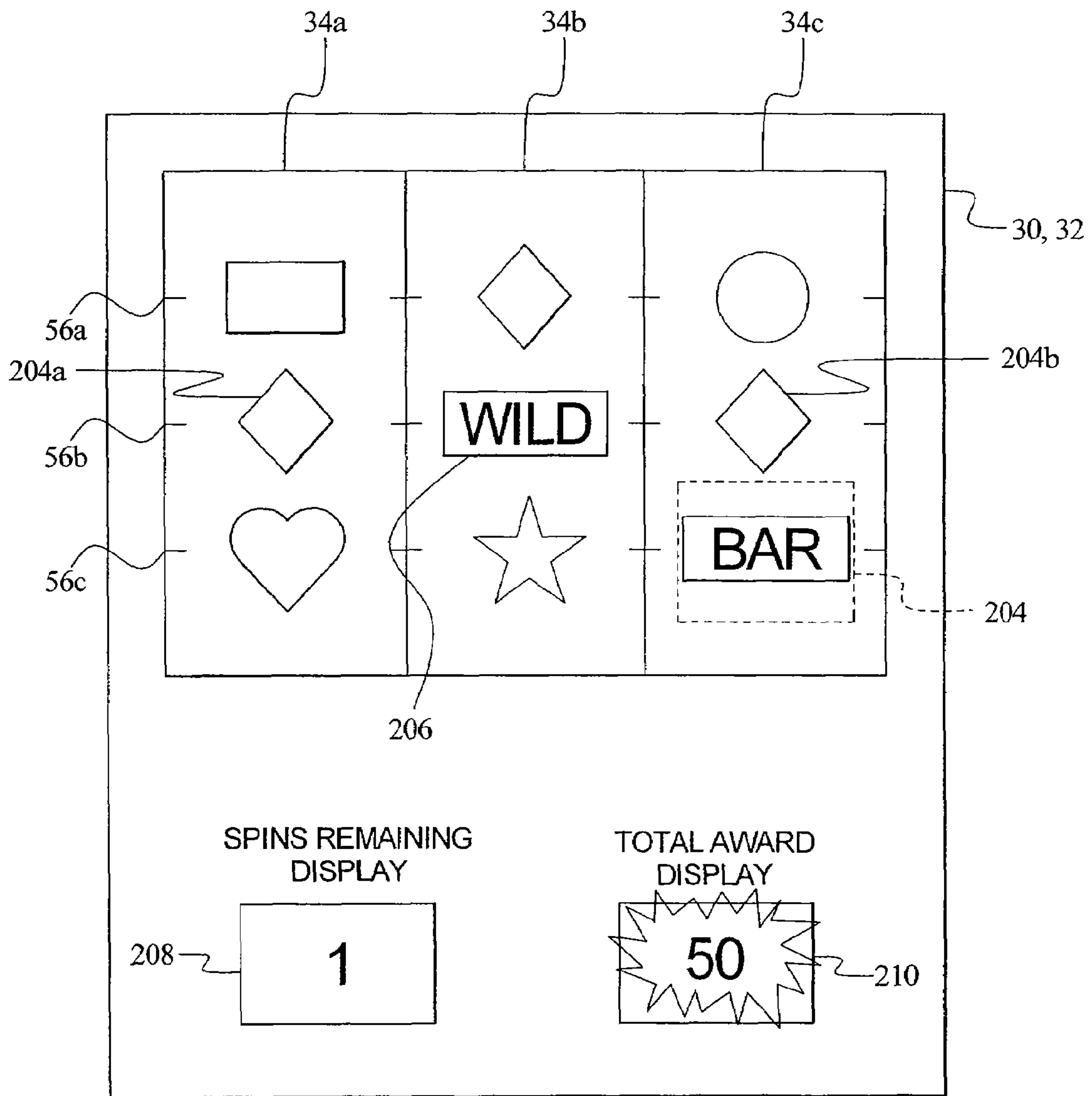


FIG. 11A

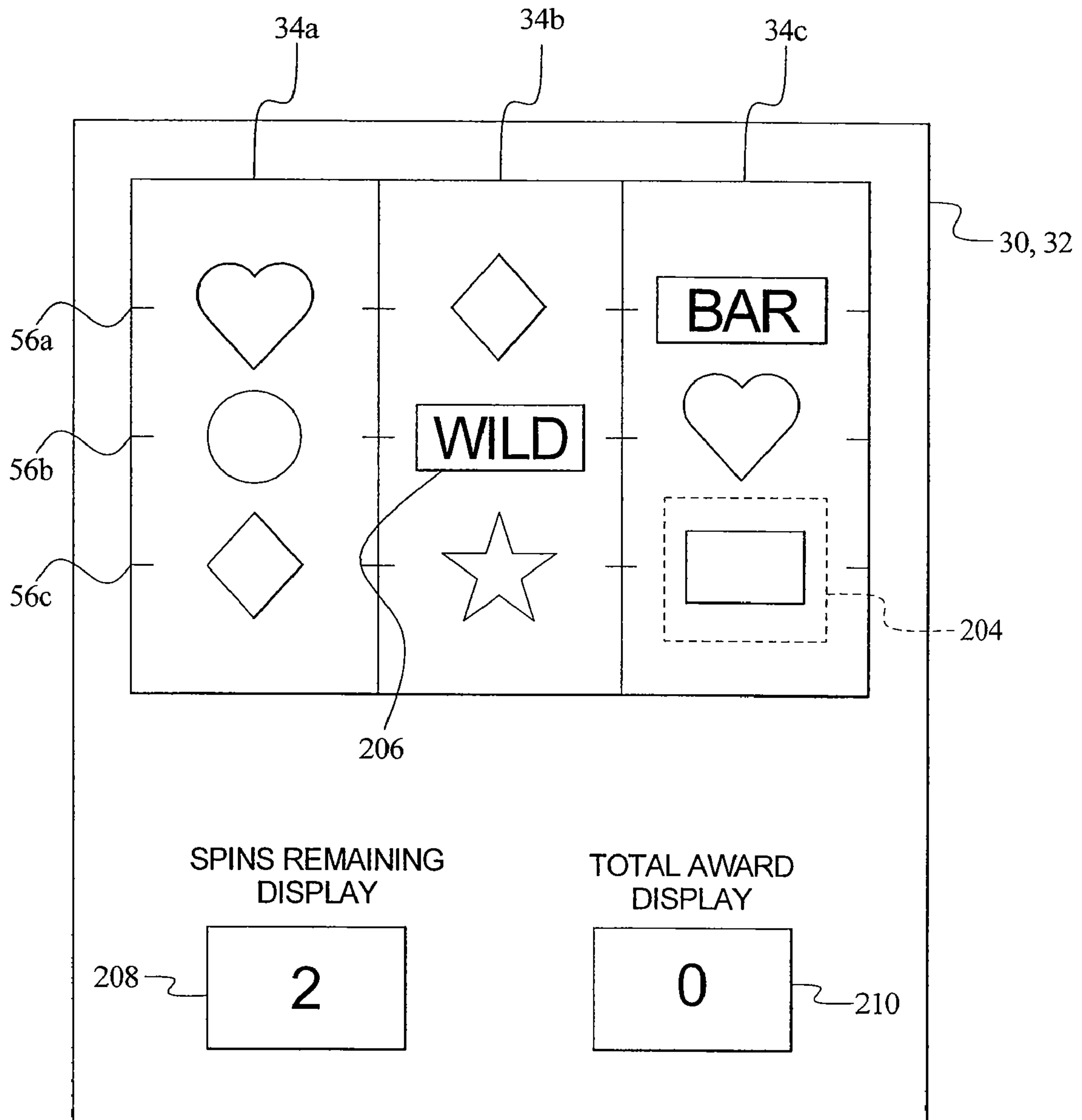


FIG. 11B

212



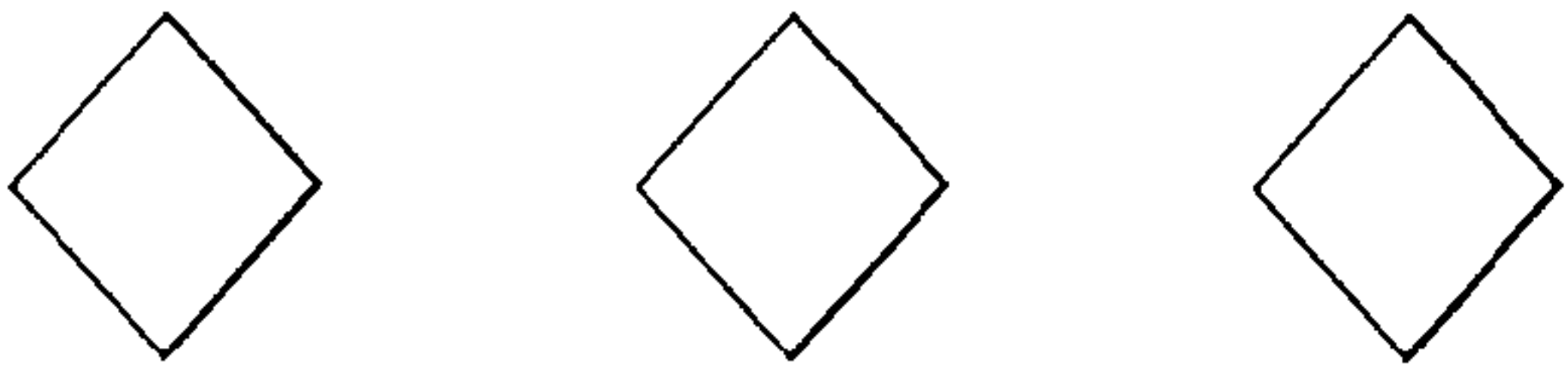
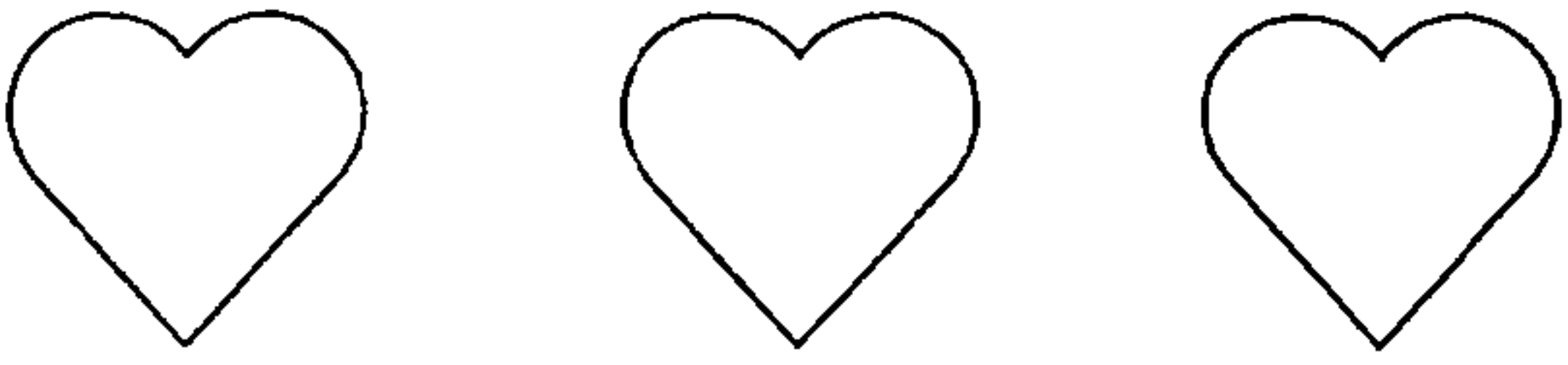

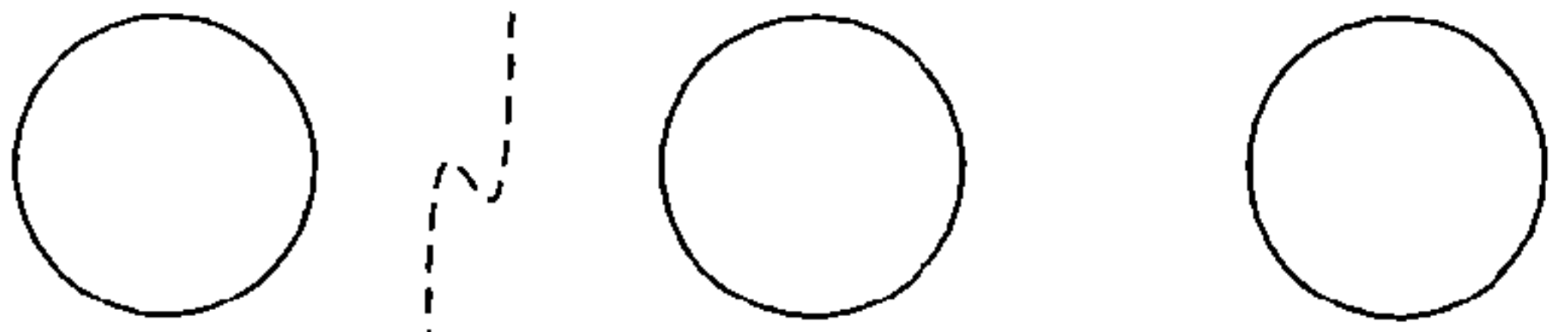
COMBINATION	AWARD
 214a	250 216a
	100
	75
	50
 214b	25 216b
	10

FIG. 11C

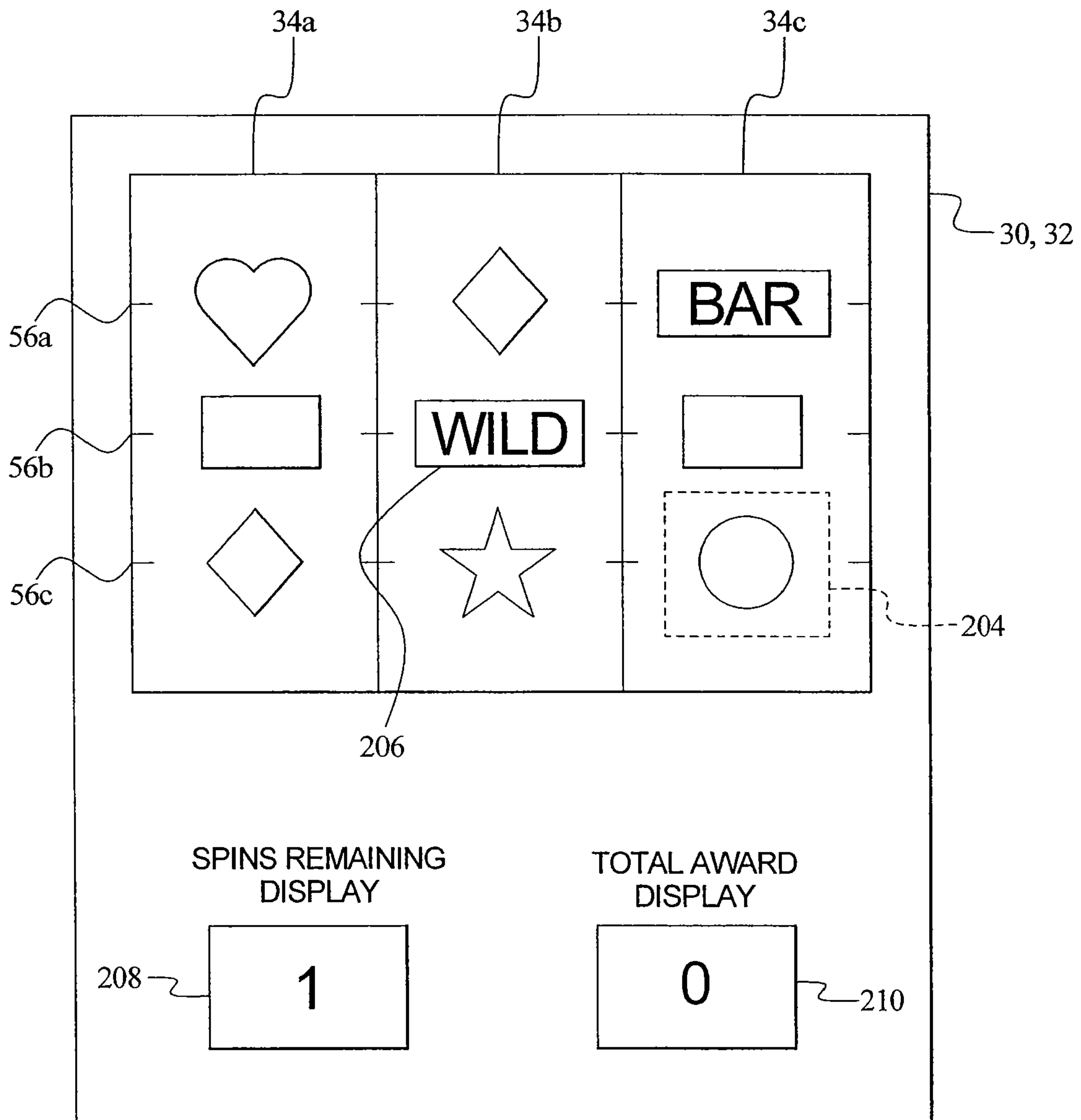


FIG. 11D

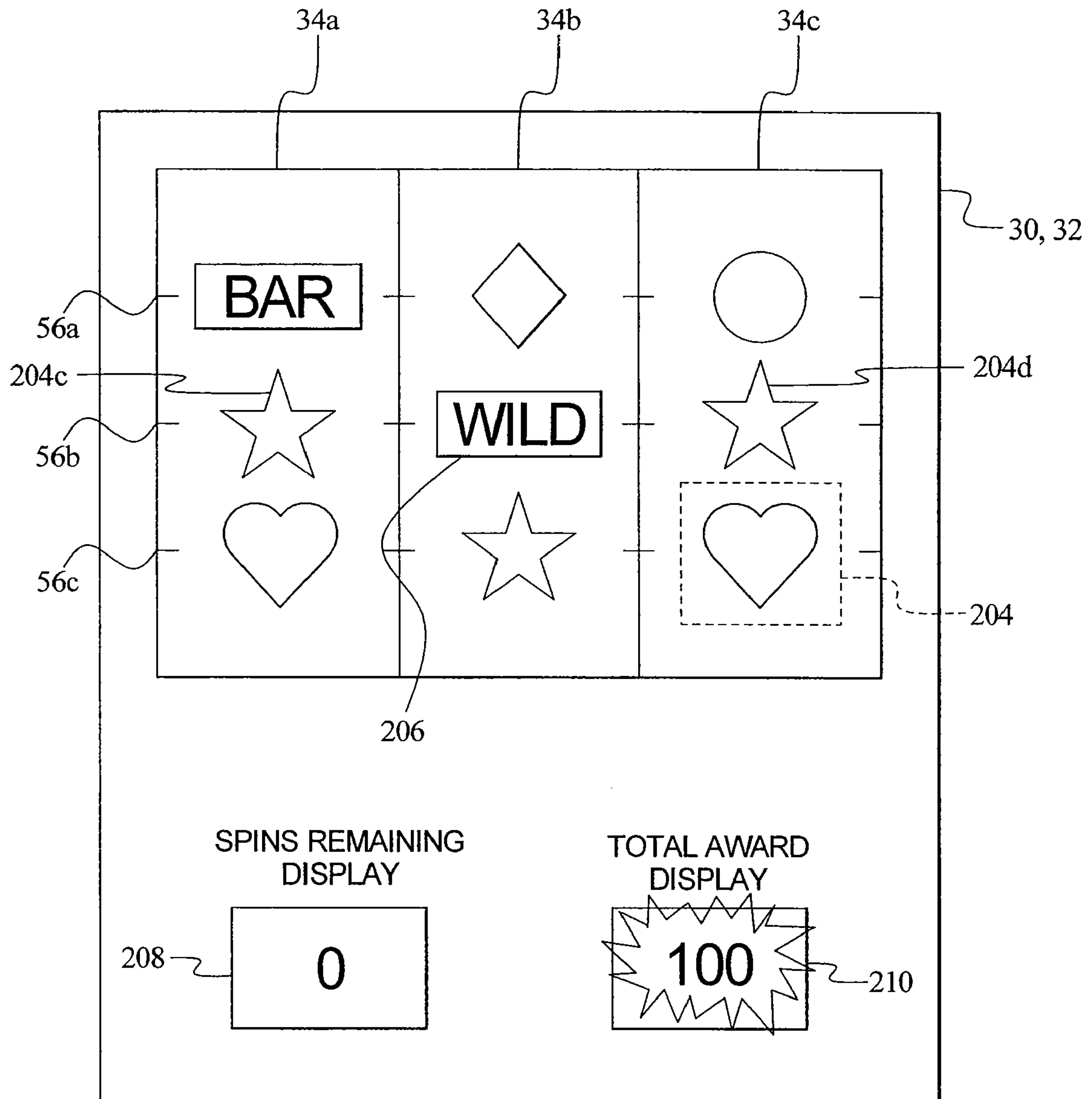


FIG. 12

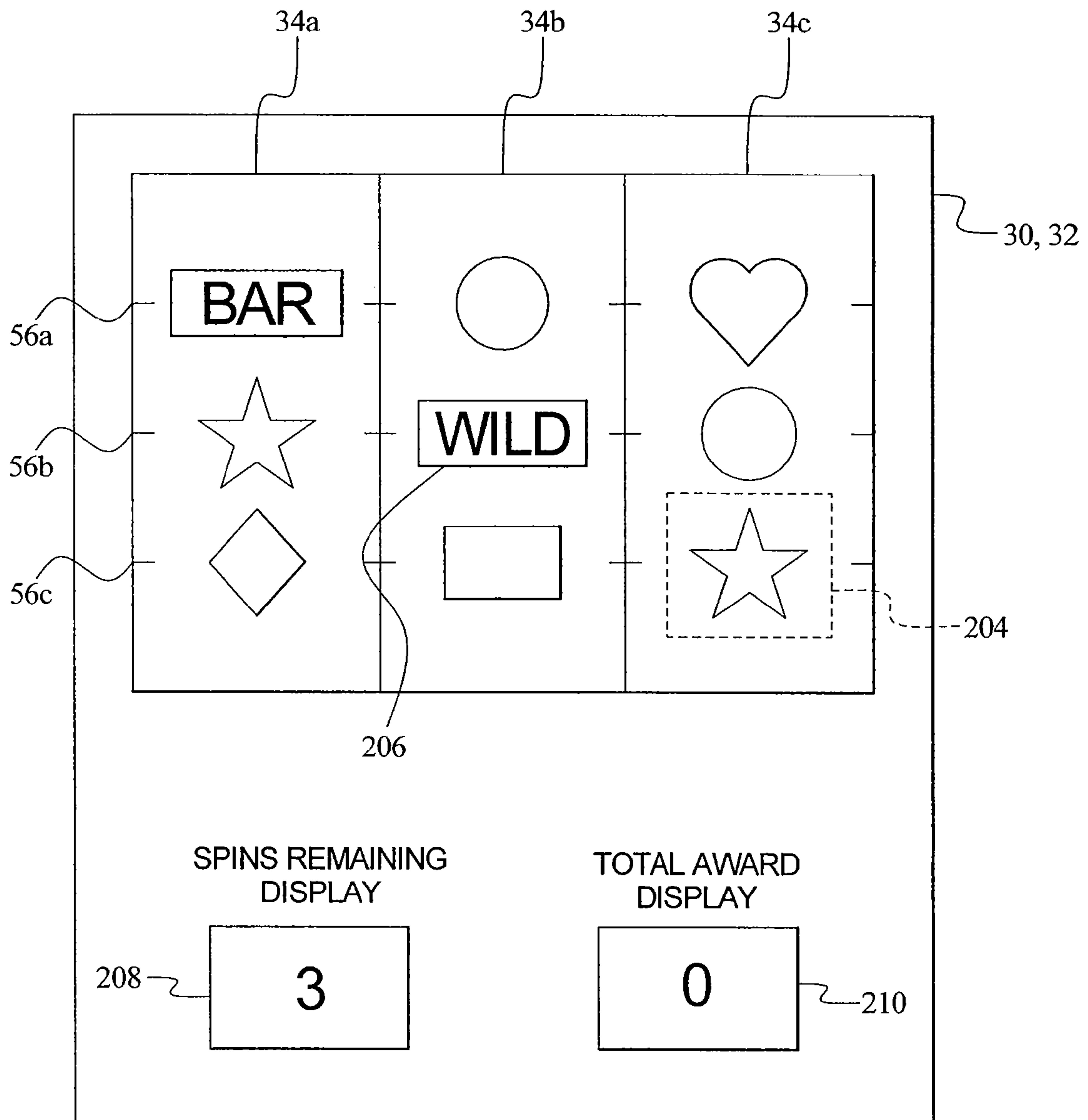


FIG. 13A

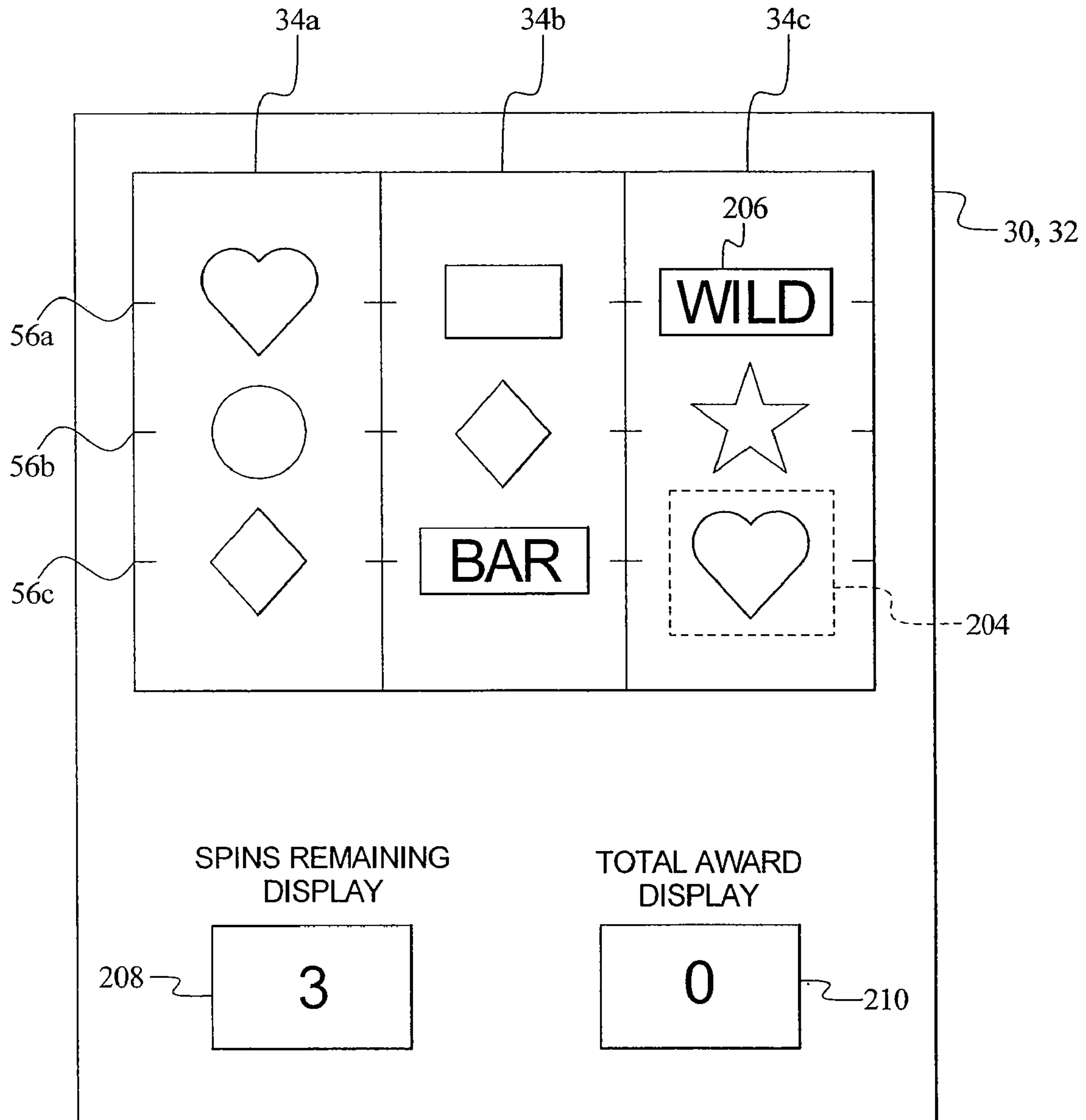


FIG. 13B

218

220




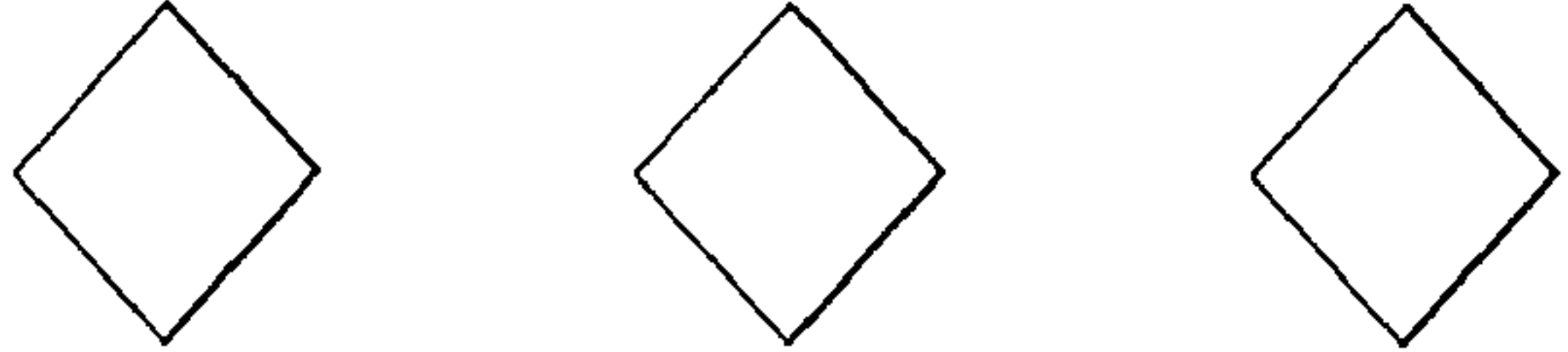
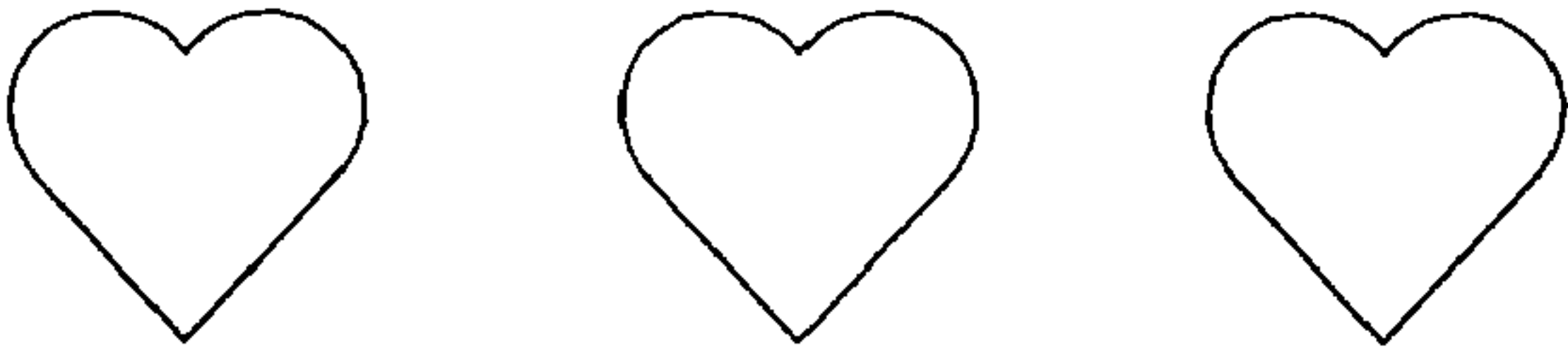

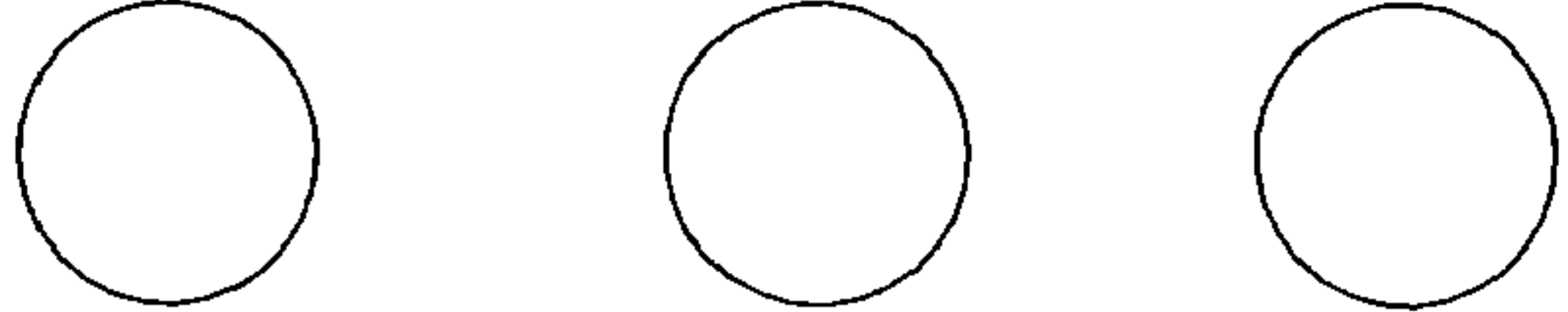
COMBINATION	AWARD
	
	100
	75
	50
	25
	10

FIG. 13C

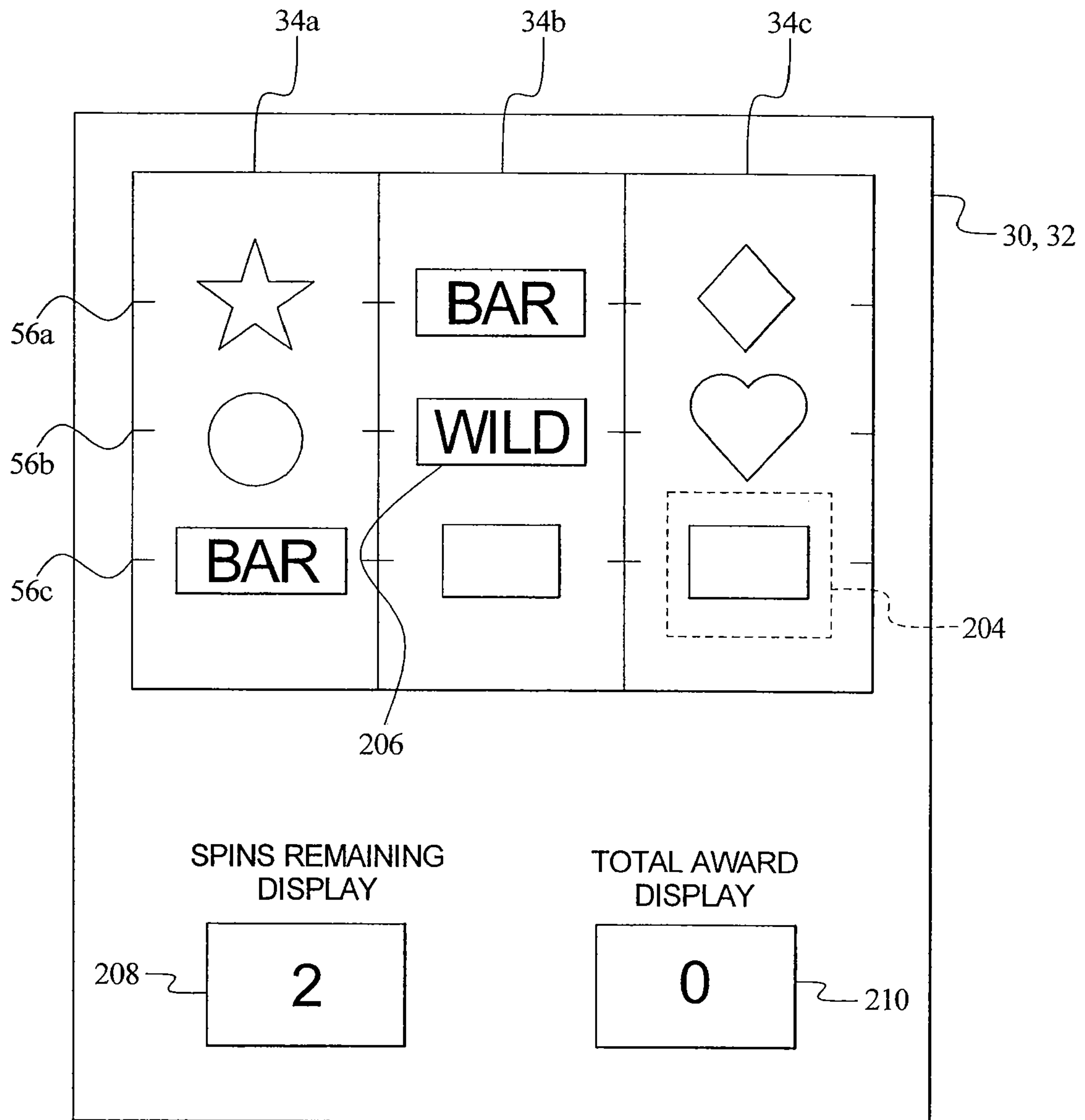


FIG. 13D

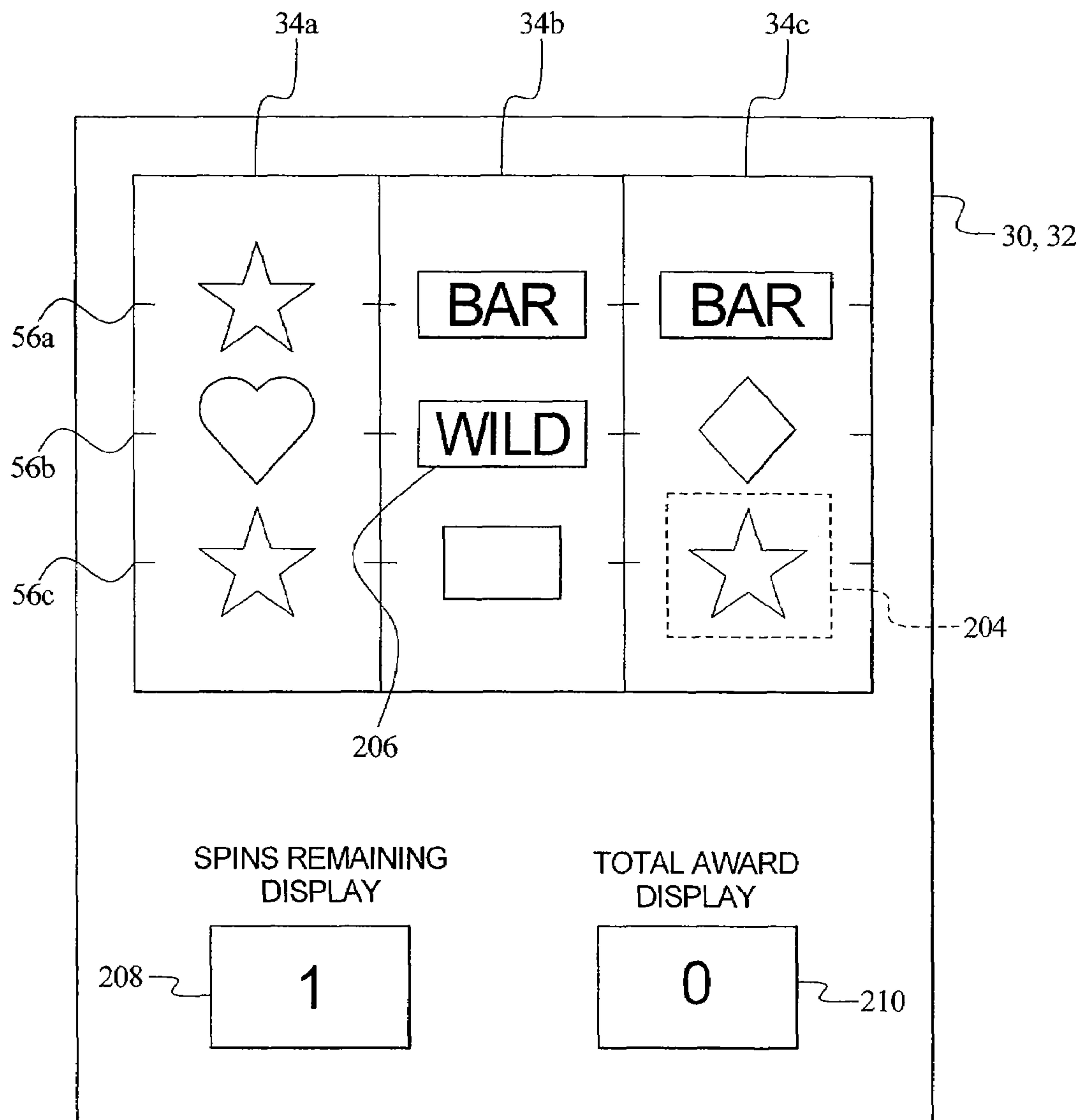


FIG. 13E

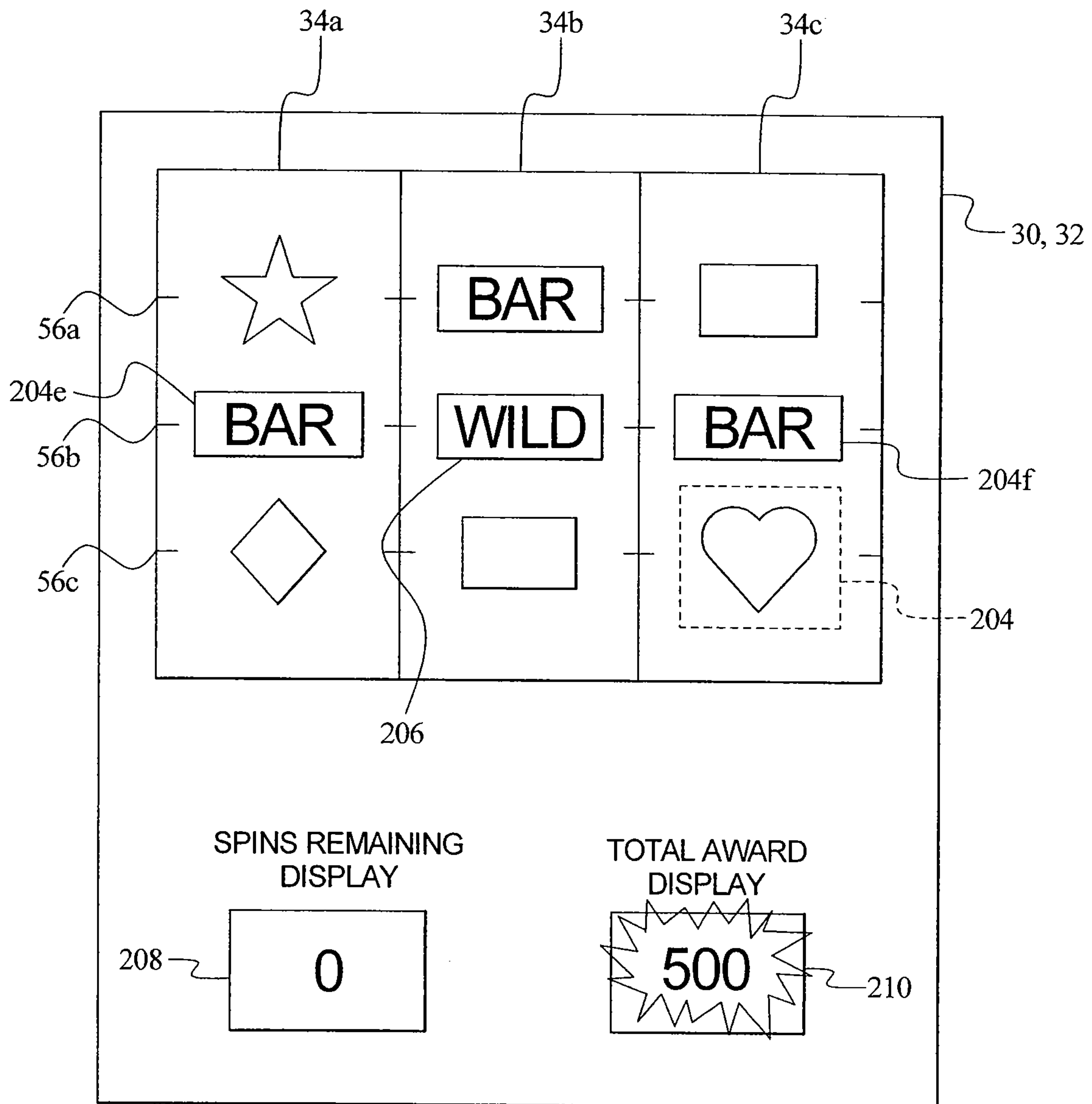


FIG. 14A

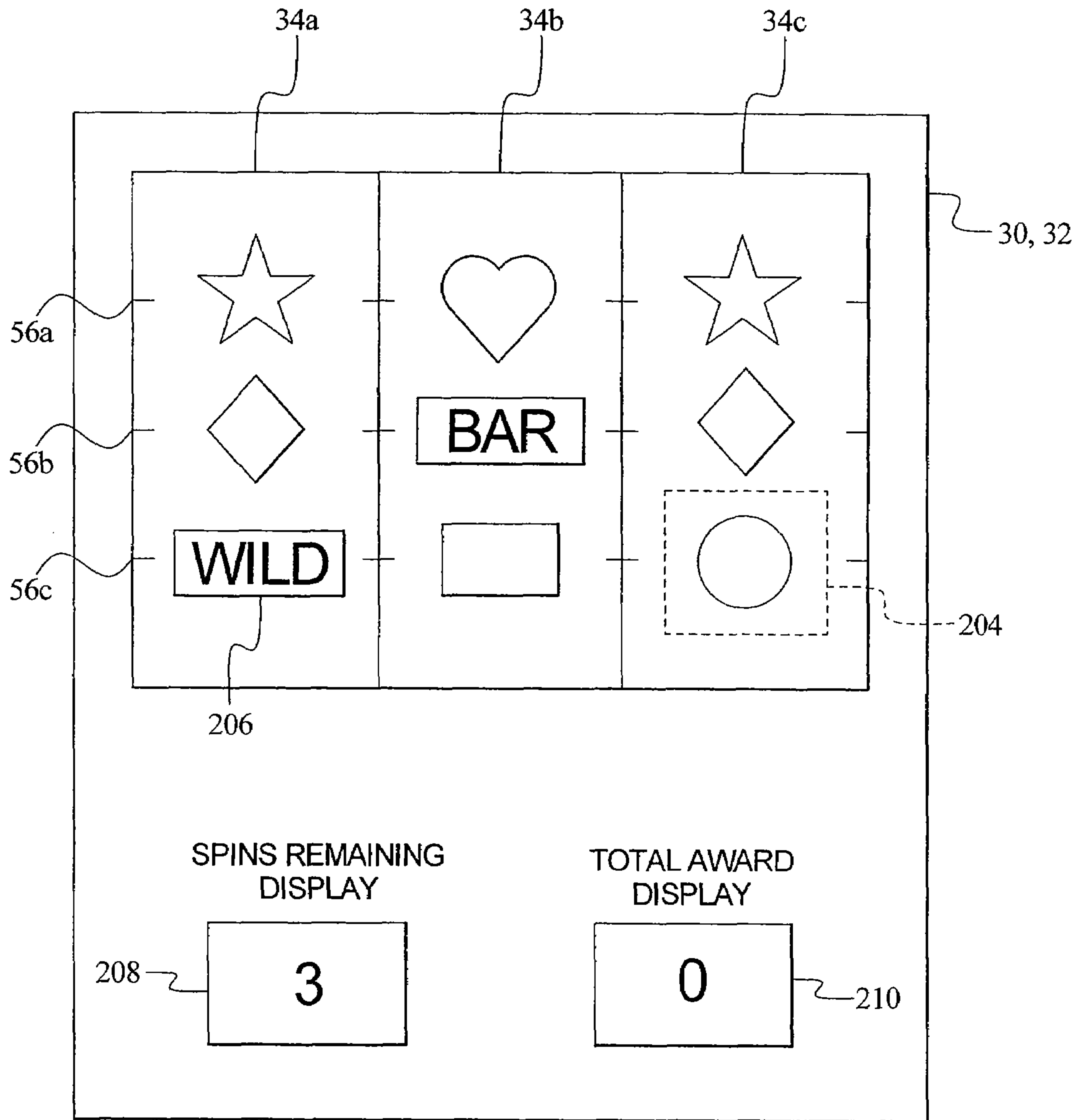


FIG. 14B

224

226




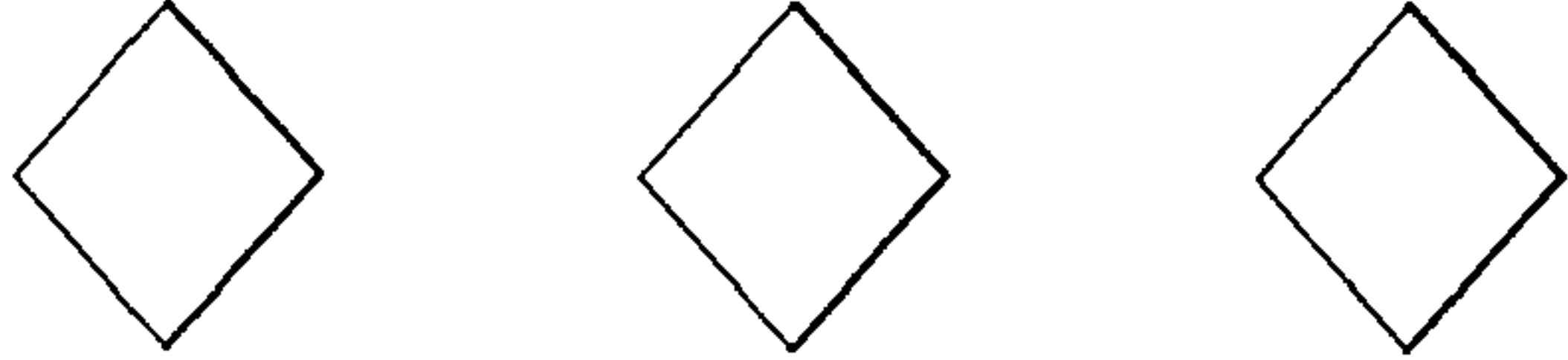

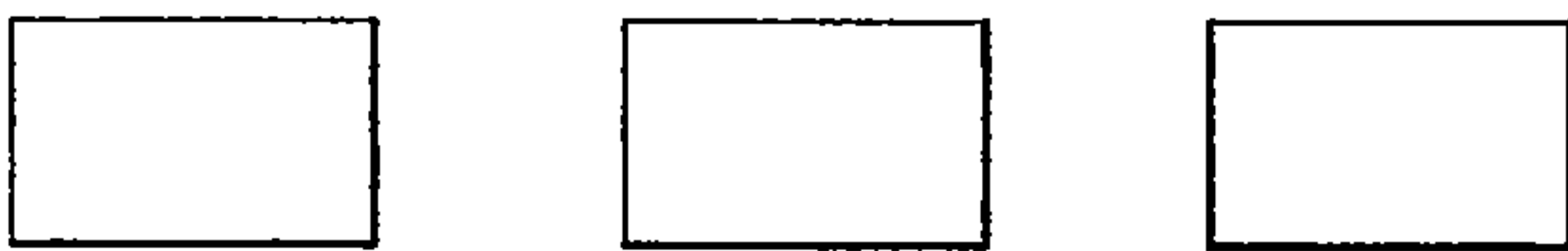
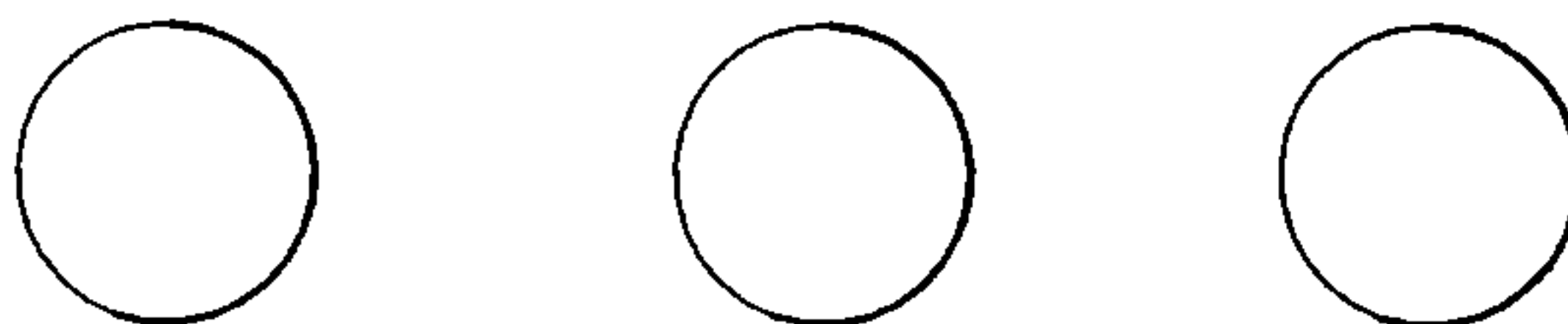
COMBINATION	AWARD
	
	250
	100
	50
	25
	10

FIG. 14C

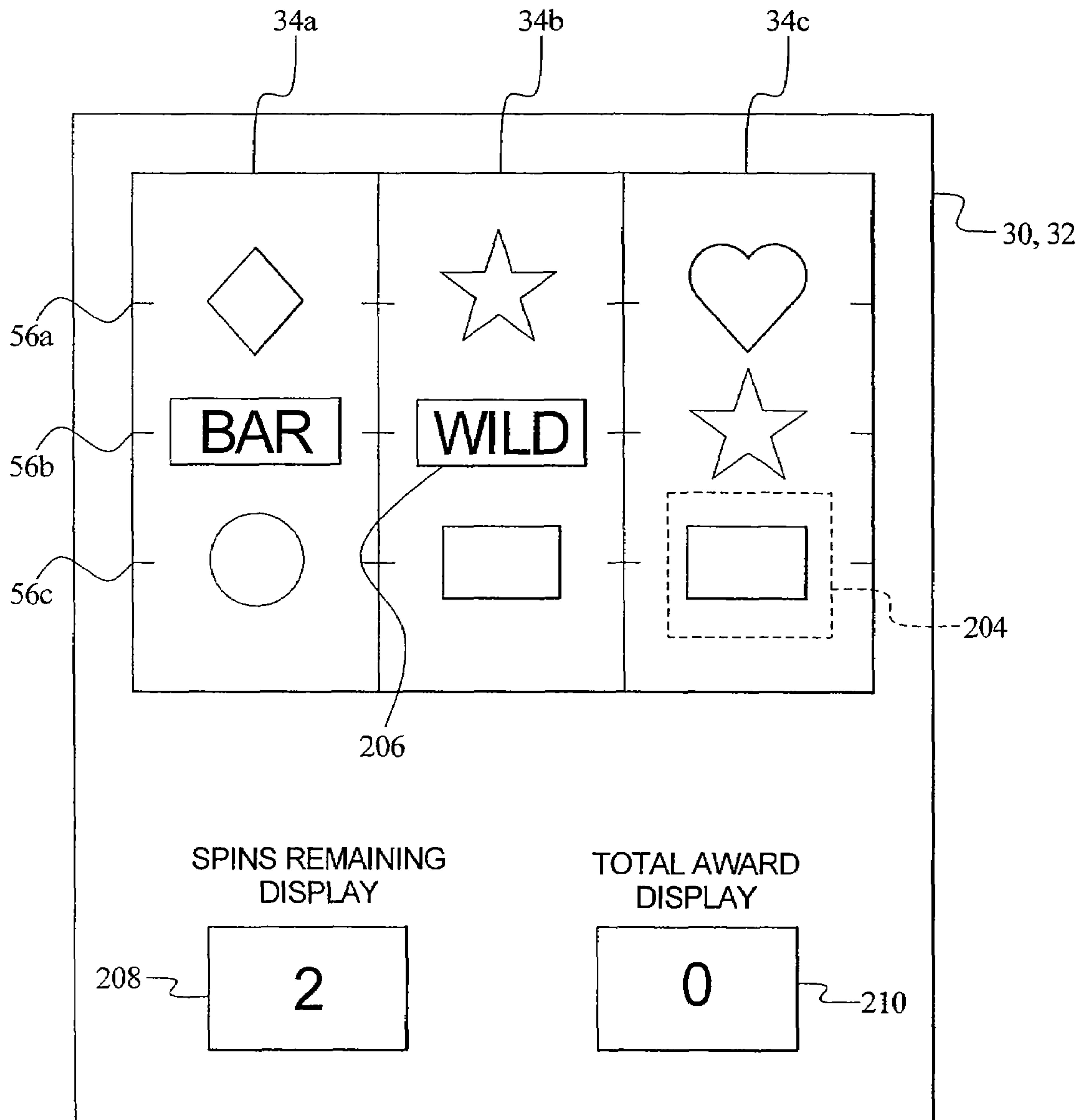


FIG. 14D

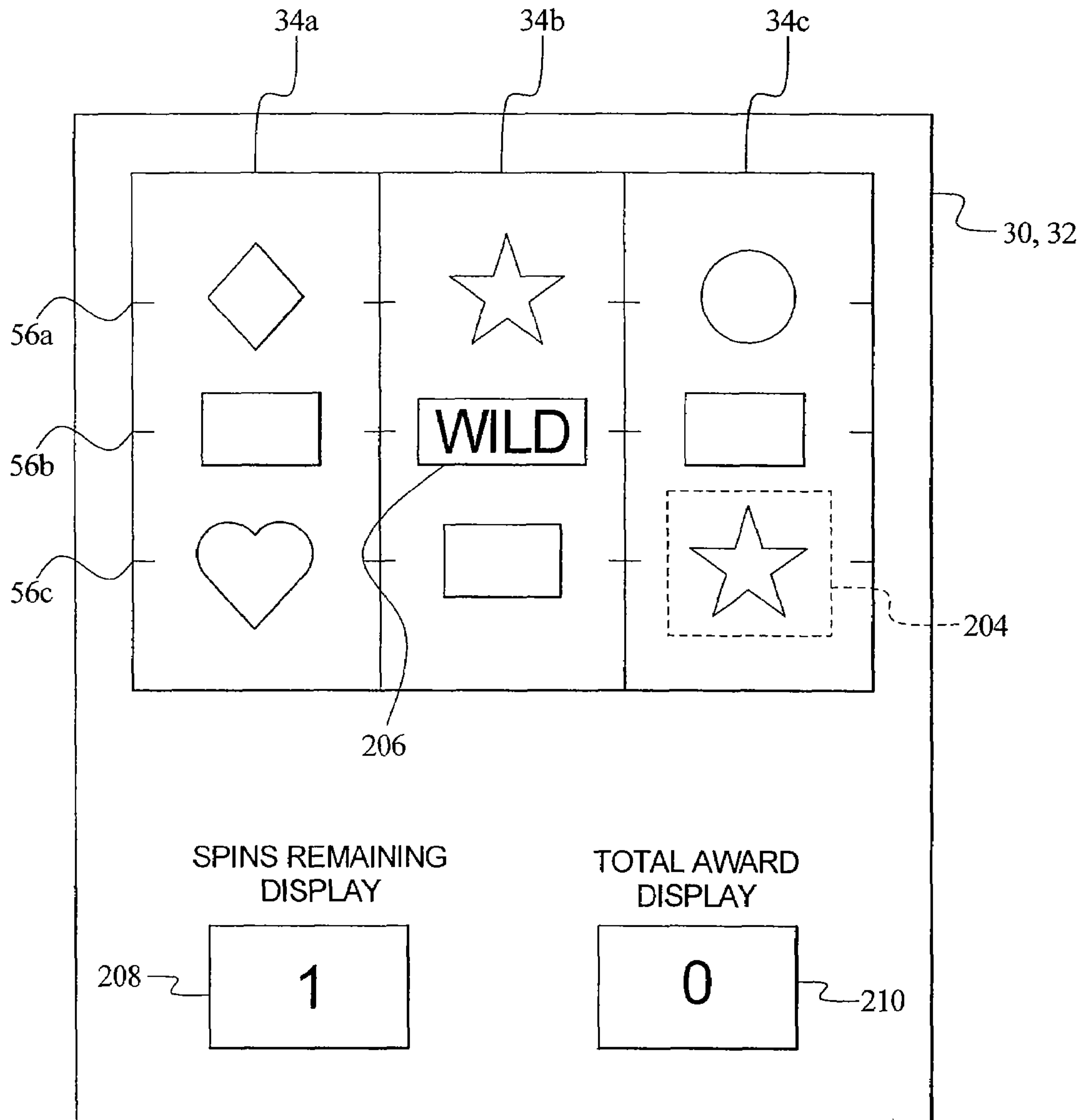


FIG. 14E

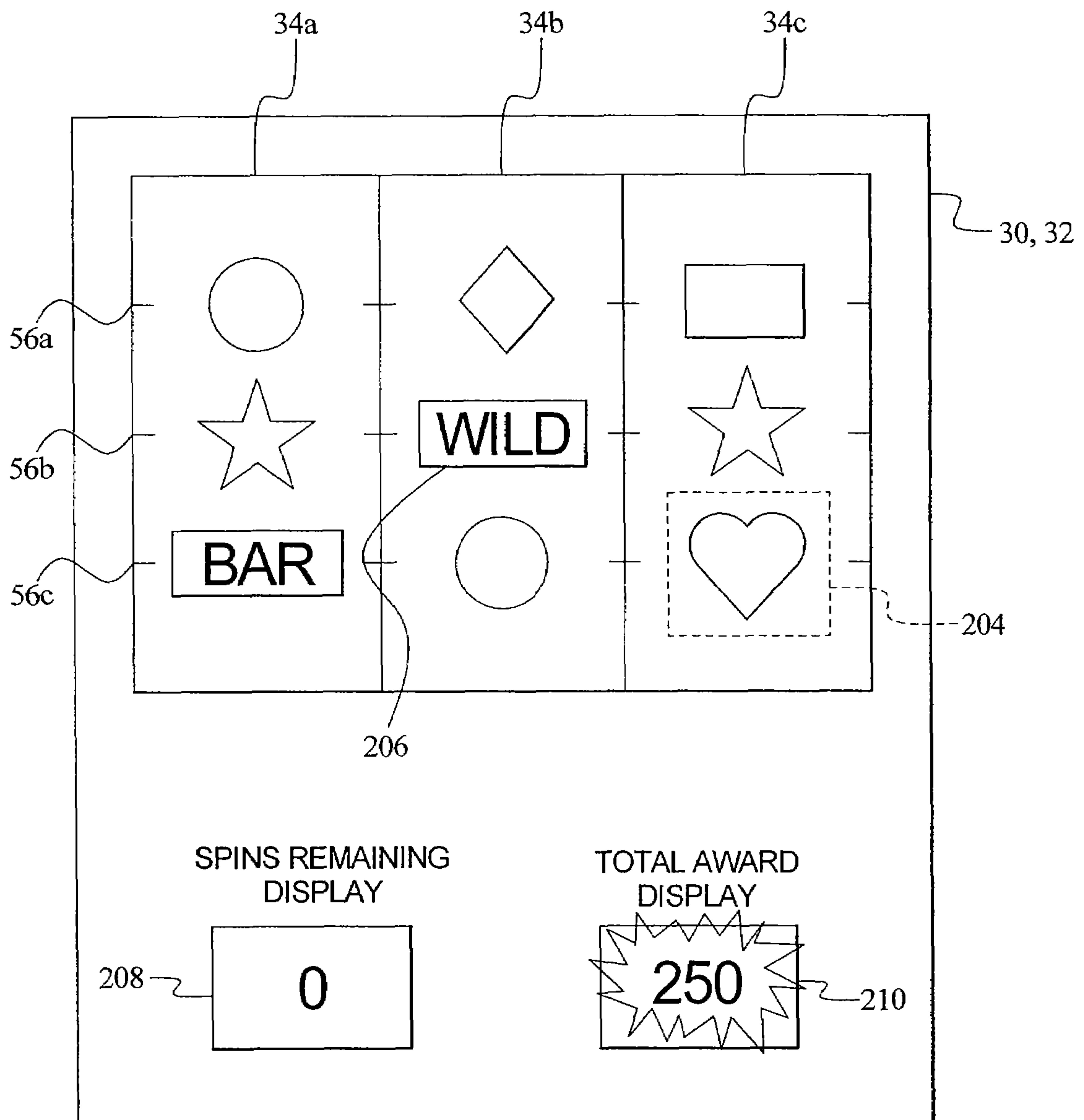


FIG. 15

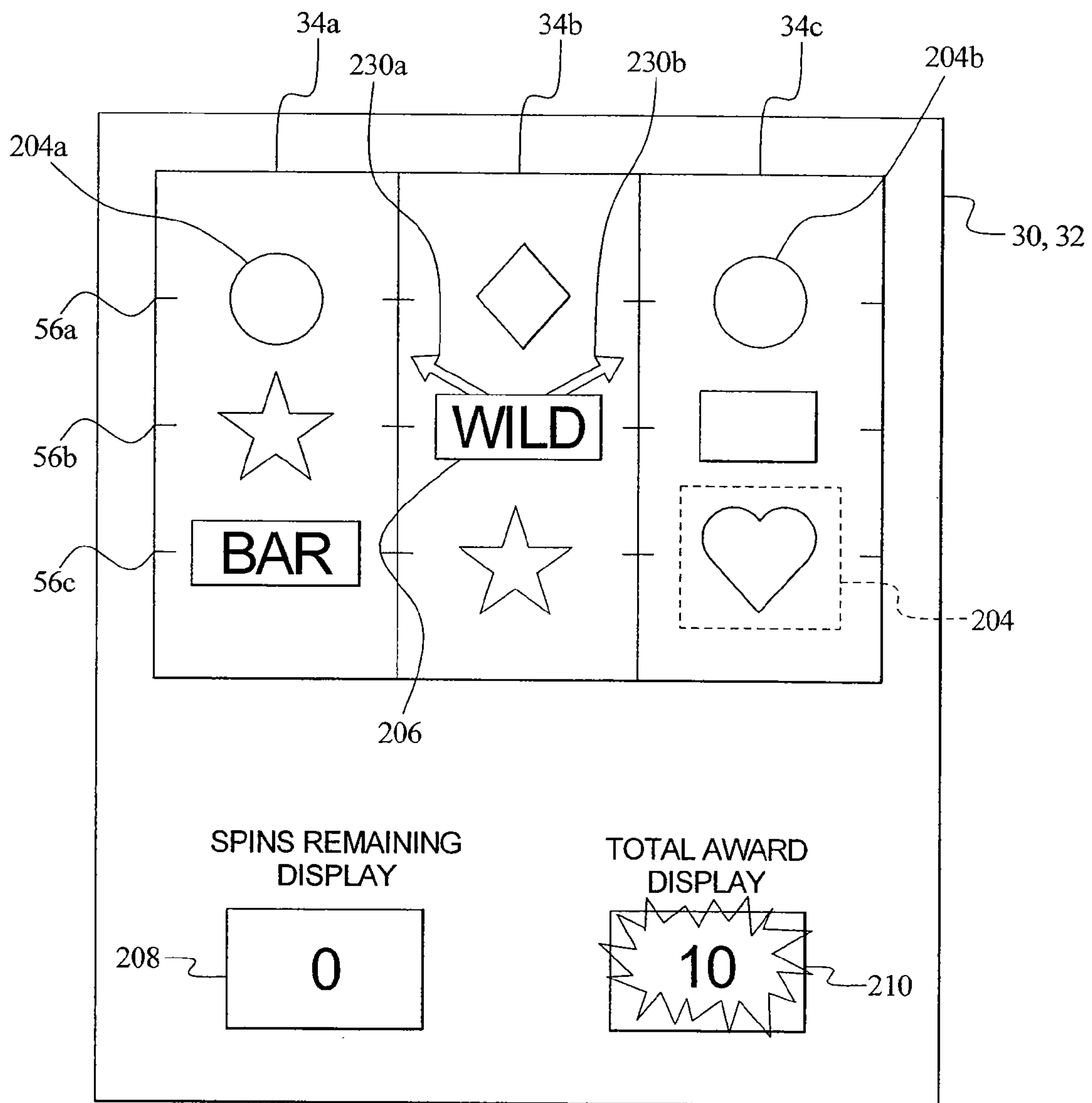
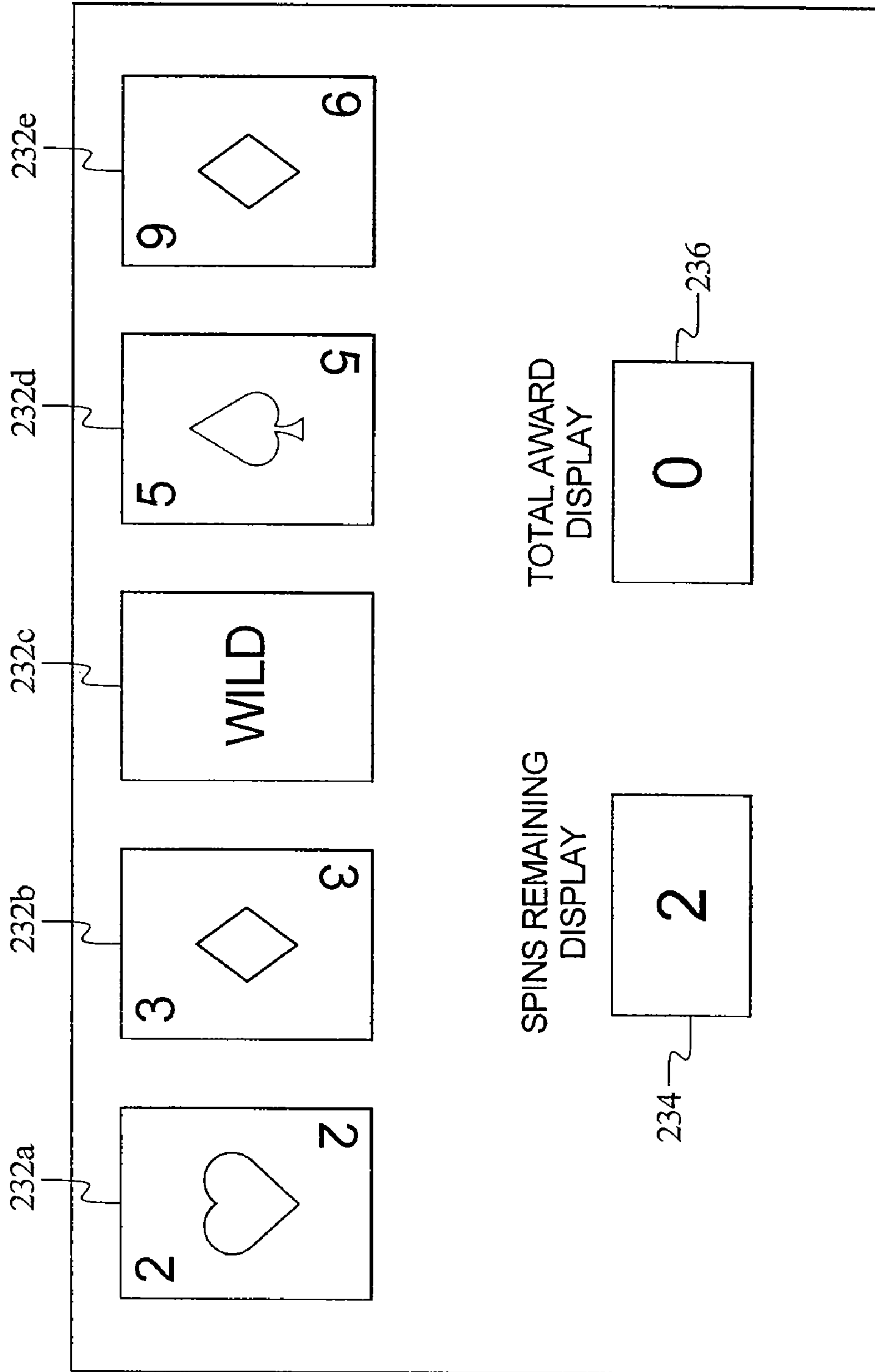


FIG. 16



**GAMING DEVICE INCLUDING A GAME
HAVING A WILD SYMBOL RELATED AWARD**

PRIORITY CLAIM

This application is a continuation of and claims the benefit of U.S. patent application Ser. No. 10/633,391 filed Jul. 31, 2003, now issued U.S. Pat. No. 7,090,580, which is a continuation-in-part of and claims the benefit of U.S. patent application Ser. No. 10/241,255 filed Sep. 11, 2002, now issued U.S. Pat. No. 7,056,213, the entire contents of which are incorporated herein.

This application is related to the following commonly-owned co-pending patent applications: "GAMING DEVICE HAVING FREE GAMES BONUS WITH A CHANGING MULTIPLIER," Ser. No. 10/086,146, "GAMING DEVICE HAVING A BONUS GAME WITH MULTIPLE PLAYER SELECTABLE AWARD OPPORTUNITIES," Ser. No. 10/237,207, "GAMING DEVICE HAVING EXTENDER SYMBOLS," Ser. No. 10/191,197, "GAMING DEVICE HAVING A BONUS GAME WITH MULTIPLE PLAYER SELECTABLE AWARD OPPORTUNITIES," Ser. No. 10/660,076, "GAMING DEVICE HAVING SEQUENTIAL ACTIVATIONS OF A GAME AND REPLAY OF PREVIOUS ACTIVATIONS OF THE GAME," Ser. No. 10/956,508, "GAMING DEVICE WITH CHANGING WILD SYMBOLS," Ser. No. 10/956,303, "GAMING DEVICE HAVING FREE SPIN MODE WITH SYMBOL ELIMINATION," Ser. No. 10/953,818, "GAMING DEVICE HAVING A RE-TRIGGERING SYMBOL BONUS SCHEME WITH A BONUS SYMBOL ACCUMULATOR AND PLAYER SELECTION OF ACCUMULATION TOTAL," Ser. No. 10/952,656, "GAMING DEVICE HAVING TRANSFORMABLE WILD SYMBOLS OR CARDS WITH WILD SIGNAL INDICATORS," Ser. No. 10/920,798, "GAMING DEVICE HAVING WILD INDICATORS," Ser. No. 11/015,842, "GAMING DEVICE HAVING WILD INDICATORS," Ser. No. 10/982,096, "GAMING DEVICE WITH WILD ACTIVATION SYMBOLS AND WILD TERMINATION SYMBOLS," Ser. No. 10/966,223, "GAMING DEVICE HAVING A RE-TRIGGER SYMBOL BONUS SCHEME," Ser. No. 11/156,112, "GAMING DEVICE HAVING A FREE SPIN GAME INCLUDING AN ACCUMULATED MODIFIER," Ser. No. 11/216,323, "GAMING DEVICE AND METHOD HAVING FREE ACTIVATION MODE AND FREE ACTIVATION MODE WITH FREE ACTIVATION RE-TRIGGER," Ser. No. 11/217,182, "GAMING DEVICE HAVING A PROBABILITY ENHANCING TRIGGER SYMBOL," Ser. No. 11/419,681, "GAMING DEVICE HAVING A PROBABILITY ENHANCING TRIGGER SYMBOL," Ser. No. 11/419,680, "GAMING DEVICE INCLUDING A GAME HAVING A WILD SYMBOL RELATED AWARD," Ser. No. 11/463,815, "GAMING DEVICE INCLUDING A GAME HAVING A WILD SYMBOL RELATED AWARD," Ser. No. 11/463,818, "GAMING DEVICE HAVING A FREE SPIN GAME," Ser. No. 11/459,872, "GAMING DEVICE HAVING A PROBABILITY ENHANCING TRIGGER SYMBOL," Ser. No. 11/456,016, and "GAMING DEVICE HAVING A FREE SPIN GAME," Ser. No. 11/465,734,

COPYRIGHT NOTICE

A portion of the disclosure of this patent document contains or may contain material which is subject to copyright protection. The copyright owner has no objection to the photocopy reproduction by anyone of the patent document or the

patent disclosure in exactly the form it appears in the Patent and Trademark Office patent file or records, but otherwise reserves all copyright rights whatsoever.

BACKGROUND OF THE INVENTION

Gaming device manufacturers strive to make gaming devices that provide as much enjoyment and excitement as possible. Providing a game in which a player has an opportunity to win potentially large awards or credits is one way to enhance player enjoyment and excitement.

Currently, gaming machines or devices provide games wherein a player has one or more opportunities to obtain a winning symbol combination on mechanical or video reels. The winning symbol combination may be along the same payline or on different paylines (known as a scatter pay). By providing gaming devices with more winning symbol combinations, players have more opportunities to receive an award.

In known gaming devices, however, the probability of obtaining the largest award (i.e., the jackpot award) is typically much lower than the probability of obtaining the other awards in a game. Thus, although a player may obtain more awards in a game, these awards are generally the relatively small awards and not the relatively large awards such as the jackpot award.

Many jurisdictions have regulations that prohibit changing the probability of occurrence associated with the reel symbols. This makes it more difficult to create bonus or secondary games with high payouts using the bonus game reels and reel symbols.

Additionally, many known gaming devices provide wild symbols or wild cards to enhance a player's opportunity of receiving awards in a game. In a reel game, wild symbols provide a player with an additional opportunity or opportunities to obtain winning symbol combinations on the reels. Therefore, wild symbols, wild cards and wild indicators in gaming devices provide additional excitement and entertainment for players.

In a slot machine having reels, a wild symbol can enable the matching of one or more symbols on a payline to achieve a symbol combination. For example in FIG. 8, a gaming device including a game having three reels is displayed to a player. In the game, a winning combination of symbols includes three matching symbols in the game. As illustrated in FIG. 8, in one of the activations or spins of the reels, a star symbol, a wild symbol and a circle symbol are indicated on the reels. The wild symbol matches one of the symbols on the same payline, payline 56b, as the wild symbol. Therefore, the indicated symbol combination on payline 56b is either two star symbols or two circle symbols. In this example, neither of these symbol combinations are winning symbol combinations. Therefore, the player obtained a wild symbol on the reels but did not obtain a winning symbol combination in the game as indicated by the game display 200 and the total award display 202. Because the probability of obtaining a winning symbol combination increases when a wild symbol occurs on one or more of the reels in a game, a player's excitement and enjoyment also increases in the game. However, when the player does not obtain a winning symbol combination after obtaining a wild symbol in the game, the player's excitement level decreases. Therefore, a game that provides additional award opportunities related to a wild symbol is desirable.

Gaming devices that increase the probability of obtaining the relatively large award and specifically, the jackpot award, are desirable. Additionally, gaming devices that increase the opportunities of obtaining an award or awards in a game are

desirable. To increase player enjoyment and excitement, it is desirable to provide new games and gaming devices which increase the likelihood or probability that the player will obtain one or more awards in a game and specifically, one or more relatively large awards in a game.

SUMMARY OF THE INVENTION

The present invention is directed to a gaming device including an award mode of a primary game or bonus game where the probability of obtaining an award and specifically, a relatively large award increases when the player enters the award mode or bonus game.

In one embodiment, the gaming device includes a plurality of reels, each having a plurality of symbols. These symbols include a plurality of award symbols, at least one non-award symbol or null symbol or blank, at least one trigger symbol or symbol combination and at least one wild symbol. One or more paylines are associated with the reels to indicate symbols or symbol combinations on the reels, which are evaluated for winning symbol combinations. The symbols may be any suitable symbols such as letters, numbers, characters or any other suitable images. The award mode also includes a triggering event, which in one embodiment, includes a trigger symbol occurring on the reels. In one embodiment, the triggering event occurs when the trigger symbol is indicated on a designated reel on one of the paylines associated with the reels. In another embodiment, the triggering event occurs when the trigger symbol occurs on any of the paylines.

In a primary game, the gaming device initiates the award mode when the triggering event occurs in the game. In the award mode, the gaming device holds the reel including the trigger symbol stationary while activating or spinning the other reels until those reels indicate a wild symbol on the payline. The gaming device then holds the reels including the wild symbols stationary while reactivating or re-spinning the reel including the trigger symbol. Thus, the award mode effectively reduces the game to a single reel game where only one of the award symbols on the reel indicates a winning symbol combination in the award mode.

In the award mode, the gaming device re-activates or re-spins the reel including the trigger symbol until one of the award symbols is indicated on the payline on that reel. For instance, if a non-award or null symbol, or the trigger symbol is indicated on the payline in the award mode, the gaming device re-spins the reel until one of the award symbols or the wild symbol is indicated on the payline. The null symbols and the trigger symbol do not provide an award to the player in the award mode, but instead cause the gaming device to re-spin the reels. Therefore, the player is guaranteed to receive one of the award symbols or the wild symbol in the award mode before the award mode ends. Reducing the number of symbols that may be indicated on the payline to end the game, increases the probability that any one of the award symbols will be indicated on the payline. The gaming device then provides the award associated with the indicated award symbol or the indicated award symbol combination to the player. The award is added to the player's total award in a total award display and the bonus mode ends. In another embodiment, the player continues to re-activate the reels in the award mode if the player has spins remaining in the award mode.

The gaming device of the present invention effectively reduces the game to a single reel game or event which increases the probability or chance that a player will obtain an award in the award mode and specifically that the player will obtain a relatively large award such as jackpot award in the award mode. For example, in a three reel slot game, if each of

the reels in the game includes twenty symbols including the trigger symbol, wild symbol and non-award or null symbols, the probability or chance of obtaining an award symbol combination in that game is $(1/20) \times (1/20) \times (1/20)$ or 1 in 8000.

In the award mode the game is reduced to a single reel game as described above. Therefore, the probability of obtaining an award symbol (or symbol combination) in the award mode significantly increases. The probability is determined by multiplying the probability of the trigger symbol being indicated in the primary game (i.e., 1 in 20) by the probability of indicating one of the award symbols occurring in the award mode (i.e., 1 in 9). Therefore, the probability of one of the award symbols (or symbol combinations) being indicated in the game (through the award mode) is $(1/20) \times (1/9)$, which equals a probability of $(1/180)$. Thus, it is significantly more likely that the player will obtain one of the award symbols and therefore a winning award symbol combination in game through the award mode. This increases the player's excitement and enjoyment of the game because the player has a greater opportunity or probability of obtaining the relatively large award or jackpot award in the award mode.

In one embodiment, a probability of being indicated on the payline is associated with each of the symbols on the reels. In one aspect of this embodiment, the probability associated with the trigger symbol is less than the probability associated with at least one of the award symbols, null symbols and the wild symbol on the reels. In another aspect of this embodiment, the probability associated with the trigger symbol is less than a plurality of the probabilities associated with the award symbols, null symbols and the wild symbol. In a further aspect of this embodiment, the probability associated with the trigger symbol is less than all of the probabilities associated with the award symbols, null symbols and the wild symbol in the game.

Similarly in another embodiment, the award symbols include one relatively large award and several relatively small awards. In this embodiment, a probability of being indicated on the payline is associated with the award symbols such that the probability associated with the award symbol including the relatively large award is less than at least one of the probabilities associated with the award symbols including the relatively small awards being indicated on the payline. In another embodiment, the probability associated with the award symbol including the relatively large award is less than a plurality of the probabilities associated with the award symbols including the relatively small awards. In a further embodiment, the probability associated with the award symbol including the relatively large award is less than all of the probabilities associated with the award symbols including the relatively small awards.

In a further embodiment, the award mode of the present invention includes an award associated with a winning symbol combination including all wild symbols. In this embodiment, if the award mode is initiated and a wild symbol is indicated on the payline associated with the reels, in combination with the other wild symbols indicated on the payline, the gaming device provides the maximum or largest award in the game, such as the jackpot award. In another embodiment, the gaming device provides a predetermined award associated with a winning symbol combination including wild symbols in the game.

In an alternative embodiment, the gaming device includes a game which displays a plurality of reels to a player. The reels include a plurality of symbols having at least one trigger symbol such as a wild symbol. The gaming device activates or spins the reels for at least one activation or spin in a game and indicates a combination of symbols on the reels. If the symbol

5

combination indicated on the reels includes a wild symbol but is not a winning symbol combination in the game, the gaming device holds the reel including the wild symbol stationary. The gaming device then provides the player with a designated number of activations or spins to re-spin at least one of the reels other than the held reel in the game. The designated number of activations or spins may be predetermined, randomly determined, determined based on a wager made by a player or determined according to any suitable determination method in a game. The wild symbol and the symbol combinations may be indicated on one payline associated with the reels, a plurality of paylines associated with the reels or on all of the paylines associated with the reels.

In one embodiment, the gaming device re-activates or re-spins the reel or reels other than the reel including the wild symbol until a winning symbol combination is indicated on the reels or until there are no spins remaining in the game. In another embodiment, the gaming device re-activates or re-spins the reel or reels other than the reel including the wild symbol until a winning symbol combination is indicated on the reels. In a further embodiment, the gaming device re-activates or re-spins the reel or reels other than the reel including the wild symbol until there are no spins remaining in the game. In this embodiment, the gaming device provides the awards to the player associated with any winning symbol combinations that occur on the reels during the designated number of activations or spins of the reels.

In another alternative embodiment, if the symbol combination indicated on the reels includes a wild symbol but does not indicate a winning symbol combination having an award amount equal to or greater than a designated award amount in the game, the gaming device holds the reel including the wild symbol stationary. The gaming device then provides the player with a designated number of activations or spins to re-spin at least one of the reels other than the held reel in the game as described above. The gaming device then provides the player with an award or awards associated with any winning symbol combinations indicated on the reels in the game. The designated award amount may be an award value or values or any other suitable award level in the game. In addition, the designated award amount may be predetermined, randomly determined, determined based on a wager made by the player in the game or determined according to any suitable determination method.

In a further alternative embodiment, the present invention provides a gaming device including a free spins game which displays a plurality of reels to a player. The reels include a plurality of symbols where the symbols include at least one trigger symbol such as a wild symbol. The gaming device also provides a designated number of activations or spins of the reels in the game. The gaming device activates or spins the reels to indicate the symbols on the reels. If a wild symbol is indicated on the reels such as on a payline associated with the reels and no winning symbol combinations are indicated on the same payline as the wild symbol, the gaming device freezes or holds the reel including the wild symbol stationary. The gaming device then re-activates or re-spins the other reels, not including the reel including the wild symbol, to indicate symbols in the game. The gaming device continues to activate the other reels in the game for the remaining number of spins in the game until a winning symbol combination, if any, is indicated on the payline associated with the reels. The gaming device then provides an award associated with the winning symbol combination to the player. The game ends when there are no spins remaining in the game, the gaming device provides the player with the total award indicated in a total award display.

6

In another embodiment of the present invention, the gaming device freezes or holds the reel including the wild symbol stationary when the wild symbol is indicated on a payline associated with the reels and the award amounts associated with any winning symbol combinations indicated on the payline are less than a designated award amount. Thus, the gaming device ensures that if the player does obtain a winning symbol combination in the game, the award associated with that winning symbol combination will be equal to or greater than a designated minimum award or award amount in the game. The designated award amount may be any suitable level desired by game implementor.

In this embodiment, the gaming device activates or spins the reels for a designated number of spins in the game. If a wild symbol is indicated on a payline associated with the reels and the award value or amount associated with any indicated winning symbol combinations on the payline are less than the designated award value, the gaming device freezes or holds the reel including the wild symbol and enables the player to have an opportunity to obtain an award associated with a winning symbol combination in the game that is equal to or greater than the designated award value or amount. The gaming device continues to activate the reels, other than the reel including the wild symbol, to indicate symbols and possibly winning symbol combinations in the game. The gaming device then provides any awards associated with winning symbol combinations including the wild symbol on the payline that are equal to or greater than the designated award amount. The gaming device then transfers those awards to the total award display. When there are no spins remaining in the game, the game ends and the gaming device provides the total award to the player.

In a further alternative embodiment, the gaming device provides an award or awards to a player for any winning symbol combinations including the wild symbol which are located on any of the paylines associated with the reels (i.e., a scatter pay combination). In one embodiment, the winning symbol combination includes the wild symbol and any symbols located on the reels not including the wild symbol. In another embodiment, the winning symbol combination includes the wild symbol and any symbols included on any of the reels including the reel having the wild symbol. Thus, the gaming device provides the player with more opportunities to obtain a winning combination of symbols including the wild symbol in the game and thereby increases the player's chance of obtaining an award in the game.

In another alternative embodiment, one or more symbol indicators are associated with the wild symbol. In this embodiment, when the wild symbol is indicated on the reels, the reel including the wild symbol is held stationary while the other reels not including the wild symbol are activated. When the reels not including the wild symbol stop, the symbol indicator or indicators associated with the wild symbol indicate or point to one or more symbols on the reels. The symbol indicator or indicators may point to symbols on different reels or the same reel as the reel including the wild symbol. In one embodiment, the symbol indicator or indicators associated with the wild symbol point to a fixed location or locations on the reels. It should be appreciated that the symbol indicators may indicate or point to a randomly selected location on the reels or a designated section on the reels. The symbols indicated by the symbol indicators are combined with the wild symbol to form a symbol combination in an activation. The gaming device provides the player with any awards associated with the formed symbol combination.

In a further alternative embodiment, the symbols on the reels include at least one bonus symbol. If the bonus symbol

is indicated on one or more designated paylines associated with the reels, the gaming device provides a bonus award or an additional award to the player in the game. The bonus award may include at least one free spin of the reels, at least one free game and/or at least one multiplier. It should be appreciated that the bonus award or additional award may be any suitable award as desired by the game implementor. The bonus symbol further enhances the probability that a player will obtain one of the winning symbol combinations in the game.

In another alternative embodiment, a probability of being indicated on a payline associated with the reels is associated with each of the symbols on the reels. In one aspect of this embodiment, the probability associated with the wild symbol is less than the probability associated with at least one of the other symbols on the reels. In another aspect of this embodiment, the probability associated with the wild symbol is less than the probability associated with a plurality of the other symbols on the reels. In a further aspect of this embodiment, the probability associated with the wild symbol is less than all of the probabilities associated with the other symbols on the reels.

In a further alternative embodiment, the present invention is employed in a card game. In this embodiment, the gaming device displays a plurality of cards to a player in a game. The cards include a plurality of symbols including at least one trigger symbol such as a wild symbol. The symbols may be numbers, colors, letters, playing card suits, characters or any suitable image. In a game, the gaming device displays the cards in one or more rounds to the player. If a wild symbol appears on one of the cards and there is not a winning combination of cards, the gaming device holds the card including the wild symbol. The gaming device then replaces at least one of the cards not including the wild symbol for a designated number of rounds until a winning combination of cards are indicated or until there are no rounds remaining in the game. In another embodiment, the gaming device continues to replace at least one of the cards not including the wild symbol until a winning combination of cards are indicated. The gaming device then provides the player with the award associated with the winning combination of cards. In a further embodiment, the gaming device holds the card including the wild symbol when no winning combination of cards are indicated that include an award amount equal to or greater than a designated award amount in the game.

It should be appreciated that the present invention may be employed in a primary game, a bonus game, a sub-game or any suitable game.

It should also be appreciated that although the present application primarily discusses a trigger symbol, a combination of symbols (i.e., a trigger symbol combination) could be employed to trigger the award mode. It should also be appreciated that the trigger symbol could function as a wild symbol and one of the other reels could re-activated.

It is therefore an advantage of the present invention to provide a gaming device that increases the probability of obtaining awards in a game.

Another advantage of the present invention is to provide a gaming device that increases the probability of obtaining a relatively large award in a game.

It is a further advantage of the present invention to provide a gaming device that increases the probability of obtaining the jackpot award in a game.

Other objects, features and advantages of the invention will be apparent from the following detailed disclosure, taken in

conjunction with the accompanying sheets of drawings, wherein like numerals refer to like parts, elements, components, steps and processes.

BRIEF DESCRIPTION OF THE DRAWINGS

FIG. 1A is a front perspective view of one embodiment of the gaming device of the present invention.

FIG. 1B is a front perspective view of another embodiment of the gaming device of the present invention.

FIG. 1C is an enlarged elevation view of a set of reels and the reel stop positions included on the reels in a three reel slot game.

FIG. 2 is a schematic block diagram of the electronic configuration of one embodiment of the gaming device of the present invention.

FIG. 3A is an enlarged elevation view of one of the display devices of FIGS. 1A and 1B illustrating one embodiment of the present invention.

FIG. 3B is an award table illustrating the symbol combinations and the awards associated with the symbols combinations of the embodiment of FIG. 3A.

FIG. 4A is probability table illustrating the probability of each of the symbols being indicated on each of the reels in a primary game.

FIG. 4B is probability table illustrating the probability of each of the symbols being indicated on each of the reels in an award mode.

FIGS. 5A, 5B, 5C, 5D, 5E and 5F are enlarged front elevation views of an example of the embodiment shown in FIG. 3 illustrating a primary game and an award mode initiated by the occurrence of a triggering event in the primary game.

FIG. 6 is an enlarged elevation view of one of the display devices of FIGS. 1A and 1B illustrating another embodiment of the present invention.

FIG. 7 is an enlarged elevation view of one of the display devices of FIGS. 1A and 1B illustrating a further embodiment of the present invention.

FIG. 8 is an enlarged elevation view of a known game in a gaming device.

FIG. 9 is an enlarged elevation view of an alternative embodiment of the present invention.

FIG. 10A is an enlarged elevation view of an example of the alternative embodiment of the present invention where a wild symbol is indicated on one of the reels.

FIG. 10B is an enlarged elevation view of the example of FIG. 10A where a winning symbol combination is indicated on the reels.

FIG. 11A is an enlarged elevation view of an example of another alternative embodiment of the present invention.

FIG. 11B is an award summary table associated with the embodiment of FIG. 11A.

FIGS. 11C and 11D are enlarged elevation views of the example of the embodiment of FIG. 11A.

FIG. 12 is an enlarged elevation view of a further alternative embodiment of the present invention.

FIG. 13A is an enlarged elevation view of an example of one alternative embodiment of the present invention.

FIG. 13B is award summary table associated with the embodiment of FIG. 13A.

FIGS. 13C, 13D and 13E are enlarged elevation views of the embodiment of FIG. 13A illustrating a game where the gaming device provides a player with three activations of the reels in the game.

FIG. 14A is an enlarged elevation view of an example of another alternative embodiment of the present invention.

FIG. 14B is an award summary table associated with the embodiment of FIG. 15A.

FIGS. 14C, 14D and 14E are enlarged elevation views of the embodiment of FIG. 14A where the gaming device provides three activations of the reels in the game.

FIG. 15 is an enlarged elevation view of another alternative embodiment of the present invention where the wild symbol includes two symbol indicators.

FIG. 16 is an enlarged elevation view of a further alternative embodiment of the present invention where a plurality of cards are displayed to a player.

DETAILED DESCRIPTION OF THE INVENTION

Gaming Device and Electronics

Referring now to the drawings, two embodiments of the gaming device of the present invention are illustrated in FIGS. 1A and 1B as gaming device 10a and gaming device 10b, respectively. Gaming device 10a and/or gaming device 10b are generally referred to herein as gaming device 10. Gaming device 10 is preferably a slot machine having the controls, displays and features of a conventional slot machine. It is constructed so that a player can operate it while standing or sitting, and gaming device 10 is preferably mounted on a console. However, it should be appreciated that gaming device 10 can be constructed as a pub-style table-top game (not shown) which a player can operate preferably while sitting. Furthermore, gaming device 10 can be constructed with varying cabinet and display designs, as illustrated by the designs shown in FIGS. 1A and 1B. Gaming device 10 can also be implemented as a program code stored in a detachable cartridge for operating a hand-held video game device. Also, gaming device 10 can be implemented as a program code stored on a disk or other memory device which a player can use in a desktop or laptop personal computer or other computerized platform.

Gaming device 10 can incorporate any primary game such as slot, black jack, poker or keno, any of the bonus triggering events and any of the bonus round games. The symbols and indicia used on and in gaming device 10 may be in mechanical, electrical, electronic or video form.

As illustrated in FIGS. 1A and 1B, gaming device 10 includes a coin slot 12 and bill acceptor 14 where the player inserts money, coins or tokens. The player can place coins in the coin slot 12 or paper money or ticket vouchers in the bill acceptor 14. Other devices could be used for accepting payment such as readers or validators for credit cards or debit cards. When a player inserts money in gaming device 10, a number of credits corresponding to the amount deposited is shown in a credit display 16. After depositing the appropriate amount of money, a player can begin the game by pulling arm 18 or pushing play button 20. Play button 20 can be any play activator used by the player which starts any game or sequence of events in the gaming device.

As shown in FIGS. 1A and 1B, gaming device 10 also includes a bet display 22 and a bet one button 24. The player places a bet by pushing the bet one button 24. The player can increase the bet by one credit each time the player pushes the bet one button 24. When the player pushes the bet one button 24, the number of credits shown in the credit display 16 decreases by one, and the number of credits shown in the bet display 22 increases by one.

A player may cash out and thereby receive a number of coins corresponding to the number of remaining credits by pushing a cash out button 26. When the player cashes out, the player receives the coins in a coin payout tray 28. The gaming

device 10 may employ other payout mechanisms such as credit slips redeemable by a cashier or electronically recordable cards which keep track of the player's credits.

Gaming device 10 also includes one or more display devices. The embodiment shown in FIG. 1A includes a central display device 30, and the alternative embodiment shown in FIG. 1B includes a central display device 30 as well as an upper display device 32. Gaming device 10 displays a plurality of reels 34 such as three to five reels 34 in mechanical or video form at one or more of the display devices. A display device can be any viewing surface such as glass, a video monitor or screen, a liquid crystal display or any other display mechanism. If the reels 34 are in video form, the display device for the video reels 34 is preferably a video monitor.

Each reel 34 displays a plurality of indicia such as bells, hearts, fruits, numbers, letters, bars or other images, which preferably correspond to a theme associated with the gaming device 10. Furthermore, gaming device 10 preferably includes speakers 36 for making sounds or playing music.

As illustrated in FIG. 2, the general electronic configuration of gaming device 10 preferably includes: a processor 38; a memory device 40 for storing program code or other data; a central display device 30; an upper display device 32; a sound card 42; a plurality of speakers 36; and one or more input devices 44. The processor 38 is preferably a microprocessor or microcontroller-based platform which is capable of displaying images, symbols and other indicia such as images of people, characters, places, things and faces of cards. The memory device 40 can include random access memory (RAM) 46 for storing event data or other data generated or used during a particular game. The memory device 40 can also include read only memory (ROM) 48 for storing program code which controls the gaming device 10 so that it plays a particular game in accordance with applicable game rules and pay tables.

As illustrated in FIG. 2, the player preferably uses the input devices 44, such as pull arm 18, play button 20, the bet one button 24 and the cash out button 26 to input signals into gaming device 10. In certain instances it is preferable to use a touch screen 50 and an associated touch screen controller 52 instead of a conventional video monitor display device. Touch screen 50 and touch screen controller 52 are connected to a video controller 54 and processor 38. A player can make decisions and input signals into the gaming device 10 by touching touch screen 50 at the appropriate places. As further illustrated in FIG. 2, the processor 38 can be connected to coin slot 12 or bill acceptor 14. The processor 38 can be programmed to require a player to deposit a certain amount of money in order to start the game.

It should be appreciated that although a processor 38 and memory device 40 are preferable implementations of the present invention, the present invention can also be implemented using one or more application-specific integrated circuits (ASIC's) or other hard-wired devices, or using mechanical devices (collectively or alternatively referred to herein as a "processor"). Furthermore, although the processor 38 and memory device 40 preferably reside on each gaming device 10 unit, it is possible to provide some or all of their functions at a central location such as a network server for communication to a playing station such as over a local area network (LAN), wide area network (WAN), Internet connection, microwave link, and the like. The processor 38 and memory device 40 is generally referred to herein as the "computer" or "controller."

With reference to FIGS. 1A, 1B and 2, to operate the gaming device 10 in one embodiment the player must insert the appropriate amount of money or tokens at coin slot 12 or

bill acceptor **14** and then pull the arm **18** or push the play button **20**. The reels **34** will then begin to spin. Eventually, the reels **34** will come to a stop. As long as the player has credits remaining, the player can spin the reels **34** again. Depending upon where the reels **34** stop, the player may or may not win additional credits.

In addition to winning credits in this manner, gaming device **10** also gives players the opportunity to win credits in a bonus round. This type of gaming device **10** will include a program which will automatically initiates a bonus round when the player has achieved a qualifying condition in the game. This qualifying condition can be a particular arrangement of indicia on a display device. The gaming device **10** preferably uses a video-based central display device **30** to enable the player to play the bonus round. Preferably, the qualifying condition is a predetermined combination of indicia appearing on one or more of a plurality of the reels **34**. As illustrated in the five reel slot game shown in FIGS. **1A** and **1B**, the qualifying condition could be the number seven appearing on three adjacent reels **34** along a payline **56**. It should be appreciated that the present invention can include one or more paylines, such as payline **56**, wherein the paylines can be horizontal, diagonal or any combination thereof.

Probability Enhancing Trigger Symbol

Referring to FIGS. **1C**, **3A**, **3B**, **4A** and **4B**, one embodiment of the reels of the present invention is illustrated where three reels are employed in a game. It should be appreciated that any suitable number of reels may be employed in the primary game. In this embodiment, each of the reels **34a**, **34b** and **34c** includes symbols **100**, which are represented by letters A, B, C, D, E, F, G and H, non-award or null symbols or blanks **104**, at least one trigger symbol **102** and at least one wild symbol **105**. It should be appreciated that any suitable number and types of symbols may be employed in a game according to the present invention. Each symbol is positioned at a reel stop position or reel stop on each of the reels. Therefore, one of the symbols such as one of the award symbols, one of the null symbols, the trigger symbol or the wild symbol will be indicated on a payline in the game.

Referring to FIG. **3A**, in one embodiment the gaming device displays a plurality of reels and specifically three reels **34a**, **34b** and **34c**. The reels include a plurality of symbols such as the letters A, B, C, D, E, F, G and H. The reels also include at least one trigger symbol, such as a diamond symbol **102**. It should be appreciated that one or more of the reels may include at least one trigger symbol. Additionally, each of the reels includes at least one wild symbol **105** and at least one null symbol or blank **104**. A probability of being indicated is associated with each of the symbols on the reels. In the primary game, the probability of each of the symbols being indicated on one of the reels is one in twenty (1/20) or 5.0% as shown in the probability table illustrated in FIG. **4A**. If a triggering event occurs in the primary game, an award mode is initiated. In the award mode, the primary game is effectively reduced to a one-reel game. In addition, the null symbols **104** or blanks, and the trigger symbol, each re-spin or re-activate the reels. Thus, the effective number of symbols on the reels is reduced from twenty symbols to nine symbols, which further increases the probability that one of the symbols will be indicated on the reels. Several paylines, such as paylines **56a**, **56b** and **56c** are associated with the reels. It should be appreciated that one or more paylines may be associated with the reels. A spins remaining display **106** indicates the number of spins remaining in the game. A total

award display indicates the total value of the awards accumulated by the player in the game.

The gaming device provides the player with a number of spins in the game. The number of spins may be randomly determined, predetermined or determined in any suitable manner. The player uses the spins to activate or spin the reels **34a**, **34b** and **34c**. The gaming device provides an award associated with one or more winning symbol combinations indicated on one of the paylines **56a**, **56b** or **56c** associated with the reels. The player continues to spin the reels until the player has no spins remaining as indicated by the spins remaining display **106**.

The trigger symbol or diamond symbol **102** increases the probability that the player will obtain one of the awards in the game and specifically increases the probability that the player will obtain the largest award such as the jackpot award in the game. The game preferably includes only one trigger symbol, designated as a diamond symbol **102**, on one of the reels **34** in the game. In one embodiment, the middle reel **34b**, includes the trigger symbol or diamond symbol **102**. If the diamond symbol **102** is indicated on one of the paylines **56a**, **56b** or **56c**, the gaming device initiates an award mode. In the award mode, the gaming device freezes or holds the reel **34b** including the trigger symbol **102** stationary while the gaming device activates or spins the remaining reels or outside reels **34a** and **34c**, which are adjacent to the middle reel **34b**. The gaming device activates or spins these reels until a wild symbol **105** is indicated on the same payline as the trigger symbol or diamond symbol **102**.

Once the wild symbols **105** are indicated on reels **34a** and **34c** and on the same payline as the trigger symbol **102**, the gaming device holds or keeps these reels stationary. The symbols on payline **56b** are wild symbol **105a** on reel **34a**, trigger symbol or diamond symbol **102** on reel **34b** and wild symbol **105b** on reel **34c**. The gaming device now re-spins or re-activates reel **34b** until an award symbol such as one of the letters is indicated on payline **56b**. Any award symbol **100** indicated on that payline will provide a symbol combination having three identical symbols matching the award symbol **100** indicated on that payline. This occurs because two of the symbols on that payline are the wild symbols **105a** and **105b** as illustrated in FIG. **5C**. Because only the middle reel **34b** is re-activated or re-spun during the game to determine the award, the game is reduced to a one reel or single reel game. The player now only needs to obtain one award symbol to win an award in the award mode. More specifically, the player only has to spin one reel **34b** to obtain the largest award such as the jackpot award in the game. Thus, because the award mode reduced the game to a one reel or single reel game, the probability of obtaining any of the awards, and specifically the largest award in the game, increases significantly.

In the award mode, when the middle reel **34b** is re-activated and the trigger symbol or diamond symbol **102** is indicated on payline **56b**, the gaming device re-spins or re-activates reel **34b**. Thus in one embodiment, the trigger symbol or diamond symbol does not provide an award to the player in the game. In another embodiment, an award is associated with the trigger symbol and is provided to the player if the trigger symbol is indicated on the reel after the reel is re-activated in the award mode.

Similarly, if a non-award or null symbol (i.e., blank) **104** is indicated on payline **56b** on reel **34b**, the gaming device re-spins or re-activates reel **34b**. Thus, a null symbol does not provide an award to the player; rather, the reels are re-spun to give the player another opportunity to obtain one of the awards in the game. Once an award symbol **100** is indicated on the designated payline on reel **34b**, the gaming device

provides an award associated with the award combination including those symbols. If the award symbol happens to be the jackpot symbol, the player obtains three of the jackpot symbols and therefore, the jackpot award in the game. The award received by the player in the game is transferred to the total award display **108** and provided to the player when the game ends. In one embodiment, the game ends when the player obtains an award in the game. In another embodiment, the game ends when the player runs out of spins as indicated by the spins remaining display **106**.

In a further embodiment, the gaming device includes a modifier such as a multiplier which changes such as by increasing when the null symbol occurs on the reel. The modifier such as the multiplier is employed in one embodiment to increase the award determined by the generated symbol on the reel.

By effectively reducing the game to a single reel or one reel game, the present invention significantly increases the probability of obtaining an award in the game without changing the random probability of occurrence. In particular, the present invention increases the probability or the likelihood that the player will obtain the largest award such as the jackpot award in the game. For example, in a typical reel-type game, a player must obtain one of a plurality of designated symbol combinations on one or more of the paylines associated with a set of reels to obtain an award in the game. The gaming device or player spins the reels and the reels randomly indicate symbols on one or more of the paylines associated with the reels. If a winning symbol combination is indicated on one of the designated winning paylines in the game, the gaming device provides an award associated with that winning symbol combination. The probability of obtaining a particular symbol combination, however, is based on the number of reels in a game and the number of symbols included on those reels. Thus, the more reels and symbols in a game, the less likely or less probable it is that the player will obtain one of the winning symbol combinations in that game.

For example, a particular game of the gaming device may include three reels, such as reels **34a**, **34b** and **34c** in FIG. **3A**. In this example, each of the reels includes twenty reel positions, which include nine award symbols as symbols A, B, C, D, E, F, G, and H, one wild symbol, one trigger symbol and ten null symbols. In this example, the symbols must occur or be indicated on payline **56b** to provide a winning symbol combination in the game. Thus, at the beginning of the game each symbol has a 5% (1/20) chance or probability of being indicated on payline **56b** on each of the reels as illustrated in FIG. **4A**. As a result, the overall probability that a particular symbol combination will occur on that payline is $(1/20) \times (1/20) \times (1/20)$, which equals $(1/8000)$ or 0.013%. Therefore, in this example, because each symbol has a 5% (1/20) chance or probability of being indicated on a single payline on the reels, the overall probability of a particular symbol combination occurring on that payline in the primary game (without the award mode) is $(1/8000)$ or 0.013%.

Referring to FIG. **3B**, an example of a payout or award table is illustrated. In this example, a winning symbol combination in the primary game includes three identical symbols. For instance, the jackpot award or largest award indicated on the table is the award of ten thousand associated with the symbol combination including three A symbols (i.e., A, A, A). The award associated with the other winning symbol combinations are also shown in the table. It should be appreciated that any suitable combination of symbols in a game may be designated as a winning symbol combination.

Referring to FIG. **4A**, a probability table for a primary game or base game indicates the probability of each of the

symbols being indicated on a payline for each reel in the three reel slot game shown in FIG. **3A**. The table also indicates the probability of being indicated on a payline associated with each of the winning symbol combinations shown in FIG. **3B** for each of the symbols on the reels and the probability of three null symbols or blanks being indicated on the payline. As illustrated in the table, the probability of each of the award symbols (i.e., A, B, C, D, E, F, G and H) being indicated on any one of the reels is (1/20). The probability of a winning symbol combination including one of the award symbols, the trigger symbol or the wild symbol, being indicated on the designated payline is $(1/8000)$ (i.e., $(1/20) \times (1/20) \times (1/20)$). The probability of three null symbols or blanks being indicated on the payline is $((10/20) \times (10/20) \times (10/20))$ or (1/8). Therefore, a player has a one in eight thousand chance in the primary game to obtain one of the winning symbol combinations, and specifically of obtaining the jackpot award in the game.

In the award mode of the present invention, the number of reels is effectively reduced to one reel or one active reel such as reel **34b**. As a result, the probability of obtaining a particular symbol or a particular symbol combination increases significantly. Referring to FIG. **4B**, a probability table illustrates the probabilities of each of the symbols being indicated on the reel in the award mode. Additionally, the table illustrates the probability of a winning symbol combination, which in the award mode is one award symbol, being indicated on the payline in the award mode. Because the trigger symbol and the null symbols cause the reel to re-spin in the award mode, the number of effective award symbols in the award mode is reduced to nine. Therefore, the probability of each of the award symbols or the wild symbol being indicated on the payline in the game (through the award mode) is $(1/180)$, which is the probability of the trigger symbol being indicated on the payline in the primary game (1/20) multiplied by the probability of any one of the award symbols or the wild symbol being indicated on the payline in the award mode, which is (1/9). The probability of one of the award symbols or the wild symbol being indicated in the game (through the award mode) is therefore, $(1/20) \times (1/9)$ or $(1/180)$ as shown in FIG. **4B**. Accordingly, the overall probability of obtaining a specific symbol combination is $(0.013\% (1/8000) + 0.56\% (1/180))$ which equal 0.573%.

Referring to FIG. **3A**, in one example of the award mode of the present invention, if a trigger symbol or diamond symbol **102** is indicated on payline **56b** in a primary game, an award mode is initiated and the outside reels **34a** and **34c** are re-activated or re-spun until wild symbols are indicated on payline **56b**. Then, the reels **34a** and **34c** are held stationary while the middle reel **34b** is re-activated or re-spun until an award symbol is indicated on payline **56b**. The probability or likelihood of obtaining a particular symbol combination on the reels has now increased because the player only has to obtain one award symbol on reel **34b** in order to obtain an award in the game.

In this example, the middle reel **34b** includes twenty reel positions including eight award symbols, one wild symbol, a trigger symbol or diamond symbol **102**, and ten null symbols **104** as shown in FIGS. **1C** and **3A**. Therefore, the player initially has a one in twenty chance of obtaining the trigger symbol or diamond symbol **102** on reel **34b** in the primary game as described above. In the award mode, if the player obtains the trigger symbol **102** or one of the null symbols **104** on payline **56b** after the reel **34b** is re-activated, the gaming device re-spins or re-activates reel **34b** again until an award symbol **100** is indicated on payline **56b**. Because the trigger symbol **102** and the null symbols **104** re-spin or re-activate the

reels in the award mode, the actual number of symbols that provide an award and end the bonus mode are nine (i.e., the eight award symbols and the wild symbol). Therefore, the player has a one in nine chance of obtaining an award symbol **100** in the award mode and thereby a 11.1% chance of obtaining a winning symbol combination on payline **56b**. As a result, the overall probability of obtaining a winning symbol combination on the reels in the award mode is determined by taking the probability of obtaining the trigger symbol or diamond symbol **102** on reel **34b** in the initial or primary game, which is 1 in 20 (1/20), multiplied by the probability or the likelihood of one of the award symbols being indicated on payline **56b**, which is 1 in 9 (1/9). The overall probability therefore equals (1/180) or 0.56% for obtaining any one of the winning symbol combinations on the reels in the game (through the award mode) as shown in FIG. 4B. Thus, the probability of obtaining a winning symbol combination on the reels in the primary game is 1 in 8000 or 0.013% and this probability increases to 1 in 180 or 0.56% in the award mode. This significantly increases a player's opportunities or chances of obtaining one of the awards in the game and specifically a relatively large award such as the jackpot award. This increases a player's excitement and enjoyment of the game.

Referring to FIGS. 5A through 5F, an example of one embodiment of the present invention is illustrated where the player obtains a trigger symbol or diamond symbol **102** in the primary game or primary mode. This example includes three reels **34a**, **34b** and **34c** as shown in FIG. 5A, where each reel includes a plurality of award symbols A, B, C, D, E, F, G and H, one trigger symbol designated as diamond symbol **102**, one wild symbol **105** and ten null symbols **104**. The player begins the game with five spins as indicated by the spins remaining display **106** as shown in FIG. 5A. Additionally, the player begins the game with an award of zero as indicated by the total award display **108**. The player uses their first spin as shown in FIG. 5B to activate or spin the reels. A trigger symbol or diamond symbol **102** is indicated on payline **56b** on reel **34b**. The trigger symbol or diamond symbol **102** initiates the bonus mode of the present invention.

Referring to FIG. 5C, the gaming device freezes or holds reel **34b** stationary while spinning or re-spinning the outside reels **34a** and **34c** until wild symbols **105a** and **105b**, respectively, are indicated on payline **56b** on those reels. As indicated by the spins remaining display **106**, the number of spins does not decrease when these reels are activated or re-activated to indicate the wild symbols. Additionally, the total award display **108** indicates that the player does not obtain an award for obtaining the trigger symbol (i.e., diamond symbol **102**) or the wild symbols **105a** or **105b**. In another embodiment, the gaming device provides an award associated with the trigger symbol and/or the wild symbols.

Referring to FIG. 5D, the outside reels **34a** and **34c** are stationary or cannot be re-activated, therefore the gaming device or player can only re-activate or re-spin reel **34b**. In FIG. 5D the gaming device re-activates reel **34b** and a null symbol **104** is indicated on payline **56b**. The symbol combination of a wild symbol **105a**, a null symbol **104** and wild symbol **105b** on reels **34a**, **34b** and **34c**, respectively, is not a winning symbol combination in the game. Therefore, the player does not receive an award for this symbol combination. However, the null symbol **104** does not end the game, but instead causes the gaming device to automatically re-spin or re-activate reel **34b**. Thus, the null symbol **104** provides the player with another opportunity to obtain an award symbol in the game. The number of spins remaining in the award mode

does not decrease as indicated by the spins remaining display **106** and the total award still remains at zero as indicated by the total award display **108**.

Alternatively, as indicated above, the game upon the occurrence of the null symbol can change such as increment a modifier (such as a multiplier) which is employed to modify and preferably increase the award to

Referring to FIG. 5E, the gaming device or player re-activates reel **34b** in the game. The trigger symbol or diamond symbol **102** is indicated on payline **56b** on reel **34b**. The resultant symbol combination is the wild symbol **105a**, the trigger symbol **102** and the wild symbol **105b**, on reels **34a**, **34b** and **34c**, respectively, which is not a winning symbol combination. Similar to the null symbol **104** shown in FIG. 5D, the trigger symbol or diamond symbol **102** causes the gaming device to re-activate or re-spin reel **34b**. Therefore, the player has another opportunity to obtain an award symbol in the game. The number of spins remaining in the bonus mode and the total award did not change in the game as indicated by the spins remaining display **106** and the total award display **108**.

Referring to FIG. 5F, the gaming device or player re-spins and re-activates reel **34b** in the award mode. After this spin, an award symbol designated by the letter A (**110**) is indicated on payline **56b** on reel **34b**. As a result, a winning symbol combination including wild symbol **105a** on reel **34a**, award symbol **110** on reel **34b** and wild symbol **105b** on reel **34c** is indicated on payline **56b**. This symbol combination provides a combination of three A symbols **110** because the wild symbols act or equal the award symbol **110**. In this example, a combination including three A symbols provides the jackpot or largest award of ten thousand to the player as indicated by the total award display **108**. Thus, the trigger symbol or diamond symbol **102** increases the probability or likelihood that the player will obtain an award and particularly the jackpot award in the game. The player has four spins remaining as indicated by the spins remaining display **106**. In one embodiment, the player uses the remaining spins to spin the reels four more times in the award mode. In another embodiment, the game ends when the player obtains an award in the game.

Referring to FIG. 6, another embodiment of the present invention is illustrated where the symbols on the middle or central reel **34b** include awards, such as the values of twenty, one hundred and five. In the award mode of this embodiment, the player re-spins or re-activates reel **34b** until one of the award values are indicated on payline **56b**. Instead of obtaining a winning symbol combination in the game, the player obtains three times the value of the indicated award or value on payline **56b**. For example, in FIG. 6, the award of one hundred is indicated on payline **56b** in the award mode. Therefore, the combination of the award of one hundred with the wild symbols **205a** and **205b** provide an award of three hundred because the wild symbols match the award value indicated on payline **56b** on reel **34b**. Thus, the player obtains an award of three hundred as indicated by the total award display **108** in the award mode. It should be appreciated that any symbols, values or any combination of symbols or values may be employed on the reels in the award mode of the game of the present invention.

Referring to FIG. 7, a further embodiment of the present invention is illustrated where the middle or center reel **34b** includes a wild symbol **105b**. In this embodiment, the player re-spins reel **34b** after obtaining the trigger symbol or diamond symbol **102** as described above. If the player obtains the wild symbol on payline **56b** on reel **34b**, the player obtains a symbol combination including three wild symbols **105a**, **105b** and **105c**. Thus, the player obtains the largest award or

the highest or most desirable symbol combination associated with the game such as the jackpot symbol combination because the player obtained three wild symbols on payline **56b**. Thus, the wild symbol **105b** increases the probability that the player will obtain the largest award such as the jackpot award in the game. In another embodiment, an award or award value is associated with the symbol combination including the wild symbol as shown in FIG. **3B**.

In one alternative embodiment of the present invention, the number of spins of the reel can be limited such as to a predetermined number, a randomly determined number, or a number based on another functional game element such as the player's wager.

Wild Symbol Related Award

In an alternative embodiment, the gaming device includes a game which displays a plurality of reels to a player. The reels include a plurality of symbols having at least one trigger symbol such as a wild symbol. The trigger symbol enables a player to obtain additional opportunities to obtain awards in a game after one or more losing symbol combinations including at least one wild symbol are indicated on the reels.

In one alternative embodiment, the gaming device activates or spins the reels for at least one activation or spin in a game and indicates one or more symbols such as a combination of symbols on the reels. If the symbol combination indicated on the reels includes a wild symbol, but is not a winning symbol combination in the game, the gaming device holds the reel including the wild symbol stationary. The gaming device then provides the player with a designated number of activations or spins to re-spin at least one of the reels other than the held reel in the game. The designated number of activations or spins may be predetermined, randomly determined, determined based on a wager made by a player or determined according to any suitable determination method in a game. In another embodiment, the wild symbol and the symbol combinations are indicated on one payline associated with the reels, a plurality of paylines associated with the reels or on all of the paylines associated with the reels.

Referring to FIG. **9**, in an example of the above embodiment, the gaming device displays a plurality of reels to a player. The reels include a plurality of symbols **204** including at least one trigger symbol, which is a wild symbol **206**. The symbols in this example are shapes such as circles, rectangles, hearts, diamonds, stars and bar symbols. It should be appreciated that the symbols may be shapes, numbers, letters, characters or any suitable images. Three paylines **56a**, **56b** and **56c** are associated with the reels. In this example, the gaming device provides an award to the player for any winning symbol combinations including three matching symbols indicated on payline **56b**. A spins remaining display **208** indicates the number of free spins provided to the player in a game, if any. A total award display **210** indicates the total award accumulated by the player in the game. At the start of the game, the number of free spins is zero and the total award is zero.

Referring to FIG. **10A**, the gaming device activates or spins the reels in the game and a symbol on each reel is indicated on the payline **56b**. Specifically, a wild symbol **206** is indicated on the payline. However, a winning symbol combination is not indicated on the payline because three matching symbols are not indicated on the payline. Thus, the player obtained a wild symbol but did not obtain a winning symbol combination in the game. The gaming device therefore holds reel **34b**, which includes the wild symbol **206**, stationary, and provides two free spins of the reels as indicated by the spins remaining

display **208**. As a result, the gaming device provides the player with additional opportunities to win awards associated with the wild symbol. This increases the player's excitement and enjoyment in the game. The total award in the game is still zero as indicated by the total award display **210**.

Referring to FIG. **10B**, the gaming device activates or spins the reels using one of the free spins provided to the player in the game. The reels stop spinning and three symbols are indicated on payline **56b**. The indicated symbols are a diamond symbol **204a**, the wild symbol **206** and another diamond symbol **204b**. The wild symbol **206** matches or substitutes for one of the symbols indicated on the payline. Because only diamond symbols are indicated on the payline, the wild symbol matches or substitutes as a diamond symbol on the payline. Thus, a symbol combination including three matching symbols, specifically three diamond symbols, is indicated on payline **56b**. This is a winning symbol combination in the game. Therefore, the gaming device provides an award associated with the winning symbol combination (i.e., three diamond symbols), which in this example is an award of fifty. The award of fifty is added to the player's total award and the player now has a total award of fifty as indicated by the total award display **210**. The game ends and the total award indicated by the total award display is provided to the player.

In another alternative embodiment, the gaming device holds a reel including a wild symbol stationary when the wild symbol occurs on or is indicated on a designated payline in the game and the award amount associated with any winning symbol combinations indicated on the payline are not greater than a designated award amount in the game. The gaming device therefore ensures that if the player does obtain an award in the game, the award is above a designated award or award amount (i.e., a minimum award amount). It should be appreciated that the designated award amount may be any suitable award amount such as a particular symbol combination or combinations, or a particular award value in the game.

Referring to FIG. **11**, an example of this embodiment is illustrated where the gaming device displays a plurality of reels including symbols **204**. The symbols include at least one wild symbol **206** as described above. In this example, the gaming device designates a particular award amount to be a minimum award amount in the game. Therefore, the gaming device will provide an award to the player only if the award or award amount associated with a winning symbol combination indicated by the reels is equal to or greater than the designated award amount for the game. In FIG. **11**, an award summary table **212** displays a plurality winning symbol combinations **214** such as the winning symbol combination including three bar symbols (**214a**), associated with the symbols in the game. Additionally, a plurality of awards **216** such as the award of two hundred fifty (**216a**) are associated with the winning symbol combinations. In this example, the gaming device designated winning symbol combination **214b** and the associated award of twenty-five (**216b**) as the minimum award amount in the game. Thus, the player must obtain a winning symbol combination **214** that produces an award greater than twenty-five, which is the designated award amount in the game.

Referring to FIGS. **11A** and **11B**, the gaming device spins the reels and three symbols are indicated on payline **56b**. The symbols include a circle symbol, a wild symbol **206** and a heart symbol. Because this symbol combination is not a winning symbol combination as indicated by the award summary table **212**, the gaming device holds the reel including the wild symbol **206** stationary and provides a designated number of free spins to the player to obtain an award related to or based on the wild symbol **206**. The gaming device provides two free

spins to the player as indicated by the spins remaining display **208**. The gaming device will use the free spins to spin reels **34a** and **34c** in the game. Because the player did not obtain an award in this spin, the total award is still zero as indicated by the total award display **210**.

Referring to FIG. **11C**, the gaming device activates or spins the reels **34** using the first free spin. The reels stop spinning and three symbols are indicated on payline **56b**. The symbols are a rectangle symbol, the wild symbol **206** and another rectangle symbol. The wild symbol **206** substitutes for one of the rectangle symbols on payline **56b** and therefore, a symbol combination including three matching rectangle symbols are indicated on payline **56b**. This symbol combination, however, does not generate an award or award amount greater than the designated award amount of twenty-five. Thus, the player does not obtain a winning symbol combination in this spin. There is only one free spin remaining in the game as indicated by the spins remaining display **208**. Also, the total award is still zero as indicated by the total award display **210**.

Referring to FIG. **11D**, the gaming device activates or spins the reels **34** using the last free spin in the game. After this spin, the reels indicate a star symbol **204c**, the wild symbol **206** and star symbol **204d**. The wild symbol **206** substitutes as one of the symbols on the payline (i.e., a star symbol) and therefore a winning symbol combination including three star symbols is indicated on payline **56b**. Also, this winning symbol combination provides an award which is greater than the designated award amount **216b** associated with the winning symbol combination **214b** as shown in FIG. **11B** because the award of one hundred associated with three star symbols is greater than the award of twenty-five associated with the three rectangle symbols. Thus, the gaming device adds the award of one hundred to the player's total award in the game as indicated by the total award display **210**.

In one embodiment as illustrated in this example, the game ends when the player obtains an award in the game regardless of whether the player obtains the award in the first spin or the last spin in the game. In another embodiment, the gaming device activates or spins the reel or reels other than the reel including the wild symbol until a winning symbol combination is indicated on the reels or until there are no spins remaining in the game. In another embodiment, the gaming device activates or spins the reel or reels other than the reel including the wild symbol until a winning symbol combination is indicated on the reels. In a further embodiment, the gaming device activates or spins the reel or reels other than the reel including the wild symbol until there are no spins remaining in the game. In this embodiment, the gaming device provides awards to the player associated with any winning symbol combinations that occur on the reels during the designated number of activations or spins of the reels.

In a further alternative embodiment of the present invention, if a player achieves a bonus triggering or qualifying condition during the primary game, the gaming device **10** initiates a free spins game. In the free spins game, the gaming device provides one or more activations or free spins of the reels to the player. The gaming device or player continues to spin or activate the reels until there are no free spins remaining in the game. In another embodiment, if a re-triggering event occurs in a game, the gaming device re-triggers or re-spins the reels in the game (i.e., provides additional free spins in the game). The re-triggering event may be a re-trigger symbol occurring on the reels, a re-trigger symbol combination occurring on the reels or any suitable event. It should be appreciated that the gaming device may re-trigger or re-spin the reels one or more times in the game.

Referring to FIG. **12**, one embodiment of the present invention is illustrated. In this embodiment, the gaming device includes a plurality of reels displayed to a player and the gaming device provides the player with a designated number of activations or free spins of the reels. The reels may be mechanical reels or video reels as described above. The reels include a plurality of symbols where the symbols include at least one wild symbol. A plurality of awards are associated with the symbols **204** or combinations of the symbols **204** and the awards may be values, credits, free spins, free games, multipliers or any suitable award or awards. The wild symbol or wild symbols **206** are designated with the word "WILD" but may be designated with any suitable designator or symbol. In a game, the wild symbol **206** matches or substitutes for any one of the symbols **204** on the reels in the game. In one embodiment, the wild symbol substitutes for one of the symbols indicated on the same payline as the wild symbol. In another embodiment, the wild symbol matches or substitutes for the most desirable symbol on a payline or on the reels such as the jackpot symbol or the symbol associated with the largest award in the game. A spins remaining display **208** indicates the number of spins remaining in a game. A total award display **210** indicates the total award accumulated by a player in the game.

In a game, the gaming device or the player activates or spins the reels to indicate symbols on the reels. Symbols may be indicated on one or more reels such as in a scatter pay combination, or on a single payline associated with the reels. The gaming device provides any awards associated with any winning symbol combination indicated on the reels. The gaming device or player continues to activate or spin the reels for a designated number of spins in a game until there are no activations or spins remaining in the game. The player then receives the total award indicated in the total award display **210**.

In one embodiment of the present invention, the gaming device enhances a player's opportunity to obtain one or more awards in a game by utilizing the indicated wild symbol **206** to provide a better opportunity of obtaining an award in a game. In this embodiment, the gaming device or player spins the reels **34a**, **34b** and **34c** to indicate symbols on the reels. If a wild symbol is indicated on one of a plurality of paylines associated with the reels **34**, the reel including the wild symbol **206** is frozen or held stationary. The gaming device then activates the reels, not including the reel having the wild symbol, to enhance the opportunity of obtaining an award in the game. Because the wild symbol **206** is held stationary or in place on one of the paylines associated with the reels, less symbols must be indicated on the reels to obtain a winning symbol combination in the game. For example, in FIG. **12**, the wild symbol is indicated on payline **56b**. The gaming device or players spins the other reels **34a** and **34c** to attempt to obtain a winning symbol combination including the wild symbol **206**. However, the number of reels that are activated in the game decrease, which thereby increases the chance or opportunity that the player will obtain a winning symbol combination including the wild symbol, in the game. The player or gaming device continues to spin the reels **34a** and **34c** for the remaining number of activations in the game until there are no activations or spins remaining in the game. The gaming device provides the player with any awards associated with winning symbol combinations indicated on the reels. The awards are added to the total award display **210** and the player receives the total award indicated by the total award display at the end of the game.

Referring to FIG. **13A**, an example of the embodiment of FIG. **12** is illustrated where the gaming device displays a

plurality of reels **34a**, **34b** and **34c**. The reels include a plurality of symbols **204** having at least one wild symbol **206**. A plurality of awards are associated with specific symbol combinations as indicated in the award summary table **210** in FIG. **13B**. The winning symbol combinations **220** are designated in the first column of the award summary table **218**. Additionally, the awards **222** associated with each of the specific winning symbol combinations are indicated in the table. In this embodiment, the winning symbol combinations include three matching symbols. It should be appreciated that the winning symbol combinations may include one or more matching symbols or any suitable symbol combinations in a game. In FIG. **13A**, three paylines **56a**, **56b** and **56c** are associated with the reels **34**. In this example, a winning symbol combination must be indicated on the middle payline or payline **56b** in the game. The gaming device provides the player with three activations or spins of the reels **34** as indicated by the spins remaining display **208**. Also, the player begins the game with a total award of zero as indicated in the total award display **210**.

Referring to FIG. **13C**, the gaming device activates or spins the reels for the first time in the game. After the reels stop spinning, a wild symbol **206** is indicated on payline **56b**. However, a winning symbol combination, as designated in the award summary table **218** in FIG. **13B**, is not indicated on payline **56b** even though the wild symbol **206** is indicated on the payline. Specifically, the circle symbol, the wild symbol **206**, and the heart symbol are indicated on payline **56b**, which is not a winning symbol combination in the game. Therefore, the gaming device freezes or holds reel **34b** stationary and thereby enhances the player's opportunity to obtain a winning symbol combination in the game. The gaming device will spin or activate reels **34a** and **34c** to indicate symbols on payline **56b** including the wild symbol **206**. The player has two spins remaining as indicated in the spins remaining display **208**. The player's total award is zero as indicated in the total award display **210**.

Referring to FIG. **13D**, the gaming device activates or spins the reels for a second time in the game. In this activation or spin, the gaming device only activates or spins reels **34a** and **34c** because reel **34b** is held stationary. Thus, the player only needs to obtain two symbols, one on each of the reels **34a** and **34c**, on payline **56b** to obtain a winning symbol combination in the game. After this spin, a heart symbol, a wild symbol **206**, and a diamond symbol are indicated on payline **56b**. This combination of symbols is not a winning symbol combination as illustrated in the award summary table **218** in FIG. **13B**. The player now has only one spin remaining in the game as indicated in the spins remaining display **208**. Also, the total award is zero as indicated in the total award display **210**.

Referring to FIG. **13E**, the gaming device activates or spins the reels **34** for the last time in the game. The reels stop spinning and indicate a bar symbol **204a**, a wild symbol **206** and a bar symbol **204b** on payline **56b**. Because the wild symbol **206** matches or substitutes for one of the symbols indicated on the same payline as the wild symbol, the wild symbol matches or substitutes as a bar symbol. Thus, the symbol combination indicated on payline **56b** is three bar symbols. Three bar symbols represent a winning symbol combination in the game as illustrated in FIG. **13B**. The gaming device provides the award associated with this winning symbol combination, which is five hundred, and displays that award in the total award display **210**. There are no spins remaining in the game as indicated by the spins remaining display **208**. Therefore, the gaming device provides the player with the total award indicated in the total award display **210**, which is five hundred.

In another alternative embodiment of the present invention, the gaming device freezes or holds one of the reels **34** stationary when a wild symbol is indicated on the reel on a designated payline associated with the reels and the award or awards, if any, associated with any winning symbol combinations occurring on the payline is less than a designated award value in the game. In this embodiment, the gaming device designates an award value in the game. The designated award value defines a minimum award value or base award value to provide to a player in the game. The award value may be any suitable award value as desired by the game implementor, but not exceeding the largest possible award in the game. Furthermore, the designated award value may be predetermined, randomly determined, determined based on a wager made by the player or according to any suitable determination method.

The gaming device activates or spins the reels for a designated number of spins in the game. The gaming device provides the awards associated with any winning symbol combinations indicated on a designated payline associated with the reels. If a wild symbol **206** is indicated on the payline and the award or awards, if any, associated with any winning symbol combinations indicated on the payline is less than the designated award value, the gaming device freezes or holds the reel including the wild symbol stationary and activates the other reels in the game for the remaining number of activations. This provides the player with an enhanced opportunity to obtain an award or awards in the game using the wild symbol because the player needs less symbols to obtain a winning symbol combination in the game. Also, the designated award value insures that if the player does obtain an award in the game, the award will be above a specified award value, which increases the player's excitement and enjoyment of the game.

Referring to FIG. **14A**, **14B**, **14C**, **14D** and **14E**, an example of this embodiment is illustrated where the gaming device provides a player with three spins in a game. The gaming device designates an award value or award of fifty as the minimum award value in the game. Therefore, if a wild symbol is indicated on the payline, but a winning symbol combination having an award value of fifty or greater is not indicated on the payline, the gaming device enhances the player's opportunity to obtain a winning symbol combination in the game by holding the reel including the wild symbol stationary for the remainder of the game. The player begins the game with a total award of zero as indicated in the total award display **210** in FIG. **14A**.

Referring to FIG. **14B**, an award summary table **224** indicates winning symbol combinations **226** and the awards **228** associated with those winning symbol combinations in the game. In this embodiment, a winning symbol combination includes three matching symbols. However, it should be appreciated that any combination of symbols may be designated as a winning symbol combination in a game. Additionally, any suitable award may be associated with a winning symbol combination in a game.

Referring to FIG. **14C**, the gaming device activates or spins the reels for the first in this game. The reels stop spinning and indicate a bar symbol, a wild symbol **206**, and a star symbol on payline **56b**. Although the player obtained a wild symbol **206** on the payline **56b**, the player did not obtain a winning symbol combination in the game. Specifically, the player did not obtain a winning symbol combination that included an award greater than the designated award value of fifty as indicated in the award summary table **224** in FIG. **14B**. Therefore, the gaming device freezes or holds reel **34b**, which includes the wild symbol **206**, stationary. The gaming device

then activates or spins the other reels **34a** and **34c** for the remaining number of spins or activations in the game. The player has two activations or spins remaining in the game as indicated in the spins remaining display **208**. The total award in the game is still zero as indicated in the total award display **210**.

Referring to FIG. **14D**, the gaming device activates or spins the reels for a second time in a game. A rectangle symbol, a wild symbol **206** and another rectangle symbol are indicated on payline **56b**. Because the wild symbol acts or substitutes for one of the symbols indicated on the same payline as the wild symbol, which in this spins is a rectangle symbol, a combination of three rectangle symbols is indicated on the payline. This symbol combination, however, does not include an award value greater than the designated award value of fifty as indicated in the award summary table **224** in FIG. **14B**. Specifically, an award of twenty-five is associated with the symbol combination including three rectangle symbols, which is less than the designated award value of fifty. However, the gaming device continues to activate or spin the reels in the game. The player now has one spin remaining in the game as indicated by the spins remaining display **208**. Furthermore, the total award in the game is zero as indicated by the total award display **210**.

Referring to FIG. **14E**, the gaming device spins or activates the reels for the final time in the game. In this spin, a star symbol, a wild symbol **206** and another star symbol are indicated on payline **56b**. An award of two-hundred fifty is associated with a winning symbol combination including three star symbols as indicated in the award summary table **224**. The award value of two-hundred fifty is greater than the designated award value of fifty. Thus, the gaming device provides this award to the player in the game. The award of two-hundred fifty is transferred to the total award display as indicated by the total award display **210**. The player does not have any spins remaining in the game as indicated by the spins remaining display **208**. The gaming device therefore provides the total award of two-hundred fifty as indicated in the total award display **210** to the player and the game ends.

In a further alternative embodiment, after the gaming device freezes or holds one of the reels **34** stationary when a wild symbol is indicated on the reels, the gaming device activates or spins the reels, other than the held reel, for a designated number of spins in the game and provides an award or awards associated with any winning symbol combinations including the wild symbol indicated on any of the paylines associated with the reels (i.e., a scatter pay combination). For example in FIG. **14E**, if one of the star symbols is located on payline **56a** and the other star symbol is located on payline **56c**, the gaming device provides the award associated with a winning symbol combination including three star symbols (i.e., two star symbols and the wild symbol) because the winning combination of symbols including the wild symbol occurred on the reels. It should be appreciated that the winning symbol combination including the wild symbol may include any winning combination of symbols on the reels including the reel having the wild symbol. This embodiment provides the player with a greater opportunity to obtain an award or awards in a game using the wild symbol because the player can obtain a winning symbol combination on any of the reels, instead of on a designated payline or paylines.

Referring to FIG. **15** in another alternative embodiment, the wild symbol includes at least one symbol indicator **230** which points to or indicates one or more symbols on the reels in the scatter pay combination embodiment described above. In one aspect of this embodiment, the indicator or indicators are stationary and point to a fixed location or locations on the

reels. For example in FIG. **15**, the wild symbol **206** includes two indicators which are in the form of arrows **230a** and **230b**. Indicator **230a** points to the symbol location on reel **34a**, which is associated with payline **56a**. Indicator **230b** points to the symbol location on reel **34c**, which is associated with payline **56a**. It should be appreciated that the indicators may be arrows, pointers or any other suitable indicator. It should also be appreciated that the wild symbol may include one or more indicators and the indicators may point to any suitable location or locations on the reels. In this example, the reel including the wild symbol is held stationary while the other reels (i.e., the reels not including the wild symbol) are activated. The reels stop and the indicators **230a** and **230b** associated with the wild symbol point to the circle symbol **204a** and another circle symbol **204b**. Thus, the gaming device provides an award associated with a winning symbol combination including three circle symbols (i.e., two circle symbols and the wild symbol). It should be appreciated that the indicators may indicate or point to a randomly selected location on the reels or a designated section on the reels.

In a further alternative embodiment of the present invention, the symbols on the reels include at least one bonus symbol. When the bonus symbol is indicated on one or more designated paylines in a game, the gaming device provides an additional award or bonus award in the game. The bonus award associated with the bonus symbol may be at least one free spin of the reels, at least one free game and/or at least one multiplier. It should be appreciated that the bonus award may be any suitable award as desired by the game implementor. The bonus award enables a player to obtain additional awards or additional spins of the reels in a game, which further enhances the player's excitement and enjoyment of the game.

In another alternative embodiment, a probability of being indicated on one or more paylines associated with the reels is associated with each of the symbols on the reels. In one embodiment, the probability associated with the wild symbol is less than at least one of the probabilities associated with the other symbols on the reels. In another embodiment, the probability associated with the wild symbol is less than a plurality of the probabilities associated with the other symbols on the reels. In a further embodiment, the probability associated with the wild symbol is less than all of the probabilities associated with the other symbols on the reels. It should be appreciated that the probabilities associated with the symbols may be any suitable probabilities as desired by the game implementor.

In a further alternative embodiment, the present invention is employed in a card game such as a video poker game. In this embodiment, the gaming device display a plurality of cards to a player. The cards include a plurality of symbols including at least one wild symbol. The symbols may be any suitable symbols such as numbers, colors, letters, playing card suits, images or any other suitable symbols or images. If a card includes a wild symbol but a winning combination of cards is not indicated, the gaming device holds the card including the wild symbol. The gaming device then replaces at least one of the cards for a designated number of rounds. The number of rounds may be predetermined, randomly determined, determined based on a wager by a player or according to any suitable determination method. Thus, the gaming device provides the player with additional opportunities to win awards related to the wild symbol on the cards. In one embodiment, the gaming device replaces one or more of the cards in the rounds until a winning combination of cards is indicated. In another embodiment, the gaming device replaces one or more of the cards until there are no rounds remaining in the game. In this embodiment, the gaming device enables the player to

25

obtain one or more awards in the game. In a further embodiment as described above, the gaming device holds the card including the wild symbol when the wild symbol appears on the card and the award amount associated with the combination of symbols indicated by the cards is not greater than a designated award amount.

Referring to FIG. 16, the above embodiment is illustrated where the gaming device displays five cards to the player in the game. The cards include a two of hearts (232a), a three of diamonds (232b), a wild symbol card (232c), a five of spades (232d) and a nine of diamonds (232e). In this example, a pair of matching cards is not a winning combination of cards. Therefore, the combination of cards displayed in FIG. 16 does not produce a winning combination of cards in the game. Because a wild symbol appears on one of the cards, card 232c, and there are no winning combinations of cards in the game, the gaming device holds card 232c. The gaming device then replaces at least one of the cards, other than the card including the wild symbol (232c), until a winning combination of cards is indicated such as three matching cards (i.e., three of a kind), or until there are no rounds remaining in the game. The gaming device then provides the player with the award associated with the winning combination of cards in the game as indicated by the total award display 236.

It should be appreciated that the present invention may be employed in a primary game, a bonus game, free spins game, a sub-game or in any suitable game.

While the present invention is described in connection with what is presently considered to be the most practical and preferred embodiments, it should be appreciated that the invention is not limited to the disclosed embodiments, and is intended to cover various modifications and equivalent arrangements included within the spirit and scope of the claims. Modifications and variations in the present invention may be made without departing from the novel aspects of the invention as defined in the claims, and this application is limited only by the scope of the claims.

The invention is claimed as follows:

1. A gaming device comprising:

at least one display device;

at least one input device;

at least one processor; and

at least one memory device which stores a plurality of instructions, which when executed by the at least one processor, cause the at least one processor to operate with the at least one display device and the at least one input device to:

(a) display a primary game associated with a plurality of reels, said reels having a plurality of symbols including a plurality of trigger symbols;

(b) enable a player to place a wager on a play of the primary game;

(c) after placement of the wager for said play of the primary game, randomly generate a plurality of the symbols;

(d) display said randomly generated plurality of symbols on the reels;

(e) determine if the displayed symbols include a designated number of the trigger symbols, said designated number of the trigger symbols being at least one;

(f) if the displayed symbols include the designated number of the trigger symbols, determine if the displayed trigger symbols form a designated winning symbol combination of a plurality of different winning symbol combinations; and

(g) if the determination is made that the displayed symbols include the designated number of the trigger

26

symbols but said displayed trigger symbols do not form the designated winning symbol combination, for each of a designated number of re-activations of at least one of the reels other than the reels having said displayed trigger symbols:

(i) randomly generate a plurality of the symbols,

(ii) display said randomly generated symbols on said at least one of the reels, and

(iii) if the designated winning symbol combination occurs on the reels during any of the designated number of re-activations, provide a designated award to the player.

2. The gaming device of claim 1, wherein each of the reels includes at least one of the trigger symbols.

3. The gaming device of claim 1, wherein said trigger symbols are wild symbols.

4. The gaming device of claim 1, wherein said trigger symbols are symbols other than wild symbols.

5. The gaming device of claim 1, wherein said reels are video reels.

6. The gaming device of claim 1, wherein the plurality of instructions, when executed by the at least one processor, cause the at least one processor to, for each of said designated number of re-activations, re-activate each of the reels other than the reels having said displayed trigger symbols.

7. The gaming device of claim 1, wherein the plurality of instructions, when executed by the at least one processor, cause the at least one processor to, for each of said designated number of re-activations, randomly generate one of the symbols on each of the reels other than the reels having said displayed trigger symbols.

8. The gaming device of claim 1, wherein the designated number of re-activations is predetermined.

9. The gaming device of claim 1, wherein the designated number of re-activations is one.

10. The gaming device of claim 1, wherein the designated number of re-activations is determined based on the wager made by the player.

11. The gaming device of claim 1, wherein the designated award includes at least one free play of the primary game.

12. The gaming device of claim 1, wherein the designated award includes a plurality of free plays of the primary game.

13. A gaming device comprising:

at least one display device;

at least one input device;

at least one processor; and

at least one memory device which stores a plurality of instructions, which when executed by the at least one processor, cause the at least one processor to operate with the at least one display device and the at least one input device to:

(a) display a primary game associated with a plurality of reels, said reels including a plurality of symbols including a plurality of trigger symbols, a plurality of different awards associated with a plurality of different winning symbol combinations formed by said symbols;

(b) enable a player to place a wager on a play of the primary game;

(c) after placement of the wager for said play of the primary game, randomly generate a plurality of the symbols;

(d) display said randomly generated plurality of symbols on the reels,

(e) determine if the displayed symbols include a designated number of the trigger symbols, said designated number of the trigger symbols being at least one;

27

- (f) if the displayed symbols include the designated number of the trigger symbols, determine if the displayed trigger symbols result in a designated award of the plurality of different awards; and
- (g) if the determination is made that the displayed symbols include the designated number of the trigger symbols, but the displayed trigger symbols do not result in the designated award, for each of a designated number of re-activations of the reels:
- (i) randomly generate a plurality of the symbols on at least one of the reels other than the reels having said displayed trigger symbols,
- (ii) display said randomly generated plurality of symbols on said at least one of the reels, and
- (iii) provide the designated award to the player if a designated winning symbol combination occurs on the reels during any of said designated number of activations.
14. The gaming device of claim 13, wherein each of the reels includes at least one of the trigger symbols.
15. The gaming device of claim 13, wherein said trigger symbols are wild symbols.
16. The gaming device of claim 13, wherein said trigger symbols are symbols other than wild symbols.
17. The gaming device of claim 13, wherein said reels are video reels.
18. The gaming device of claim 13, wherein the plurality of instructions, when executed by the at least one processor, cause the at least one processor to, for each of said designated number of re-activations, re-activate each of the reels other than the reels having said displayed trigger symbols.
19. The gaming device of claim 13, wherein the plurality of instructions, when executed by the at least one processor, cause the at least one processor to, for each of said designated number of re-activations, randomly generate one of the symbols on each of the reels other than the reels having said displayed trigger symbols.
20. The gaming device of claim 13, wherein the designated award includes an award of a minimum value.
21. The gaming device of claim 13, wherein the designated number of re-activations is predetermined.
22. The gaming device of claim 13, wherein the designated number of re-activations is one.
23. The gaming device of claim 13, wherein the designated number of re-activations is determined based on the wager made by the player.
24. The gaming device of claim 13, wherein the designated award includes at least one free play of the primary game.
25. The gaming device of claim 13, wherein the designated award includes a plurality of free plays of the primary game.
26. A method of operating a gaming device, the method comprising:
- (a) causing at least one display device to display a plurality of reels, said reels including a plurality of symbols of a primary game, said symbols including a plurality of trigger symbols;
- (b) enabling a player to place a wager for a play of the primary game;
- (c) after placement of said wager for said play of the primary game, randomly generating a plurality of said symbols;
- (d) causing the at least one display device to display said randomly generated symbols on the reels;
- (e) determining if the displayed symbols include a designated number of the trigger symbols, said designated number of the trigger symbols being at least one;

28

- (f) if the displayed symbols include the designated number of the trigger symbols, determining if the displayed trigger symbols form a designated winning symbol combination of a plurality of different winning symbol combinations; and
- (g) if the determination is made that the displayed symbols include the designated number of the trigger symbols, but said displayed trigger symbols do not form the designated winning symbol combination, for each of a designated number of re-activations of at least one of the reels other than the reels having said displayed trigger symbols:
- (i) randomly generating a plurality of the symbols,
- (ii) causing the at least one display device to display said randomly generated symbols on said at least one of the reels, and
- (iii) if the designated winning symbol combination occurs on the reels during any of said designated number of re-activations providing a designated award to the player.
27. The method of claim 26, wherein each of the reels includes at least one of the trigger symbols.
28. The method of claim 26, wherein said trigger symbols are wild symbols.
29. The method of claim 26, wherein said trigger symbols are symbols other than wild symbols.
30. The method of claim 26, wherein said reels are video reels.
31. The method of claim 26, which includes, for each of said designated number of re-activations, randomly generating one of said symbols on each of the reels other than the reels having said displayed trigger symbols.
32. The method of claim 26, which includes predetermining the designated number of re-activations.
33. The method of claim 26, wherein providing the designated number of re-activations includes providing one re-activation.
34. The method of claim 26, which includes determining the designated number of re-activations based on the wager made by the player.
35. The method of claim 26, wherein the designated award includes at least one free play of the primary game.
36. The method of claim 26, wherein the designated award includes a plurality of free plays of the primary game.
37. The method of claim 26, which is provided through a data network.
38. The method of claim 37, wherein the data network is an internet.
39. A method of operating a gaming device, the method comprising:
- (a) causing at least one display device to display a plurality of reels, said reels including a plurality of symbols of a primary game, said symbols including a plurality of trigger symbols, a plurality of different awards associated with a plurality of different winning symbol combinations formed by said symbols;
- (b) enabling a player to place a wager for a play of the primary game;
- (c) after placement of said wager for said play of the primary game, randomly generating a plurality of said symbols;
- (d) causing the at least one display device to display said randomly generated symbols on the reels;
- (e) determining if the displayed symbols include a designated number of the trigger symbols, said designated number of the trigger symbols being at least one;

29

- (f) if the displayed symbols include the designated number of the trigger symbols, determining if the displayed trigger symbols result in a designated award of the plurality of different awards; and
- (g) if the determination is made that the displayed symbols include the designated number of the trigger symbols, but said displayed trigger symbols do not result in the designated award, for each of a designated number of re-activations of at least one of the reels other than the reels having said displayed trigger symbols:
- (i) randomly generating a plurality of the symbols,
 - (ii) causing the at least one display device to display said randomly generated symbols on said at least one of the reels, and
 - (iii) providing the designated award to the player if a designated winning symbol combination occurs on the reels during any of said designated number of re-activations.
40. The method of claim 39, wherein each of the reels includes at least one of the trigger symbols.
41. The method of claim 39, wherein said trigger symbols are wild symbols.
42. The method of claim 39, wherein said trigger symbols are symbols other than wild symbols.
43. The method of claim 39, wherein said reels are video reels.
44. The method of claim 39, which includes, for each of said designated number of re-activations, randomly generating one of said symbols on each of the reels other than the reels having said displayed trigger symbols.
45. The method of claim 39, wherein the designated award includes an award of a minimum value.
46. The method of claim 39, which includes predetermining the designated number of re-activations.
47. The method of claim 39, wherein providing the designated number of re-activations includes providing one re-activation.
48. The method of claim 39, which includes determining the designated number of re-activations based on the wager made by the player.
49. The method of claim 39, wherein the designated award includes at least one free play of the primary game.
50. The method of claim 39, wherein the designated award includes a plurality of free plays of the primary game.
51. The method of claim 39, which is provided through a data network.
52. The method of claim 51, wherein the data network is an internet.
53. A gaming system comprising:
- at least one display device;
 - at least one input device;
 - at least one processor; and
 - at least one memory device which stores a plurality of instructions, which when executed by the at least one processor, cause the at least one processor to operate with the at least one display device and the at least one input device, for a play of a game, to:
 - (a) display a plurality of reels, said reels having a plurality of symbols including a plurality of designated symbols;
 - (b) cause an activation of the reels;
 - (c) if, as a result of said activation, a designated number of said designated symbols are displayed on the reels in predetermined positions, said designated number being at least one, and the reels do not display a predetermined symbol combination including said displayed designated symbols:

30

- (i) hold stationary each of said reels which displays one of said designated symbols, and
 - (ii) automatically re-activate at least one of the reels other than the held reels to randomly generate and display at least one of the plurality of symbols; and
 - (d) if the predetermined symbol combination is displayed on the reels, provide an award to a player.
54. The gaming system of claim 53, wherein each of the reels includes at least one of the designated symbols.
55. The gaming system of claim 53, wherein said designated symbols include wild symbols.
56. The gaming system of claim 53, wherein the award includes a bonus game.
57. The gaming system of claim 53, which includes a payline associated with the reels wherein if, after said activation, the designated number of said designated symbols are displayed on the payline and the reels do not display the predetermined symbol combination including said displayed designated symbols on the payline, then each of said reels which displays one of the designated symbols is held stationary and at least one of the reels other than the held reels is automatically re-activated, and, if the predetermined symbol combination is displayed on said payline, the award is provided to the player.
58. The gaming system of claim 53, which includes a plurality of paylines associated with the reels wherein if, after said activation, the designated number of said designated symbols are displayed on one of the paylines and the reels do not display the predetermined symbol combination including said displayed designated symbols on said one of the paylines, then each of said reels which displays one of the designated symbols is held stationary and at least one of the reels other than the held reels is automatically re-activated, and, if the predetermined symbol combination is displayed on said one of the paylines, the award is provided to the player.
59. A gaming system comprising:
- at least one display device;
 - at least one input device;
 - at least one processor; and
 - at least one memory device which stores a plurality of instructions, which when executed by the at least one processor, cause the at least one processor to operate with the at least one display device and the at least one input device, for a play of a game, to:
 - (a) enable a player to place one of a plurality of different wager amounts, said plurality of different wager amounts including a designated wager amount;
 - (b) if the player places the designated wager amount:
 - (i) cause an activation of a plurality of reels associated with said game, said reels having a plurality of symbols including a plurality of designated symbols;
 - (ii) provide to the player any awards associated with any winning symbol combination displayed on the reels as a result of said activation;
 - (iii) if, as a result of said activation, a designated number of said designated symbols are displayed on the reels in predetermined positions, said designated number being at least one, and the reels do not display a predetermined symbol combination including said displayed designated symbols:
 - (A) hold stationary each of said reels which displays one of said designated symbols, and
 - (B) automatically re-activate at least one of the reels other than the held reels to randomly generate and display at least one symbol; and

31

- (iv) if the predetermined symbol combination is displayed on the reels provide a designated award to the player; and
- (c) if the player places another one of said plurality of wager amounts: 5
 - (i) cause an activation of the plurality of reels; and
 - (ii) provide to the player any awards associated with any winning symbol combination displayed on the reels as a result of said activation.
- 60. The gaming system of claim 59, wherein each of the 10 reels includes at least one designated symbol.
- 61. The gaming system of claim 59, wherein said designated symbols include wild symbols.
- 62. The gaming system of claim 59, wherein the designated 15 award includes a bonus game.
- 63. A gaming system comprising:
 - at least one display device;
 - at least one input device;
 - at least one processor; and
 - at least one memory device which stores a plurality of 20 instructions, which when executed by the at least one processor, cause the at least one processor to operate with the at least one display device and the at least one input device, for a play of a game, to:
 - (a) display a plurality of reels, said reels having a plu- 25 rality of symbols including a plurality of designated symbols;
 - (b) cause an activation of the reels;

32

- (c) if, as a result of said activation, a designated number of said designated symbols are displayed on the reels in predetermined positions, said designated number being at least one, and the activation of the reels does not produce a designated result which is predetermined from a plurality of different possible results prior to said play of the game:
 - (i) hold each of said reels which displays one of said designated symbols in a predetermined position, and
 - (ii) automatically re-activate at least one of the reels other than the held reels to randomly generate and display at least one symbol; and
- (d) if the designated result occurs, provide an award associated with the designated result to a player.
- 64. The gaming system of claim 63, wherein each of the reels includes at least one of the designated symbols.
- 65. The gaming system of claim 63, wherein said designated symbols include wild symbols.
- 66. The gaming system of claim 63, wherein the award associated with the designated result includes an award of a designated amount.
- 67. The gaming system of claim 63, wherein the designated result includes a designated winning combination of said symbols from a plurality of different winning symbol combinations.

* * * * *

UNITED STATES PATENT AND TRADEMARK OFFICE
CERTIFICATE OF CORRECTION

PATENT NO. : 7,850,521 B2
APPLICATION NO. : 11/464347
DATED : December 14, 2010
INVENTOR(S) : Rodgers et al.

Page 1 of 1

It is certified that error appears in the above-identified patent and that said Letters Patent is hereby corrected as shown below:

IN THE CLAIMS:

In Claim 13, column 26, line 64, replace the “,” with a “;”.

In Claim 13, column 27, line 18, replace “activations” with --re-activations--.

Signed and Sealed this
Eighth Day of March, 2011

A handwritten signature in black ink that reads "David J. Kappos". The signature is written in a cursive style with a large, stylized 'D' and 'K'.

David J. Kappos
Director of the United States Patent and Trademark Office

UNITED STATES PATENT AND TRADEMARK OFFICE
CERTIFICATE OF CORRECTION

PATENT NO. : 7,850,521 B2
APPLICATION NO. : 11/464347
DATED : December 14, 2010
INVENTOR(S) : Rodgers et al.

Page 1 of 1

It is certified that error appears in the above-identified patent and that said Letters Patent is hereby corrected as shown below:

On the Title Page:

The first or sole Notice should read --

Subject to any disclaimer, the term of this patent is extended or adjusted under 35 U.S.C. 154(b)
by 207 days.

Signed and Sealed this
Fourteenth Day of June, 2011

A handwritten signature in black ink that reads "David J. Kappos". The signature is written in a cursive, slightly slanted style.

David J. Kappos
Director of the United States Patent and Trademark Office