

US007509144B2

(12) **United States Patent**
Bettinger et al.

(10) **Patent No.:** **US 7,509,144 B2**
(45) **Date of Patent:** **Mar. 24, 2009**

(54) **SCALABLE COMMUNICATION SYSTEM, METHOD AND APPARATUS**

(75) Inventors: **David D. Bettinger**, Chantilly, VA (US); **Hai Quang Tang**, Olney, MD (US); **Christopher Robert Burdick**, Leesburg, VA (US); **Joseph J. Boone**, Fairfax, VA (US); **Gregory Carey Braunberg**, Manassas, VA (US); **Hao Cheng**, Herndon, VA (US); **Jason B. Maiorana**, Vienna, VA (US); **Chao Liu**, Fairfax, VA (US)

(73) Assignee: **VT iDirect, Inc.**, Herndon, VA (US)

(*) Notice: Subject to any disclaimer, the term of this patent is extended or adjusted under 35 U.S.C. 154(b) by 669 days.

(21) Appl. No.: **11/012,270**

(22) Filed: **Dec. 16, 2004**

(65) **Prior Publication Data**

US 2005/0152301 A1 Jul. 14, 2005

Related U.S. Application Data

(60) Provisional application No. 60/543,537, filed on Feb. 12, 2004, provisional application No. 60/530,264, filed on Dec. 18, 2003.

(51) **Int. Cl.**

H04B 1/38 (2006.01)
H04B 7/185 (2006.01)
H04B 1/08 (2006.01)
H04Q 7/20 (2006.01)

(52) **U.S. Cl.** **455/561**; 455/12.1; 455/349; 455/430; 370/316

(58) **Field of Classification Search** 455/3.02, 455/427, 12.1, 430, 349; 370/316
See application file for complete search history.

(56) **References Cited**

U.S. PATENT DOCUMENTS

5,544,222 A * 8/1996 Robinson et al. 455/557
7,170,889 B2 * 1/2007 Eagling et al. 370/360
2006/0052052 A1 * 3/2006 Jung et al. 455/3.01

* cited by examiner

Primary Examiner—Nick Corsaro

Assistant Examiner—Shannon R Brooks

(74) *Attorney, Agent, or Firm*—Oblon, Spivak, McClelland, Maier & Neustadt, P.C.

(57) **ABSTRACT**

A communication system, method, computer program product, and apparatus include common equipment shared between multiple independently administered networks. The common equipment is reconfigurable and expandable and provides changed communication capacity and functions when additional elements are added or reconfigured. Configurable features include, for example, communication bandwidth, Quality of Service, and a number of communication satellites included in the communication system. The common equipment includes expandable elements including, for example, a single hub modem chassis that can expand to communicate with more than one communication satellite and a protocol processor that can share a protocol processing task with another protocol processors.

37 Claims, 24 Drawing Sheets

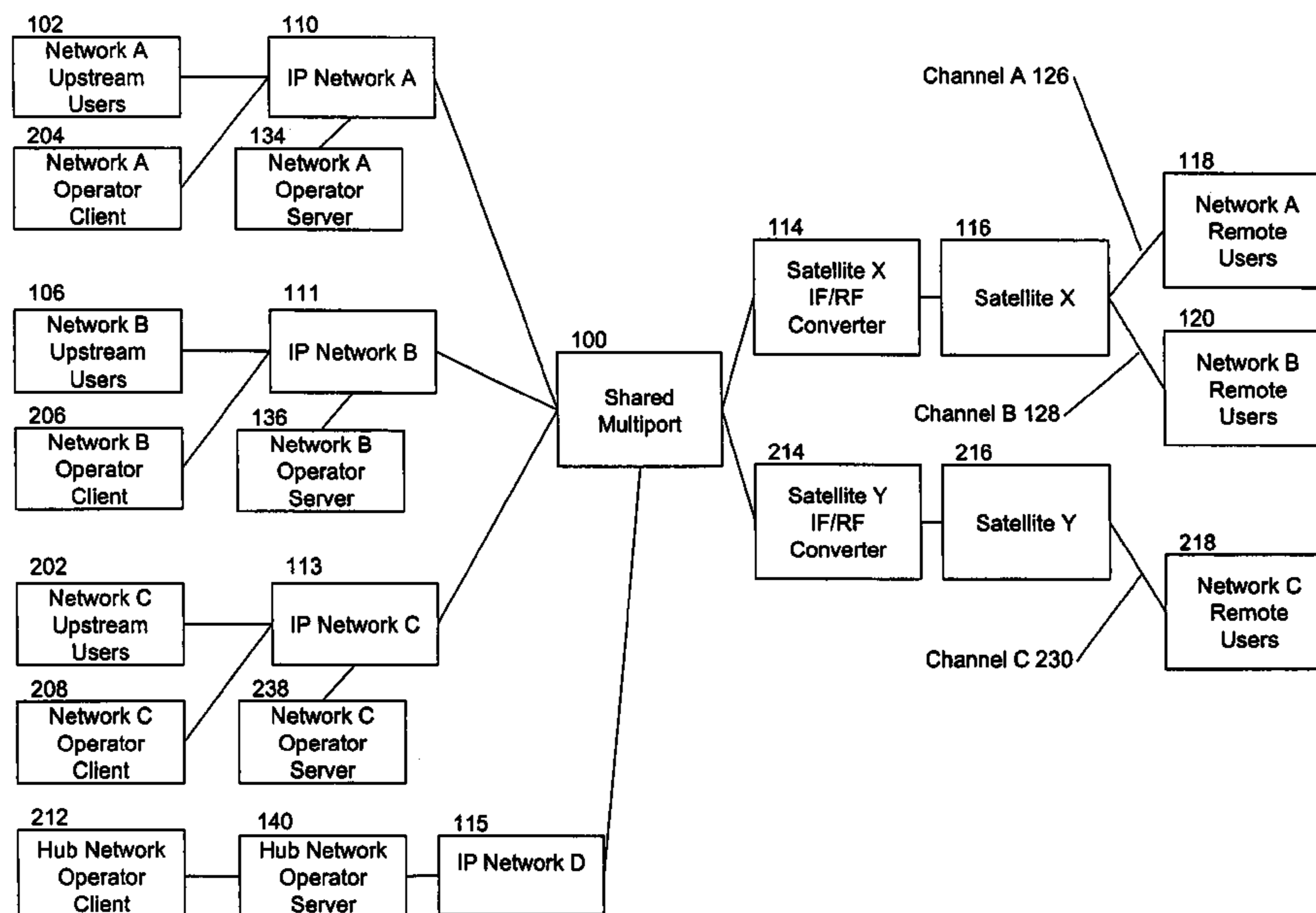

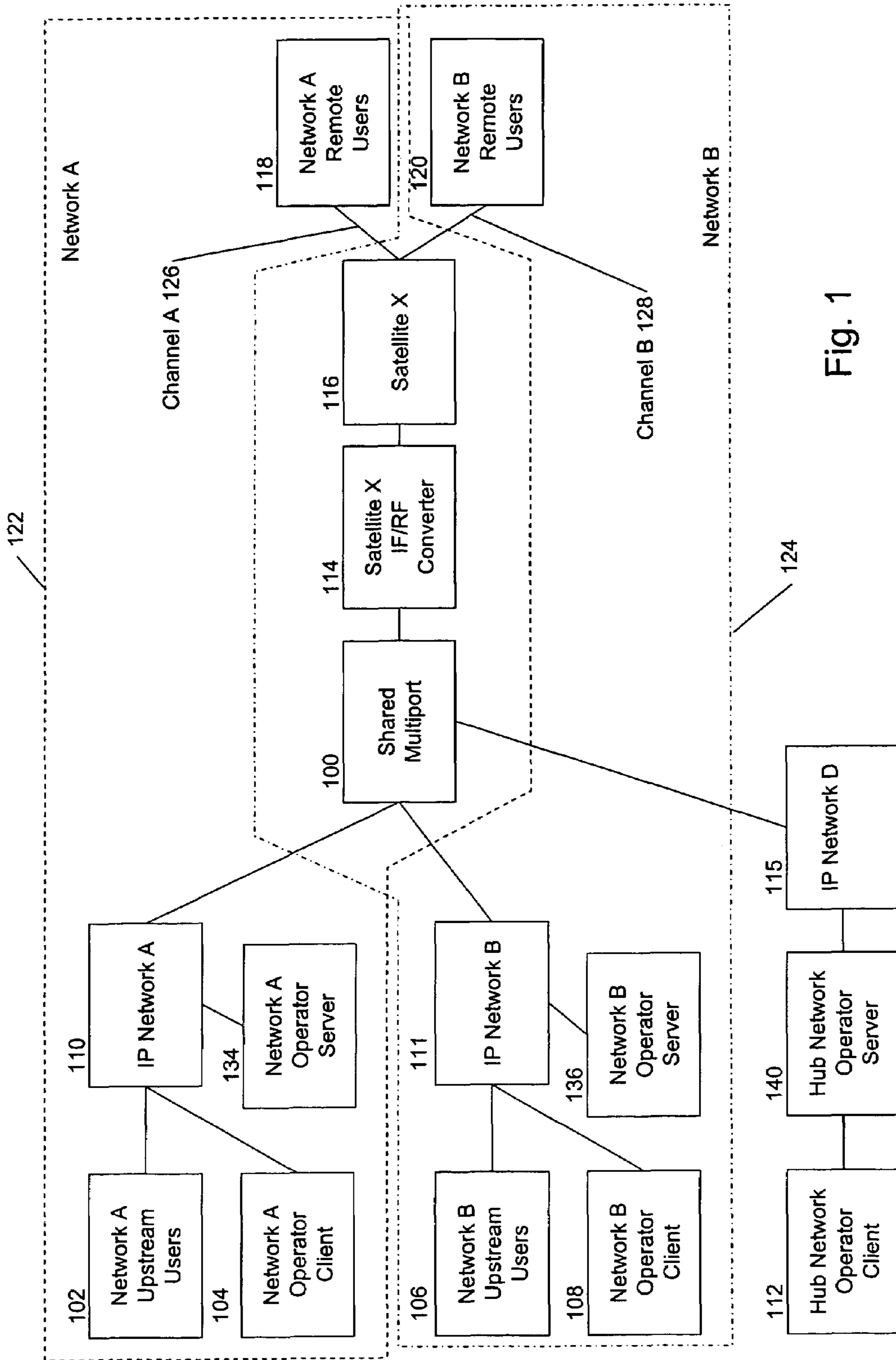

Fig. 1

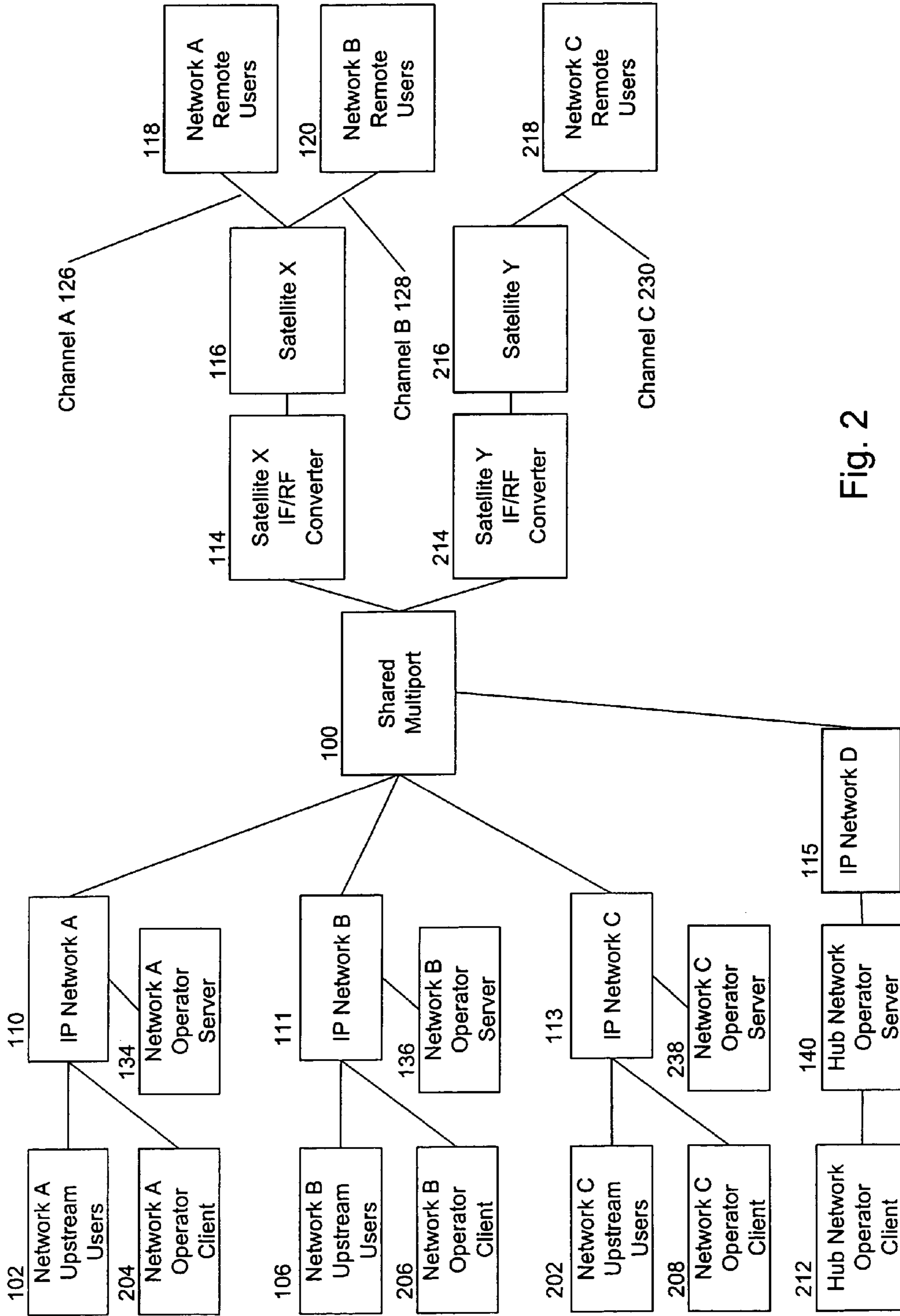

Fig. 2

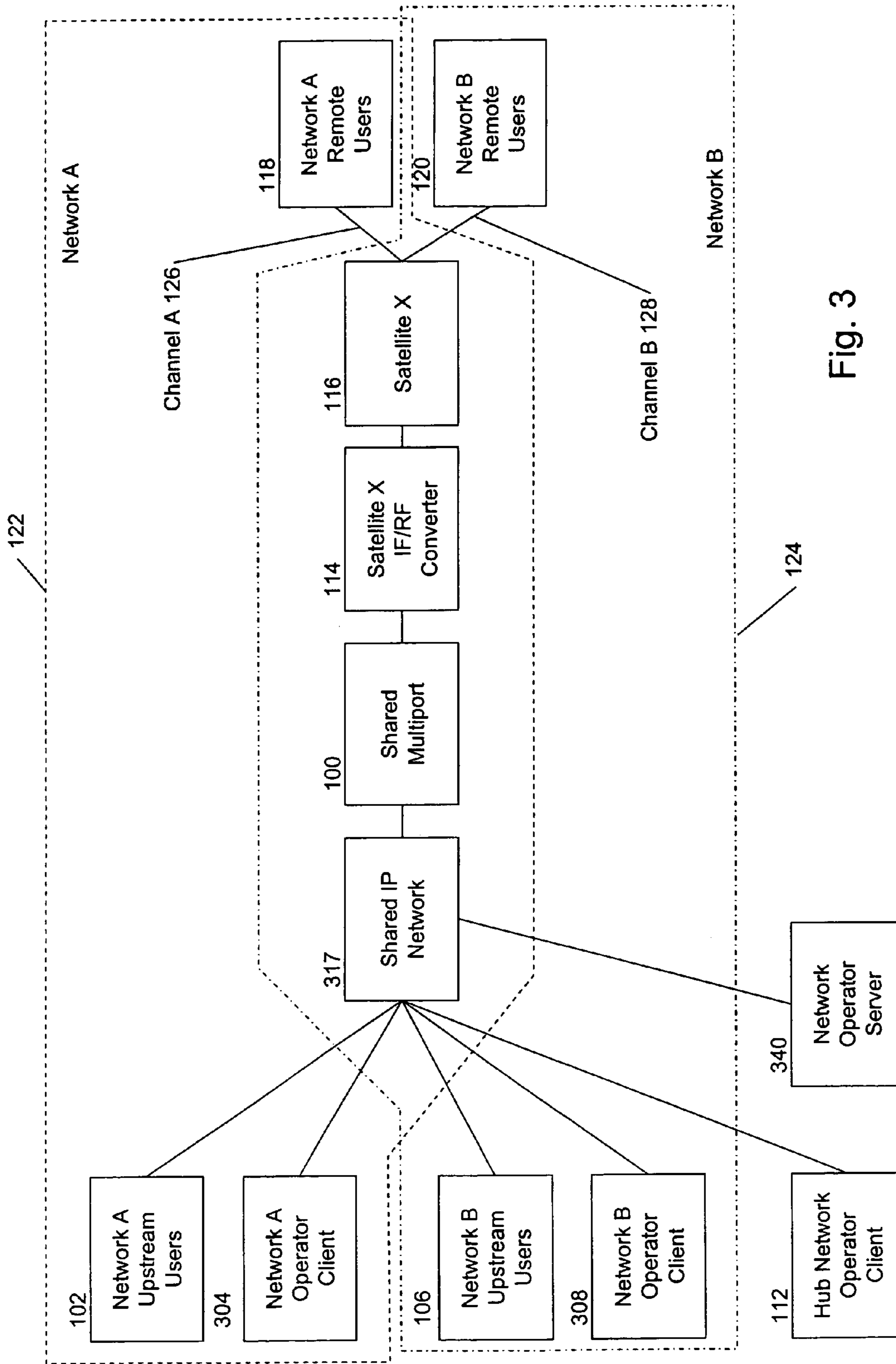

Fig. 3

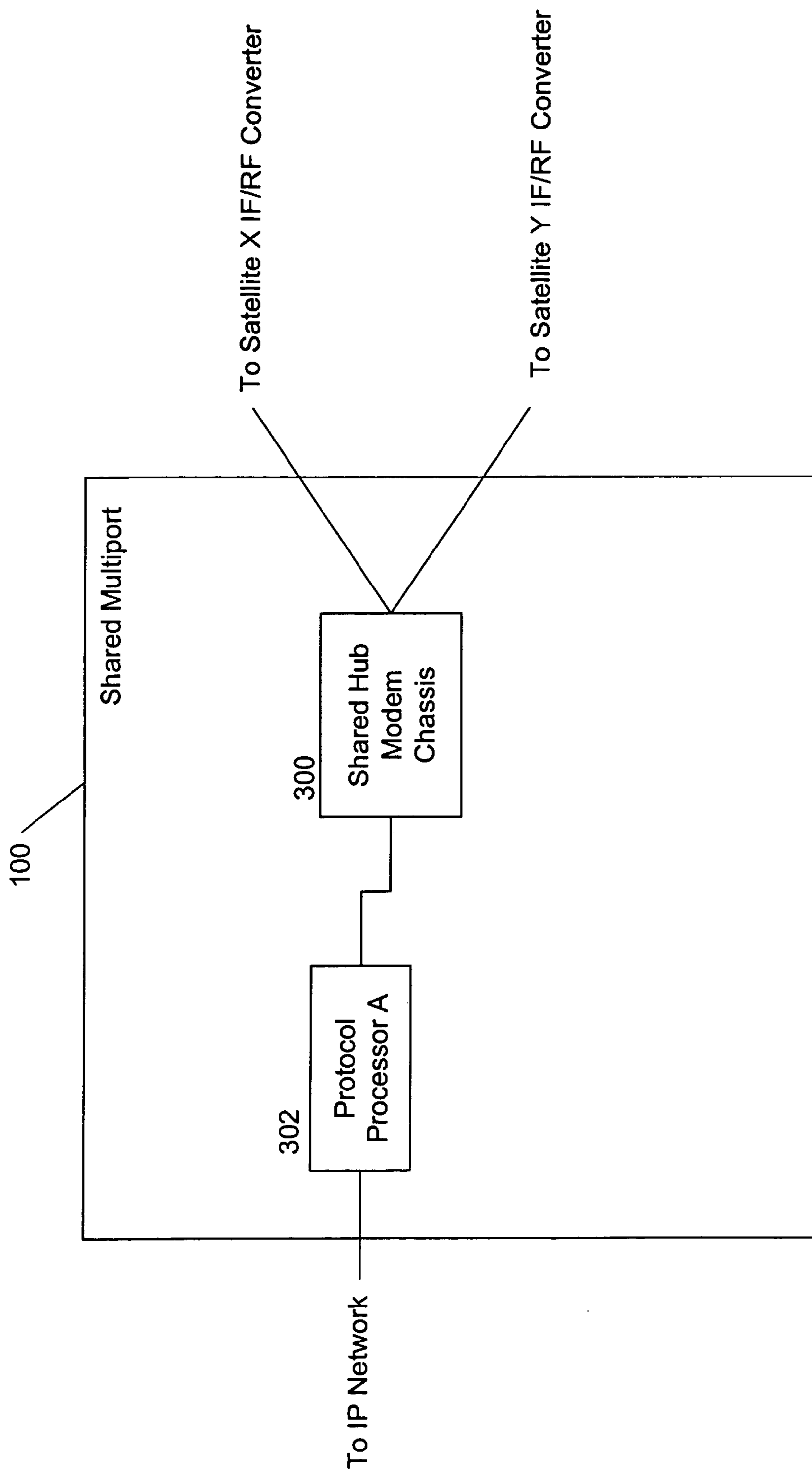

Fig. 4

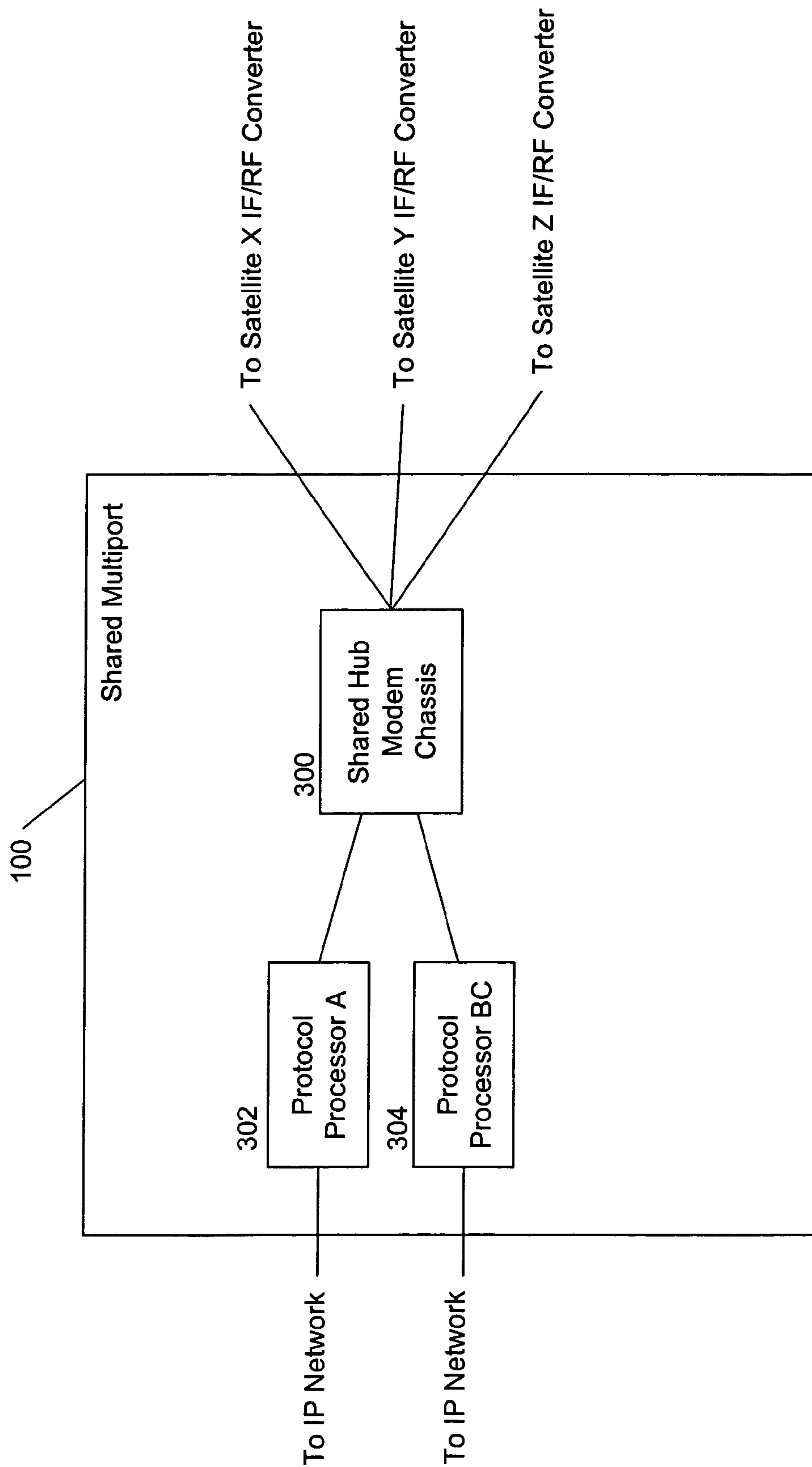

Fig. 5A

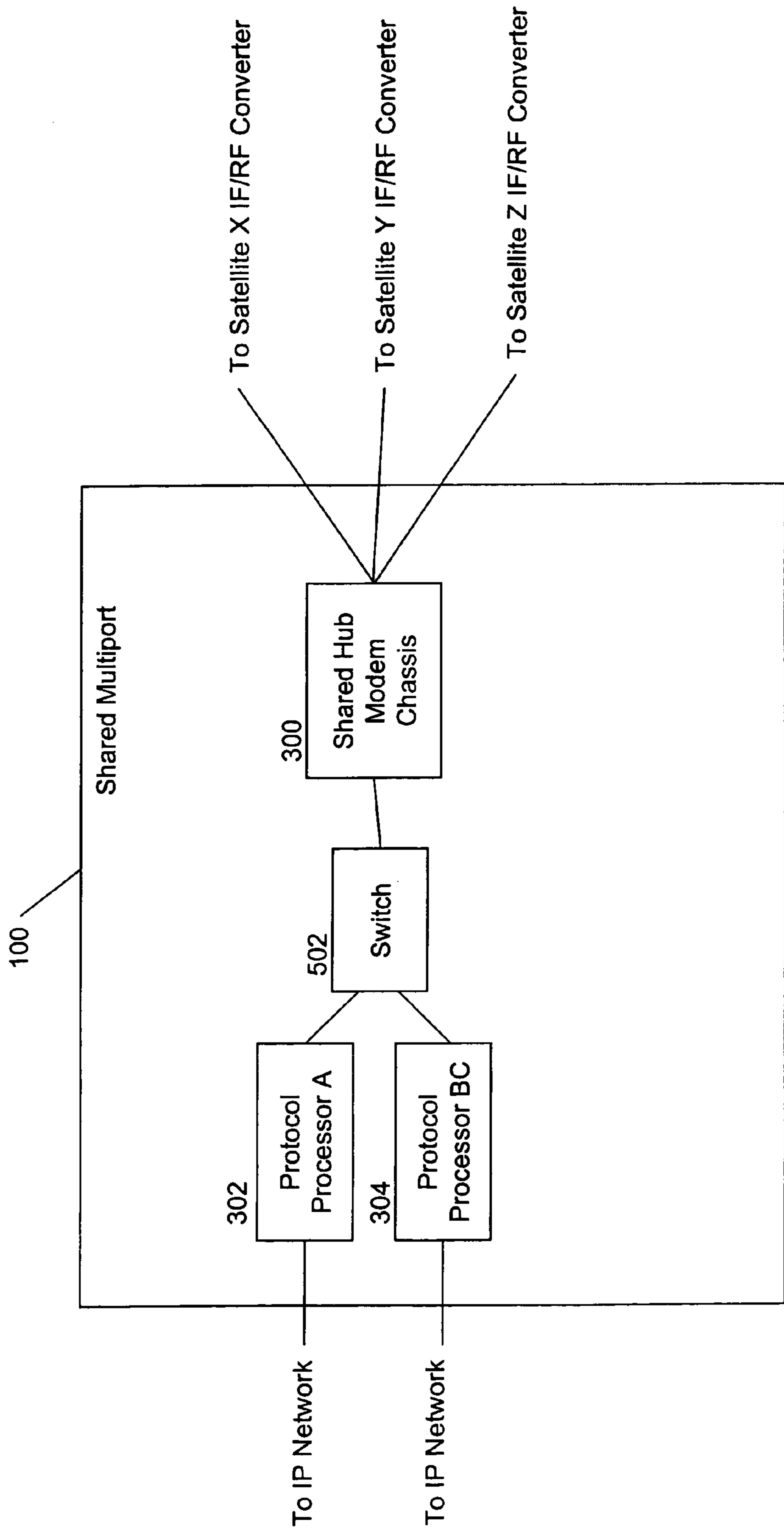

Fig. 5B

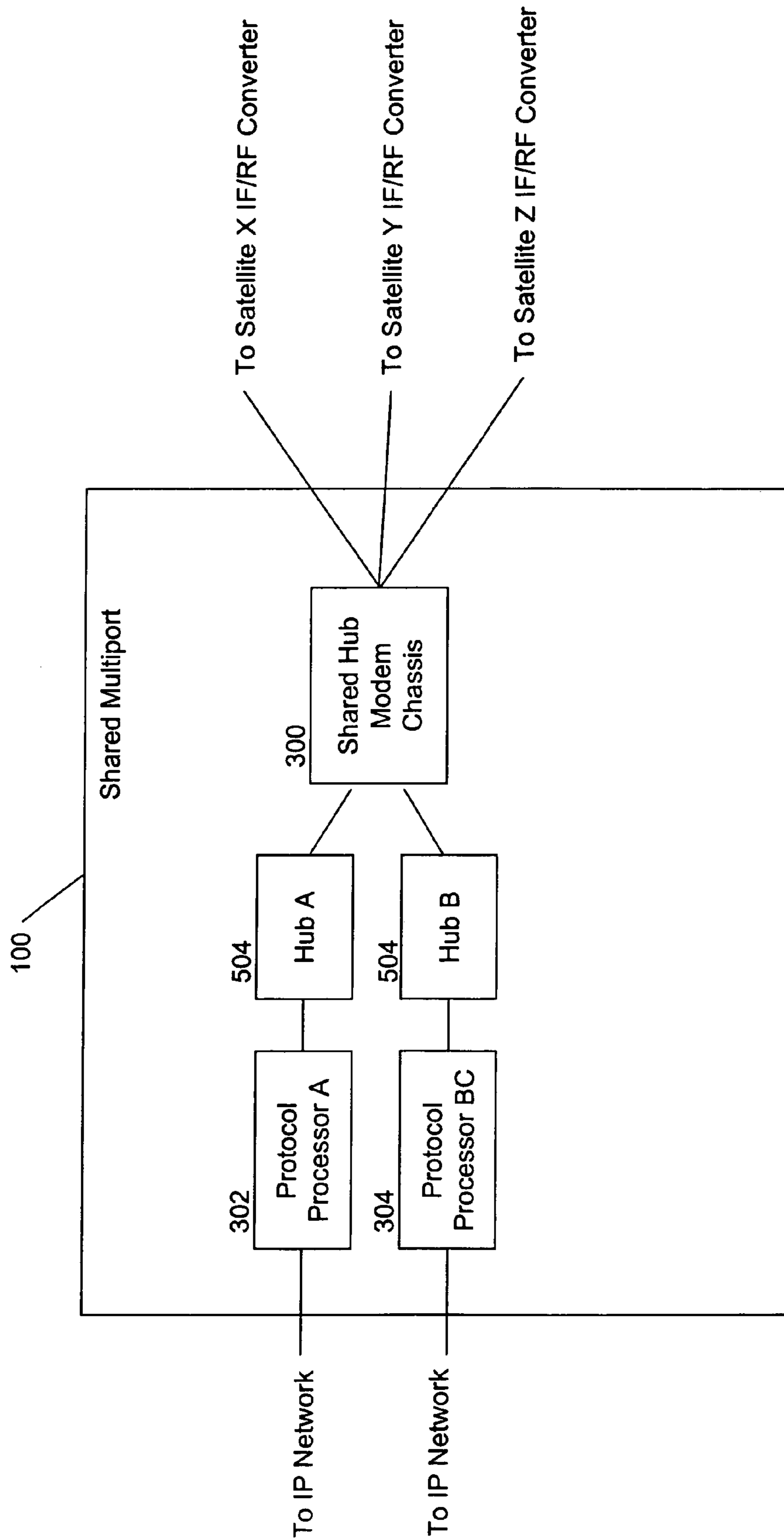

Fig. 5C

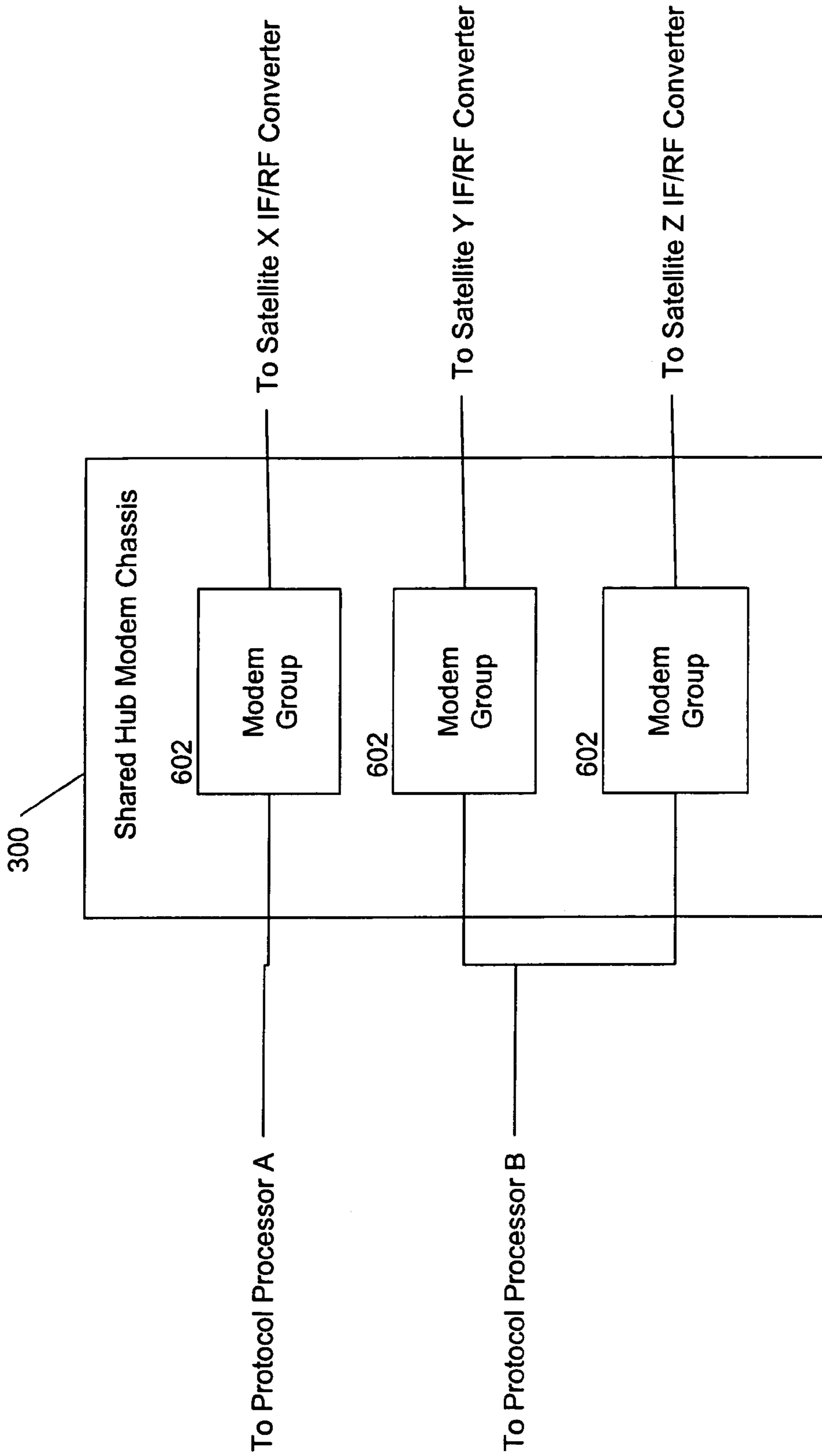

Fig. 6

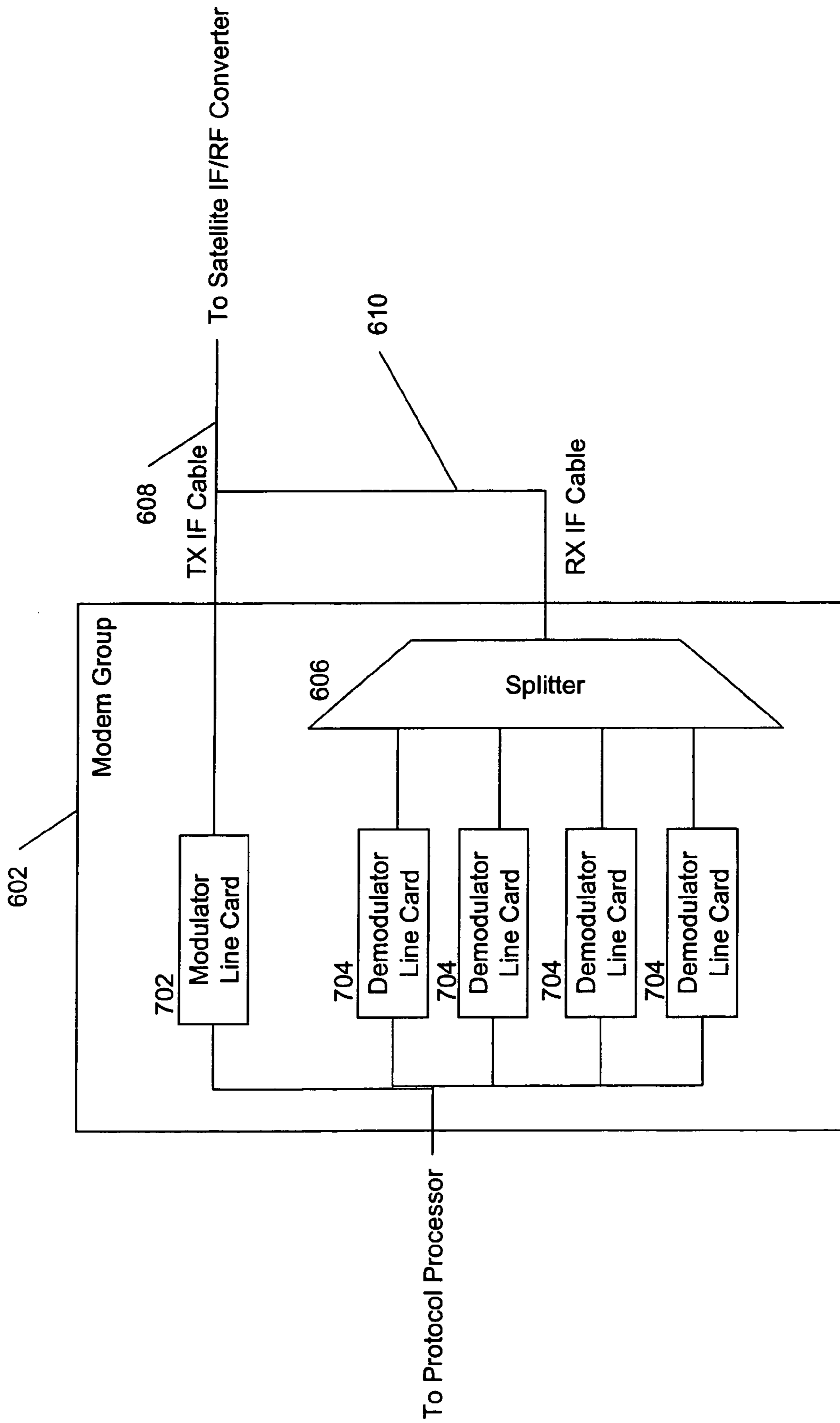

Fig. 7

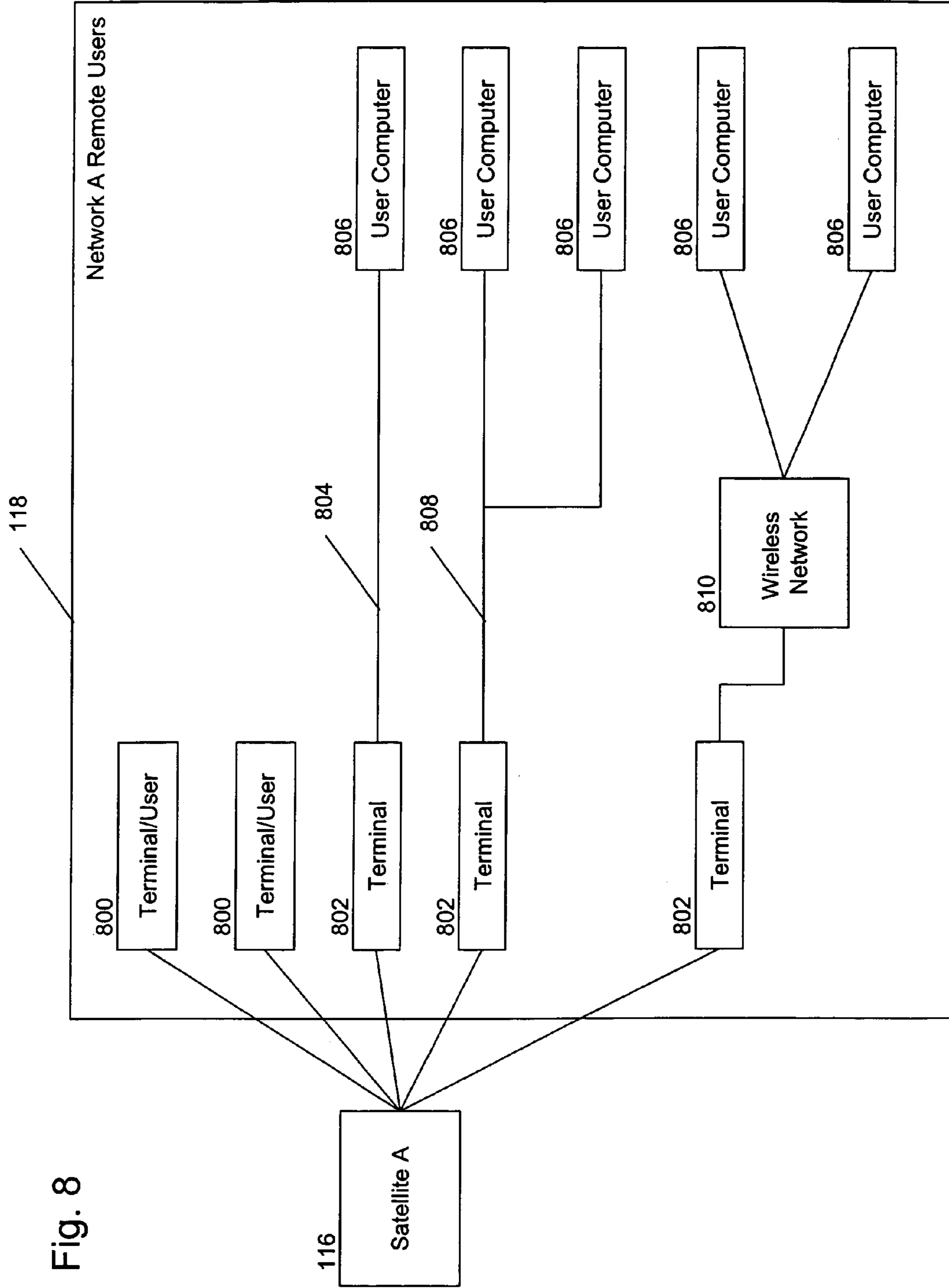

Fig. 8

Fig. 9A

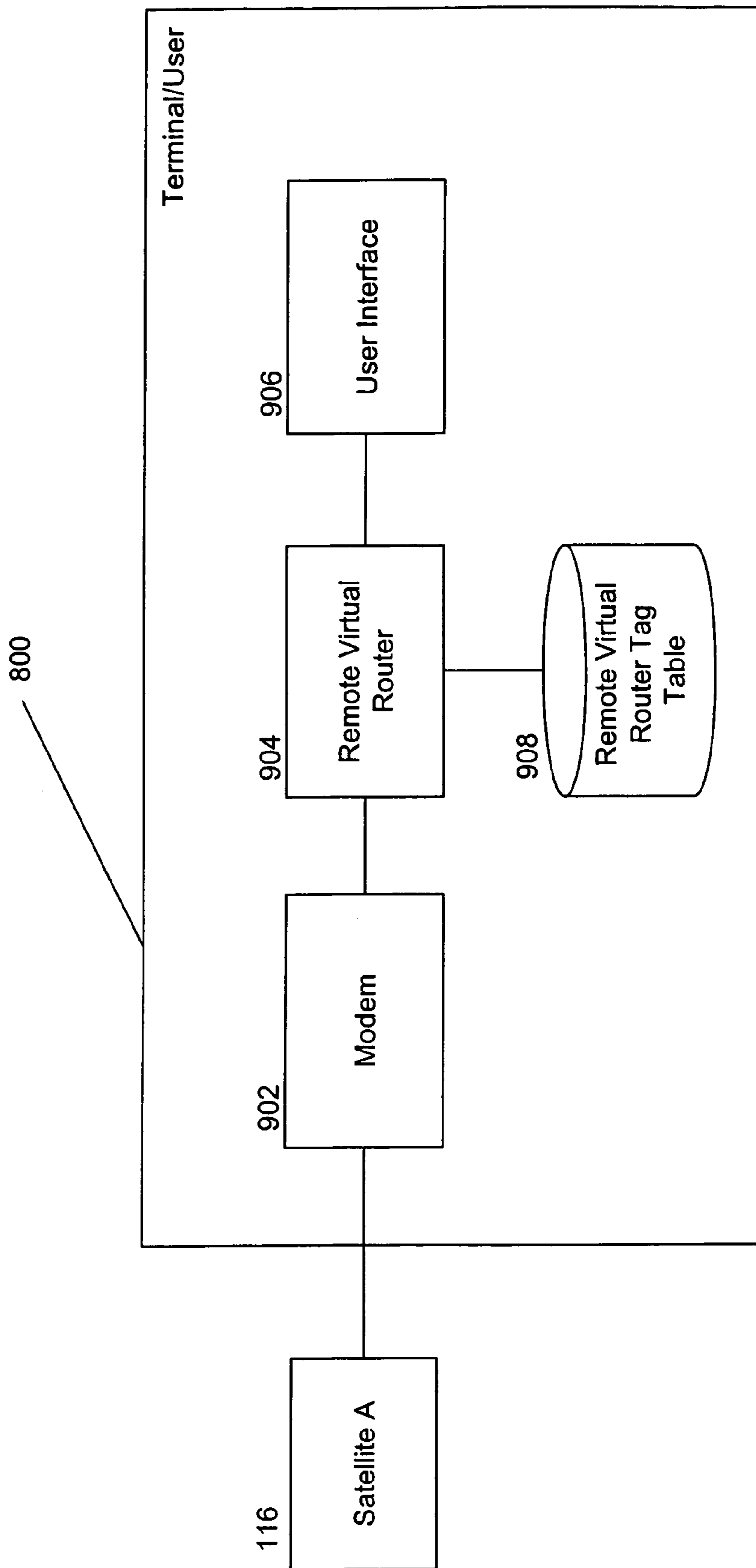

Fig. 9B

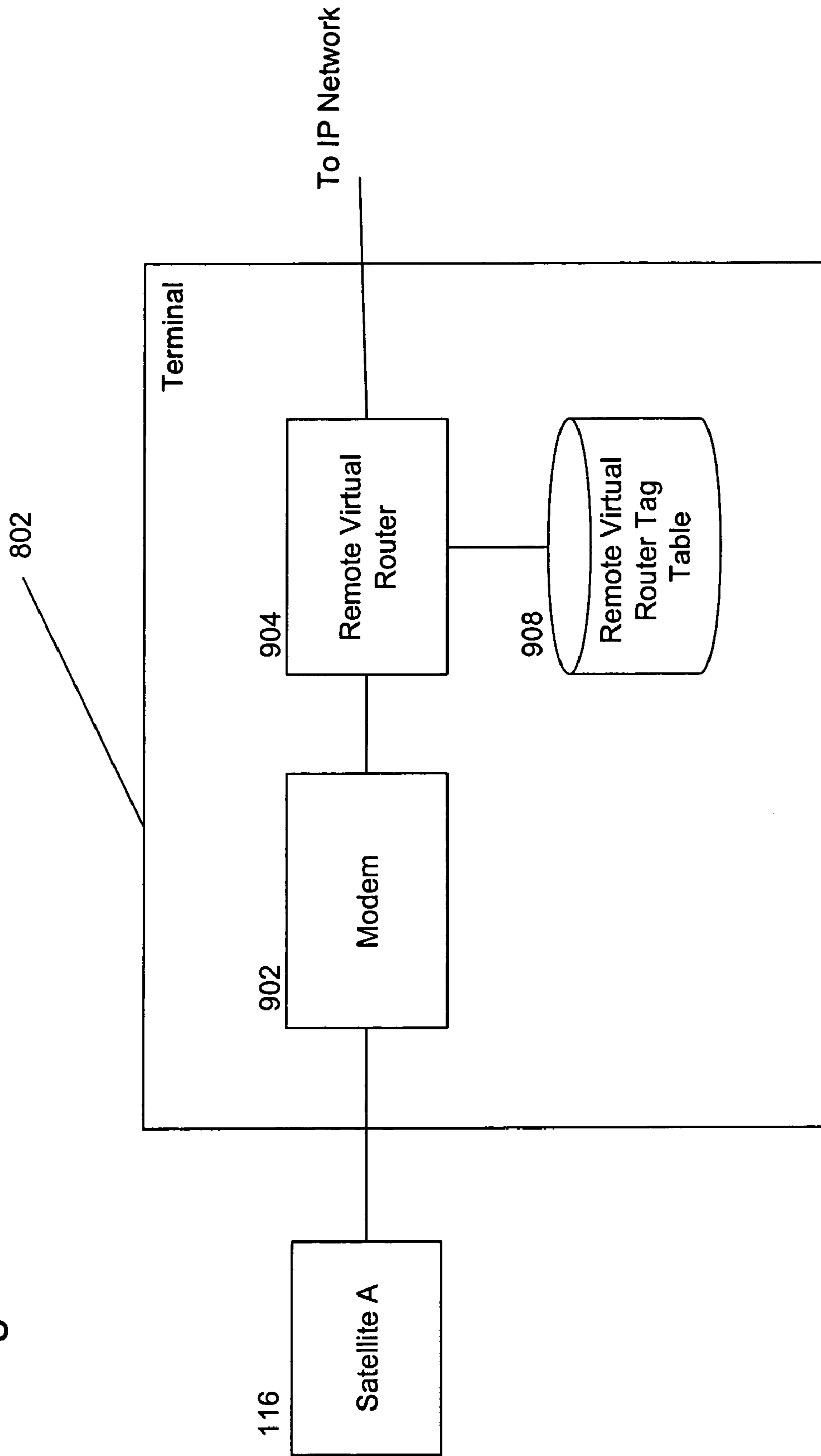

Fig. 9C

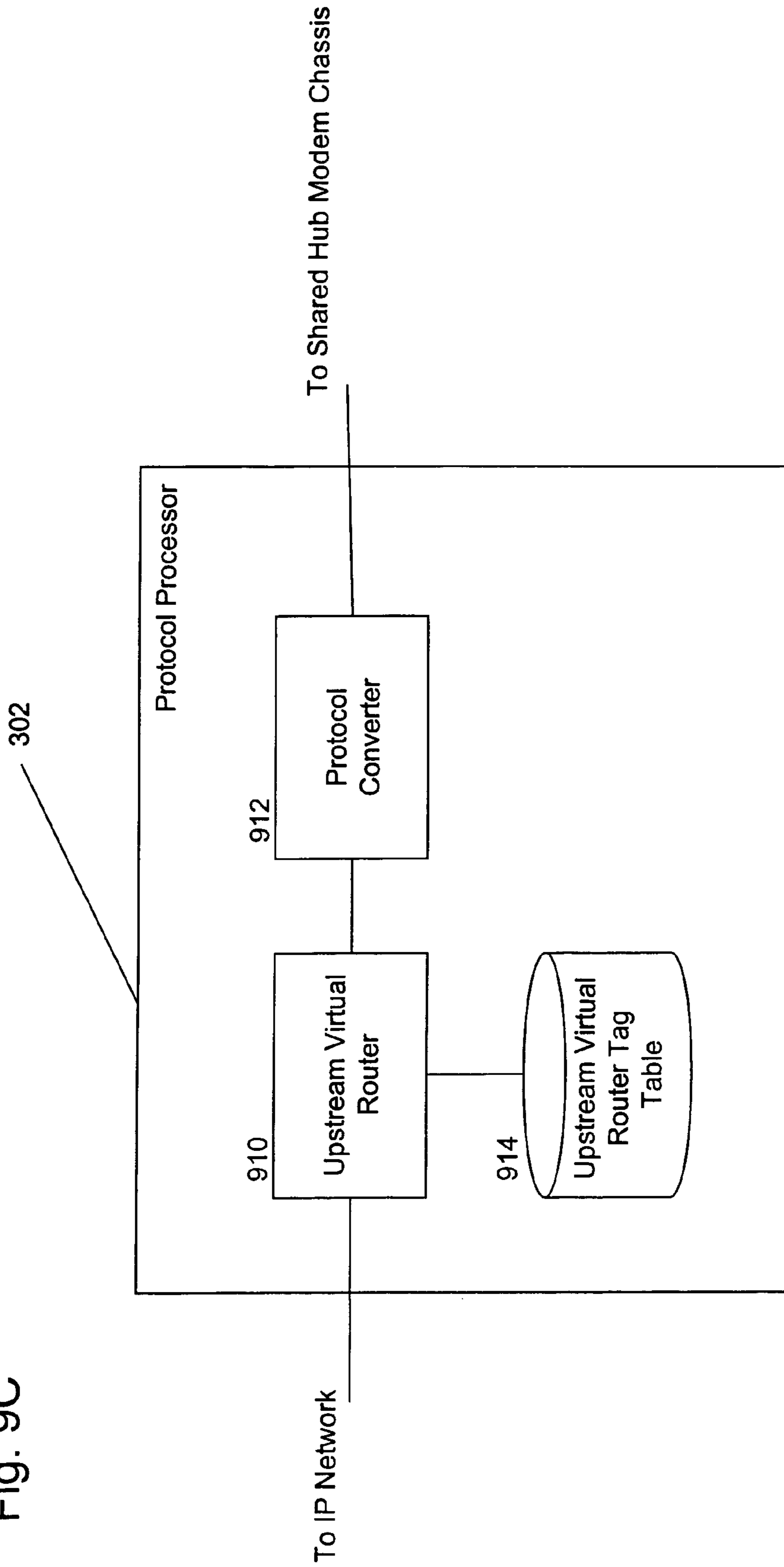
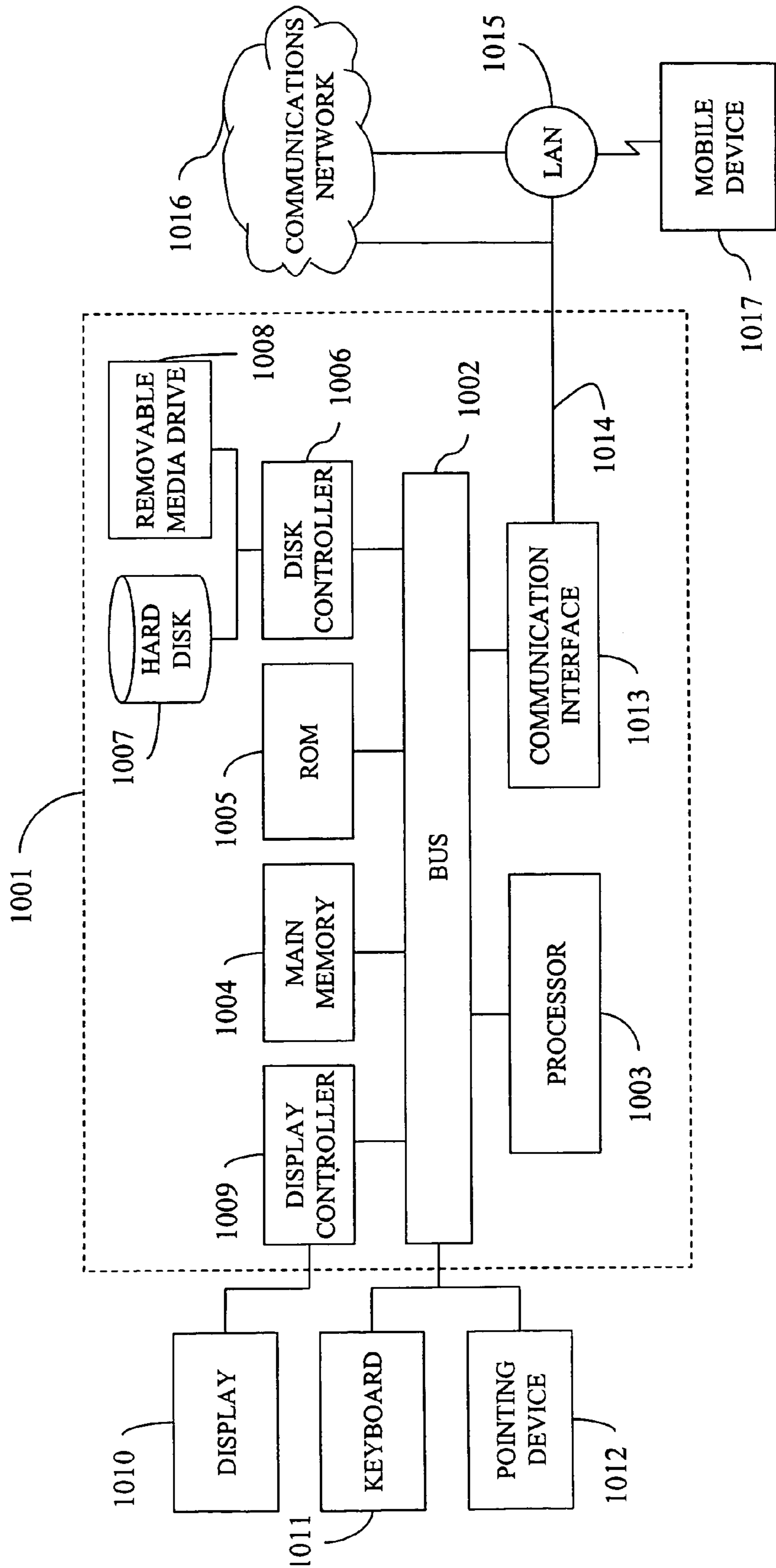

Fig. 10



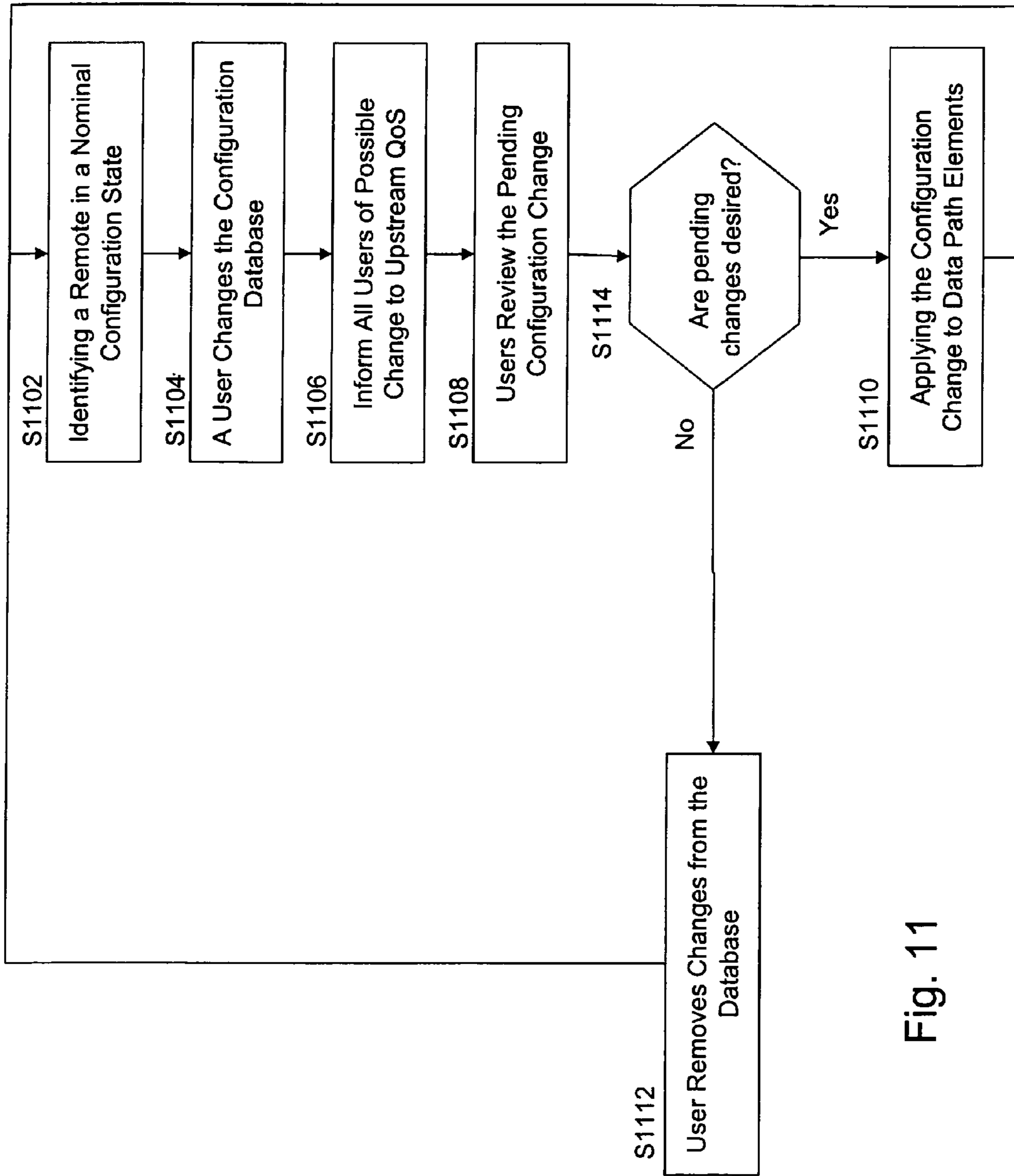

Fig. 11

CONFIGURATION STATE	NETWORK ELEMENT	MEANING
Nominal	Network, Chassis, Line Card, Remote	The element is completely configured, is alive in the network, and there are no unapplied changes.
Changes Pending	Network, Chassis, Line Card, Remote	The element is completely configured and is alive in the network. There are changes in the database that have not been applied.
Incomplete	Network, Chassis, Line Card, Remote	The element is only partially configured; one or more key components of the configuration are unspecified (e.g. carriers, IP address, serial number)
Never Applied	Network, Chassis, Line Card, Remote	The element is completely configured but the configuration has never been applied to the element.
Deactivated	Remote	The remote modem was at one time active in the network, but it has been deactivated.

Fig. 12

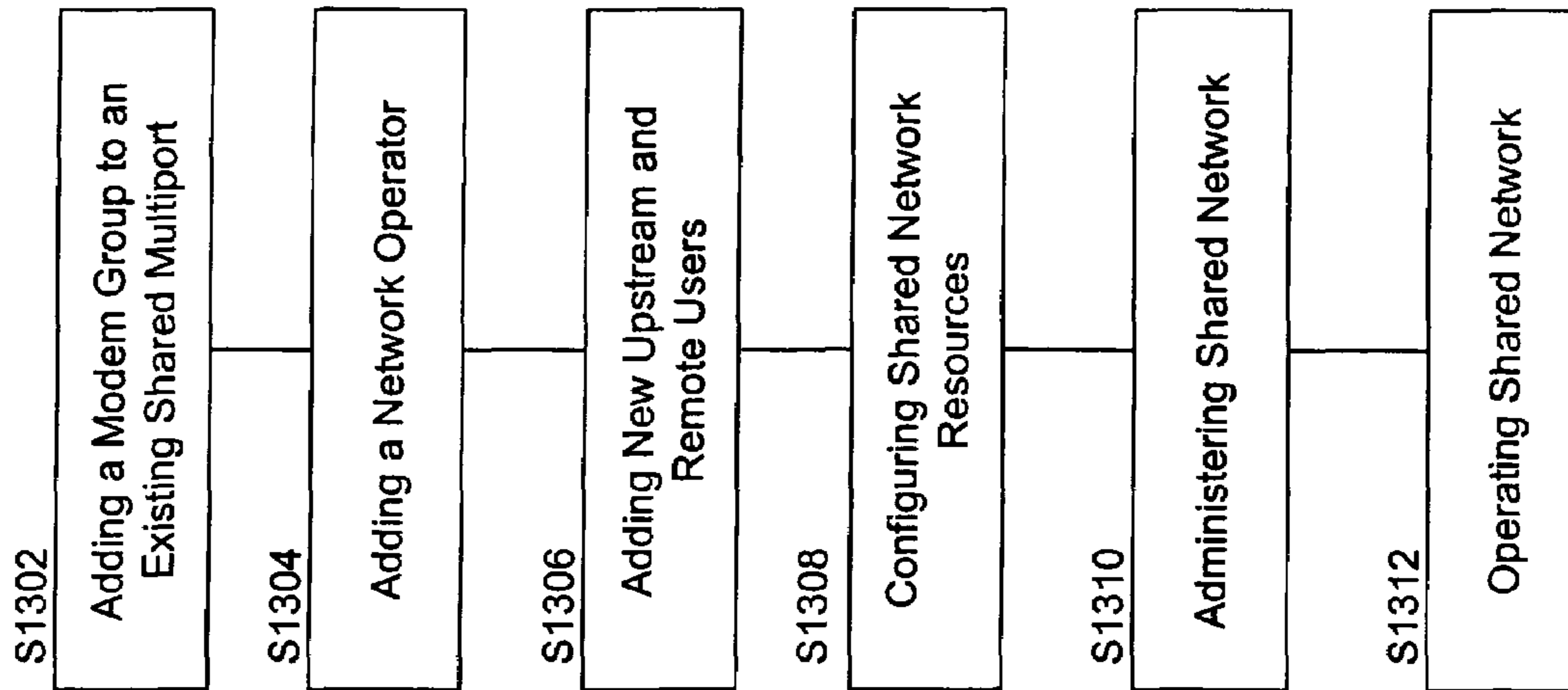

Fig. 13A

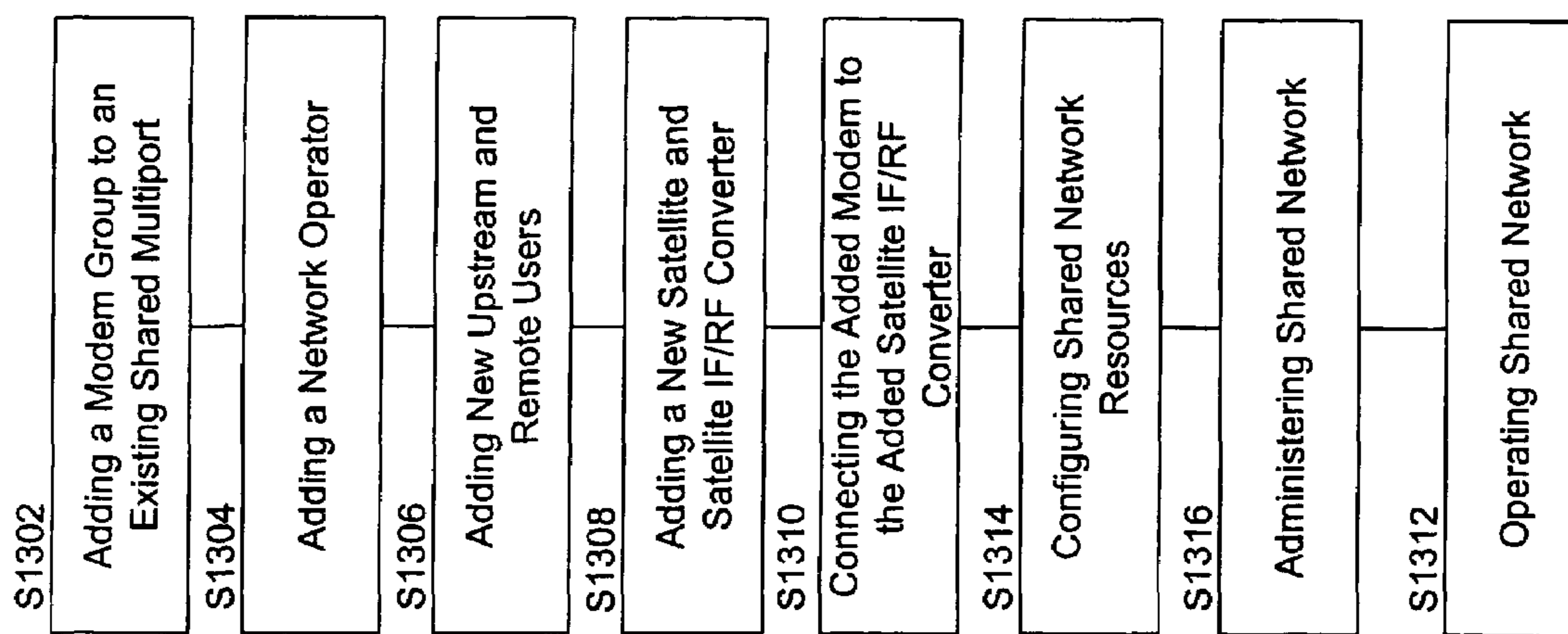

Fig. 13B

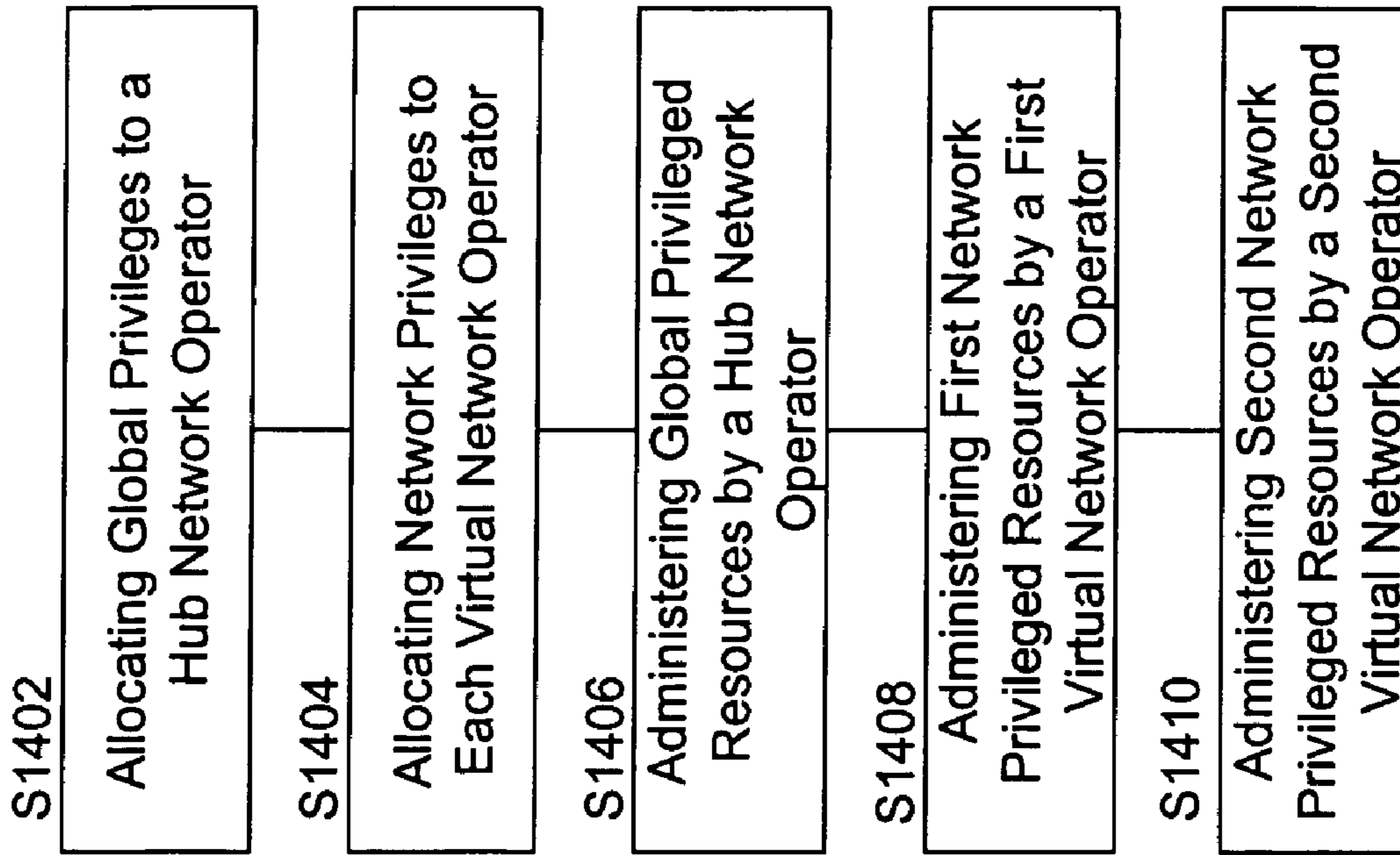

Fig. 14

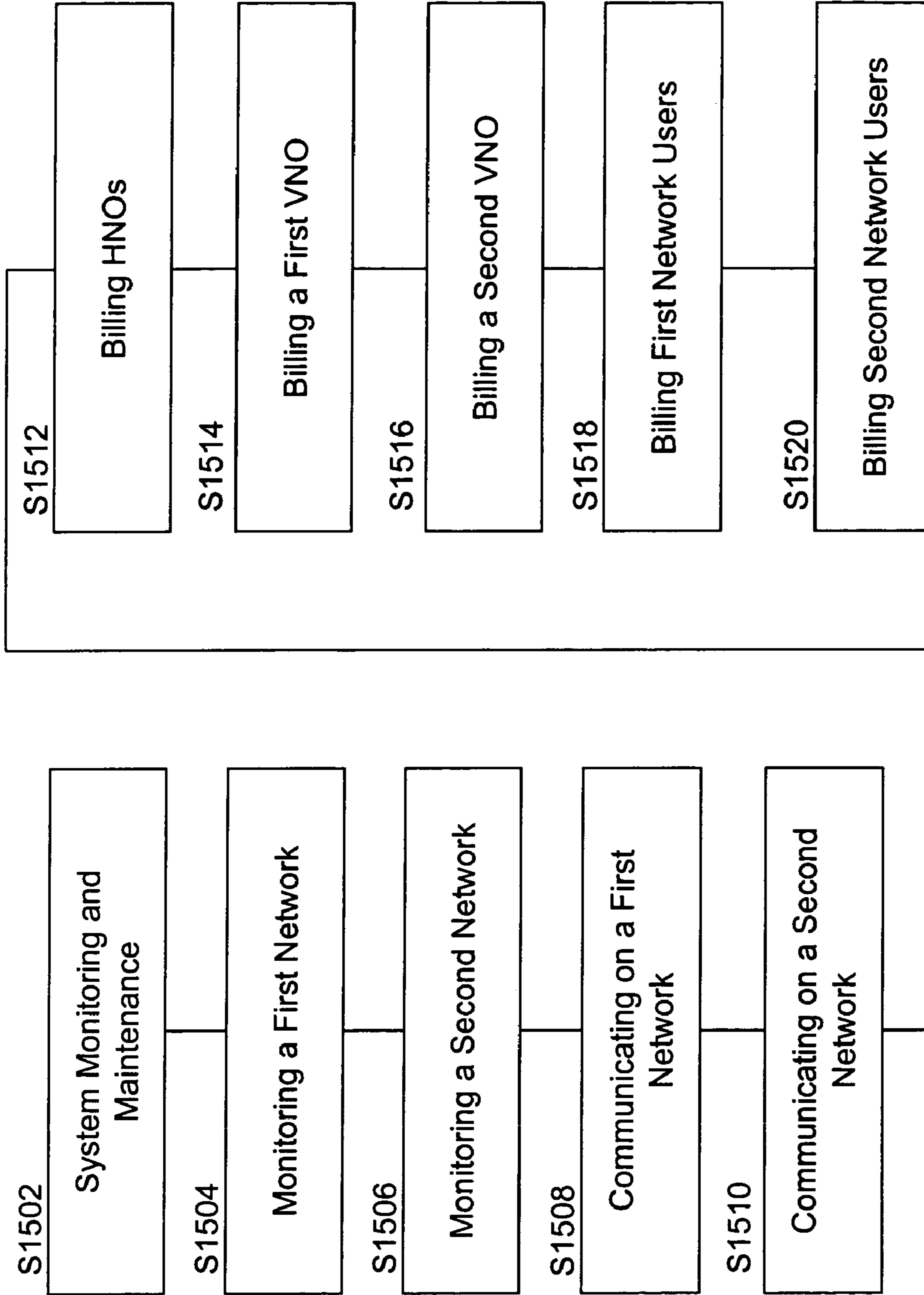

Fig. 15

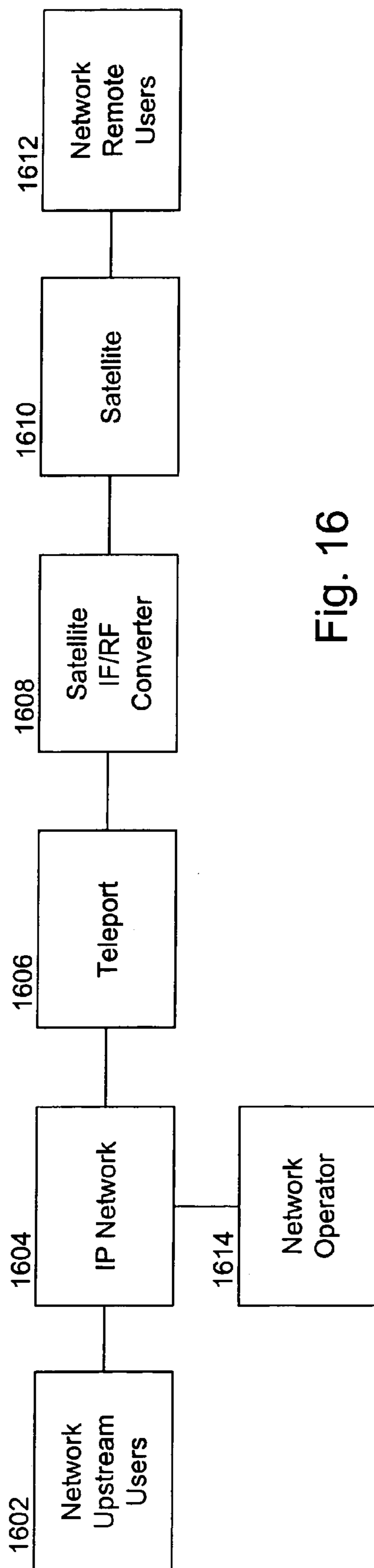

Fig. 16

Background Art

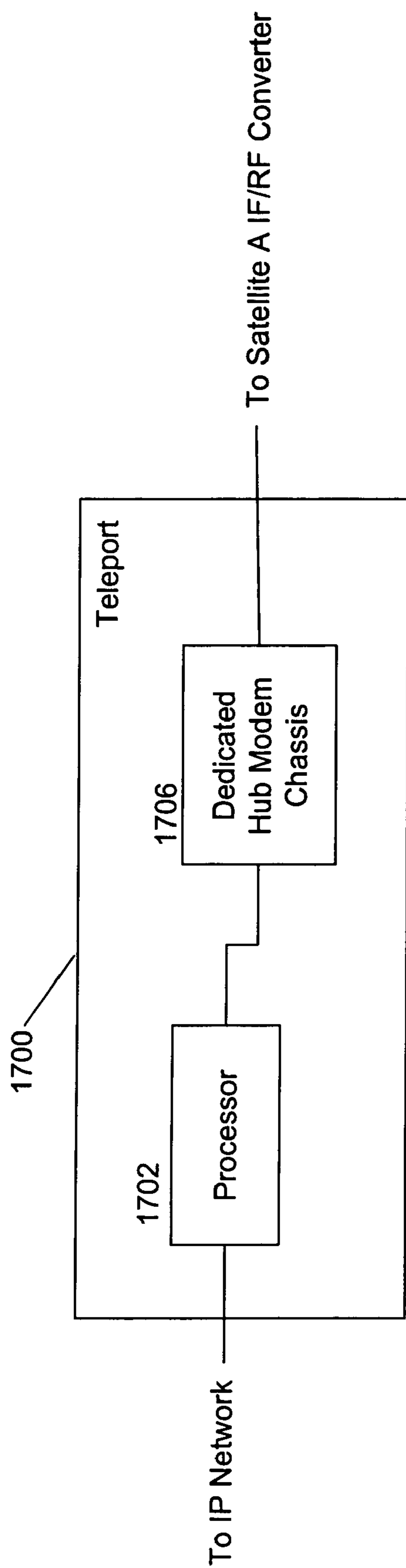

Fig. 17A

Background Art

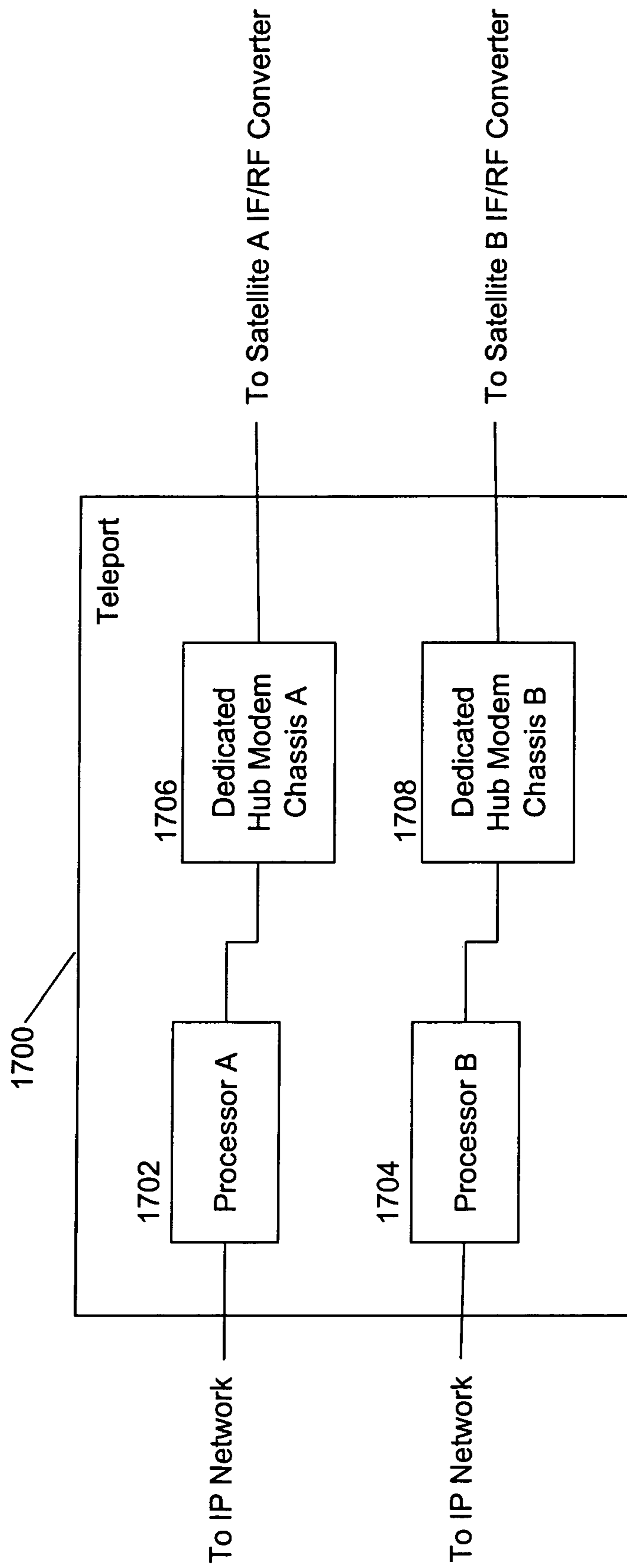

Fig. 17B

Background Art

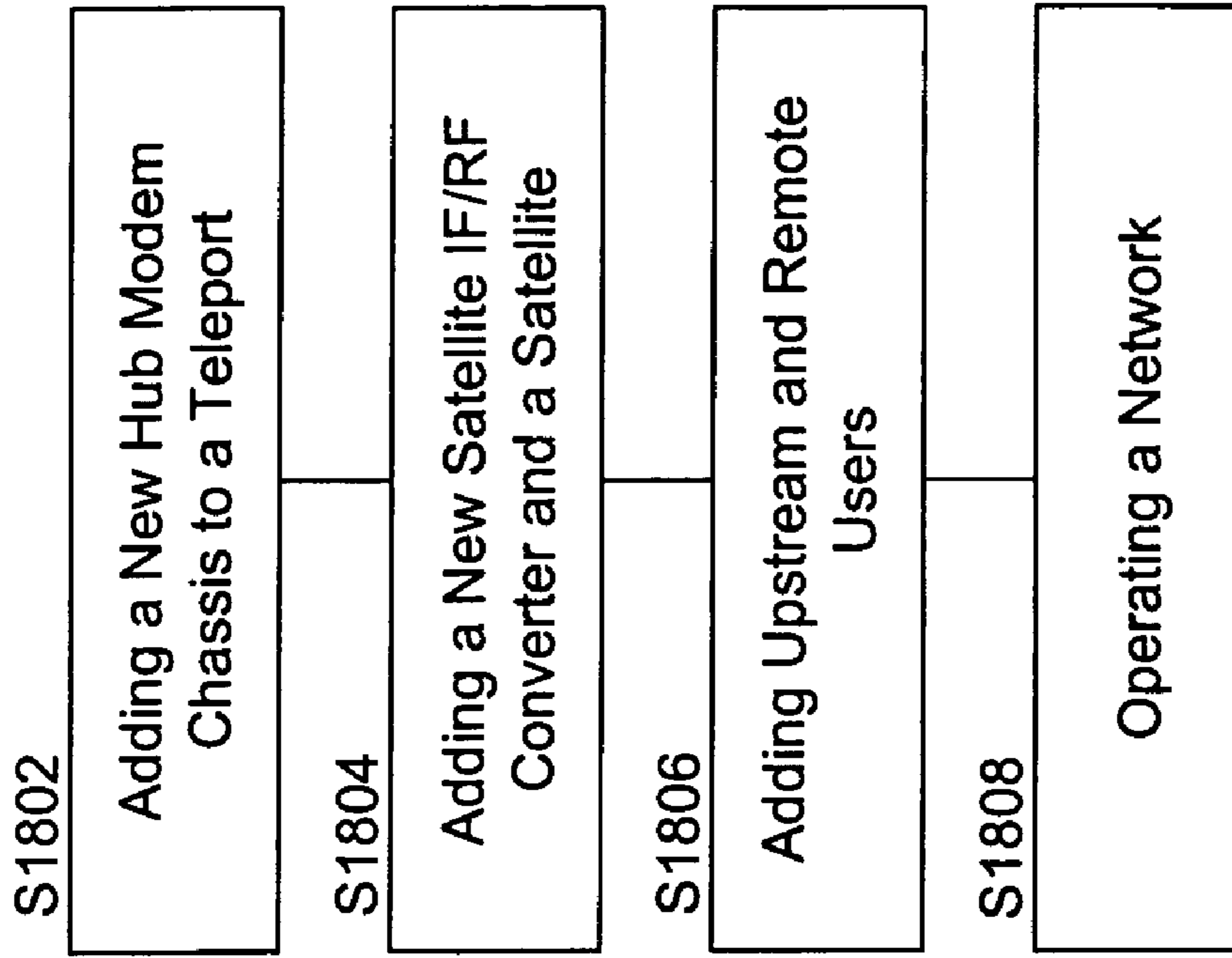

Fig. 18

Background Art

SCALABLE COMMUNICATION SYSTEM, METHOD AND APPARATUS

CROSS REFERENCE TO RELATED APPLICATIONS

The present application contains subject matter related to that disclosed in commonly owned U.S. patent application Ser. No. 11/012,256, entitled HUB MODEM SYSTEM, METHOD AND APPARATUS, filed Dec. 16, 2004; U.S. patent application Ser. No. 11/012,343, entitled CONFIGURATION STATE MANAGEMENT SYSTEM, METHOD AND APPARATUS, filed Dec. 16, 2004; U.S. patent application Ser. No. 11/012,269, entitled VIRTUAL ROUTER SYSTEM, METHOD AND APPARATUS, filed Dec. 16, 2004; and U.S. patent application Ser. No. 11/012,359, entitled VIRTUAL NETWORK OPERATOR SYSTEM, METHOD AND APPARATUS and claims priority to U.S. provisional patent application Ser. No. 60/530,264, entitled NETWORK MANAGEMENT SYSTEM, filed Dec. 18, 2003, and U.S. provisional patent application Ser. No. 60/543,537, entitled METHOD AND APPARATUS AND SYSTEM FOR SHARING A NETWORK HUB BETWEEN MULTIPLE AND INDEPENDENTLY ADMINISTERED SATELLITE NETWORKS, filed Feb. 12, 2004, the entire contents of each of which being incorporated herein by reference.

BACKGROUND OF THE INVENTION

1. Field of the Invention

The present invention relates to communication networks and more particularly to a communication system including shared, independently managed communication networks. The present invention also relates to a method of providing shared independently managed communication networks, and to an apparatus in a shared independently administered network. Further, the present invention relates to communication networks that are satellite communication networks.

2. Discussion of the Background

A conventional satellite network communication system business method includes a satellite network provider and satellite network users. The satellite network provider obtains all the equipment, including teleport, remote equipment and related software, and provides communication network services to network users for a fee.

FIG. 16 shows an example of a conventional satellite network communication system including network upstream users 1602 and network remote users 1612 that communicate via Internet Protocol (IP) network 1604, teleport 1606, satellite IF/RF converter 1608 and satellite 1610. Further, a network operator 1614 performs network management functions. A teleport 1606 provides a connection between an IP network and a single IF/RF converter 1608 with a connection to a single satellite 1610.

FIG. 17A shows an example of the composition of teleport 1606, including processor 1702 and dedicated hub modem chassis 1706.

FIG. 17B shows another example of a background teleport 1700 that is similar to teleport 1606. However, background teleport 1700 includes connections to two satellite IF/RF converters connected to two different satellites. Teleport 1700 includes processor A 1702 connected to an IP network, processor B 1704 connected to an IP network, a dedicated hub modem chassis A 1706, and a dedicated hub modem chassis B 1708. Dedicated hub modem chassis A 1706 provides an intermediate frequency (IF) connection to the satellite A

IF/RF converter, which in turn connects via a radio frequency (RF) path to satellite A (not shown), and dedicated hub modem chassis B 1708 provides an IF connection to the satellite B IF/RF converter, which in turn connects via a RF path to satellite B (not shown).

Thus, in this system a dedicated hub modem chassis is required for each satellite in a teleport, and each dedicated hub modem chassis can provide a connection to only a single satellite, via a satellite IF/RF converter. As recognized by the present inventors, additional expenses are unnecessarily incurred when more than one satellite network is to be operated at a teleport. In addition, the addition of a new network necessitates installation and administration of an additional teleport or an additional hub chassis for the new network. Thus, considerable planning and expense are incurred when adding a new network.

FIG. 18 shows an example of a conventional method of operating a satellite communications network. When a new independently managed network is required, a new hub modem chassis must be added to a teleport, as shown in step S1802. In addition, a new satellite IF/RF converter and a new satellite must be added to the communication system, as shown in step S1804. Next, the method includes adding upstream and remote users, as shown in step S1806, and operating the network, as shown in step S1808.

As recognized by the present inventors, it is difficult to incrementally add capabilities for new users. For example, to create a new independently managed private satellite network, a satellite system provider must obtain, install, configure and manage at least an additional hub modem chassis and line cards for the additional hub modem chassis.

Also, it is difficult to increase or decrease the amount of bandwidth allocated to a particular network. To increase the number of carriers allocated to a particular network (i.e., upstream) or adding a new network (i.e., modem group and associated equipment for a network) in the background art, it is necessary to add a teleport or add an additional hub modem chassis, thereby incurring significant capital expense.

An alternative background approach is to combine a plurality of smaller customers on a single network, and varying the amount of bandwidth allocated to each customer on that network as required. However, in that alternative approach each network user does not have control over key network parameters like IP address assignment, QoS, number of upstreams, and frame lengths. Further, security (e.g., password scheme, level of encryption (at least up to Layer 3)) options are the same for all satellite network system users in the background approach.

Further, this alternative background approach does not allow each user to customize the single network for their particular application (e.g., VoIP, web browsing, shared database, etc. . . .). Thus, customers are not able to independently take advantage of all network features and are required to coordinate the control of those features with a third party network operator, thereby increasing expense and reducing customer flexibility and autonomy. Alternatively, to get flexible control over these network parameters, each user of the background approach would disadvantageously need to spend additional money to set up independent networks dedicated to their application and tailored to their needs.

Further, this conventional satellite communication network includes a large number of interrelated configuration parameters. The configuration parameters are interrelated because changes to parameters in one part of the communication network has an impact on another part, and may require further changes to that other part of the network. A background method of configuring a satellite communication

network includes changing each of the parameters one at a time from a network operator workstation and after the final parameter is changed, waiting until the system stabilizes to see if the changed parameters had the desired effect. For example, to change an IP address of a remote user in a background system, a network operator enters the new IP address in the remote user software, and then enters the new IP address in each related computer that communicates with the remote user's IP address. Then, after the final IP address is changed, the operator waits to see if the change had the desired effect.

The present inventors recognized that a problem with this method of configuring a satellite communication network is that as configuration parameters are changed, those changes may cause undesirable temporary effects in the communication network. Further, those effects may ripple through the communication network, causing problems that are more difficult to repair. For example, when changing the IP address in the example shown above, after changing the IP address on the remote user software, a remote user loses the ability to communicate on the IP network, and may start a communication recovery action that may include sending messages to a domain name server for example, or may include other error recovery attempts that in turn may result in other errors that must be corrected. Consequently, operation of such a communication system may be disadvantageously disrupted during a change of configuration.

In addition, each user of a satellite network system shares a single IP address space. For example, if multiple independent users on a single network have network equipment with the same IP addresses, in this conventional system, those independent users are required to change their IP addresses in a coordinated manner to ensure that no two devices have the same IP address. Thus, users of the background satellite network system do not have a mechanism for independently defining IP addresses to allow independent assignment of IP addresses that may be the same, if multiple users each want some equipment to have the same IP address.

Moreover, this conventional system must coordinate with customer to make changes to remotes because the system does not provide a mechanism for network operators to easily make changes themselves without remote user involvement.

In addition, because configuration changes are made one remote at a time, configuration changes are time consuming and may disadvantageously take a long time to complete.

SUMMARY OF THE INVENTION

Accordingly, one object of the invention is to provide a novel scalable communication system, method, computer program product, and apparatuses. An embodiment of the communication system, method, computer program product, and apparatus includes common equipment shared between multiple independently administered networks. The common equipment is reconfigurable and expandable and provides changed communication capacity and functions when additional elements are added or reconfigured. Configurable features include, for example, communication bandwidth, Quality of Service, and a number of communication satellites included in the communication system. The common equipment includes expandable elements including, for example, a single hub modem chassis that can expand to communicate with more than one communication satellite and a protocol processor that can share a protocol processing task with another protocol processors.

BRIEF DESCRIPTION OF THE DRAWINGS

A more complete appreciation of the invention and many of the attendant advantages thereof will be readily obtained as the same becomes better understood by reference to the following detailed description when considered in connection with the accompanying drawings, wherein:

FIG. 1 is a block diagram of a communication system according to an embodiment of present invention;

FIG. 2 is a block diagram of a communication system according to another embodiment of the present invention;

FIG. 3 is a block diagram of a communication system according to another embodiment of the present invention;

FIG. 4 is a block diagram of a shared multiport according to an embodiment of the present invention;

FIG. 5A is a block diagram of a shared multiport according to another embodiment of the present invention;

FIG. 5B is a block diagram of a shared multiport according to another embodiment of the present invention;

FIG. 5C is a block diagram of a shared multiport according to another embodiment of the present invention;

FIG. 6 is a block diagram of a shared hub modem chassis according to an embodiment of the present invention;

FIG. 7 is a block diagram of a modem group according to an embodiment of the present invention;

FIG. 8 is a block diagram of remote users and remote user connections according to an embodiment of the present invention;

FIG. 9A is a block diagram of a terminal/user according to an embodiment of the present invention;

FIG. 9B is a block diagram of a terminal according to an embodiment of the present invention;

FIG. 9C is a block diagram of a protocol processor to an embodiment of the present invention;

FIG. 10 is a block diagram of a computer used in an embodiment of the present invention;

FIG. 11 is a flow diagram of a method according to an embodiment of the present invention;

FIG. 12 is a table of configuration states according to an embodiment of the present invention;

FIG. 13A is a flow diagram of a method according to an embodiment of the present invention;

FIG. 13B is a flow diagram of a method according to another embodiment of the present invention;

FIG. 14 is a flow diagram of a method according to another embodiment of the present invention;

FIG. 15 is a flow diagram of a method according to another embodiment of the present invention;

FIG. 16 is a block diagram of a background communication system;

FIG. 17A is a block diagram of a background teleport;

FIG. 17B is a block diagram of another background teleport; and

FIG. 18 is a flow diagram of a background method of managing a communication system.

DESCRIPTION OF THE PREFERRED EMBODIMENTS

Referring now to the drawings, wherein like reference numerals designate identical or corresponding parts throughout the several views, FIG. 1 shows an example of a satellite communication system including shared independently administered satellite communication networks according to an embodiment of the present invention. In particular, FIG. 1 shows an example of two shared independently administered satellite communication networks, network A 122 and net-

5

work B **124**. Further, it should be noted that although the description herein includes examples of satellite communication networks, the inventions also pertain to and includes communication networks that do not include satellites.

Network A **122** includes network A upstream users **102** and network A operator **104** connected by IP network **110** to a shared multipoint **100**. Network A operator **104** provides management functions for network A, as discussed later in this specification. Further, network A **122** includes satellite X IF/RF converter **114** providing an IF connection to the shared multipoint **100** and an RF connection to a satellite X **116** also forming part of network A. The network connection between the satellite X IF/RF converter **114** and satellite X **116** includes a satellite antenna and other satellite related equipment (not shown). Further, network A **122** includes network A remote users **118**, which may include a plurality of remote user sites within a communication range of satellite X. Satellite X **116** communicates with network A remote users using channel A **122**. Network A remote users **118** send and receive data with each other and with the network A upstream users **102** via the aforementioned elements of network A **122**.

In addition, according to the example in FIG. 1, network B **124** includes network B upstream users **106** and network B operator **108** connected by an IP network **110** to the shared multipoint **100**. Further, network B **124** includes satellite X IF/RF converter **114** providing a connection between the shared multipoint **100** and the satellite X **116** also forming part of network B, via a satellite antenna (not shown). Further, network B **124** includes network B remote users **120** that are within a communication range of satellite X **116** using channel B **128**, and network B remote users communicate with each other and with the network B upstream users **106** via the aforementioned elements of network B **124**.

Thus, as can be seen in the example of FIG. 1, network A **122** and network B **124** include independent (i.e., not shared) network A upstream users **102** and network B upstream users **106**, as well as independent remote users including network A remote users **118** and network B remote users **120**. However, network A **122** and network B **124** share a common shared multipoint **100**, satellite X IF/RF converter **114** and satellite X **116**. Further, in the example of FIG. 1, each shared independently administered network has an independent network operator (i.e., network A operator **104** and network B operator **108**) providing network administration functions, described later in the present specification.

Further, a satellite communication system according to the present embodiment includes a hub network operator **112** that provides administration functions for the entire satellite communication system, including network A and network B, and which also allocates resources amongst the shared independently administered networks, as described later in the specification.

In addition, although the present embodiment shows a single hub network operator **112**, other embodiments according to the present invention include a different number of hub network operators, to provide hub network operator functionality at different physical locations, or to provide visibility into network resources for a System Network Provider (SNP), for example, as discussed below in conjunction with the detailed description of the network management system embodiments.

Upstream users, like network A upstream user **102** in the embodiment of FIG. 1, may be any network user providing business services to the respective remote users of that network. Further, remote users may be any network user that uses network services provided by the network upstream user, or by other remote users. For example, a network upstream

6

user may be a corporate headquarters, and field offices plus employee workstations at field offices may be examples of remote users. Alternatively, the network upstream user may represent a connection to another network, for example the the global internet, and remote users may be any internet user on that internet connection. Other network upstream users may include, for example, fixed upstream headquarters with remote mobile platforms or remote sensors as remote users.

FIG. 2 includes an example of a further possible embodiment of the present invention including three shared independently administered networks A, B, and C (not individually labeled). As in the embodiment of FIG. 1, networks A and B are configured to share the shared multipoint **100**, the satellite X IF/RF converter **116**, and satellite X **116**. However, in the present embodiment, an additional network, network C also shares the shared multipoint **100**, and the shared multipoint **100** provides connections to a second satellite IF/RF converter, satellite X IF/RF converter **214**. Thus, network C includes network C upstream user **202**, and network C operator **204** connected through respective IP networks **110** to the shared multipoint **100**. Further, network C includes satellite Y IF/RF converter **214** that provides a connection between the shared multipoint **100** and satellite Y **216**. Further, network C includes network C remote users **218** that are in communication with satellite Y **216** on channel C **230**. Network C remote users **218** use the shared and dedicated network equipment to communicate amongst themselves and with network C upstream users **202**.

Thus, as in the embodiment of FIG. 1, each shared independently administered communication network in the embodiment of FIG. 2 includes independent users, which may have independent IP spaces. In other words, none of network A upstream user **102**, network B upstream user **106**, network C upstream user **202**, network A remote users **118**, network B remote users **120**, and network C remote users **218** are shared between more than one network (i.e., each user operates with a single network). However, each shared network shares the shared multipoint **100**, and in the present embodiment, the shared multipoint **100** provides a connection to more than one satellite IF/RF converter, satellite X IF/RF converter **114** and satellite Y IF/RF converter **214**. Further, network A and network B share satellite X IF/RF converter **114** and satellite X **116**, while network C includes satellite Y IF/RF converter **214** and satellite Y **216**.

Further, in the example of FIG. 2, each shared independently administered network has an independent network operator that is implemented using a client/server architecture, and in the present embodiment, three networks A, B, and C are implemented, each having a separate network operator. Thus, network A operator is implemented as network A operator client **204** and network A operator server **134**, network B operator is implemented as network B operator client **206** and network B operator server **136**, network C operator is implemented as network C operator client **208** and network C operator server **238**. Further, each of the networks are connected using separate IP networks, IP network A **110**, IP network B **111**, and IP network C **113**. Further, a satellite communication system according to the present embodiment includes a hub network operator **212** that provides administration functions for the entire satellite communication system, including networks A, B, and C, and which also allocates resources amongst the shared independently administered networks A, B, and C.

Thus, according to the present invention, a single shared multipoint may provide network connections to a plurality of satellite IF/RF converters and satellites as part of a satellite communications system including a plurality of shared inde-

pendently administered networks. In addition, a plurality of shared independently administered communication networks may share the shared multipoint **100**.

In addition, although it was not specifically indicated above, the present embodiment includes various satellites operating in various frequency ranges. For example, each of satellite X and satellite Y may include a Ku band satellite, a Ka band satellite, or a C band satellite. Further, there is no restriction on the types of satellites that may operate from a single shared multipoint.

Although FIGS. **1** and **2** show independent IP networks **110** providing connections between each upstream network user/network operator and the shared multipoint **100**, the present invention also includes sharing IP networks **110** between two or more networks, for example as shown in FIG. **3**.

FIG. **3** shows a further embodiment of a satellite communication system including shared independently administered communication networks A and B, configured as in FIG. **1**. In addition, each of the upstream users and network managers share a single IP network, shared IP network **117**. Further, though each network includes a separate network operator client application in the present embodiment (i.e., network A operator client **304** and network B operator client **308**), they share a common network operator server **340**.

FIG. **4** shows a possible embodiment of a shared multipoint **100** according to the present invention, configured for use in a satellite communication system as shown in the embodiment of FIG. **3**. Shared multipoint **100** includes a shared hub modem chassis **300** and protocol processor A **302**. In the present embodiment, protocol processor A **302** provides network services for a single shared IP network, IP network **117**. Alternatively, a protocol processor may provide network services for plural shared independently administered networks, e.g., networks A and B. Thus, in that embodiment, protocol processor A **302** is shared by networks A and B.

In particular, each protocol processor provides network services such as dynamic assignment of available inroute bandwidth (e.g., based on a fairness algorithm), IP routing to all line cards (described below), Internet Group Management Protocol (IGMP) based IP multicast support, hub side control for Transmission Control Protocol (TCP) and Web Acceleration to optimize TCP and web browsing over a satellite link, automatic adjustment of transmit power to maintain a low Bit Error Rate (BER) through the satellite link, downstream CIR, QoS and traffic prioritization, firewall functions (e.g., using Access Control Lists (ACL)), and link encryption to all or selected sites (e.g., using Triple Data Encryption Standard (3DES)), for example.

The shared hub modem chassis **300** shown in FIG. **4** provides a connection between each of the networks using the protocol processor and the corresponding satellite IF/RF converter. Thus, when part of a system configured according to the embodiment of FIG. **1**, the shared hub modem chassis **300** provides a connection between protocol processor A **302** and the satellite X IF/RF converter, and between protocol processor B **304** and the satellite X IF/RF converter. Thus the shared hub modem chassis **300** is shared by networks A and B.

Although FIG. **4** shows a protocol processor connected to a single shared IP network, a protocol processor may be connected to plural networks, according to further embodiments of the present invention, for example as shown in FIGS. **5A-5C**.

FIG. **5A** shows a further embodiment of a shared multipoint **100**, according to an embodiment of the present invention. The shared multipoint **100** of the present embodiment includes the shared hub modem chassis **300**, the protocol processor A

302 and a protocol processor BC **304**. Protocol processor A **302** is dedicated to shared network A and provides network services for shared network A. Protocol processor BC **304** is shared between network B and a third network C, and provides network services for networks B and C. Further, in the present embodiment, the shared hub modem chassis provides a connection to three satellite IF/RF converters, satellite X IF/RF converter providing satellite connections for network A, satellite Y IF/RF converter providing satellite connections for network B, and satellite Z IF/RF converter providing network connections for network C. Accordingly, in the present embodiment, the shared hub modem chassis **300** is shared by network A, network B, and network C.

FIGS. **5B** and **5C** show further alternative embodiments of coupling a shared hub modem chassis to a plurality of protocol processors, using a network switch **502**, as in FIG. **5B** or network hubs **504**, as in FIG. **5C**.

The protocol processor of the present invention supports a scalable system architecture. As additional users are added to the system, there is additional burden added to the protocol processor. One or more additional protocol processors can be added to the system to provide support for additional users without requiring a change to the other parts of the system. Thus, a system can be initially created to support a small number of users with a relatively small capital investment. Then, as the number of users increases, the system can be seamlessly expanded by adding additional protocol processors. In particular, when a predetermined usage threshold is reached, an additional protocol processor is added to the system. A communication processing load is automatically redistributed from the first protocol processor to the first and second protocol processors. Further, as discussed above, additional user networks can be added to the system using a single protocol processor, or additional protocol processors can be added. The system automatically redistributes the communication load over the available protocol processors. The predetermined threshold may be determined based upon a system status criteria, for example a network management system status report or a CPU utilization.

FIG. **6** shows a possible embodiment of shared hub modem chassis **300**, according to an embodiment of the present invention and configured for use in a shared multipoint as in the embodiment of FIG. **5**. Shared hub modem chassis **300** includes three modem groups **602** providing connections between protocol processors and satellite IF/RF converters. In the present example, a first modem group **602** provides a connection between protocol processor A and a satellite X IF/RF converter, a second modem group **602** provides a connection between protocol processor B and a satellite Y IF/RF converter, and a third modem group **602** provides a connection between protocol processor B and a satellite Z IF/RF converter. Thus, the modem group **602** provides an interface between baseband frequency communications at the protocol processor and passband frequency communications suitable for a satellite IF/RF converter, and according to the present embodiment, each modem group is dedicated to one satellite IF/RF converter. Additionally, each modem group has a common frame time reference (i.e., synchronizing pulse for the start of each multiplexed time frame), which may be different from the common frame time reference of other modem groups. The common frame time reference implements a standard satellite communication protocol, for example as described in Pritchard, Wilbur L., and Joseph A. Scivilli, *Satellite Communication Systems Engineering*, Prentice-Hall, 1986, which is incorporated in its entirety herein by reference. Further, one protocol processor may make a connection to more than one modem group according to the present

invention. In addition, although the modem groups **602** are represented with a same label, at least one modem group **602** may be differently configured or include a different embodiment of the modem group **602** than the other modem groups **602** (e.g., different types or numbers or configurations of line cards in one or each modem group **602**).

Although the shared hub modem chassis embodiment in FIG. **6** includes three modem groups, other embodiments of the shared hub modem chassis are possible having a different number of modem groups. Further, since each modem group provides a connection between at least one protocol processor and a satellite IF/RF converter connected to a satellite, other embodiments of the shared hub modem chassis are possible having connections to other numbers of satellite IF/RF converters connected to satellites. Thus, it is possible to increase or decrease the number of satellite IF/RF converters and satellites sharing a shared hub modem chassis by adding or removing, respectively, modem groups from the shared hub modem chassis.

FIG. **7** shows an embodiment of a modem group **602** according to an embodiment of the present invention. The modem group **602** includes a modulator line card **702** providing a connection between a protocol processor and a TX IF Cable **608** connected to a satellite transmitter (not shown) in a satellite IF/RF converter. Additionally, each line card in a modem group shares a common frame time reference. A modulator line card accepts packets from a protocol processor (e.g., using IP over Ethernet), converts them to a serial stream (e.g., delimited HDLC frames), converts data to modulated symbols (e.g., QPSK) through a mapping process and upconverts the symbols to IF. A demodulator line card performs similar functions in a reverse order. The modem group **602** of the present embodiment also includes four demodulator line cards **704** connected to a splitter **606**. The splitter **606** is also connected to an RX IF Cable **610** connected to a satellite receiver (not shown) in a satellite IF/RF converter. The splitter **606** receives satellite communications from the satellite IF/RF converter and distributes the multiplexed data in the satellite communications for use by the individual demodulator line cards **704**. The demodulator line cards **704** demodulate the received communication data and provide that data to the protocol processor.

Each demodulator line card **704** provides a communication demodulation capability for remote users operating at a particular data rate. Thus, demodulation capability can be expanded or reduced by adding or removing, respectively, demodulator line cards from a modem group.

Although the embodiment of FIG. **7** shows a modem group connected to a single protocol processor, the modem group may also be connected to a plurality of protocol processors. Further, other modem group embodiments are possible including a number of demodulator line cards **704** other than shown here. In addition, although modulator line card **702** is differently designated than each demodulator line card **604**, a modem group embodiment including modulator/demodulator line cards that perform the functions of both modulator line card **702** and demodulator line card **704** are possible. Thus, each line card includes the ability to both transmit a downstream carrier and receive an upstream carrier. Further, although splitter **606** is represented as being separate from the demodulator line cards **704**, it is possible for the function performed by the splitter **606** to be implemented within each demodulator line card, and therefore shared between the demodulator line cards **704**.

FIG. **8** shows a possible embodiment of network A remote users **118** including two remote terminals/users **800** and three terminals **802** in communication with satellite A **116**. Other

quantities of terminals **802** and terminals/users **800** are also possible. Each terminal **802** includes a satellite antenna, and satellite IF/RF conversion functions, for example as in a Very Small Aperture Terminal (VSAT). Each user computer provides communication capabilities appropriate to the type of communication employed by the network (e.g., keyboard and terminal, or sensor and telemetry device). Further, the remote users **118** may include one or more remote site/users **800** that include all the features of terminal **802** and user computer **806**.

Network A remote users **118** according to this embodiment also include a plurality of user computers **806** connected via communication connections to associated terminals **802**. For example, a user computer **806** may communicate with a terminal **802** using a dedicated communication link **804**, which provides a special purpose point-to-point line between the terminal **802** and a user computer **806**. Examples of a dedicated communication link **804** include a RS-232 data link or other point to point communication links. Alternatively, a plurality of user computers **806** may communicate with network A via a single terminal **802** using a multidrop communication link **808**. Multidrop communication link **808** may include, for example, an RS-422 data link or an Ethernet data link. Further, a plurality of user computers **806** may communicate with network A via a single terminal **802** using a wireless communication link **810**. A wireless communication link **810** may be implemented using a radio network, like WiFi or WiMax, an optical network, microwave links, or other wireless communication links.

This arrangement of remote users advantageously allows one or a plurality of user computers to connect to a shared independently managed network using a remote site, and further allows those user computers to be advantageously remotely located from the remote site. For example, with a WiMax wireless communication link, a plurality of user computers can share a common VSAT terminal **802** within a region of a few kilometers.

FIGS. **9A** and **9B** include detailed block diagrams of a possible embodiment of a remote site terminal/user **800** and single terminal **802** according to the present invention. Each single terminal **802** includes a satellite modem **902**, a remote virtual router **904** and a remote virtual router tag table **908**. Each terminal/user **800** includes a satellite modem **902**, a remote virtual router **904**, a remote virtual router tag table **908** and user interface **906**. The remote virtual router **904** and remote virtual router tag table **908** work with the upstream virtual router **910** and upstream virtual router tag table **914** (described below) in conjunction with the shared network equipment, to provide a virtual router capability.

As discussed above, each remote terminal transmits communications from remote users to upstream users using the shared network equipment and each remote terminal receives communications from upstream users sent via the shared network equipment. The remote virtual router **904** appends a virtual router tag (not shown) based on the contents of the remote virtual router tag table **908** to each communication packet that is intended to be transmitted to an upstream user. The virtual router tag includes a unique identifier that is mapped to a local IP address of a remote user or an upstream user, and the mapping between the virtual router tag and each local IP address is stored in the remote virtual router tag table **908**. A duplicate copy of the mapping is also stored in the upstream virtual router tag table **914** (discussed below). Further, the remote virtual router removes a virtual router tag from each communication packet transmitted to a remote user

11

and routes the packet to the local IP address of a remote user, based on the contents of the remote virtual router tag table **908**.

FIG. **9C** is a detailed block diagram of protocol processor **302**, which includes upstream virtual router **910** operatively connected to upstream virtual router tag table **914** and protocol converter **912**. The protocol converter **912** converts communications from line cards in the shared hub modem chassis for transmission to a client on the IP network and converts communications from a client on the IP network for transmission to a line card in the shared hub modem chassis. The upstream virtual router **910** appends a virtual router tag (not shown) based on the contents of the upstream virtual router tag table **914** to each communication packet that is intended to be transmitted to a remote user on a particular VLAN. The virtual router tag includes a unique identifier that is mapped to a local IP address of a remote user or an upstream user, and the mapping between the virtual router tag and each local IP address is stored in the upstream virtual router tag table **914**. Further, the upstream virtual router **910** removes a virtual router tag from each packet to be transmitted to an upstream user and routes the packet to the local IP address of the upstream user based on the contents of the upstream virtual router tag table **914**.

Thus, communications between the protocol processor and a remote terminal according to an embodiment of the present invention includes a virtual router capability that repackages IP packets into virtual router packets by adding a virtual router tag. Each intermediate system element, including the shared hub modem chassis, satellite IF/RF converter and satellite, is configured to pass the virtual router packets along. At the protocol processor end, virtual router packets are converted back to IP packets by consulting a virtual router lookup table that maps the combined virtual router address and IP address back into an IP address. Similarly, at the remote end, downstream virtual router packets are converted back to IP packets using the virtual router table.

This arrangement allows complete freedom in the administration of networks that share hardware. Thus, a first shared network operator may select and assign IP addresses for first shared network users without regard to or knowledge of any IP addresses selected by a second network operator for second network users. For example, network operator A may assign a network A remote user the IP address 10.0.0.1 and network operator B may also assign a network B remote user the same IP address, 10.0.0.1, without any risk of conflict.

Further, a capability of a communication system can be flexibly varied at least by 1) changing a number of modem groups, 2) changing a number of enabled line cards, 3) changing a number of communicating satellites, or 4) changing a number of protocol processors. In particular, the system may be created with a relatively small capital investment, but may be expanded without adding a new hub modem chassis.

First, the system communication capability may be changed by changing a number of modem groups. As discussed above, each modem group provides a potentially unique independently administered network capability to the communication system. Each network may be differently configured to satisfy different technical or business purposes. For example, each network may support a different encryption scheme (e.g., having different encryption levels on one network than on other networks in the communication system), different communication purposes (e.g., voice priority communication on one network and data priority communication on another network in the communication system), different QoS scheme (e.g., different QoS levels on one network than on other networks in the communication system),

12

different bandwidth allocation schemes and different owners or system administrators on each network. A number of modem groups may be reduced by reallocating line cards of an existing modem group to one or more other modem groups in the hub modem chassis. Alternatively, a modem group may be added to the system by reallocating line cards of existing modem groups or by adding new line cards and allocating them to a new modem group. Thus, additional independently administered networks may be added to the communication system without adding an additional hub modem chassis.

Second, a total upstream communication bandwidth of a particular modem group may be changed by allocating additional line cards to that modem group, or by de-allocating line cards. For example, when the desired bandwidth exceeds a predetermined threshold, one or more additional line cards are enabled for a modem group and communications are redistributed over all the line cards in the enlarged modem group to allow the communication system to provide increased bandwidth without adding an additional hub modem chassis. The predetermined threshold may be determined based upon a system status criteria, for example a network management system status report or a CPU utilization.

Third, the communication system may be expanded to support new users or to allocate communication resources to a particular group of existing users. For example, the communication system may be expanded to support new users in a new geographic region by adding an additional satellite capability including a communication link to an additional satellite. The additional satellite capability is added to the existing system by adding or allocating one or more new modem groups in the shared hub modem chassis and connecting the new modem group to an additional satellite via an IF/RF converter, as discussed above. Thus, a new satellite capability allowing communication with a new group of users using an additional satellite is easily added to the communication system without adding an additional hub modem chassis.

Fourth, a communication capability of the communication system may be expanded to include additional protocol processing capability by adding additional protocol processors. For example, if a desired level of protocol processing capability increases beyond a particular threshold, additional protocol processors may be enabled, and the protocol processing capability is shared between plural protocol processors. For example, an increase in voice communication capacity requires an increased protocol processing. Thus, if a desired voice communication capacity exceeds a predetermined threshold, an additional protocol processor may be enabled to increase the protocol processing capability of the communication system.

FIG. **10** illustrates a computer system **1001** upon which an embodiment of the present invention may be implemented. The computer system **1001** includes a bus **1002** or other communication mechanism for communicating information, and a processor **1003** coupled with the bus **1002** for processing the information. The computer system **1001** also includes a main memory **1004**, such as a random access memory (RAM) or other dynamic storage device (e.g., dynamic RAM (DRAM), static RAM (SRAM), and synchronous DRAM (SDRAM)), coupled to the bus **1002** for storing information and instructions to be executed by processor **1003**. In addition, the main memory **1004** may be used for storing temporary variables or other intermediate information during the execution of instructions by the processor **1003**. The computer system **1001** further includes a read only memory (ROM) **1005** or other static storage device (e.g., program-

mable ROM (PROM), erasable PROM (EPROM), and electrically erasable PROM (EEPROM)) coupled to the bus **1002** for storing static information and instructions for the processor **1003**.

The computer system **1001** also includes a disk controller **1006** coupled to the bus **1002** to control one or more storage devices for storing information and instructions, such as a magnetic hard disk **1007**, and a removable media drive **1008** (e.g., floppy disk drive, read-only compact disc drive, read/write compact disc drive, compact disc jukebox, tape drive, flash memory drive, and removable magneto-optical drive). The storage devices may be added to the computer system **1001** using an appropriate device interface (e.g., small computer system interface (SCSI), integrated device electronics (IDE), enhanced-IDE (E-IDE), direct memory access (DMA), or ultra-DMA).

The computer system **1001** may also include special purpose logic devices (e.g., application specific integrated circuits (ASICs)) or configurable logic devices (e.g., simple programmable logic devices (SPLDs), complex programmable logic devices (CPLDs), and field programmable gate arrays (FPGAs)).

The computer system **1001** may also include a display controller **1009** coupled to the bus **1002** to control a display **1010**, such as a cathode ray tube (CRT), for displaying information to a computer user. The computer system includes input devices, such as a keyboard **1011** and a pointing device **1012**, for interacting with a computer user and providing information to the processor **1003**. The pointing device **1012**, for example, may be a mouse, a trackball, or a pointing stick for communicating direction information and command selections to the processor **1003** and for controlling cursor movement on the display **1010**. In addition, a printer may provide printed listings of data stored and/or generated by the computer system **1001**.

The computer system **1001** performs a portion or all of the processing steps of the invention in response to the processor **1003** executing one or more sequences of one or more instructions contained in a memory, such as the main memory **1004**. Such instructions may be read into the main memory **1004** from another computer readable medium, such as a hard disk **1007** or a removable media drive **1008**. One or more processors in a multi-processing arrangement may also be employed to execute the sequences of instructions contained in main memory **1004**. In alternative embodiments, hard-wired circuitry may be used in place of or in combination with software instructions. Thus, embodiments are not limited to any specific combination of hardware circuitry and software.

As stated above, the computer system **1001** includes at least one computer readable medium or memory for holding instructions programmed according to the teachings of the invention and for containing data structures, tables, records, or other data described herein. Examples of computer readable media are compact discs, hard disks, floppy disks, tape, magneto-optical disks, PROMs (EPROM, EEPROM, flash EPROM), DRAM, SRAM, SDRAM, or any other magnetic medium, compact discs (e.g., CD-ROM), or any other optical medium, punch cards, paper tape, or other physical medium with patterns of holes, a carrier wave (described below), or any other medium from which a computer can read.

Stored on any one or on a combination of computer readable media, the present invention includes software for controlling the computer system **1001**, for driving a device or devices for implementing the invention, and for enabling the computer system **1001** to interact with a human user (e.g., print production personnel). Such software may include, but is not limited to, device drivers, operating systems, develop-

ment tools, and applications software. Such computer readable media further includes the computer program product of the present invention for performing all or a portion (e.g., locally portion of distributed processing) of the processing performed in implementing the invention.

The computer code devices of the present invention may be any interpretable or executable code mechanism, including but not limited to scripts, interpretable programs, dynamic link libraries (DLLs), Java classes, and complete executable programs. Moreover, parts of the processing of the present invention may be distributed or centralized for better performance, reliability, and/or cost.

The term "computer readable medium" as used herein refers to any medium that participates in providing instructions to the processor **1003** for execution. A computer readable medium may take many forms, including but not limited to, non-volatile media, volatile media, and transmission media. Non-volatile media includes, for example, optical, magnetic disks, flash memory, and magneto-optical disks, such as the hard disk **1007** or the removable media drive **1008**. Volatile media includes dynamic memory, such as the main memory **1004**. Transmission media includes coaxial cables, copper wire and fiber optics, including the wires that make up the bus **1002**. Transmission media also may also take the form of acoustic or light waves, such as those generated during radio wave and infrared data communications.

Various forms of computer readable media may be involved in carrying out one or more sequences of one or more instructions to processor **1003** for execution. For example, the instructions may initially be carried on a magnetic disk of a remote computer. The remote computer can load the instructions for implementing all or a portion of the present invention remotely into a dynamic memory and send the instructions over a telephone line using a modem. A modem local to the computer system **1001** may receive the data on the telephone line and use an infrared transmitter to convert the data to an infrared signal. An infrared detector coupled to the bus **1002** can receive the data carried in the infrared signal and place the data on the bus **1002**. The bus **1002** carries the data to the main memory **1004**, from which the processor **1003** retrieves and executes the instructions. The instructions received by the main memory **1004** may optionally be stored on storage device **1007** or **1008** either before or after execution by processor **1003**.

The computer system **1001** also includes a communication interface **1013** coupled to the bus **1002**. The communication interface **1013** provides a two-way data communication coupling to a network link **1014** that is connected to, for example, a local area network (LAN) **1015**, or to another communications network **1016** such as the Internet. For example, the communication interface **1013** may be a network interface card to attach to any packet switched LAN. As another example, the communication interface **1013** may be an asymmetrical digital subscriber line (ADSL) card, an integrated services digital network (ISDN) card or a modem to provide a data communication connection to a corresponding type of communications line. Wireless links may also be implemented. In any such implementation, the communication interface **1013** sends and receives electrical, electromagnetic or optical signals that carry digital data streams representing various types of information.

The network link **1014** typically provides data communication through one or more networks to other data devices. For example, the network link **1014** may provide a connection to another computer through a local network **1015** (e.g., a LAN) or through equipment operated by a service provider, which provides communication services through a commu-

communications network **1016**. The local network **1014** and the communications network **1016** use, for example, electrical, electromagnetic, or optical signals that carry digital data streams, and the associated physical layer (e.g., CAT 5 cable, coaxial cable, optical fiber, etc). The signals through the various networks and the signals on the network link **1014** and through the communication interface **1013**, which carry the digital data to and from the computer system **1001** maybe implemented in baseband signals, or carrier wave based signals. The baseband signals convey the digital data as unmodulated electrical pulses that are descriptive of a stream of digital data bits, where the term “bits” is to be construed broadly to mean symbol, where each symbol conveys at least one or more information bits. The digital data may also be used to modulate a carrier wave, such as with amplitude, phase and/or frequency shift keyed signals that are propagated over a conductive media, or transmitted as electromagnetic waves through a propagation medium. Thus, the digital data may be sent as unmodulated baseband data through a “wired” communication channel and/or sent within a predetermined frequency band, different than baseband, by modulating a carrier wave. The computer system **1001** can transmit and receive data, including program code, through the network(s) **1015** and **1016**, the network link **1014** and the communication interface **1013**. Moreover, the network link **1014** may provide a connection through a LAN **1015** to a mobile device **1017** such as a personal digital assistant (PDA) laptop computer, or cellular telephone.

Each network operator includes a network management system (NMS) that provides network administration functionality with visibility into a level of network resources that may be differently configured. Network resources managed by the NMS include all configurable aspects of the communication system including remote user equipment, line cards, the shared hub modem chassis, and the protocol processors, for example. The NMS includes a database that stores configuration parameters and privileges for each resource in the communication system.

Each NMS may be configured as a client/server application with a client NMS application and a server NMS application. The client and server NMS applications may execute on a same computer or on different computers located in a same location or at different locations. Although the NMS server application may receive communication for each of the shared networks configured to share common hardware, as in the embodiment of FIG. 3, the NMS server application is configured to only provide network monitoring and status information to an NMS client regarding networks over which the NMS client has administrative privileges. The configuration of the NMS client may be based on a content of a database. Further, the NMS server only allows an NMS client to perform network management functions that the NMS client is privileged to perform based on the database content. In addition, the NMS server only allows an NMS client to manage the user accounts of users on a network that the NMS client is privileged to administer, based on the database content.

For each configurable resource in the communication system, the NMS stores a metadata value including a state variable representing a state of a change to the associated parameter, an original value of the configuration parameter, and a desired changed value of the configuration parameter. The NMS uses the stored metadata to coordinate a change in configuration of the communication system with minimal disruption to communication system operation. For example, one or more network configuration changes may be planned using the NMS, and the desired changed value of each con-

figuration parameter is stored in the metadata. Then, NMS can be scheduled to make all the network configuration parameters at the same time, and at a time that is most convenient for users, for example at night time when communication system usage is low.

To implement a network configuration change, the NMS uses a coordinated three state change mechanism. In particular, in step **1**, desired changes are entered in the metadata stored in the configuration database. In step **2**, the NMS displays the desired changes and allows a network operator to make further changes, and in step **3** the NMS communicates the changes to the participating network resources, monitors their response and stores their status in the database metadata.

This three-step change process gives the network operator ultimate control over operational network components, because no change takes place without the operator initiating it. However, the three-step change process also creates a situation where the NMS database is temporarily out-of-sync with the actual network (i.e., after the operator has made database modifications, but before they have been applied to the network). Accordingly, to help operators easily manage this situation and others like it, each key component of the network maintains and reports a configuration state variable that shows the current status of that key component.

FIG. 11 shows an example of a method of changing a network configuration, according to an embodiment of the present invention. In step **S1102**, a remote user is already configured, commissioned, and all previous changes have been applied, thus the remote user reports its configuration state as “Nominal” and the configuration state is monitored and displayed for the network operator and stored in the NMS metadata. In step **S1104**, a user makes some change to the configuration database, for example, the user changes a QoS parameter. In step **S1106**, all users are informed of possible changes to Upstream QoS caused by the configuration database changes made in **S1104**. In step **S1108**, each user reviews the pending configuration changes and resulting changes to QoS. In step **S1114**, the users indicate if pending changes are desired. If the changes are desired, proceed to step **S1110** in which the changes are applied to the data path elements (e.g., shared multiport, satellite IF/RF converters, remote users, etc. . . .). If the changes are not desired, proceed to step **S1112**, in which the user that changed the configuration database removes that change from the database.

Thus, according to the present invention, the configuration state variable is associated with each configurable element of the communication system and the configuration state value can be easily managed by the NMS thereby allowing configuration changes to be made in an orderly, predictable, and controlled manner.

In a further example of a method of making a configuration change, a hub frequency change is desired. Using the NMS, a network operator enters the desired hub frequency change and the NMS stores the hub frequency change in the metadata database. Further, the NMS makes all other related changes to configurable communication system equipment, including changes to the frequency of each remote user operating with that hub. At this point the network operator can review all changes related to the hub frequency change, including an indication of which parameters must consequently change on each related piece of communication equipment, prior to applying that change, and if necessary, the network operator can modify or abort the change.

Further, as a network operator enters configuration parameters into the NMS, the NMS displays an indication of which

further configuration parameters may also be required and indicates if the configuration parameters have been fully entered.

Further, when making a configuration change, the NMS will periodically poll related communication system elements to determine their current configuration state.

Each configurable element of the communication system has a communication state, which according to one embodiment of the present invention, includes the configuration states as shown in FIG. 12.

The network management system **804** may be configured to perform a hub network operator function or a virtual network operator function. If the network management system is configured to perform the role of a hub network operator, the network operator **800** is configured for hub operator use, as in hub network operator client **112** and hub network operator server **140** of FIG. 1. If the network management system **804** is configured to perform the role of a virtual network operator, the network operator **800** is configured for network operator use, as in the network A operator client **104** and network A operator server **134**, or as in network B operator client **108** and network B operator server **136** of FIG. 1. Further, the network management system is configured to provide different levels of capability for different users.

For example, one possible embodiment of the network management system (NMS) **804**, provides different levels of permission and visibility to network resources depending upon the type of user. For example, a hub network operator user type identified as a Hub Network Operator (HNO) Super User has permission and visibility to all communication system resources, a network operator user type identified as a Virtual Network Operator (VNO) Super User has visibility only to resources of one shared independently administered network in the communication system, and a network operator user type identified as a VNO Guest User has read-only permission to observe configuration parameters and network status for one shared independently administered network in the communication system. The network management system **804** also includes the ability to create other user types with other permissions and visibility of network resources. Further, VNO accounts may be configured to provide access to the resources allocated to the VNO's network and may be configured to not have access to the resources allocated to other networks in the shared satellite communication system. Alternatively, remote users and communications in a network may be made part of different network subgroups, and different VNOs on the same network may be configured to have access to remote users and communications in one subgroup and may be further configured not to have access to remote users and communications in another subgroup.

VNO accounts are configured for each VNO NMS user and include user information, for example name/password, user type (e.g., VNO Super User or VNO Guest). VNO Super Users may use the network management system **804** to perform virtual network operations, for example to add, modify and delete network remote users, activate and deactivate network remote users, select Quality of Service (QoS) profiles, monitor and query remote statistics, and have visibility only to their independent shared network. VNO Super Users cannot add or modify carriers, independently add or modify line cards or protocol processors, independently add or modify hardware components, or view other shared networks in the communication system, because these features are reserved to HNO and System Network Provider (SNP) accounts due to their impact on shared RF configurations.

Participants in a method of operating a satellite communication system that includes shared independently adminis-

tered satellite communication networks include a Host Network Operator, a Virtual Network Operator, a Shared Network Provider, and Users. These participants achieve their business goals through the use of a shared communications system, according to the present invention.

A Host Network Operator (HNO) provides a hosting environment for sophisticated enterprise or service provider customers who desire more control over the network management of their services. The HNO role may be performed by companies who own or operate satellites to broaden existing space segment distribution channels or to create new channels for service offerings. HNOs manage shared network equipment and allocate network resources to Virtual Network Operators (VNOs). For example, HNOs perform network management, installation and maintenance services for VNOs.

Further, HNOs are responsible for purchasing and maintaining a portion of the hardware and software in a satellite network. In particular, HNOs are responsible for satellites and satellite ground equipment, including spacecraft, transponders, hub antenna components, and hub Radio Frequency Transceivers (RFT) or radio frequency/intermediate frequency converters (IF/RF converters). HNOs are also responsible for a portion of the shared multipoint equipment. At the shared multipoint, HNOs are responsible for the hub modem chassis, protocol processors, host Network Management System (NMS) server, and host NMS clients.

HNOs are responsible for managing some system parameters, including inbound and outbound carriers, bandwidth regions, carrier frequencies, power, bit rates, acquisition and uplink control parameters, and Internet Protocol (IP) addresses of hub modems, NMS clients and servers, protocol processors and upstream routers, for example.

HNOs provide services to VNOs, including remote commissioning support, link budget preparation, hub equipment maintenance, upstream internet connection/private data connection maintenance, and coordination of software/firmware upgrades, for example. Further, HNOs have full visibility to all parts of the network using the NMS.

HNOs derive revenue from space segment operations, collocation services, and network management fees to VNOs. The network management fees include, for example, commissioning, configuration management, real-time monitoring, and periodic report generation fees, for example.

A Virtual Network Operator (VNO) is a "non-facilities" based provider of satellite network operator services that will be supported by the Host Network Operator business model. The VNO manages an independently managed, shared network and allocates network resources to users of that network. The VNO role is performed by sophisticated enterprise customers and service providers, and allows them to operate and manage state-of-the-art satellite networks. VNO is a low cost way of entering into a Satellite Network Operations business because much of the upfront capital investment has already been made, and VNOs can incrementally grow system capability as business opportunities grow. Further, the VNO business model provides greater control over end user networks, thereby providing better customer service.

VNOs are responsible for obtaining and maintaining a portion of the hardware and software in a satellite network, or VNOs contract those responsibilities to the HNO. In particular, at the shared multipoint, VNOs are responsible for line cards, netmodems, network user equipment, and virtual NMS client software. VNOs support line card installation (through coordination with HNO, if necessary), commissioning of new remote sites, and support of all network user sites. VNOs manage all network user configuration, including rate shap-

ing, network user IP address assignment (through coordination with HNO, if necessary), in-route timeplan and outroute frame configuration, Network Address Translation (NAT) and Dynamic Host Configuration Protocol (DHCP), for example. Further, VNOs coordinate software/firmware upgrades with HNO and SNP.

VNOs derive revenue from recurring enterprise service fees, installation and maintenance of network user equipment and software, and as a space segment reseller, for example.

Each network user on an independently managed, shared network typically receives service from a single VNO. For example, those services may include web hosting, content or DNS caching, data or video broadcast services, and other IP related services. Further, network users may also receive support, for example, commissioning support, help desk and technical support (e.g., during an outage), and changes or additions to QoS profiles.

The Shared Network Provider (SNP) performs a variety of tasks, including an initial survey of the shared multipoint site, initial installation of equipment at the shared multipoint site, broadband network operation training to HNOs and VNOs, ongoing technical support and consulting services to HNOs and VNOs, and software/firmware updates and maintenance, for example. In addition, the SNP may have visibility to all parts of the network through the NMS, at the discretion of the relevant HNO. Further, the SNP provides technical expertise to HNOs, for example including link budget and network architecture expertise.

Consulting services provided by the SNP include hub engineering design, initial network configuration, file server configuration and base band hub station installation, for example. Broadband network operation training includes NMS training, Time Division Multiple Access (TDMA) System training, Network Operations Center (NOC) training, for example. SNP provided maintenance services include broadband router software/firmware maintenance, NMS software maintenance, and protocol processor software/firmware maintenance, for example.

FIG. 13A shows a possible embodiment of a shared independently administered business method of a communication system that includes shared independently administered networks, and in particular, a method of adding a new shared network to an existing satellite communications system. In step S1302 a HNO and VNO add a modem group to an existing shared multipoint that is already connected via a satellite IF/RF converter to an existing satellite. The HNO selects a number of line cards and upstream and downstream carrier rates for the modem group as appropriate for the service level desired for the new network to be added. In step S1304 the HNO uses a hub network operator to allocate privileges to a new network operator and adds the operator to the communication system. In S1306, the VNO of the new network adds new upstream and remote user sites to the new network configuration using the new network operator, and in S1308, the VNO configures the network resources for operation according to the VNOs business goals. In S1310, the new network is administered, including system administration functions performed by the HNO and SNP, and network administration functions performed by the VNO. In step S1312, the new network is operated, including system monitoring functions performed by the SNP, billing functions performed by the HNO and VNO and communication functions performed by the users, for example.

FIG. 13B shows a further possible embodiment of a method of operating a communication system including shared independently administered communication networks, and in particular, an embodiment of a method to add a

satellite, satellite IF/RF converters, and a modem group to an existing shared multipoint to create a new shared network. Steps S1302 through S1312 are performed similarly to the steps in the embodiment of FIG. 13A. In step S1308 a new satellite and a new satellite IF/RF converter are added to the communication system and in step S1310 the added satellite IF/RF converter is connected to the new modem group in the existing shared multipoint.

Thus, the existing shared multipoint is reconfigured, with the addition of the new modem group, to operate with an additional new satellite not previously connected, and it is not necessary to add a new hub modem chassis for connection to an additional satellite, as required by background methods.

FIG. 14 shows a possible embodiment of a method of configuring shared network resources, as shown in step S1308 in the embodiments of FIGS. 13A and 13B. In step S1402, global privileges (i.e., privileges to all resources in the communication system) are granted to a hub network operator by the SNP and the hub network operator is configured to have those privileges. In step S1404, the hub network operator grants certain privileges to observe and control network resources to each of the virtual network operators in the communication system. As discussed above, each virtual network operator is typically granted privileges to resources of its shared independently administered network. In step S1406, the hub network operator administers resources throughout the communication system, setting up those resources for operation with a shared network. In step S1408, a first virtual network operator administers resources throughout the first network, setting up those resources for operation, including activating/deactivating users, setting up IP addresses, etc. . . . , as discussed above. In step S1410, a second network operator administers resources throughout the second network, setting up those resources for operation. The first virtual network operator does not have access to resources on the second network, and likewise, the second virtual network operator does not have access to resources on the first network. A hub network operator has access to all resources in the communication system, including first network resources and second network resources.

FIG. 15 shows an example of operating a shared network, as in step S1312 in FIGS. 13A and 13B, according to a possible embodiment of the present invention. In step S1502 the SNP, HNO and VNOs perform system monitoring and maintenance functions including monitoring the health of system equipment and preparing periodic software and firmware upgrades to elements of the communication system. In step S1504, the HNO and a first virtual network operator further monitor the status of the first network to provide support to first network users. In step S1504, the HNO and a second virtual network operator further monitor the status of the second network to provide support to second network users. The first virtual network operator does not have access to users on the second network, and likewise, the second virtual network operator does not have access to users on the first network. In step S1512, SNPs bill the HNO for provided maintenance and monitoring services. In step S1514, the HNO bills a first VNO for first network communication resources allocated to the VNO and for usage of the first network as monitored by the HNO. In step S1516, the HNO bills a second VNO for second network communication resources allocated to the VNO and for usage of the second network as monitored by the HNO. In step S1518, the first VNO bills users of the first network based on monitored usage, and in step S1520, the second VNO bills users of the second network based on monitored usage.

21

Numerous modifications and variations of the present invention are possible in light of the above teachings. It is therefore to be understood that within the scope of the appended claims, the invention may be practiced otherwise than as specifically described herein.

The invention claimed is:

1. A scalable satellite communication system comprising: a shared hub modem chassis containing first line card slots, second line card slots and first line cards in the first line card slots, wherein said first line cards are operatively connected by said first line card slots to a first satellite IF/RF converter configured to communicate with a first satellite, said first line cards further configured to perform a first satellite communication function, said second line card slots operatively connected to a second satellite IF/RF converter configured to communicate with a second satellite, said second line card slots further configured to provide a second satellite communication function if the second line cards are operatively connected to the second line card slots and to not provide a second satellite communication function if the second line cards are not operatively connected to the second line card slots, and said second line card slots providing an expansion capability for said satellite communication system when the second satellite communication function is to be provided by adding the second line cards.
2. The system of claim 1, wherein the second line cards are operatively connected to the second line card slots when the second satellite communication function is to be provided.
3. The system of claim 1, further comprising: a first protocol processor operatively connected to the shared hub modem chassis and configured to communicate with a first user across a first user network, said first protocol processor configured to perform a protocol processing, said first protocol processor being configured to share the protocol processing with a second protocol processor if the second protocol processor is operatively connected to the shared hub modem chassis, and configured to exclusively perform the protocol processing if the second protocol processor is not operatively connected to the shared hub modem chassis, said first protocol processor providing an increased protocol processing capacity for said satellite communication system when the second protocol processor is added.
4. The system of claim 3, wherein the second protocol processor is operatively connected to the shared hub modem chassis when a load on the first protocol processor exceeds a predetermined threshold.
5. The system of claim 1, wherein a communication capacity of the system is based on a number of operatively connected line cards, and the number of operatively connected second line cards is increased when a load on the communication capacity of the system exceeds a predetermined threshold.
6. The system of claim 1, wherein a number of independently administered networks of the system is based on a number of operatively connected line cards, and the number of operatively connected second line cards is increased when an increased number of independently administered networks is to be provided.
7. A scalable satellite communication system comprising: a shared hub modem chassis containing first line card slots, second line card slots and first line cards in the first line card slots,

22

- wherein said first line cards are operatively connected by said first line card slots to a first satellite IF/RF converter configured to communicate with a first satellite, said first line cards further configured to perform a first satellite communication function having a first communication capacity,
- said second line card slots operatively connected to the first satellite IF/RF converter configured to communicate with the first satellite, said second line card slots further configured to provide the first satellite communication function having a second communication capacity if the second line cards are operatively connected to the second line card slots and to provide the first satellite communication function having the first communication capacity if the second line cards are not operatively connected to the second line card slots,
- said second line card slots providing an expansion capability for said satellite communication system when the second communication capacity is to be provided by operatively connecting a number of second line cards.
8. The system of claim 7, wherein the first communication capacity is based on a number of operatively connected line cards, and the number of operatively connected second line cards is increased when a load on the first communication capacity exceeds a predetermined threshold.
 9. The system of claim 7, wherein said second line card slots are operatively connected to a second satellite IF/RF converter configured to communicate with a second satellite, said second line card slots further configured to provide a second satellite communication function if the second line cards are operatively connected to the second line card slots and to not provide a second satellite communication function if the second line cards are not operatively connected to the second line card slots, and said second line card slots are configured to provide an expansion capability for said satellite communication system when the second satellite communication function is to be provided by adding the second line cards.
 10. The system of claim 9, wherein the second line cards are operatively connected to the second line card slots when the second satellite communication function is to be provided.
 11. The system of claim 7, further comprising: a first protocol processor operatively connected to the shared hub modem chassis and configured to communicate with a first user across a first user network, said first protocol processor configured to perform a protocol processing, said first protocol processor being configured to share the protocol processing with a second protocol processor if the second protocol processor is operatively connected to the shared hub modem chassis, and configured to exclusively perform the protocol processing if the second protocol processor is not operatively connected to the shared hub modem chassis, said first protocol processor providing an increased protocol processing capacity for said satellite communication system when the second protocol processor is added.
 12. The system of claim 11, wherein the second protocol processor is operatively connected to the shared hub modem chassis when a load on the first protocol processor exceeds a predetermined threshold.
 13. The system of claim 7, wherein a number of independently administered networks of the system is based on a number of operatively connected line cards, and the number

23

of operatively connected second line cards is increased when an increased number of independently administered networks is to be provided.

14. A scalable satellite communication system comprising:
a shared hub modem chassis containing

first line card slots, second line card slots and
first line cards in the first line card slots,

wherein said first line cards are operatively connected by
said first line card slots to a first satellite IF/RF con-
verter configured to communicate with a first satellite,
said first line cards further configured to perform a
first independently administered network function,

said second line card slots operatively connected to the
first satellite IF/RF converter configured to commu-
nicate with the first satellite, said second line card
slots further configured to provide a second independ-
ently administered network function if the second
line cards are operatively connected to the second line
card slots and to not provide a second independently
administered network function if the second line
cards are not operatively connected to the second line
card slots,

said second line card slots providing an expansion capa-
bility for said satellite communication system when
the second independently administered network func-
tion is to be provided by adding the second line cards.

15. The system of claim **14**, wherein the second line cards are operatively connected to the second line card slots when the second independently administered network function is to be provided.

16. The system of claim **14**, wherein a communication capacity of the system is based on a number of operatively connected line cards, and the number of operatively connected second line cards is increased when a load on the first communication capacity exceeds a predetermined threshold.

17. The system of claim **14**, wherein said second line card slots are operatively connected to a second satellite IF/RF converter configured to communicate with a second satellite, said second line card slots further configured to provide a second satellite communication function if the second line cards are operatively connected to the second line card slots and to not provide a second satellite communication function if the second line cards are not operatively connected to the second line card slots, and

said second line card slots are configured to provide an
expansion capability for said satellite communication
system when the second satellite communication func-
tion is to be provided by adding the second line cards.

18. The system of claim **17**, wherein the second line cards are operatively connected to the second line card slots when the second satellite communication function is to be provided.

19. The system of claim **14**, further comprising:

a first protocol processor operatively connected to the
shared hub modem chassis and configured to communi-
cate with a first user across a first user network,

said first protocol processor configured to perform a pro-
tocol processing, said first protocol processor being con-
figured to share the protocol processing with a second
protocol processor if the second protocol processor is
operatively connected to the shared hub modem chassis,
and configured to exclusively perform the protocol pro-
cessing if the second protocol processor is not opera-
tively connected to the shared hub modem chassis,

said first protocol processor providing an increased proto-
col processing capacity for said satellite communication
system when the second protocol processor is added.

24

20. The system of claim **19**, wherein the second protocol processor is operatively connected to the shared hub modem chassis when a load on the first protocol processor exceeds a predetermined threshold.

21. A scalable satellite communication system comprising:
a shared hub modem chassis containing

first line card slots, second line card slots and
first line cards in the first line card slots,

wherein said first line cards are operatively connected by
said first line card slots to a first satellite IF/RF con-
verter configured to communicate with a first satellite,
said first line cards further configured to perform a
first satellite communication function having a first
communication capacity,

a first protocol processor operatively connected to the
shared hub modem chassis and configured to communi-
cate with a first user across a first user network, said first
protocol processor configured to perform a protocol pro-
cessing,

said first protocol processor being configured to share the
protocol processing with a second protocol processor if
the second protocol processor is operatively connected
to the shared hub modem chassis, and configured to
exclusively perform the protocol processing if the sec-
ond protocol processor is not operatively connected to
the shared hub modem chassis,

said first protocol processor providing an increased proto-
col processing capacity for said satellite communication
system when the second protocol processor is added.

22. The system of claim **21**, wherein the second protocol processor is operatively connected to the shared hub modem chassis when a load on the first protocol processor exceeds a predetermined threshold.

23. The system of claim **21**, wherein said second line card slots are operatively connected to a second satellite IF/RF converter configured to communicate with a second satellite, said second line card slots further configured to provide a second satellite communication function if the second line cards are operatively connected to the second line card slots and to not provide a second satellite communication function if the second line cards are not operatively connected to the second line card slots, and

said second line card slots are configured to provide an
expansion capability for said satellite communication
system when the second satellite communication func-
tion is to be provided by adding the second line cards.

24. The system of claim **23**, wherein the second line cards are operatively connected to the second line card slots when the second satellite communication function is to be provided.

25. The system of claim **21**, wherein a communication capacity of the system is based on a number of operatively connected line cards, and the number of operatively connected second line cards is increased when a load on the first communication capacity exceeds a predetermined threshold.

26. The system of claim **21**, wherein a number of independ-
ently administered networks of the system is based on a
number of operatively connected line cards, and the number
of operatively connected second line cards is increased when
an increased number of independently administered networks
is to be provided.

27. A method of scaling a satellite communication system
comprising:

performing a first satellite communication function using
first line cards, said first line cards having a first com-
munication capacity and are installed in first line card
slots in a shared hub modem chassis containing first line
card slots and second line card slots,

wherein said first line cards are operatively connected by
said first line card slots to a first satellite IF/RF converter

25

configured to communicate with a first satellite, and said second line card slots being operatively connected to a second satellite IF/RF converter configured to communicate with a second satellite;

providing a second satellite communication function from the second line card slots if the second line cards are operatively connected to the second line card slots and not providing a second satellite communication function if the second line cards are not operatively connected to the second line card slots,

said second line card slots providing an expansion capability for said satellite communication system when the second satellite communication function is to be provided by adding the second line cards, and

said second line card slots providing an expansion capability for said satellite communication system when an increased first communication capacity is to be provided by increasing a number of second line cards.

28. The method of claim **27**, wherein the first communication capacity is based on the number of the second line cards, and further comprising:

increasing the number of second line cards when a load on the first communication capacity exceeds a predetermined threshold.

29. The method of claim **27**, further comprising:

connecting the second line cards to the second modem group slot when the second satellite communication function is to be provided.

30. The method of claim **27**, further comprising:

communicating with a first user across a first user network from a first protocol processor operatively connected to the shared hub modem chassis;

sharing the protocol processing between the first protocol processor and a second protocol processor if the second protocol processor is operatively connected to the shared hub modem chassis; and

exclusively performing the protocol processing in the first protocol processor if the second protocol processor is not operatively connected to the shared hub modem chassis,

said first protocol processor providing an increased protocol processing capacity for said satellite communication system when the second protocol processor is added.

31. The method of claim **30**, further comprising:

connecting the second protocol processor to the shared hub modem chassis when a load on the first protocol processor exceeds a predetermined threshold.

32. A computer program product storing computer program instructions which when executed by a computer cause the computer to perform the following steps:

performing a first satellite communication function using first line cards, said first line cards having a first communication capacity and are installed in first line card slots in a shared hub modem chassis containing first line card slots and second line card slots,

wherein said first line cards are operatively connected by said first line card slots to a first satellite IF/RF converter configured to communicate with a first satellite, and said second line card slots being operatively connected to a second satellite IF/RF converter configured to communicate with a second satellite;

providing a second satellite communication function from the second line card slots if the second line cards are operatively connected to the second line card slots and not providing a second satellite communication function if the second line cards are not operatively connected to the second line card slots,

said second line card slots providing an expansion capability for said satellite communication system when the

26

second satellite communication function is to be provided by adding the second line cards, and

said second line card slots providing an expansion capability for said satellite communication system when an increased first communication capacity is to be provided by increasing a number of second line cards.

33. The computer program product of claim **32**, wherein the first communication capacity is based on the number of the second line cards, and further comprising:

increasing the number of second line cards when a load on the first communication capacity exceeds a predetermined threshold.

34. The computer program product of claim **32**, further comprising:

connecting the second line cards to the second modem group slot when the second satellite communication function is to be provided.

35. The computer program product of claim **32**, further comprising:

communicating with a first user across a first user network from a first protocol processor operatively connected to the shared hub modem chassis;

sharing the protocol processing between the first protocol processor and a second protocol processor if the second protocol processor is operatively connected to the shared hub modem chassis; and

exclusively performing the protocol processing in the first protocol processor if the second protocol processor is not operatively connected to the shared hub modem chassis,

said first protocol processor providing an increased protocol processing capacity for said satellite communication system when the second protocol processor is added.

36. The computer program product of claim **35**, further comprising:

connecting the second protocol processor to the shared hub modem chassis when a load on the first protocol processor exceeds a predetermined threshold.

37. A scalable satellite communication device comprising:

first line card slots;

second line card slots; and

first line cards in the first line card slots,

wherein said first line cards are operatively connected by said first line card slots to a first satellite IF/RF converter configured to communicate with a first satellite, said first line cards further configured to perform a first satellite communication function and to have a first communication capacity,

said second line card slots operatively connected to a second satellite IF/RF converter configured to communicate with a second satellite, said second line card slots further configured to provide a second satellite communication function if the second line cards are operatively connected to the second line card slots and to not provide a second satellite communication function if the second line cards are not operatively connected to the second line card slots,

said second line card slots providing an expansion capability for said satellite communication system when the second satellite communication function is to be provided by adding the second line cards, and

said second line card slots providing an expansion capability for said satellite communication system when an increased first communication capacity is to be provided by increasing a number of second line cards.