

US007198572B2

(12) **United States Patent**
Walker et al.

(10) **Patent No.:** **US 7,198,572 B2**
(45) **Date of Patent:** **Apr. 3, 2007**

(54) **SLOT DRIVEN VIDEO STORY**

(75) Inventors: **Jay S. Walker**, Ridgefield, CT (US);
James A. Jorasch, Stamford, CT (US);
Thomas M. Sparico, Riverside, CT
(US); **Jesse M. Fink**, Wilton, CT (US)

(73) Assignee: **Walker Digital, LLC**, Stamford, CT
(US)

(*) Notice: Subject to any disclaimer, the term of this
patent is extended or adjusted under 35
U.S.C. 154(b) by 0 days.

(21) Appl. No.: **10/882,859**

(22) Filed: **Jul. 1, 2004**

(65) **Prior Publication Data**

US 2004/0242304 A1 Dec. 2, 2004

Related U.S. Application Data

(63) Continuation of application No. 10/272,554, filed on
Oct. 16, 2002, now Pat. No. 6,893,341, which is a
continuation of application No. 09/798,719, filed on
Mar. 2, 2001, now Pat. No. 6,500,068, which is a
continuation of application No. 08/832,723, filed on
Apr. 11, 1997, now Pat. No. 6,234,896.

(51) **Int. Cl.**
A63F 9/24 (2006.01)

(52) **U.S. Cl.** **463/25; 463/16; 463/30**

(58) **Field of Classification Search** 463/1,
463/9-13, 16-22, 25-31, 40-43; 273/143 R,
273/139, 138.1, 138.2, 292-293; 700/91-93;
705/1, 16-17, 39, 41; 725/5-8, 23, 25, 30,
725/32, 34, 86, 141, 153

See application file for complete search history.

(56) **References Cited**

U.S. PATENT DOCUMENTS

4,375,286 A	3/1983	Seitz et al.	273/121 A
4,553,748 A	11/1985	Allen et al.	273/1 E
4,618,150 A	10/1986	Kimura	273/143 R
4,799,683 A	1/1989	Bruner, Jr.	273/138 A
4,839,743 A	6/1989	Best et al.	358/310

(Continued)

FOREIGN PATENT DOCUMENTS

GB 2072395 A 9/1981

OTHER PUBLICATIONS

“IGT Launches Next-Generation Video Gaming machine”, PR
Newswire, Aug. 23, 1995, Section: Financial News.

(Continued)

Primary Examiner—Mark Sager

(57) **ABSTRACT**

A gaming system includes a network server connected to a
plurality of gaming devices that are adapted to provide a
video payout on each play based on a set of payout param-
eters. Memory at each gaming device stores payout param-
eters that correspond to each possible gaming result or
outcome. When a play is initiated by a player, a gaming
result is generated at a gaming device. The gaming device
responds by accessing a corresponding payout parameter
from the memory which may be a monetary amount, a video
presentation segment or a combination thereof. If the payout
is video, the network server receives the payout parameter
and transmits video presentation segment to the gaming
device accordingly. The gaming device then provides a
video payout, in the form of displayed video presentation, to
the player. The player thus receives at least one form of
payment on each play.

25 Claims, 13 Drawing Sheets

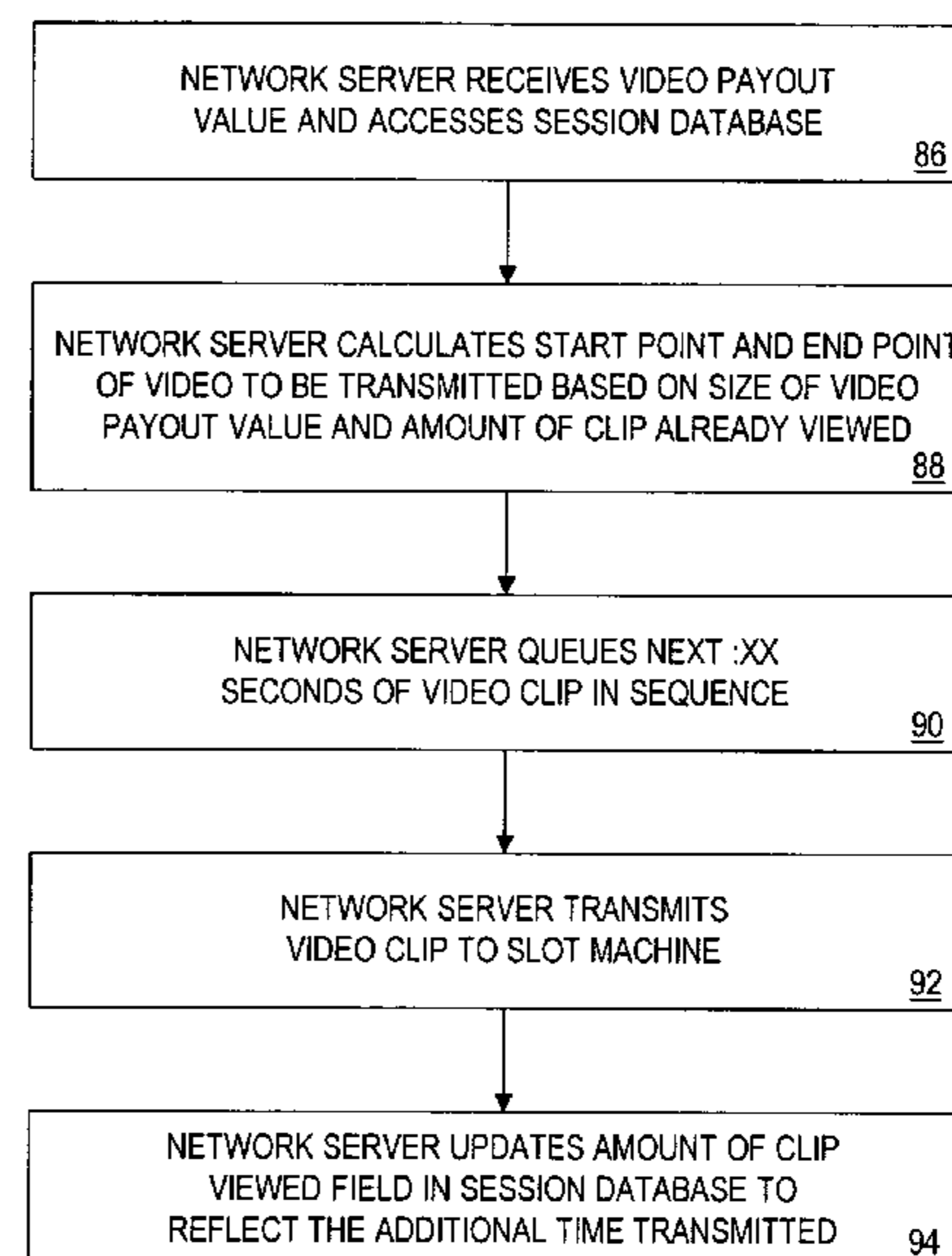
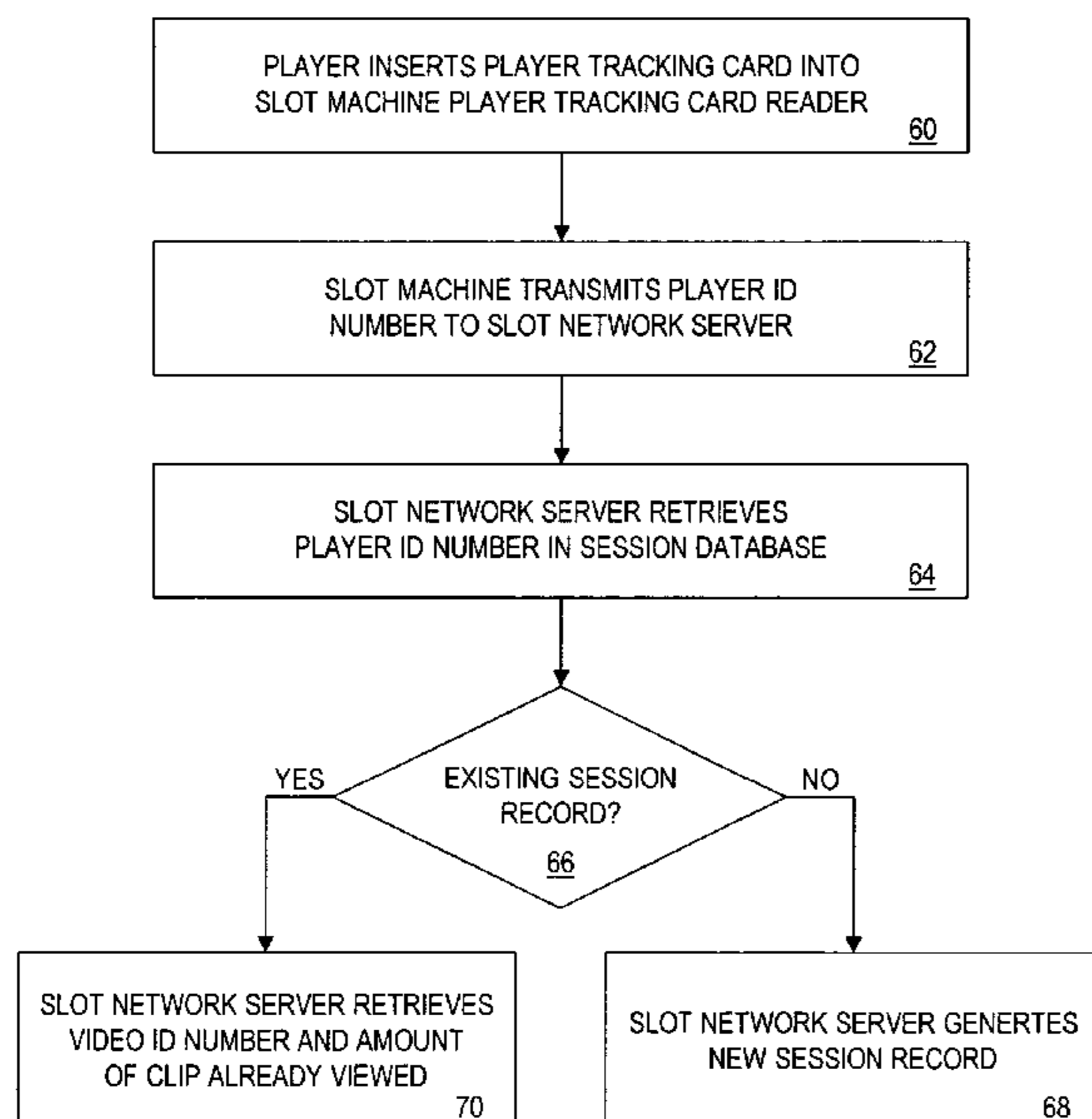

U.S. PATENT DOCUMENTS

4,858,930 A	8/1989	Sato	273/85 G	5,664,998 A	9/1997	Seelig et al.	463/20
5,127,651 A	7/1992	Okada	273/143 R	5,664,999 A	9/1997	Kurihara	463/20
5,142,358 A	8/1992	Jason	359/93	5,697,843 A	12/1997	Manship et al.	463/20
5,259,613 A	11/1993	Marnell, II	273/138 A	5,770,533 A	6/1998	Franchi	463/42
5,373,440 A	12/1994	Cohen et al.	364/410	5,779,549 A	7/1998	Walker et al.	463/42
5,393,061 A	2/1995	Manship et al.	273/143 R	5,788,573 A	8/1998	Baerlocher et al.	463/16
5,411,258 A	5/1995	Wilson et al.	273/86 B	5,947,820 A	9/1999	Morro et al.	463/9
5,423,539 A	6/1995	Nagao	273/143 R	5,971,851 A	10/1999	Pascal et al.	463/24
5,449,173 A	9/1995	Thomas et al.	273/143 R	6,110,041 A	8/2000	Walker et al.	463/20
5,472,195 A	12/1995	Takemoto et al.	273/138 A	6,186,893 B1	2/2001	Walker et al.	463/20
5,488,411 A	1/1996	Lewis	348/8	6,224,486 B1	5/2001	Walker et al.	463/42
5,494,287 A	2/1996	Manz	273/143 R	6,234,896 B1	5/2001	Walker et al.	463/16
5,508,731 A	4/1996	Kohorn	348/1	6,500,068 B2	12/2002	Walker et al.	
5,513,846 A	5/1996	Niederlein et al.	273/143 R	6,811,482 B2	11/2004	Letovsky	
5,579,537 A	11/1996	Takahisa	455/66				
D378,604 S	3/1997	Brettschneider	D21/37				
5,612,730 A	3/1997	Lewis	348/8				
5,630,754 A	5/1997	Rebane	463/9				
5,655,961 A	8/1997	Acres et al.	463/27				

OTHER PUBLICATIONS

Brochure: "Welcome to Video Reality!", Atronic Casino Technology, Oct. 1995.
 "More 'Dotmation' Slots Hit Tower", Atlantic City Insider, Revealing the Casinos Best-Kept Secrets, Jan. 1997, vol. 1.

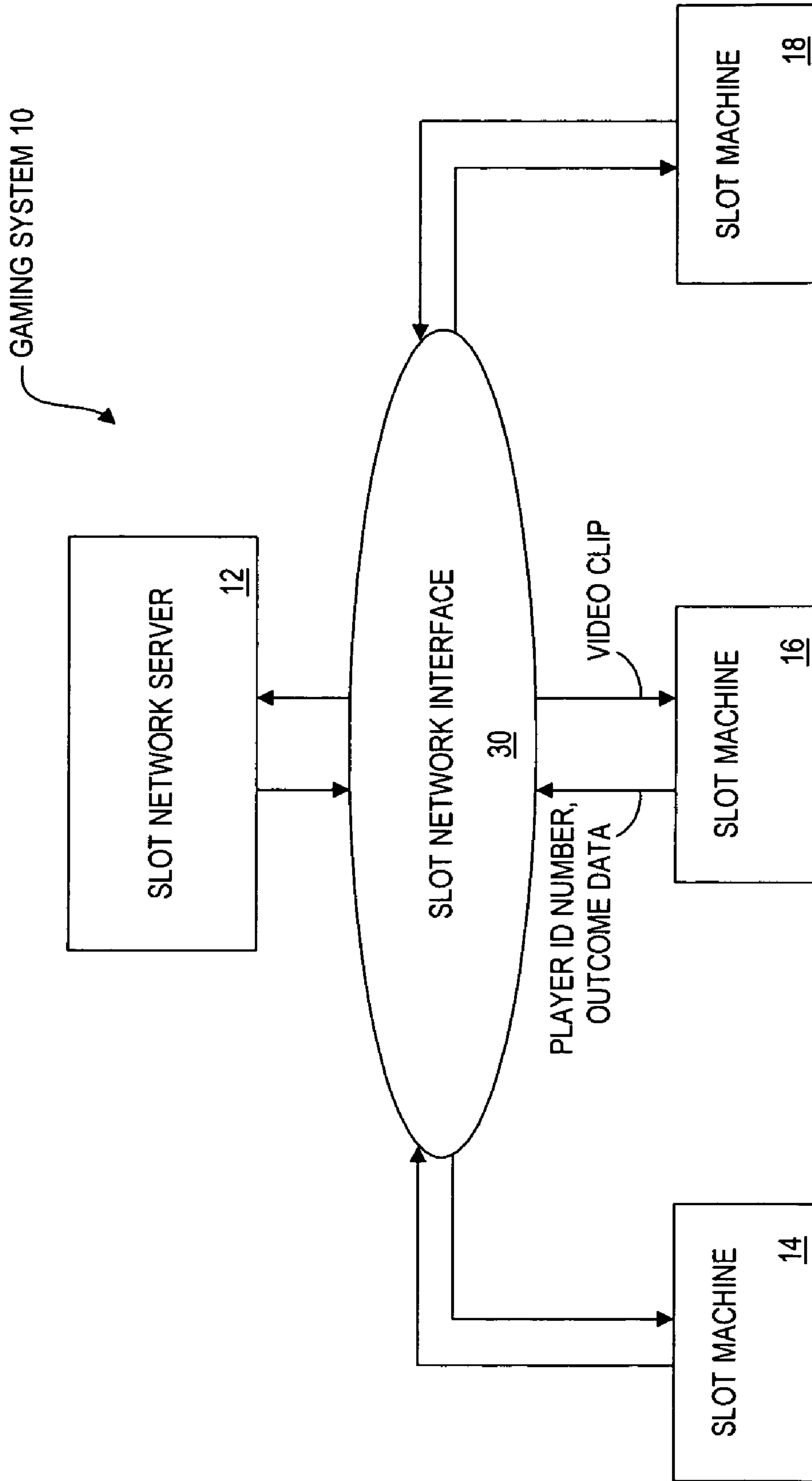

FIG. 1

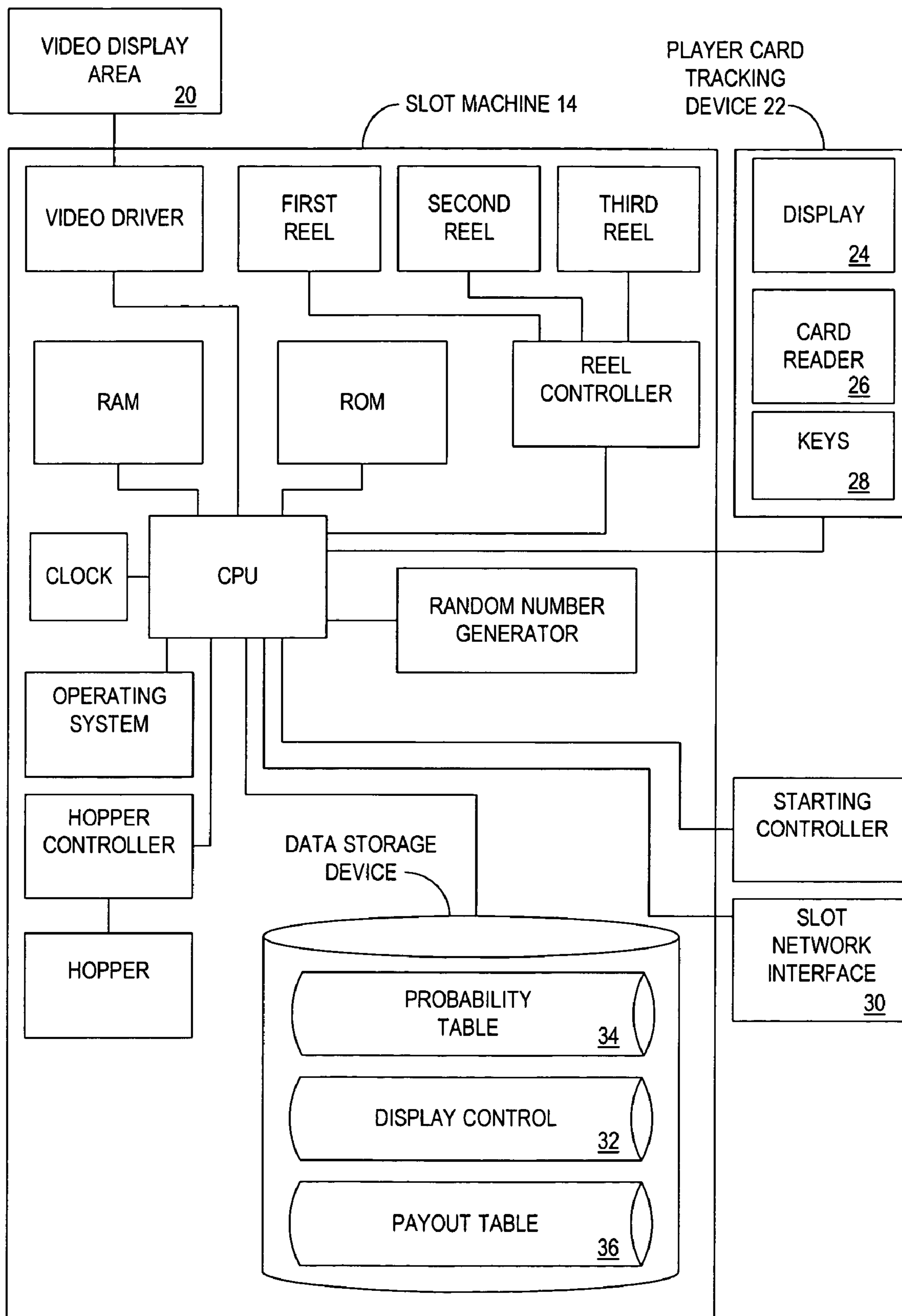

FIG. 2

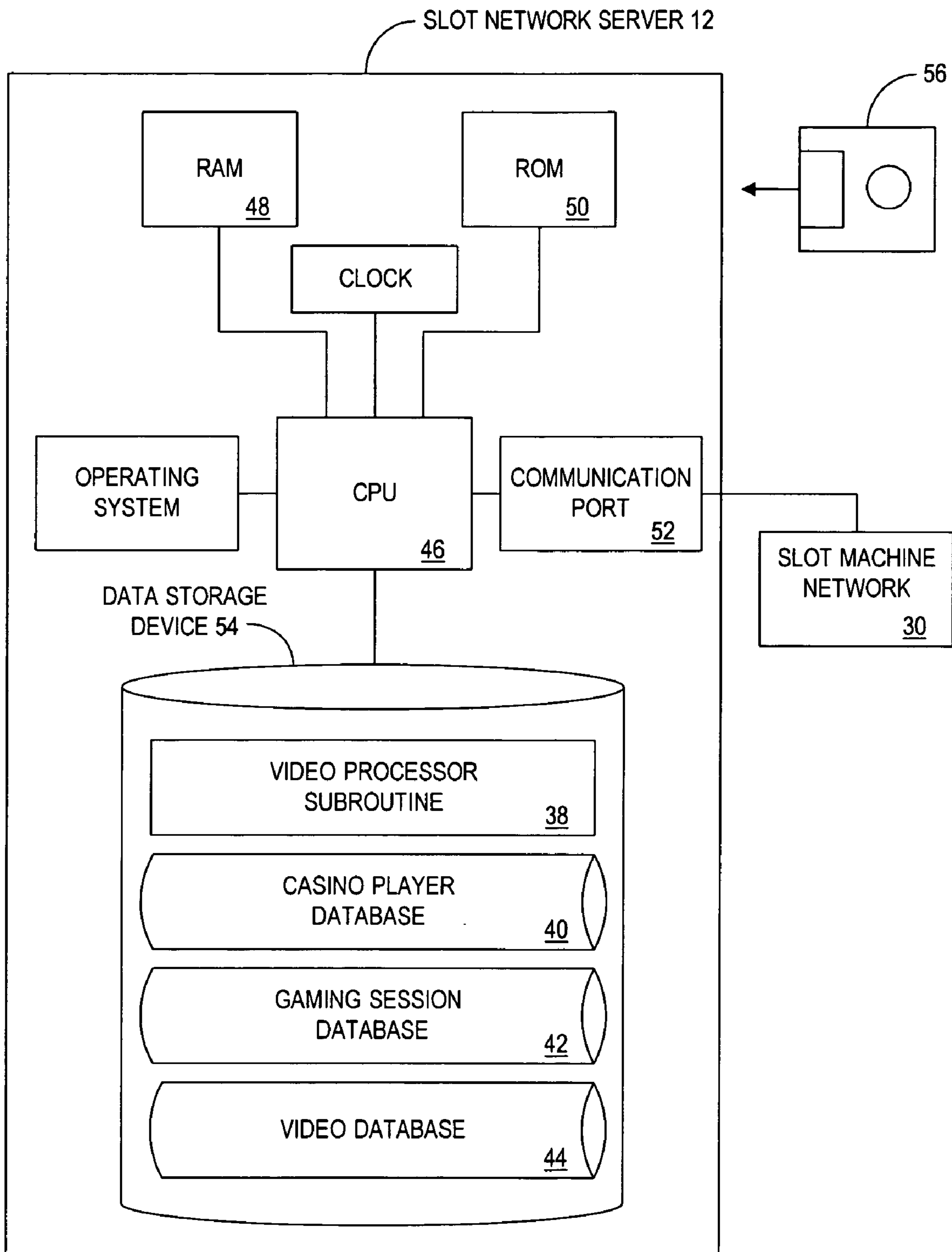

FIG. 3

CASINO PLAYER DATABASE 40



NAME	PLAYER ID NUMBER	ADDRESS	PREFERRED VIDEO CATAGORIES
BOB SMITH	4356-ABC	124 MAIN ST. ANYTOWN	COMEDY
DOUG JONES	1234-FVT	345 MAIN ST. SOMETOWN	SPORTS

FIG. 4

GAMING SESSION DATABASE 42



SLOT MACHINE ID NUMBER	SLOT MACHINE TYPE	PLAYER ID NUMBER	VIDEO CATEGORY	VIDEO ID NUMBER	AMOUNT OF CLIP VIEWED ALREADY	OUTPUT DEVICE
RIXSCPU	BALLY 2A	4356-ABC	SPORTS	SP2345	2 MINS. 46 SECONDS	VIDEO SCREEN
50BGCRP	IGT 45DE	1234-FVT	ADVENTURE	AD5643	31 SECONDS	VR GOGGLES

FIG. 5

VIDEO DATABASE 44



VIDEO ID NUMBER	CATAGORY	TITLE	LENGTH (TIME)
SP2345	SPORTS	1996 BASEBALL HIGHLIGHTS	20 MINUTES
AD5643	ADVENTURE	AMAZON JOURNEY	15 MINUTES

FIG. 6

SLOT MACHINE PAYOUT TABLE 36



REEL OUTCOME	1 COIN	2 COINS	3 COINS
BAR/BAR/BAR	50	100	150
CHERRY/CHERRY/CHERRY	25	50	75
LEMON/LEMON/LEMON	15	30	45
BELL/BELL/BELL	10	20	30
BAR/BAR/CHERRY	5	10	15
CHERRY/CHERRY/BAR	1	2	3
BELL/BELL/LEMON	30 SEC. VIDEO	60 SEC. VIDEO	90 SEC. VIDEO
PEACH/PEACH/BELL	15 SEC. VIDEO	30 SEC. VIDEO	45 SEC. VIDEO
ALL OTHERS (LOSING COMBINATIONS)	10 SEC. VIDEO	20 SEC. VIDEO	30 SEC. VIDEO

FIG. 7

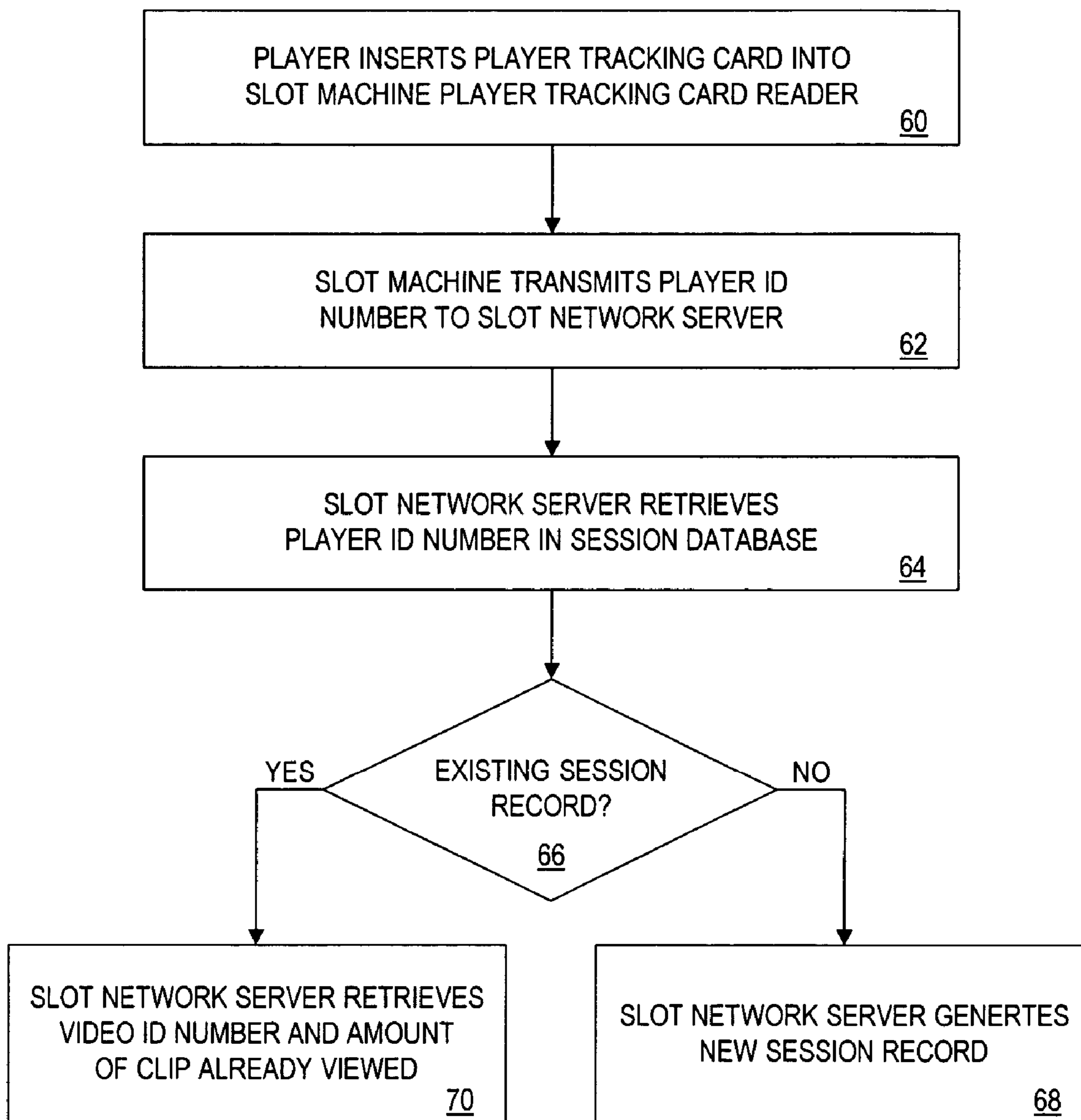

FIG. 8

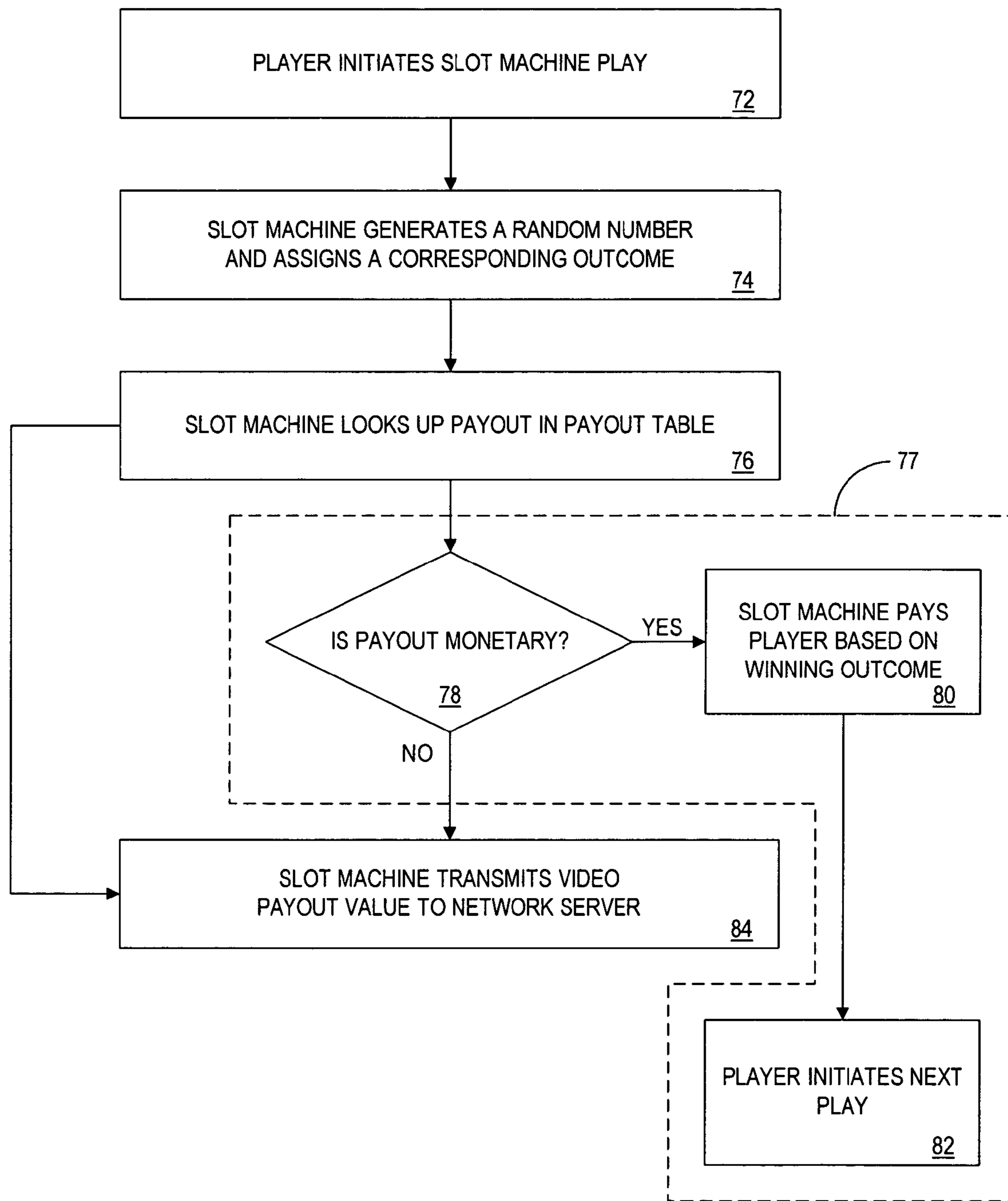

FIG. 9

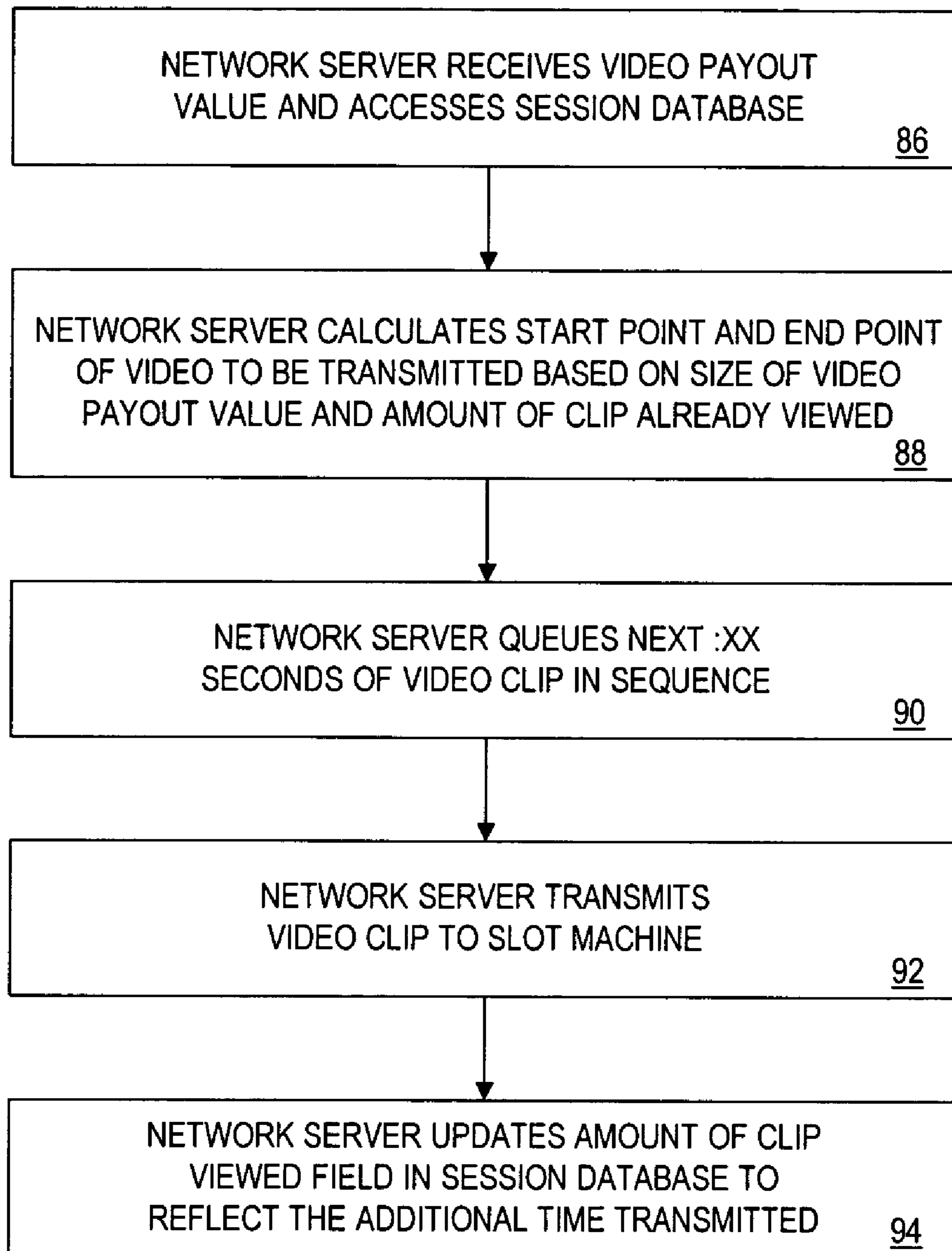

FIG. 10

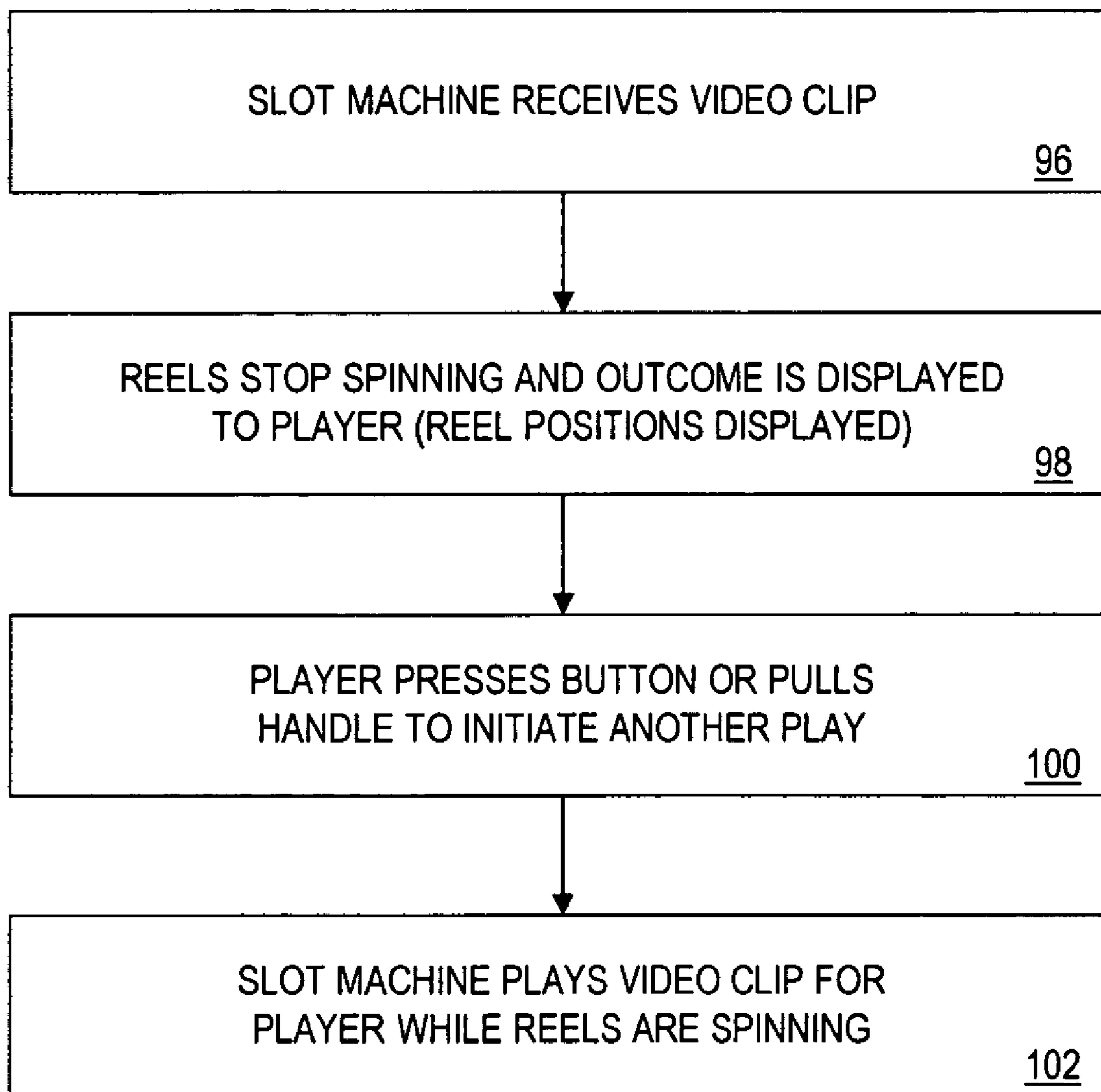

FIG. 11

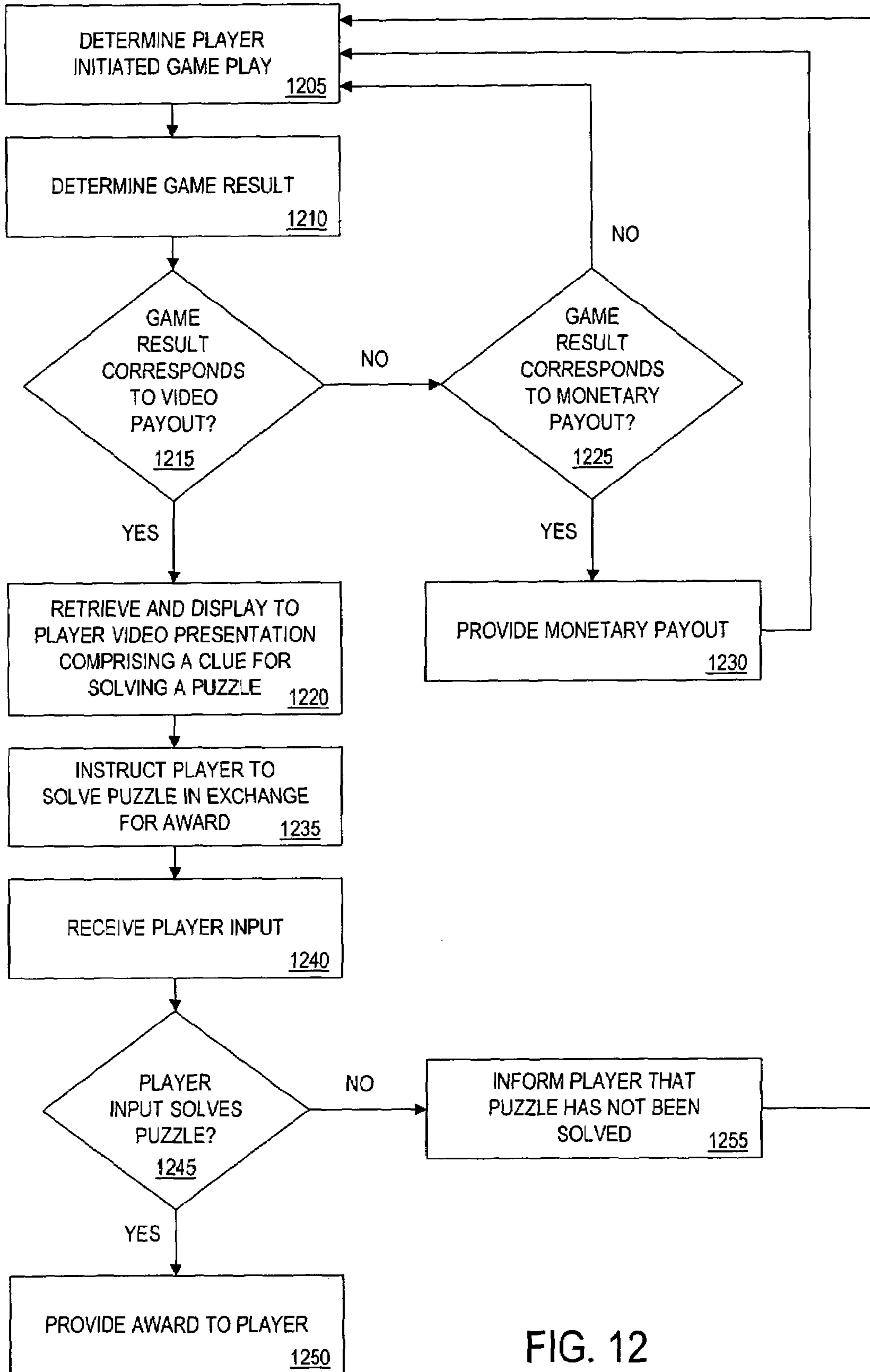

FIG. 12

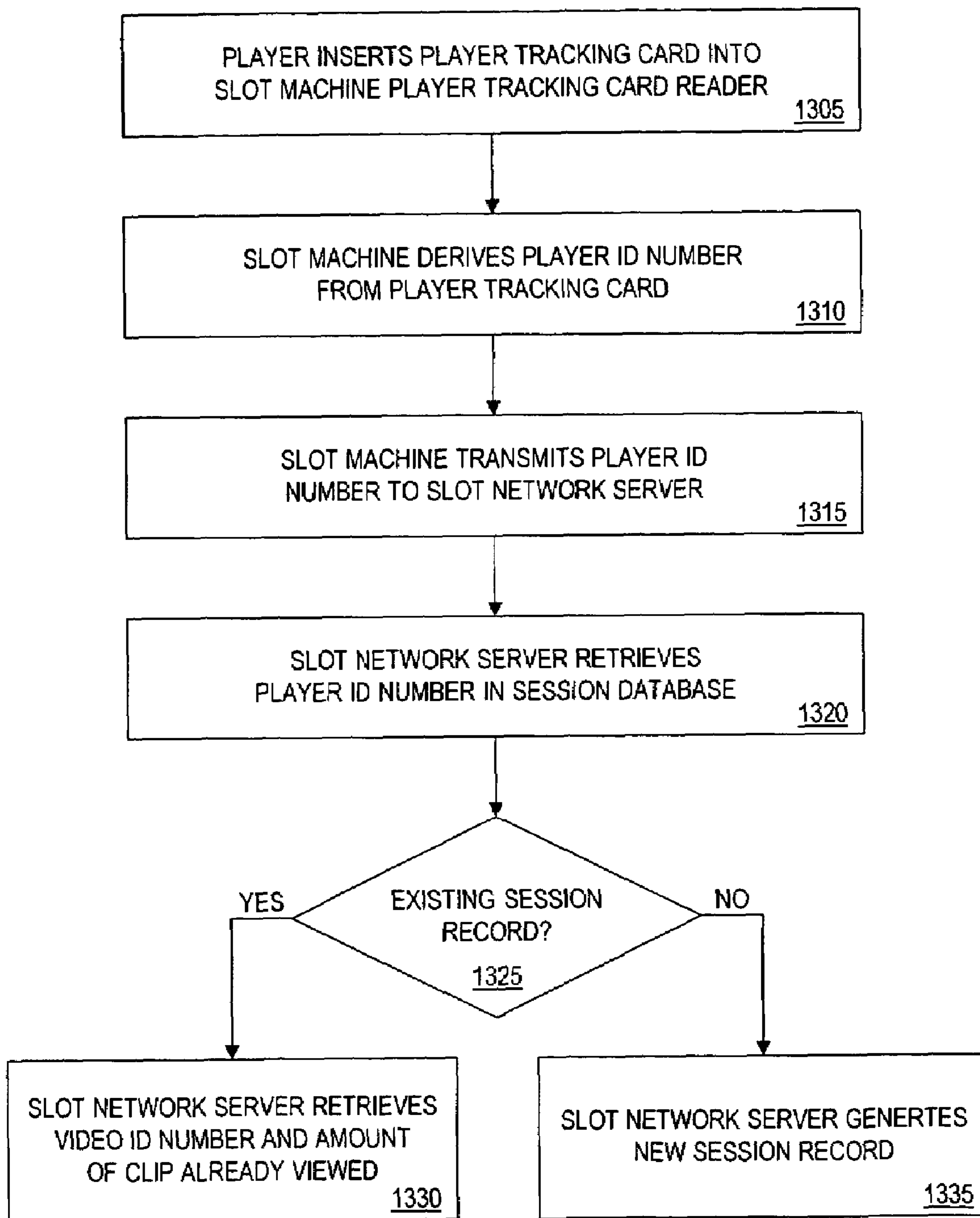

FIG. 13

SLOT DRIVEN VIDEO STORY

The present application is a continuation application of commonly-owned, U.S. patent application Ser. No. 10/272, 554, filed Oct. 16, 2002 in the name of Walker et al. and entitled SLOT DRIVEN VIDEO STORY, which issued as U.S. Pat. No. 6,893,341 on May 17, 2005;

which is a continuation application of commonly-owned, U.S. patent application Ser. No. 09/798,719, filed Mar. 2, 2001 in the name of Walker et al. and entitled SLOT DRIVEN VIDEO STORY, and which issued as U.S. Pat. No. 6,500,068 B1 on Dec. 31, 2002; which is a continuation application of commonly-owned, U.S. patent application Ser. No. 08/832,723, filed Apr. 11, 1997 in the name of Walker et al. and entitled SLOT DRIVEN VIDEO STORY, and which issued as U.S. Pat. No. 6,234,896 B1 on May 22, 2001.

FIELD OF THE INVENTION

This invention relates to a gaming system which provides a payout for each play and, more particularly, to a system which selectively provides a video presentation to a user, as a form of non-monetary compensation, in accordance with criteria such as player identification data and a gaming result.

BACKGROUND OF THE INVENTION

Slot machines provide an important source of revenue for the gaming industry. For that reason, gaming establishments constantly search for new gaming strategies and features to provide additional incentives for slot machine players to continue play. Some gaming devices now provide video or graphical information to entertain a player during play. For instance, some slot machines provide "Dotmation", a computer controlled LED display, that ties a game to an animated character. Such a system is currently utilized in "Piggy Bankin", wherein a pig dances around an LED display screen as the slot machine play ensues.

Another approach is found in U.S. Pat. No. 5,259,613, entitled "Casino and Entertainment Systems" wherein gaming devices are furnished with audio/video communication equipment that is connected to a central control station. The control station selectively engages in both voice and video communication with the players at each individual slot machine. Live sporting events and even daytime soap opera television can be displayed.

It is also known that some gaming devices provide an increased probability of winning to attract players. For example, U.S. Pat. No. 5,423,539 (Nagao) entitled "Slot Machine with Payout Modifying Symbols" describes a gaming device in which a player wins by obtaining a certain combination of characters associated with a winning table (e.g., the various winning combinations). The gaming system includes a wild card which may be substituted for any character and, thus, increases the probability of a player receiving a winning combination of characters.

Gaming devices have also been known to provide complimentary points for players who are members of slot clubs. These slot clubs provide the player with a slot tracking card which when inserted into the slot machine rewards the player with comp points for each handle pull or game play. These points, which may be redeemed for some prize or gift, are part of casino programs used to attract players. Complimentary points are automatically provided to a player simply for initiating a gaming play, (e.g., paying a monetary sum to

begin a play), but do not form part of the prize structure of the underlying game. In other words, complimentary points are provided to a player regardless of the gaming result. In most cases, the monetary sum paid by the player into the slot machine determines the amount of complimentary points to be provided by the casino.

There is a continuing desire on the part of gaming establishments to enhance the playing and winning experience at slot machines with video or graphic information.

SUMMARY OF THE INVENTION

Accordingly, it is an object of the invention to provide a gaming device which contains a payout table which results in a player receiving a "payout" for every possible gaming result.

A further object of the invention is to provide a system for provision of a video presentation to slot machine players, wherein the video presentation is output as a form of a low-level non-monetary winning.

A further object of the invention is to provide a gaming system, wherein a player can terminate a video presentation at a gaming device and can resume display of the video presentation from the point of termination, at another time or gaming device.

A further object of the invention is to provide a gaming device for provision of a video presentation wherein the video presentation can be used as part of a skill-game puzzle, with a prize structure separate from the gaming device.

A further object of this invention is to provide a gaming system which provides a payout, either as a monetary award or as a displayed video presentation, on each play, based on a set of payout conditions.

A gaming system includes a network server connected to a plurality of gaming devices that are adapted to provide a video payout on each play based on a set of payout parameters. Memory at each gaming device stores payout parameters that correspond to each possible gaming result or outcome. When a play is initiated by a player, a gaming result is generated at a gaming device. The gaming device responds by accessing a corresponding payout parameter from the memory which may be a monetary amount, a video presentation segment or a combination thereof. If the payout is video, the network server receives the payout parameter and transmits a video presentation segment to the gaming device accordingly. The gaming device then provides a video payout, in the form of a displayed video presentation, to the player. The player thus receives at least one form of payment on each play.

BRIEF DESCRIPTION OF THE DRAWINGS

FIG. 1 is a block diagram of a network with a network server that cooperates with a plurality of slot machines to provide video payouts to players for each slot machine play.

FIG. 2 is a block diagram of a slot machine with video capability.

FIG. 3 is a block diagram of the slot network server.

FIG. 4 is a schematic diagram of a player database maintained in the network server.

FIG. 5 is a schematic diagram of a session database maintained in the network server.

FIG. 6 is a schematic diagram of a video database maintained in the network server.

FIG. 7 is a schematic diagram of a payout table database maintained in the slot machine.

FIG. 8 illustrates a logic flow diagram of the initiation of a slot machine play.

FIGS. 9 through 11 illustrate a logic flow diagram of the operation of a slot machine play.

FIG. 12 is a flow diagram illustrating an exemplary process according to an embodiment of the present invention.

FIG. 13 is a flow diagram illustrating an exemplary process according to an embodiment of the present invention.

DETAILED DESCRIPTION OF THE INVENTION

Before proceeding with a detailed description of a preferred embodiment of the present invention, it is well to define certain terms as used herein. Although the embodiments discussed herein are directed to slot machines, it is to be understood that the present invention is equally applicable to other gaming devices, such as video poker machines, video blackjack machines, video roulette machines, video keno machines, video bingo machines, and the like.

The term "video presentation" or "video information" when used to describe a payout refers to a movie, music video, soap opera, sporting event, or other video entertainment material. This video information is presented via a video display.

The term "resume code" will be used hereafter to refer to data, provided to a player upon a termination of a video presentation, which allows the player to resume display of the video presentation at another time or gaming device. That is to say, in certain cases, a player may desire to terminate display of the video presentation before the entire video presentation has been viewed. In such a case, the resume code allows a player to continue display of the video presentation, from the point of termination, at another time or gaming device. The resume code may take the form of any combination of characters (e.g., ABCD1, \$%j1, etc.).

FIG. 1 is a block diagram of a gaming system 10 in accordance with the present invention. Gaming system 10 includes a network server 12 which is connected to a plurality of slot machines 14, 16, 18 via a slot network interface 30. Each slot machine 14, 16, 18 is adapted to receive player data, (e.g., a Player ID Number), and to generate a gaming result and a corresponding payout parameter for each play. The player data and payout parameters from each slot machine 14, 16, 18 are respectively transmitted to network server 12, via network interface 30.

Network server 12 receives the player data and payout parameters and selects a video presentation for each respective slot machine based on the player data and payout parameters. The selected video presentation is then transmitted, via slot network interface 30, to the appropriate slot machine (14, 16, 18) for display. Instead of storing the video presentation in network server 12 and transmitting the video information to slot machine 14, 16, 18, the video information can be stored locally in each slot machine 14, 16, 18 for subsequent display.

FIG. 2 illustrates a block diagram of a slot machine 14. Slot machine 14 is configured in a manner known in the prior art, except for a display control subroutine 32, a probability database 34 and a payout database 36. Player tracking device 22 includes a display 24, a card reader 26 and buttons 28 ("soft" or "hard") for enabling a player to input data into slot machine 14. It should be noted that "buttons" can refer to a touchscreen button or a physical

button on the outside of the machine casing. A video display area 20 may also be provided in slot machine 14, but may not be externally accessed by network server 12. If this is the case, display 24 is used to display downloaded video information (e.g., movies, music videos, etc.) and further messages to the player. Each of the remaining submodules within slot machine 14 is known to those skilled in the art and requires no detailed discussion.

Display control subroutine 32 controls the operation of tracking device 22, including card reader 26 and buttons 28. When a player inputs a selection or other data via buttons 28, such entry is recognized by display control subroutine 32, which causes the resident CPU in slot machine 14 to configure the entered data for transmission over slot network interface 30 to network server 12.

Network server 12 includes a video processor subroutine 38 which is stored therein or which can be loaded thereinto via a magnetic disk 56 (FIG. 3). The video processor subroutine 38, in combination with the network server hardware, provides control and updating of connected databases, and selection and transmission of video presentation material to connected slot machines. The video processor subroutine 38 further processes input signals from the players at the respective slot machines.

FIG. 3 illustrates a block diagram of a representative network server 12. Network server 12 includes a central processor unit (CPU) 46 which is coupled to a random access memory (RAM) 48, a read only memory (ROM) 50 and a communication port 52 which provides interconnection to slot machine interface 30. A data storage device 54 provides memory capacity for a video processor subroutine 38, a casino player database 40, a gaming session database 42 and a video database 44.

A schematic illustration of the contents of the casino player database 40 is found in FIG. 4 and preferably includes Name; Player Identification (ID) Number; Address; and Preferred Video Categories. Most of the contents of player database 40 are self explanatory and require no further description. The Preferred Video Categories identifies types of video information, (e.g., sports, adventure, etc.). In essence, player database 40 provides sufficient information to enable network server 12 to perform the invention hereof without requiring any further data from the player.

Gaming session database 42 is schematically shown in FIG. 5 and includes the following data:

- Slot Machine Identification (ID) Number;
- Slot Machine Type;
- Player ID Number;
- Video Category;
- Video Identification (ID) Number;
- Amount of Clip Viewed Already; and
- Output Device.

Most of the contents of session database are self-explanatory and require no further description. Slot Machine Type identifies the make and model of the slot machine being played. Video ID Number identifies a particular video previously viewed by the player. "Amount of Clip Viewed Already" indicates how much of the video information has been previously viewed by the player. Output Device indicates the type of display device used for each particular video information source (e.g., display screen, Virtual-Reality glasses, etc.).

Video database 44 is shown in FIG. 6 and has fields including Video ID Number, Category, Title and Length (time). Video ID Number identifies a particular video presentation. Category classifies the type of video presentation,

(e.g., action, sports, etc.) Title is the title of each video presentation. Finally, Length (Time) indicates the length of time of the entire video presentation.

FIG. 7 schematically illustrates a payout database 36 and includes Reel Outcome, 1 Coin, 2 Coins and 3 Coins fields. The Reel Outcome field identifies all possible permutations of gaming results for slot machine 14. The 1 Coins through 3 Coins fields correspond to payout parameters (e.g., pre-determined payout) associated with each possible gaming result. That is to say, every possible combination of gaming outcome in the Reel Outcome field is associated with a payout parameter, thereby ensuring that each slot machine play results in payout, (e.g., at least a presentation of video information.) For instance, a player, inserting three coins and receiving a gaming result of 2 Bells & a Lemon, will receive 45 seconds worth of a video presentation.

Before proceeding with a description of the operation of the first embodiment of the invention, it should be understood that in a preferred embodiment each slot machine is configured to provide at least a video payout (e.g., a video presentation), on each slot machine play, in addition to conventional payouts (e.g., a monetary sum) that are commonly provided by slot machines. Therefore, a player always wins at least a video payout on each play. In alternate embodiments, the invention includes payouts of video information as the only payout, and/or video payouts supplemental to normal cash payouts but without a win on every play.

Turning now to FIGS. 8 through 11, the operation of the first embodiment of the invention will be described. Initially, each slot machine 14, 16, 18 has had loaded and stored therein probability table 34, payout table 36 and display control subroutine 32. The network server 12 also has had loaded and stored therein video processor subroutine 38 player database 40, session database 42 and video database 44. Such stored databases enable network server 12 to selectively provide a video presentation to players at each individual slot machines 14, 16, 18.

As shown in FIG. 8, a player begins a slot machine play session by inserting a player tracking card (not shown) into card reader 26 of slot machine 14 (Box 60). The player tracking card stores at least a Player ID Number and may also store monetary credit information. Slot machine 14 transmits the Player ID Number to network server 12 over slot network interface 30 (Box 62). Network server 12 receives the Player ID Number, accesses session database 42 (Box 64) and determines whether a session record exists for the Player ID Number (Box 66). If a session record exists, network server 12 retrieves the Video ID Number and Amount of Clip Already Viewed that are associated with the Player ID Number (Box 70). Otherwise, network server 12 generates a new session record in session database 42, for the new Player ID Number (Box 68). Such an arrangement allows a player to resume display of a video presentation at a future play session and, thus, provides additional incentive for a player to resume slot machine play.

While not shown in FIG. 8, slot machine 14 may utilize other methods for receiving player data. For instance, a player can manually input a resume code or Player ID Number (as described above), instead of utilizing a player tracking card. The resume code or Player ID Number would be provided to a player upon a termination of a video presentation by the player. A player can then input the resume code or Player ID Number, via buttons 28, at another time or gaming device and resume display of the video presentation from the point of termination. As with the player tracking card embodiment described above, the

player provided Player ID Number or resume code is likewise transmitted to network server 12 for processing.

Thereafter, a player can commence slot machine play, as shown in FIGS. 9 through 11. A player initiates a slot machine play by pulling a handle or pushing a "spin reels" button (Box 72). Slot machine 14 then generates a random number and assigns a corresponding outcome to the random number (Box 74). The CPU of slot machine 14 accesses payout database 36, locates the particular gaming result under Reel Outcome field and assigns a corresponding payout parameter from either the 1 Coin, 2 Coins or 3 Coins field accordingly (Box 76). The payout parameter is then transmitted to network server 12.

Network server 12 receives the payout parameter and accesses session database 42 (Box 86). Based on the Player ID Number, network server 12 selects a video presentation accordingly. For example, the network server would select video presentation SP2345, a sports video, for Player ID Number 4356-ABC.

Network server 12 (FIG. 10) then calculates a start point and an end point of video presentation to be transmitted to slot machine 14 based on the payout parameter (e.g., 45 seconds of video presentation) and an amount of video presentation already viewed by the player (Box 88). Other gaming results or player factors may also be considered in calculating the length of video presentation. For example, the length of a play session or player status (e.g., preferred player) could extend the length of the presentation.

Network server 12 then queues the next portion of the video presentation in sequence for transmission (Box 90) and transmits the video presentation to slot machine 14 (Box 92). After transmission, the Amount Of Clip Viewed field of session database 42 is updated to reflect the additional time period of transmitted video presentation (Box 94).

Thereafter, slot machine 14 receives the video presentation from network server 12 (Box 96) and the reels stop spinning to display the gaming result to the player (Box 98). The video presentation is then displayed on display 24 of slot machine 14 (Box 102), and a player can initiate the next slot machine play (Box 100), as the video presentation is displayed. Note that a player continuously playing a slot machine (e.g., initiating one slot machine play after another) will receive a continuous video stream of video presentation.

In a second embodiment of the present invention, slot machine 14 utilizes the video presentation to provide an additional puzzle-type game. Each video presentation portion (e.g., video clip) displayed to the player upon a non-monetary payout parameter provides a clue for solving a puzzle. The puzzle may be a murder mystery, trivia game, etc. After each displayed video presentation portion, the player is instructed over display 24 to solve the puzzle, for example, by selecting one of multiple answer choices which is then compared with a pre-defined answer or player input associated with the displayed video presentation. Such a gaming feature may be a form of payout in itself or may provide a prize structure of its own.

In the preferred embodiment of the present invention, slot machine 14 provides either a monetary payout or a video payout, for each slot machine play. The payout is based on the gaming result and the corresponding payout parameter from payout database 36. Note that the video payouts are provided for each gaming result that typically provides no monetary payout, (e.g., a losing gaming result or outcome.) For instance, a gaming result corresponding to 3 Bars would result in a monetary payout to the player, whereas 2 Peaches & 1 Bell would result in a video payout to the player.

Payout database **36** (FIG. 7) is adapted to include monetary payout parameters and video payout parameters. Each possible gaming result or combination in payout database **36** has a corresponding payout parameter, either as a monetary payout parameter (e.g., cash or credit) or a video payout parameter (e.g., video presentation).

Slot machine **14** is adapted to identify an occurrence of a monetary payout parameter as compared to a video payout parameter and to provide a corresponding payout to the player. Referring to FIG. 9, such an arrangement is accomplished by incorporating additional steps to the operation of the invention described above, as indicated by the reference number **77** (FIG. 9). Specifically, after a gaming result is generated and a corresponding payout parameter is selected from payout database **26** (Boxes **74**, **76**), slot machine **14** determines whether the payout parameter is a monetary payout parameter or a video payout parameter (Box **78**).

If the payout parameter is monetary, slot machine **14** can issue the monetary payout, either as cash or locally stored machine credits (Box **80**). Cash can be directly dispensed to the player or credited to an account maintained locally at the machine or remotely at the server. In any case, after a monetary payout is issued, a player can then initiate the next slot machine play (Box **82**).

If the payout parameter is a video payout, slot machine **14** transmits the payout parameter to network server **12** (Box **84**). At this point, network server **12** performs the same operations as those described above for the first embodiment (FIGS. **10** and **11**), namely, selecting a segment of video presentation and transmitting it back to slot machine **14** for display.

Although slot machine **14**, in this case, provides either a video payout or a monetary payout, other payouts or combination of payouts may also be provided. Such payouts may include a free play, frequent flyer miles, etc. Payout database **36**, likewise, would be adapted to include additional payout parameters; and gaming system **10** would be configured to provide these additional forms of payment. For example, frequent flyer miles could be provided in the same manner as monetary credits. In each case, however, the payout, its type and amount is derived from the payout database, (e.g., a payout table), and may also be dependent upon the Player ID Number.

Referring now to FIG. **12**, a flow diagram illustrates an exemplary process according to an embodiment of the present invention. The process begins with step **1205**, wherein a player initiated game play is determined. The game result is then determined in step **1210**. It is then determined, in step **1215**, whether the game result correspond to video output. If the game result does not correspond to video output, it is determined in step **1225** whether the game result corresponds to monetary payout. If the game result does correspond to monetary payout, the process proceeds to step **1230**, where the monetary payout is provided. The process then returns to step **1205**, where a player initiated game play is again determined. If the game result does not correspond to monetary payout, the process also returns to step **1205**, where a player initiated game play is again determined. If, in step **1215**, it is determined that the game result does correspond to video output, the process proceeds to step **1220**, where video presentation comprising a clue for solving a puzzle is retrieved and displayed to a player. In step **1235**, the player is instructed to solve the puzzle in exchange for an award. A player input is received in step **1240**. It is then determined, in step **1245**, whether the player input solves the puzzle. If the player input does solve the puzzle, the award is provided to the player in step **1250**.

If the player input does not solve the puzzle, the process continues instead to step **1255**, in which step the player is informed that the puzzle has not been solved. The process then returns to step **1205**, wherein a player initiated game play is again determined. Referring now to FIG. **13**, a flow diagram illustrates an exemplary process according to another embodiment of the present invention. The process begins with step **1305**, in which step the player inserts a player tracking card into a slot machine player tracking card reader. The slot machine then derives the player ID number from the player tracking card in step **1310**. In step **1315**, the slot machine transmits the player ID number to a slot network server. The slot network server, in step **1320**, retrieves the player ID number from in a session database. In step **1325** it is determined whether there is an existing session record. If there is an existing session record, the slot network server, in step **1330**, retrieves a video ED number and amount of clip already viewed. If a session record does not exist, the slot network server, in step **1335**, generates a new session record.

In summary, the present invention provides a gaming system wherein a player always wins a prize, in the form of selected video presentation (e.g., a movie, music video, etc.), for each play of a gaming device. The prize structure is based on the gaming result or outcome generated during the play. Such a gaming system may also provide other prizes such as a monetary sum, frequent flyer miles, a free pull, etc.

It should be understood that the forgoing description is only illustrative of the invention. Various alternatives and modifications can be devised by those skilled in the art without departing from the invention. Accordingly, the present invention is intended to embrace all such alternatives, modifications and variances which fall within the scope of the appended claims.

What is claimed is:

1. A method, comprising:

receiving, via a gaming device, a code indicating a point of termination of a video presentation;
determining an outcome of a game play at the gaming device;
determining that the outcome corresponds to a display of a video presentation; and
causing, in response to determining that the outcome corresponds to a display of a video presentation, a display of the video presentation to be resumed from the point of termination.

2. The method of claim 1, further comprising:

receiving an indication that an outcome of a game play at the gaming device corresponds to an output of a portion of the video presentation;
determining the portion of the video presentation based at least on the code; and
wherein causing comprises:
causing the determined portion of the video presentation to be output via the gaming device.

3. The method of claim 2, wherein determining the portion of the video presentation comprises:

determining a start point of the portion based on the point of termination indicated by the code; and
determining an end point of the portion of the video presentation.

4. The method of claim 3, wherein determining an end point comprises determining an end point of the portion of the video presentation based on the outcome of the game play.

9

5. The method of claim 3, wherein determining an end point comprises determining an end point of the portion of the video presentation based on an amount of the video presentation previously output to a player associated with the code.

6. The method of claim 3, wherein determining an end point comprises determining an end point of the portion of the video presentation based on a length of a play session of a player associated with the code.

7. The method of claim 3, wherein determining an end point comprises determining an end point of the portion of the video presentation based on a player status of a player associated with the code.

8. The method of claim 1, wherein the code is output via a first gaming device and is received at a second gaming device.

9. The method of claim 1, wherein the code is received at a time different from a time at which the code was output.

10. The method of claim 1, wherein the code comprises a player tracking card identifier.

11. The method of claim 1, wherein receiving the code comprises:

determining that a player tracking card has been inserted into the gaming device; and

determining a player tracking card identifier of the card.

12. The method of claim 11, further comprising:

determining, based on the player tracking card identifier, an amount of video presentation already output to a player associated with the player tracking card identifier, thereby determining a point of termination of the video presentation.

13. The method of claim 12, wherein determining an amount of video presentation already viewed comprises:

retrieving, from a database and based on the player tracking card identifier, a record that stores an indication of an amount of video presentation already output to the player.

14. An apparatus, comprising:

a processor; and

a storage device in communication with said processor and storing instructions adapted to be executed by said processor to:

perform the method of claim 1.

15. A computer-readable medium storing computer-readable instructions that direct a microprocessor to:

perform the method of claim 1.

16. A method, comprising:

determining that a random outcome of a game play at a gaming device corresponds to an output of a portion of a video presentation;

determining the portion of the video presentation by selecting the video presentation from a plurality of available video presentations,

10

determining a start point of the portion of the video presentation, and

determining an end point of the portion of the video presentation; and

causing the determined portion of the video presentation to be output via the gaming device.

17. The method of claim 16, wherein selecting the video presentation comprises:

selecting the video presentation based on information associated with a player associated with the random outcome.

18. The method of claim 16, wherein selecting the video presentation comprises selecting a category of video presentation based on a preference indicated by the player.

19. The method of claim 16, wherein determining a start point of the portion of the video presentation comprises:

determining an end point of a portion of the video presentation previously output to a player associated with the random outcome; and

determining the start point such that an output of the video presentation resumes from the end point of the portion previously output.

20. The method of claim 16, wherein determining an end point of the portion of the video presentation comprises:

determining an end point of the portion of the video presentation based on the outcome of the game play.

21. The method of claim 16, wherein determining an end point of the portion of the video presentation comprises:

determining an end point of the portion of the video presentation based on an amount of the video presentation previously output to a player associated with the code.

22. The method of claim 16, wherein determining an end point of the portion of the video presentation comprises:

determining an end point of the portion of the video presentation based on a length of a play session of a player associated with the random outcome.

23. The method of claim 16, wherein determining an end point of the portion of the video presentation comprises:

determining an end point of the portion of the video presentation based on a player status of a player associated with the random outcome.

24. An apparatus, comprising:

a processor; and

a storage device in communication with said processor and storing instructions adapted to be executed by said processor to:

perform the method of claim 16.

25. A computer-readable medium storing computer-readable instructions that direct a microprocessor to:

perform the method of claim 16.

* * * * *